

**Programming Guide**

**Agilent Technologies**  
**ESG Family Signal Generators**

**Serial Number Prefixes**

(Affix Label Here)



**Part Number E4400-90324**

**Printed in USA**

**April 2002**

Supersedes **June 2001**

© Copyright 1999-2002 Agilent Technologies, Inc.



## 1. Preparing for Use

Setting up the Equipment for Remote Operation . . . . .	1-2
Programming the Signal Generator . . . . .	1-9
Overview of Serial Interface (RS-232) Programming . . . . .	1-10
Transferring Data . . . . .	1-14
GPIB Instrument Nomenclature . . . . .	1-17
GPIB Command Statements . . . . .	1-18
Getting Started with SCPI . . . . .	1-25
Programming the Status Register System . . . . .	1-42
Advanced Programming Information . . . . .	1-73

## 2. Programming Commands and Examples

Command Syntax . . . . .	2-2
IEEE 488.2 Common Commands . . . . .	2-3
Subsystem Commands . . . . .	2-6
:AM Subsystem . . . . .	2-7
:CALibration Subsystem . . . . .	2-12
:COMMunicate Subsystem . . . . .	2-14
:DIAGnostic Subsystem . . . . .	2-16
:DISPlay Subsystem . . . . .	2-18
:DM and :BURSt Subsystems (ESG-D and ESG-DP Series) . . . . .	2-19
:FM Subsystem . . . . .	2-22
:FREQuency Subsystem . . . . .	2-27
:LFOutput Subsystem . . . . .	2-31
:LIST Subsystem . . . . .	2-34
:MEMory and :MMEMory Subsystems . . . . .	2-37
:OUTPut Subsystem . . . . .	2-44
:PM Subsystem . . . . .	2-46
:POWER Subsystem . . . . .	2-51
:PULM Subsystem . . . . .	2-56
:ROUTE Subsystem (Option UN8) . . . . .	2-58
:STATus Subsystem . . . . .	2-61
:SWEep Subsystem . . . . .	2-69
:SYSTem Subsystem . . . . .	2-70
:TRIGger Subsystem . . . . .	2-74
Using the Example Programs . . . . .	2-76
GPIB Check, Example Program 1 . . . . .	2-77
Local Lockout Demonstration, Example Program 2 . . . . .	2-79
Using Queries, Example Program 3 . . . . .	2-81
Generating a CW Signal, Example Program 4 . . . . .	2-84
Generating an AC-Coupled External FM Signal, Example Program 5 . . . . .	2-86
Generating an AC-Coupled Internal FM Signal, Example Program 6 . . . . .	2-88
Generating a Step-Swept Signal, Example Program 7 . . . . .	2-90
Generating an External DC-Coupled Pulse Modulated Signal, Example Program 8 . . . . .	2-92
Saving and Recalling States, Example Program 9 . . . . .	2-94
Reading the Status Byte, Example Program 10 . . . . .	2-97
End of Sweep Service Request, Example Program 11 . . . . .	2-101

### **3. Remote Data Transfer**

ARB Waveform Data Downloads .....	3-2
User File Data Downloads .....	3-12
FIR Filter Coefficient Data Downloads .....	3-23
Data Downloads Directly into Pattern RAM .....	3-27
Data Transfer Troubleshooting .....	3-33

### **4. Softkey/Command Cross-Reference**

Front Panel Key Versus Command .....	4-2
Agilent 8656/57-Compatible Language .....	4-21

# 1 Preparing for Use

This chapter explains how to set up the equipment for remote programming of the signal generator, the GPIB and RS-232 capabilities of the signal generator, and provides a program for an operational check of remote programming functionality. Instruction is also provided for programming the signal generator using GPIB command statements and the SCPI language.

---

## Setting up the Equipment for Remote Operation

The signal generator can be remotely controlled using either the general purpose interface bus (GPIB) or a serial connection to the rear-panel RS-232 auxiliary interface connector.

### GPIB Overview

GPIB is a high-performance bus that allows individual instruments and computers to be combined into integrated test systems. The bus and its associated interface operations are defined by the IEEE 488.1 standard. The IEEE 488.2 standard defines the interface capabilities of instruments and controllers in a measurement system, including some frequently used commands.

---

**NOTE** The functionality provided by GPIB is also available using the rear-panel RS-232 AUXILIARY INTERFACE. For more information on using this type of system configuration, see [“Serial Interface \(RS-232\) Overview”](#) on page 1-7.

---

Commands are sent over the GPIB via a controller’s language system. HP BASIC is the language used in the programming examples in this book. HP BASIC was selected because the majority of GPIB computers have BASIC language capability. However, other languages can also be used. The use of HP BASIC is explained later in this chapter starting with [“Programming the Signal Generator”](#) on page 1-9.

### Additional Required Equipment

The following tables list the additional required equipment to implement an GPIB system interface between a computer or workstation and the signal generator.

**Table 1-1 GPIB Required Equipment for PC-Based Systems**

Interface Card	Operating System	I/O Library	Languages	Backplane	Max I/O (kB/sec)	Buffering
HP 82341C	Windows 3.1/95/NT	SICL/VISA	C/C++, Visual Basic, HP VEE	ISA/EISA, 16 bit	750	Built-in
HP 82340B	Windows 3.1/95/NT	SICL/VISA	C/C++, Visual Basic, HP VEE	ISA/EISA, 16 bit	520	None
HP 82335B	MS-DOS, Windows 3.1	Command Library/SICL	C/C++, PASCAL, BASIC for PC (including Visual Basic), HP VEE	ISA/EISA, 8 bit	355	None

**Table 1-2 Required Equipment for HP Series 700 Workstations Running HP-UX**

Interface Card	Operating System	I/O Library	Languages	Backplane	Max I/O (kB/sec)	Buffering
HP E2071C	HP-UX	SICL/VISA	ANSI C, HP VEE, HP BASIC	EISA	750	Built-in
HP E2070C	HP-UX	SICL/VISA	ANSI C, HP VEE, HP BASIC	EISA	230	None

**Table 1-3 GPIB Cables**

Model	HP 10833A	HP 10833B	HP 10833C	HP 10833D
Length	1 meter	2 meters	4 meters	5 meters

**I/O Libraries for GPIB**

SCPI (standard commands for programmable instruments) is a popular language used to communicate with the signal generator. Do not confuse SCPI with SICL and VISA, which are I/O libraries of functions used by programs that communicate through GPIB. SCPI is the actual language used to communicate with the signal generator itself.

Agilent Technologies Standard Instrument Control Library (SICL) and Virtual Instrument Software Architecture (VISA) are I/O libraries used to develop I/O applications for the GPIB interface. These functions are used in C or BASIC programs to simplify communication with the signal generator.

SICL is a modular instrument communications library that works with a variety of computer architectures, I/O interfaces, and operating systems. Applications written in C/C++ or Visual BASIC using this library can be ported at the source code level from one system to another without, or with very few, changes.

VISA is an I/O library that can be used to develop I/O applications and instrument drivers that comply with the VXI “plug & play” standards. Applications and instruments drivers developed with VISA can execute on VXI “plug & play” system frameworks that have the VISA I/O layer.

One or both of these libraries are included with the GPIB interface card. SICL/VISA for Hewlett-Packard Series 700 Controllers (model E2091D) and SICL/VISA for personal computers (model E2094E) may also be purchased. For additional information on SICL and VISA, see the user’s guides included with the SICL/VISA software package.

## GPIB Interconnecting Cables

The GPIB connector enables you to connect the signal generator to any other instrument or device on the interface bus. A GPIB connector and cable are shown in [Figure 1-1](#). The codes next to the connector describe the GPIB electrical capabilities of the signal generator, using IEEE Std. 488-1978 mnemonics (GPIB, IEEE-488, and IEC-625 are electrically equivalent, although IEC-625 uses a unique connector).

**Figure 1-1 GPIB Connector and Cable**

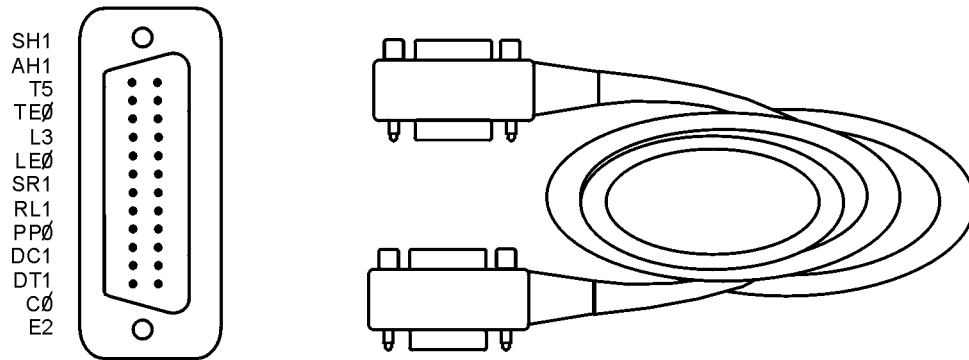

ck74b

Briefly, the mnemonics translate as follows:

Mnemonic	Signal Description	Capabilities
SH1	Source Handshake	Complete
AH1	Acceptor Handshake	Complete
T5	Talker	Capable of basic talker, serial poll, and unaddressed if MLA.
TE0	Talker, Extended Address	None
L3	Listener	Capable of basic listener, and unaddressed if MTA
LE0	Listener, Extended Address	None
SR1	Service Request	Complete
RL1	Remote Local	Complete
PP0	Parallel Poll	None
DC1	Device Clear	Complete
DT1	Device Trigger	Complete
C0	Controller	None
E2	Identifies electrical tristate drivers	



You can connect as many as 14 instruments to the signal generator via GPIB (15 total instruments in the system). The cables can be interconnected in a star pattern (one central instrument, with the GPIB cables emanating from that instrument like spokes on a wheel), or in a linear pattern (like boxcars on a train), or any combination pattern. The following restrictions apply:

- Each instrument must have a unique GPIB address ranging from 0 through 30 (decimal).
- In a two-instrument system that uses just one GPIB cable, the cable length must not exceed 4 meters (9.13 ft.) between the two instruments.
- When more than two instruments are connected on the bus, the cable length between each instrument must not exceed 2 meters (6.5 ft.) per unit.
- The total cable length between all instruments must not exceed 20 meters (65 ft.).

### Setting Up the Interface for GPIB Operation

1. Connect a computer and any other peripherals to the signal generator with GPIB cables.
2. Reset all instruments connected to the bus. If you are not sure how to reset a device, switch off the line power to the device and then switch the power back on.
3. Check the signal generator's GPIB address.

Press **Utility > GPIB/RS-232 > GPIB Address**.

If the address is not 19, press **1 > 9 > Enter**.

---

**NOTE** Programming examples in this book assume that the signal generator's GPIB address is 19. Modify the examples, if necessary, to correspond to your signal generator's address.

---

4. Check the signal generator's remote language.

Press **Utility > GPIB/RS-232 > Remote Language**. The default remote language is SCPI.

If SCPI is not highlighted, press **SCPI**.

---

**NOTE** Although there are a number of remote languages compatible with other signal sources, SCPI is the *only* remote language that can implement *all* of the signal generator's features. Unless you have reason to use one of the other remote languages (for example, programs previously written for another signal source that has been replaced by the ESG family signal generator), choose SCPI to maximize your control of the signal generator's functionality. All programming commands in this documentation set are written in SCPI.

---

### Verifying GPIB Programming Functionality

This program verifies that the GPIB connections and interface are functional. With the equipment set up as described in the previous section, clear and reset the controller. Type in the following program:

```
10  Sig_gen=719
20  ABORT 7
30  LOCAL Sig_gen
40  CLEAR Sig_gen
50  OUTPUT Sig_gen;"*RST"
60  REMOTE Sig_gen
70  CLEAR SCREEN
80  PRINT "The source should now be in REMOTE."
90  PRINT "Verify that the 'R' annunciator is displayed"
100 END
```

Run the program and verify that the R (remote) annunciator is activated on the signal generator's display. If it is not, verify that the signal generator address is set to 19 (see ["Setting Up the Interface for GPIB Operation"](#) on page 1-5) and that the interface cable is properly connected.

If the controller display indicates an error message, it is possible that the program was entered in incorrectly. If the controller accepts the remote statement but the signal generator's remote annunciator does not appear on the signal generator's display, refer to the service guide for troubleshooting information.

#### Program Comments

10:	Sets up a variable to contain the GPIB address of the signal generator.
20:	Aborts any bus activity and return the GPIB interfaces to their reset states.
30:	Places the signal generator into LOCAL mode to cancel any local lockouts that may have been set up.
40 to 50:	Resets the signal generator's parser and clears any pending output from the signal generator. Prepares the signal generator to receive new commands.
60:	Places the signal generator into remote mode.
70:	Clears the controller's display.
80 to 90:	Prints a message to the controller's display.
100:	Ends the program.

## Serial Interface (RS-232) Overview

You can also control the signal generator using the rear-panel serial RS-232 serial port (labeled AUXILIARY INTERFACE). All of the functionality provided by GPIB is available using the rear-panel serial interface, except for indefinite blocks, serial polling, GET, non-SCPI remote languages, and remote mode.

Commands are sent over the serial interface via a controller's language system. HP BASIC is the language used in the programming examples in this book. BASIC was selected because the majority of GPIB computers have BASIC language capability, but other languages can also be used. For more detail on using HP Basic, see [“Programming the Signal Generator”](#) on page 1-9. For information regarding RS-232 operating parameters such as handshake, baud rate, character format, and parity, see [“Overview of Serial Interface \(RS-232\) Programming”](#) on page 1-10.

### RS-232 Serial Interconnecting Cables

The signal generator's serial connector enables you to connect the signal generator to a serial port on a personal computer. The connector's pin configuration shown in [Table 1-4](#).

Only one instrument per RS-232 port on the computer may be connected at any given time. The additional items required when using a serial interface are listed in [Table 1-5](#).

**Table 1-4. The RS-232 Connector**

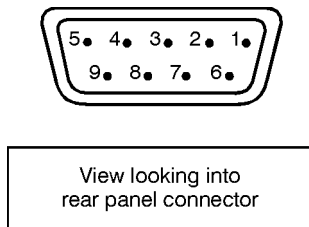

Pin Number	Signal Description	Signal Name
1	No Connection	
2	Receive Data	RECV
3	Transmit Data	XMIT
4	+5V	
5	Ground, 0V	
6	No Connection	
7	Request to Send	RTS
8	Clear to Send	CTS
9	No Connection	

**Table 1-5. Additional Equipment Required for Serial Interface**

Quantity	Description	Agilent Part Number
1	Serial RS-232 cable 9-pin (male) to 9-pin (female)	8120-6188
1	RS-232 null modem (male-male) <sup>1</sup>	5158-6639
1	Serial RS-232 adapter (female-female)	1252-7825

1.Ensure proper pin connections between computer and signal generator.

## Connecting the Interface

1. Attach the male end of the RS-232 cable to the signal generator's rear-panel AUXILIARY INTERFACE connector.
2. Attach the female end of the RS-232 cable to the null modem.
3. Using a 5-mm nut driver, remove both standoffs from the female-to-female adapter.
4. Connect one end of the modified adapter to the null modem and the other end to the selected port on the computer.
  - For personal computers, make the connection to the COM2 RS-232 port. COM1 is acceptable if available.
  - For UNIX workstations, connect to the /dev/tty00 port. Alternatively, /dev/tty01 may be used if it is available.

## Configuring the Interface

1. Set the signal generator's baud rate.

Press **Utility > GPIB/RS-232 > RS-232 Baud Rate**. The default RS-232 baud rate is 19200. Use baud rates 19200 or lower only. Press the appropriate softkey to adjust the signal generator's baud rate to the baud rate of your personal computer or UNIX workstation.
2. Set the signal generator's handshake.

Press **Utility > GPIB/RS-232 > RS-232 Pace**. To determine the hardware operating parameters, you need to know whether DSR (data set ready) and CTS (clear to send) are active during communication with the controller, and the baud rate expected by the controller. Set the signal generator's handshake accordingly.
3. Set the signal generator's RS-232 echo.

Press **Utility > GPIB/RS-232 > RS-232 Echo Off On** to the desired operating state for your configuration.
4. Set the signal generator's remote language.

Press **Utility > GPIB/RS-232 > Remote Language**. The only remote language supported by RS-232 is SCPI (standard commands for programmable instruments).  
If SCPI is not highlighted, press **SCPI** to select it.

## Verifying the RS-232 System Interface

The following command verifies that the serial interface functions. With the equipment set up as described in the previous sections, clear and reset the controller. Execute the following command: `OUTPUT "*IDN?"`

The signal generator should return a string similar to the following, depending on model:

*<instrument model name and number>*, US37040098 B.03.00

If not, verify that the RS-232 parameters are set correctly (see "[Setting Up the Interface for GPIB Operation](#)" on page 1-5) and that the interface cable is properly connected.

---

## Programming the Signal Generator

The signal generator can be controlled entirely by a computer (although the line power switch must be operated manually). Several functions are possible only by remote control. Computer programming procedures for the signal generator involve selecting a GPIB command statement and then adding the specific programming codes (SCPI or 8656/67-compatible) to that statement to achieve the desired operating conditions. The programming codes can be categorized into two groups: those that mimic front panel keystrokes, and those that are unique and have no front panel equivalent.

In the programming explanations that follow, specific examples are included that are written in a generic dialect of the HP BASIC language. HP BASIC was selected because the majority of GPIB computers have HP BASIC language capability. However, other languages can be used as well.

### Data Transfers Between Computer and Peripheral

Five statements are used to transfer information between a desktop computer and the interface card:

- The OUTPUT statement sends data to the interface which, in turn, sends the information to the peripheral device.
- The ENTER statement inputs data from the interface card after the interface has received it from the peripheral device.
- The STATUS statement is used to monitor the interface and obtain information about interface operation such as buffer status, detected errors, and interrupt enable status.
- The CONTROL statement is used to control interface operation and defines such parameters as baud rate, character format, or parity.
- The TRANSFER statement is used to input or output data from/to the interface and, in turn, from/to the peripheral device.

Since the interface has no on-board processor, ENTER and OUTPUT statements cause the computer to wait until the ENTER or OUTPUT operation is complete before continuing to the next line. For OUTPUT statements, this means that the computer waits until the last bit of the last character has been sent over the serial line before continuing with the next program statement.

---

## Overview of Serial Interface (RS-232) Programming

Serial interface programming techniques are similar to most general I/O applications. The interface card is initialized by use of CONTROL statements; STATUS statements evaluate its readiness for use. Data is transferred between the desktop computer and a peripheral device by OUTPUT and ENTER statements.

Due to the asynchronous nature of serial I/O operations, special care must be exercised to ensure that data is not lost by sending to another device before the device is ready to receive. Modem line handshaking can be used to help solve this problem. These and other topics are discussed in greater detail elsewhere in this chapter.

### Determining Operating Parameters

Before you can successfully transfer information to a device, you must match the operating characteristics of the interface to the corresponding characteristics of the peripheral device. This includes matching signal lines and their functions as well as matching the character format for both devices.

#### Handshake and Baud Rate

To determine hardware operating parameters, you need to know the answer for each of the following questions about the peripheral device:

- Which of the following signal and control lines are actively used during communication with the peripheral?
  - Data Set Ready (DSR)
  - Clear to Send (CTS)
- What baud rate (line speed) is expected by the peripheral?

#### Character Format Parameters

To define the character format, you must know the requirements of the peripheral device for the following parameters:

- Character Length: Eight data bits are used for each character, excluding start, stop, and parity bits.
- Parity Enable: Parity is disabled (absent) for each character.
- Stop Bits: One stop bit is included with each character.

## Serial Configuration for BASIC/UX

There is no capability in BASIC/UX for reading the hardware bit settings on either the HP 98626 or HP 98644 Serial Interface cards. Therefore, BASIC/UX provides two methods for configuring modem control options:

- The `stty` command from the HP-UX environment.
- The keyword `CONTROL` and registers directly related to the modem control options.

Of the two methods mentioned above, the best one to use while in the HP-UX environment is the `stty` command. The reason for this is any modem control options set by using the keyword `CONTROL` are lost when you leave BASIC/UX. However, if you prefer to change these options while in the BASIC/UX environment, then read the subsequent section [“Using Program Control to Override Defaults”](#) on page 1-12.

This section deals with the first method mentioned above which is the use of the `stty` command from the HP-UX environment.

### Defaults for the Serial Interface

When HP-UX is being booted up, the defaults for all serial interfaces are:

<b>Baud Rate</b>	300
<b>Bits per character</b>	8
<b>Parity</b>	Off
<b>Stop bits</b>	1

The above values are used by BASIC/UX as defaults, unless configured as explained in the next section.

Some common serial interface configuration settings are:

<b>Baud Rate to</b>	9600
<b>Bits per character to</b>	8
<b>Parity to</b>	Odd and disabled
<b>Stop bits to</b>	1

## Configuring a Serial Interface for BASIC/UX

To configure your serial interface with the values mentioned in the previous section, you can execute the following HP-UX command before entering BASIC/UX:

```
/bin/stty 9600 cs8 -cstopb < /dev/rmb/serialnn
```

where:

**9600** is the baud rate. The following are baud rates you can use with the `stty` command:

300      1200      2400      4800      9600      19 200

**cs8** is the number of bits per character. For this signal generator, the number of bits per character is 8.

**-cstopb** causes one stop bit per character to be used.

**< /dev/rmb/serialnn** assigns the `stty` options to the serial interface located at select code number `nn`.

For more information on `stty` options, see the *HP-UX Language Reference*.

## Using Program Control to Override Defaults

You can override some of the interface default configuration options by use of `CONTROL` statements. This not only enables you to guarantee certain parameters, but also provides a means for changing selected parameters in the course of a running program.

### Interface Reset

Whenever an interface is connected to a modem that may still be connected to a telecommunications link from a previous session, it is good programming practice to reset the interface to force the modem to disconnect, unless the status of the link and remote connection are known. When the interface is connected to a line printer or similar peripheral, resetting the interface is usually unnecessary unless an error condition requires it.

```
100 CONTROL Sc,0;1      ! Resets Interface.
```

When the interface is reset by use of a `CONTROL` statement to `CONTROL` Register 0 with a non-zero value, the interface is restored to the BASIC/UX power-up condition whether or not it is the same as the current default switch configuration. If you are not sure of the present settings, or if your application requires changing the configuration during program operation, you can use `CONTROL` statements to configure the interface. An example of where this may be necessary is when several peripherals share a single interface through a manually operated RS-232 switch such as those used to connect multiple terminals to a single computer port, or a single terminal to multiple computers.



## Selecting the Baud Rate

In order to successfully transfer information between the interface card and a peripheral, the interface and peripheral must be set to the same baud rate. A CONTROL statement to register 3 (or 13 with 98644 interfaces) can be used to set the interface baud rate to any one of the following values:

300      1200      2400      4800      9600      19 200

For example, to select a baud rate of 9600, the following program statement is used:

```
1190 CONTROL Sc,3;9600
```

Use of values other than those shown may result in incorrect operation.

To verify the current baud rate setting, use a STATUS statement addressed to register 3. All rates are in baud (bits/second).

## Setting Character Format and Parity

CONTROL Register 4 overrides the Line Control switches that control parity and character format. All bits in this table correspond to equivalent switch settings on the HP 98626 and HP 98644 serial interface cards. A 1 is the same as set. To determine the value sent to the register, add the appropriate values selected from the following table.

**Table 1-6 Character Format and Parity Settings Handshake**

<b>Handshake (Bits 7 &amp; 6)</b>	<b>Parity Enable (Bit 3)</b>	<b>Stop Bits (Bit 2)</b>	<b>Character Length (Bits 1 &amp; 0)</b>
01 Xon/Xoff Bidirectional 11 Handshake Disabled	0 Disabled	0 One stop bit	11 Eight bits/char

For example, to configure a character format of 8 bits per character, one stop bit, and disabled parity, with XON/XOFF; use the following CONTROL statement:

```
1200 CONTROL Sc,4;IVAL("10011",2)
```

-or-

```
1200 CONTROL Sc,4;19
```

---

## Transferring Data

The serial interface card is designed for relatively simple serial I/O operations. It is not intended for sophisticated applications that use ON INTR statements to service the interface.

### Entering and Outputting Data

When the interface is properly configured, either by use of default switches or CONTROL statements, you are ready to begin data transfers. OUTPUT statements are used to send information to the peripheral; ENTER statements to input information from the external device.

- OUTPUT 20;"String data",Numeric\_var,Etc
- ENTER 20;String\_var\$,Numeric\_var,Etc

Any valid OUTPUT or ENTER statement and variables list may be used, but you must be sure that the data format is compatible with the peripheral device. For example, non-ASCII data sent to an ASCII line printer may result in unexpected behavior.

Various other I/O statements can be used in addition to OUTPUT and ENTER, depending on the situation. For example, the LIST statement can be used to list programs to an RS-232 line printer -- provided the interface is properly configured before the operation begins.

### Outputting Data

To send data to a peripheral, use OUTPUT, OUTPUT USING, or any other similar or equivalent construct. Suppression of end-of-line delimiters and other formatting capabilities are identical to normal operation in general I/O applications. The OUTPUT statement hangs the computer until the last bit of the last character in the statement variable list is transmitted by the interface. When the output operation is complete, the computer then continues to the next line in the program.

### Entering Data

To input data from a peripheral, use ENTER, ENTER USING, or an equivalent statement. Inclusion or elimination of end-of-line delimiters and other information is determined by the formatting specified in the ENTER statement. The ENTER statement hangs the computer until the input variables list is satisfied. To minimize the risk of waiting for another variable that isn't coming, you may prefer to specify only one variable for each ENTER statement, and analyze the result before starting the next input operation.

Be sure that the peripheral is not transmitting data to the interface while no ENTER is in progress. Otherwise, data may be lost because the card provides buffering for only one character. Also, interrupts from other I/O devices, or operator inputs to the computer keyboard can cause delay in computer service to the interface that result in buffer overrun at higher baud rates.

## Modem Line Handshaking

Modem line handshaking, when used, is performed automatically by the computer as part of the OUTPUT or ENTER operation. If the modem line states have not been latched in a fixed state by Control Register, the following sequence of events is executed automatically during each OUTPUT or ENTER operation:

For OUTPUT operations:

1. Set Data Terminal Ready and Request-to-Send modem lines to active state.
2. Check Data Set Ready and Clear-to-Send modem lines to be sure they are active.
3. Send information to the interface and then to the peripheral.
4. After data transfer is complete, clear Data Terminal Ready and Request-to-Send signals.

For ENTER operations:

1. Set Data Terminal Ready line to active state. Leave Request-to-Send inactive.
2. Check Data Set Ready and Data Carrier Detect modem lines to be sure they are active.
3. Input information from the interface as it is received from the peripheral.
4. After the input operation is complete, clear the Data Terminal Ready signal.

After a given OUTPUT or ENTER operation is completed, the program continues execution on the next line.

Control Register 5 can be used to force selected modem control lines to their active states. The Data Rate Select line is set or cleared by bit 2. Request-to-send and Data Terminal Ready are held in their active states when bits 1 and 0 are true, respectively. If bits 1 or 0 are false, the corresponding modem line is toggled during OUTPUT or ENTER as explained previously.

## Incoming Data Error Detection and Handling (BASIC/WS only)

The serial interface card can generate several errors that are caused when certain conditions are encountered while receiving data from the peripheral device. The UART detects a given error condition. The card then generates a pending error to BASIC. Errors can be generated by any of the following conditions:

- Parity error. The parity bit on an incoming character does not match the parity expected by the receiver. This condition is most commonly caused by line noise.
- Framing error. Start and stop bits do not match the timing expectations of the receiver. This can occur when line noise causes the receiver to miss the start bit or obscures the stop bits.
- Overrun error. Incoming data buffer overrun caused a loss of one or more data characters. This is usually caused when data is received by the interface, but no ENTER statement has been activated to input the information.
- Break received. A BREAK was sent to the interface by the peripheral device. The desktop computer program must be able to properly interpret the meaning of a break and take appropriate action.

All UART status errors are generated by incoming data, never by outbound data. When a UART error occurs, the corresponding bit of Status Register 10 is set, and a pending error (ERROR 167: Interface status error) is sent to BASIC. BASIC processes the error according to the following rules:

- If an ENTER is in progress, the error is handled immediately as part of the ENTER process. An active ON ERROR causes the error trap to be executed. If no ON ERROR is active, the error is fatal and causes the program to terminate.
- If an OUTPUT is in progress, or if there is no current activity between the computer and interface, the error is flagged, but nothing is done by BASIC until an ENTER statement is encountered. When the computer begins execution of the ENTER statement, if an ON ERROR is active, the error trap is executed. If there is no active ON ERROR for that select code, the fatal ERROR 167 causes the BASIC program to terminate.
- If a STATUS statement is executed to Status Register 10 before an ENTER statement is encountered for that select code, the pending BASIC error is cleared, and the program continues as if no error had been generated.

Note that the above UART status errors cannot be detected using BASIC/UX.

---

## GPIB Instrument Nomenclature

An instrument that is part of an GPIB network is categorized as a listener, talker, or controller, depending on its current function in the network.

Listener	A listener is a device capable of receiving data or commands from other instruments. Any number of instruments in the GPIB network can be listeners simultaneously.
Talker	A talker is a device capable of transmitting data or commands to other instruments. To avoid confusion, an GPIB system allows only one device at a time to be an active talker.
Controller	A controller is an instrument, typically a computer, capable of managing the various GPIB activities. Only one device at a time can be an active controller.

---

## GPIB Command Statements

Command statements form the nucleus of GPIB programming; they are understood by all instruments in the network. When combined with the programming language codes, they provide all management and data communication instructions for the system.

An explanation of the fundamental command statements follows. Some computers may use a slightly different terminology, or support an extended or enhanced version of these commands. Use the following explanations as a starting point and refer to the HP BASIC language reference manual, the I/O programming guide, and the GPIB manual for the computer you are using.

Syntax drawings accompany each statement. All items enclosed by a circle or oval are computer-specific terms that must be entered exactly as described; items enclosed in a rectangular box are names of parameters used in the statement; and the arrows indicate a path that generates a valid combination of statement elements.

The seven fundamental command statements are as follows:

### Abort

ABORT abruptly terminates all listener/talker activity on the interface bus, and prepares all instruments to receive a new command from the controller. Typically, this is an initialization command used to place the bus in a known starting condition. The syntax is:

**Figure 1-2. Abort Command Syntax**

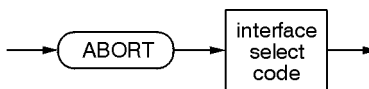

ck702a

where the interface select code is the computer's GPIB I/O port, which is typically port 7.

### A BASIC Example

```
10 ABORT 7
100 IF V>20 THEN ABORT 7
```

### Related Statements Used by Some Computers

- ABORTIO (used by HP-80 series computers)
- HALT
- RESET

## Remote

REMOTE causes an instrument to change from local control to remote control. In remote control, the front panel keys are disabled except for the **Local** key and the line power switch. The syntax is:

**Figure 1-3. Remote Command Syntax**

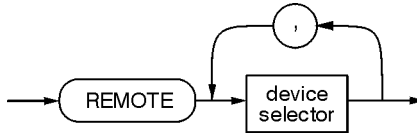

ck703a

where the device selector is the address of the instrument appended to the GPIB port number. Typically, the GPIB port number is 7 and the default address for the signal generator is 19, so the device selector is 719.

### Some BASIC Examples

```
10 REMOTE 7
```

which prepares all GPIB instruments for remote operation (although nothing appears to happen to the instruments until they are addressed to talk), or

```
10 REMOTE 719
```

which affects the GPIB instrument located at address 19, or

```
10 REMOTE 719, 721, 726, 715
```

which affects four instruments that have addresses 19, 21, 26, and 15.

### Related Statements Used by Some Computers

- RESUME

## Local Lockout

LOCAL LOCKOUT can be used with REMOTE to disable the front panel **Local** key. With the **Local** key disabled, only the controller (or a hard reset by the line power switch) can restore local control. The syntax is:

**Figure 1-4. Local Lockout Command Syntax**

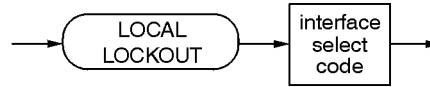

ck704a

## A BASIC Example

```
10 REMOTE 719
20 LOCAL LOCKOUT 7
```

## Local

LOCAL is the complement to REMOTE, causing an instrument to return to local control with a fully enabled front panel. The syntax is:

**Figure 1-5. Local Command Syntax**

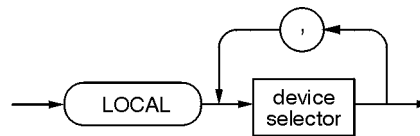

ck705a

## Some BASIC Examples

```
10 LOCAL 7
```

which affects all instruments in the network, or

```
10 LOCAL 719
```

for an addressed instrument (address 19).

## Related Statements Used by Some Computers

- RESUME



## Clear

CLEAR causes all GPIB instruments, or addressed instruments, to assume a cleared condition. The definition of clear is unique for each instrument. For the signal generator:

1. All pending output-parameter operations are halted.
2. The parser (the software that interprets the programming codes) is reset and now expects to receive the first character of a programming code.
3. Any sweep in progress is aborted and continuous sweep is turned off.
4. Any I/Q calibration in progress will be aborted.

The syntax is:

**Figure 1-6. Clear Command Syntax**

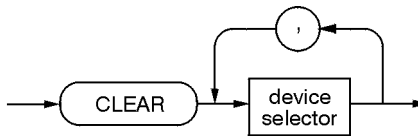

ck706a

### Some BASIC Examples

```
10 CLEAR 7
```

to clear all GPIB instruments, or

```
10 CLEAR 719
```

to clear an addressed instrument (address 19)

### Related Statements Used by Some Computers

- RESET
- CONTROL
- SEND

The preceding statements are primarily management commands that do not incorporate programming codes. The following two statements do incorporate programming codes and are used for data communication.

## Output

OUTPUT is used to send function commands and data commands from the controller to the addressed instrument. The syntax is:

**Figure 1-7. Output Command Syntax**

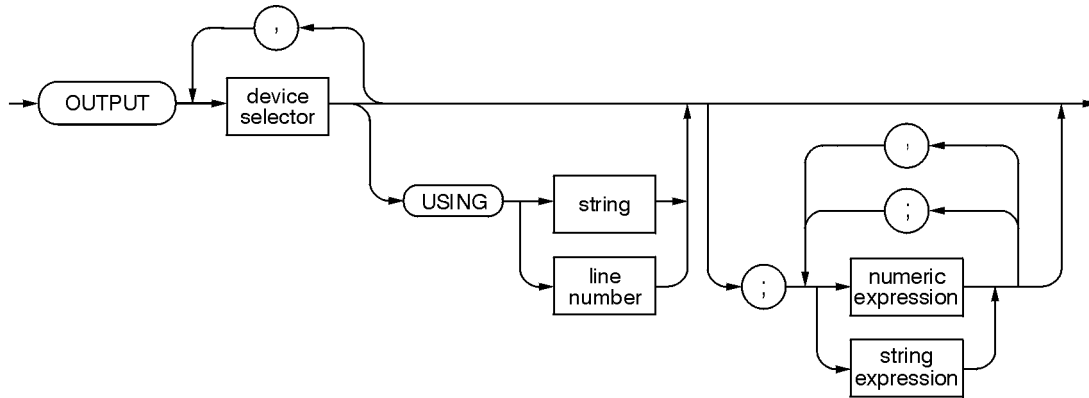

ck707a

where USING is a secondary command that formats the output in a particular way, such as a binary or ASCII representation of numbers. The USING command is followed by image items that precisely define the format of the output; these image items can be a string of code characters or a reference to a statement line in the program. Image items are explained in the programming codes where they are needed. Notice that this syntax is virtually identical to the syntax for the ENTER statement that follows.

### A BASIC Example

```
100 OUTPUT 719; "programming codes"
```

### Related Statements Used by Some Computers

- CONTROL
- CONVERT
- IMAGE
- IOBUFFER
- TRANSFER

## Enter

ENTER is the complement of OUTPUT and is used to transfer data from the addressed instrument to the controller. The syntax is:

**Figure 1-8. Enter Command Syntax**

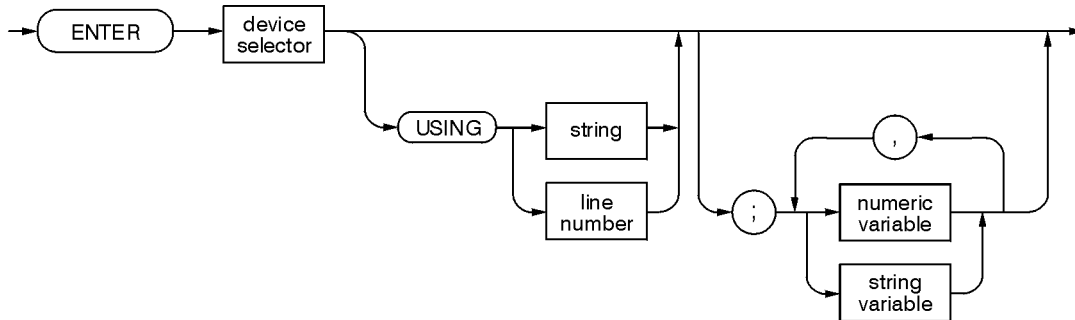

ck708a

ENTER is nearly always used in conjunction with OUTPUT.

### Some BASIC Examples

```
100 OUTPUT 719, "...programming codes..."
```

```
110 ENTER 719; "...response data..."
```

ENTER statements are commonly formatted, requiring the secondary command USING and the appropriate image items. The most-used image items involve end-of-line (EOI) suppression, binary inputs, and literal inputs. For example:

```
100 ENTER 719 USING "#, B"; A, B, C
```

suppresses the EOI sequence (#), and indicates that variables A, B, and C are to be filled with binary (B) data. In another example:

```
100 ENTER 719 USING "#, 123A"; A$
```

suppresses EOI and indicates that string variable A\$ is to be filled with 123 bytes of literal data (123A).

---

**NOTE** Be careful when using byte-counting image specifiers. If the requested number of bytes does not match the actual number available, data might be lost or the program might enter an endless wait state.

---

The suppression of the EOI sequence is frequently necessary to prevent a premature termination of the data input. When not specified, the typical EOI termination occurs when an ASCII LF (line feed) is received. However the LF bit pattern could coincidentally occur randomly in a long string of binary data, where it might cause a false termination. Also the bit patterns for the ASCII CR (carriage return), comma, or semicolon might cause a false termination. Suppression of the EOI causes the computer to accept all bit patterns as data, not commands, and relies on the GPIB EOI (end or identify) line for correct end-of-data termination.

#### **Related Statements Used by Some Computers**

- CONVERT
- IMAGE
- IOBUFFER
- ON TIMEOUT
- SET TIMEOUT
- TRANSFER

---

## Getting Started with SCPI

This section describes the use of the Standard Commands for Programmable Instruments language (SCPI). This section explains how to use SCPI commands in general. For a list of the specific SCPI commands available in the signal generator, refer to [Chapter 2](#) and [Chapter 3](#).

### Understanding Common Terms

The following terms are used throughout the remainder of this chapter.

Controller	A controller is any computer used to communicate with a SCPI instrument. A controller can be a personal computer, a minicomputer, or a plug-in card in a card cage. Some intelligent instruments can also function as controllers.
Instrument	An instrument is any device that implements SCPI. Most instruments are electronic measurement or stimulus devices, but this is not a requirement. Similarly, most instruments use an GPIB or RS-232 interface for communication. The same concepts apply regardless of the instrument function or the type of interface used.
Program Message	A program message is a combination of one or more properly formatted SCPI commands. Program messages always go from a controller to an instrument. Program messages tell the instrument how to make measurements and output signals.
Response Message	A response message is a collection of data in specific SCPI formats. Response messages always go from an instrument to a controller or listening instrument. Response messages tell the controller about the internal state of the instrument and about measured values.
Command	A command is an instruction in SCPI. You combine commands to form messages that control instruments. In general, a command consists of mnemonics (keywords), parameters, and punctuation.
Query	A query is a special type of command. Queries instruct the instrument to make response data available to the controller. Query mnemonics always end with a question mark.

## Standard Notation

This section uses several forms of notation that have specific meaning:

### Command

**Mnemonics** Many commands have both a long and a short form and you must use either one or the other (SCPI does not accept a combination of the two). Consider the FREQuency command, for example. The short form is FREQ and the long form is FREQUENCY. This notation type is a shorthand to document both the long and short form of commands. SCPI is not case sensitive, so fREQuEnCy is just as valid as FREQUENCY, but FREQ and FREQUENCY are the only valid forms of the FREQuency command.

### Angle

**Brackets** Angle brackets indicate that the word or words enclosed represent something other than themselves. For example, <new line> represents the ASCII character with the decimal value 10. Similarly, <END> means that EOI is asserted on the GPIB interface. Words in angle brackets have much more rigidly defined meaning than words shown in ordinary text. For example, this section uses the word “message” to talk about messages generally. But the bracketed words <program message> indicate a precisely defined element of SCPI. If you need them, you can find the exact definitions of words such as <program message> in a syntax diagram.

## How to Use Examples

Programming with SCPI requires knowledge of two languages. You must know the programming language of your controller (BASIC, C, Pascal) as well as the language of your instrument (SCPI). The semantic requirements of your controller’s language determine how the SCPI commands and responses are handled in your application.

### Command Examples

Command examples look like this:

```
:FREQuency: CW?
```

This example tells you to put the string `:FREQuency: CW?` in the output statement appropriate to your application programming language. If you encounter problems, study the details of how the output statement handles message terminators such as <new line>. If you are using simple OUTPUT statements in HP BASIC, this is taken care of for you. In HP BASIC, you type:

```
OUTPUT 719 " :FREQuency: CW? "
```

Command examples do not show message terminators because they are used at the end of every program message. See “[Details of Commands and Responses](#)” on page 1-35 for more information about message terminators.

## Response Examples

Response examples look like this:

```
3.000000000000E+009
```

These are the characters you would read from an instrument after sending a query command. To actually pull them from the instrument into the controller, use the input statement appropriate to your application programming language. If you have problems, study the details of how the input statement operates. In particular, investigate how the input statement handles punctuation characters such as the comma and the semicolon and how it handles <new line> and EOI. To enter the previous response in HP BASIC you type:

```
ENTER 719;CW_frequency
```

Response examples do not show response message terminators because they are always <new line> <END>. These terminators are typically automatically handled by the input statement. See “[Details of Commands and Responses](#)” on page 1-35 for more information about terminators.

## Program and Response Messages

To understand how your instrument and controller communicate using SCPI, you must understand the concepts of program and response messages. Program messages are the formatted data sent from the controller to the instrument. Conversely, response messages are the formatted data sent from the instrument to the controller. Program messages contain one or more commands, and response messages contain one or more responses.

The controller may send commands at any time, but the instrument sends responses only when specifically instructed to do so. The special type of command used to instruct the instrument to send a response message is the query. All query mnemonics end with a question mark. Queries return either measured values or internal instrument settings. Any internal setting that can be programmed with SCPI can also be queried.

### Forgiving Listening and Precise Talking

SCPI uses the concept of forgiving listening and precise talking outlined in IEEE 488.2. Forging listening means that instruments are very flexible in accepting various command and parameter formats. For example, the signal generator accepts either :POWER:ALC[:STATE] ON or :POWER:ALC[:STATE] 1 to turn on the source's RF output.

Precise talking means that the response format for a particular query is always the same. For example, if you query the power state when it is on (using :POWER:ALC[:STATE]?), the response is always 1, regardless of whether you previously sent :POWER:ALC[:STATE] 1 or :POWER:ALC[:STATE] ON.

## Types of Commands

Commands can be separated into two groups, common commands and subsystem commands.

Common commands are generally not measurement related. They are used to manage macros, status registers, synchronization, and data storage. Common commands are easy to recognize because they all begin with an asterisk, such as \*IDN?, \*OPC, and \*RST. Common commands are defined by IEEE 488.2.

Subsystem commands include all measurement functions and some general purpose functions. Subsystem commands are distinguished by the colon used between keywords, as in :FREQuency:CW?. Each command subsystem is a set of commands that roughly corresponds to a functional block inside the instrument. For example, the :POWeR subsystem contains commands for power generation, while the :STATus subsystem contains commands for accessing status registers.

**Figure 1-9. SCPI Command Types**

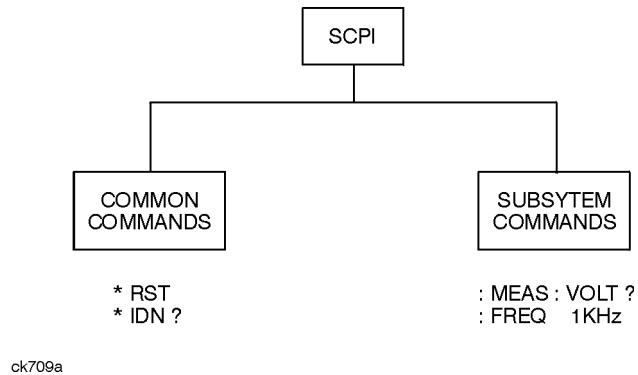

The remaining paragraphs in this subsection discuss subsystem commands in more detail. Remember, some commands are implemented in one instrument and not in another, depending on its measurement function.



## Subsystem Command Trees

### Command Tree Structure

Most programming tasks involve subsystem commands. SCPI uses a hierarchical structure for subsystem commands similar to the file systems on most computers. In SCPI, this command structure is called a command tree.

**Figure 1-10. A Simplified Command Tree**

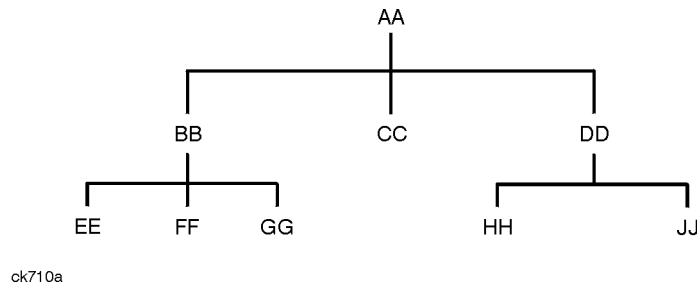

In the command tree shown above, the command closest to the top is the root command, or simply “the root.” Notice that you must follow a particular path to reach lower level subcommands. For example, if you wish to access the GG command, you must follow the path AA to BB to GG.

### Paths Through the Command Tree

To access commands in different paths in the command tree, you must understand how an instrument interprets commands. The parser, a part of the instrument firmware, decodes each message sent to the instrument. The parser breaks up the message into component commands using a set of rules to determine the command tree path used. The parser keeps track of the current path: the level in the command tree where it expects to find the next command you send. This is important because the same keyword may appear in different paths. The particular path you use determines how the keyword is interpreted. The following rules are used by the parser:

Power On and Reset	After power is cycled or after *RST, the current path is set to the root.
Message Terminators	A message terminator, such as a <new line> character, sets the current path to the root. Many programming languages have output statements that send message terminators automatically. See “ <a href="#">Details of Commands and Responses</a> ” on page 1-35 for more information about message terminators.

Colon	When a colon is placed between two command mnemonics, it moves the current path down one level in the command tree. For example, the colon in <code>MEAS:VOLT</code> specifies that <code>VOLT</code> is one level below <code>MEAS</code> . When the colon is the first character of a command, it specifies that the next command mnemonic is a root level command. For example, the colon in <code>:INIT</code> specifies that <code>INIT</code> is a root level command.
Semicolon	A semicolon separates two commands in the same message without changing the current path.
White Space	White space characters, such as <code>&lt;tab&gt;</code> and <code>&lt;space&gt;</code> , are generally ignored. There are two important exceptions. White space inside a keyword, such as:  <code>:FREQ uency</code>  is not allowed. You must use white space to separate parameters from commands. For example, the <code>&lt;space&gt;</code> between <code>LEVEL</code> and <code>6.2</code> in the command <code>:POWER:LEVEL 6.2</code> is mandatory. White space does not affect the current path.
Commas	If a command requires more than one parameter, you must separate adjacent parameters using a comma. Commas do not affect the current path.
Common Commands	Common commands, such as <code>*RST</code> , are not part of any subsystem. An instrument interprets them in the same way, regardless of the current path setting.

**Figure 1-11. Proper Use of the Colon and Semicolon**

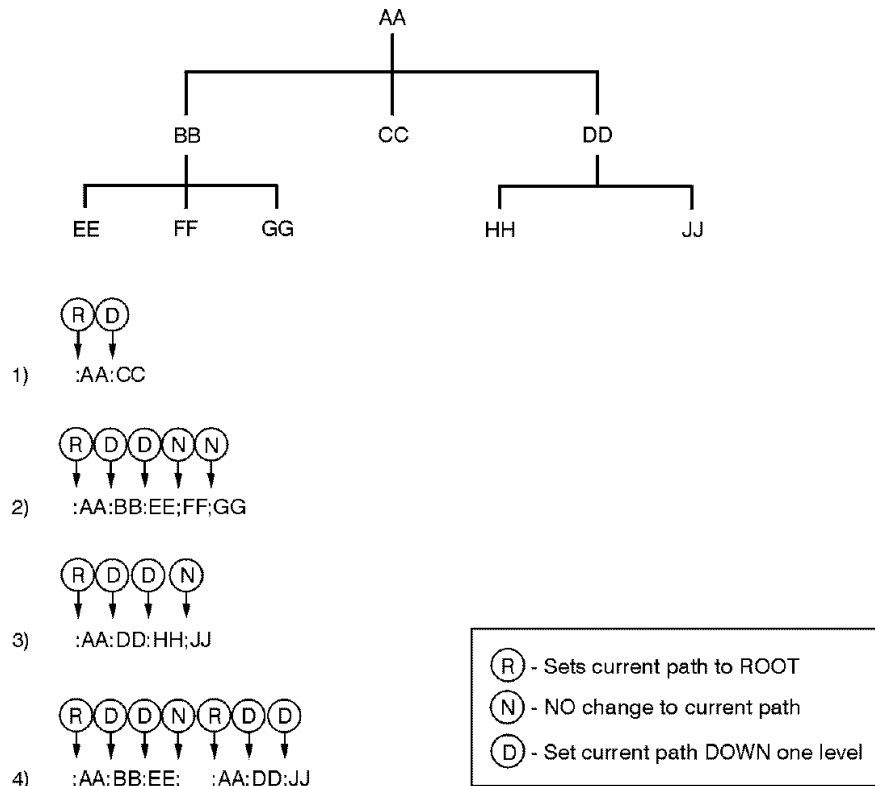

ck711a

Examples of how to use the colon and semicolon to navigate efficiently through the command tree are shown in [Figure 1-11](#). Notice how proper use of the semicolon can reduce the amount of information that must be sent over the interface.

Sending this message:

```
:AA:BB:EE; FF; GG
```

is the same as sending these three messages:

```
:AA:BB:EE
```

```
:AA:BB:FF
```

```
:AA:BB:GG
```

## More About Commands

### Query and Event Commands

You can query any value that you can set. For example, the presence of the signal generator `FREQUENCY:OFFSET` command implies that a `FREQUENCY:OFFSET?` also exists. If you see a command ending with a question mark, it is a query-only command. Some commands are events and cannot be queried. An event has no corresponding setting if it causes something to happen inside the instrument at a particular instant.

### Implied Commands

Implied commands appear in square brackets. If you send a subcommand immediately preceding an implied command, but do not send the implied command, the instrument assumes you intend to use the implied command and behaves just as if you had sent it. Notice that this means that the instrument expects you to include any parameters required by the implied command. The following example illustrates equivalent ways to program the signal generator using explicit and implied commands.

Example signal generator commands with and without an implied command:

`FREQUENCY[:CW] 500 MHz`            using explicit commands

`FREQUENCY 500 MHz`                using implied commands

### Optional Parameters

Optional parameter names are enclosed in square brackets. If you do not send a value for an optional parameter, the instrument chooses a default value. The instrument's command dictionary documents the values used for optional parameters.

## Program Message Examples

The following parts of the signal generator SCPI command set will be used to demonstrate how to create complete SCPI program messages:

```
:FREQuency
```

```
:POWER
```

### Example 1

```
"FREQuency:START 500 MHz; STOP 1000 MHz"
```

The command is correct and will not cause errors. It is equivalent to sending the following:

```
"FREQuency:START 500 MHz; FREQuency:STOP 1000 MHz"
```

### Example 2

```
"POWER 10 DBM; :OFFSet 5 DB"
```

This command results in a command error. The command makes use of the default `POWER[:LEVEL][:IMMEDIATE]` node. When using a default node, there is no change to the current path position. Since there is no command "OFFSet" at the root, an error results. A correct way to send this is:

```
"POWER 10 DBM; :POWER:OFFSet 5 DB"
```

### Example 3

```
"POWER:OFFSet 5 DB; POWER 10 DBM"
```

This command results in a command error. The `POWER 10 DBM` portion of the command is missing a leading colon. The path level is dropped at each colon until it is in the `POWER:OFFSet` subsystem.

When the `POWER 10 DBM` command is sent, it then causes confusion because no such node occurs in the `POWER:OFFSet` subsystem. By adding a leading colon, the current path is reset to the root. The correct command is:

```
"POWER:OFFSet 5 DB; :POWER 10 DBM"
```

### Example 4

```
"FREQ 500 MHZ; POWER 4 DBM"
```

In this example the keyword short form is used. The command is correct. It utilizes the default nodes of `[:CW]` and `[:LEVEL]`. Since default nodes do not affect the current path, it is not necessary to use a leading colon before `POWER`.

## Reading Instrument Errors

When debugging a program, you may want to know if an instrument error has occurred. The signal generator can display error messages on their front panel displays. If your system includes an instrument that does not have this capability, you can put the following code segment in your program to read error messages and print them on the controller's display.

```
10 !
20 ! The rest of your
30 ! variable declarations
40 Assign @box to 719
50 DIM Err_msg$(75)
60 INTEGER Err_num
70 !
80 ! Part of your program
90 ! that generates errors
100 !
110 !
200 REPEAT
210 OUTPUT @Box;":SYST:ERR?"
220 ! Query instrument error
230 ENTER @Box;Err_num,Err_msg$
240 ! Read error #, message
250 PRINT Err_num,Err_msg$
260 ! Print error message
270 UNTIL Err_num = 0
280 ! Repeat until no errors
290 !
300 ! The rest of your program
310 !
```

## Details of Commands and Responses

This section describes the syntax of SCPI commands and responses. It provides many examples of the data types used for command parameters and response data.

### Program Message Syntax

These program messages contain commands combined with appropriate punctuation and program message terminators.

**Figure 1-12. Simplified Program Message Syntax**

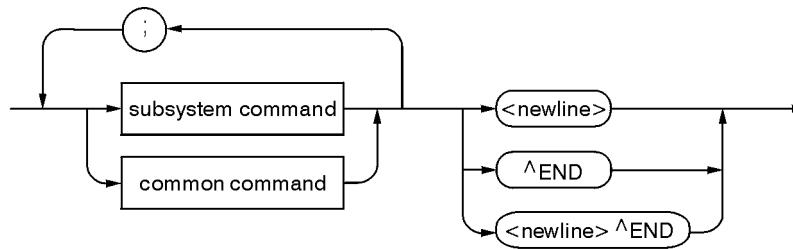

NOTES:

<newline> = ASCII character decimal '0'  
^END = EOI asserted with last byte

ck712a

You can send common commands and subsystem commands in the same message as shown in [Figure 1-12](#). If you send more than one command in the same message, you must separate them with a semicolon. You must always end a program message with one of the three program message terminators shown in [Figure 1-12](#). Use <new line>, <END>, or <new line> <END> as the program message terminator. The word <END> means that EOI is asserted on the GPIB interface at the same time the preceding data byte is sent. Most programming languages send these terminators automatically. For example, if you use the HP BASIC OUTPUT statement, <new line> is automatically sent after your last data byte. If you are using a PC, you can usually configure the system to send whatever terminator you specify.

## SCPI Subsystem Command Syntax

Figure 1-13. SCPI Simplified Subsystem Command Syntax

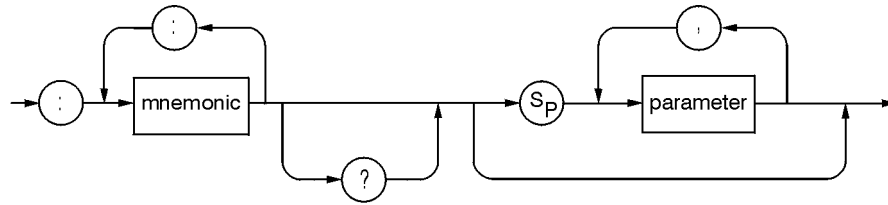

NOTE:

SP = white space, ASCII characters  $0_{10}$  to  $9_{10}$   
and  $11_{10}$  to  $32_{10}$

ck713a

There must be a <space> between the last command mnemonic and the first parameter in a subsystem command as shown in Figure 1-13. This is one of the few places in SCPI where <space> is required. Note that if you send more than one parameter with a single command, you must separate adjacent parameters with a comma. Parameter types are explained later in this subsection.

## Common Command Syntax

Figure 1-14. Simplified Common Command Syntax

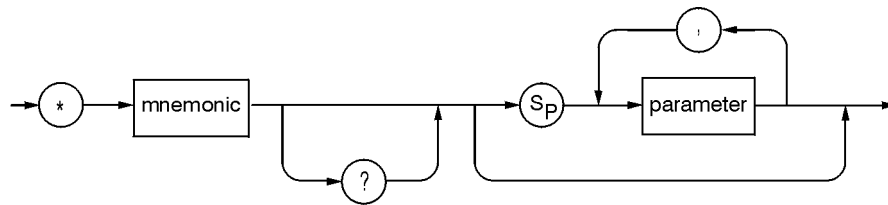

NOTE:

SP = white space, ASCII characters  $0_{10}$  to  $9_{10}$   
and  $11_{10}$  to  $32_{10}$

ck714a

As with subsystem commands, use a <space> to separate a command mnemonic from subsequent parameters. Separate adjacent parameters with a comma. Parameter types are explained later in this section.



## Response Message Syntax

**Figure 1-15. Simplified Response Message Syntax**

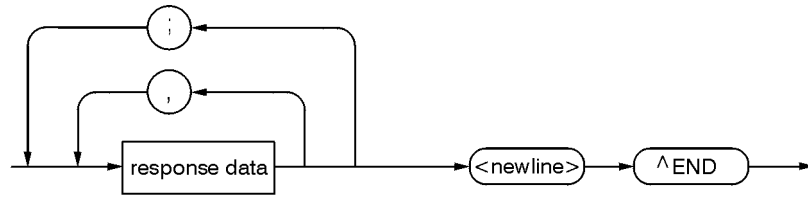

ck715a

Response messages can contain both commas and semicolons as separators. When a single query command returns multiple values, a comma separates each data item. When multiple queries are sent in the same message, the groups of data items corresponding to each query are separated by a semicolon. For example, the fictitious query :QUERY1?:QUERY2? might return a response message of:

, ; ,

Response data types are explained later in this subsection. Note that <new line><END> is always sent as a response message terminator.

## SCPI Data Types

SCPI defines different data formats for use in program messages and response messages. It does this to accommodate the principle of forgiving listening and precise talking. Forgiving listening means that instruments are flexible, accepting commands and parameters in various formats. Precise talking means an instrument always responds to a particular query in a predefined, rigid format. Parameter data types are designed to be flexible in the spirit of forgiving listening. Conversely, response data types are defined to meet the requirements of precise talking.

Parameter Types	Response Data Types
Numeric	Real or Integer
Extended Numeric	Integer
Discrete	Discrete
Boolean	Numeric Boolean
String	String
Block	Definite Length Block (all interfaces) Indefinite Length Block (not supported with RS-232)
Non-decimal Numeric	Hexadecimal Octal Binary

Each parameter type has one or more corresponding response data types. For example, a setting that you program using a numeric parameter returns either real or integer response data when queried. Whether real or integer response data is returned depends on the instrument used. However, precise talking requires that the response data type be clearly defined for a particular instrument and query. [Chapter 2](#) contains information about data types for individual commands.

## Parameter Types

**Numeric Parameters** Numeric parameters are used in both subsystem commands and common commands. Numeric parameters accept all commonly used decimal representations of numbers including optional signs, decimal points, and scientific notation.

If an instrument setting programmed with a numeric parameter can only assume a finite number of values, the instrument automatically rounds the parameter. For example, if an instrument has a programmable output impedance of 50 or 75 ohms, and you specified 76.1 for output impedance, the value is rounded to 75. If the instrument setting can only assume integer values, it automatically rounds the value to an integer. For example sending \*ESE 10.123 is the same as sending \*ESE 10.

Examples of numeric parameters:

100	no decimal point required
100.	fractional digits optional
-1.23	leading signs allowed
4.56e<space>3	space allowed after e in exponential
-7.89E-01	use either E or e in exponential
+256	leading + allowed
.5	digits left of decimal point optional

**Extended Numeric Parameters** Most subsystems use extended numeric parameters to specify physical quantities. Extended numeric parameters accept all numeric parameter values and other special values as well. All extended numeric parameters accept MAXimum and MINimum as values. Other special values, such as UP and DOWN may be available as documented in [Chapter 2](#). Notice that MINimum and MAXimum can be used to set or query values. The query forms are useful for determining the range of values allowed for a given parameter.

In some instruments, extended numeric parameters accept engineering unit suffixes as part of the parameter value.

Notice that extended numeric parameters are not used for common commands or STATUS subsystem commands.

Examples of extended numeric parameters:

100.	any simple numeric values
-1.23	
4.56e<space>3	
-7.89E-01	
+256	
.5	
MAX	largest valid setting
MIN	valid setting nearest negative infinity
-100 mV	negative 100 millivolts

**Discrete Parameters** Use discrete parameters to program settings that have a finite number of values. Discrete parameters use mnemonics to represent each valid setting. They have a long and a short form, just like command mnemonics. You can use mixed upper and lower case letters for discrete parameters.

Examples of discrete parameters used with the TRIG:SOURce subsystem:

BUS	GPIB triggering
IMMediate	immediate trigger
EXTernal	external triggering

Although discrete parameter values look like command keywords, do not confuse the two. In particular, be sure to use colons and spaces properly. Use a colon to separate command mnemonics from each other. Use a space to separate parameters from command mnemonics.

Examples of discrete parameters in commands:

```
100 OUTPUT @Source;"TRIGger:SOURce BUS"
100 OUTPUT @Source;"TRIGger:SOURce IMMediate"
100 OUTPUT @Source;"TRIGger:SOURce EXTernal"
```

**Boolean Parameters** Boolean parameters represent a single binary condition that is either true or false. There are only four possible representations for a Boolean parameter:

- ON Boolean true, upper/lower case allowed
- OFF Boolean false, upper/lower case allowed
- 1 Boolean true
- 0 Boolean false

**Block Parameters** A data block contains the data of primary interest. It may contain dimensioned data such as DATA(CURVe), or specific sets of data (WAVEform, etc.). At least one data block is required and multiple data blocks are allowed. The following table details the data block for a List Pattern data block, used to write pattern lists directly to the instrument's baseband generator board:

- Bit 0 (1) data value: 0 or 1 as required for a data bit.
- Bit 1 (2) Always 0
- Bit 2 (4) Burst control: 0 for burst off, 1 for burst on. All data values that require power out must have this bit on.
- Bit 3 (8) Always 0
- Bit 4 (16) Always 16
- Bit 5 (32) Always 0
- Bit 6 (64) Event 1 control: 0 or 1, as desired on the EVENT1 output.
- Bit 7 (128) Pattern reset: Reset the pattern to start after this entry is processed.

## Response Data Types

**Real Response Data** A large portion of all measurement data are formatted as real response data. Real response data are decimal numbers in either fixed decimal notation or scientific notation. Most high-level programming languages that support instrument I/O handle either decimal or scientific notation transparently.

Examples of real response data:

- 1.23E+0
- 1.0E+2
- +1.0E+2
- 0.5E+0
- 1.23
- 100.0
- +100.0
- 0.5

**Integer Response Data** Integer response data are decimal representations of integer values including optional signs. Most status register related queries return integer response data.

Examples of integer response data:

0	signs are optional
+100	leading + sign allowed
-100	leading sign allowed
256	never any decimal point

**Discrete Response Data** Discrete response data are similar to discrete parameters. The main difference is that discrete response data return only the short form of a particular mnemonic, in all upper case letters.

Examples of discrete response data:

IMM	Immediate
EXT	External

**String Response Data** String response data are similar to string parameters. The main difference is that string response data use only double quotes as delimiters, rather than single quotes. Embedded double quotes may be present in string response data. Embedded quotes appear as two adjacent double quotes with no characters between them.

Examples of string response data:

“This IS valid”  
“SO IS THIS” “  
“I said, ““Hello!”””

---

## Programming the Status Register System

The signal generator's instrument status system provides complete IEEE 488.2 Device Standard data structures for reporting instrument status using the register model.

The IEEE 488.2 register model of the status system is comprised of multiple registers which are arranged in a hierarchical order. The lower-priority status registers propagate their data to the higher-priority registers in the data structures by means of summary bits. The Status Byte Register is at the top of the hierarchy and contains the general status information for the instrument's events and conditions. All other individual registers are used to determine the specific events or conditions.

You can determine the state of certain instrument hardware and firmware events and conditions by programming the status register system.

Figure 1-16. The Overall Status Byte Register System

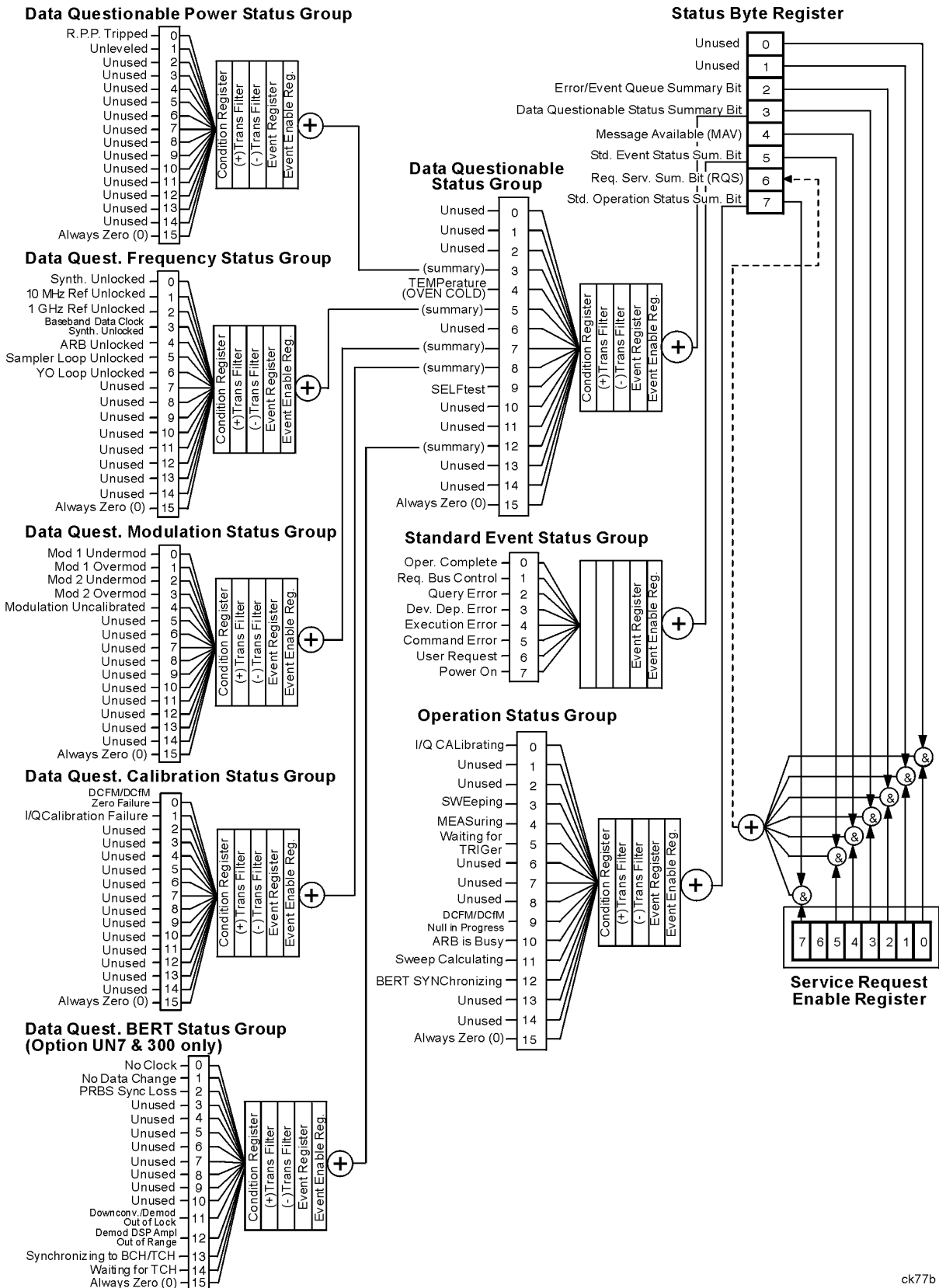

ck77b

## Status Byte Group

Figure 1-17. The Status Byte Group

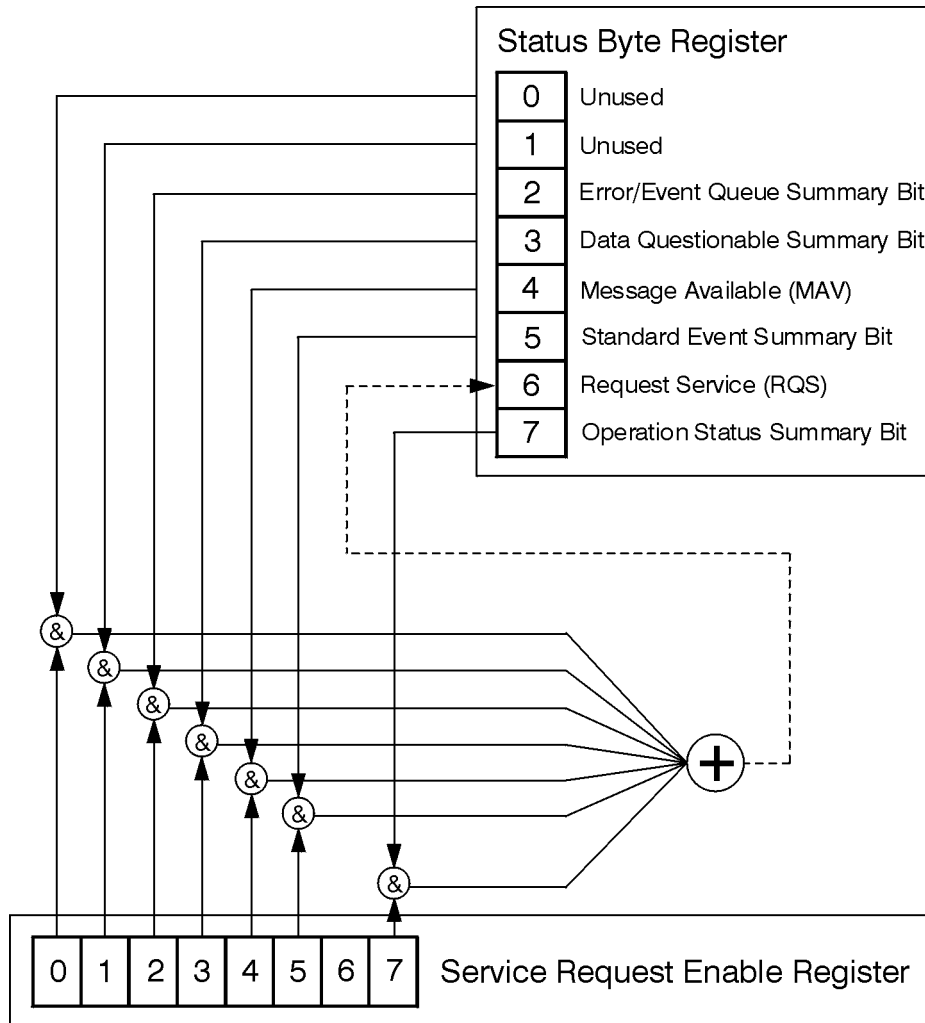

ck721a



The Status Byte Group consists of the Status Byte Register and the Service Request Enable Register. The Status Byte Register contains the following bits:

**Figure 1-18.**

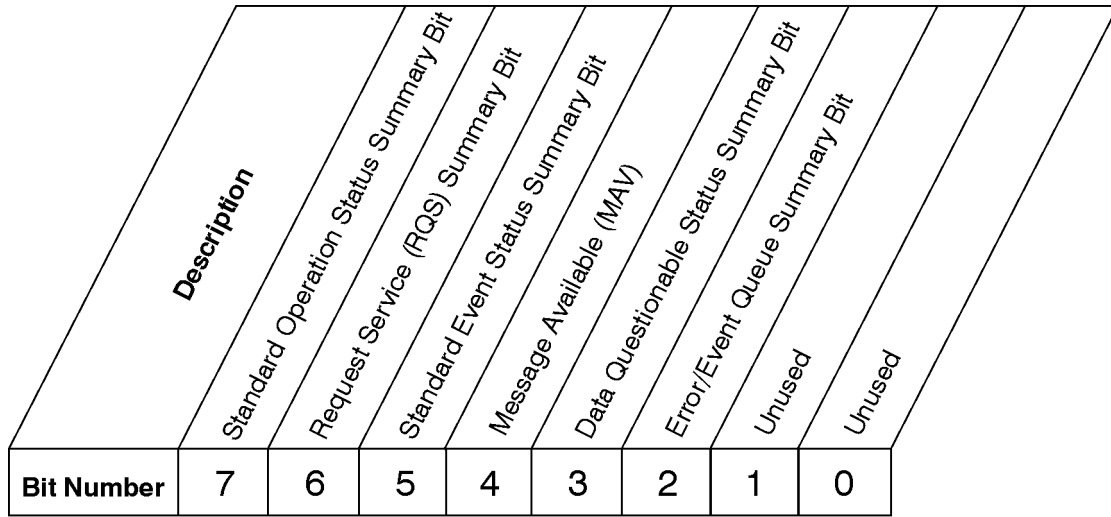

\*STB?

**Status Byte Register**

ck725a

Bit	Description
0, 1	These bits are always set to 0.
2	A 1 in this bit position indicates that the SCPI error queue is not empty. The SCPI error queue contains at least one error message.
3	A 1 in this bit position indicates that the Data Questionable summary bit has been set. The Data Questionable Event Register can then be read to determine the specific condition that caused this bit to be set.
4	A 1 in this bit position indicates that the signal generator has data ready in the output queue. There are no lower status groups that provide input to this bit.
5	A 1 in this bit position indicates that the Standard Event summary bit has been set. The Standard Event Status Register can then be read to determine the specific event that caused this bit to be set.
6	A 1 in this bit position indicates that the instrument has at least one reason to require service. This bit is also called the Master Summary Status bit (MSS). The individual bits in the Status Byte are individually ANDed with their corresponding service request enable register, then each individual bit value is Ored and input to this bit.
7	A 1 in this bit position indicates that the Standard Operation summary bit has been set. The Standard Operation Event Register can then be read to determine the specific condition that caused this bit to be set.

To query the Status Byte Register, send the command `*STB?` The response will be the *decimal* sum of the bits which are set to 1. For example, if bit number 7 and bit number 3 are set to 1, the decimal sum of the 2 bits is 128 plus 8. So the decimal value 136 is returned.

In addition to the Status Byte Register, the Status Byte Group also contains a Service Request Enable Register. This register lets you choose which bits in the Status Byte Register will trigger a service request. Send the `*SRE <num>` command where `<num>` is the sum of the decimal values of the bits you want to enable plus the decimal value of bit 6. For example, to enable bit 7 so that whenever the Standard Operation Status Register summary bit is set to 1 it will trigger a service request, send the command `*SRE 192` (128 + 64). You must always enable bit 6 when you enable any other bits for a service request. The command `*SRE?` returns the decimal value of the sum of the bits previously enabled with the `*SRE <num>` command.

**Figure 1-19.**

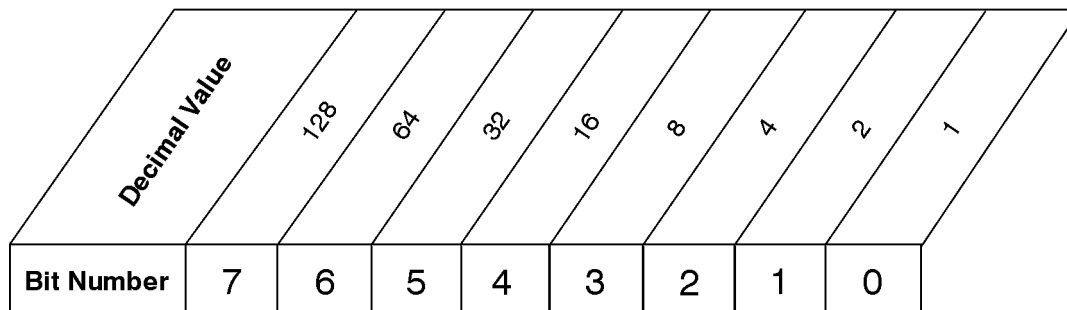

`*SRE <num>`  
`*SRE?`

**Service Request Enable Register**

ck726a

**Status Groups**

The Standard Operation Status Group and the Data Questionable Status Group each consist of the following registers; the Standard Event Status Group is similar but does not have negative or positive transition filters.

Condition Register

A condition register continuously monitors the hardware and firmware status of the signal generator. There is no latching or buffering for a condition register; it is updated in real time.

Negative Transition Filter

A negative transition filter specifies the bits in the condition register that will set corresponding bits in the event register when the condition bit changes from 1 to 0.

**Positive  
Transition  
Filter**

A positive transition filter specifies the bits in the condition register that will set corresponding bits in the event register when the condition bit changes from 0 to 1.

**Event  
Register**

An event register latches transition events from the condition register as specified by the positive and negative transition filters. Bits in the event register are latched, and once set, they remain set until cleared by either querying the register contents or sending the \*CLS command.

**Event  
Enable  
Register**

An enable register specifies the bits in the event register that can generate a summary bit. The signal generator logically ANDs corresponding bits in the event and enable registers and ORs all the resulting bits to produce a summary bit. Summary bits are, in turn, used by the Status Byte Register.

In general, a status group is a set of related registers whose contents are programmed in order to produce status summary bits. In each status group, corresponding bits in the condition register are filtered by the negative and positive transition filters and stored in the event register. The contents of the event register are logically ANDed with the contents of the enable register and the result is logically ORed to produce a status summary bit in the Status Byte Register.

### Standard Event Status Group

Figure 1-20. The Standard Event Status Group

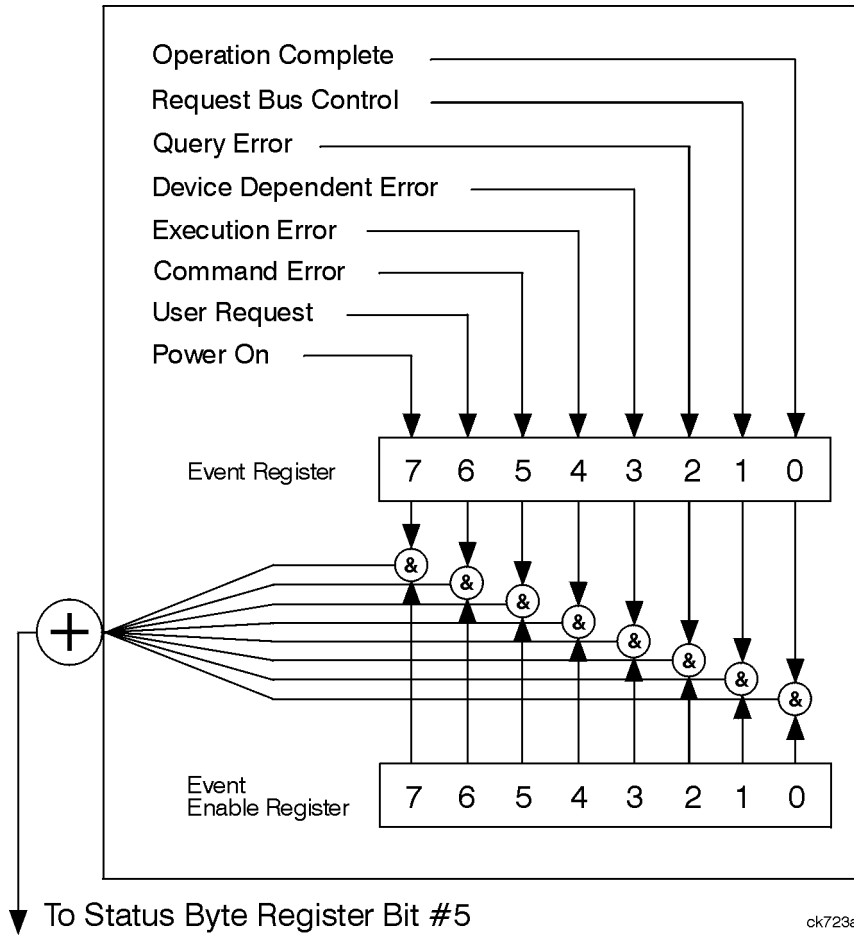

The Standard Event Status Group is used to determine the specific event that set bit 5 in the Status Byte Register. The Standard Event Status Group consists of the Standard Event Status Register (an event register) and the Standard Event Status Enable Register. The Standard Event Status Register contains the following bits:

Figure 1-21.

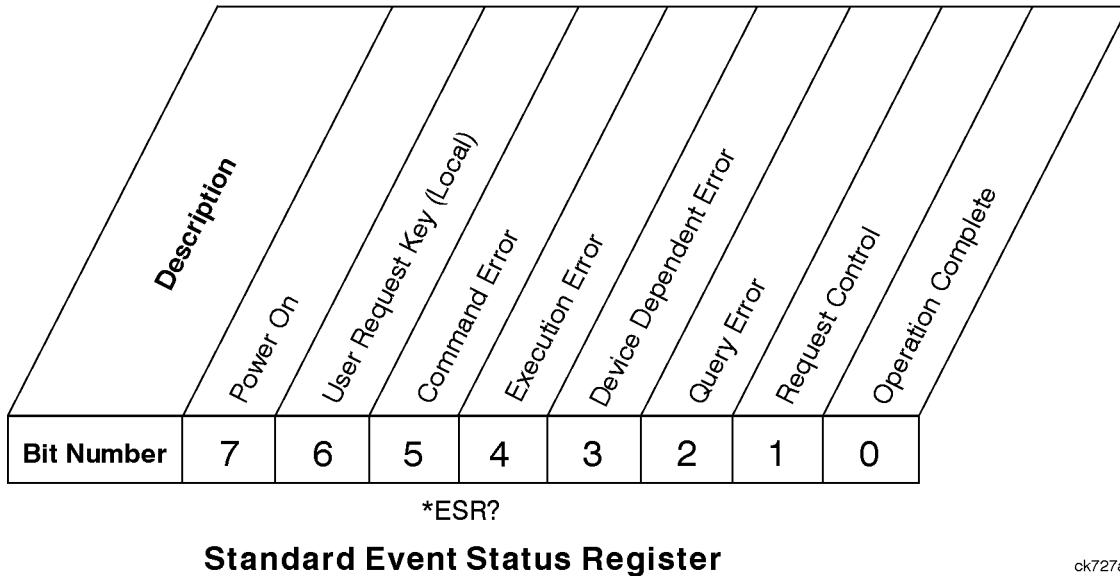

Bit	Description
0	A 1 in this bit position indicates that all pending signal generator operations were completed following execution of the *OPC command.
1	This bit is always set to 0. (The signal generator does not request control.)
2	A 1 in this bit position indicates that a query error has occurred. Query errors have SCPI error numbers from -499 to -400.
3	A 1 in this bit position indicates that a device dependent error has occurred. Device dependent errors have SCPI error numbers from -399 to -300 and 1 to 32767.
4	A 1 in this bit position indicates that an execution error has occurred. Execution errors have SCPI error numbers from -299 to -200.
5	A 1 in this bit position indicates that a command error has occurred. Command errors have SCPI error numbers from -199 to -100.
6	A 1 in this bit position indicates that the <b>Local</b> key has been pressed. This is true even if the signal generator is in local lockout mode.
7	A 1 in this bit position indicates that the signal generator has been turned off and then on.

To query the Standard Event Status Register, send the command `*ESR?`. The response will be the *decimal* sum of the bits which are set to 1. For example, if bit number 7 and bit number 3 are set to 1, the decimal sum of the 2 bits is 128 plus 8. So the decimal value 136 is returned.

**Figure 1-22.**

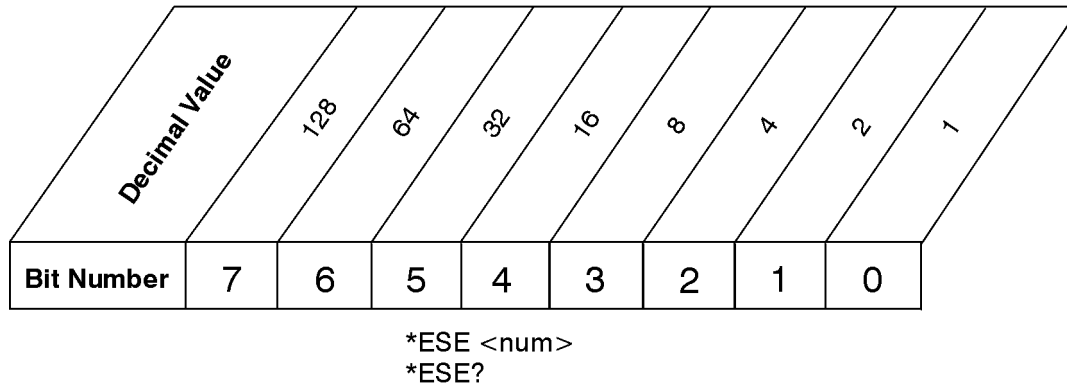

**Standard Event Status Enable Register**

ck728a

In addition to the Standard Event Status Register, the Standard Event Status Group also contains a Standard Event Status Enable Register. This register lets you choose which bits in the Standard Event Status Register will set the summary bit (bit 5 of the Status Byte Register) to 1. Send the `*ESE <num>` command where `<num>` is the sum of the decimal values of the bits you want to enable. For example, to enable bit 7 and bit 6 so that whenever either of those bits is set to 1, the Standard Event Status summary bit of the Status Byte Register will be set to 1, send the command `*ESE 192 (128 + 64)`. The command `*ESE?` returns the decimal value of the sum of the bits previously enabled with the `*ESE <num>` command.

### Standard Operation Status Group

Figure 1-23. The Standard Operation Status Group

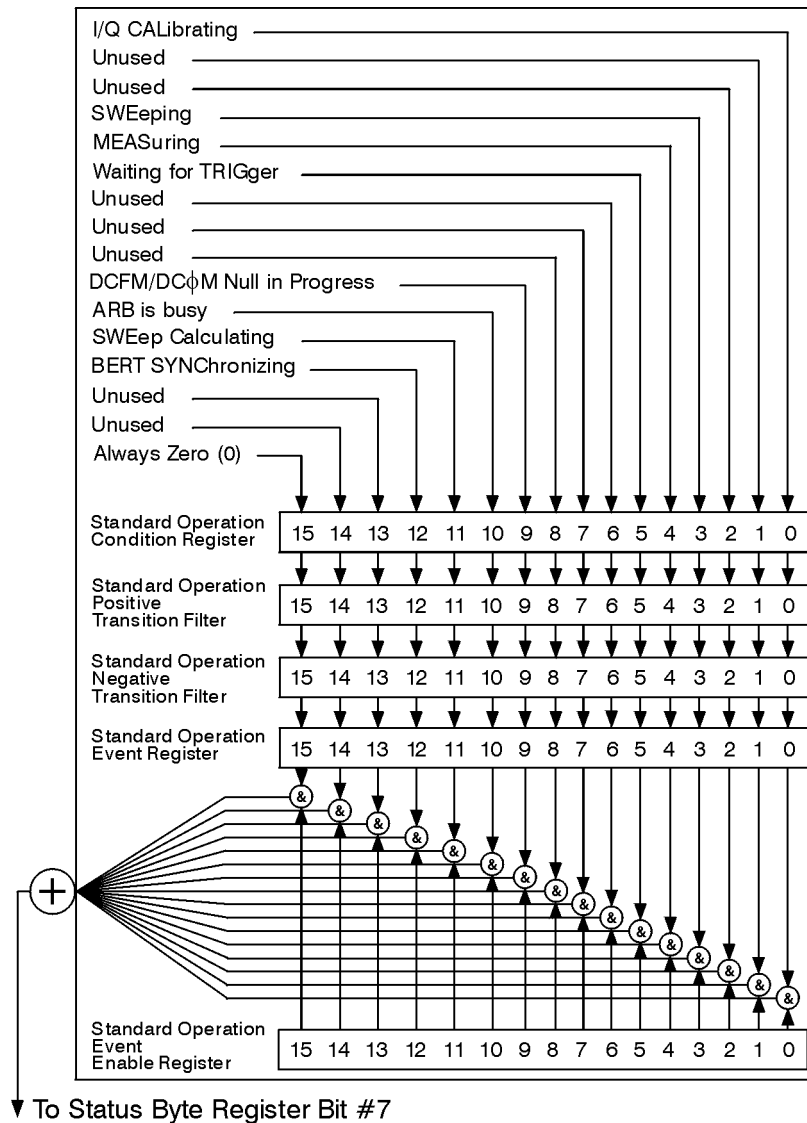

ck78b

The Standard Operation Status Group is used to determine the specific event that set bit 7 in the Status Byte Register. The Standard Operation Status Group consists of the Standard Operation Condition Register, the Standard Operation Negative Transition Filter, the Standard Operation Positive Transition Filter, the Standard Operation Event Register, and the Standard Operation Event Enable Register. The Standard Operation Condition Register contains the following bits:

Figure 1-24.

Bit Number	15	14	13	12	11	10	9	8	7	6	5	4	3	2	1	0
Description	Always Zero (0)	Unused	Unused	BERT SYNChronizing	SWEEP Calculating	ARB is busy	DCFM/DCΦM Null In Progress	Unused	Unused	Unused	Waiting for TRIGger	MEASuring	SWEEPing	Unused	Unused	I/Q CALibrating

STATus:OPERation:CONDition?

### Standard Operation Condition Register

ck79b

Bit	Description
0	A 1 in this bit position indicates that an I/Q calibration is being performed.
1, 2	Unused. These bits are always set to 0.
3	A 1 in this bit position indicates that a sweep is in progress.
4	A 1 in this bit position indicates that a bit error rate test is in progress (Options UN7 and 300 only).
5	A 1 in this bit position indicates that the source is in a “wait for trigger” state of the trigger model.
6, 7, 8	Unused. These bits are always set to 0.
9	A 1 in this bit position indicates that the signal generator is currently performing a DCFM/DCΦM zero calibration.
10	A 1 in this bit position indicates that the signal generator is currently busy processing ARB commands.
11	A 1 in this bit position indicates that the signal generator is currently doing the necessary pre-sweep calculations.
12	A 1 in this bit position indicates that the signal generator is currently synchronizing to BCH, TCH, and PRBS.
13, 14	Unused. These bits are always set to zero.
15	Always Zero (0).



The Standard Operation Condition Register continuously monitors the hardware and firmware status of the instrument. Condition registers are read-only. To query the condition register, send the command `STATUS:OPERation:CONDition?` The response will be the *decimal* sum of the bits which are set to 1. For example, if bit number 9 and bit number 3 are set to 1, the decimal sum of the 2 bits is 512 plus 8. So the decimal value 520 is returned.

The transition filter specifies which types of bit state changes in the condition register will set corresponding bits in the event register. The changes may be positive (from 0 to 1) or negative (from 1 to 0). Send the command `STATUS:OPERation:NTRansition <num>` (negative) or `STATUS:OPERation:PTRansition <num>` (positive) where `<num>` is the sum of the decimal values of the bits you want to enable.

The Standard Operation Event Register latches transition events from the condition register as specified by the transition filters. Event registers are destructive read-only. Reading data from an event register will clear the content of that register. To query the event register, send the command `STATUS:OPERation[:EVENT]?`

**Figure 1-25.**

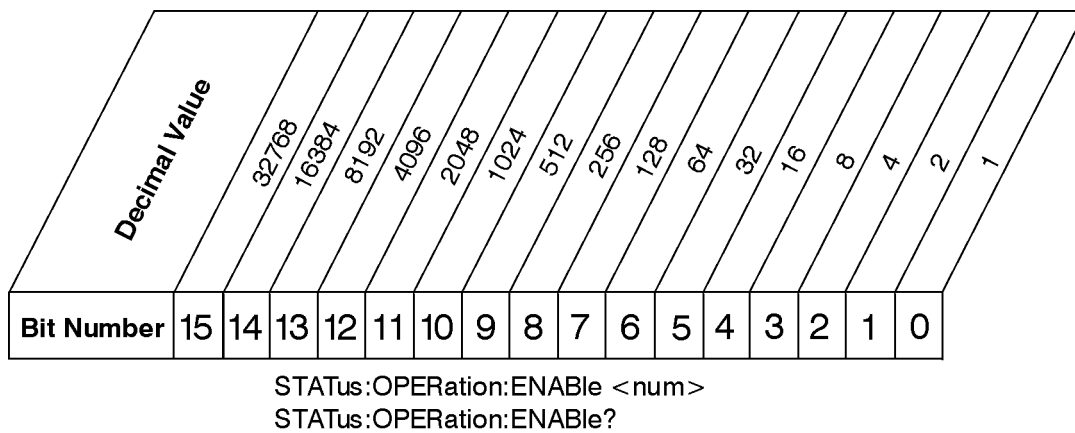

**Standard Operation Event Enable Register**

ck730a

The Standard Operation Status Group also contains a Standard Operation Event Enable Register. This register lets you choose which bits in the Standard Operation Event Register will set the summary bit (bit 7 of the Status Byte Register) to 1. Send the `STATUS:OPERation:ENABLE <num>` command where `<num>` is the sum of the decimal values of the bits you want to enable. For example, to enable bit 9 and bit 3 so that whenever either of those bits is set to 1, the Standard Operation Status summary bit of the Status Byte Register will be set to 1, send the command `STAT:OPER:ENAB 520` (512 + 8). The command `STATUS:OPERation:ENABLE?` returns the decimal value of the sum of the bits previously enabled with the `STATUS:OPERation:ENABLE <num>` command.

## Data Questionable Status Group

Figure 1-26. The Data Questionable Status Group

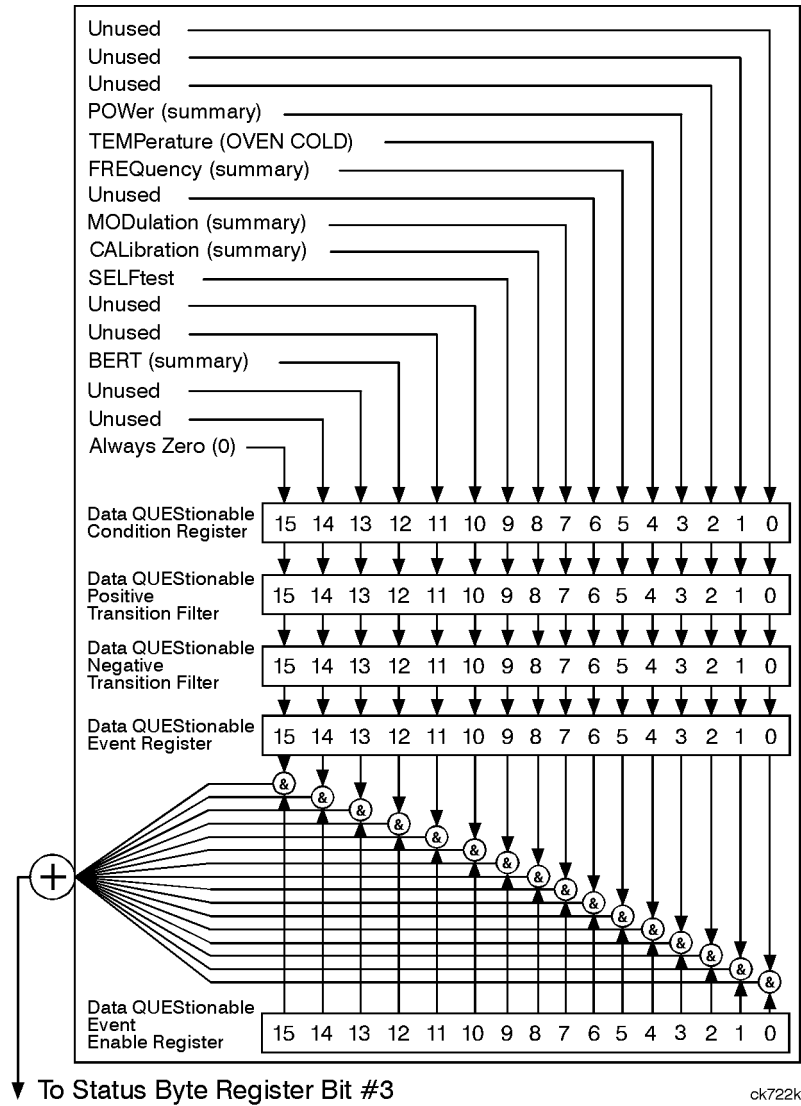

The Data Questionable Status Group is used to determine the specific event that set bit 3 in the Status Byte Register. The Data Questionable Status Group consists of the Data Questionable Condition Register, the Data Questionable Negative Transition Filter, the Data Questionable Positive Transition Filter, the Data Questionable Event Register, and the Data Questionable Event Enable Register. The Data Questionable Condition Register contains the following bits:

**Figure 1-27.**

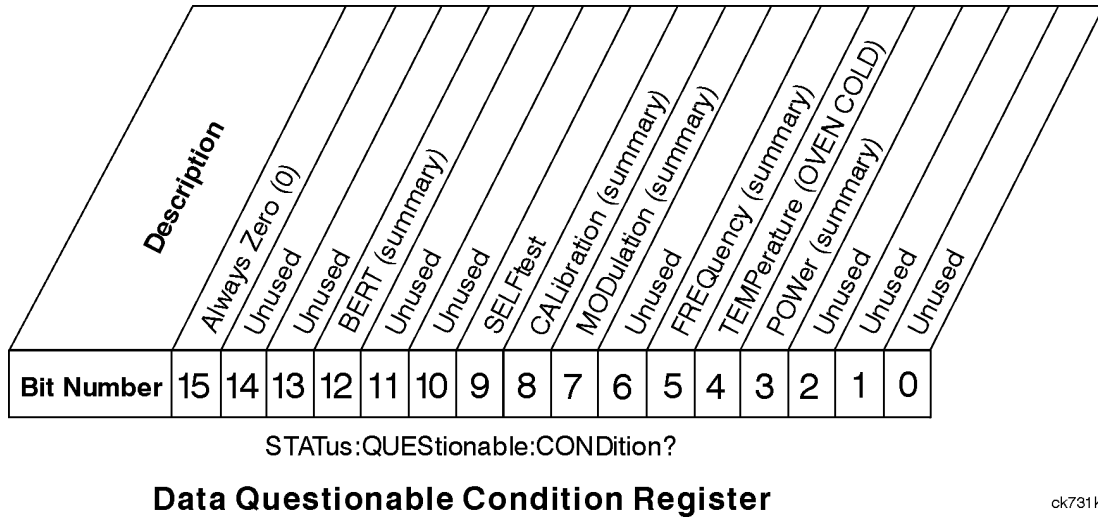

Bit	Description
0, 1, 2	Unused. These bits are always set to 0.
3	This is a summary bit taken from the QUESTIONable:POWER register. A 1 in this bit position indicates that one of the following may have happened: The ALC (Automatic Leveling Control) is unable to maintain a leveled RF output power (i.e., ALC is UNLEVELED), or the reverse power protection circuit has been tripped.
4	A 1 in this bit position indicates that the internal reference oscillator (reference oven) is cold.
5	This is a summary bit taken from the QUESTIONable:FREQUENCY register. A 1 in this bit position indicates that one of the following may have happened: synthesizer PPL unlocked, 10 MHz reference VCO PPL unlocked, heterodyned VCO PPL unlocked, or baseband PPL unlocked. See the Data Questionable Frequency Status Group for more information.
6	Unused. This bit is always set to 0.
7	This is a summary bit taken from the QUESTIONable:MODulation register. A 1 in this bit position indicates that one of the following may have happened: modulation source 1 underrange, modulation source 1 overrange, modulation source 2 underrange, or modulation source 2 overrange. See the Data Questionable Modulation Status Group for more information.

Bit	Description
8	This is a summary bit taken from the QUESTIONable:CALibration register. A 1 in this bit position indicates that one of the following may have happened: an error has occurred in the DCFM/DCΦM zero calibration or an error has occurred in the I/Q calibration. See the Data Questionable Calibration Status Group for more information.
9	A 1 in this bit position indicates that a self-test has failed during power-up. This bit can only be cleared by cycling the instrument's line power. *CLS will not clear this bit.
10, 11	Unused. These bits are always set to 0.
12	This is a summary bit taken from the QUESTIONable:BERT register. A 1 in this bit position indicates that one of the following may have happened: no clock, no data change, or sync loss state for a bit error rate test (Option UN7 only). See the Data Questionable Calibration Status Group for more information.
13, 14	Unused. These bits are always set to 0.
15	Always Zero (0).

The Data Questionable Condition Register continuously monitors the hardware and firmware status of the instrument. Condition registers are read-only. To query the condition register, send the command `STATUS:QUESTIONable:CONDition?` The response will be the *decimal* sum of the bits which are set to 1. For example, if bit number 9 and bit number 3 are set to 1, the decimal sum of the 2 bits is 512 plus 8. So the decimal value 520 is returned.

The transition filter specifies which types of bit state changes in the condition register will set corresponding bits in the event register. The changes may be positive (from 0 to 1) or negative (from 1 to 0). Send the command `STATUS:QUESTIONable:NTRansition <num>` (negative) or `STATUS:QUESTIONable:PTRansition <num>` (positive) where <num> is the sum of the decimal values of the bits you want to enable.

The Data Questionable Event Register latches transition events from the condition register as specified by the transition filters. Event registers are destructive read-only. Reading data from an event register will clear the content of that register. To query the event register, send the command `STATUS:QUESTIONable[:EVENT]?`

Figure 1-28.

<b>Decimal Value</b>																		
		32768	16384	8192	4096	2048	1024	512	256	128	64	32	16	8	4	2	1	
<b>Bit Number</b>	15	14	13	12	11	10	9	8	7	6	5	4	3	2	1	0		

STATus:QUESTionable:ENABLE <num>  
STATus:QUESTionable:ENABLE?

**Data Questionable Event Enable Register**

ck732a

The Data Questionable Status Group also contains a Data Questionable Event Enable Register. This register lets you choose which bits in the Data Questionable Event Register will set the summary bit (bit 3 of the Status Byte Register) to 1. Send the `STATus:QUESTionable:ENABLE <num>` command where <num> is the sum of the decimal values of the bits you want to enable. For example, to enable bit 9 and bit 3 so that whenever either of those bits is set to 1, the Data Questionable Status summary bit of the Status Byte Register will be set to 1, send the command `STAT:QUES:ENAB 520 (512 + 8)`. The command `STATus:QUESTionable:ENABLE?` returns the decimal value of the sum of the bits previously enabled with the `STATus:QUESTionable:ENABLE <num>` command.

## Data Questionable Power Status Group

Figure 1-29. The Data Questionable Power Status Group

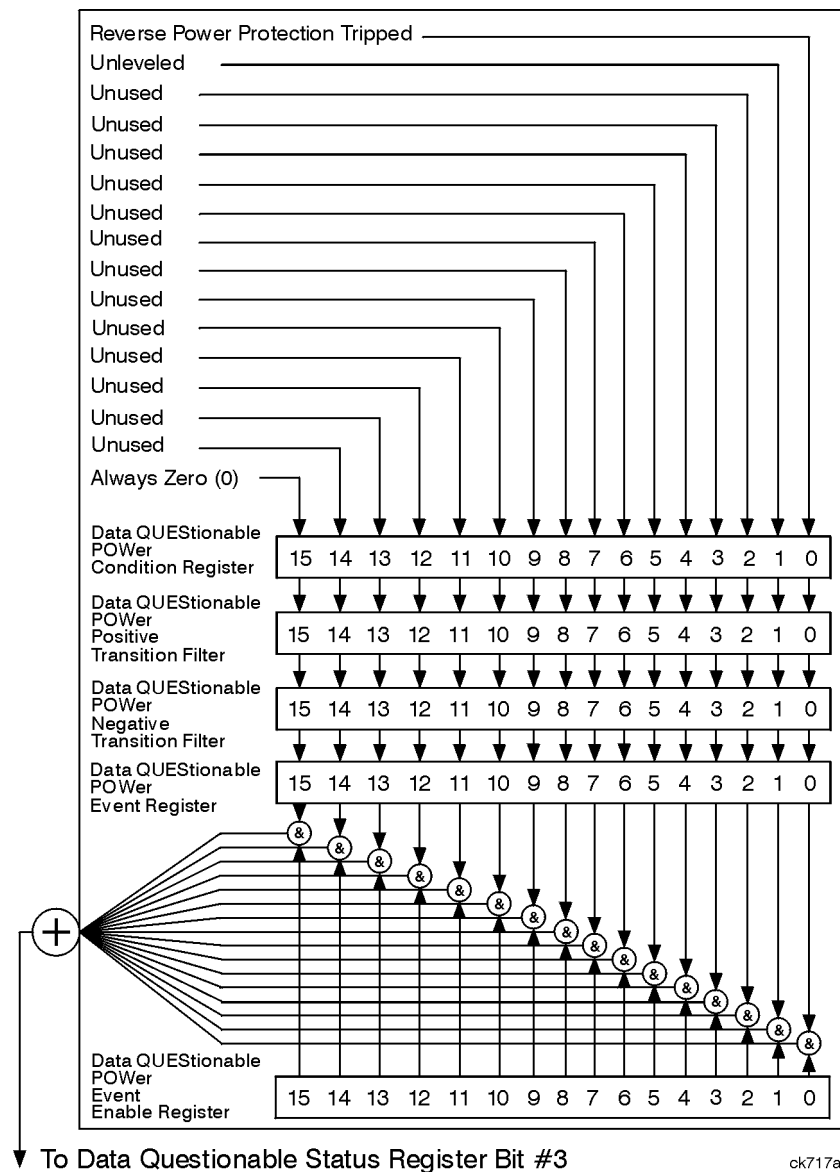

The Data Questionable Power Status Group is used to determine the specific event that set bit 3 in the Data Questionable Condition Register. The Data Questionable Power Status Group consists of the Data Questionable Power Condition Register, the Data Questionable Power Negative Transition Filter, the Data Questionable Power Positive Transition Filter, the Data Questionable Power Event Register, and the Data Questionable Power Event Enable Register. The Data Questionable Power Condition Register contains the following bits:

Figure 1-30.

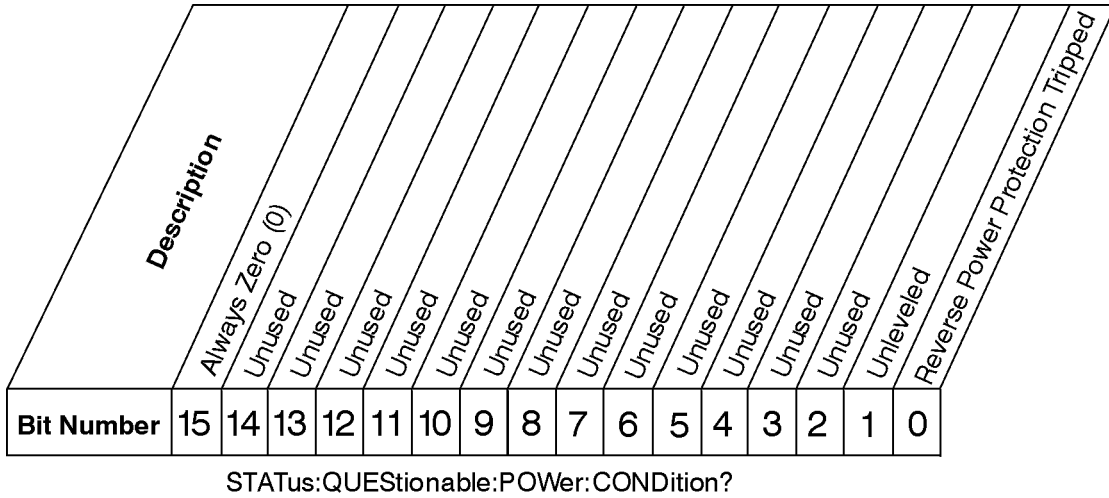

**Data Questionable Power Condition Register**

ck735a

Bit	Description
0	A 1 in this bit indicates that the reverse power protection circuit has been tripped. There is no output in this state. Any conditions that may have caused reverse power should be corrected. After correcting the problem, the RPP circuit can be reset by sending the remote SCPI command statement :OUTput:PROTEction:CLEar or by pressing the <b>Reset RPP</b> softkey on the front panel. In 8648 mode, any SCPI command resets the reverse power protection circuit.
1	A 1 in this bit indicates that the output leveling loop is unable to set the output power.
2–14	Unused. These bits are always set to 0.
15	Always Zero (0).

The Data Questionable Power Condition Register continuously monitors output power status of the instrument. Condition registers are read-only. To query the condition register, send the command `STATus:QUESTionable:POWer:CONDition?` The response will be the *decimal* sum of the bits which are set to 1.

The transition filter specifies which types of bit state changes in the condition register will set corresponding bits in the event register. The changes may be positive (from 0 to 1) or negative (from 1 to 0). Send the command `STATus:QUESTionable:POWer:NTRansition <num>` (negative) or `STATus:QUESTionable:POWer:PTRansition <num>` (positive) where <num> is the sum of the decimal values of the bits you want to enable.

The Data Questionable Power Event Register latches transition events from the condition register as specified by the transition filters. Event registers are destructive read-only. Reading data from an event register will clear the content of that register. To query the event register, send the command `STATUS:QUESTIONable:POWER[:EVENT]?`

**Figure 1-31.**

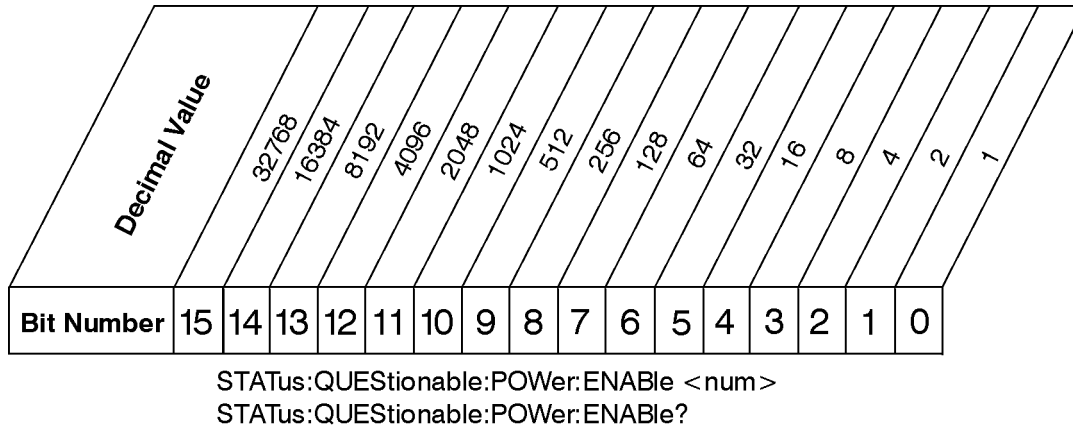

**Data Questionable Power Event Enable Register**

ck736a

The Data Questionable Power Status Group also contains a Data Questionable Power Event Enable Register. This register lets you choose which bits in the Data Questionable Power Event Register will set the summary bit (bit 3 of the Data Questionable Condition Register) to 1. Send the `STATUS:QUESTIONable:POWER:ENABLE <num>` command where `<num>` is the sum of the decimal values of the bits you want to enable. For example, to enable bit 9 and bit 3 so that whenever either of those bits is set to 1, the Data Questionable Power summary bit of the Data Questionable Condition Register will be set to 1, send the command `STAT:QUES:POW:ENAB 520 (512 + 8)`. The command `STATUS:QUESTIONable:POWER:ENABLE?` returns the decimal value of the sum of the bits previously enabled with the `STATUS:QUESTIONable:POWER:ENABLE <num>` command.



### Data Questionable Frequency Status Group

Figure 1-32. Data Questionable Frequency Status Group

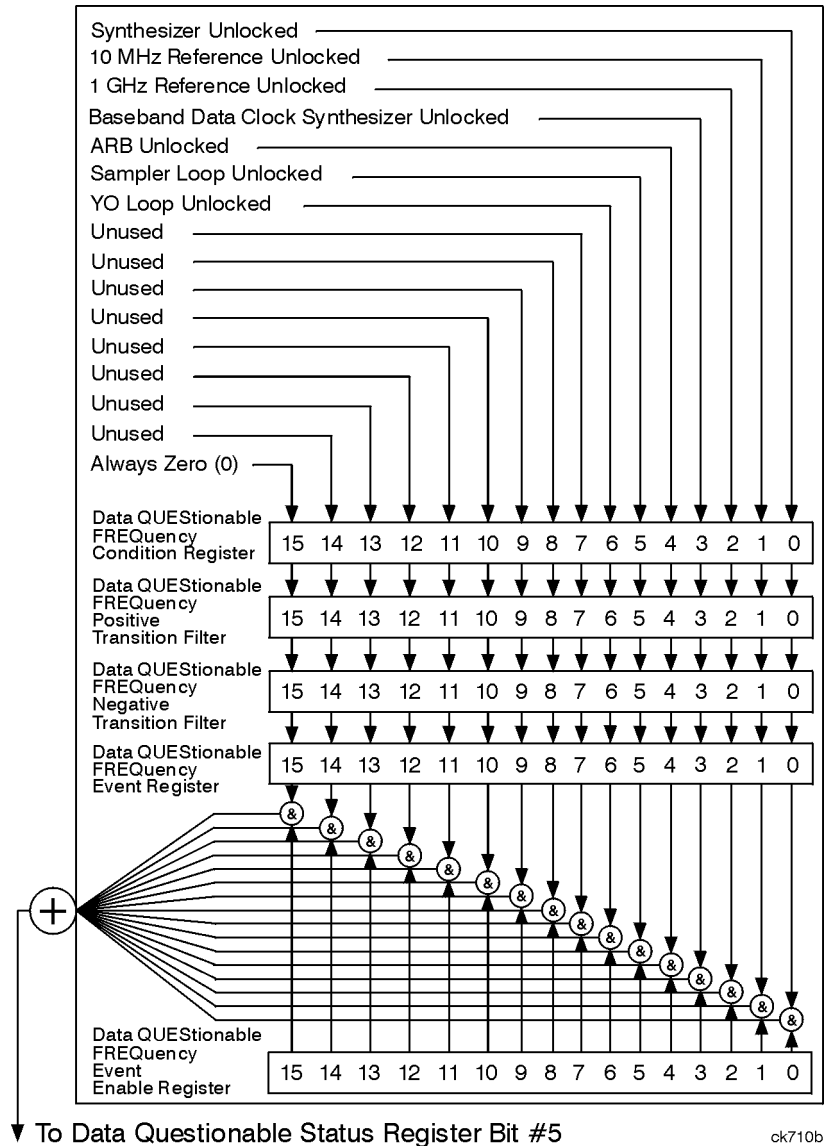

The Data Questionable Frequency Status Group is used to determine the specific event that set bit 5 in the Data Questionable Condition Register. The Data Questionable Frequency Status Group consists of the Data Questionable Frequency Condition Register, the Data Questionable Frequency Status Group, the Data Questionable Frequency Negative Transition Filter, the Data Questionable Frequency Positive Transition Filter, the Data Questionable Frequency Event Register, and the Data Questionable Frequency Event Enable Register. The Data Questionable Frequency Condition Register contains the following bits:

Figure 1-33.

Bit Number	Description
15	Always Zero (0)
14	Unused
13	Unused
12	Unused
11	Unused
10	Unused
9	Unused
8	Unused
7	Unused
6	YO Loop Unlocked
5	Sampler Loop Unlocked
4	ARB Unlocked
3	Baseband Unlocked
2	1 GHz Reference Unlocked
1	10 MHz Reference Unlocked
0	Synthesizer Unlocked

STATUS:QUESTIONABLE:FREQUENCY:CONDITION?

### Data Questionable Frequency Condition Register

ck711b

Bit	Description
0	A 1 in this bit indicates that the synthesizer is unlocked.
1	A 1 in this bit indicates that the 10 MHz reference signal is unlocked.
2	A 1 in this bit indicates that the 1 GHz reference signal is unlocked.
3	A 1 in this bit indicates that the baseband data clock synthesizer is unlocked.
4	A 1 in this bit indicates that the ARB is unlocked.
5	A 1 in this bit indicates that the sampler loop is unlocked.
6	A 1 in this bit indicates that the YO loop is unlocked.
7–14	Unused. These bits are always set to 0.
15	Always Zero (0).

The Data Questionable Frequency Condition Register continuously monitors output frequency status of the instrument. Condition registers are read-only. To query the condition register, send the command `STATUS:QUESTIONABLE:FREQUENCY:CONDITION?` The response will be the *decimal* sum of the bits which are set to 1.

The transition filter specifies which types of bit state changes in the condition register will set corresponding bits in the event register. The changes may be positive (from 0 to 1) or negative (from 1 to 0). Send the command  
`STATUS:QUESTIONABLE:FREQUENCY:NTRANSITION <num>` (negative) or  
`STATUS:QUESTIONABLE:FREQUENCY:PTRANSITION <num>` (positive) where <num> is the sum of the decimal values of the bits you want to enable.



### Data Questionable Modulation Status Group

Figure 1-35. Data Questionable Modulation Status Group

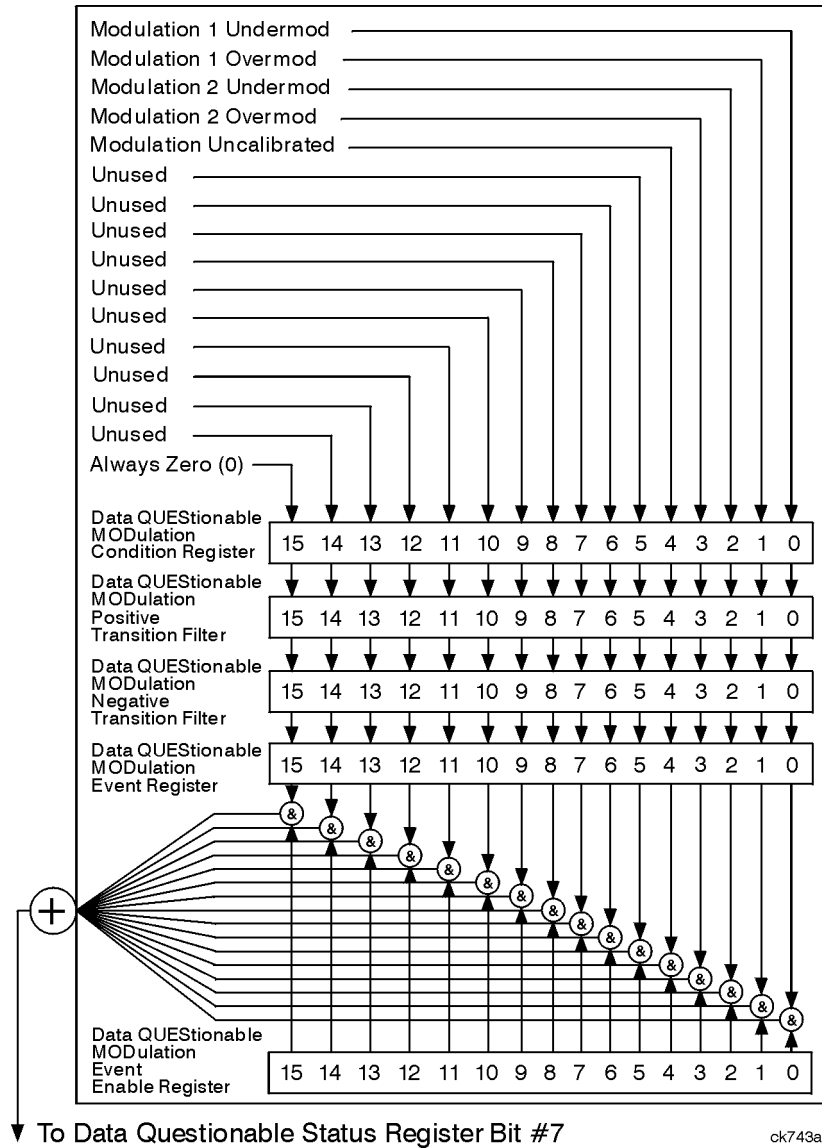

The Data Questionable Modulation Status Group is used to determine the specific event that set bit 7 in the Data Questionable Condition Register. The Data Questionable Modulation Status Group consists of the Data Questionable Modulation Condition Register, the Data Questionable Modulation Negative Transition Filter, the Data Questionable Modulation Positive Transition Filter, the Data Questionable Modulation Event Register, and the Data Questionable Modulation Event Enable Register. The Data Questionable Modulation Condition Register contains the following bits:

**Figure 1-36.**

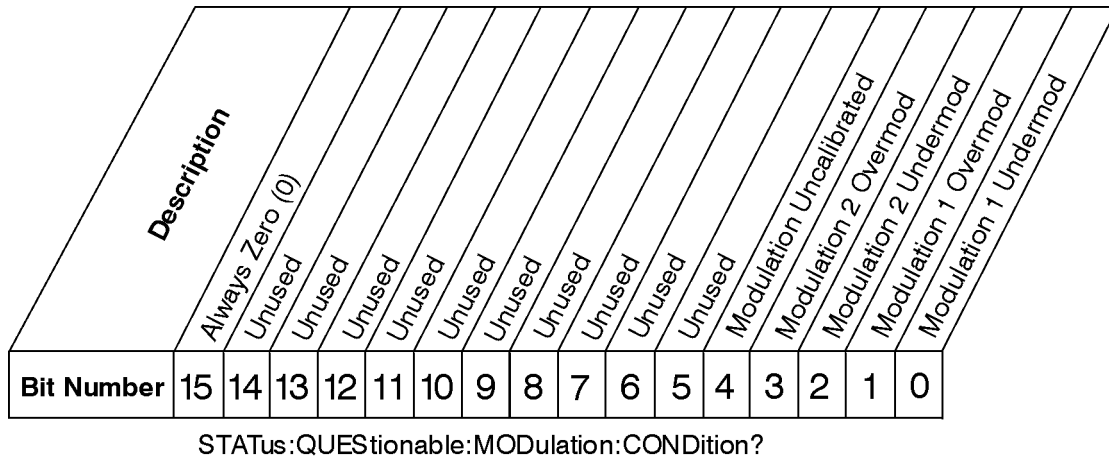

**Data Questionable Modulation Condition Register**

ck744a

Bit	Description
0	A 1 in this bit indicates that the External 1 input, AC coupling on, is less than 0.97 volts.
1	A 1 in this bit indicates that the External 1 input, AC coupling on, is more than 1.03 volts.
2	A 1 in this bit indicates that the External 2 input, AC coupling on, is less than 0.97 volts.
3	A 1 in this bit indicates that the External 2 input, AC coupling on, is more than 1.03 volts.
4	A 1 in this bit indicates that the modulated signal is not calibrated.
5–14	Unused. These bits are always set to 0.
15	Always Zero (0).

The Data Questionable Modulation Condition Register continuously monitors the modulation status of the instrument. Condition registers are read-only. To query the condition register, send the command `STATus:QUESTionable:MODulation:CONDition?` The response will be the *decimal* sum of the bits which are set to 1.

The transition filter specifies which types of bit state changes in the condition register will set corresponding bits in the event register. The changes may be positive (from 0 to 1) or negative (from 1 to 0). Send the command

`STATUS:QUESTIONABLE:MODulation:NTRansition <num>` (negative) or  
`STATUS:QUESTIONABLE:MODulation:PTRansition <num>` (positive) where `<num>` is the sum of the decimal values of the bits you want to enable.

The Data Questionable Modulation Event Register latches transition events from the condition register as specified by the transition filters. Event registers are destructive read-only. Reading data from an event register will clear the content of that register. To query the event register, send the command

`STATUS:QUESTIONABLE:MODulation[:EVENT]?`

**Figure 1-37.**

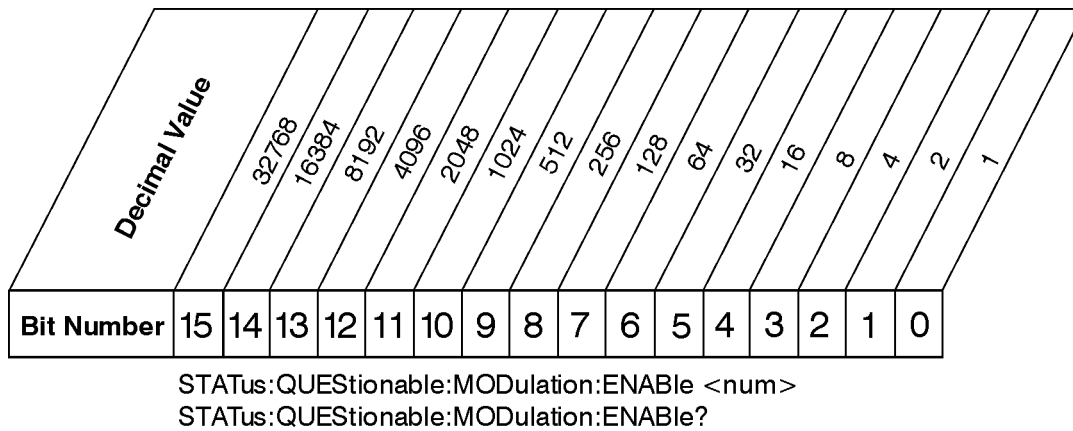

**Data Questionable Modulation Event Enable Register**

ck738a

The Data Questionable Modulation Status Group also contains a Data Questionable Modulation Event Enable Register. This register lets you choose which bits in the Data Questionable Modulation Event Register will set the summary bit (bit 7 of the Data Questionable Condition Register) to 1. Send the

`STATUS:QUESTIONABLE:MODulation:ENABLE <num>` command where `<num>` is the sum of the decimal values of the bits you want to enable. For example, to enable bit 9 and bit 3 so that whenever either of those bits is set to 1, the Data Questionable Modulation summary bit of the Data Questionable Condition Register will be set to 1, send the command

`STAT:QUES:MOD:ENAB 520` (512 + 8). The command

`STATUS:QUESTIONABLE:MODulation:ENABLE?` returns the decimal value of the sum of the bits previously enabled with the `STATUS:QUESTIONABLE:MODulation:ENABLE <num>` command.

### Data Questionable Calibration Status Group

Figure 1-38. Data Questionable Calibration Status Group

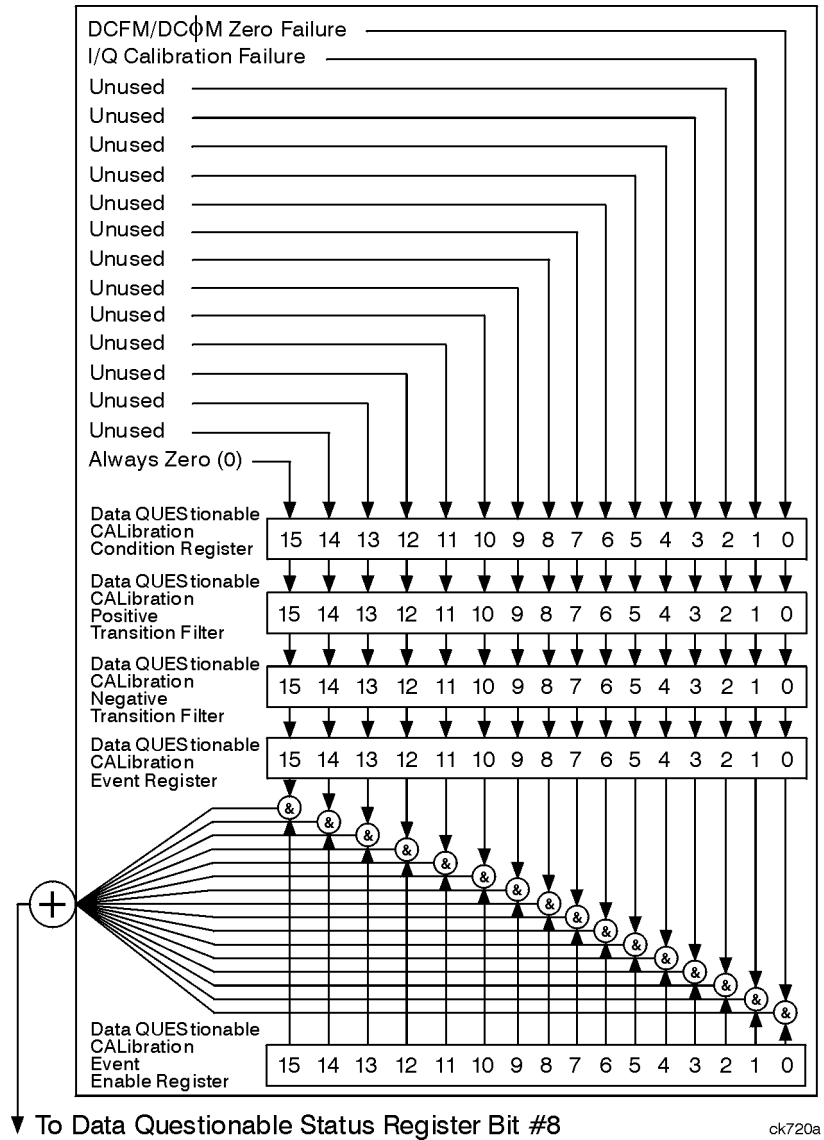

The Data Questionable Calibration Status Group is used to determine the specific event that set bit 8 in the Data Questionable Condition Register. The Data Questionable Calibration Status Group consists of the Data Questionable Calibration Condition Register, the Data Questionable Calibration Negative Transition Filter, the Data Questionable Calibration Positive Transition Filter, the Data Questionable Calibration Event Register, and the Data Questionable Calibration Event Enable Register. The Data Questionable Calibration Condition Register contains the following bits:

**Figure 1-39.**

Bit Number	15	14	13	12	11	10	9	8	7	6	5	4	3	2	1	0
Description	Always Zero (0)	Unused	Unused	Unused	Unused	Unused	Unused	Unused	Unused	Unused	Unused	Unused	Unused	Unused	I/Q Calibration Failure	DCFM/DCΦM Zero Failure

STATus:QUESTionable:CALibration:ENABLE <num>  
 STATus:QUESTionable:CALibration:ENABLE?

### Data Questionable Calibration Condition Register

ck740a

Bit	Description
0	A 1 in this bit indicates that the DCFM/DCΦM zero calibration routine has failed. This is a critical error. The output of the source has no validity until the condition of this bit is 0.
1	A 1 in this bit indicates that the I/Q calibration routine has failed. An I/Q calibration failure does not affect the validity of the source output.
2–14	Unused. These bits are always set to 0.
15	Always Zero (0).

The Data Questionable Calibration Condition Register continuously monitors the calibration status of the instrument. Condition registers are read-only. To query the condition register, send the command `STATus:QUESTionable:CALibration:CONDition?` The response will be the *decimal* sum of the bits which are set to 1.

The transition filter specifies which types of bit state changes in the condition register will set corresponding bits in the event register. The changes may be positive (from 0 to 1) or negative (from 1 to 0). Send the command

`STATus:QUESTionable:CALibration:NTRansition <num>` (negative) or  
`STATus:QUESTionable:CALibration:PTRansition <num>` (positive) where <num> is the sum of the decimal values of the bits you want to enable.



The Data Questionable Calibration Event Register latches transition events from the condition register as specified by the transition filters. Event registers are destructive read-only. Reading data from an event register will clear the content of that register. To query the event register, send the command  
`STATUS:QUESTIONable:CALibration[:EVENT]?`

**Figure 1-40.**

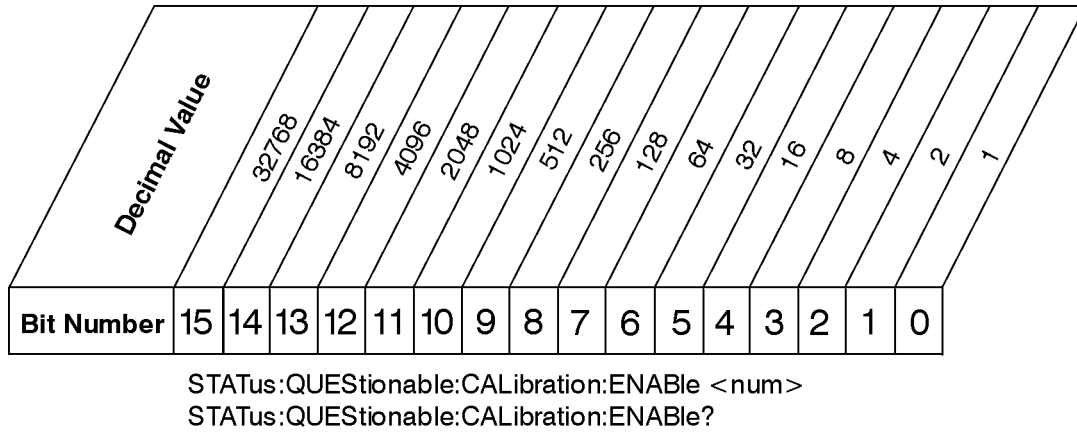

**Data Questionable Calibration Event Enable Register**

ck741a

The Data Questionable Calibration Status Group also contains a Data Questionable Calibration Event Enable Register. This register lets you choose which bits in the Data Questionable Calibration Event Register will set the summary bit (bit 8 of the Data Questionable Condition register) to 1. Send the `STATUS:QUESTIONable:CALibration:ENABLE <num>` command where `<num>` is the sum of the decimal values of the bits you want to enable. For example, to enable bit 9 and bit 3 so that whenever either of those bits is set to 1, the Data Questionable Calibration summary bit of the Data Questionable Condition Register will be set to 1, send the command `STAT:QUES:CAL:ENAB 520 (512 + 8)`. The command `STATUS:QUESTIONable:CALibration:ENABLE?` returns the decimal value of the sum of the bits previously enabled with the `STATUS:QUESTIONable:CALibration:ENABLE <num>` command.

### Data Questionable BERT Status Group

Figure 1-41. Data Questionable BERT Status Group

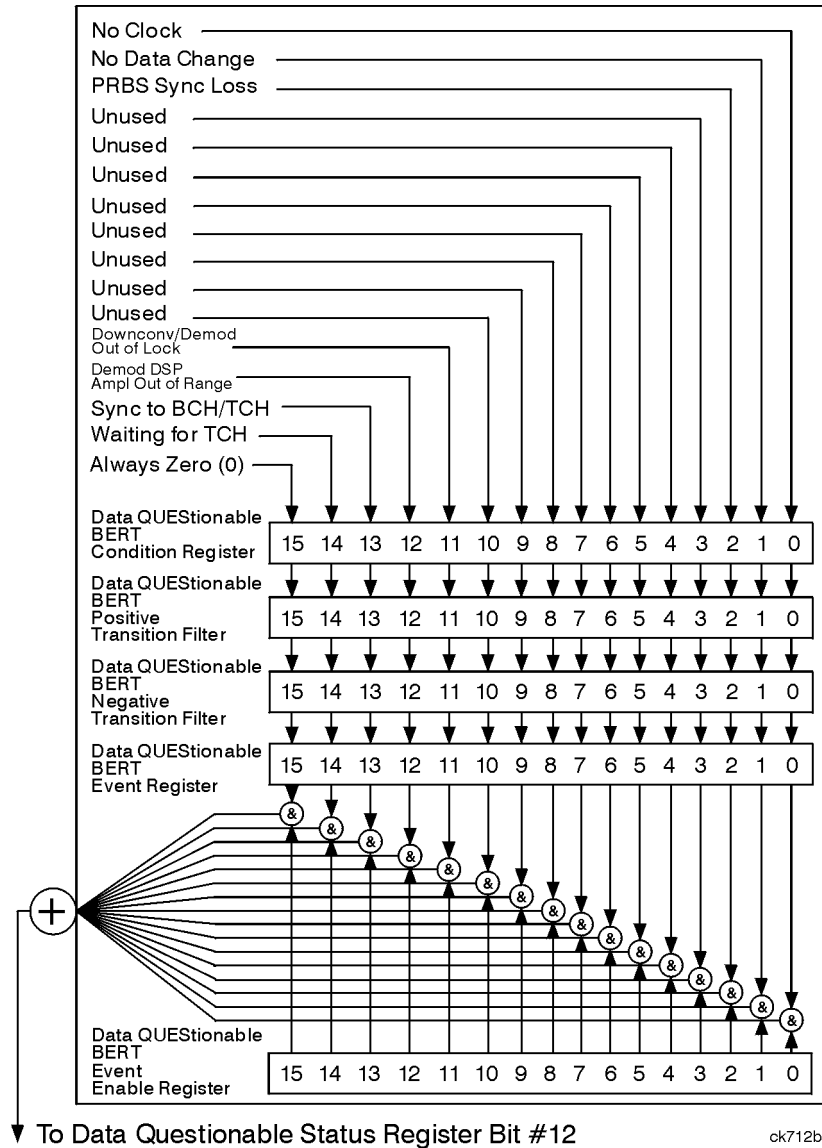

The Data Questionable BERT Status Group is used for Options UN7 and 300 only. If your signal generator is not equipped with Options UN7 or 300, all of the bits in this group are set to 0.

The Data Questionable BERT Status Group is used to determine the specific event that set bit 12 in the Data Questionable Condition Register. The Data Questionable BERT Status Group consists of the Data Questionable BERT Condition Register, the Data Questionable BERT Negative Transition Filter, the Data Questionable BERT Positive Transition Filter, the Data Questionable BERT Event Register, and the Data Questionable BERT Event Enable Register. The Data Questionable BERT Condition Register contains the following bits:

**Figure 1-42.**

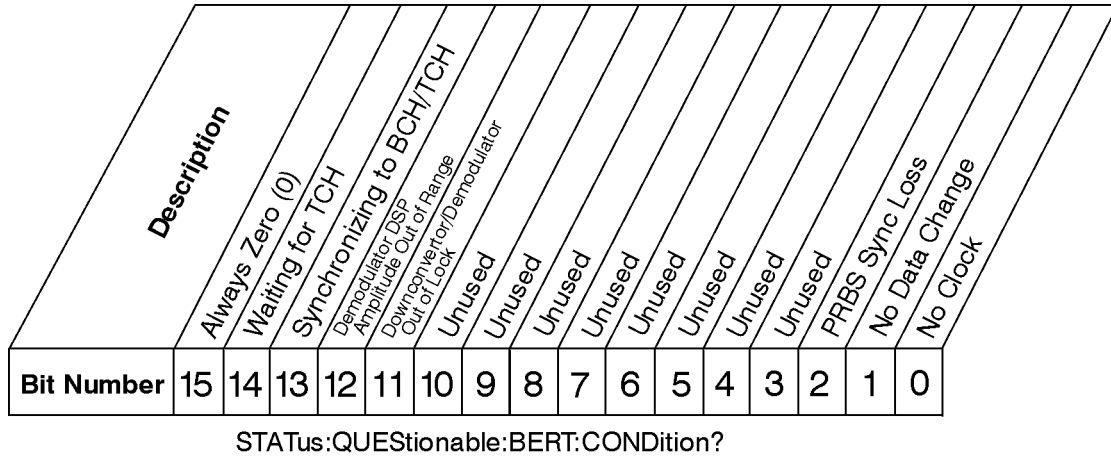

**Data Questionable BERT Condition Register**

ck713b

Bit	Description
0	A 1 in this bit indicates that a no clock signal has been input to the BER CLK IN connector for more than three seconds during a bit error rate test.
1	A 1 in this bit indicates that data signals input to the BER DATA IN connector have not changed for a period of more than 200 clock signals during a bit error rate test.
2	A 1 in this bit indicates that the synchronization of the incoming data to the BER DATA IN connector for the bit error rate test has been lost.
3–10	Unused. These bits are always set to 0.
11	A 1 in this bit indicates that either the downconverter or demodulator is out of lock.
12	A 1 in this bit indicates that the demodulator DSP amplitude is out of range.
13	A 1 in this bit indicates that BCH or TCH synchronization is not established.
14	A 1 in this bit indicates that a TCH midamble is not being received.
15	Always Zero (0).

The Data Questionable BERT Condition Register continuously monitors the bit error rate tests (BERT) status of the instrument with Options UN7 or 300. Condition registers are read-only. To query the condition register, send the command `STATUS:QUESTIONABLE:BERT:CONDITION?` The response will be the *decimal* sum of the bits which are set to 1.

The transition filter specifies which types of bit state changes in the condition register will set corresponding bits in the event register. The changes may be positive (from 0 to 1) or negative (from 1 to 0). Send the command `STATUS:QUESTIONABLE:BERT:NTRANSITION <num>` (negative) or `STATUS:QUESTIONABLE:BERT:PTRANSITION <num>` (positive) where `<num>` is the sum of the decimal values of the bits you want to enable.

The Data Questionable BERT Event Register latches transition events from the condition register as specified by the transition filters. Event registers are destructive read-only. Reading data from an event register will clear the content of that register. To query the event register, send the command `STATUS:QUESTIONABLE:BERT[:EVENT]?`

**Figure 1-43.**

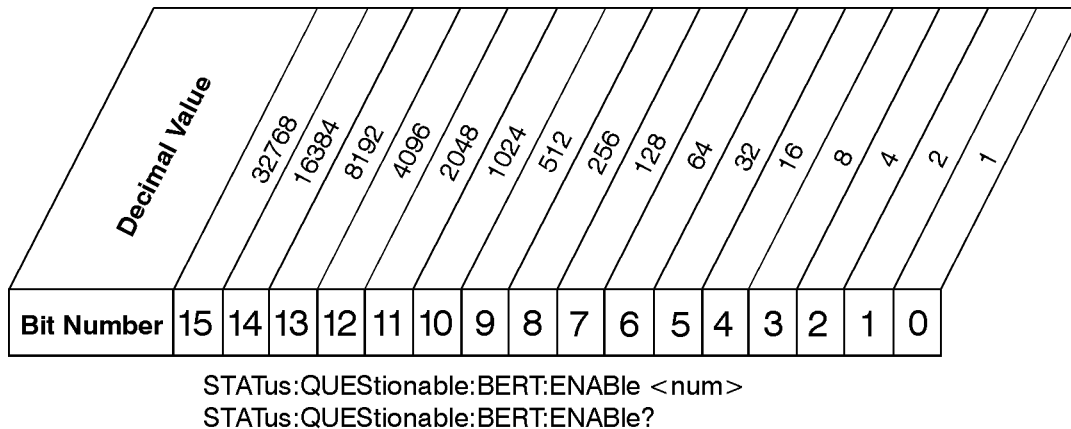

**Data Questionable BERT Event Enable Register**

ck747k

The Data Questionable BERT Status Group also contains a Data Questionable BERT Event Enable Register. This register lets you choose which bits in the Data Questionable BERT Event Register will set the summary bit (bit 8 of the Data Questionable Condition register) to 1. Send the `STATUS:QUESTIONABLE:BERT:ENABLE <num>` command where `<num>` is the sum of the decimal values of the bits you want to enable. For example, to enable bit 9 and bit 3 so whenever either of those bits is set to 1, the Data Questionable BERT summary bit of the Data Questionable Condition Register will be set to 1, send the command `STAT:QUES:CAL:ENAB 520 (512 + 8)`. The command `STATUS:QUESTIONABLE:BERT:ENABLE?` returns the decimal value of the sum of the bits previously enabled with the `STATUS:QUESTIONABLE:BERT:ENABLE <num>` command.

---

## Advanced Programming Information

This section provides advanced programming information for applications requiring special techniques.

### Sending BREAK Messages

A BREAK is a special character transmission that usually indicates a change in operating conditions. Interpretation of break messages varies with the application. To send a break message, send a non-zero value to Control Register 1 as follows (Sc is the interface select code):

```
CONTROL Sc,1;1      ! Send a Break to peripheral.
```

### Using the Modem Control Register

Control Register 5 controls various functions related to modem operation. Bits 0 through 3 control modem lines, and bit 4 enables a self-test loopback configuration.

#### Modem Handshake Lines (RTS and DTR)

The Request To Send and the Data Terminal Ready lines are set or cleared at the beginning and end of each OUTPUT or ENTER operation. In some cases, it may be advantageous or necessary to maintain either or both in an active state. This is done by setting bit 1 or 0 respectively in Control Register 5 as follows:

```
CONTROL Sc,5;2      ! Set RTS line only and hold active.
CONTROL Sc,5;1      ! Set DTR line only and hold active.
CONTROL Sc,5;3      ! Set DTR line only and hold active.
CONTROL Sc,5;0      ! Set both RTS and DTR lines active.
```

When RTS or DTR are set by Control Register 5, they are not toggled during OUTPUT or ENTER operations, but remain constantly in an active state until the CONTROL register is cleared by:

- writing a different value to CONTROL register 5.
- an interface reset to CONTROL register 0.
- an interface reset (Reset) from the keyboard (Shift Break on an ITF keyboard, or SHIFT PAUSE on a 98203 keyboard).

### **Programming the DRS Modem Line**

Bit 2 of Control Register 5 controls the present state of the Data Rate Select (DRS). When bit 2 is set, the modem line is activated. When bit 2 is cleared, the modem line is cleared. To set the DRS line, the following statement or its equivalent can be used:

```
CONTROL Sc,5;4      ! Sets the DRS line.
```

This line is also cleared by a CONTROL statement to Control Register 5 with bit 2 cleared, or by an interface reset.

## 2 Programming Commands and Examples

This chapter describes each of the SCPI commands alphabetically, by subsystem. The descriptions include syntax requirements, ranges, restrictions, and status at \*RST.

Several example programs are also provided to help you understand how the general SCPI concepts presented in [Chapter 1](#) apply to programming real measurements. Also included is information on the creation, transfer, and application of user files.

---

## Command Syntax

Following the heading for each programming command entry is a syntax statement showing the proper syntax for the command. An example syntax statement is shown here:

```
POWer[:LEVel] MAXimum|MIN
```

Syntax statements read from left to right. In this example, the `:LEVel` portion of the statement immediately follows the `POWer` portion of the statement with no separating space. A separating space is legal only between the command and its argument. In this example, the portion following the `[ :LEVel ]` portion of the statement is the argument. Additional conventions used in the syntax statements are defined as follows:

- Italics are used to symbolize a program code parameter or query response.
- `:=` means “is defined as.”
- `|` (vertical bar) indicates a choice of one element from a list. For example, `<A> | <B>` indicates `<A>` or `<B>` but not both.
- `[]` (square brackets) indicate that the enclosed items are optional.
- Upper-case lettering indicates that the upper-case portion of the command is the minimum required for the command. For example, in the command `FREQuency`, `FREQ` is the minimum requirement.
- Lower-case lettering indicates that the lower-case portion of the command is optional; it can either be included with the upper-case portion of the command or omitted. For example, in the command `FREQuency`, either `FREQ`, or `FREQUENCY` is correct.
- `?` after a subsystem command indicates that the command is a query.



---

## IEEE 488.2 Common Commands

Common commands are generally not measurement related, but are used to manage macros, status registers, synchronization, and data storage. All common commands begin with an asterisk. The common commands are defined by IEEE 488.2.

### **\*CLS (Clear Status)**

\*CLS

This command clears the status byte, the data questionable event register, the standard event status register, the standard operation status register and any other registers that are summarized in the status byte.

### **\*ESE (Standard Event Status Enable)**

\*ESE

This command sets the standard event status enable register.

\*ESE?

This queries the status of the standard event status enable register.

### **\*ESR? (Standard Event Status Register)**

\*ESR?

This queries the value of the standard event status register. This is a destructive read.

### **\*IDN? (Identification)**

\*IDN?

This query outputs an identifying string to the GPIB. The response for the signal generator will be a string that shows the actual model number, serial number and firmware revision will be substituted.

### **\*OPC (Operation Complete)**

\*OPC

This command sets bit 0 in the standard event status register when all pending operations have finished.

### **\*OPC? (Operation Complete)**

\*OPC?

This queries bit 0 in the standard event status register. The signal generator will return an ASCII '1' when all pending operations have finished.

### **\*RCL (Recall)**

\*RCL <reg>, <seq>

The \*RCL <reg>, <seq> command recalls the instrument state from the specified memory register <reg> of the specified sequence <seq>. The range of registers <reg> is 0 through 99 and the range of sequences <seq> is 0 through 9.

### **\*RST (Reset)**

\*RST

This command resets the instrument to a factory pre-defined condition.

### **\*SAV (Save)**

\*SAV <reg>, <seq>

The \*SAV <reg>, <seq> command saves the instrument state to the specified memory register <reg> of the specified sequence <seq>. The range of registers <reg> is 0 through 99 and the range of sequences <seq> is 0 through 9.

### **\*SRE (Service Request Enable)**

\*SRE

This command sets the value of the service request enable register.

### **\*SRE? (Service Request Enable Query)**

\*SRE?

This queries the value of the service request enable register.

### **\*STB? (Read Status Byte)**

\*STB?

This queries the status byte. This is a non-destructive read.

**\*TRG (Trigger)**

\*TRG

This command triggers the device if, and only if, Bus Triggering is the type of trigger event selected. Otherwise, \*TRG is ignored.

**\*TST? (Self-Test)**

\*TST?

This query returns the result of the power-up selftest:

- 0 - Passed (no tests failed and at least one test passed)
- 1 - Failed (one or more tests failed)

**\*WAI (Wait-to-continue)**

\*WAI

This command causes the instrument to wait until all pending commands are completed, before executing any other commands.

---

## Subsystem Commands

Subsystem commands include all measurement functions and some general purpose functions. Subsystem commands are distinguished by the colon used between keywords, as in AM:SOURce. Each subsystem is a set of commands that roughly corresponds to a functional block of the instrument.

---

## :AM Subsystem

The amplitude modulation subsystem is used to set the modulation controls and the parameters associated with amplitude modulated signals.

### Amplitude Modulation Source

```
:AM[1] | 2:SOURCE INT[1] | EXT1 | EXT2
:AM[1] | 2:SOURCE?
```

This command sets the source that will generate the amplitude modulation. The choices are Internal Source 1, External Source 1, or External Source 2. You can choose internally-generated amplitude modulation or select an externally-applied signal from either the EXT 1 INPUT or EXT 2 INPUT connectors. The internal modulation is always AC-coupled. For the externally-applied signals, you can choose between AC- and DC-coupled modulation. A 1.0 V<sub>pk</sub> input is required for calibrated AM depth settings. The EXT 1 LO/HI and EXT 2 LO/HI display annunciators will turn on if the peak input voltage differs from 1.0 V<sub>pk</sub> by more than 3%. (The LO/HI annunciators only function for AC-coupled external inputs.)

The internal and external 1 and 2 sources have multiple uses. You can use them for amplitude, frequency, and phase modulation. For burst modulation, you can only use the external 1 source and you must use the external 2 source for pulse modulation. However, any given source can only be routed to one enabled modulation at a time. If, for example, you were using the external 1 source in a frequency modulation configuration for **FM Path 1**, and then you configured **AM Path 2** to also use the external 1 source, the signal generator would turn off **FM Path 1** and assign the external 1 source to your **AM Path 2** configuration. Notice that for these purposes the external 1 AC-coupled source is the same as the external 1 DC-coupled source and the external 2 AC-coupled source is the same as the external 2 DC-coupled source.

\*RST Value: Internal

### Amplitude Modulation State

```
:AM[1] | 2:STATE ON|OFF|1|0
:AM[1] | 2:STATE?
```

This command toggles the amplitude modulation on or off for whichever AM path configuration (**AM Path 1** or **AM Path 2**) you have selected. The choices are On (1) or Off (0). Notice, however that although you can turn on amplitude modulation with this command, the RF carrier is modulated by the enabled modulation only when you have also set **Mod On/Off** to **On**. Whenever amplitude modulation is enabled, the AM annunciator is turned on in the display.

There are two paths for AM modulation which can be simultaneously enabled as long as they use different sources (Int, Ext1, or Ext2). **AM Path 2** is limited to a maximum rate of 1 MHz. **AM Path 2** must be set to a deviation less than or equal to **AM Path 1**. The modulation signals from both paths are summed internally for composite modulation.

\*RST Value: Off

## Amplitude Modulation Depth

```
:AM[1] | 2[:DEPTH] <val><unit>  
:AM[1] | 2[:DEPTH]?
```

This command sets the depth of amplitude modulation.

This command is used to set the amplitude modulation depth, in percent, for the **AM Path 1** and **AM Path 2** configurations. The choices for the variables <val> and <unit> may range from 0.1 PCT to 100 PCT. After executing the command, the current value for AM depth is displayed in the active entry area. The minimum increment allowed is 0.1%. Notice that the new value of AM depth applies only to whichever AM path configuration (**AM Path 1** or **AM Path 2**) you have currently selected.

\*RST Value: 0.1%

## Amplitude Modulation Depth Coupling

```
:AM[1] | 2[:DEPTH]:TRACK ON|OFF|1|0  
:AM[1] | 2[:DEPTH]:TRACK?
```

This command links the AM depth values of **AM Path 1** and **AM Path 2** and allows the amplitude modulation depth values on both path 1 and path 2 to track each other. If the AM depth coupling function is activated, changing the AM depth on path 1 will cause an equal change in AM depth on path 2, and visa versa. The choices are On (1) or Off (0).

\*RST Value: Off

## External Amplitude Modulation Source Coupling

```
:AM[1] | 2:EXTERNAL[1] | 2:COUPLing AC|DC  
:AM[1] | 2:EXTERNAL[1] | 2:COUPLing?
```

This command sets the external coupling for the amplitude modulation source, if External was selected as the AM[1] | 2:SOURCe. The choices are AC or DC coupling. This command does not change the currently active source, nor does it switch the current modulation on or off. The modulating signal may be the sum of several signals, either internal or external sources. If the coupling is set to DC, then both the AC and DC signal components pass. AC coupling passes only AC signal components.

The command :AM[1] | 2:EXTERNAL[1] | 2:COUPLing AC lets you input an external, AC-coupled, amplitude modulation signal to the EXT 1 INPUT connector. The modulation signal is tested for voltage and a display annunciator will report a high or low condition if the voltage is  $> \pm 3\%$  of 1 Vpk.

The command :AM[1] | 2:EXTERNAL[1] | 2:COUPLing DC lets you input an external, DC-coupled, amplitude modulation signal to the EXT 1 INPUT connector.

The external 1 source has multiple uses but can be used for only one modulation at a time. If, for example, you were using the external 1 source in a frequency modulation configuration for **FM Path 1**, and then you configured **AM Path 2** to also use the external 1

source, the signal generator would turn off **FM Path 1** and assign the external 1 source to your **AM Path 2** configuration.

\*RST Value: DC

## Internal Amplitude Modulation Alternate Frequency

```
:AM[1] | 2: INTernal[1]: FREQuency: ALTernate <val><unit>
:AM[1] | 2: INTernal: FREQuency: ALTernate?
```

This command sets the frequency for the alternate signal. The alternate frequency is the second frequency of a dual-sine or the stop frequency of a swept-sine. The choices for the variables <val> and <unit> range from 0.1 kHz (minimum) to 50.0 kHz (maximum).

\*RST Value: 400.00 Hz

## Internal Amplitude Modulation Alternate Frequency Amplitude

```
:AM[1] | 2: INTernal[1]: FREQuency: ALTernate: AMPLitude: PERCent <val><unit>
:AM[1] | 2: INTernal: FREQuency: ALTernate: AMPLitude: PERCent?
```

This command sets the amplitude of the alternate frequency as a percentage of the total amplitude. Therefore, if the alternate frequency makes up 30% of the total amplitude, then the primary frequency is 70% of the total amplitude (for dual-sine only). The choices for the variables <val> and <unit> range from 0.1% (minimum) to 99.9% (maximum).

\*RST Value: 50%

## Internal Amplitude Modulation Source Rate

```
:AM[1] | 2: INTernal[1]: FREQuency <val><unit>
:AM[1] | 2: INTernal: FREQuency?
```

This command sets the rate of the internally-generated modulation source. The choices for the variables <val> and <unit> range from 0.1 Hz (minimum) to 50 kHz (maximum) if the internal waveform is Sine wave. For all other waveforms, the maximum internal amplitude modulation rate is 10 kHz.

Use this command to change the internal modulation frequency for the **AM Path 1** and **AM Path 2** configurations. The minimum increment allowed is 0.1 Hz. Notice that the new value of AM rate applies only to whichever AM configuration (**AM Path 1** or **AM Path 2**) you have currently selected.

\*RST Value: 400.0 Hz

## Internal Amplitude Modulation Sweep Time

```
:AM[1] | 2: INTernal[1]: SWEep: TIME <val><unit>
:AM[1] | 2: INTernal: SWEep: TIME?
```

This command selects the sweep time for a swept-sine, internally-generated signal.

\*RST Value: 100 msec

## Internal Amplitude Modulation Sweep Trigger

```
:AM[1] | 2:INTernal[1]:SWEep:TRIGger IMMEDIATE | BUS | EXTERNAL | KEY  
:AM[1] | 2:INTernal:SWEep:TRIGger?
```

This command selects the trigger for the amplitude modulation sweep.

\*RST Value: Immediate

## Internal Amplitude Modulation Waveform

```
:AM[1] | 2:INTernal[1]:FUNction:SHAPE SINE | TRIangle | SQUARE | RAMP | NOISE |  
DUALsine | SWEptsine  
:AM[1] | 2:INTernal:FUNction:SHAPE?
```

This command allows you to assign an AM waveform to your **AM Path 1** and **AM Path 2** configurations. Select from sine, triangle, square, ramp, noise, dual sine, and swept sine waveforms. Notice that your waveform selection applies only to whichever AM path configuration you have currently selected.

Using the command `:AM[1] | 2:INTernal[1]:FUNction:SHAPE SINE` lets you specify sine as the amplitude modulation waveform for the **AM Path 1** and **AM Path 2** configurations. Notice that the selected waveform applies only to whichever AM path configuration you have currently selected.

Using the command `:AM[1] | 2:INTernal[1]:FUNction:SHAPE TRIangle` lets you specify triangle as the amplitude modulation waveform for the **AM Path 1** and **AM Path 2** configurations. Notice that the selected waveform applies only to whichever AM path configuration you have currently selected.

Using the command `:AM[1] | 2:INTernal[1]:FUNction:SHAPE SQUARE` lets you specify square as the amplitude modulation waveform for the **AM Path 1** and **AM Path 2** configurations. Notice that the selected waveform applies only to whichever AM path configuration you have currently selected.

Using the command `:AM[1] | 2:INTernal[1]:FUNction:SHAPE RAMP` lets you specify ramp as the amplitude modulation waveform for the **AM Path 1** and **AM Path 2** configurations. Notice that the selected waveform applies only to whichever AM path configuration you have currently selected.

Using the command `:AM[1] | 2:INTernal[1]:FUNction:SHAPE NOISE` lets you specify noise as the amplitude modulation waveform for the **AM Path 1** and **AM Path 2** configurations. Notice that the selected waveform applies only to whichever AM path configuration you have currently selected.

Using the command `:AM[1] | 2:INTernal[1]:FUNction:SHAPE DUALsine` allows you to set the dual sine as the amplitude modulation waveform for the **AM Path 1** and **AM Path 2** configurations. In this mode you can set the AM rates for two separate tones. In addition, you can set a percentage of the tone 2 AM depth to the total AM depth.



Using the command `:AM[1] | 2:INTernal[1]:FUNcTion:SHAPE SWEPTsine` allows you to set the swept-sine amplitude modulation waveform for the **AM Path 1** and **AM Path 2** configurations. In this mode you can set the start and stop AM rate and the sweep time. You can set the signal generator to a single, externally-triggered sweep on either a negative or positive TTL level or you can choose continuous sweep, triggered immediately. In this menu you can also select either a positive or negative polarity for the TRIGGER OUT signal.

\*RST Value: Sine

## Wideband Amplitude Modulation State

```
:AM:WIDeband:STATe ON|OFF|1|0  
:AM:WIDeband:STATe?
```

This command sets the operating state of the wideband amplitude modulation source. The choices are On (1) or Off (0). AM wideband (ESG-D and ESG-DP Series) provides bandwidth beyond the standard AM with fixed depth (100%). The modulation source is the I input.

**AM Path 1** and **AM Path 2** are summed internally for composite modulation. Either path can be switched to any one of the modulation sources: Int, Ext1, or Ext2. All modulation types can be simultaneously enabled, except FM with  $\Phi$ M, AM with burst envelope, and wideband AM with I/Q. AM, FM, and  $\Phi$ M can sum simultaneous inputs from any two sources (Int, Ext1, and Ext2). Any given source (Int, Ext1, or Ext2) can only be routed to one activated modulation type.

The wideband AM selection (**AM Path WB**) eliminates the bandwidth limitations of the ALC loop thereby increasing the bandwidth beyond that of the standard amplitude modulation. Typical rates for wideband AM are listed in the technical specifications document. When you select **AM Path WB** in the AM menu, you must apply your modulating signal to the I input. The sensitivity is 0.5 V = 100% AM depth. With **AM Path WB** selected, the modulated RF signal will be available at the RF OUTPUT connector when you turn on both **Mod On/Off** and **RF On/Off**.

\*RST Value: Off

---

## :CALibration Subsystem

The calibration subsystem is used to set the controls and the parameters associated with instrument calibration.

### DCFM/DC $\Phi$ M Calibration

:CALibration:DCFM

There is no query for this command.

This command initiates a DCFM or DC $\Phi$ M calibration (depending on which kind of modulation is currently active) and stores the results in the instrument's firmware. This calibration eliminates the offset in phase (or frequency, as appropriate) modulation so that the carrier phase (or frequency) remains the same with no modulation applied. An external DC-coupled phase (or frequency) modulation must be active when the calibration is performed. After calibration, the DC signal produces no modulation.

There are no initial values associated with this command.

### Default I/Q Calibration

:CALibration:IQ:DEFault

The is no query for this command.

This command will restore the original factory calibration data for the internal I/Q modulator. The latest calibration data from the user calibration is discarded. Although the factory calibration data may not be optimized for the signal generator's present status, the data can be used as a starting point if the current data is lost (if the I/Q calibration is unable to execute).

There are no initial values associated with this command.

### Full I/Q Calibration

:CALibration:IQ:FULL

There is no query for this command.

This command sets and performs a full-frequency range (regardless of the start and stop frequency settings) I/Q calibration and stores the results in the instrument's firmware.

There are no initial values associated with this command.

## I/Q Calibration

:CALibration:IQ

There is no query for this command.

This command sets and performs an I/Q calibration and stores the results in the instrument's firmware.

There are no initial values associated with this command.

## I/Q Calibration Start Frequency

:CALibration:IQ:START <val><units>

:CALibration:IQ:START?

This command sets the start frequency for an I/Q calibration. The choices for the variables <val> and <units> range between 250 kHz and the highest specified operating frequency of your source.

I/Q Calibration Start Frequency is a persistent state; it is not affected by an instrument preset or a power cycle. The ESG is initially shipped from the factory with this parameter set to 100 kHz.

## I/Q Calibration Stop Frequency

:CALibration:IQ:STOP <val><units>

:CALibration:IQ:STOP?

This command sets the stop frequency used for an I/Q calibration. The choices for the variables <val> and <units> range between 250 kHz and the highest specified operating frequency of your source.

I/Q Calibration Stop Frequency is a persistent state; it is not affected by an instrument preset or a power cycle. The ESG is initially shipped from the factory with this parameter set to the maximum specified frequency.

---

## :COMMunicate Subsystem

The communicate subsystem is used to set the controls and the parameters associated with serial system communication.

### GPIB Address

```
:SYSTem:COMMunicate:GPIB:ADDRESS <number>  
:SYSTem:COMMunicate:GPIB:ADDRESS?
```

This command sets the source's GPIB address. The choices for the variable <number> are integers 0 through 30.

This is a persistent state set to 19 at the factory.

### RS-232 Baud Rate

```
:SYSTem:COMMunicate:SERial:BAUD <number>  
:SYSTem:COMMunicate:SERial:BAUD?
```

This command sets the baud rate for the rear panel RS-232 interface (labeled AUXILIARY INTERFACE). The baud rate must be set to 19200 if an optional remote interface box is connected. The choices for the variable are 300, 1200, 2400, 4800, 9600, 19200, 38400.

This is a persistent state set to 19200 at the factory.

### RS-232 Reset

```
:SYSTem:COMMunicate:SERial:RESet  
There is no query for this command.
```

This command resets the RS-232 buffer. This will discard any unprocessed SCPI input received via the RS-232 port.

There are no initial values associated with this command.

### RS-232 RTS Control

```
:SYSTem:COMMunicate:SERial:CONTRol:RTS ON|OFF|IBFull|RFR  
:SYSTem:COMMunicate:SERial:CONTRol:RTS?
```

This command controls the state of the RS-232 RTS line. The choices are ON, OFF, RFR, and IBFull.

Use ON for connecting the optional remote interface box. The instrument ignores the state of the CTS line.

Use OFF for a three-wire remote connection. With this setting, the instrument ignores the state of the CTS line. This setting is not compatible with the optional remote interface box.

Use IBFull or its alias RFR to turn on handshaking. Do not use these settings without a properly configured remote connection that uses hardware handshaking.

- With IBFull or RFR, when the receive buffer of the instrument is near overflow, the RTS line is turned off.
- With RFR or IBFull, the instrument monitors the state of the CTS line, and if it goes false discontinues transmitting over RS-232. This setting is not compatible with the optional remote interface box.

This is a persistent state set to ON at the factory.

### RS-232 RTS Echo

```
:SYSTem:COMMunicate:SERial:ECHO ON|OFF|1|0
:SYSTem:COMMunicate:SERial:ECHO?
```

This command controls the state of the RS-232 echo. The choices are On (1) of Off (0).

This is a persistent state set to Off at the factory.

### RS-232 Timeout

```
:SYSTem:COMMunicate:SERial:TOUT <val>
:SYSTem:COMMunicate:SERial:TOUT?
```

This command sets the value for the RS-232 serial port timeout. If further input is not received within the assigned timeout period while a SCPI command is being processed, then the command is aborted and the input buffer is cleared.

This is a persistent state set to 60 seconds at the factory.

### RS-232 XON Handshake Receive State

```
:SYSTem:COMMunicate:SERial:RECeive:PACE XON|NONE
:SYSTem:COMMunicate:SERial:RECeive:PACE?
```

This command sets XON/XOFF handshaking when the instrument is receiving data. The choices are XON and None.

This is a persistent state, set to None at the factory.

### RS-232 XON Handshake Transmit State

```
:SYSTem:COMMunicate:SERial:TRANsmit:PACE XON|NONE
:SYSTem:COMMunicate:SERial:TRANsmit:PACE?
```

This command sets XON/XOFF handshaking when the instrument is transmitting data. The choices are XON and None.

This is a persistent state, set to None at the factory.

---

## :DIAGnostic Subsystem

The diagnostic subsystem is used to set the controls and the parameters associated with instrument operational and tracking data.

### Attenuator Cycle Information

```
:DIAGnostic[:CPU]:INFORMATION:CCOUNT:ATTENUATOR?
```

This query returns the number of times that the attenuator has been switched.

### Display Time-On Information

```
:DIAGnostic[:CPU]:INFORMATION:DISPLAY:OTIME?
```

This query returns the number of hours that the source's display has been activated.

### Power Cycle Information

```
:DIAGnostic[:CPU]:INFORMATION:CCOUNT:PON?
```

This query returns the number of times that the sources line power has been cycled.

### Reverse Power Protection Trips Information

```
:DIAGnostic[:CPU]:INFORMATION:CCOUNT:PROTECTION?
```

This query returns the number of times that the reverse power protection circuitry has been activated.

### Option Information

```
:DIAGnostic[:CPU]:INFORMATION:OPTIONS?
```

This query returns a list of installed instrument options. For instance: UN8, UN7, 300.

### Detailed Option Information

```
:DIAGnostic[:CPU]:INFORMATION:OPTIONS:DETAIL?
```

This query returns information on the installed instrument options.

### Installed Board Information

```
:DIAGnostic[:CPU]:INFORMATION:BOARDS?
```

This query returns a list of the installed boards in the instrument, including the board name, part number, serial number, version number and status.

## Instrument Firmware Information

```
:DIAGnostic:INFORMATION:SDATE?
```

This query returns the instrument's firmware revision date.

## Instrument Time-On Information

```
:DIAGnostic[:CPU]:INFORMATION:OTIME?
```

This query returns the number of hours that the source has had its line power activated.

---

## :DISPlay Subsystem

The display subsystem is used to set the controls and the parameters associated with the signal source's LCD display.

### Display Amplitude Units

```
:DISPlay:ANNotation:AMPLitude:UNIT DBM|DBUV|DBUVEMF|V|VEMF
:DISPlay:ANNotation:AMPLitude:UNIT?
```

This command sets amplitude units of the signal generator front panel display.

\*RST DBM

### Display Brightness Configuration

```
:DISPlay:BRIGhtness <val>
:DISPlay:BRIGhtness?
```

This command sets the brightness of the instrument's LCD display. Choices for the variable <val> range from 0.02 (dimpest) to 1.0 (brightest).

This is a persistent state, set to 1 at the factory.

### Display Contrast Configuration

```
:DISPlay:CONTRast <val>
:DISPlay:CONTRast?
```

This command sets the contrast of the instrument's LCD display. Choices for the variable <val> range from 0.0 to 1.0.

This is a persistent state set to 0.768 at the factory.

### Display Inverse Video Configuration

```
:DISPlay:INVerse ON|OFF|1|0
:DISPlay:INVerse?
```

This command sets the source's display to inverse video mode. Choices are On (1) or Off (0).

This is a persistent state set to Off at the factory.

### Display Remote Configuration

```
:DISPlay:REMote ON|OFF|1|0
:DISPlay:REMote?
```

This command sets the source's display updating off or on, when the remote control bus is in remote.

This is a persistent state in the preset mode. However, it resets to off, the default value, when the power is cycled.



## :DM and :BURSt Subsystems (ESG-D and ESG-DP Series)

These digital modulation subsystems are used to set the I/Q modulation controls and the I/Q parameters associated with I/Q modulated signals.

### Burst Envelope State

```
:BURSt:STATe ON|OFF|1|0
:BURSt:STATe?
```

This command enables/disables the burst envelope. The choices are On (1) or Off (0).

\*RST Value: Off

### Burst Source

```
:BURSt:SOURce EXTernal[1]|INTernal[1]
:BURSt:SOURce?
```

Use this command to select either an internally-generated or an externally-supplied burst source. For an externally-supplied burst source, apply the in-phase and quadrature-phase signals to the I INPUT and Q INPUT connectors. The signal level is  $\sqrt{I^2+Q^2} = 0.5 V_{\text{rms}}$ .

\*RST Value: External

### Digital Modulation Source

```
:DM:SOURce EXTernal|INTernal[1]
:DM:SOURce?
```

Use this command to change the I/Q source to externally supplied I and Q signals. Apply the in-phase and quadrature-phase signals to the I INPUT and Q INPUT connectors. The signal level is  $\sqrt{I^2+Q^2} = 0.5 V_{\text{rms}}$ . If you do not have Option UN8, this is the only I/Q source and it cannot be changed. If you have Option UN8, the I/Q source can also be set to an internal I/Q source.

\*RST Value: External

### Digital Modulation Mode State

```
:DM:STATe ON|OFF|1|0
:DM:STATe?
```

This command enables/disables the I/Q modulation. The choices are On (1) or Off (0). Notice, however, that although you can enable I/Q modulation with this command, the RF carrier is modulated only when you have the modulation activated. Whenever I/Q modulation is enabled, the I/Q annunciator is turned on in the display.

\*RST Value: Off

## External ALC Bandwidth Configuration

```
:DM:EXtErnal:ALC:BWIDth|BANDwidth NORMal|NARRow  
:DM:EXtErnal:ALC:BWIDth|BANDwidth?
```

This command is used to toggle between ALC normal and narrow bandwidth modes. The choices are Normal or Narrow. You can choose to set the signal generator to narrow bandwidth mode if you have switched on I/Q modulation, are using an external I/Q source, and the ALC circuit is set to on. Setting the external ALC bandwidth to narrow limits the bandwidth to 100 Hz, which can improve EVM. Narrow bandwidth mode may, however, also slow the settling time for frequency changes as much as 40 ms. Defaults are Normal if IQ modulation is off, Narrow if EXT IQ or HIGH BW AM is on.

\*RST Value: Normal

## High Crest Mode State

```
:DM:EXtErnal:HICrest[:STATe] ON|OFF|1|0  
:DM:EXtErnal:HICrest[:STATe]?
```

This command is used to change operating conditions to accommodate IQ inputs with high crest factor. Maximum output level is reduced and power level accuracy is degraded. IQ drive levels should be reduced, dB per dB, for crest factors greater than 4 dB.

\*RST Value: Off

## I Channel Offset Adjustment

```
:DM:IQADjustment:IOFFset <val><unit>  
:DM:IQADjustment:IOFFset?
```

This command is used to set the I channel offset, in percent of full scale. 100% offset is equivalent to 500 mV at the input connector. Choices for the variables <val> and <unit> range from -100.0 to +100.0%.

When using this command to minimize the LO feedthrough signal, optimum performance is achieved when the command is sent after all other I/Q path commands are executed, such as those that change the internal phase polarity or adjust the modulator attenuator. If other adjustments are made after minimizing is performed, the LO feedthrough signal may increase.

\*RST Value: 0.00%

## I/Q Adjustments State

```
:DM:IQADjustment[:STATe] ON|OFF|1|0  
:DM:IQADjustment[:STATe]?
```

This command is used to enable the I/Q adjustments (I/Q gain, I offset, and Q offset). The choices include On (1) or Off (0).

\*RST Value: Off

## I/Q Gain Ratio Adjustment

```
:DM:IQADjustment:GAIN <val><unit>
:DM:IQADjustment:GAIN?
```

This command is used to set the I/Q gain ratio in dB, by which I gain exceeds Q gain. Choices for the variables <val> and <unit> range from -4.0 to +4.0 dB.

\*RST Value: 0.00 dB

## I/Q Modulation Phase Polarity

```
:DM:POLarity[:ALL] NORMal|INVerted
:DM:POLarity[:ALL]?
```

This command sets the polarity of the I/Q modulation signal. The choices are Normal or Inverted. In the inverted mode the input applied to the I INPUT connector is physically routed to the Q input port of the internal I/Q modulator. In addition, the input applied to the Q INPUT connector is physically routed to the I input port of the internal I/Q modulator. This inverts the direction of phase rotation of the I/Q modulation. If you have enabled a digital modulation mode (Option UN8 only), I/Q phase polarity will be automatically set to normal. You can override this setting with this command.

\*RST Value: Normal

## Q Channel Offset Adjustment

```
:DM:IQADjustment:QOFFset <val><unit>
:DM:IQADjustment:QOFFset?
```

This command is used to set the Q channel offset, in percent of full scale. 100% offset is equivalent to 500 mV at the input connector. Choices for the variables <val> and <unit> range from -100.0 to +100.0%.

\*RST Value: 0.00%

## Quadrature Skew Adjustment

```
:DM:IQADjustment:QSKew <val><unit>
:DM:IQADjustment:QSKew?
```

This command is used to adjust the phase angle between the I and Q vectors. When the quadrature skew is zero, the phase angle is 90 degrees. Positive skew increases the angle from 90 degrees while negative skew decreases the angle from 90 degrees. The range of values allowed is 10 degrees with a minimum increment of 0.1 degrees. However, if you're operating the signal generator in the 3.3 to 4 GHz frequency range, quadrature skew settings greater than  $\pm 5$  degrees will not be within specifications.

\*RST Value: 0.0 degrees

## :FM Subsystem

The frequency modulation subsystem is used to set the modulation controls and the parameters associated with frequency modulated signals.

### External Frequency Modulation Source Coupling

```
:FM[1]|2:EXTErnal[1]|2:COUPling AC|DC
:FM[1]|2:EXTErnal[1]|2:COUPling?
```

This command sets the external coupling for the frequency modulation source. The choices are AC or DC coupling. This command does not change the currently active source, nor does it switch the current modulation on or off. The modulating signal may be the sum of several signals, either internal or external sources. If the coupling is set to DC, then both the AC and DC signal components pass. AC coupling passes only AC signal components.

The external 1 source has multiple uses but can be used for only one modulation at a time. If, for example, you were using the external 1 source in an amplitude modulation configuration for **AM Path 1**, and then you configured **FM Path 2** to also use the external 1 source, the signal generator would turn off **AM Path 1** and assign the external 1 source to your **FM Path 2** configuration. Notice that for these purposes, the external 1 AC-coupled source is the same as the external 1 DC-coupled source.

\*RST Value: DC

### Frequency Modulation Deviation

```
:FM[1]|2[:DEViation] <val><unit>
:FM[1]|2[:DEViation]?
```

Use this command to set the frequency modulation deviation for the **FM Path 1** and **FM Path 2** configurations. The current value for FM deviation is displayed in the active entry area. The range of values allowed depends on the carrier frequency. For the ESG-A and ESG-D Series, the maximum peak deviation for a frequency is calculated by multiplying N by 10 MHz. For the ESG-AP and ESG-DP Series, N is multiplied by 1 MHz. (The following table lists the values for N and the resulting maximum peak deviations.)

Carrier Frequency	N	Maximum Peak Deviation (ESG-A & ESG-D)	Maximum Peak Deviation (ESG-AP & ESG-DP)
250 kHz to ≤ 249.999 MHz	1	10 MHz	1 MHz
> 249.999 MHz to ≤ 500 MHz	0.5	5 MHz	0.5 MHz
> 500 MHz to ≤ 1 GHz	1	10 MHz	1 MHz
> 1 GHz to ≤ 2 GHz	2	20 MHz	2 MHz
> 2 GHz to 4 GHz	4	40 MHz	4 MHz

For example, if you choose a carrier frequency of 400 MHz, multiply 0.5 times 10 MHz. This results in a 5 MHz maximum peak deviation.

Notice that the new value of FM deviation applies only to whichever FM path configuration you have currently selected. Also, whenever **FM Path 1** is used with **FM Path 2**, the deviation for **FM Path 1** must be greater than or equal to the deviation for **FM Path 2**.

\*RST Value: 1.0 kHz

## Frequency Modulation Deviation Coupling

```
:FM[1]|2[:DEVIation]:TRACk ON|OFF|1|0
:FM[1]|2[:DEVIation]:TRACk?
```

This command toggles the FM deviation coupling on and off. Turning on FM deviation coupling links the FM deviation values of **FM Path 1** and **FM Path 2**. When the values are coupled, any change you make to one FM deviation value is applied to both FM deviation values.

\*RST Value: Off

## Frequency Modulation Source

```
:FM[1]|2:SOURce INT[1]|EXT1|EXT2
:FM[1]|2:SOURce?
```

This command sets the source that will generate the frequency modulation. The choices are Internal Source 1, External Source 1, or External Source 2.

You can choose internally-generated frequency modulation or select an externally-applied signal from either the EXT 1 INPUT or EXT 2 INPUT connectors. The internal modulation is always AC-coupled. For the externally-applied signals, you can choose between AC- and DC-coupled modulation. A 1.0 Vpk input is required for calibrated FM deviation settings. The EXT 1 LO/HI and EXT 2 LO/HI display annunciators will turn on if the peak input voltage differs from 1.0 Vpk by more than 3%. (The LO/HI annunciators only function for AC-coupled external inputs.)

The internal and external 1 and 2 sources have multiple uses. You can use them for amplitude, frequency, and phase modulation. For burst modulation, you can only use the external 1 source and you must use the external 2 source for pulse modulation. However, any given source can only be routed to one enabled modulation at a time. If, for example, you were using the external 1 source in a frequency modulation configuration for **FM Path 1**, and then you configured **AM Path 2** to also use the external 1 source, the signal generator would turn off **FM Path 1** and assign the external 1 source to your **AM Path 2** configuration. Notice that for these purposes the external 1 AC-coupled source is the same as the external 1 DC-coupled source and the external 2 AC-coupled source is the same as the external 2 DC-coupled source.

\*RST Value: Internal

## Frequency Modulation State

```
:FM[1] | 2:STATE ON|OFF|1|0  
:FM[1] | 2:STATE?
```

This command toggles the frequency modulation on or off for whichever FM path configuration (**FM Path 1** or **FM Path 2**) you have selected. The choices are On (1) or Off (0). Notice, however that although you can turn on frequency modulation with this command, the RF carrier is modulated by the enabled modulation only when you have also set **Mod On/Off** to **On**. Whenever frequency modulation is enabled, the FM annunciator is turned on in the display.

There are two paths for FM modulation which can be simultaneously enabled as long as they use different paths sources (Int, Ext1, or Ext2). **FM Path 2** is limited to a maximum rate of 1 MHz. **FM Path 2** must be set to a deviation less than or equal to **FM Path 1**. The modulation signals from both paths are summed internally for composite modulation.

\*RST Value: Off

## Internal Frequency Modulation Alternate Frequency

```
:FM[1] | 2:INTernal[1]:FREQuency:ALTErnate <val><unit>  
:FM[1] | 2:INTernal:FREQuency:ALTErnate?
```

This command sets the frequency for the alternate signal. The alternate frequency is the second frequency of a dual-sine or the stop frequency of a swept-sine. The choices for the variables <val> and <unit> range from 0.1 kHz (minimum) to 50.0 kHz (maximum).

\*RST Value: 400.00 Hz

## Internal Frequency Modulation Alternate Frequency Amplitude

```
:FM[1] | 2:INTernal[1]:FREQuency:ALTErnate:AMPLitude:PERCent <val><unit>  
:FM[1] | 2:INTernal:FREQuency:ALTErnate:AMPLitude:PERCent?
```

This command sets the amplitude of the alternate frequency as a percentage of the total amplitude. Therefore, if the alternate frequency makes up 30% of the total amplitude, then the primary frequency is 70% of the total amplitude (for dual-sine only). The choices for the variables <val> and <unit> range from 0.1% (minimum) to 99.9% (maximum).

\*RST Value: 50%

## Internal Frequency Modulation Source Rate

```
:FM[1] | 2:INTernal[1]:FREQuency <val><unit>
:FM[1] | 2:INTernal:FREQuency?
```

This command sets the internal modulation frequency for the **FM Path 1** and **FM Path 2** configurations. The current value for FM rate is displayed in the active entry area. The range of values allowed is 0.1 Hz to 10 kHz. (0.1 Hz to 50 kHz is the range allowed if sinewave is selected as the internal waveform.) The minimum increment allowed is 0.1 Hz. Notice that the new value of FM rate applies only to whichever FM path configuration you have currently selected.

\*RST Value: 400.0 Hz

## Internal Frequency Modulation Sweep Time

```
:FM[1] | 2:INTernal[1]:SWEep:TIME <val><unit>
:FM[1] | 2:INTernal:SWEep:TIME?
```

This command selects the sweep time for a swept-sine, internally-generated signal.

\*RST Value: 100 msec

## Internal Frequency Modulation Sweep Trigger

```
:FM[1] | 2:INTernal[1]:SWEep:TRIGger IMMEDIATE|BUS|EXTERNAL|KEY
:FM[1] | 2:INTernal:SWEep:TRIGger?
```

This command selects the trigger for the frequency modulation sweep.

\*RST Value: Immediate

## Internal Frequency Modulation Waveform

```
:FM[1] | 2:INTernal[1]:FUNction:SHAPE SINE|TRIangle|SQUare|RAMP|
NOISE|DUALsine|SWEptsine
:FM[1] | 2:INTernal:FUNction:SHAPE?
```

This command allows you to assign an FM waveform to your **FM Path 1** and **FM Path 2** configurations. Select from sine, triangle, square, ramp, noise, dual sine, and swept sine waveforms. Notice that your waveform selection applies only to whichever AM path configuration you have currently selected.

Using the command `:FM[1] | 2:INTernal[1]:FUNction:SHAPE SINE` lets you specify sine as the amplitude modulation waveform for the **FM Path 1** and **FM Path 2** configurations. Notice that the selected waveform applies only to whichever FM path configuration you have currently selected.

Using the command `:FM[1] | 2:INTernal[1]:FUNction:SHAPE TRIangle` lets you specify triangle as the amplitude modulation waveform for the **FM Path 1** and **FM Path 2** configurations. Notice that the selected waveform applies only to whichever FM path configuration you have currently selected.

**:FM Subsystem**

Using the command `:FM[1] | 2:INTernal[1]:FUNction:SHAPE SQUARE` lets you specify square as the amplitude modulation waveform for the **FM Path 1** and **FM Path 2** configurations. Notice that the selected waveform applies only to whichever FM path configuration you have currently selected.

Using the command `:FM[1] | 2:INTernal[1]:FUNction:SHAPE RAMP` lets you specify ramp as the amplitude modulation waveform for the **FM Path 1** and **FM Path 2** configurations. Notice that the selected waveform applies only to whichever FM path configuration you have currently selected.

Using the command `:FM[1] | 2:INTernal[1]:FUNction:SHAPE NOISE` lets you specify noise as the amplitude modulation waveform for the **FM Path 1** and **FM Path 2** configurations. Notice that the selected waveform applies only to whichever FM path configuration you have currently selected.

Using the command `:FM[1] | 2:INTernal[1]:FUNction:SHAPE DUALsine` allows you to set the dual sine as the amplitude modulation waveform for the **FM Path 1** and **FM Path 2** configurations. In this mode you can set the FM rates for two separate tones. In addition, you can set a percentage of the tone 2 FM depth to the total FM depth.

Using the command `:FM[1] | 2:INTernal[1]:FUNction:SHAPE SWEPtsine` allows you to set the swept-sine amplitude modulation waveform for the **FM Path 1** and **FM Path 2** configurations. In this mode you can set the start and stop FM rate and the sweep time. You can set the signal generator to a single, externally-triggered sweep on either a negative or positive TTL level or you can choose continuous sweep, triggered immediately. In this menu you can also select either a positive or negative polarity for the TRIGGER OUT signal.

\*RST Value: Sine



---

## :FREQUENCY Subsystem

The frequency subsystem is used to set the controls and the parameters associated with carrier signal frequency.

### Continuous Wave Frequency

```
:FREQUENCY[:CW] <val><unit>  
:FREQUENCY[:CW]?  
  
:FREQUENCY:FIXED <val><unit>  
:FREQUENCY:FIXED?
```

This command sets the signal generator's CW output frequency. The choices for the variable <val> may range from 100 kHz to the signal generator's maximum specified output frequency.

The current RF output frequency is always shown in the frequency area of the display (unless you have altered the display by turning on frequency reference mode, entering an offset or a multiplier, or if a frequency sweep is selected). Use this command to change the RF output frequency. Frequency becomes the active function and the current value is also shown in the active entry area of the display.

At \*RST, this value is set to the signal generator's maximum specified output frequency.

### Fixed Frequency

```
:FREQUENCY:FIXED <val><unit>  
:FREQUENCY:FIXED?
```

This command sets the carrier frequency for the signal generator's RF output. The choices for the variables (depending on your signal generator's model number) <val> and <unit> range from 100 kHz (minimum) to 1 GHz, 2 GHz, 3 GHz, or 4 GHz (maximum).

\*RST Value: signal generator's maximum specified output frequency.

### Frequency Mode

```
:FREQUENCY:MODE CW|FIXED|LIST  
:FREQUENCY:MODE?
```

This command sets the frequency mode of the signal generator. The choices are CW or Fixed, and List.

\*RST Value: CW

## Frequency Multiplier

```
:FREQUENCY:MULTIPLIER <val>  
:FREQUENCY:MULTIPLIER?
```

This command sets the multiplier for the signal generator's carrier frequency. The choices for the variable <val> are integers between 1 and 50.

You can multiply the frequency shown on the display without changing the frequency output at the RF OUTPUT connector (simulating the frequency at the output of a harmonic multiplier). For example, set the output frequency to 1 MHz. Then send the command :FREQUENCY:MULTIPLIER 3. The display will now show an output frequency of 3 MHz but the actual output frequency will remain at 1 MHz. For any multiplier greater than 1, the MULT indicator is shown in the frequency area of the display.

\*RST Value: 1

## Frequency Offset

```
:FREQUENCY:OFFSET <val><unit>  
:FREQUENCY:OFFSET?
```

This command sets the frequency offset. The choices for the variables <val> and <unit> are frequencies between 0.0 Hz and 200.00 GHz.

A frequency offset changes the value shown in the frequency area of the display but does not affect the output frequency. For example, if the current output frequency is 1 MHz and you enter a frequency offset of 3 MHz, the output frequency will remain at 1 MHz but the display will show a frequency of 4 MHz. This feature lets you simulate the frequency at the output of a frequency translating device.

A frequency offset can be entered at any time during normal operation and also when you are operating in frequency reference mode. When an offset has been entered, the OFFSET indicator is turned on in the frequency area of the display.

\*RST Value: 0.0 Hz

## Frequency Optimization

```
:FREQUENCY:SYNTHESIS <val>  
:FREQUENCY:SYNTHESIS?
```

This command sets the PLL (Phase Lock Loop) bandwidth for optimizing phase noise. The choices for the variable <val> may range from 1 (offsets below 10 kHz) to 2 (offsets above 10 kHz). This command is used with ESG-A and ESG-D Series instruments only.

\*RST Value: 2

## Frequency Reference

```
:FREQuency:REFerence <val>
:FREQuency:REFerence?
```

This command sets the current output frequency as a frequency reference value. The choices for the variable <val> are frequencies between 0.0 Hz and the signal generator's maximum specified output frequency. All frequency parameters are then set as relative to the reference value.

\*RST Value: 0.0 Hz

## Frequency Reference State

```
:FREQuency:REFerence:STATe ON|OFF|1|0
:FREQuency:REFerence:STATe?
```

This command toggles the frequency reference mode on and off. When frequency reference mode is turned on, the frequency value displayed is equal to the current hardware output frequency minus the reference value set by the :FREQuency:REFerence <val> command. (This command sets the reference value equal to the current output frequency. If you have not yet set the reference value, the \*RST value for frequency reference is 0 Hz.) The REF indicator is turned on in the frequency area of the display. All frequency parameters will now be set as relative to the reference value.

Frequency offsets can be used with frequency reference mode. In this situation, the display will show the frequency calculated as the current hardware output frequency minus the reference value plus the frequency offset.

Frequency reference mode only changes the display; it does not change the RF output frequency. For example, if you set your RF output frequency to 700 MHz, set your reference value to 700 MHz, and then turn frequency relative mode on, your display shows your frequency as 0 Hz but your output frequency remains at 700 MHz.

\*RST Value: Off

## Phase Adjustment

```
:PHASe[:ADJust] <val><unit>
:PHASe[:ADJust]?
```

This command adjusts the phase of the modulating signal. The choices for the variables <val> and <unit> may range plus or minus 3.141 radians from the initial value.

\*RST Value: 0.000

## Reference Oscillator Source Query

```
:ROSCillator:SOURce?
```

This command queries the source of the signal generator's reference oscillator. It returns either INT or EXT.

## Reference Oscillator Source State

```
:ROSCillator:SOURce:AUTO ON|OFF|1|0  
:ROSCillator:SOURce:AUTO?
```

This command sets the signal generator's capability of automatically selecting between the internal reference oscillator and an external reference oscillator to either on or off. When this function is turned on, the signal generator detects when a valid reference signal is present at the 10 MHz IN connector and automatically switches from internal to external reference operation. Conversely, when this function is turned off, the signal generator uses the internal reference only, even if an external reference is connected.

\*RST Value: ON

## Set Phase Reference

```
:PHASe:REFerence
```

This command sets the current output phase as a zero reference. Phase adjustments are then set as relative to this zero reference.

## Start Frequency

```
:FREQuency:STARt <val><unit>  
:FREQuency:STARt?
```

This command sets the frequency of the first point in the sweep. The choices for the variables <val> and <unit> may range from 100.0 kHz to the signal generator's maximum specified frequency.

\*RST Value: signal generator's maximum specified frequency.

## Stop Frequency

```
:FREQuency:STOP <val><unit>  
:FREQuency:STOP?
```

This command sets the frequency of the last point in the sweep. The choices for the variables <val> and <unit> may range from 100.0 kHz to the signal generator's maximum specified frequency.

\*RST Value: signal generator's maximum specified frequency.

---

## :LFOutput Subsystem

The low frequency output subsystem is used to set the controls and the parameters associated with the low frequency output signals.

### Function Generator Pulse Period Configuration

```
:LFOutput:FUNCTION:PERIOD <val><unit>  
:LFOutput:FUNCTION:PERIOD?
```

This command sets the period for the internally-generated pulse modulation source. The choices for the variables <val> and <unit> range from 16 microseconds to 30 seconds.

\*RST Value: 80.0  $\mu$ sec

### Function Generator Pulse Width Configuration

```
:LFOutput:FUNCTION:PWIDTh <val><unit>  
:LFOutput:FUNCTION:PWIDTh?
```

This command sets the pulse width for the internally-generated pulse source. The choices for the variables <val> and <unit> range from 8.0 microseconds to the value of the pulse period.

\*RST Value: 40.0  $\mu$ sec

### Function Generator Sweep Time

```
:LFOutput:FUNCTION:SWEep:TIME <val><unit>  
:LFOutput:FUNCTION:SWEep:TIME?
```

This command selects the sweep time for the function generator.

\*RST Value: 100 msec

### Function Generator Sweep Trigger

```
:LFOutput:FUNCTION:SWEep:TRIGger IMMEDIATE|KEY|EXTERNAL|BUS  
:LFOutput:FUNCTION:SWEep:TRIGger?
```

This command selects the trigger for the function generator sweep.

\*RST Value: Immediate

## Low Frequency Output, Alternate Frequency

```
:LFOutput:FUNCTION:FREQUENCY:ALTERNATE <val><unit>  
:LFOutput:FUNCTION:FREQUENCY:ALTERNATE?
```

This command sets the frequency for the alternate LF output signal when you have selected the function generator as the internal source. The alternate frequency is the second frequency of a dual-sine or the stop frequency of a swept-sine. The choices for the variables <val> and <unit> range from 0.1 kHz (minimum) to 50.0 kHz (maximum).

\*RST Value: 400.0 Hz

## Low Frequency Output, Alternate Frequency Amplitude

```
:LFOutput:FUNCTION:FREQUENCY:ALTERNATE:AMPLITUDE:PERCENT <val><unit>  
:LFOutput:FUNCTION:FREQUENCY:ALTERNATE:AMPLITUDE:PERCENT?
```

This command sets the amplitude of the alternate frequency as a percentage of the total LF output amplitude. Therefore, if the alternate frequency makes up 30% of the total amplitude, then the primary frequency is 70% of the total LF output amplitude. The choices for the variables <val> and <unit> range from 0.1% (minimum) to 99.9% (maximum).

\*RST Value: 50%

## Low Frequency Output Amplitude

```
:LFOutput:AMPLITUDE <val><unit>  
:LFOutput:AMPLITUDE?
```

This command scales the output of the signal at the LF OUTPUT connector on the front panel. The choices for the variables <val> and <unit> range from 0.0 volts (minimum) to 5.0 volts peak (maximum).

\*RST Value: 0.0 volts

## Low Frequency Output Frequency

```
:LFOutput:FUNCTION:FREQUENCY <val><unit>  
:LFOutput:FUNCTION:FREQUENCY?
```

This command sets the modulating frequency for the LF output signal when you have selected the function generator as the internal source. The choices for the variables <val> and <unit> range from 0.1 Hz (minimum) to 10.0 kHz (maximum). (0.1 Hz to 50 kHz is the range allowed if sinewave is selected as the internal waveform.)

\*RST Value: 400.0 Hz

## Low Frequency Output Source

```
:LFOutput:SOURce INT[1]|FUNction
:LFOutput:SOURce?
```

This command sets the low frequency source. The choices are Internal or Function Generator. When set to Function Generator, you can select a frequency and shape in addition to selecting the amplitude for the signal that is output at the LF OUTPUT front panel connector. Any modulation with the internal source selected is turned off when the function generator is selected.

When set to Internal, this command allows you to output a signal at the LF OUTPUT connector where the frequency and shape of the signal is set by the internal source as it is being used by a modulation. For example, if the internal source is currently assigned to an AM path configuration and AM is turned on, the signal output at the LF OUTPUT connector will have the frequency and shape of the amplitude modulating signal.

If the pulse source for pulse modulation is set to internal square, the internal source is a sinewave which is later squared by the modulator to generate the pulse squarewave. The LF OUTPUT signal for this internal source, therefore, is a sinewave. If the pulse source for pulse modulation is set to internal pulse, a true variable-width pulse will be seen on the LF OUTPUT.

At \*RST, this value is set to Internal.

## Low Frequency Output State

```
:LFOutput:STATe ON|OFF|1|0
:LFOutput:STATe?
```

This command sets the low frequency source state. The choices are On (1) or Off (0).

\*RST Value: Off

## Low Frequency Output Waveform

```
:LFOutput:FUNCTion:SHAPE SINE|DUALsine|SWEPTsine|TRIangle|SQUare|RAMP|
PULSe|NOISE|DC
:LFOutput:FUNCTion:SHAPE?
```

This command selects the waveform for the low frequency output signal. The choices are Sine, Dual-sine, Swept-sine, Triangle, Square, Ramp, Pulse, Noise, and DC waveforms.

\*RST Value: Sine

## :LIST Subsystem

The list subsystem is used to set the controls and the parameters associated with frequency and/or power sweeps.

### Dwell List

```
:LIST:DWELL <val>{, <val>}  
:LIST:DWELL?
```

This command defines a list of dwell times. The list is stored in a file (DWEL\_FILE) which is only reinitialized upon power-up preset. Each value specifies the minimum time that the sweep engine waits at that point's frequency and/or power setting before going to the next setting. Dwell times are only used when the point trigger source is set to Immediate.

### Dwell List Points Query

```
:LIST:DWELL:POINTs?
```

This command queries the signal generator for the number of points in the dwell list.

### Dwell List Type

```
:LIST:DWELL:TYPE LIST|STEP  
:LIST:DWELL:TYPE?
```

This command sets the type of dwell for a list sweep. The choices are List or Step. Use this command to toggle the dwell time for the list sweep points between the values defined in the list sweep and the value set for step sweep. Choose **LIST** to sweep with dwell times that you have defined in the list sweep. Choose **STEP** to sweep each point in the list with a dwell time set via the `:SWEep:DWELL <val>` command.

\*RST Value: List

### Frequency List

```
:LIST:FREQuency <val>{, <val>}  
:LIST:FREQuency?
```

This command defines the frequency list. Each value specifies the frequency that the sweep engine uses when sweeping frequency. This list is stored in a file (FREQ\_FILE), which is only reinitialized upon power-up preset.

### Frequency List Points Query

```
:LIST:FREQuency:POINTs?
```

This command queries the signal generator for the number of points in the frequency list.



## List Direction

```
:LIST:DIRection UP|DOWN  
:LIST:DIRection?
```

This command sets the direction of execution of a list sweep. The choices are Up or Down. Choose **UP** to sweep from the first point in the list to the last point, or from the step sweep start frequency and amplitude to the stop frequency and amplitude. Choose **DOWN** to reverse the direction of the sweep.

\*RST Value: Up

## List Mode

```
:LIST:MODE AUTO|MANual  
:LIST:MODE?
```

This command sets the operating mode of a list sweep. The choices are Auto or Manual. When in manual mode, the selected point controls the frequency and amplitude according to the sweep type.

\*RST Value: Auto

## List Trigger Source

```
:LIST:TRIGger:SOURce BUS|IMMediate|EXTernal|KEY  
:LIST:TRIGger:SOURce?
```

This command sets the point-to-point triggering source for the sweep. The choices are Bus (trigger a list or step sweep using the GPIB), Immediate (immediately triggers the current sweep), External (trigger a list or step sweep on a signal applied to the TRIGGER IN rear panel connector), or Key (triggers the step when you press the **Trigger** front panel key). The sweep must be initiated (and the sweep trigger received) before the point-to-point trigger can cause the sweep to go to the next point.

\*RST Value: Immediate

## List Type

```
:LIST:TYPE LIST|STEP  
:LIST:TYPE?
```

This command sets the type of sweep. The choices are List and Step. You create a list sweep by supplying the frequency, amplitude, and dwell time for each point in the sweep. You create a step sweep by supplying the start and stop frequency and amplitude, the number of points, and a dwell time. The signal generator then determines the values of each point between the first and last point in a linear manner.

\*RST Value: List

## Load List From Step Sweep

```
:LIST:TYPE:LIST:INITialize:FSTep
```

This command eliminates the existing sweep list data and replaces it with the step sweep data points.

## Manual Point

```
:LIST:MANual <val>  
:LIST:MANual?
```

This command sets the current element used by the list mode. If list mode is controlling frequency and/or power then the indexed element in the respective list(s) will be used. If the list mode is `AUTO`, then nothing will happen until the mode is changed to `MANUAL`. If the point selected is beyond the length of the longest enabled list, then the point will be set to the maximum possible point, and an error will be generated.

At `*RST`, this value is set to 1.

## Power List

```
:LIST:POWer <val>{,<val>}  
:LIST:POWer?
```

This command defines the power list. Each value specifies the power level that the instrument uses when it is sweeping. This list is stored in a file (`POW_FILE`), which is only reinitialized upon power-up preset.

## Power List Points Query

```
:LIST:POWer:POINts?
```

This command queries the signal generator for the number of points in the power list.

## Preset List

```
:LIST:TYPE:LIST:INITialize:PRESet
```

This command eliminates the existing sweep list data and replaces it with a new list consisting of the following: one point at a default frequency with a default amplitude and a default dwell time.

---

## :MEMory and :MMEMory Subsystems

The memory and mass memory subsystems are used to manage and access instrument memory and mass storage.

### All Memory Catalog

```
:MEMory:CATalog[:ALL]?
```

```
:MMEMory:CATalog[:ALL]? "<file systems>"
```

This command outputs all lists of the files in the specified memory subsystem “:” for memory :CATalog. The return data will be in the following form:

```
<mem used>,<mem free>{,<file listing>}
```

The signal generator will return the two memory usage parameters and as many file listings as there are files in the directory list. Each file listing parameter will be in the following form:

```
"<file_name>",<file type>,<file size>
```

The file types are:

- BINary - A binary file
- STATE - A state file
- LIST - A sweep list file
- FIR - A filter coefficient file (Option UN8 or UND)
- SHAPe - A burst shape file (Option UN8 only)
- BIT - A Bit file
- ARB Catalog Types (Option UND only) (see below)
- Modulation Catalog Types (see [page 2-42](#))

### ARB Catalog Types (Option UND only)

```
:MEMory:CATalog:CDMa? | DMOD? | DWCDma? | FCDMa? | FWCDma? | MCDMa? | MDMOD? | MDWCdma? | MFCDma? | MFWCDma? | MTONe? | RCDMa? | RWCDma? | SEQ? | UWCDma?
```

```
:MMEMory:CATalog? "ARBI:"
```

```
:MMEMory:CATalog? "NVARbi:"
```

These commands output a list of related files in the “:” directory. The return data will be in the following form:

```
<mem used>,<mem free>{,<file listing>}
```

The signal generator will return the two memory usage parameters and as many file listings as there are files in the directory list. Each file listing parameter will be in the following form:

```
"<file_name>",<file type>,<file size>
```

The file types are:

- ARBI - a volatile arbitrary waveform generator file (Option UND)
- CDMa - an IS-95 CDMA file (Option UN5)
- DMOD - a digital modulation file
- DWCDma - a downlink W-CDMA file (Option 100, 3GPP V3.4 12-00)
- FCDDMa - a forward link cdma2000 file (Option 101)
- FWCDma - a forward link W-CDMA file (Option 100, Rev. 1.0-1.2)
- MCDMa - a multicarrier IS-95 CDMA file (Option UN5)
- MDMod - multicarrier digital modulation file
- MDWCdma - a multicarrier downlink W-CDMA file (Option 100, 3GPP V3.4 12-00)
- MFCDma - a multicarrier forward link cdma2000 file (Option 101)
- MFWCDma - a multicarrier forward link W-CDMA file (Option 100, Rev. 1.0-1.2)
- MTONe - a multitone file
- NVARBI - a non-volatile arbitrary waveform generator file (Option UND)
- RCDMa - a reverse link cdma2000 file (Option 101)
- RWCDma - a reverse link W-CDMA file (Option 100, Rev. 1.0-1.2)
- SEQ - a sequence file
- UWCDma - an uplink W-CDMA file (Option 100, 3GPP V3.4 12-00)

## Binary Memory Catalog

```
:MEMory:CATalog:BINary?
```

This command outputs a list of the binary files in the “:” directory. The return data will be in the following form:

```
<mem used>,<mem free>{,<file listing>}
```

The signal generator will return the two memory usage parameters and as many file listings as there are files in the directory list. Each file listing parameter will be in the following form:

```
"<file_name>",<file type>,<file size>
```

## Bit Memory Catalog

```
:MEMory:CATalog:BIT?
```

This command outputs a list of the bit files in the “.” directory. The return data will be in the following form:

```
<mem used>,<mem free>{,<file listing>}
```

The signal generator will return the two memory usage parameters and as many file listings as there are files in the directory list. Each file listing parameter will be in the following form:

```
"<file_name>",<file type>,<file size>
```

## FIR Memory Catalog

```
:MEMory:CATalog:FIR?
```

This command outputs a list of the FIR files in the “.” directory. The return data will be in the following form:

```
<mem used>,<mem free>{,<file listing>}
```

## Shape Memory Catalog

```
:MEMory:CATalog:SHAPE?
```

This command outputs a list of the SHAPE files in the “.” directory. The return data will be in the following form:

```
<mem used>,<mem free>{,<file listing>}
```

## Copy Files

```
:MEMory:COPY[:NAME] "<file_name>",<file_name>"
```

```
:MMEMory:COPY <msus>,<msus>
```

This command makes duplicates of the requested files. The variable <msus> represents [<file\_system>:]<file\_name>".

## Delete All

---

**CAUTION** Using this command causes the loss of all state and list files, any saved setups which use the table editor, and any user-downloaded files. You cannot recover the files after sending this command.

---

```
:MEMory:DELeTe:ALL
```

This command clears the user file system of ALL files. This includes the “.”, “LIST:”, and “STATE:” directories. If any one of the deleted files are used by a mode that performs digital modulation, then the data type of that modulation will be changed to PN9.

## Delete ARB File Types (Option UND only)

:MEMory:DELeTe:CDMa | DMOD | DWCDma | FCDMa | FWCDma | MCDMa | MDMoD | MDWCdma | MFCDma | MFWCdma | MTONE | RCDMa | RWCDma | SEQ | UWCDma  
:MMEMemory:DELeTe:ARBI | NVARBI

These commands will delete all the files related to the specific ARB file type command selected.

The file types are:

- ARBI - a volatile arbitrary waveform generator file (Option UND)
- CDMa - an IS-95 CDMA file (Option UN5)
- DMOD - a digital modulation file
- DWCDma - a downlink W-CDMA file (Option 100, 3GPP V3.4 12-00)
- FCDMa - a forward link cdma2000 file (Option 101)
- FWCDma - a forward link W-CDMA file (Option 100, Rev. 1.0-1.2)
- MCDMa - a multicarrier IS-95 CDMA file (Option UN5)
- MDMoD - multicarrier digital modulation file
- MDWCdma - a multicarrier downlink W-CDMA file (Option 100, 3GPP V3.4 12-00)
- MFCDma - a multicarrier forward link cdma2000 file (Option 101)
- MFWCdma - a multicarrier forward link W-CDMA file (Option 100, Rev. 1.0-1.2)
- MTONE - a multitone file
- NVARBI - a non-volatile arbitrary waveform generator file (Option UND)
- RCDMa - a reverse link cdma2000 file (Option 101)
- RWCDma - a reverse link W-CDMA file (Option 100, Rev. 1.0-1.2)
- SEQ - a sequence file
- UWCDma - an uplink W-CDMA file (Option 100, 3GPP V3.4 12-00)

## Delete Binary

:MEMory:DELeTe:BINary

This command deletes all binary files.

## Delete Bit

:MEMory:DELeTe:BIT

This command deletes all bit files.

## Delete Filename

```
:MEMory:DELEte[:NAME] "<file_name>"
```

```
:MMEMory:DELEte[:NAME] <msus>
```

This command clears the user file system of "<file\_name>" or <msus>. If any one of the deleted files are used by a mode that performs digital modulation, then the data type of that modulation will be changed to PN9. The variable <msus> represents.

```
[<file_system>:] "<file_name>".
```

## Delete FIR

```
:MEMory:DELEte:FIR
```

This command deletes all FIR files.

## Delete FSK

```
:MEMory:DELEte:FSK
```

This command deletes all FSK files.

## Delete IQ

```
:MEMory:DELEte:IQ
```

This command deletes all I/Q files.

## Delete List

```
:MEMory:DELEte:LIST
```

This command deletes all list files.

## Delete Shape

```
:MEMory:DELEte:SHAPE
```

This command deletes all shape files.

## Delete State

```
:MEMory:DELEte:STATE
```

This command deletes all state files.

## Free Memory Query

```
:MEMory:FREE[:ALL]?
```

This command outputs the number of bytes left in the user file system.

## List Memory Catalog

```
:MEMory:CATalog:LIST?
```

This command outputs a list of sweep lists files in the “:” directory. The return data will be in the following form:

```
<mem used>,<mem free>{,<file listing>}
```

The signal generator will return the two memory usage parameters and as many file listings as there are files in the directory list. Each file listing parameter will be in the following form:

```
"<file_name>",<file type>,<file size>
```

## Load Sweep List

```
:MMEemory:LOAD:LIST <msus>
```

```
:MEMory:LOAD:LIST "<file_name>"
```

This command loads a sweep list from memory. The variable <msus> represents [`<file_system>`:]"<file\_name>".

## Memory Data Load

```
:MEMory:DATA "<file_name>",<datablock>
```

```
:MMEemory:DATA <msus>,<datablock>
```

This command loads <datablock> into the memory location "<file\_name>" or <msus>. The variable <msus> represents [`<file_system>`:]"<file\_name>".

## Memory Filename Query

```
:MEMory:DATA? "<file_name>"
```

```
:MMEemory:DATA? <msus>
```

This command returns the <datablock> associated with the "<file\_name>" or <msus>. The variable <msus> represents [`<file_system>`:]"<file\_name>".

## Modulation Catalog Types

```
:MEMory:CATalog:IQ?|FSK?
```

This command outputs a list of the I/Q or FSK files in the “:” directory. The return data will be in the following form:

```
<mem used>,<mem free>{,<file listing>}
```

The signal generator will return the two memory usage parameters and as many file listings as there are files in the directory list. Each file listing parameter will be in the following form:

```
"<file_name>",<file type>,<file size>
```



The file types are:

- I/Q - an I/Q file
- FSK - an FSK file

## Rename File

```
:MEMory:MOVE <src_file>,<dest_file>
```

```
:MMEMory:MOVE <src_file>,<dest_file>
```

This command renames the requested (highlighted) file in the memory catalog.

## State Comment

```
:MEMory:STATE:COMMENT <reg_num>,<seq_num>,"<comment>"
```

```
:MEMory:STATE:COMMENT? <reg_num>,<seq_num>
```

This command allows you to add a descriptive comment to the saved state <reg>,<seq>. Comments can be up to 55 characters long.

## State Memory Catalog

```
:MEMory:CATalog:STATe?
```

This command outputs a list of the state files in the “.” directory. The return data will be in the following form:

```
<mem used>,<mem free>{,<file listing>}
```

The signal generator will return the two memory usage parameters and as many file listings as there are files in the directory list. Each file listing parameter will be in the following form:

```
"<file_name>",<file type>,<file size>
```

## Store Sweep List

```
:MEMory:STORE:LIST "<file_name>"
```

```
:MMEMory:STORE:LIST <msus>
```

This command stores the current sweep list to file "<file\_name>" or <msus>. The variable <msus> represents [<file\_system>:] "<file\_name>".

---

## :OUTPut Subsystem

The RF output subsystem is used to set the controls and the parameters associated with the signal generator's RF output.

### RF Output Circuit Protection Clear

```
:OUTPut:PROTection:CLEar
```

There is no query for this command.

This command resets the signal generator's reverse power protection circuitry.

### RF Output Circuit Protection Mode

```
:OUTPut:PROTection:MODE "NORMAL" | "8648"
```

```
:OUTPut:PROTection:MODE?
```

This command sets operating mode of the signal generator's reverse power protection circuitry. The choices are Normal and 8648. When set to Normal, the RPP can only be reset by eliminating the source of the excess reverse power detected at the RF OUTPUT connector, and then pressing Reset RPP or sending the remote command `OUTPut:PROTection:CLEar`. When set to 8648, the RPP will be reset and the caution message removed on any SCPI command. This mode is provided for compatibility with systems that use the HP/Agilent 8648. It is only available when you have selected 8648A/B/C/D as the remote language. At all other times reverse power protection is set to Normal.

---

**CAUTION** Operate in this mode with *caution*. Repeatedly tripping the RPP can cause damage to the signal generator. It is still best to eliminate the source of the excess reverse power and then reset the reverse power protection circuit by pressing the **Reset RPP** softkey or sending the remote command `OUTPut:PROTection:CLEar`. You should not ignore RPP trips. Hardware damage may occur before the RPP can protect the instrument.

---

The RPP reset mode is a persistent state, set to Normal at the factory; it is not affected by an instrument preset or by a power cycle.

### RF Output Circuit Protection Query

```
:OUTPut:PROTection:TRIPped?
```

This command queries the signal generator's reverse power protection circuitry to determine if it has been activated.

## RF Output Modulation State

```
:OUTPut:MODulation[:STATe] ON|OFF|1|0  
:OUTPut:MODulation[:STATe]?
```

This command sets the operating state of the signal generator's RF output modulations you have enabled. The choices are On (1) or Off (0). All modulation types can be simultaneously enabled except FM with  $\Phi$ M, AM with external burst source, and wideband AM with I/Q. An annunciator is always displayed to indicate whether overall modulation is switched on or off.

\*RST Value: On

## RF Output State

```
:OUTPut[:STATe] ON|OFF|1|0  
:OUTPut[:STATe]?
```

This command sets the operating state of the signal generator's RF output. The choices are On (1) or Off (0). Although you can configure and engage various modulations, no signal is available at the RF OUTPUT connector until the command `:OUTPut[:STATe] ON` is executed. An annunciator is always displayed to indicate whether RF is switched on or off.

\*RST Value: Off

## :PM Subsystem

The phase modulation subsystem is used to set the modulation controls and the parameters associated with phase modulated signals.

### $\Phi$ Modulation Bandwidth Configuration

```
:PM[1] | 2 :BANDwidth | BWIDth NORMAL | HIGH
:PM[1] | 2 :BANDwidth | BWIDth?
```

This command toggles between normal phase modulation mode and wideband phase modulation mode. The choices are Normal and Wideband.

\*RST Value: Normal

### $\Phi$ Modulation Deviation

```
:PM[1] | 2[:DEVIation] <val><unit>
:PM[1] | 2[:DEVIation]?
```

This command sets the deviation of the phase modulation. The choices for the variables <val> and <unit> depend on the carrier frequency. For the ESG-A and ESG-D Series, the maximum peak deviation for a frequency is calculated by multiplying N by 10 MHz. (Refer to [Table 2-1](#).) For the ESG-AP and ESG-DP Series, the maximum peak deviation for a frequency is calculated by multiplying N by 1 MHz. (Refer to [Table 2-2](#).)

**Table 2-1. Phase Modulation Frequency Response (ESG-A and ESG-D)**

Mode	Maximum Deviation	Maximum Rates (3 dB BW)	
		$\Phi$ M Path 1	$\Phi$ M Path 2
Normal	$N^1 \times 90$ radians	dc to 100 kHz	dc to 100 kHz
High Bandwidth	$N^1 \times 2\pi$ radians	dc to 1.5 MHz (typical)	dc to 0.9 MHz (typical)
	$N^1 \times \pi/2$ radians	dc to 4 MHz (typical)	dc to 1 MHz (typical)

1. For the value of N, refer to [Table 2-3](#).

**Table 2-2. Phase Modulation Frequency Response (ESG-AP and ESG-DP)**

Mode	Maximum Deviation	Maximum Rates (3 dB BW)	
		$\Phi$ M Path 1	$\Phi$ M Path 2
Normal	$N^1 \times 10$ radians	dc to 100 kHz	dc to 100 kHz
High Bandwidth	$N^1 \times 1$ radians	dc to 1MHz	dc to 1 MHz

1. For the value of N, refer to [Table 2-3](#).

**Table 2-3. Carrier Frequency Bands versus Value of N**

Carrier Frequency	N
250 kHz to $\leq 249.999$ MHz	1
$> 249.999$ MHz to $\leq 500$ MHz	0.5
$> 500$ MHz to $\leq 1$ GHz	1
$> 1$ GHz to $\leq 2$ GHz	2
$> 2$ GHz to 4 GHz	4

\*RST Value: 0.000 radians

### $\Phi$ Modulation Deviation Coupling

```
:PM[1]|2[:DEVIation]:TRACk ON|OFF|1|0
:PM[1]|2[:DEVIation]:TRACk?
```

This command allows the phase modulation deviation values on both path 1 and path 2 to track each other. The choices are On (1) or Off (0). If the phase modulation deviation coupling function is activated, changing the phase modulation deviation on path 1 will change the in phase modulation deviation on path 2 to match, and visa versa. This is an exact match tracking, not an offset tracking.

\*RST Value: Off

### $\Phi$ Modulation Source

```
:PM[1]|2:SOURce INT[1]|EXT1|EXT2
:PM[1]|2:SOURce?
```

This command sets the source that will generate the phase modulation. The choices are Internal Source 1, External Source 1, or External Source 2.

\*RST Value: Internal

### $\Phi$ Modulation State

```
:PM[1]|2:STATe ON|OFF|1|0
:PM[1]|2:STATe?
```

This command sets the operating state of the phase modulation source. The choices are On (1) or Off (0).

\*RST Value: Off

## External $\Phi$ Modulation Source Coupling

```
:PM[1]|2:EXTeRnal[1]|2:COUPling AC|DC  
:PM[1]|2:EXTeRnal[1]|2:COUPling?
```

This command sets the external coupling for the phase modulation source if :PM[1]|2:SOURCe was selected external. The choices are AC or DC coupling. This command does not change the currently active source, nor does it switch the current modulation on or off. The modulating signal may be the sum of several signals, either internal or external sources. If the coupling is set to DC, then both the AC and DC signal components pass. AC coupling passes only AC signal components.

\*RST Value: DC

## Internal $\Phi$ Modulation Alternate Frequency

```
:PM[1] | 2: INTERNAL[1]: FREQUENCY: ALTERNATE <val><unit>
:PM[1] | 2: INTERNAL: FREQUENCY: ALTERNATE?
```

This command sets the frequency for the alternate signal. The alternate frequency is the second frequency of a dual-sine or the stop frequency of a swept-sine. The choices for the variables <val> and <unit> range from 0.1 kHz (minimum) to 50.0 kHz (maximum).

\*RST Value: 400.00 Hz

## Internal $\Phi$ Modulation Alternate Frequency Amplitude

```
:PM[1] | 2: INTERNAL[1]: FREQUENCY: ALTERNATE: AMPLITUDE: PERCENT <val><unit>
:PM[1] | 2: INTERNAL: FREQUENCY: ALTERNATE: AMPLITUDE: PERCENT?
```

This command sets the amplitude of the alternate frequency as a percentage of the total amplitude (phase modulation deviation). Therefore, if the alternate frequency makes up 30% of the total amplitude, then the primary frequency is 70% of the total phase modulation deviation amplitude (for dual-sine only). The choices for the variables <val> and <unit> range from 0.1% (minimum) to 99.9% (maximum).

\*RST Value: 50%

## Internal $\Phi$ Modulation Source Rate

```
:PM[1] | 2: INTERNAL[1]: FREQUENCY <val><unit>
:PM[1] | 2: INTERNAL: FREQUENCY?
```

This command sets the rate of the internally-generated modulation source. The choices for the variables <val> and <unit> range from 0.1 Hz (minimum) to 50 kHz (maximum) if the internal waveform is Sine wave. For all other waveforms, the maximum internal amplitude modulation rate is 10 kHz.

\*RST Value: 400.0 Hz

## Internal $\Phi$ Modulation Sweep Time

```
:PM[1] | 2: INTERNAL[1]: SWEEP: TIME <val><unit>
:PM[1] | 2: INTERNAL: SWEEP: TIME?
```

This command selects the sweep time for a swept-sine, internally-generated signal.

\*RST Value: 0.1 Hz

## Internal $\Phi$ Modulation Sweep Trigger

```
:PM[1] | 2: INTERNAL[1]: SWEEP: TRIGGER IMMEDIATE | BUS | EXTERNAL | KEY
:PM[1] | 2: INTERNAL: SWEEP: TRIGGER?
```

This command selects the trigger for the phase modulation sweep.

\*RST Value: Immediate

## Internal $\Phi$ Modulation Waveform

```
:PM[1]|2:INTernal[1]:FUNction:SHAPE SINE|TRIangle|SQUare|RAMP|NOISE|  
DUALsine|SWEPTsine  
:PM[1]|2:INTernal:FUNCTion:SHAPE?
```

This command selects the modulation waveform of the internally generated signal. The choices are Sine, Triangle, Square, Ramp, Noise, Dual-sine, or Swept-sine.

\*RST Value: Sine



---

## :POWER Subsystem

The RF power subsystem is used to set the controls and the parameters associated with the signal generator's RF output amplitude.

### Alternate Amplitude Delta (Option UNA)

```
:POWER:ALternate:AMPLitude <val>  
:POWER:ALternate:AMPLitude?
```

This command sets the delta value for the alternate amplitude. The actual RF output is equal to the sum of the delta value, the main RF output amplitude, the amplitude offset value minus the amplitude reference value.

\*RST Value: 0 dB

### Alternate Amplitude Manual Trigger (Option UNA)

```
:POWER:ALternate:MANual MAIN|DELta  
:POWER:ALternate:MANual?
```

This command toggles the alternate amplitude manual trigger source between main and alternate (delta). With the alternate amplitude trigger set to manual, this command is used to switch the RF output between main and alternate amplitudes.

\*RST Value Main

### Alternate Amplitude State (Option UNA)

```
:POWER:ALternate:STATE ON|OFF|1|0  
:POWER:ALternate:STATE?
```

This command toggles the alternate amplitude between on and off. The alternate amplitude mode must be turned on in order to switch the RF output power between main and alternate amplitudes.

\*RST Value: Off

## Alternate Amplitude Trigger Source (Option UNA)

```
:POWER:ALternate:TRIGger[:SOURce] INTernal|EXTernal|MANual  
:POWER:ALternate:TRIGger[:SOURce]?
```

This command selects the alternate amplitude trigger source to be either internal, external, or manual.

Internal triggering is only available with baseband generator options. With internal triggering, each timeslot is allowed to output power with assigned main or alternate amplitude.

With external triggering, an external trigger must be provided at the TRIGGER IN BNC connector to toggle the RF output power between main or alternate amplitudes.

With manual triggering, the RF output can be toggled between main and alternate amplitudes using the :POWER:ALternate:MANual MAIN|ALternate command.

\*RST Value: Manual

## Automatic RF Output Level Attenuation

```
:POWER:ATTenuation:AUTO ON|OFF|1|0  
:POWER:ATTenuation:AUTO?
```

This command sets the signal generator to automatically couple the attenuator to the RF output power level. With this function off (equivalent to attenuator-hold mode On), power drop-outs do not occur for power adjustments. The choices are on (1) or off (0). The maximum power adjustment range is frequency-dependent, but will be at least +4 dB for increasing power and at least -13 dB for decreasing power.

\*RST Value: ON

## Define Power Units

```
:UNIT:POWER DBM|DBUV|V|VEMF|  
:UNIT:POWER?
```

This command terminates an amplitude value in either dBm, dB $\mu$ V, V, Vemf.

\*RST Value: dBm

## RF Output Automatic Leveling Circuitry (ALC) Bandwidth

```
:POWER:ALC:BANDwidth|BWIDth NORMAL|NARROW  
:POWER:ALC:BANDwidth|BWIDth?
```

This command changes the bandwidth of the ALC loop. Defaults are Normal if IQ modulation is off, Narrow if EXT IQ is on.

\*RST Value: Normal

## RF Output Automatic Leveling Circuitry (ALC) Search State

```
:POWER:ALC:SEARCH ON|OFF|1|0|ONCE
:POWER:ALC:SEARCH?
```

This command toggles between the auto and manual modes of power search mode. The choices are On (1) or Off (0). Power search is an internal calibration routine used to achieve calibrated output power when the ALC is off. When you turn power search on, power search will execute automatically with each change to the RF frequency or power, and also with each change to the AM, burst, pulse, or I/Q modulation state. You do not need to disconnect modulation inputs, however modulation is disabled during power search. If you are using external I/Q modulation, the power search routine assumes that the I/Q input level is  $\sqrt{I^2+Q^2} = 0.5 V_{\text{rms}}$ . Actual output amplitude will scale directly with  $\sqrt{I^2+Q^2}$ . When power search is set to Off, the power search routine is not run unless the command [ :SOURCE ] :POWER:ALC:SEARCH ONCE is sent.

\*RST Value: Off

## RF Output Automatic Leveling Circuitry (ALC) Search Reference

```
:POWER:ALC:SEARCH:REFERENCE FIXED|MODULATED
:POWER:ALC:SEARCH:REFERENCE?
```

This command lets you set either fixed or modulated modes of power search. Power search is an internal calibration routine used to achieve calibrated power when the ALC is off. Fixed power search mode uses a 0.5 volt reference. When you set the power search mode to modulated, the current I/Q modulation remains active and the reference is the RMS value of the current I/Q modulation.

\*RST Value: Fixed

## RF Output Automatic Leveling Circuitry (ALC) State

```
:POWER:ALC:STATE ON|OFF|1|0
:POWER:ALC:STATE?
```

This command sets the operating state of the signal generator's RF output automatic leveling circuitry. The choices are On (1) or Off (0).

\*RST Value: On

## RF Output Level Amplitude Offset

```
:POWER[:LEVel][:IMMediate]:OFFSet <val><unit>  
:POWER[:LEVel][:IMMediate]:OFFSet?
```

This command sets a value for amplitude offset for the RF output power level. An amplitude offset changes the value shown in the amplitude area of the display but does not affect the absolute output power. For example, if the current output power is 0 dBm and you enter an amplitude offset of -3 dBm, the output power will remain at 0 dBm but the display will show an amplitude of -3 dBm. This feature lets you simulate the power level at a test point beyond the RF OUTPUT connector.

\*RST Value: 0.00 dB

## RF Output Level Immediate Amplitude

```
:POWER[:LEVel][:IMMediate][:AMPLitude] <val><unit>  
:POWER[:LEVel][:IMMediate][:AMPLitude]?
```

This command sets the RF output power. The choices for variables <val> and <unit> are power levels between -135.00 (minimum) and +20 dBm (maximum). Amplitude becomes the active function and the current value is shown in the active entry area of the display.

\*RST Value: -135 dBm

## RF Output Power Mode

```
:POWER:MODE FIXed|LIST  
:POWER:MODE?
```

This command sets the signal generator's RF output power operating mode. The choices are Fixed and List.

\*RST Value: Fixed

## RF Output Reference Power

```
:POWER:REFErence <val><unit>  
:POWER:REFErence?
```

This command sets the power setting of the signal generator's RF output reference. The choices for the variables <val> and <unit> range from -400 dBm (minimum) to 300 dBm (maximum).

\*RST Value: 0 dBm

## RF Output Reference Power State

```
:POWER:REFERENCE:STATE ON|OFF|1|0  
:POWER:REFERENCE:STATE?
```

This command sets the operating state of the signal generator's RF output reference. The choices are On (1) or Off (0).

\*RST Value: Off

## RF Output Start Power

```
:POWER:START <val><unit>  
:POWER:START?
```

This command sets the first operating power level in swept power applications. The choices for the variables <val> and <unit> are -135.00 dBm to +20 dBm.

\*RST Value: -135.00 dBm

## RF Output Stop Power

```
:POWER:STOP <val><unit>  
:POWER:STOP?
```

This command sets the last operating power level in swept power applications. The choices for the variables <val> and <unit> are -135.00 dBm to +20 dBm.

\*RST Value: -135.00 dBm

---

## :PULM Subsystem

The pulse modulation subsystem is used to set the modulation controls and the parameters associated with pulse modulated signals.

### Fast Pulse Modulation State

```
:PULM:FAST:STATE ON|OFF|1|0
:PULM:FAST:STATE?
```

This command sets the operating state of fast pulse modulation. The choices are On (1) or Off (0).

\*RST Value: Off

### Internal Pulse Modulation Pulse Period Configuration

```
:PULM:INTernal[1]:PERiod <val><unit>
:PULM:INTernal[1]:PERiod?
```

This command sets the period time for the internally-generated pulse modulation source. The choices for the variables <val> and <unit> range from 30 seconds to 16 microseconds.

\*RST Value: 80.0  $\mu$ sec

### Internal Pulse Modulation Pulse Width Configuration

```
:PULM:INTernal[1]:PWIDth <val><unit>
:PULM:INTernal[1]:PWIDth?
```

This command sets the pulse width for the internally-generated pulse modulation source. The choices for the variables <val> and <unit> range from 8.0 microseconds to the value of the pulse period.

\*RST Value: 40.0  $\mu$ sec

## Internal Pulse Modulation Source Rate

```
:PULM:INTernal[1]:FREQuency <val><unit>  
:PULM:INTernal[1]:FREQuency?
```

This command sets the rate of the internal squarewave pulse modulation source. The choices for the variables <val> and <unit> range from 0.1 Hz (minimum) to 50 kHz (maximum) if the internal waveform is Sine wave. For all other waveforms, the maximum internal amplitude modulation rate is 10 kHz.

\*RST Value: 400.0 Hz

## Internal Pulse Waveform Configuration

```
:PULM:INTernal[1]:FUNctIon:SHAPE SQUare|PULSE  
:PULM:INTernal[1]:FUNctIon:SHAPE?
```

This command toggles the modulation waveform of the internal pulse modulation source between squarewave and variable pulse width wave. The choices are Square and Pulse.

\*RST Value: Pulse

## Pulse Modulation Source

```
:PULM:SOURce INT|EXT2  
:PULM:SOURce?
```

This command sets the source that will generate the pulse modulation. The choices are Internal Square, Internal Pulse, or External Source 2.

\*RST Value: Internal Square

## Pulse Modulation State

```
:PULM:STATe ON|OFF|1|0  
:PULM:STATe?
```

This command sets the operating state of the pulse modulation source. The choices are On (1) or Off (0).

\*RST Value: Off

---

## :ROUTE Subsystem (Option UN8)

The route subsystem is used to set the parameters associated with signal polarity. <sup>1</sup>

### Burst Gate Input Polarity Configuration

```
:ROUTE:HARDware:DGENERator:IPOLarity:BGATE POSitive|NEGative  
:ROUTE:HARDware:DGENERator:IPOLarity:BGATE?
```

This command configures the polarity of the TTL input signal at the BURST GATE IN connector. POSitive refers to the rising edge, while NEGative refers to the falling edge.

\*RST Value: Positive

### Data Clock Input Polarity Configuration

```
:ROUTE:HARDware:DGENERator:IPOLarity:CLOCK POSitive|NEGative  
:ROUTE:HARDware:DGENERator:IPOLarity:CLOCK?
```

This command configures the polarity of the TTL input signal at the DATA CLOCK connector. POSitive refers to the rising edge, while NEGative refers to the falling edge.

\*RST Value Positive

### Data Clock Output Polarity Configuration

```
:ROUTE:HARDware:DGENERator:OPOLarity:CLOCK POSitive|NEGative  
:ROUTE:HARDware:DGENERator:OPOLarity:CLOCK?
```

This command configures the polarity of the TTL output signal at the DATA CLOCK OUT connector. POSitive refers to the rising edge, while NEGative refers to the falling edge.

\*RST Value: Positive

### Data, Data Clock, and Symbol Sync Outputs State

```
:ROUTE:HARDware:DGENERator:OUTPut:DCS[:STATe] ON|OFF|1|0  
:ROUTE:HARDware:DGENERator:OUTPut:DCS[:STATe]?
```

This command is used to disconnect the output signals from the rear panel DATA OUT, DATA CLK OUT, and SYMBOL SYNC OUT connectors. Normally, these output signals should be connected (On). However, disconnecting these outputs will decrease the spurs that are sometimes present when you are operating at high symbol rates.

\*RST Value: On

---

1. Older versions of the :ROUTE subsystem SCPI commands will still work for backward compatibility with Options UN8 and UN9 – hardware versions B and C, and Options UN3 and UN4 – hardware version A.



## Data Input Polarity Configuration

```
:ROUTE:HARDware:DGENERator:IPOLarity:DATA POSitive|NEGative
:ROUTE:HARDware:DGENERator:IPOLarity:DATA?
```

This command configures the polarity of the TTL input signal at the DATA connector. POSitive refers to normal logic, while NEGative refers to inverted logic.

\*RST Value: Positive

## Data Output Polarity Configuration

```
:ROUTE:HARDware:DGENERator:OPOLarity:DATA POSitive|NEGative
:ROUTE:HARDware:DGENERator:OPOLarity:DATA?
```

This command configures the polarity of the TTL output signal at the DATA OUT connector. POSitive refers to normal logic, while NEGative refers to inverted logic.

\*RST Value: Positive

## Event 1/2 Output Polarity Configuration

```
:ROUTE:HARDware:DGENERator:OPOLarity:EVENT[1]|2 POSitive|NEGative
:ROUTE:HARDware:DGENERator:OPOLarity:EVENT[1]|2?
```

This command configures the polarity of the TTL output signal at the EVENT 1 or EVENT 2 connector. POSitive refers to normal logic, while NEGative refers to inverted logic.

\*RST Value: Positive

## Pattern Trigger Input Polarity Configuration

```
:ROUTE:HARDware:DGENERator:IPOLarity:TRIGger POSitive|NEGative
:ROUTE:HARDware:DGENERator:IPOLarity:TRIGger?
```

This command configures the polarity of the TTL signal at the PATTERN TRIG IN connector that triggers an event. POSitive refers to the rising edge, while NEGative refers to the falling edge.

\*RST Value: Positive

## Symbol Sync Input Polarity Configuration

```
:ROUTE:HARDware:DGENERator:IPOLarity:SSYNc POSitive|NEGative
:ROUTE:HARDware:DGENERator:IPOLarity:SSYNc?
```

This command configures the polarity of the TTL input signal at the SYMBOL SYNC connector. POSitive refers to normal logic, while NEGative refers to inverted logic.

\*RST Value: Positive

## Symbol Sync Output Polarity Configuration

```
:ROUTE:HARDware:DGENERator:OPOLarity:SSYNc POSitive|NEGative  
:ROUTE:HARDware:DGENERator:OPOLarity:SSYNc?
```

This command configures the polarity of the TTL output signal at the SYMBOL SYNC OUT connector. POSitive refers to normal logic, while NEGative refers to inverted logic.

\*RST Value: Positive

---

## :STATus Subsystem

The IEEE status subsystem is used to set the controls and the parameters associated with status conditions within the signal generator.

### Status Preset

```
:STATus:PRESet
```

This command presets all transition filters, enable registers, and all error/event queue enable registers.

### Data Questionable BERT Status Group Condition Register Query

```
:STATus:QUESTionable:BERT:CONDition?
```

This command returns the decimal value of the sum of the bits in the Data Questionable BERT Condition Register. For example, if no clock signal has not been input for more than three seconds during the bit error rate measurements (bit 0), then a value of 1 is returned. Note that the data in this register is continuously updated and reflects the current conditions.

### Data Questionable BERT Status Group Enable

```
:STATus:QUESTionable:BERT:ENable <num>  
:STATus:QUESTionable:BERT:ENable?
```

This command determines what bits in the Data Questionable BERT Status Group Event Register will set the Data Questionable BERT Summary bit (bit 12) in the Data Questionable Status Group Condition Register. The variable <num> is the sum of the decimal values of the bits you want to enable.

### Data Questionable BERT Status Group Event Register Query

```
:STATus:QUESTionable:BERT[:EVENT]?
```

This command returns the decimal value of the sum of the bits in the Data Questionable BERT Event Register. For example, if no clock signal for the bit error rate tests has not been input for more than three seconds (bit 0), then a 1 is returned. Note that the register requires that the equivalent PTR or NTR filters be set before a condition register bit can set a bit in the Event register. Note also that the data in this register is latched until it is queried. Once queried, the data is cleared.

## Data Questionable BERT Status Negative Transition Filter Register Enable

```
:STATus:QUESTionable:BERT:NTRansition <num>  
:STATus:QUESTionable:BERT:NTRansition?
```

This command determines what bits in the Data Questionable BERT Status Group Condition Register will set the corresponding bit in the Data Questionable BERT Status Group Event Register when that bit has a negative transition (1 to 0). The variable <num> is the sum of the decimal values of the bits that you want to enable.

## Data Questionable BERT Status Positive Transition Filter Register Enable

```
:STATus:QUESTionable:BERT:PTRansition <num>  
:STATus:QUESTionable:BERT:PTRansition?
```

This command determines what bits in the Data Questionable BERT Status Group Condition Register will set the corresponding bit in the Data Questionable BERT Status Group Event Register when that bit has a positive transition (0 to 1). The variable <num> is the sum of the decimal values of the bits that you want to enable.

## Data Questionable Calibration Status Group Condition Register Query

```
:STATus:QUESTionable:CALibration:CONDition?
```

This command returns the decimal value of the sum of the bits in the Data Questionable Calibration Condition Register. For example, if the DCFM or DCΦM zero calibration fails (bit 0), then a value of 1 is returned. Note that the data in this register is continuously updated and reflects the current conditions.

## Data Questionable Calibration Status Group Enable

```
:STATus:QUESTionable:CALibration:ENable <num>  
:STATus:QUESTionable:CALibration:ENable?
```

This command determines what bits in the Data Questionable Calibration Status Group Event Register will set the Data Questionable Calibration Summary bit (bit 8) in the Data Questionable Status Group Condition Register. The variable <num> is the sum of the decimal values of the bits you want to enable.

## Data Questionable Calibration Status Group Event Register Query

```
:STATus:QUESTionable:CALibration[:EVENT]?
```

This command returns the decimal value of the sum of the bits in the Data Questionable Calibration Event Register. For example, if the DCFM or DCΦM zero calibration has failed (bit 0), then a 1 is returned. Note that the register requires that the equivalent PTR or NTR filters be set before a condition register bit can set a bit in the Event register. Note also that the data in this register is latched until it is queried. Once queried, the data is cleared.

## Data Questionable Calibration Status Negative Transition Filter Register Enable

```
:STATus:QUESTionable:CALibration:NTRansition <num>  
:STATus:QUESTionable:CALibration:NTRansition?
```

This command determines what bits in the Data Questionable Calibration Status Group Condition Register will set the corresponding bit in the Data Questionable Calibration Status Group Event Register when that bit has a negative transition (1 to 0). The variable <num> is the sum of the decimal values of the bits that you want to enable.

## Data Questionable Calibration Status Positive Transition Filter Register Enable

```
:STATus:QUESTionable:CALibration:PTRansition <num>  
:STATus:QUESTionable:CALibration:PTRansition?
```

This command determines what bits in the Data Questionable Calibration Status Group Condition Register will set the corresponding bit in the Data Questionable Calibration Status Group Event Register when that bit has a positive transition (0 to 1). The variable <num> is the sum of the decimal values of the bits that you want to enable.

## Data Questionable Condition Positive Transition Filter Register Enable

```
:STATus:QUESTionable:PTRansition <num>  
:STATus:QUESTionable:PTRansition?
```

This command determines what bits in the Data Questionable Status Group Condition Register will set the corresponding bit in the Data Questionable Status Group Event Register when that bit has a positive transition (0 to 1). The variable <num> is the sum of the decimal values of the bits that you want to enable.

## Data Questionable Condition Query

```
:STATus:QUESTionable:CONDition?
```

This command returns the decimal value of the sum of the bits in the Data Questionable Condition Register. For example, if a Reference Oscillator Oven (ESG-AP, ESG-DP, and Option 1E5 only) is cold (bit 4), then a value of 16 is returned. Note that the data in this register is continuously updated and reflects current conditions.

## Data Questionable Frequency Status Group Condition Register Query

```
:STATus:QUESTionable:FREQuency:CONDition?
```

This command returns the decimal value of the sum of the bits in the Data Questionable Frequency Condition Register. For example, if the 1 GHz internal reference clock is unlocked (bit 2), then a value of 4 is returned. Note that the data in this register is continuously updated and reflects the current conditions.

## Data Questionable Frequency Status Group Enable

```
:STATus:QUESTionable:FREQuency:ENable <num>  
:STATus:QUESTionable:FREQuency:ENable?
```

This command determines what bits in the Data Questionable Frequency Status Group Event Register will set the Data Questionable Frequency Summary bit (bit 5) in the Data Questionable Status Group Condition Register. The variable <num> is the sum of the decimal values of the bits you want to enable.

## Data Questionable Frequency Status Group Event Register Query

```
:STATus:QUESTionable:FREQuency[:EVENT]?
```

This command returns the decimal value of the sum of the bits in the Data Questionable Frequency Event Register. For example, if the 1 GHz internal reference clock is unlocked (bit 2), then a value of 4 is returned. Note that the register requires that the equivalent PTR or NTR filters be set before a condition register bit can set a bit in the Event register. Note also that the data in this register is latched until it is queried. Once queried, the data is cleared.

## Data Questionable Frequency Status Negative Transition Filter Register Enable

```
:STATus:QUESTionable:FREQuency:NTRansition <num>  
:STATus:QUESTionable:FREQuency:NTRansition?
```

This command determines what bits in the Data Questionable Frequency Status Group Condition Register will set the corresponding bit in the Data Questionable Frequency Status Group Event Register when that bit has a negative transition (1 to 0). The variable <num> is the sum of the decimal values of the bits that you want to enable.

## Data Questionable Frequency Status Positive Transition Filter Register Enable

```
:STATus:QUESTionable:FREQuency:PTRansition <num>  
:STATus:QUESTionable:FREQuency:PTRansition?
```

This command determines what bits in the Data Questionable Frequency Status Group Condition Register will set the corresponding bit in the Data Questionable Frequency Status Group Event Register when that bit has a positive transition (0 to 1). The variable <num> is the sum of the decimal values of the bits that you want to enable.

## Data Questionable Modulation Status Group Condition Register Query

```
:STATus:QUESTionable:MODulation:CONDition?
```

This command returns the decimal value of the sum of the bits in the Data Questionable Modulation Condition Register. Note that the data in this register is continuously updated and reflects the current conditions.

## Data Questionable Modulation Status Group Enable

```
:STATus:QUESTionable:MODulation:ENABLE <num>
:STATus:QUESTionable:MODulation:ENABLE?
```

This command determines what bits in the Data Questionable Modulation Status Group Event Register will set the Data Questionable Modulation Summary bit (bit 7) in the Data Questionable Status Group Condition Register. The variable <num> is the sum of the decimal values of the bits you want to enable.

## Data Questionable Modulation Status Group Event Register Query

```
:STATus:QUESTionable:MODulation[:EVENT]?
```

This command returns the decimal value of the sum of the bits in the Data Questionable Modulation Event Register. For example, if the External 1 AC modulation is selected with no modulation connected, a Modulation 1 Undermod condition exists (bit 0), then a value of 1 is returned. Note that the register requires that the equivalent PTR or NTR filters be set before a condition register bit can set a bit in the Event register. Note also that the data in this register is latched until it is queried. Once queried, the data is cleared.

## Data Questionable Modulation Status Negative Transition Filter Register Enable

```
:STATus:QUESTionable:MODulation:NTRansition <num>
:STATus:QUESTionable:MODulation:NTRansition?
```

This command determines what bits in the Data Questionable Modulation Status Group Condition Register will set the corresponding bit in the Data Questionable Modulation Status Group Event Register when that bit has a negative transition (1 to 0). The variable <num> is the sum of the decimal values of the bits that you want to enable.

## Data Questionable Modulation Status Positive Transition Filter Register Enable

```
:STATus:QUESTionable:MODulation:PTRansition <num>
:STATus:QUESTionable:MODulation:PTRansition?
```

This command determines what bits in the Data Questionable Modulation Status Group Condition Register will set the corresponding bit in the Data Questionable Modulation Status Group Event Register when that bit has a positive transition (0 to 1). The variable <num> is the sum of the decimal values of the bits that you want to enable.

## Data Questionable Power Status Group Condition Register Query

```
:STATus:QUESTionable:POWER:CONDition?
```

This command returns the decimal value of the sum of the bits in the Data Questionable Power Condition Register. For example, if the RF output signal is unlevelled (bit 1), then a value of 2 is returned. Note that the data in this register is continuously updated and reflects the current conditions.

## Data Questionable Power Status Group Enable

```
:STATus:QUESTionable:POWER:ENable <num>  
:STATus:QUESTionable:POWER:ENable?
```

This command determines what bits in the Data Questionable Power Status Group Event Register will set the Data Questionable Power Summary bit (bit 3) in the Data Questionable Status Group Condition Register. The variable <num> is the sum of the decimal values of the bits you want to enable.

## Data Questionable Power Status Group Event Register Query

```
:STATus:QUESTionable:POWER[:EVENT]?
```

This command returns the decimal value of the sum of the bits in the Data Questionable Power Event Register. For example, if the RF output signal is unlevelled (bit 1), then a value of 2 is returned. Note that the register requires that the equivalent PTR or NTR filters be set before a condition register bit can set a bit in the Event register. Note also that the data in this register is latched until it is queried. Once queried, the data is cleared.

## Data Questionable Power Status Negative Transition Filter Register Enable

```
:STATus:QUESTionable:POWER:NTRansition <num>  
:STATus:QUESTionable:POWER:NTRansition?
```

This command determines what bits in the Data Questionable Power Status Group Condition Register will set the corresponding bit in the Data Questionable Power Status Group Event Register when that bit has a negative transition (1 to 0). The variable <num> is the sum of the decimal values of the bits that you want to enable.

## Data Questionable Power Status Positive Transition Filter Register Enable

```
:STATus:QUESTionable:POWER:PTRansition <num>  
:STATus:QUESTionable:POWER:PTRansition?
```

This command determines what bits in the Data Questionable Power Status Group Condition Register will set the corresponding bit in the Data Questionable Power Status Group Event Register when that bit has a positive transition (0 to 1). The variable <num> is the sum of the decimal values of the bits that you want to enable.

## Data Questionable Status Group Enable

```
:STATus:QUESTionable:ENABLE <num>  
:STATus:QUESTionable:ENABLE?
```

This command determines what bits in the Data Questionable Status Group Event Register will set the Data Questionable Status Group Summary bit (bit 3) in the Status Byte Register. The variable <num> is the sum of the decimal values of the bits you want to enable.



## Data Questionable Status Group Event Register Query

```
:STATus:QUEStionable[:EVENT]?
```

This command returns the decimal value of the sum of the bits in the Data Questionable Event Register. For example, if the instrument has just been connected to line power and the Reference Oscillator Oven (ESG-AP, ESG-DP, and Option 1E5 only) is cold (bit 4), then a value of 16 is returned. Note that the register requires that the equivalent PTR or NTR filters be set before a condition register bit can set a bit in the Event register. Note also that the data in this register is latched until it is queried. Once queried, the data is cleared.

## Data Questionable Status Negative Transition Filter Register Enable

```
:STATus:QUEStionable:NTRansition <num>
:STATus:QUEStionable:NTRansition?
```

This command determines what bits in the Data Questionable Status Group Condition Register will set the corresponding bit in the Data Questionable Status Group Event Register when that bit has a negative transition (1 to 0). The variable <num> is the sum of the decimal values of the bits that you want to enable.

## Standard Operation Status Group Condition Register Query

```
:STATus:OPERation:CONDition?
```

This command returns the decimal value of the sum of the bits in the Standard Operation Status Group Event Register. For example, if a sweep is in progress (bit 3), then the value 8 is returned.

## Standard Operation Status Group Enable

```
:STATus:OPERation:ENable <num>
:STATus:OPERation:ENable?
```

This command determines what bits in the Standard Operation Status Group Event Register will set the Standard Operation Status Group Summary bit (bit 7) in the Status Byte Register. The variable <num> is the sum of the decimal values of the bits you want to enable.

## Standard Operation Status Group Event Register Query

```
:STATus:OPERation[:EVENT]?
```

This command returns the decimal value of the sum of the bits in the Standard Operation Event Register. For example, if a sweep is in progress (bit 3), then the value 8 is returned. Note that the register requires that the equivalent PTR or NTR filters be set before a condition register bit can set a bit in the event register. Also note that the data in the register is latched until it is queried. Once queried, the data is cleared.

## **Standard Operation Status Group Negative Transition Filter Register Enable**

```
:STATus:OPERation:NTRansition <num>  
:STATus:OPERation:NTRansition?
```

This command determines what bits in the Standard Operation Status Group Event Register will set the corresponding bit in the Standard Operation Status Group Event Register when that bit has a negative transition (1 to 0). The variable <num> is the sum of the decimal values of the bits that you want to enable.

## **Standard Operation Status Group Positive Transition Filter Register Enable**

```
:STATus:OPERation:PTRansition <num>  
:STATus:OPERation:PTRansition?
```

This command determines what bits in the Standard Operation Status Group Event Register will set the corresponding bit in the Standard Operation Status Group Event Register when that bit has a positive transition (0 to 1). The variable <num> is the sum of the decimal values of the bits that you want to enable.

---

## :SWEep Subsystem

The sweep subsystem is used to set the controls and the parameters associated with a frequency and/or power sweep.

### Sweep Dwell

```
:SWEep:DWELl <val>  
:SWEep:DWELl?
```

This command sets the dwell time for each point in a sweep. The choices for the variable <val> are 0.001 seconds to 60 seconds in 1 ms increments. Dwell time is used when the point trigger is **Immediate**. The dwell time is the minimum amount of time the sweep is guaranteed to pause after setting the frequency and power for the current point.

\*RST Value: 0.002 seconds

### Sweep Points

```
:SWEep:POINTs <val>  
:SWEep:POINTs?
```

This command defines the number of points in a step sweep. The choices for the variable <val> range from 2 to 401. A step sweep must always have a minimum of 2 points and can be configured to have as many as 401 points.

\*RST Value: 2

---

## :SYSTem Subsystem

The system subsystem is used to set the controls and the parameters associated with overall system communication.

### Error Information Query

```
:SYSTem:ERRor[:NEXT]?
```

This command queries the signal generator's error queue.

### Help Mode

```
:SYSTem:HELp:MODE SINGLE|CONTinuous  
:SYSTem:HELp:MODE?
```

This command sets the mode of the signal generator's help function. The choices are Single and Continuous. In Single mode, help is provided only for the next key that you press. In Continuous mode, help is provided for the next key you press and that key's function is also executed (except for the Preset key). In either mode, pressing the Help key while the help dialog box is displayed will turn help off.

The help mode is a persistent state; it is not affected by an instrument preset or by a power cycle.

### Persistent State and Instrument State Reset

```
:SYSTem:PRESet:ALL
```

This command sets the persistent state and the instrument state values to their factory defaults.

### Persistent State Reset

```
:SYSTem:PRESet:PERsistent
```

This command sets the persistent state values to their factory defaults.

### PN9 Preset Configuration (Option UN8)

```
:SYSTem:PRESet:PN9 NORMal|QUICK  
:SYSTem:PRESet:PN9?
```

This command sets the preset value for the PN9 mode. The choices are Normal and Quick. PN9 mode applies only to personalities that require software PRBS generation.

This is a persistent state with no initial values, shipped from the factory with this parameter set to Normal.

## Power On/Preset Conditions

```
:SYSTEM:PON:TYPE PRESet | LAST
:SYSTEM:PON:TYPE?
```

This command sets the defined instrument conditions after a power on. The choices are Preset (the factory preset conditions) or Last (the conditions at the time the instrument was powered down).

This is a persistent state. There are no initial values. The instrument is initially shipped from the factory with this parameter set to Last.

## Preset Language

```
:SYSTEM:PRESet:LANGUage "SCPI" | "COMP" | "NADC" | "PDC" | "PHS" | "8648"
:SYSTEM:PRESet:LANGUage?
```

This command sets the remote language at the preset condition. The choices are SCPI, COMP, NADC, PDC, PHS, and 8648 compatible.

The preset language is a persistent state; it is not affected by an instrument preset or by a power cycle. The signal generator is shipped from the factory with this parameter set to SCPI.

COMP is for 8656/8657A/B compatibility.

NADC is for 8657D compatibility. (Option UN8)

PDC is for 8657D compatibility. (Option UN8)

PHS is for 8657J compatibility. (Option UN8)

8648 is for 8648A/B/C/D compatibility.

## Preset Save

```
:SYSTEM:PRESet[:USER]:SAVE
```

This command saves your user-defined preset state.

The user's state definition is a state file; it is not affected by an instrument preset or by a power cycle.

## Preset Type

```
:SYSTEM:PRESet:TYPE NORMal | USER
:SYSTEM:PRESet:TYPE?
```

This command toggles the preset state between factory-defined conditions and user-defined conditions. The choices are Normal and User.

This is a persistent state set to Normal at the factory.

## Remote Language

```
:SYSTem:LANGUage "SCPI" | "COMP" | "NADC" | "PDC" | "PHS" | "8648"  
:SYSTem:LANGUage?
```

This command sets the remote language for the signal generator. The choices are SCPI, COMP, NADC, PDC, PHS, or 8648 compatible.

COMP is for 8656/8657A/B compatibility.

NADC is for 8657D compatibility. (Option UN8)

PDC is for 8657D compatibility. (Option UN8)

PHS is for 8657J compatibility. (Option UN8)

8648 is for 8648A/B/C/D compatibility.

\*RST Value: based on the value of the :SYSTem:PRESet:LANGUage setting.

## SCPI Capability Query

```
:SYSTem:CAPability?
```

This command queries the signal generator's capabilities and outputs the instrument specifier:

```
(RFSOURCE WITH( (AM|FM|PULM|PM|LFO)&(FSSWEEP|FLIST)&(PSSWEEP|PLIST)  
&TRIGGER&REFERENCE))
```

This is a list of the SCPI-defined basic functionality of the instrument and the additional capabilities it has in parallel (a&b) and singularly (a | b).

## SCPI Version

```
:SYSTem:VERSion?
```

This command returns the SCPI version number with which the instrument complies.

## Screen Saver Delay

```
:SYSTem:SSAVer:DELay <val>  
:SYSTem:SSAVer:DELay?
```

This command sets the amount of time (in hours) before the display light or text (see next command, “[Screen Saver Mode](#)”) is switched off, if there is no input via the front panel. The choices for the variable <val> are the numbers 1 through 12, in 1 hour increments.

Screen saver delay is a persistent state; it is not affected by an instrument preset or by a power cycle. The signal generator is shipped from the factory with this parameter set to 1.

## Screen Saver Mode

```
:SYSTem:SSAVer:MODE LIGHT|TEXT  
:SYSTem:SSAVer:MODE?
```

This command toggles the screen saver mode the choices are

Light Only and Light & Text.

Screen saver mode is a persistent state; it is not affected by an instrument preset or by a power cycle. The signal generator is shipped from the factory with this parameter set to Light Only.

## Screen Saver State

```
:SYSTem:SSAVer:STATE ON|OFF|1|0  
:SYSTem:SSAVer:STATE?
```

This command sets the operating state of the screen saver. The choices are On (1) and Off (0).

Screen saver state is a persistent state; it is not affected by an instrument preset or by a power cycle. The signal generator is shipped from the factory with this parameter set to Off.

## System Preset

```
:SYSTem:PRESet
```

This command returns the signal generator to a set of defined conditions.

---

## :TRIGger Subsystem

The trigger subsystem is used to set the controls and the parameters associated with triggering a sweep in the signal generator.

### Abort

:ABORt

There is no query for this command.

This command causes the sweep in progress to abort and reset, causes the bit error rate (BER) measurement in progress to abort and set the BER measurement state to Off. If INIT:CONT is ON, then the sweep will immediately reinitiate. The pending operation flag (affecting \*OPC, \*WAI, and \*OPC?) will undergo a transition once the sweep has been reset.

### Continuous Sweep

:INITiate:CONTinuous[:ALL] ON|OFF|1|0  
:INITiate:CONTinuous[:ALL]?

This command activates the continuous sweep mode. The choices are On (1) or Off (0).

Modifying this value does not affect the sweep in progress. Executing this command with ON causes the sweep to be automatically restarted at the end of the previous sweep. Executing this command with OFF causes the sweep to wait until an :INITiate[:IMMediate] command is sent to reinitiate the sweep.

\*RST Value: Off

### External Trigger On Slope

:TRIGger[:SEQuence]:SLOPe POSitive|NEGative  
:TRIGger[:SEQuence]:SLOPe?

This command sets the polarity of the slope present at the TRIGGER IN connector that will trigger a sweep in the signal generator. The choices are Positive edge and Negative edge.

\*RST Value: Positive

### Immediate Trigger

:TRIGger[:SEQuence][:IMMediate]  
There is no query for this command.

This command has no effect unless sweep is waiting for a trigger. If sweep is waiting for a trigger (sweep or point-to-point) then this command triggers the sweep, regardless of other settings in the :SWEep subsystem.



## Single Sweep

```
:INITiate[:IMMediate][:ALL]
```

There is no query for this command.

This command initiates a single sweep if the sweep is on for either frequency or power, and the sweep is not already initiated.

## Trigger Output Polarity

```
:TRIGger:OUTPut:POLarity POSitive|NEGative
```

```
:TRIGger:OUTPut:POLarity?
```

This command sets the polarity of the TTL signal present at the TRIGGER OUT connector. The choices are Positive and Negative. The Trigger out is asserted (after the frequency and/or power is set) while the sweep is waiting for its step trigger. Also, the swept-sine sends a pulse to the TRIGGER OUT at the beginning of each sweep.

\*RST Value: Positive

## Trigger Source

```
:TRIGger[:SEQuence]:SOURce BUS|IMMediate|EXTernal|KEY
```

```
:TRIGger[:SEQuence]:SOURce?
```

This command sets the trigger source. The choices are Bus (allows you to trigger a list or step sweep via GPIB), Immediate (immediately triggers the current sweep once it is armed), External (Pos and Neg) (allows you to trigger a list or step sweep on the positive or negative edge of a signal applied to the TRIGGER IN connector), or Key (immediately triggers an armed sweep when you press the Trigger hardkey).

\*RST Value: Immediate

---

## Using the Example Programs

The example programs are interactive. They require active participation by the operator. To gain an understanding of the principles without following all of the instructions, read the “Program Comments” sections to follow the programmed activity.

The GPIB select code is assumed to be preset to 7. All example programs in this section expect the signal generator’s GPIB address to be decimal 19.

To verify the signal generator’s current GPIB address, press **Utility > GPIB/RS-232 > GPIB Address**.

The active entry area indicates the present GPIB address. If the number displayed is not 19, press **19** on the numeric keypad and then press **Enter** to set the address to 19.

Now check that the interface language is set to SCPI. Press **Utility > GPIB/RS-232 > Remote Language**. The selected interface language is then shown. If the instrument’s remote language is not set to SCPI, press **Utility > GPIB/RS-232 > Remote Language > SCPI**.

---

## GPIB Check, Example Program 1

Verify that the remote annunciator (R) is activated on the signal generator's display. If it is not, verify that the signal generator's address is set to 19 and that the interface cable is properly connected.

If the controller display indicates an error message, it is possible that the program was typed incorrectly. If the controller accepts the REMOTE statement but the signal generator's remote annunciator does not appear on the display, refer to the service guide for troubleshooting information.

This program verifies that the GPIB connections and interface are functional. Connect a controller to the signal generator using an GPIB cable. CLEAR and RESET the controller and type in the following commands and RUN the program:

```

10  !*****
20  !
30  ! PROGRAM NAME: GPIB_CK                      Rev. 2A796
40  !
50  ! PROGRAM DESCRIPTION: This program verifies that the GPIB connections and
60  !                       interface are functional.
70  !
80  !                       Connect a controller to the signal generator using an
90  ! GPIB cable.
100 !
110 ! CLEAR and RESET the controller and type in the following commands and RUN
120 ! the program:
130 !
140 !*****
150 !
160 Sig_gen=719
170 LOCAL Sig_gen
180 CLEAR Sig_gen
190 CLEAR SCREEN
200 OUTPUT Sig_gen;"*RST"
210 REMOTE Sig_gen
220 PRINT "The signal generator should now be in REMOTE."
230 PRINT
240 PRINT "Verify that the remote [R] annunciator is on. Press the 'Local' key, "
250 PRINT "on the front panel, to return the signal generator to LOCAL control."
260 PRINT
270 PRINT "Press RUN to start again."
280 END





```

## Program Comments

10 to 150:	Title and program description
160:	Sets up a variable to contain the GPIB address of the source.
170:	Places the signal generator into LOCAL mode.
180:	Resets the signal generator's parser and clears any pending output from the source.
190:	Clears the controller's display.
200:	Sets the signal generator to a defined state.
210:	Sets the signal generator to REMOTE mode.
220 to 270:	Prints messages to the controller's display.
280:	Ends the program.

---

## Local Lockout Demonstration, Example Program 2

When the signal generator is in REMOTE mode, all the front panel keys are disabled except for the **Local**, , and  keys. But, when the LOCAL LOCKOUT command is sent, the **Local** key also is disabled  and  only and are allowed. The LOCAL command, executed from the controller, is then the only way to return all (or selected) instruments to front-panel control.

CLEAR and RESET the controller, type the following commands, and RUN the program.

```

10  !*****
20  !
30  ! PROGRAM NAME:                LCLLCK_OT                Rev.  2A796
40  !
50  ! PROGRAM DESCRIPTION:  When the signal generator is in REMOTE mode, all
60  !                       functional front panel keys are disabled except for
70  !                       the Local and Contrast keys.  But, when the LOCAL LOCKOUT
80  !                       command is set on the bus, even the Local key is disabled.
90  !                       The LOCAL command, executed from the controller, is then
100 !                       the only way to return the signal generator to front panel,
110 !                       LOCAL, control.
120 !
130 ! Continue by building upon Example Program #1; GPIB CHECK:
140 !
150 !*****
160 !
170 Sig_gen=719
180 CLEAR Sig_gen
190 LOCAL Sig_gen
200 REMOTE Sig_gen
210 CLEAR SCREEN
220 OUTPUT Sig_gen;"*RST"
230 PRINT "The signal generator should now be in REMOTE."
240 PRINT
250 PRINT "Verify that all keys are ignored, except the 'Local' and 'Contrast' keys."
260 PRINT
270 PRINT "Verify that pressing 'Local' causes the remote [R] annunciator to go OFF."
280 PRINT
290 PRINT "..... Press Continue"
300 PAUSE
310 REMOTE Sig_gen
320 LOCAL LOCKOUT 7
330 PRINT
340 PRINT "Signal generator should now be in LOCAL LOCKOUT mode."
350 PRINT

```

**Local Lockout Demonstration, Example Program 2**

```

360 PRINT "Verify that all keys including 'Local' (except Contrast keys) have no effect."
370 PRINT
380 PRINT "..... Press Continue"
390 PAUSE
400 PRINT
410 LOCAL 7
420 PRINT "Signal generator should now be in LOCAL mode."
430 PRINT
440 PRINT "Verify that the signal generator's front-panel keyboard is functional."
450 PRINT
460 PRINT "Press RUN to start again."
470 END

```

**Program Comments**

10 to 160:	Title and program description
170:	Sets up a variable to contain the GPIB address of the source.
180:	Resets the signal generator's parser and clears any pending output from the source.
190:	Places the signal generator into LOCAL mode.
200:	Sets the signal generator to REMOTE mode.
210:	Clears the controller's display.
220:	Sets the signal generator to a defined state.
230 to 300:	Prints messages on the computer's display, then pauses.
310:	Places the signal generator into REMOTE mode.
320:	Places the signal generator into LOCAL LOCKOUT mode.
330 to 400:	Prints a message on the computer's display, then pauses.
410:	Returns the signal generator to LOCAL control.
420 to 460:	Prints messages on the computer's display.
470:	Ends the program.

---

## Using Queries, Example Program 3

In this example, query commands are used with response data formats.

CLEAR and RESET the controller and run the following program:

```

10  !*****
20  !
30  ! PROGRAM NAME:   QUERIES                               Rev. 2A796
40  !
50  ! PROGRAM DESCRIPTION:  In this example, query commands are used with response
60  !                       data formats.
70  !
80  ! CLEAR and RESET the controller and RUN the following program:
90  !
100 !*****
110 !
120 DIM A$(10),C$(100),D$(10)
130 INTEGER B
140 Sig_gen=719
150 LOCAL Sig_gen
160 CLEAR Sig_gen
170 CLEAR SCREEN
180 OUTPUT Sig_gen;"*RST"
190 OUTPUT Sig_gen;"FREQ:CW?"
200 ENTER Sig_gen;F
210 PRINT "Present source CW frequency is: ";F/1.E+6;"MHz"
220 PRINT
230 OUTPUT Sig_gen;"POW:AMPL?"
240 ENTER Sig_gen;W
250 PRINT "Current power setting is: ";W;"dBm"
260 PRINT
270 OUTPUT Sig_gen;"FREQ:MODE?"
280 ENTER Sig_gen;A$
290 PRINT "Source's frequency mode is: ";A$
300 PRINT
310 B=0
320 !OUTPUT Sig_gen;"OUTP:MOD OFF"
330 OUTPUT Sig_gen;"OUTP:MOD:STAT?"
340 ENTER Sig_gen;B
350 IF B>0 THEN
360     PRINT "Modulation is: ON"
370 ELSE
380     PRINT "Modulation is: OFF"
390 END IF

```

```

400 OUTPUT Sig_gen;"*IDN?"
410 ENTER Sig_gen;C$
420 PRINT
430 PRINT "This signal generator is a ";C$
440 PRINT
450 OUTPUT Sig_gen;"SYST:COMM:GPIB:ADDR?"
460 ENTER Sig_gen;D$
470 PRINT "The GPIB Address is ";D$
480 PRINT
490 PRINT "Press the 'Local' key to return the instrument to LOCAL control"
500 PRINT "or Press RUN to start again."
510 END

```

## Program Comments

10 to 110:	Title and program description
120:	Dimension string A\$, string C\$, and string D\$ variables to contain responses.
130:	Declares variable B as an integer.
140:	Assigns the signal generator's GPIB address to a variable.
150:	Places the signal generator into LOCAL mode.
160:	Resets the signal generator's parser and clears any pending output from the source.
170:	Clears the controller's display.
180:	Sets the signal generator to a defined state.
190:	Queries the value of the signal generator's CW frequency.
200:	Enters the query response into the variable F. The response is always returned in fundamental units (Hz, in the case of frequency).
210 to 220:	Prints the instrument's current source frequency (in MHz) to the controller's display.
230:	Queries the value of the signal generator's CW power.
240:	Enters the query response into the variable W.
250 to 260:	Prints the instrument's current source power (in dBm) to the controller's display.
270:	Queries the value of a discrete function, <code>FREQ:MODE</code> .
280:	Enter the response into A\$. The response will be a string that represents the function's present state.
290 to 300:	Prints the value of A\$ on the computer's display.
310:	Assigns a value of 0 to B variable.
320:	Commented command for turning off modulation
330:	Queries the on/off state for modulation.
340:	Enters value for the modulation state.



350 to 390:	Determines the on/off modulation state and displays the results on the controller's display.
400:	Queries the signal generator's identity.
410:	Enters the response into C\$. The response will be a string that represents the signal generator's model and options.
420 to 440:	Prints the value of C\$ (the signal generator's model and options) on the computer's display.
450:	Queries the signal generator's GPIB address.
460:	Enters the response into D\$. The response will be a string that represents the signal generator's GPIB address.
470 to 480:	Prints the value of D\$ (the signal generator's GPIB address) on the computer's display.
490 to 500:	Prints messages to the controller's display.
510:	Ends the program.

---

## Generating a CW Signal, Example Program 4

In this example, a CW signal is generated at a frequency of 500 kHz with a power level of -2.1 dBm. CLEAR and RESET the controller and then run the following program:

```
10  !*****
20  !
30  ! PROGRAM NAME:   SIGNAL_CW                      Rev.  2A796
40  !
50  ! PROGRAM DESCRIPTION:  In this example, a CW signal is generated at a
60  !                       frequency of 500 kHz with a power level of -2.1 dBm.
70  !
80  ! CLEAR and RESET the controller and type in the following commands and RUN
90  ! the program:
100 !
110 !*****
120 !
130 Sig_gen=719
140 LOCAL Sig_gen
150 CLEAR Sig_gen
160 CLEAR SCREEN
170 OUTPUT Sig_gen;"*RST"
180 OUTPUT Sig_gen;"FREQ 500 kHz"
190 PRINT
200 OUTPUT Sig_gen;"POW:AMPL -2.1 dBm"
210 PRINT
220 OUTPUT Sig_gen;"OUTP:STAT ON"
230 PRINT
240 LOCAL Sig_gen
250 PRINT "Press RUN to start again."
260 END
```

## Program Comments

10 to 120:	Title and program description
130:	Assigns the signal generator's GPIB address to a variable.
140:	Places the signal generator into LOCAL mode.
150:	Resets the signal generator's parser and clears any pending output from the source.
160:	Clears the controller's display.
170:	Sets the signal generator to a defined state for programming.
180 to 190:	Sets the frequency to 500 kHz.
200 to 210:	Sets the signal generator's power level to -2.1 dBm.
220 to 230:	Turns the RF output on.
240:	Returns the signal generator to LOCAL mode.
250:	Prints a message to the controller's display.
260:	Ends the program.

## Generating an AC-Coupled External FM Signal, Example Program 5

In this example, an AC-coupled FM signal will be generated at a carrier frequency of 700 MHz with a power level of  $-25$  dBm and a deviation of 20 kHz. In order to accomplish this, connect the output of a modulating signal source to the signal generator's EXT 2 connector, set the modulation signal source for the desired FM characteristics, and then run the following program:

```

10  !*****
20  !
30  ! PROGRAM NAME:   EXT_FM   AC-COUPLED                      Rev. 2A796
40  !
50  ! PROGRAM DESCRIPTION:  In this example, an AC-coupled FM signal will be
60  !                       generated at a carrier frequency of 700 MHz with a
70  !                       power level of -25 dBm and a deviation of 20 kHz.
80  !                       In order to accomplish this, connect the output of a
90  !                       modulating signal source to the signal generator's
100 !                       EXTERNAL 2 INPUT connector.
110 !
120 !                       Set the modulation signal source for the desired FM
130 !                       rate and correct 1 Vpk amplitude (HI/LO indication).
140 !
150 ! CLEAR and RESET the controller and type in the following commands and RUN
160 ! the program:
170 !
180 !*****
190 !
200 Sig_gen=719
210 LOCAL Sig_gen
220 CLEAR Sig_gen
230 CLEAR SCREEN
240 OUTPUT Sig_gen;"*RST"
250 OUTPUT Sig_gen;"FM:SOUR EXT2"
260 OUTPUT Sig_gen;"FM:EXT2:COUP AC"
270 OUTPUT Sig_gen;"FM:DEV 20 kHz"
280 OUTPUT Sig_gen;"FREQ 700 MHz"
290 OUTPUT Sig_gen;"POW:AMPL -25 dBm"
300 OUTPUT Sig_gen;"FM:STAT ON"
310 OUTPUT Sig_gen;"OUTP:STAT ON"
320 PRINT
330 PRINT "Press RUN to start again."
340 LOCAL Sig_gen
350 END

```

## Program Comments

10 to 190:	Title and program description
200:	Assigns the signal generator's GPIB address to a variable.
210:	Places the signal generator into LOCAL mode.
220:	Resets the signal generator's parser and clears any pending output from the source.
230:	Clears the controller's display.
240:	Sets the signal generator to a defined state.
250:	Sets External 2 source to frequency modulation.
260:	Sets FM path 2 coupling to AC.
270:	Sets FM path 2 deviation to 20 kHz.
280:	Sets the carrier frequency to 700 MHz.
290:	Sets the carrier output power level to -25 dBm.
300:	Turns on the frequency modulation.
310:	Turns on the RF output.
320 to 330:	Prints a message to the controller's display.
340:	Places the signal generator into LOCAL mode.
360:	Ends the program.

---

## Generating an AC-Coupled Internal FM Signal, Example Program 6

In this example, an AC-coupled internal FM signal will be generated at a carrier frequency of 900 MHz with a power level of -15 dBm. The FM rate will be 5 kHz and the peak deviation will be 100 kHz. CLEAR and RESET the controller, type the following commands, and RUN the program:

```
10  !*****
20  !
30  ! PROGRAM NAME:  INT_FM                      REV. 2A796
40  !
50  ! PROGRAM DESCRIPTION:  In this example, an internal FM signal will be
60  !                       generated at a carrier frequency of 900 MHz with a
70  !                       power level of -15 dBm.  The FM rate will be 5 kHz
80  !                       and the FM peak deviation will be 100 kHz.
90  !
100 ! CLEAR and RESET the controller and type in the following commands and RUN
110 ! the program:
120 !
130 !*****
140 !
150 Sig_gen=719
160 LOCAL Sig_gen
170 CLEAR Sig_gen
180 CLEAR SCREEN
190 OUTPUT Sig_gen;"*RST"
200 OUTPUT Sig_gen;"FM2:INT:FREQ 5 kHz"
210 OUTPUT Sig_gen;"FM2:DEV 100 kHz"
220 OUTPUT Sig_gen;"FREQ 900 MHz"
230 OUTPUT Sig_gen;"POW -15 dBm"
240 OUTPUT Sig_gen;"FM2:STAT ON"
250 OUTPUT Sig_gen;"OUTP:STAT ON"
260 PRINT
270 PRINT "Press RUN to start again."
280 LOCAL Sig_gen
290 END
```

## Program Comments

10 to 140:	Title and program description
150:	Assigns the signal generator's GPIB address to a variable.
160:	Places the signal generator into LOCAL mode.
170:	Resets the signal generator's parser and clears any pending output from the source.
180:	Clears the controller's display.
190:	Sets the signal generator to a defined state for programming.
200:	Sets the path 2 internal FM source rate to 5 kHz.
210:	Sets the path 2 internal FM source deviation to 100 kHz.
220:	Sets the signal generator's carrier frequency to 900 MHz.
230:	Sets the signal generator's carrier power to -15 dBm.
240:	Turns on the frequency modulation.
250:	Turns on the signal generator's RF output.
260 to 270:	Prints a message to the controller's display.
280:	Places all the signal generator into LOCAL mode.
300:	Ends the program.

---

## Generating a Step-Swept Signal, Example Program 7

In this example, the signal generator will be programmed to continuously step sweep a defined set of points from 500 MHz to 800 MHz and dwell 500 ms at each of the points. The signal generator will then be set to LOCAL mode to allow the user to make adjustments from the front panel.

CLEAR and RESET the controller, type the following commands, and RUN the program.

```
10  !*****
20  !
30  ! PROGRAM NAME:   STEP_SWEEP                      Rev. 2A796
40  !
50  ! PROGRAM DESCRIPTION:  In this example, the generator will be setup to
60  !                      continuously step sweep a defined set of points from
70  !                      500 MHz to 800 MHz and dwell 500 ms at each of the
80  !                      points. The generator will then be set for local front
90  !                      panel control to allow the operator to make adjustments.
100 !
110 ! CLEAR and RESET the controller and type in the following commands and RUN
120 ! the program:
130 !
140 !*****
150 !
160 Sig_gen=719
170 LOCAL Sig_gen
180 CLEAR Sig_gen
190 CLEAR SCREEN
200 OUTPUT Sig_gen;"*RST"
210 OUTPUT Sig_gen;"*CLS"
220 OUTPUT Sig_gen;"FREQ:MODE LIST"
230 OUTPUT Sig_gen;"LIST:TYPE STEP"
240 OUTPUT Sig_gen;"FREQ:STAR 500 MHz"
250 OUTPUT Sig_gen;"FREQ:STOP 800 MHz"
260 OUTPUT Sig_gen;"SWE:POIN 10"
270 OUTPUT Sig_gen;"SWE:DWEL .5 S"
280 !OUTPUT Sig_gen;"INIT"           ! Used for single sweep
290 OUTPUT Sig_gen;"INIT:CONT ON"  ! ON for continuous sweep; OFF for single sweep
300 OUTPUT Sig_gen;"POW:AMPL -5 dBm"
310 OUTPUT Sig_gen;"OUTP:STAT ON"
320 PRINT "The signal generator is continuously step sweeping from"
330 PRINT "500 to 800 MHz. The generator is dwelling 500 ms per step"
340 PRINT "for the defined 10 steps."
350 WAIT 3
360 LOCAL Sig_gen
370 PRINT
```



```

380 PRINT "The signal generator is no longer in REMOTE."
390 PRINT
400 WAIT 3
410 PRINT "Press RUN to start again"
420 END

```

## Program Comments

10 to 150:	Title and program description
160:	Assigns the signal generator's GPIB address to a variable.
170:	Places the signal generator into LOCAL mode.
180:	Resets the signal generator's parser and clears any pending output from the source.
190:	Clears the controller's display.
200:	Sets the signal generator to a defined state for programming.
210:	Clears the signal generator's Status Byte Register.
220:	Sets the signal generator's frequency mode to LIST.
230:	Sets the signal generator's LIST type to STEP.
240:	Sets the signal generator's start frequency to 500 MHz.
250:	Sets the signal generator's stop frequency to 800 MHz.
260:	Sets the signal generator's frequency steps at 10 evenly-spaced points, starting at 500 MHz and ending at 800 MHz.
270:	Sets the signal generator's output signal to dwell at each of the ten points of 500 ms.
280:	Continuously initializes the signal generator sweep.
290:	Sets the signal generator to CONTINUOUS sweep mode.
300:	Sets the signal generator's RF output to -5 dBm.
310:	Turns on the signal generator's RF output.
320 to 340:	Prints a message to the controller's display.
350:	Waits 3 seconds.
360:	Returns the signal generator to LOCAL mode.
370 to 390:	Prints a message to the controller's display.
400:	Waits 3 seconds.
410:	Prints a message to the controller's display.
420:	Ends the program.

## Generating an External DC-Coupled Pulse Modulated Signal, Example Program 8

In this example, a repetitive, externally-triggered, pulse-modulated signal will be generated at a carrier frequency of 5 MHz with a power level of  $-5$  dBm. Connect an external pulse source to the EXT 2 INPUT on the signal generator and set the desired pulse characteristics.

CLEAR and RESET the controller, type the following commands and RUN the program.

```

10  !*****
20  !
30  !  PROGRAM NAME:    EXT_PULSE                      Rev.  2A796
40  !
50  !  PROGRAM DESCRIPTION:  In this example, a repetitive, externally-triggered,
60  !                          dc-coupled pulse modulated signal will be generated
70  !                          at a carrier frequency of 5 MHz with a power level of
80  !                          -5 dBm.  Connect an external pulse source to the EXT 2
90  !                          INPUT on the signal generator and set the desired pulse
100 !                          characteristics.
110 !
120 !  CLEAR and RESET the controller and type in the following commands and RUN
130 !  the program:
140 !
150 !*****
160 !
170 Sig_gen=719
180 LOCAL Sig_gen
190 CLEAR Sig_gen
200 CLEAR SCREEN
210 OUTPUT Sig_gen;"*RST"
220 OUTPUT Sig_gen;"PULM:SOUR EXT2"
230 OUTPUT Sig_gen;"PULM:STAT ON"
240 OUTPUT Sig_gen;"FREQ 5 MHz"
250 OUTPUT Sig_gen;"POW:ALC OFF"
260 OUTPUT Sig_gen;"POW:AMPL -5 dBm"
270 OUTPUT Sig_gen;"POW:ALC:SEAR ON"
280 OUTPUT Sig_gen;"OUTP:STAT ON"
290 PRINT
300 PRINT "Press RUN to start again."
310 LOCAL Sig_gen
320 END

```

## Program Comments

10 to 160:	Title and program description
170:	Assigns the signal generator's GPIB address to a variable.
180:	Places the signal generator into LOCAL mode.
190:	Resets the signal generator's parser and clears any pending output from the source.
200:	Clears the controller's display.
210:	Sets the signal generator to a defined state for programming.
220:	Sets the signal generator's pulse modulation source to EXT2.
230:	Turns pulse modulation on.
240:	Sets the carrier frequency to 5 MHz.
250:	Turns off the power leveling search to assist in maintaining the required power level.
260:	Sets the output power level to -5 dBm.
270:	Turns on the power leveling search to assist in maintaining the required power level.
280:	Turns the RF output on.
290 to 300:	Prints a message to the controller's display.
310:	Places the signal generator into LOCAL mode.
320:	Ends the program.

---

## Saving and Recalling States, Example Program 9

In this example, instrument settings are saved in the signal generator's registers. These settings can then be recalled separately; either from the keyboard or from the source's front panel.

CLEAR and RESET the controller, type the following commands, and RUN the program:

```
10  !*****
20  !
30  ! PROGRAM NAME:   REG_SAV                               Rev.  2A796
40  !
50  ! PROGRAM DESCRIPTION:  In this example, instrument settings are saved in the
60  !                       instrument's registers.  These settings can then be
70  !                       recalled separately either from the keyboard or from
80  !                       the front panel of the instrument.
90  !
100 ! CLEAR and RESET the controller and type in the following commands and RUN
110 ! the program:
120 !
130 !*****
150 DIM Clear$(10)
160 X=0
170 Sig_gen=719
180 LOCAL Sig_gen
190 CLEAR Sig_gen
200 CLEAR SCREEN
210 OUTPUT Sig_gen;"*RST"
220 OUTPUT Sig_gen;"*CLS"
230 ! *****
240 Sig_in:  !
250 REPEAT
260     X=X+1
270     PRINT
280     PRINT "Configure the INSTRUMENT for the settings to be SAVED."
290     LOCAL Sig_gen
300     PRINT "when the setup is complete, Press Continue..."
310     PAUSE
320     CLEAR SCREEN
330     OUTPUT Sig_gen;"*SAV ";X
340     INPUT "Are there anymore setups to be SAVED?  Yes/No",No$
350     No$=UPC$(No$[1,1])
360 UNTIL No$="N"
370 WAIT 1
380 PRINT
390 PRINT "You have saved";X;"setups."
400 OUTPUT Sig_gen;"*RST"
```

```

410 ! *****
420 Sig_out: !
430 INPUT "ENTER the Register number to be RECALLED or ENTER 0 to exit.",Reg1
440 CLEAR SCREEN
450 IF Reg1=0 THEN
460 PRINT
470 PRINT "You have requested to exit the program the program has been terminated."
480 GOTO Ins_lcl
490 END IF
500 IF Reg1>X THEN
510 PRINT
520 PRINT "You have requested a Register number not recognized by this executive."
530 GOTO Ins_lcl
540 END IF
550 OUTPUT Sig_gen;"*RCL ";Reg1
560 CLEAR SCREEN
570 PRINT
580 PRINT "The instrument has been set to the values from Registrar";Reg1;".
590 GOTO Sig_out
600 ! *****
610 Ins_lcl: !
620 LOCAL Sig_gen
630 PRINT
640 WAIT 1
650 PRINT "The instrument has been returned to local control...Press RUN to start again."
660 END
    
```

### Program Comments

10 to 140:	Title and program description
150:	Dimension string Clear\$ to contain responses.
160:	Assigns a value of 0 to X variable.
170:	Assigns the signal generator's GPIB address to a variable.
180:	Places the signal generator into LOCAL mode.
190:	Resets the signal generator's parser and clear any pending output from the source.
200:	Clears the controller's display.
210:	Sets the signal generator to a defined state for programming.
220:	Clears the signal generator's Status Byte Register.
230:	Program border
240 to 360:	Subroutine: Sig_in. Allows the operator to configure the measurement and store the settings in save/recall registers. The subroutine will display the total number of instrument settings that were saved.

370:	Waits one second.
380 to 390:	Print a message on the computer's display.
400:	Sets the signal generator to a defined state for programming.
410:	Program border
420 to 540:	Subroutine: Sig_out. Assigns keyboard values to the program variable. The subroutine includes conditional statements that will terminate the program depending on the value stored in the program variable Reg1 or transfers execution to a specified program.
550:	Recalls contents of register 1.
560:	Clears the controller's display.
570 to 580:	Prints a message to the controller's display.
590:	Transfers program to a specific line.
600:	Program border
610:	Subroutine: Ins_lcl
620 to 630:	Returns the signal generator to LOCAL mode.
640:	Waits one second.
650:	Prints a message to the controller's display.
660:	Ends the program.

---

## Reading the Status Byte, Example Program 10

The following example reads the source's status byte and checks for certain conditions: in this case, an unlevelled output condition and an undermodulated output condition are created, and the Status Byte Register is read by the program to determine the questionable condition.

Unlevelled or undermodulated conditions are easy to produce from the front panel. Follow the directions below:

- To create an unlevelled output condition:
  1. Set the source's output amplitude to +20 dBm.
  2. Set the source's output frequency to the maximum value.
  3. Turn on the source's RF output.
  4. Check the source's display for the UNLEVEL annunciator.
- To create an undermodulated output condition:
  1. Select a modulation menu (AM, FM, Phase Modulation).
  2. Select an AC-coupled external source (i.e. Ext 1 AC-Coupled).
  3. Turn on the modulation.
  4. Do not connect any input to the selected external input.
  5. Check the source's display for the EXT1 LO annunciator.

CLEAR and RESET the controller, type the following commands, and RUN the program:

```

10  !*****
20  !
30  ! Read Status Byte Example
40  !
50  !*****
60  Sig_gen=719
70  CLEAR Sig_gen
80  CLEAR SCREEN
90  OUTPUT Sig_gen;"*CLS"
100 IF FNStat_con(Sig_gen,"UNLEVELED") THEN PRINT "Sig Gen Power Unlevelled"
110 IF FNStat_con(Sig_gen,"MOD 1 UNDERMOD") THEN PRINT "Sig Gen Mod 1 Undermod"
120 IF FNStat_con(Sig_gen,"MOD 1 OVERMOD") THEN PRINT "Sig Gen Mod 1 Overmod"
130 IF FNStat_con(Sig_gen,"MOD 2 UNDERMOD") THEN PRINT "Sig Gen Mod 2 Undermod"
140 IF FNStat_con(Sig_gen,"MOD 2 OVERMOD") THEN PRINT "Sig Gen Mod 2 Overmod"
150 IF FNStat_con(Sig_gen,"OVEN COLD") THEN PRINT "Sig Gen Oven Cold"
160 IF FNStat_con(Sig_gen,"SYNTH UNLOCKED") THEN PRINT "Sig Gen Synth Unlock"
170 IF FNStat_con(Sig_gen,"10 MHZ REF UNLCK") THEN PRINT "Sig Gen 10 MHz Ref Unlck"
180 IF FNStat_con(Sig_gen,"1 GHZ REF UNLCK") THEN PRINT "Sig Gen 1 GHz LO Unlck"

```

```
190 IF FNStat_con(Sig_gen,"BBG SYNTH UNLCK") THEN PRINT "Sig Gen BBG Synth Unlck"
200 !*****
210 END
220 !
230 !
240 Stat_con:DEF FNStat_con(Sig_gen,Condition_name$)
250     SELECT Condition_name$
260     CASE "MOD 1 UNDERMOD","MOD 1 OVERMOD","MOD 2 UNDERMOD","MOD 2 OVERMOD"
270         IF Condition_name$="MOD 1 UNDERMOD" THEN Bit_number=0
280         IF Condition_name$="MOD 1 OVERMOD" THEN Bit_number=1
290         IF Condition_name$="MOD 2 UNDERMOD" THEN Bit_number=2
300         IF Condition_name$="MOD 2 OVERMOD" THEN Bit_number=3
310         OUTPUT Sig_gen;"STAT:QUES:MOD:ENAB 32767"
320         OUTPUT Sig_gen;"STAT:QUES:MOD:COND?"
330         ENTER Sig_gen;Condition
340     CASE "UNLEVELED"
350         Bit_number=1
360         OUTPUT Sig_gen;"STAT:QUES:POW:ENAB 32767"
370         OUTPUT Sig_gen;"STAT:QUES:POW:COND?"
380         ENTER Sig_gen;Condition
390     CASE "OVEN COLD"
400         Bit_number=4
410         OUTPUT Sig_gen;"STAT:QUES:ENAB 32767"
420         OUTPUT Sig_gen;"STAT:QUES:COND?"
430         ENTER Sig_gen;Condition
440     CASE "SYNTH UNLOCKED","10 MHZ REF UNLCK","1 GHZ REF UNLCK","BBG SYNTH UNLCK"
450         IF Condition_name$="SYNTH UNLOCKED" THEN Bit_number=0
460         IF Condition_name$="10 MHZ REF UNLCK" THEN Bit_number=1
470         IF Condition_name$="1 GHZ REF UNLCK" THEN Bit_number=2
480         IF Condition_name$="BBG SYNTH UNLCK" THEN Bit_number=3
490         OUTPUT Sig_gen;"STAT:QUES:FREQ:ENAB 32767"
500         OUTPUT Sig_gen;"STAT:QUES:FREQ:COND?"
510         ENTER Sig_gen;Condition
520     CASE ELSE
530         PRINT "Error in FNStat_con! ";Condition_name$;" is an unknown condition"
540         PAUSE
550     END SELECT
560     State=BIT(Condition,Bit_number)
570     RETURN State
580 FNEND
```



**Program Comments**

10 to 50:	Program title
60:	Assigns the signal generator's GPIB address to a variable.
70 to 80:	Resets the signal generator's parser, clears any pending output, and clears the controller's display.
90:	Resets the signal generator's Status Byte Register.
100:	Checks function FNStat_con for an UNLEVELED condition. If the signal generator is unleveled, prints a message to the controller's display.
110:	Checks function FNStat_con for an External 1 Undermod condition. If the modulation level input at EXT 1 is low, prints a message to the controller's display.
120:	Checks function FNStat_con for an External 1 Overmod condition. If the modulation level input at EXT 1 is high, prints a message to the controller's display.
130:	Checks function FNStat_con for an External 2 Undermod condition. If the modulation level input at EXT 2 is low, prints a message to the controller's display.
140:	Checks function FNStat_con for an External 2 Overmod condition. If the modulation level input at EXT 2 is high, prints a message to the controller's display.
150:	Checks function FNStat_con for an OVEN COLD condition. If the internal 10 MHz Reference Standard Oven is cold, prints a message to the controller's display. NOTE: This condition is valid only for instruments having the high stability timebase (ESG-AP, ESG-DP, and Option 1E5).
160:	Checks function FNStat_con for a synthesizer unlocked condition. If unlocked, prints a message to the controller's display.
170:	Checks function FNStat_con for a 10 MHz reference unlocked condition. If unlocked, prints a message to the controller's display.
180:	Checks function FNStat_con for a 1 GHz reference unlocked condition. If unlocked, prints a message to the controller's display.
190:	Checks function FNStat_con for a baseband synthesizer unlocked condition. If unlocked, prints a message to the controller's display.
200 to 230:	Ends conditional section.
240 to 250:	Defines the function FNStat_con. This main program passes the signal generator's address and a string indicating what condition to check for to this section of the program. Select/Case statements are used to determine which Data Questionable Status Register is checked. The proper bit within the register is then enabled and read. The state of the bit is then returned to the program (lines 100 – 190).
260:	Selects cases dealing with the Data Questionable Modulation Status Group.
270 to 300:	Assigns values to the variable <Bit_number> according to the variable <Condition_name\$>.
310:	Enables all bits in the Data Questionable Modulation event register.
320 to 330:	Queries the Data Questionable Modulation Event Register and stores it in the variable <Condition>.
340:	Selects the case of an UNLEVELED condition.

## Reading the Status Byte, Example Program 10

350 to 380:	Assigns a value to <Bit_number>. Enables all bits in the Data Questionable Power Event Register, then queries the Data Questionable Event Register and stores it in the variable <Condition>.
390:	Selects cases dealing with an OVEN COLD condition. NOTE: This condition is valid only for instruments the high stability timebase (ESG-AP, ESG-DP, and Option 1E5).
400 to 430:	Assigns a value to the variable <Bit_number>. Enables all bits in the Data Questionable Event Register, then queries the Data Questionable Event Register and stores it in the variable <Condition>.
440:	Selects cases dealing with the Data Questionable Frequency Status Group.
450 to 480:	Assigns a value to the variable <Bit_number> according to <Condition_name>.
490:	Enables all bits in the Data Questionable Frequency Event Register.
500 to 510:	Queries the Data Questionable Frequency Event Register and stores it in the variable <Condition>.
520 to 540:	If <Condition_name\$> is unknown, it prints a message to the screen and pauses the program. Note that <Condition_name\$> is passed to the function from the main program.
560 to 570:	Returns the state of the bit corresponding to the condition queried to the main program. For example, if the source's output power was unlevelled and an UNLEVELED condition was queried, then the value of Bit 0 (line 350) of the Data Questionable Power Status Group (line 370 – 380) would be returned.
580:	Ends the program.

---

## End of Sweep Service Request, Example Program 11

The following example provides a program that produces a service request to the controller when a specific condition (in this case: end of sweep) is present in the signal generator.

CLEAR and RESET the controller, type the following commands, and RUN the program:

```

10      !*****
20      !
30      ! End of Sweep Service Request Example
40      !
50      !*****
60      Sig_gen=719
70      CLEAR Sig_gen
80      CLEAR SCREEN
90      OUTPUT Sig_gen;"*RST"
100     OUTPUT Sig_gen;"*CLS"
110     !*****
120     Setup_srq:  !
130     Gpib=7
140     Mask=2
150     OUTPUT Sig_gen;"STAT:OPER:NTR 8"
160     OUTPUT Sig_gen;"STAT:OPER:PTR 0"
170     OUTPUT Sig_gen;"STAT:OPER:ENAB 8"
180     OUTPUT Sig_gen;"*SRE 128"
190     ON INTR Gpib GOSUB Service_routine
200     ENABLE INTR Gpib;Mask
210     !*****
220     Setup_swp:  !
230     OUTPUT Sig_gen;"FREQ:MODE LIST"
240     OUTPUT Sig_gen;"LIST:TYPE STEP"
250     OUTPUT Sig_gen;"LIST:TRIG:SOUR IMM"
260     OUTPUT Sig_gen;"LIST:MODE AUTO"
270     OUTPUT Sig_gen;"FREQ:STAR 40 MHZ"
280     OUTPUT Sig_gen;"FREQ:STOP 900 MHZ"
290     OUTPUT Sig_gen;"SWE:POIN 25"
300     OUTPUT Sig_gen;"SWE:DWEL .5 S"
310     OUTPUT Sig_gen;"INIT:CONT OFF"
320     OUTPUT Sig_gen;"TRIG:SOUR IMM"
330     Trigger_swp:  !
340     OUTPUT Sig_gen;"INIT"
350     Sweep=1
360     !*****
370     Wait_4_swp_end:  !
380     PRINT "Sweeping";

```

```

390 WHILE Sweep=1
400   PRINT " .";
410   WAIT 1
420 END WHILE
430 GOTO End
440 !
450 !*****
460 Service_routine:      !
470   Ser_poll=SPOLL(Sig_gen)
480   IF BIT(Ser_poll,7) THEN
490     PRINT "The Sig Gen has completed a sweep"
500     Sweep=0
510   ELSE
520     PRINT "A Service Request was received for unknown reasons"
530   END IF
540   ENABLE INTR 7
550   RETURN
560 !*****
570 End: !
580   END

```

## Program Comments

10 to 50:	Program title
60:	Assigns the signal generator's GPIB address to a variable.
70:	Resets the signal generator's parser and clears any pending output from the source.
80:	Clears the computer's display.
90:	Sets the signal generator to a defined state for programming.
100:	Clears the Status Byte; resets all registers to 0.
110:	Program border
130 to 140:	Sets variables GpiB and Mask so that BASIC will cause an interrupt when there is a service request on the GPIB Interface. Refer to the HP BASIC Interface Reference for details.
150:	Configures the Operation Status Group Negative Transition Filter so that a negative transition in Bit 3 (Sweeping) of the Operation Status Group initiates a corresponding event in the Operation Event Register. This event occurs at the end of a sweep.
160:	Configures the Operation Status Group Positive Transition Filter so that no positive transitions in the Operation Status Group initiate a corresponding event in the Operation Event Register. In other words, a start of sweep does not initiate an event.
170:	Enables Operation Status Event Bit 3 (Sweeping) to report its event to the Summary Bit 7 of the Status Byte Register.
180:	Enables Summary Bit 7 of the Status Byte Register to generate a Service Request (SRQ) on GPIB.

190 to 200:	Setups HP BASIC to recognize the SRQ and branches to “Service Routine” when the SRQ is received.
210:	Program border
220 to 320:	Sets up the signal generator for a 40 MHz to 900 MHz stepped single sweep.
330 to 350:	Triggers the sweep.
370 to 420:	An endless loop developed for the sake of this example. The program is stuck here forever or until the signal generator generates an SRQ at the end of sweep. Then an Interrupt is initiated and the program branches to Service_routine (Line 460).
470:	A serial poll is used to read the signal generator Status Byte.
480 to 490:	If Status Byte Bit 7 is true then the sweep is complete. Sets the value of the variable sweep to 0 so the program can exit the endless loop after it returns.
510 to 530:	Indicates that the SRQ cause is unknown.
540 to 550:	Re-enables the Interrupt in HP BASIC then returns to the endless loop. If sweep is still set to 1 the program is again stuck in the endless loop waiting for end-of-sweep. If an end-of-sweep was detected, the program ends.
570 to 580:	Ends the program.



## 3 Remote Data Transfer

You can generate data on a remote computer and subsequently download it into the signal generator. Depending on the options present, the signal generator accepts ARB waveform data, user file data, FIR filter coefficient data, or data downloaded directly to pattern RAM. This section explains the different download methods, and the data formatting required for each method.

This chapter is divided by data transfer method, and provides troubleshooting information:

[“ARB Waveform Data Downloads”](#) on page 3-2

[“User File Data Downloads”](#) on page 3-12

[“FIR Filter Coefficient Data Downloads”](#) on page 3-23

[“Data Downloads Directly into Pattern RAM”](#) on page 3-27

[“Data Transfer Troubleshooting”](#) on page 3-33

---

## ARB Waveform Data Downloads

This section explains how to download I/Q waveform files into the signal generator.

---

**NOTE** Downloads into volatile ARB memory are *significantly* faster than downloads into nonvolatile NVARB memory.

---

Option UND signal generators accept I/Q waveform data downloads. After downloading the data, these user-defined I/Q waveforms can be sequenced together with other waveforms and played as part of a waveform sequence.

Dual ARB waveforms are composed of two sets of data: I data and Q data. The I data drives the I port of the I/Q modulator and the Q data drives the Q port. These two sets of data give rise to the name *dual* arbitrary waveform generator.

I and Q data are arrays of 2-byte integers, in high-byte, low-byte order. The actual waveform shape is enclosed in the least-significant 14 bits of both the I and Q data. The other four bits (two for I and two for Q) are used for event markers and internal sequencing.

Bit Number	I	Q
0 through 13	waveform data	waveform data
14	EVENT 1	reserved, set to 0
15	EVENT 2	reserved, set to 0

A 1 in bit position 14 or 15 of the I data will cause a TTL high to appear at the associated EVENT BNC connector on the signal generator's rear panel.

Bit-value-versus-output-power:

- 0 gives negative full-scale output
- 8192 gives 0V output
- 16383 gives positive full-scale output

---

**NOTE** Because there are two files, one containing I data and another containing Q data, it is important that you remember to rewrite both the I and Q waveform data when downloading and overwriting a waveform in memory.

---

## Types of Arbitrary Waveform Generator Memory

There are two types of arbitrary waveform generator memory: volatile static RAM, referred to as ARB memory, and nonvolatile FLASH RAM, referred to as NVARB memory.



Waveform data stored in ARB memory is volatile. The data in ARB memory is destroyed whenever the signal generator's line power is cycled. In ARB memory, waveform data may be downloaded, sequenced, and played back through the signal generator's I/Q baseband generator section.

Information stored in NVARB memory is nonvolatile. Waveforms stored in NVARB memory must first be moved to ARB memory in order to be sequenced and played. Waveform data stored in NVARB memory is not at risk when the signal generator's line power is cycled.

While waveforms may be directly downloaded to either ARB or NVARB memory, it is much faster to download to dynamic RAM-based volatile ARB memory. If memory space permits, first download the waveform data to ARB memory and then copy it in NVARB memory.

## Data Requirements

I/Q waveform data downloads have the following requirements:

- Data must be in unsigned, offset (binary) format.

The signal generator expects this type of data.

- Data must be in 2-byte integers

Two bytes are needed to express 14-bit waveforms. The signal generator accepts the most significant byte first.

- Input data must be between 0 and 16383.

This range is based on the input specifications of the 14-bit DAC used to create the analog voltages for the I/Q modulator. Note that markers increase the size of the I data beyond 16383.

- Each I and Q waveform must contain at least 16 points to play in the waveform sequencer.

A point equals an integer.

- Each I and Q waveform must contain an even number of points to play in the waveform sequencer.

- Each I and Q waveform should be the same length.

Different length I and Q waveforms are allowed. The shorter waveform gives a 0V output from its end to the length of the longer waveform.

## Data Limitations

As explained in “[Types of Arbitrary Waveform Generator Memory](#)” on page 3-2, there are two types of arbitrary waveform generator memory. The data limitations for the two different memory areas are explained separately.

### For Volatile and Nonvolatile ARB Memory Downloads

ARB waveform memory space (approximately 1 Mpoints) is allocated in 4096-point (8192 byte) segments. Accordingly, regardless of how small the waveform is, it always occupies at least 4096 points of volatile ARB memory. If a waveform file is too large to fit into a 4096-point memory segment, additional memory space is allocated in multiples of 4096 points. For example, a waveform of 4100 points, is allocated to a 8192-point memory segment.

When played back through the sequencer, smaller waveforms play back only the number of points occupied by their waveform data, not the full 4096 points. See the following table.

Waveform	Number of Points	Memory Space (in points)
wfm1	32	4096
wfm2	128	4096
wfm3	4096	4096
wfm4	4098	8192
Total Points	8354	20480

---

**NOTE** It is important to remember that, if there are many small waveform files stored in volatile ARB memory, the total memory usage may be much more than the sum of the points that make up the actual waveform data. There will not be as much memory available as perhaps expected, based on the combined sum of the individual waveform data files.

---

### Data Volatility

Waveform data stored in ARB memory is *volatile*. This data is destroyed whenever the signal generator's line power is cycled. Waveform data in ARB memory can be downloaded, sequenced, and played back through the signal generator's I/Q baseband generator section.

Information stored in NVARB memory is *nonvolatile*. This data survives a line power cycle, and remains in the memory catalog until you delete the file, or until the signal generator's internal battery expires. To be sequenced and played, waveforms in NVARB memory must first be moved to ARB memory.

### Downloading Waveforms into Volatile and Nonvolatile ARB Memory

---

**NOTE** Downloads into volatile ARB memory are *significantly faster* than downloads into nonvolatile NVARB memory, due to the data parsing required by nonvolatile ARB memory.

---

There are two SCPI commands required to download I/Q data into ARB memory, one for the I data and one for the Q data. The signal generator will associate the I waveform values and the Q waveform values, and drive the I and Q modulators in the baseband generator with the stored waveform.

If only one of the two required commands is executed (I values only or Q values only), the missing data will be set to values corresponding to a 0 V output.

### Data Requirements and Limitations

- Data must be in unsigned, offset (binary) format.
- Data must be in 2-byte integers (the signal generator accepts the MSB first).
- Input data must be between 0 and 16383.
- Each I and Q waveform must contain at least 16 points.
- Each I and Q waveform must contain an even number of points.
- Each I and Q waveform should be the same length.

### Preliminary Setup

Before downloading into volatile ARB memory, turn off the ARB by pressing **Mode > Dual ARB > ARB Off On** until **Off** is highlighted or execute the SCPI command `[ :SOURCE]:RADio:ARB[:STATE] OFF`.

### SCPI Commands

**For Volatile ARB Memory:** `:MMEM:DATA "ARBI:<waveform name>", <I waveform data>`

This command downloads the I values for your waveform into volatile ARB memory. The variable `<waveform_name>` denotes the name that will be associated with the downloaded waveform data within the signal generator and therefore must be the same for both I and Q downloads.

```
:MMEM:DATA "ARBQ:<waveform name>", <Q_waveform data>
```

This command downloads the Q values for your waveform into volatile ARB memory.

**For Nonvolatile ARB Memory:** `:MMEM:DATA "NVARBI:<waveform name>", <I waveform data>`

This command downloads the I values for your waveform into nonvolatile ARB memory. The variable `<waveform_name>` denotes the name that will be associated with the downloaded waveform data within the signal generator and therefore must be the same for both I and Q downloads.

```
:MMEM:DATA "NVARBQ:<waveform name>", <Q_waveform data>
```

This command downloads the Q values for your waveform into volatile ARB memory.

## Sample Command Line

A sample command line:

```
:MMEM:DATA "ARBI:<waveform name>", #ABC
```

"<waveform name>" the name of the waveform file within the signal generator.

A the number of decimal digits to follow in B.

B a decimal number specifying the number of data bytes in C.

C the binary waveform data in 2-byte integers.

### Example 1

```
:MMEM:DATA "ARBI:WAVEFORM1", #232<32 bytes of data>
```

| | | | |  
A B C

WAVEFORM1 the waveform name

2 defines the number of decimal digits to follow in B. This variable is represented by A in the sample command line.

32 denotes how many bytes of data are to follow. This variable is represented by B in the sample command line.

<32 bytes of data> the binary waveform data in 2-byte integers. Data order is defined as Most Significant Byte (first) and Least Significant Byte (last). This variable is represented by C in the sample command line.

---

**NOTE** This command line only sends the I-half of the I/Q waveform data. After sending the above command, you must send  
MMEM:DATA "ARBQ:<waveform name>", <Q waveform data> for the Q data.

---

## Querying the Waveform Data

Use the following SCPI command line to upload waveform data from volatile ARB memory to the personal computer:

```
:MMEM:DATA? "ARBI:<waveform name>"
```

```
:MMEM:DATA? "ARBQ:<waveform name>"
```

Use the following SCPI command line to upload waveform data from nonvolatile ARB memory to the personal computer:

```
:MMEM:DATA? "NVARBI:<waveform name>"
```

```
:MMEM:DATA? "NVARBQ:<waveform name>"
```

## Example Programs

**Waveform Downloading Using HP BASIC for Windows™** The following program shows you how to download waveforms using HP BASIC for Windows™ into volatile ARB memory.

To download into nonvolatile ARB memory, replace line 80 with:

```
80 OUTPUT @ESG USING "#,K";":MMEM:DATA ""NVARBI:testfile"", #"
```

and replace line 130 with:

```
130 OUTPUT @ESG USING "#,K";":MMEM:DATA ""NVARBQ:testfile"", #"
```

First, the I waveform data is put into an array of integers called `Iwfm_data` and the Q waveform data is put into an array of integers called `Qwfm_data`. The variable `Nbytes` is set to equal the number of bytes in the I waveform data. This should be twice the number of integers in `Iwfm_data`, since an integer is 2 bytes. Input integers must be between 0 and 16383.

In the Output commands, USING "#,K" formats the data. The pound symbol (#) suppresses the automatic EOL (End of Line) output. This allows multiple output commands to be concatenated as if they were a single output. The "K" instructs HP BASIC to output the following numbers or strings in the default format.

```
5 Npoints=20
10 ALLOCATE INTEGER Iwfm_data(1:Npoints),Qwfm_data(1:Npoints)
15 DEG
20 FOR I=1 TO Npoints
25   Iwfm_data(I)=INT(8191*(COS(I*360/Npoints))+8192)
30   Qwfm_data(I)=INT(8191*(COS(I*360/Npoints))+8192)
35 NEXT I
40 Nbytes=2*Npoints
45 Assign @ESG to 719
50 Assign @ESGb to 719; FORMAT MSB FIRST
60 Nbytes$=VAL$(Nbytes)
70 Ndigits$=VAL$(LEN$(Nbytes$))
80 OUTPUT @ESG USING "#,K";":MMEM:DATA ""ARBI:testfile"", #"
90 OUTPUT @ESG USING "#,K";Ndigits$
100 OUTPUT @ESG USING "#,K";Nbytes
110 OUTPUT @ESGb;Iwfm_data(*)
120 OUTPUT @ESG;
130 OUTPUT @ESG USING "#,K";":MMEM:DATA ""ARBQ:testfile"", #"
140 OUTPUT @ESG USING "#,K";Ndigits$
150 OUTPUT @ESG USING "#,K";Nbytes$
160 OUTPUT @ESGb;Qwfm_data(*)
170 OUTPUT @ESG;
180 Assign @ESG TO *
190 Assign @ESGb TO *
200 END
```

**Program Comments**

5:	Sets the number of points in the waveform.
10:	Defines arrays for I and Q waveform points. Sets them to be integer arrays.
15:	Sets HP BASIC to use degrees for cosine and sine functions.
20:	Sets up loop to calculate waveform points.
25:	Calculates I waveform points.
30:	Calculates Q waveform points.
35:	End of loop.
40:	Calculates number of bytes in I or Q waveform.
45:	Opens an I/O path to the signal generator using GPIB. 7 is the address of the GPIB card in the computer, and 19 is the address of the signal generator. This I/O path is used to send ASCII data to the signal generator.
50:	Opens an I/O path for sending binary data to the signal generator. <code>FORMAT MSB FIRST</code> is needed to send the 2 bytes of each integer to the signal generator in the correct order.
60:	Creates an ASCII string representation of the number of bytes in the waveform.
70:	Finds the number of digits in Nbytes.
80:	Sends the I waveform SCPI download-to-ARBI command and the beginning of the ASCII header for the data. <code>testfile</code> is the waveform name that will be used in the signal generator.
90 to 100:	Sends the rest of the ASCII header.
110:	Sends the binary data. Note that <code>ESGb</code> is the binary I/O path.
120:	Sends an End-of-Line to terminate the transmission.
130 to 170:	Executes same commands for the Q waveform.
180 to 190:	Closes the connections to the signal generator.
200:	End the program.

**Waveform Downloading Using HP BASIC for UNIX** The following program shows you how to download waveforms into volatile ARB memory using HP BASIC for UNIX.

First, the I waveform data is put into an array of integers called `Iwfm_data` and the Q waveform data is put into an array of integers called `Qwfm_data`. The variable `Nbytes` is set to equal the number of bytes in the I waveform data. This should be twice the number of integers in `Iwfm_data`, since an integer is 2 bytes. Input integers must be between 0 and 16383.

In the Output commands, USING "#,K" formats the data. The pound symbol (#) suppresses the automatic EOL (End of Line) output. This allows multiple output commands to be concatenated as if they were a single output. The "K" instructs HP BASIC to output the following numbers or strings in the default format.

```

5 Npoints=20
10 ALLOCATE INTEGER Iwfm_data(1:Npoint),Qwfm_data(1:Npoints)
15 DEG
20 FOR I=1 TO Npoints
25  Iwfm_data(I)=INT(8191*(COS(I*360/Npoints))+8192)
30  Qwfm_data(I)=INT(8191*(COS(I*360/Npoints))+8192)
35 NEXT I
40 Nbytes=2*Npoints
45 Assign @ESG to 719;FORMAT ON
50 Assign @ESGb to 719; FORMAT OFF
55 Nbytes$=VAL$(Nbytes)
60 Ndigits$=(LEN$(Nbytes$))
65 OUTPUT @ESG USING "#,K";":MMEM:DATA  ""ARBI:<name>"",#"
70 OUTPUT @ESG USING "#,K";Ndigits$
75 OUTPUT @ESG USING "#,K";Nbytes
80 OUTPUT @ESGb;Iwfm_data(*)
85 OUTPUT @ESG;
90 OUTPUT @ESG USING "#,K";":MMEM:DATA  ""ARBQ:<name>"",#"
95 OUTPUT @ESG USING "#,K";Ndigits$
100 OUTPUT @ESG USING "#,K";Nbytes
105 OUTPUT @ESGb;Qwfm_data(*)
110 OUTPUT @ESG;";"
115 Assign @ESGb to *
120 Assign @ESG to *
125 END

```

### Program Comments

5:	Sets the number of points in the waveform.
10:	Defines arrays for I and Q waveform points. Sets them to be integer arrays.
15:	Sets HP BASIC to use degrees for cosine and sine functions.
20:	Sets up loop to calculate waveform points.
25:	Calculates I waveform points.
30:	Calculates Q waveform points.
35:	End of loop.
40:	Calculates number of bytes in I or Q waveform.
45:	Opens an I/O path to the signal generator using GPIB. 7 is the address of the GPIB card in the computer, and 19 is the address of the signal generator. This I/O path is used to send ASCII data to the signal generator.
50:	Opens an I/O path for sending binary data to the signal generator.
55:	Creates an ASCII string representation of the number of bytes in the waveform.

### Program Comments (Continued)

60:	Finds the number of digits in Nbytes.
65:	Sends the I waveform SCPI download-to-ARBI command and the beginning of the ASCII header for the data. The variable <name> is the waveform name that will be used in the signal generator.
70 to 75:	Sends the rest of the ASCII header.
80:	Sends the binary data. Note that ESGb is the binary I/O path.
85:	Sends an End-of-Line to terminate the transmission.
90 to 110:	Executes same commands for the Q waveform. The variable <name> that appears in program line 100 must be identical to that in program line 50.
115 to 120:	Closes the connections to the signal generator.
125:	End the program.

## Playing a Downloaded Waveform

The following commands are for waveforms downloaded to ARB memory.

1. Load and select the downloaded I and Q files for playback.

Via the Front Panel Interface: If you have downloaded the data to ARB memory, this step is unnecessary because the files already reside in the playback memory. If the files were downloaded to non-volatile ARB memory (NVARB) press **Mode > Arb Waveform Generator > Dual ARB > Select Waveform > Waveform Segments > Load Store**, highlight the downloaded file in the NVARB catalog and press **Load Segment From NVARB Memory**. This loads your downloaded data into ARB memory for playback. If the proper waveform is not highlighted, use the cursor to highlight the waveform and press **Select Waveform**. This selects the proper waveform for playback.

Via the Remote Interface: If you have downloaded the data to ARB memory, this step is unnecessary because the files already reside in the playback memory. If the files were downloaded to non-volatile ARB memory (NVARB) press send the following SCPI commands:

```
[ :SOURce]:RADio:ARB:WAVEform "ARBI:"<waveform name>" "  
[ :SOURce]:RADio:ARB:WAVEform "ARBQ:"<waveform name>" "
```

These commands load ARB memory with the I and Q files of your downloaded data. This loads your downloaded data into ARB memory for playback.

2. Generate and output the waveform.

Via the Front Panel Interface: Press **ARB Off On** until On is highlighted to generate the waveform. If necessary, press **Mod On/Off** until the display reads MOD ON (modulation is set to on at preset) and **RF On/Off** to activate the RF output (RF output is set to off at instrument preset). The waveform is now modulating the carrier frequency at the RF output.



Via the Remote Interface: To generate the waveform, send the following SCPI command:

```
[ :SOURce ]:RADio:ARB[ :STATe] ON
```

To activate the modulation, send the following command:

```
:OUTPut:MODulation[:STATe] ON
```

To activate the RF output, send the following command:

```
:OUTPut[:STATe] ON
```

The waveform is now modulating the carrier frequency at the RF output.

---

## User File Data Downloads

Option UN8 or UN8/UN9 signal generators accept user file data downloads. After downloading the data, the user files can be selected as the transmitting data source for the active digital communications standard. This section contains information that will help you transfer user file data from a system controller to the signal generator. It explains how to download user files into the signal generator's memory catalog and modulate the carrier signal with them.

In framed mode, user files data will be inserted into the data fields of an existing or user-defined, custom framed digital modulation format (DECT, PHS, TETRA, custom user-defined format, etc.).

The instrument's firmware generates the required framing structure and inserts the data contained within the user file into the data field(s) of the active format. For more information, see "[User Files as Data Source for Framed Transmission](#)" on page 3-14.

---

**NOTE** Unlike downloads to pattern RAM, user files contain "data field" information only. The control data bits required for files downloaded directly into PRAM are not required for user file data.

---

In pattern mode, the user file is modulated as a continuous, unframed stream of data, according to the modulation type, symbol rate, and filtering associated with the active digital communications format (DECT, TETRA, PHS, etc.).

When a user file is selected as the data source, the signal generator's firmware loads PRAM with the data specified in the user file, and sets the other seven control bits depending upon the operating mode selected, regardless of whether continuous or framed transmission is selected. In this manner, user files are mapped into PRAM such that one user file data bit equals one byte and occupies one address in PRAM.

### Bit Memory versus Binary Memory

You can download user files to either the bit memory or binary memory catalog.

The bit memory catalog accepts data in any integer number of bits, up to the maximum available memory in the bit memory catalog (approximately 1 Mbit). The data length in bytes for files downloaded to the bit memory catalog is equal to the number of significant bits plus seven, divided by eight, then rounded down to the nearest integer. You must have enough bytes to contain the bits you specify. If the number of bits is not a multiple of 8, the least significant bits of the last byte will be ignored.

The bit memory catalog provides more versatility and is the preferred memory catalog for user file downloads.

The binary memory catalog requires data formatted in 8-bit bytes. Files stored or downloaded to the binary catalog are converted to bit files prior to editing in the bit file editor. Afterward, these modified files from the binary memory catalog are stored in the bit memory catalog as bit files.

## Data Requirements

1. Data must be in binary format.

SCPI specifies the data in 8-bit bytes.

---

**NOTE** Not all binary values are ASCII characters that can be printed. In fact, only ASCII characters corresponding to decimal values 32 through 126 are printable keyboard characters. Typically, the ASCII character corresponding to an 8-bit pattern is not printable.

Because of this, the program written to download and upload user files *must correctly convert* the binary data into 8-bit characters.

---

2. Bit length must be a multiple of the data-field length of the active format.

Also, the bit length of a user file must be a multiple of the data-field length of the active format in order to completely fill the frame's data field without leaving a remainder.

Remaining data is truncated by the signal generator's firmware and is therefore not present in the resulting waveform at the RF output.

3. Bit length must be a multiple of 8 (Binary catalog downloads only).

SCPI specifies data in 8-bit bytes, and the binary catalog stores data in 8-bit bytes. If the length (in bits) of the original data pattern is not a multiple of 8, you may need to:

- add additional bits to complete the ASCII character,
- replicate the data pattern to generate a continuously repeating pattern with no discontinuity,
- truncate and discard bits until you reach a string length that is a multiple of 8, or
- use a bit file and download to the bit memory catalog instead.

## Data Limitations

The size of a user file that can be saved depends on the available memory in the memory catalog. The maximum amount of memory in the catalog is about 270 kbytes, but memory available for user files is reduced if memory is also being occupied by instrument state files or sweep list files that have been saved to the memory catalog.

Therefore, download size limitations are directly proportional to the memory catalog's available memory space and the signal generator's pattern RAM size (UN8 = 1 Mbyte, UN9 = 8 Mbyte). To determine the maximum user file size, you must consider the:

- framing overhead,
- pattern RAM size (1 MByte or 8 MByte), and
- available memory in the memory catalog.

You may have to delete any superfluous files from the memory catalog before downloading larger files.

## Data Volatility

Downloaded user file data is *nonvolatile*. The data is stored to the instrument's memory catalog.

This data will survive a line power cycle. It will remain in the memory catalog until you delete the file, or until the signal generator's internal battery expires.

## User Files as Data Source for Framed Transmission

Specifying a user file as the data source for a framed transmission provides you with an easy method to multiplex real data into internally generated TDMA framing. The user file will fill the data fields of the active timeslot in the first frame, and continue to fill the same timeslot of successive frames as long as there is more data in the file. This functionality allows a communications system designer to download and modulate proprietary data sequences, specific PN sequences, or simulate multiframe transmission, such as those specified by some mobile communications protocols. As the example in the following figure shows, a GSM multiframe transmission requires 26 frames for speech.

**Figure 3-1 GSM Multiframe Transmission**

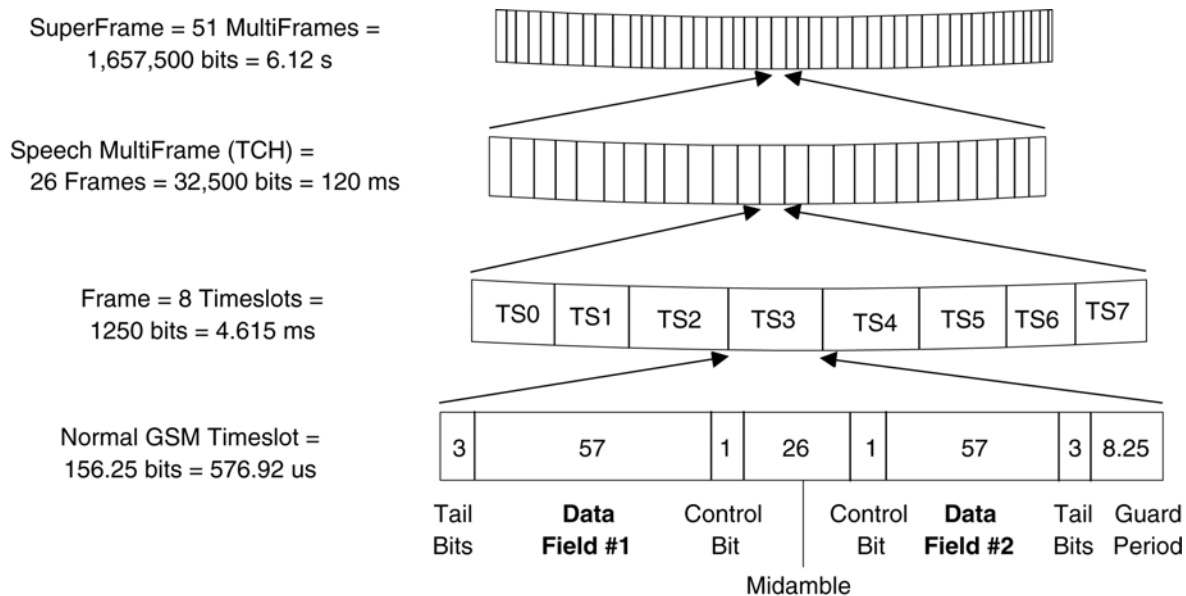

When a user file is selected as the data source for a framed transmission, the signal generator's firmware loads pattern RAM with the framing protocol of the active TDMA format. For all addresses corresponding to active (on) timeslots, burst bits are set to 1 and data bits are set with the contents of the user file for the data fields of the timeslot. Other bits are set according to the configuration selected. For inactive (off) timeslots, burst control bits are set to 0, and data is "unspecified." Pattern reset is set to 1 for the last byte in PRAM, causing the pattern to repeat after the last byte is read.

**NOTE** The data in pattern RAM is static. Firmware writes to PRAM once for the configuration selected and the hardware reads this data repeatedly. Firmware overwrites the volatile PRAM memory to reflect the desired configuration only when the data source or mode (digital communications format) is changed.

Take for example, transmitting a 228-bit user file for timeslot #1 (TS1) in a normal GSM transmission. Per the standard, a GSM normal channel is 156.25-bits long, with two 57-bit data fields (114 bits total per timeslot), and 42 bits for controlling or signalling purposes.

**NOTE** Compliant with the GSM standard, which specifies 156.25-bit timeslots, the signal generator uses 156-bit timeslots and adds an extra guard bit every fourth timeslot.

The seven remaining timeslots in the GSM frame are off. The user file will completely fill timeslot #1 in two consecutive frames, and will then repeat. See [Figure3-2](#).

**Figure 3-2 Mapping User File Data to a Single Timeslot**

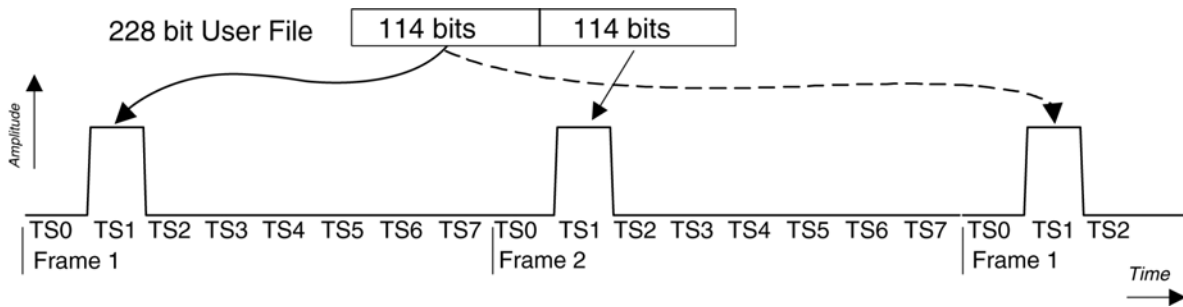

For this protocol configuration, the signal generator’s firmware loads pattern RAM with the bits defined in the following table.

**Table 3-1 PRAM Bit Definitions for GSM Normal Channel Transmission with a User File Data Source**

Frame	Timeslot	PRAM Address	Data Bits	Burst Bits	Pattern Reset Bit
1	0	0 -155	0/1 (don't care)	0 (off)	0 (off)
1	1 (on)	156 - 311	42 bits set by GSM standard & first 114 bits of user file	1 (on)	0
1	2	312 - 467	0/1 (don't care)	0	0
1	3	468 - 624	0/1 (don't care)	0	0
1	4	625 - 780	0/1 (don't care)	0	0

**Table 3-1 PRAM Bit Definitions for GSM Normal Channel Transmission with a User File Data Source (Continued)**

Frame	Timeslot	PRAM Address	Data Bits	Burst Bits	Pattern Reset Bit
1	5	781 - 936	0/1 (don't care)	0	0
1	6	937 - 1092	0/1 (don't care)	0	0
1	7	1093 - 1249	0/1 (don't care)	0	0
2	0	1250 - 1405	0/1 (don't care)	0	0
2	1 (on)	1406 - 1561	42 bits set by GSM standard & remaining 114 bits of user file	1 (on)	0
2	2 through 6	1562 - 2342	0/1 (don't care)	0	0 (off)
2	7	2343 - 2499	0/1 (don't care)	0	0 (1 in address 2499 only)

Event 1 output is set to 0 or 1 depending on the sync out selection, which enables the Event 1 output at either the beginning of the frame, beginning of a specific timeslot, or at all timeslots.

Because timeslots are configured and enabled within the signal generator, a user file can be individually assigned to one or more timeslots. A timeslot cannot have more than one data source (PN sequence or user file) specified for it. The amount of user file data that can be mapped into hardware memory depends on both the amount of PRAM available on the baseband generator, and the number and size of each frame. The amount of PRAM required for a framed transmission is:

PRAM required = size of timeslot × timeslots per frame × number of frames

and

size of timeslot = bits per timeslot

number of frames = frames per multiframe × muliframes per superframe

For example, to generate a superframe for GSM:

$$= 156.25 \times 8 \times 26 \times 51$$

$$= 1,657,5000 \text{ bytes.}$$

The 1 Mbyte memory available with Option UN8 is not sufficient for this application. Option UN9 with 8 Mbytes is required.

### Multiple User Files Selected as Data Sources for Different Timeslots

If two or more user files are selected for a framed transmission, the amount of PRAM required is determined by the user file that generates the largest number of frames. In order to generate continuously repeating data patterns, each user file must be long enough to completely fill an integer number of timeslots. In addition, all user files must meet the

“multiple of 8 bits” and “enough PRAM memory” requirements to be correctly modulated.

For example, user file #1 contains 114 bits and fills the data fields of a normal GSM timeslot, and user file #2 contains 148 bits for a custom GSM timeslot. In order to correctly transmit these data patterns as continuously repeating user files without discontinuities, both data patterns must be repeated four times. Therefore, user file #1 contains 456 bits, and user file #2 contains 592 bits. Each user file will then create exactly four frames in pattern RAM.

When two or more user files generate different numbers of complete frames, the user files will repeat on different cycles. All user files will restart when the user file that generates the largest number of frames repeats. For example, user file #1 needs four frames to completely transmit its data, and user file #2 needs only three. User file #2 will repeat after the third frame, and again when user file #1 repeats. See [Figure3-3.](#) If these were integer multiples of each other, both user files would be continuous, and user file #2 would repeat after two frames.

**Figure 3-3. Repeating Different Length User Files**

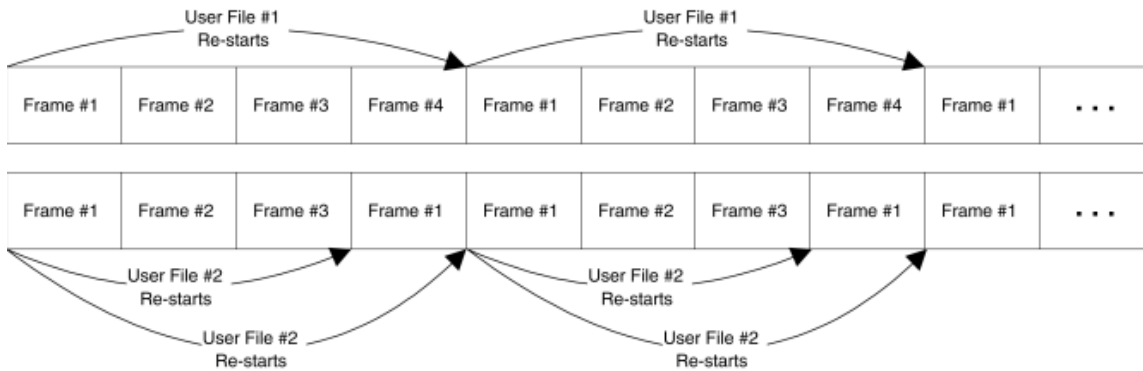

## PN9, PN15, and User File as Data Sources

If you select PN9 and/or PN15 to fill different timeslots without also selecting a user file, each PN sequence is hardware-generated to fill its designated timeslot. No discontinuity of the pseudorandom data occurs when the sequences are repeated.

When a PN sequence is selected to fill a timeslot and a user file is selected for another timeslot, the PN sequence is firmware-generated. The PN sequence is generated similarly to a user file.

During this process, PN9 sequences are handled differently than PN15.

A firmware-generated PN9 sequence always requires 511 frames to be continuous, regardless of the selected TDMA format. If the user file generates fewer than 511 frames, the user file will repeat as necessary to fill the data fields of the 511 frames. If the user file fills more than 511 frames, the PN9 sequence will repeat after the 511th frame, and repeat again when the user file repeats. In these cases, where the user file is not an integer multiple of 511 frames, either the user file or PN9 will be discontinuous.

Because of its length, a PN15 sequence will always be discontinuous regardless of whether a user file is selected for other timeslots, and regardless of the TDMA protocol selected.

The PN15 behaves just like a user file of equal length (32,767 bits).

## Downloading User File Data

This section includes information that explains how to download user file data. It includes data requirements and limitations, preliminary setup, SCPI commands and sample command lines for both downloads to the bit memory catalog and the binary memory catalog.

### Data Requirements and Limitations Summary

1. Data must be binary.
2. Bit length must be multiple of the data-field length of the active TDMA format.
3. User file size is limited by the available memory in the memory catalog.
4. When designing user files, you must consider the signal generator's PRAM size (1 Mbyte or 8 Mbyte), framing overhead, and the available memory in the memory catalog.
5. For downloads to the binary memory catalog, bit length must be multiple of 8.

### Preliminary Setup

No preliminary setup is required for user file downloads.

### Bit Memory Catalog Downloads

The bit memory catalog accepts data in any integer number of bits, up to the maximum available memory in the bit memory catalog (approximately 1 Mbit). The data length in bytes for files downloaded to the bit memory catalog is equal to the number of significant bits plus seven, divided by eight, then rounded down to the nearest integer.

You must have enough bytes to contain the bits you specify. If the number of bits is not a multiple of 8, the least significant bits of the last byte will be ignored.

For example, specifying 14 bits of a 16-bit string using the command `:MEMory:DATA:BIT "userfile1", 14, #12Qz` results in the last 2 bits being ignored. See the following figure.

```
010 0001 0111 1010    original user-defined data contains 2 bytes, 16 bits total
                                SCPI command sets bit count to 14; the last 2 bits are ignored
010 0001 0111 1010
010 0001 0111 10      only the most significant 14 bits are downloaded and stored as a bit file
```

The bit memory catalog provides more versatility and is the preferred memory catalog for user file downloads.

**SCPI Commands** `:MEMory:DATA:BIT "<file name>", <bit count>, <datablock>`

Execute this command to download the user file data into the signal generator's bit memory catalog. The variable `<file name>` denotes the name that will be associated with the downloaded user file within the signal generator.



**Sample Command Line** :MEMory:DATA:BIT "<file name>", <bit count>, #ABC

<file name> the name of the user file within the signal generator.

<bit count> the number of significant bits in the data block.

A the number of decimal digits to follow in B.

B a decimal number specifying the number of data bytes in C.

C the binary user file data.

**Example 1** :MEMory:DATA:BIT "userfile1", 16, #12Qz

userfile1 provides the user file name as it will appear in the signal generator's binary memory catalog.

1 defines the number of decimal digits to follow in "B".

2 denotes how many bytes of data are to follow.

Qz the ASCII representation of the 16 bits of data that are downloaded to the signal generator. This variable is represented by "C" in the sample command line.

---

**NOTE** Not all binary values can be printed as ASCII characters. In fact, only ASCII characters corresponding to decimal values 32 to 126 are printable keyboard characters. Typically, the binary value corresponding to your 8-bit pattern is not printable.

Therefore, the program written to download and upload user files *must correctly* convert between binary and the visible representation of the data sequence.

---

**Querying the Waveform Data** Use the following SCPI command line to upload user file data from the binary memory catalog to the controller:

```
:MEMory:DATA:BIT? "<file name>"
```

The output format is the same as the input format.

### Binary Memory Catalog Downloads

The binary memory catalog requires data formatted in 8-bit bytes. Files stored or downloaded to the Binary catalog are converted to bit files prior to editing in the Bit File Editor. Afterward, these modified files from the binary memory catalog are stored in the bit memory catalog as bit files.

The bit memory catalog provides more versatility and is the preferred memory catalog for user file downloads.

**SCPI Commands** :MMEM:DATA "<file name>", <datablock>

Execute this command to download the user file data into the signal generator's binary memory catalog. The variable <file name> denotes the name that will be associated with the downloaded user file within the signal generator.

**Sample Command Line** :MMEM:DATA "<file name>", #ABC

"<file name>" the name of the user file within the signal generator.

- A the number of decimal digits to follow in B.
- B a decimal number specifying the number of data bytes in C.
- C the binary user file data.

**Example 1** :MMEM:DATA "userfile1", #1912S407897

- userfile1 provides the user file name as it will appear in the signal generator's binary memory catalog.
- 1 defines the number of decimal digits to follow in "B".
- 9 denotes how many bytes of data are to follow.
- 12S407897 the ASCII representation of the data that is downloaded to the signal generator. This variable is represented by C in the sample command line.

---

**NOTE** Not all binary values can be printed as ASCII characters. In fact, only ASCII characters corresponding to decimal values 32 to 126 are printable keyboard characters. The previous example was carefully chosen for simplicity. Typically, the binary value corresponding to your 8-bit pattern is not printable.

Therefore, the program written to download and upload user files *must correctly* convert between binary and the visible representation of the data sequence.

---

**Querying the Waveform Data** Use the following SCPI command line to upload user file data from the binary memory catalog to the controller:

```
:MMEM:DATA? "<file name>"
```

The output format is the same as the input format.

## Selecting Downloaded User Files as the Transmitted Data

### From the Front Panel

To select the user file as a continuous stream of unframed data for the active TDMA format or for a custom modulation, press **Mode > desired format** or **Custom > Data > User File**. Highlight the desired file in the catalog of user files and press **Select File**.

To activate the TDMA format press **Mode > desired format** and toggle the format on.

To activate custom modulation press **Mode > Custom** and toggle the **Custom Off On** softkey on.

### Remotely

Execute the following SCPI command to select the user file from the bit memory catalog as

a continuous stream of unframed data for the active TDMA format.

---

**NOTE** To select a user file from the binary memory catalog, execute the same commands shown in the following examples without BIT: preceding the filename.

For example, [:SOURCE]:RADIO:<desired format>:DATA "<file name>"

---

```
[:SOURCE]:RADIO:<desired format>:DATA "BIT:<file name>"
```

```
[:SOURCE]:RADIO:<desired format>[:STATE] On activates the desired TDMA format.
```

Execute the following SCPI command to select the user file as a continuous stream of data for the custom modulation format.

```
[:SOURCE]:RADIO:CUSTOM:DATA "BIT:<file name>"
```

```
[:SOURCE]:RADIO:CUSTOM[:STATE] On activates the custom modulation format.
```

### From the Front Panel

To select the user file as framed data for the active TDMA format: press **Mode > desired format > Data Format Pattern Framed > Configure Timeslots > Configure (current active timeslot) > Data > User File**. Highlight the desired file in the catalog of user files and press **Select File**.

To activate the TDMA format press **Mode > desired format** and toggle the format on.

### Remotely

Execute the following SCPI command to select the user file as framed data for an NADC uplink traffic channel in timeslot 1. Modify the command as necessary for other formats.

```
[:SOURCE]:RADIO:NADC:SLOT1:UTChannel:DATA "BIT:<file name>"
```

```
[:SOURCE]:RADIO:NADC[:STATE] On activates the NADC format.
```

## Modulating and Activating the Carrier

The following section explains how to modulate the carrier, and activate the RF output; first from the front-panel interface and then via remote SCPI commands.

### From the Front Panel

1. Set the carrier frequency to 2.5 GHz.
2. Set the carrier amplitude -10.0 dBm.
3. Modulate the carrier.
4. Activate the RF output.

### Remotely

Execute the following SCPI commands to modulate and activate the carrier:

[ :SOURce]:RADio:<desired format>[:STATe] On activates the desired TDMA format.

[ :SOURce]:FREQuency:FIXed 2.5GHZ sets the carrier frequency to 2.15 GHz.

[ :SOURce]:POWer[:LEVel][:IMMediate][:AMPLitude] -10.0DBM sets the carrier amplitude to -10.0 dBm.

:OUTPut:MODulation[:STATe] ON modulates the carrier.

:OUTPut[:STATe] ON activates the RF output.

---

## FIR Filter Coefficient Data Downloads

Options UN8 and UND signal generators accept finite impulse response (FIR) filter coefficient data downloads. After downloading the data, these user-defined FIR filter coefficient values can be selected as the filtering mechanism for the active digital communications standard.

This chapter contains information that will help you transfer user Finite Impulse Response filter data from a system controller to your signal generator.

This section explains how to download user-defined FIR filter coefficient files into the signal generator's memory catalog and activate them. It is divided into the following subsections:

### Data Requirements

There are two requirements for FIR filter coefficient data downloads:

1. Data must be in ASCII format.

The signal generator processes FIR filter coefficients as floating point numbers.

2. Data must be in List format.

FIR filter coefficient data is processed as a list by the signal generator's firmware. See [“Sample Command Line”](#) on page 3-30.

### Data Limitations

Filter lengths of up to 1024 taps are allowed. The oversample ratio (OSR) is the number of filter taps per symbol. Oversample ratios from 1 through 32 are possible.

The maximum combination of OSR and symbols allowed is 32 symbols with an OSR of 32. The signal generator's hardware achieves the filtering through a combination of digital and analog implementation.

Option UN8 is limited to 256 taps, 32 symbols and a 16-times oversample ratio. Therefore, any number of taps you insert are digitally resampled into a maximum of 16-times oversampling with 16 symbols, or a maximum 8-times oversampling with 32 symbols. FIR filters more than 32 symbols long cannot be used.

Option UND is limited to 512 taps and 24 symbols.

The sampling period ( $\Delta t$ ) is equal to the inverse of the sampling rate ( $F_s$ ). The sampling rate is equal to the symbol rate multiplied by the oversample ratio. For example, the GSM symbol rate is 270.83 ksps. With an oversample ratio of 4, the sampling rate is 1083.32 kHz and  $\Delta t$  (inverse of  $F_s$ ) is 923.088 nsec.

## Data Volatility

Downloaded FIR filter coefficient data is *nonvolatile*. It is stored to the instrument's memory catalog.

This data will survive a line power cycle. It will remain in the memory catalog until you delete the file, or until the signal generator's internal battery expires.

## Downloading FIR Filter Coefficient Data

### Preliminary Setup

No preliminary setup is required to download FIR filter coefficient data.

### SCPI Command to Download FIR Filter Coefficients

Use the following SCPI command line to download list data from the controller to the signal generator's FIR memory catalog:

```
:MEMory:DATA:FIR "<file name>",osr,coefficient{,coefficient}
```

### Querying the FIR Filter Coefficient Data

Use the following SCPI command line to upload list data from the FIR memory catalog to the controller:

```
:MEMory:DATA:FIR? "<file name>"
```

### Sample Command Line

For example, to download a typical set of FIR filter coefficient values, the command will look like this:

```
:MEMory:DATA:FIR "FIR1",4,0,0,0,0,0,0.000001,0.000012,0.000132,0.001101,  
0.006743,0.030588,0.103676,0.265790,0.523849,0.809508,1,1,0.809508,0.52384  
9,0.265790,0.103676,0.030588,0.006743,0.001101,0.000132,0.000012,0.000001,  
0,0,0,0,0
```

FIR1            assigns the name FIR1 to the associated OSR and coefficient values.  
                 The file is then represented with this name in the FIR File catalog.

4                specifies the oversample ratio.

0,0,0,0,0,  
0.000001,... represent FIR filter coefficients.

## Selecting Downloaded User FIR Filters as the Active Filter

### From the Front Panel

To select the downloaded FIR filter data as the active filter for a TDMA format, press **Mode > TDMA > desired format > Modify Standard > Filter > Select > User FIR**. Highlight the desired file in the catalog of FIR files and press **Select File**.

To activate the TDMA format press **Mode > desired format >** and toggle the format on.

To select the downloaded FIR filter data as the active filter for a custom modulation, press **Mode > Custom > Filter > Select > User FIR**. Highlight the desired file in the catalog of FIR files and press **Select File**.

To activate the custom modulation, press **Mode > Custom > Custom Off On**.

To select the downloaded FIR filter data as the active filter for a CDMA modulation, press **Mode > CDMA Formats > desired format > CDMA Define or W-CDMA Define > Filter > Select > User FIR**. Highlight the desired file in the catalog of FIR files and press **Select File**.

To activate the CDMA modulation, press **Mode > CDMA Formats > desired format >** and toggle the format on.

### Using the Remote Interface

Execute the following SCPI command to select the downloaded FIR filter data as the active filter for a TDMA modulation format.

```
[ :SOURCE]:RADio:<desired format>:FILTer "<file name>" selects the user FIR filter you specify by file name as the active filter for the specified TDMA modulation format.
```

```
[ :SOURCE]:RADio:<desired format>[:STATE] On activates the desired TDMA format.
```

Execute the following SCPI command to select the downloaded FIR filter data as the active filter for custom modulation.

```
[ :SOURCE]:RADio:CUSTom:FILTer "<file name>" selects the user FIR filter you specify by file name as the active filter for the custom modulation format.
```

```
[ :SOURCE]:RADio:CUSTom[:STATE] On activates the custom modulation format.
```

Execute the following SCPI command to select the downloaded FIR filter data as the active filter for custom modulation.

```
[ :SOURCE]:RADio:<desired format>:ARB:FILTer "<file name>" selects the user FIR filter you specify by file name as the active filter for the CDMA modulation format.
```

```
[ :SOURCE]:RADio:<desired format>:ARB[:STATE] On activates the CDMA modulation format.
```

### Modulating and Activating the Carrier

The following section explains how to modulate the carrier, first from the front-panel interface, and then via remote SCPI commands.

#### From the Front Panel

To set the carrier frequency to 2.5 GHz, press **Frequency > 2.5 > GHz**.

To set the carrier amplitude -10.0 dBm, press **Amplitude > -10 > dBm**.

To modulate the carrier, press **Mod On/Off** until the display annunciator reads MOD ON.

To activate the RF output, press **RF On/Off** until the display annunciator reads RF ON.

### Using the Remote Interface

Execute the following SCPI commands to modulate and activate the carrier:

`[ :SOURce ] :FREQuency :FIXed 2.5GHZ` sets the carrier frequency to 2.15 GHz.

`[ :SOURce ] :POWer [ :LEVel ] [ :IMMediate ] [ :AMPLitude ] -10.0DBM` sets the carrier amplitude to -10.0 dBm.

`:OUTPut :MODulation [ :STATe ] ON` modulates the carrier.

`:OUTPut [ :STATe ] ON` activates the RF output.



---

## Data Downloads Directly into Pattern RAM

Option UN8 or UN8/UN9 signal generators accept data downloaded directly into the data generator's pattern RAM. After downloading, this data can be used to stimulate the baseband generator's I/Q modulator. Direct downloads to PRAM allow you complete control over bursting, especially helpful for designing experimental or proprietary framing schemes.

This section contains information that will help you transfer user-generated experimental or proprietary data from a system controller to the signal generator's pattern RAM. It explains how to download data directly into pattern RAM and modulate the carrier signal with the data. It is divided into the following subsections:

Signal generators with Option UN8 contain a baseband generator assembly. This assembly builds modulation schemes by reading data stored to a pattern RAM assembly and constructing framing protocols according to the data patterns present in PRAM. PRAM data can be manipulated (types of protocols changed, standard protocols modified or customized, etc.) by the front-panel interface or by remote-command interface.

Typically, the signal generator's firmware generates the required data and framing structure and loads this data into PRAM. The data is subsequently read by the baseband generator, which in turn stimulates the input of the I/Q modulator. The signal generator is also equipped to accept data downloads directly into pattern RAM from a remote computer. After using a program such as MatLab™ or MathCad™ to generate the data, the data can be downloaded directly into PRAM in either a list format or a block format.

---

**NOTE** Because there is no parsing involved, block data format downloads are *significantly* faster than list format downloads.

---

### Data Requirements

There are two requirements for data downloaded directly into pattern RAM:

- Data must be in binary form.

The data must be in binary form because the baseband generator is designed to receive data in binary form from the data generator.

- For every bit of modulation data (bit 0), you must provide 7 bits of control information (bits 1-7).

The signal generator processes data in 8-bit bytes. Because the signal generator's firmware adds seven control bits to each bit of data to be modulated, each bit of user-defined data is contained within an 8-bit byte, or "address" in pattern RAM. Each byte in PRAM is organized as shown in [Table 3-2](#). When designing waveform data for subsequent direct download into pattern RAM, every bit of "modulation data" *must* be accompanied by these other seven control bits, forming an 8-bit byte that will occupy a

## Data Downloads Directly into Pattern RAM

specific address in PRAM.

**Table 3-2 Data and Control Bit Definitions for a Pattern RAM Address**

Bit	Function	Value	Comments
0	Data	0/1	This bit is the data to be modulated. This bit is a “don’t care” when burst (bit 2) is set to 0.
1	Reserved	0	Always 0.
2	Burst	0/1	Set to 1 = RF on. Set to 0 = RF off. For non-bursted, non-TDMA systems, this bit is set to 1 for all memory locations, leaving the RF output on continuously. For framed data, this bit is set to 1 for the valid data bits for <i>on</i> timeslots and 0 for all <i>off</i> timeslots.
3	Reserved	0	Always 0
4	Reserved	1	Always 1
5	Reserved	0	Always 0
6	Event 1 Output	0/1	Setting this bit to 1 causes a level transition at the EVENT 1 BNC connector. This can be used for many functions. For example, as a marker output to trigger external hardware when the data pattern has restarted, or to create a data-synchronous pulse train by toggling this bit in alternate addresses.
7	Pattern Reset	0/1	Set to 0 = continue to next sequential memory address. Set to 1 = end of memory and restart memory playback. This bit is set to 0 for all bytes except the last address of PRAM. For the last address (byte) of PRAM, it is set to 1 to restart the pattern.

## Data Limitations

Total (data bits plus control bits) download size limitations are 1 Mbyte for Option UN8 and 8 Mbytes for Option UN9.

It is important to remember that a data pattern file containing 1 Mbyte of data for subsequent modulation must also contain another 7 Mbytes of control information. A file of this size would require a signal generator with Option UN9 and its 8 Mbyte pattern RAM. The largest amount of modulation data for a waveform in an Option UN8 signal generator is approximately 1 Mbit, leaving enough room for the required 7 Mbits control bits.

## Data Volatility

PRAM data is *volatile*.

Data stored in PRAM will not survive a line power cycle. Also, it is overwritten whenever the mode is changed and a new TDMA format is activated.

## Downloading in List Format

---

**NOTE** Because of parsing, list data format downloads are *significantly* slower than block format downloads.

---

### Data Requirements and Limitations Summary

**1. Data must be 8-bit, unsigned integers, from 0 to 255.**

This is because list format downloads are parsed prior to being loaded into PRAM.

**2. For every bit of modulation data (bit 0), you must provide 7 bits of control information (bits 1-7).**

The signal generator processes data in 8-bit bytes. Each byte contains 1 bit of “data field” information, and seven bits of control information associated with the data field bit. See [Table 3-2](#) for the required data and control bits.

Total (data bits plus control bits) download size limitations are 1 Mbyte for Option UN8 and 8 Mbytes for Option UN9.

Because waveforms containing 1 Mbyte of data for subsequent modulation must also contain 7 Mbytes of control information, a file this size requires a signal generator with Option UN9 and its 8 Mbyte pattern RAM. The largest amount of modulation data for a waveform in an Option UN8 signal generator is approximately 1 Mbits, leaving enough room for the required 7 Mbits control bits.

### Preliminary Setup

It is important to set up the digital communications format before downloading data. This allows the signal generator to define the modulation format, filter, and data clock. Activating the digital communications format after the data has been downloaded to PRAM may damage the downloaded data.

#### From the Front Panel Interface

To set up the TDMA format, press **Mode** > **desired format** and toggle the format on.

To set up the custom modulation format, press **Mode** > **Custom** and toggle the format on.

To adjust symbol rate, filtering, or other parameters, press the appropriate softkey and adjust the value.

#### Via the Remote Interface

For TDMA formats, send the SCPI command:

```
[ :SOURce ]:RADio:<desired format>[ :STATe ]:ON
```

Or for custom modulation send: [ :SOURce ]:RADio:CUSTOm[ :STATe ]:ON

To adjust symbol rate, filtering, or other parameters, execute the appropriate SCPI command.

## Data Downloads Directly into Pattern RAM

**SCPI Command to Download Data in List Format**

```
:MEMory:DATA:PRAM:LIST <uint8>[,<uint8>,<...>]
```

This command downloads the list-formatted data directly into pattern RAM. The variable <uint8> is any of the valid 8-bit, unsigned integer values between 0 and 255, as specified by [Table 3-2](#). Note that each value corresponds to a unique byte/address in PRAM.

**Sample Command Line**

For example, to burst a FIX4 data pattern of “1100” five times, then turn the burst off for 32 data periods (assuming a 1-bit/symbol modulation format), the command is:

```
:MEMory:DATA:PRAM:LIST 21,21,20,20,21,21,20,20,21,21,20,20,21,21,20,20,21,
21,20,20,16,16,16,16,16,16,16,16,16,16,16,16,16,16,16,16,16,16,16,16,16,
16,16,16,16,16,16,16,16,16,16,144
```

21                   signifies data=1, burst = on (1).

20                   signifies data=0, burst = on (1).

16                   signifies data=unspecified, burst = off (0).

144                  signifies data=unspecified, burst = off (0), pattern repeat = on (1).

**Querying the Waveform Data**

Use the following SCPI command line to determine whether there is a user-defined pattern in the PRAM:

```
:MEMory:DATA:PRAM?
```

**Downloading in Block Format**

---

**NOTE**            Because there is no parsing, block data format downloads are *significantly* faster than list format downloads.

---

**Data Requirements and Limitations Summary****1. Data must be in binary form.**

This is because the baseband generator reads binary data from the data generator.

**2. For every bit of modulation data (bit 0), you must provide 7 bits of control information (bits 1-7).**

The signal generator processes data in 8-bit bytes. Each byte contains 1 bit of “data field” information, and seven bits of control information associated with the data field bit. See [Table 3-2](#) for the required data and control bits.

Total (data bits plus control bits) download size limitations are 1 Mbyte for Option UN8 and 8 Mbytes for Option UN9.

Because a waveform containing 1 Mbit of data for subsequent modulation must also

contain another 7 Mbits of control information, a file this size requires a signal generator with Option UN9 and its 8 Mbyte pattern RAM. The largest amount of modulation data for a waveform in an Option UN8 signal generator is approximately 125 kbits, which leaves enough room for the required 875,000 control bits.

### Preliminary Setup

Before downloading data, set up the digital communications format to enable the signal generator to define the modulation format, filter, and data clock. Activating the digital communications format *after* data downloads to PRAM can damage the data.

### From the Front Panel Interface

To set up the TDMA format, press **Mode** > **desired format** and toggle the format on.

To set up a custom modulation format, press **Mode** > **Custom** and toggle the format on.

To adjust symbol rate, filtering, or other parameters, press the appropriate softkey and adjust the value.

### Via the Remote Interface

For TDMA formats, send the SCPI command:

```
[ :SOURce ]:RADio:<desired format>[ :STATe ]:ON
```

Or for custom modulation send: [ :SOURce ]:RADio:CUSTom[ :STATe ]:ON

To adjust symbol rate, filtering, or other parameters, execute the appropriate SCPI command.

### SCPI Command to Download Data in Block Format

```
:MEMory:DATA:PRAM:BLOCK <datablock>
```

This command downloads the block-formatted data directly into pattern RAM.

### Sample Command Line

A sample command line:

```
:MEMory:DATA:PRAM:BLOCK #ABC
```

- A            the number of decimal digits to follow in B.
- B            a decimal number specifying the number of data bytes in C.
- C            the binary user file data.

### Example 1

```
:MEMory:DATA:PRAM:BLOCK #1912S407897
```

1 defines the number of decimal digits to follow in “B”.

9 denotes how many bytes of data are to follow.

12S407897 is the ASCII representation of the data downloaded to the signal generator. This variable is represented by C in the sample command line.

---

**NOTE** Not all binary values can be printed as ASCII characters. In fact, only ASCII characters corresponding to decimal values 32 to 126 are printable keyboard characters. The above example was carefully chosen for simplicity. Typically, the binary value corresponding to your 8-bit pattern is not printable.

Therefore, the program written to download and upload user files *must correctly convert* between binary and the visible representation of the data sequence.

---

## Modulating and Activating the Carrier

The following section explains how to modulate the carrier with the data downloaded to PRAM, first from the front-panel interface, and then via remote SCPI commands.

### From the Front Panel Interface

1. Set the carrier frequency to 2.5 GHz (**Frequency > 2.5 > GHz**).
2. Set the carrier amplitude  $-10.0$  dBm (**Amplitude >  $-10$  > dBm**).
3. Turn modulation on (press **Mod On/Off** until the display annunciator reads MOD ON).
4. Activate the RF output (press **RF On/Off** until the display annunciator reads RF ON).

### Via the Remote Interface

Execute the following SCPI commands to modulate and activate the carrier.

1. Set the carrier frequency to 2.15 GHz:  

```
[ :SOURce ] :FREQuency:FIXed 2.5GHZ
```
2. Set the carrier power to  $-10.0$  dBm:  

```
[ :SOURce ] :POWER [ :LEVel ] [ :IMMediate ] [ :AMPLitude ] -10.0DBM
```
3. Activate the modulation:  

```
:OUTPut:MODulation [ :STATe ] ON
```
4. Activate the RF output:  

```
:OUTPut [ :STATe ] ON
```

## Data Transfer Troubleshooting

This section is divided by data transfer method:

“[Direct PRAM Download Problems](#)” on page 3-33

“[User File Download Problems](#)” on page 3-35

“[User FIR Filter Coefficient File Download Problems](#)” on page 3-38

“[ARB Waveform Data Download Problems](#)” on page 3-38

Each section contains the following troubleshooting information:

- a list of symptoms and possible causes of typical problems encountered while downloading data to the signal generator
- reminders regarding special considerations, file requirements, and data limitations
- tips on creating data, transferring data, data application and memory usage

### Direct PRAM Download Problems

**Table 3-3 Direct-to-PRAM Download Trouble - Symptoms and Causes**

Symptom	Possible Cause
The transmitted pattern is interspersed with random, unwanted data.	<p>Pattern reset bit not set.</p> <p>Insure that the pattern reset bit (bit 7, value 128) is set on the last byte of your downloaded data.</p>
ERROR -223, Too much data	<p>PRAM download exceeds the size of PRAM memory.</p> <p>Either use a smaller pattern or get more memory by ordering the appropriate hardware option.</p>

### Data Requirement Reminders

To avoid direct-download-to-PRAM problems, the following conditions *must* be met:

1. The data must be in binary form.
2. For every bit of modulation data (bit 0), you must provide seven bits of control information (bits 1-7).

Bit	Function	Value	Comments
0	Data	0/1	This bit is the data to be modulated. This bit is a “unspecified” when burst (bit 2) is set to 0.
1	Reserved	0	Always 0.
2	Burst	0/1	Set to 1 = RF on. Set to 0 = RF off. For non-bursted, non-TDMA systems, this bit is set to 1 for all memory locations, leaving the RF output on continuously. For framed data, this bit is set to 1 for <i>on</i> timeslots and 0 for <i>off</i> timeslots
3	Reserved	0	Always 0.
4	Reserved	1	Always 1.
5	Reserved	0	Always 0.
6	Event 1 Output	0/1	Setting this bit to 1 causes a level transition at the EVENT 1 BNC connector. This can be used for many functions. For example, as a marker output to trigger external hardware when the data pattern has restarted, or to create a data-synchronous pulse train by toggling this bit in alternate addresses.
7	Pattern Reset	0/1	Set to 0 = continue to next sequential memory address. Set to 1 = end of memory and restart memory playback. This bit is set to 0 for all bytes except the last address of PRAM. For the last address (byte) of PRAM, it is set to 1 to restart the pattern.



## User File Download Problems

**Table 3-4 User FIR File Download Trouble - Symptoms and Causes**

Symptom	Possible Cause
No data modulated	<p>Not enough data to fill a single timeslot.</p> <p>If a user file does not completely fill a single timeslot, the firmware will not load any data into the timeslot. For example, if a timeslot's data field should contain 114 bits, and only 100 bits are provided in the user file, no data will be loaded into the data field of the timeslot. Therefore, no will be detected at the RF output.</p>
At RF output, some data modulated, some data missing	<p>Data does not completely fill an integer number of timeslots.</p> <p>If a user file fills the data fields of more than one timeslot in a continuously repeating framed transmission, the user file will be restarted after the last timeslot containing completely filled data fields. For example, if the user file contains enough data to fill the data fields of 3.5 timeslots, firmware will load 3 timeslots with data and restart the user file after the third timeslot. The last 0.5 timeslot worth of data will never be modulated.</p>

### Data Requirement Reminders

To avoid user file data download problems, the following conditions *must* be met:

1. The user file selected must entirely fill the data field of each timeslot.
2. For Binary memory catalog downloads, the user file must be a multiple of 8 bits, so that it can be represented in ASCII characters.
3. Available PRAM must be large enough to support both the data field bits and the framing bits.

### Requirement for Continuous User File Data Transmission

**“Full Data Field” Requirements** If a user file does not *completely* fill a single timeslot, the firmware does not load *any* data into that timeslot. For example, if a timeslot's data field should contain 114 bits, and only 100 bits are provided in the user file, no data is loaded into the timeslot data field, and no data is transmitted at the RF output.

To solve this problem, add bits to the user file until the it completely fills the data field of the active protocol.

**“Integer Number of Timeslots” Requirement for Multiple-Timeslots** If a user file fills the data fields of more than one timeslot in a continuously repeating framed transmission, the user file is restarted after the last timeslot containing completely filled data fields. For example, if the user file contains enough data to fill the data fields of 3.5 timeslots, firmware loads 3 timeslots with data and restart the user file after the third timeslot. The last 0.5 timeslot worth of data is never modulated.

To solve this problem, add or subtract bits from the user file until it completely fills an integer number of timeslots

**“Multiple-of-8-Bits” Requirement** For downloads to the binary memory catalog, user file data must be downloaded in multiples of 8 bits, since SCPI specifies data in 8-bit bytes. Therefore, if the original data pattern’s length is not a multiple of 8, you may need to:

- Add additional bits to complete the ASCII character
- replicate the data pattern to generate a continuously repeating pattern with no discontinuity
- truncate the remaining bits

---

**NOTE** The “multiple-of-8-bits” data length requirement (for binary memory catalog downloads) is in *addition* to the requirement of completely filling the data field of an integer number of timeslots.

---

The following method can be used to compute the number of data pattern repetitions required in order to form a continuous data stream.

In this example, a modified PN9, 511-bit data pattern is to be applied as the data source for a 114-bit data field in a GSM Normal timeslot.

Set up a spreadsheet containing:

- A = number of repetitions of the original data pattern
- B = user file length = number of repetitions × original data pattern length
- C = Number of characters = user file length ÷ 8 (8 bits-per-character)
- D = number of frames = user file length ÷ timeslot data field size (114)
- E = total required PRAM = number of frames × number of bits-per-frame (1250 for GSM)

**Table 3-5 Data Pattern Repetitions for Continuous Data Stream**

<b>A</b>	<b>B</b>	<b>C</b>	<b>D</b>	<b>E</b>
<b>Number of reps</b>	<b>Data Pattern Length × Repetitions</b>	<b>Number of Characters (B ÷ 8)</b>	<b>Number of frames needed to end on a timeslot boundary (B ÷ timeslot data field size)</b>	<b>Total PRAM required (D × number of bits-per-frame)</b>
1	511	63.88	4.48	5,603.07
2	1,022	127.75	8.96	11,206.14
3	1,533	191.63	13.45	16,809.21
4	2,044	255.50	17.93	22,412.28
5	2,555	319.38	22.41	28,015.35
6	3,066	383.25	26.89	33,618.42
7	3,577	447.13	31.38	39,221.49

**Table 3-5 Data Pattern Repetitions for Continuous Data Stream (Continued)**

<b>A</b>	<b>B</b>	<b>C</b>	<b>D</b>	<b>E</b>
<b>Number of reps</b>	<b>Data Pattern Length × Repetitions</b>	<b>Number of Characters (B ÷ 8)</b>	<b>Number of frames needed to end on a timeslot boundary (B ÷ timeslot data field size)</b>	<b>Total PRAM required (D × number of bits-per-frame)</b>
8	4,088	511	35.86	44,824.56
9	4,599	574.88	40.34	50,427.63
...	...	...	...	...
455	232,505	29,063.13	2,039.52	2,549,396.92
456	233,016	29,127	2,044	2,555,000

The first row where both columns C and D are integers (the shaded row at the bottom of the table) is the minimum number of repetitions required to transmit the user file without discontinuity. In this example, in order to correctly generate the modified PN9 and download it to a user file, the user file must contain 456 repetitions of the 511-bit pattern. 233,016 total bits will be downloaded to the signal generator, for a total of 29,127 characters.

**“Pattern RAM Memory Space” Requirement** It is possible to exhaust the available PRAM with a large, continuous user file transmitted across a large number of frames.

In the previous example, selecting the 233,016-bit user file as the data source for the GSM Normal timeslot will cause the firmware to compute 2,044 frames of data, filling 2,555,000 bytes of PRAM space. Option UN9 (8 Mbyte pattern RAM) is required for this configuration. Trying to load this data on an Option UN8 (1 Mbyte pattern RAM) signal generator will cause an error, because there is not enough PRAM to hold the required data.

If PN11 was used instead of PN9, 456 repetitions of the data pattern would require a 933,432-bit user file, requiring 8,188 frames and 10,235,000 bytes of PRAM. Because the size of this data exceeds the limits of Option UN9 (8 Mbyte PRAM), you would need to supply a file this size via the external DATA connector.

**Using Externally-Generated, Real-Time Data for Large Files** If the data fields absolutely must be continuous data streams, and the size of the data exceeds the available PRAM, real-time data and synchronization can be supplied by an external data source to the front-panel DATA, DATA CLOCK, and SYMBOL SYNC connectors. This data can be continuously transmitted, or can be framed by supplying a data-synchronous burst pulse to the EXT1 INPUT connector on the front panel. Additionally, the external data can be multiplexed into the internally-generated framing.

---

**NOTE** This chapter does not cover externally-generated real-time data. See the ESG Family Signal Generator User’s Guide for details and timing diagrams.

---

## User FIR Filter Coefficient File Download Problems

**Table 3-6 User FIR File Download Trouble - Symptoms and Causes**

Symptom	Possible Cause
ERROR -321, Out of memory	<p>There is not enough space in the memory catalog for the FIR coefficient file being downloaded.</p> <p>To solve the problem, either reduce the file size of the FIR file or delete unnecessary files from the memory catalog.</p>
ERROR -223, Too much data	<p>User FIR filter has too many symbols.</p> <p>Option UN8 cannot use a filter that has more than 32 symbols (24 symbols maximum for Option UND). You may have specified an incorrect oversample ratio in the filter table editor.</p>

### Data Requirement Reminders

To avoid user FIR filter coefficient data download problems, the following conditions *must* be met:

1. Data must be in ASCII format.
2. Downloads must be in list format.
3. Filters containing more symbols than the hardware allows (32 for Option UN8 and 24 for Option UND) will not be selectable for that configuration.

## ARB Waveform Data Download Problems

**Table 3-7 I/Q Waveform Data Download Trouble - Symptoms and Causes**

Symptom	Possible Cause
ERROR 224, Text file busy.	<p>Attempting to download a waveform that has the same name as the waveform currently being played by the signal generator.</p> <p>To solve the problem, either change the name of the waveform being downloaded or turn off the ARB.</p>
ERROR -321, Out of memory.	<p>There is not enough space in the ARB memory for the waveform file being downloaded.</p> <p>To solve the problem, either reduce the file size of the waveform file or delete unnecessary files from ARB memory.</p>

### Data Requirement Reminders

To avoid I/Q waveform data download problems, the following six conditions *must* be met:

1. Data must be in unsigned, offset (binary) format.
2. Data must be in 2-byte integers, ordered MSB first to LSB last.

3. Input integers must be between 0 and 16383.
4. Each I and Q waveform must have at least 16 points (a point equals an integer).
5. Each I and Q waveform must contain an even number of points.
6. I and Q waveforms should be the same length. (Different length I and Q waveforms are allowed. The shorter waveform will give a 0V output from its end up to the length of the longer waveform.)



## 4 Softkey/Command Cross-Reference

This chapter provides tables that cross reference each of the SCPI commands to the corresponding front panel keys, and the 8656/57-compatible commands that are equivalent to SCPI commands.

## Front Panel Key Versus Command

Table 1 AM Softkeys

Key	SCPI Command
<b>AM Depth</b>	[ :SOURce]:AM[1]   2[:DEPT] <val><PCT> [ :SOURce]:AM[1]   2[:DEPT]?
<b>AM Depth Couple Off On</b>	[ :SOURce]:AM[1]   2[:DEPT]:TRACk ON OFF 1 0 [ :SOURce]:AM[1]   2[:DEPT]:TRACk?
<b>AM Off On</b>	[ :SOURce]:AM[1]   2:STATe ON OFF 1 0 [ :SOURce]:AM[1]   2:STATe?
<b>AM Path 1 2 WB</b>	[ :SOURce]:AM:WIDeband:STATe ON OFF 1 0 [ :SOURce]:AM:WIDeband:STATe?
<b>AM Rate</b>	[ :SOURce]:AM[1]   2:INTernAl[1]:FREQUency <val><unit> [ :SOURce]:AM[1]   2:INTernAl[1]:FREQUency?
<b>AM Source</b>	[ :SOURce]:AM[1]   2:SOURce INT[1]   EXT1   EXT2 [ :SOURce]:AM[1]   2:SOURce?
<b>AM Start Rate</b>	[ :SOURce]:AM[1]   2:INTernAl[1]:FREQUency <val><unit> [ :SOURce]:AM[1]   2:INTernAl[1]:FREQUency?
<b>AM Stop Rate</b>	[ :SOURce]:AM[1]   2:INTernAl[1]:FREQUency:ALTErnate <val> <unit> [ :SOURce]:AM[1]   2:INTernAl[1]:FREQUency:ALTErnate?
<b>AM Sweep Time</b>	[ :SOURce]:AM[1]   2:INTernAl[1]:SWEep:TIME <val><unit> [ :SOURce]:AM[1]   2:INTernAl[1]:SWEep:TIME?
<b>AM Sweep Trigger</b>	:TRIGger[:SEQUence]:SOURce BUS IMMediate EXTernAl KEY :TRIGger[:SEQUence]:SOURce?
<b>AM Tone 1 Rate</b>	[ :SOURce]:AM[1]   2:INTernAl[1]:FREQUency <val><unit> [ :SOURce]:AM[1]   2:INTernAl[1]:FREQUency?
<b>AM Tone 2 Ampl Percent Of Peak</b>	[ :SOURce]:AM[1]   2:INTernAl[1]:FREQUency:ALTErnate:AMPLitude: PERCent <val><unit> [ :SOURce]:AM[1]   2:INTernAl[1]:FREQUency:ALTErnate:AMPLitude: PERCent?
<b>AM Tone 2 Rate</b>	[ :SOURce]:AM[1]   2:INTernAl[1]:FREQUency:ALTErnate <val> <unit> [ :SOURce]:AM[1]   2:INTernAl[1]:FREQUency:ALTErnate?
<b>AM Waveform</b>	[ :SOURce]:AM[1]   2:INTernAl[1]:FUNCTion SHAPE SINE TRIangle  SQUare RAMP NOISE DUALsine SWEPTsine [ :SOURce]:AM[1]   2:INTernAl[1]:FUNCTion SHAPE?
<b>Bus</b>	[ :SOURce]:AM[1]   2:INTernAl[1]:SWEep:TRIGger BUS [ :SOURce]:AM[1]   2:INTernAl[1]:SWEep:TRIGger?



**Table 1 AM Softkeys**

<b>Key</b>	<b>SCPI Command</b>
<b>Dual-Sine</b>	[ :SOURce]:AM[1] 2:INTernal[1]:FUNction:SHAPE DUALsine [ :SOURce]:AM[1] 2:INTernal[1]:FUNction:SHAPE?
<b>Ext</b>	[ :SOURce]:AM[1] 2:INTernal[1]:SWEep:TRIGger EXTernal [ :SOURce]:AM[1] 2:INTernal[1]:SWEep:TRIGger?
<b>Ext 1 AC-Coupled</b>	[ :SOURce]:AM[1] 2:SOURce EXT1 [ :SOURce]:AM[1] 2:EXTernal[1]:COUpling AC [ :SOURce]:AM[1] 2:EXTernal[1]:COUpling?
<b>Ext 1 DC-Coupled</b>	[ :SOURce]:AM[1] 2:SOURce EXT1 [ :SOURce]:AM[1] 2:EXTernal[1]:COUpling DC [ :SOURce]:AM[1] 2:EXTernal[1]:COUpling?
<b>Ext 2 AC-Coupled</b>	[ :SOURce]:AM[1] 2:SOURce EXT2 [ :SOURce]:AM[1] 2:EXTernal2:COUpling AC [ :SOURce]:AM[1] 2:EXTernal2:COUpling?
<b>Ext 2 DC-Coupled</b>	[ :SOURce]:AM[1] 2:SOURce EXT2 [ :SOURce]:AM[1] 2:EXTernal2:COUpling DC [ :SOURce]:AM[1] 2:EXTernal2:COUpling?
<b>Immediate</b>	[ :SOURce]:AM[1] 2:INTernal[1]:SWEep:TRIGger IMMEDIATE [ :SOURce]:AM[1] 2:INTernal[1]:SWEep:TRIGger?
<b>Internal</b>	[ :SOURce]:AM[1] 2:SOURce INT[1] [ :SOURce]:AM[1] 2:SOURce?
<b>Noise</b>	[ :SOURce]:AM[1] 2:INTernal[1]:FUNction:SHAPE NOISE [ :SOURce]:AM[1] 2:INTernal[1]:FUNction:SHAPE?
<b>Ramp</b>	[ :SOURce]:AM[1] 2:INTernal[1]:FUNction:SHAPE RAMP [ :SOURce]:AM[1] 2:INTernal[1]:FUNction:SHAPE?
<b>Sine</b>	[ :SOURce]:AM[1] 2:INTernal[1]:FUNction:SHAPE SINE [ :SOURce]:AM[1] 2:INTernal[1]:FUNction:SHAPE?
<b>Square</b>	[ :SOURce]:AM[1] 2:INTernal[1]:FUNction:SHAPE SQUARE [ :SOURce]:AM[1] 2:INTernal[1]:FUNction:SHAPE?
<b>Swept-Sine</b>	[ :SOURce]:AM[1] 2:INTernal[1]:FUNction:SHAPE SWEPTSine [ :SOURce]:AM[1] 2:INTernal[1]:FUNction:SHAPE?
<b>Triangle</b>	[ :SOURce]:AM[1] 2:INTernal[1]:FUNction:SHAPE TRIangle [ :SOURce]:AM[1] 2:INTernal[1]:FUNction:SHAPE?
<b>Trigger In Polarity Neg Pos</b>	:TRIGger[:SEquence]:SLOPe POSitive NEGative :TRIGger[:SEquence]:SLOPe?
<b>Trigger Key</b>	[ :SOURce]:AM[1] 2:INTernal[1]:SWEep:TRIGger KEY [ :SOURce]:AM[1] 2:INTernal[1]:SWEep:TRIGger?
<b>Trigger Out Polarity Neg Pos</b>	:TRIGger:OUTPut:POLarity POSitive NEGative :TRIGger:OUTPut:POLarity?

**Table 2 Ampl Softkeys**

Key	SCPI Command
<b>ALC BW Normal Narrow</b>	[ :SOURce]:POWER:ALC:BWIDth BANDwidth NORMAL NARRow [ :SOURce]:POWER:ALC:BWIDth BANDwidth?
<b>ALC Off On</b>	[ :SOURce]:POWER:ALC[:STATe] ON OFF 1 0 [ :SOURce]:POWER:ALC[:STATe]?
<b>Ampl Offset</b>	[ :SOURce]:POWER[:LEVel][:IMMediate]:OFFSet <val><unit> [ :SOURce]:POWER[:LEVel][:IMMediate]:OFFSet?
<b>Alt Ampl Delta</b>	[ :SOURce]:POWER:ALTErnate:AMPLitude <val><unit> [ :SOURce]:POWER:ALTErnate:AMPLitude?
<b>Alt Ampl Off On</b>	[ :SOURce]:POWER:ALTErnate:STATE ON OFF 1 0 [ :SOURce]:POWER:ALTErnate:STATE?
<b>Alt Ampl Trigger</b>	[ :SOURce]:POWER:ALTErnate:TRIGger[:SOURce] INTERNAL  EXTERNAL MANual [ :SOURce]:POWER:ALTErnate:TRIGger[:SOURce]?
<b>Ampl Ref Set</b>	[ :SOURce]:POWER:REFerence <val><unit> [ :SOURce]:POWER:REFerence?
<b>Ampl Ref Off On</b>	[ :SOURce]:POWER:REFerence:STATE ON OFF 1 0 [ :SOURce]:POWER:REFerence:STATE?
<b>Atten Hold Off On</b>	[ :SOURce]:POWER:ATTenuation:AUTO ON OFF 1 0 [ :SOURce]:POWER:ATTenuation:AUTO?
<b>Do Power Search</b>	[ :SOURce]:POWER:ALC:SEARCh ONCE
<b>Manual Trigger</b>	[ :SOURce]:POWER:ALTErnate:MANual MAIN DELTA [ :SOURce]:POWER:ALTErnate:MANual?
<b>Power Search Manual Auto</b>	[ :SOURce]:POWER:ALC:SEARCh ON OFF 1 0 [ :SOURce]:POWER:ALC:SEARCh?
<b>Power Search Reference Fixed Modulated</b>	[ :SOURce]:POWER:ALC:SEARCh:REFerence FIXED MODulated [ :SOURce]:POWER:ALC:SEARCh:REFerence?

**Table 3 Amplitude Hardkey**

Key	SCPI Command
<b>Amplitude (hardkey)</b>	[ :SOURce]:POWER[:LEVel][:IMMediate][:AMPLitude] <val><unit> [ :SOURce]:POWER[:LEVel][:IMMediate][:AMPLitude]?

**Table 4 Display Contrast Hardkeys**

Key	SCPI Command
<b>Display Contrast (hardkeys)</b>	:DISPlay:CONTRast <value> :DISPlay:CONTRast?

**Table 5 FM Softkeys**

<b>Key</b>	<b>SCPI Command</b>
<b>Bus</b>	[ :SOURce]:FM[1] 2:INTernal[1]:SWEep:TRIGger BUS [ :SOURce]:FM[1] 2:INTernal[1]:SWEep:TRIGger?
<b>DCFM/DCΦM Cal</b>	:CALibration:DCFM
<b>Dual-Sine</b>	[ :SOURce]:FM[1] 2:INTernal[1]:FUNction:SHAPE DUALsine [ :SOURce]:FM[1] 2:INTernal[1]:FUNction:SHAPE?
<b>Ext</b>	[ :SOURce]:FM[1] 2:INTernal[1]:SWEep:TRIGger EXTErnal [ :SOURce]:FM[1] 2:INTernal[1]:SWEep:TRIGger?
<b>Ext 1 AC-Coupled</b>	[ :SOURce]:FM[1] 2:SOURce EXT1 [ :SOURce]:FM[1] 2:EXTErnal[1]:COUPling AC [ :SOURce]:FM[1] 2:EXTErnal[1]:COUPling?
<b>Ext 1 DC-Coupled</b>	[ :SOURce]:FM[1] 2:SOURce EXT1 [ :SOURce]:FM[1] 2:EXTErnal[1]:COUPling DC [ :SOURce]:FM[1] 2:EXTErnal[1]:COUPling?
<b>Ext 2 AC-Coupled</b>	[ :SOURce]:FM[1] 2:SOURce EXT2 [ :SOURce]:FM[1] 2:EXTErnal2:COUPling AC [ :SOURce]:FM[1] 2:EXTErnal2:COUPling?
<b>Ext 2 DC-Coupled</b>	[ :SOURce]:FM[1] 2:SOURce EXT2 [ :SOURce]:FM[1] 2:EXTErnal2:COUPling DC [ :SOURce]:FM[1] 2:EXTErnal2:COUPling?
<b>FM Dev</b>	[ :SOURce]:FM[1] 2[:DEViation] <val><unit> [ :SOURce]:FM[1] 2[:DEViation]?
<b>FM Dev Couple Off On</b>	[ :SOURce]:FM[1] 2[:DEViation]:TRACk ON OFF 1 0 [ :SOURce]:FM[1] 2[:DEViation]:TRACk?
<b>FM On Off</b>	[ :SOURce]:FM[1] 2:STATE ON OFF 1 0 [ :SOURce]:FM[1] 2:STATE?
<b>FM Rate</b>	[ :SOURce]:FM[1] 2:INTernal[1]:FREQuency <val><unit> [ :SOURce]:FM[1] 2:INTernal[1]:FREQuency?
<b>FM Source</b>	[ :SOURce]:FM[1] 2:SOURce?
<b>FM Start Rate</b>	[ :SOURce]:FM[1] 2:INTernal[1]:FREQuency <val><unit> [ :SOURce]:FM[1] 2:INTernal[1]:FREQuency?
<b>FM Stop Rate</b>	[ :SOURce]:FM[1] 2:INTernal[1]:FREQuency:ALTErnate <val> <unit> [ :SOURce]:FM[1] 2:INTernal[1]:FREQuency:ALTErnate?
<b>FM Sweep Time</b>	[ :SOURce]:FM[1] 2:INTernal[1]:SWEep:TIME <val><unit> [ :SOURce]:FM[1] 2:INTernal[1]:SWEep:TIME?
<b>FM Sweep Trigger</b>	:TRIGger[:SEQuence]:SOURce BUS IMMEdiate EXTErnal KEY :TRIGger[:SEQuence]:SOURce?

**Table 5 FM Softkeys**

Key	SCPI Command
<b>FM Tone 1 Rate</b>	[ :SOURce]:FM[1]   2:INTernal[1]:FREQuency <val><unit> [ :SOURce]:FM[1]   2:INTernal[1]:FREQuency?
<b>FM Tone 2 Ampl Percent Of Peak</b>	[ :SOURce]:FM[1]   2:INTernal[1]:FREQuency:ALTErnate: AMPLitude:PERCent <val><unit> [ :SOURce]:FM[1]   2:INTernal[1]:FREQuency:ALTErnate:AMPLitude:PERCent?
<b>FM Tone 2 Rate</b>	[ :SOURce]:FM[1]   2:INTernal[1]:FREQuency:ALTErnate <val><unit> [ :SOURce]:FM[1]   2:INTernal[1]:FREQuency:ALTErnate?
<b>FM Waveform</b>	[ :SOURce]:FM[1]   2:INTernal[1]:FUNctIon:SHAPE SINE   TRIangle   SQUare   RAMP   NOISE   DUALsine   SWEPTsine [ :SOURce]:FM[1]   2:INTernal[1]:FUNctIon:SHAPE?
<b>Immediate</b>	[ :SOURce]:FM[1]   2:INTernal[1]:SWEep:TRIGger IMMEDIATE [ :SOURce]:FM[1]   2:INTernal[1]:SWEep:TRIGger?
<b>Internal</b>	[ :SOURce]:FM[1]   2:SOURce INT[1] [ :SOURce]:FM[1]   2:SOURce?
<b>Noise</b>	[ :SOURce]:FM[1]   2:INTernal[1]:FUNctIon:SHAPE NOISE [ :SOURce]:FM[1]   2:INTernal[1]:FUNctIon:SHAPE?
<b>Ramp</b>	[ :SOURce]:FM[1]   2:INTernal[1]:FUNctIon:SHAPE RAMP [ :SOURce]:FM[1]   2:INTernal[1]:FUNctIon:SHAPE?
<b>Sine</b>	[ :SOURce]:FM[1]   2:INTernal[1]:FUNctIon:SHAPE SINE [ :SOURce]:FM[1]   2:INTernal[1]:FUNctIon:SHAPE?
<b>Square</b>	[ :SOURce]:FM[1]   2:INTernal[1]:FUNctIon:SHAPE SQUARE [ :SOURce]:FM[1]   2:INTernal[1]:FUNctIon:SHAPE?
<b>Swept-Sine</b>	[ :SOURce]:FM[1]   2:INTernal[1]:FUNctIon:SHAPE SWEPTsine [ :SOURce]:FM[1]   2:INTernal[1]:FUNctIon:SHAPE?
<b>Triangle</b>	[ :SOURce]:FM[1]   2:INTernal[1]:FUNctIon:SHAPE TRIangle [ :SOURce]:FM[1]   2:INTernal[1]:FUNctIon:SHAPE?
<b>Trigger In Polarity Neg Pos</b>	:TRIGger[:SEQuence]:SLOPe POSitive NEGative :TRIGger[:SEQuence]:SLOPe?
<b>Trigger Key</b>	[ :SOURce]:FM[1]   2:INTernal[1]:SWEep:TRIGger KEY [ :SOURce]:FM[1]   2:INTernal[1]:SWEep:TRIGger?
<b>Trigger Out Polarity Neg Pos</b>	:TRIGger:OUTPut:POLarity POSitive NEGative :TRIGger:OUTPut:POLarity?

**Table 6 Freq Softkeys**

Key	SCPI Command
Adjust Phase	[ :SOURce]:PHASe:[ADJust] <val><unit> [ :SOURce]:PHASe:[ADJust]?
Freq Multiplier	[ :SOURce]:FREQuency:MUlTiplier <val> [ :SOURce]:FREQuency:MUlTiplier?
Freq Offset	[ :SOURce]:FREQuency:OFFset <val><unit> [ :SOURce]:FREQuency:OFFset?
Freq Ref Off On	[ :SOURce]:FREQuency:REFerence:STATe ON OFF 1 0 [ :SOURce]:FREQuency:REFerence:STATe?
Freq Ref Set	[ :SOURce]:FREQuency:REFerence <val><unit> [ :SOURce]:FREQuency:REFerence?
Mode 1 Optimize <10kHz Offset	[ :SOURce]:FREQuency:SYNThesis 1 [ :SOURce]:FREQuency:SYNThesis?
Mode 2 Optimize >10kHz Offset	[ :SOURce]:FREQuency:SYNThesis 2 [ :SOURce]:FREQuency:SYNThesis?
Phase Ref Set	[ :SOURce]:PHASe:REFerence

**Table 7 Frequency Hardkey**

Key	SCPI Command
Frequency (hardkey)	[ :SOURce]:FREQuency[:CW] <val><unit> [ :SOURce]:FREQuency[:CW]? [ :SOURce]:FREQuency:FIXed <val><unit> [ :SOURce]:FREQuency:FIXed? [ :SOURce]:FREQuency:MODE CW FIXed LIST [ :SOURce]:FREQuency:MODE?

**Table 8 I/Q Softkeys**

Key	SCPI Command
ALC Off On	[ :SOURce]:POWer:ALC[:STATe] ON OFF 1 0 [ :SOURce]:POWer:ALC[:STATe]?
Burst Envelope Off On	[ :SOURce]:BURSt:STATe ON OFF 1 0 [ :SOURce]:BURSt:STATe?
Burst Source	[ :SOURce]:BURSt:SOURce EXTernal INTernal[1] [ :SOURce]:BURSt:SOURce?
Do Power Search	[ :SOURce]:POWer:ALC:SEARCh ONCE
Execute Cal	:CALibration:IQ :CALibration:IQ:FULL

**Table 8 I/Q Softkeys**

Key	SCPI Command
<b>Ext1 DC</b>	[ :SOURCE]:BURSt:SOURCE EXTErnal[1] [ :SOURCE]:BURSt:SOURCE?
<b>Ext I/Q</b>	[ :SOURCE]:DM:SOURCE EXTErnal [ :SOURCE]:DM:SOURCE?
<b>High Crest Mode Off On</b>	[ :SOURCE]:DM:EXTErnal:HICRest[:STATe] ON OFF 1 0 [ :SOURCE]:DM:EXTErnal:HICRest[:STATe]?
<b>I Offset</b>	[ :SOURCE]:DM:IQADjustment:IOFFset <val><unit> [ :SOURCE]:DM:IQADjustment:IOFFset?
<b>I/Q Adjustments Off On</b>	[ :SOURCE]:DM:IQADjustment[:STATe] ON OFF 1 0 [ :SOURCE]:DM:IQADjustment[:STATe]?
<b>I/Q Gain</b>	[ :SOURCE]:DM:IQADjustment:GAIN <val><unit> [ :SOURCE]:DM:IQADjustment:GAIN?
<b>I/Q Off On</b>	[ :SOURCE]:DM:STATe ON OFF 1 0 [ :SOURCE]:DM:STATe?
<b>I/Q Phase</b>	[ :SOURCE]:DM:IQADjustment:PHASE <val><unit> [ :SOURCE]:DM:IQADjustment:PHASE?
<b>I/Q Source</b>	[ :SOURCE]:DM:SOURCE EXTErnal[1] INTErnal[1] [ :SOURCE]:DM:SOURCE?
<b>Int Burst</b>	[ :SOURCE]:BURSt:SOURCE INTErnal[1] [ :SOURCE]:BURSt:SOURCE?
<b>Int I/Q</b>	[ :SOURCE]:DM:SOURCE INTErnal [ :SOURCE]:DM:SOURCE?
<b>Phase Polarity Normal Invert</b>	[ :SOURCE]:DM:POLarity[:ALL] NORMal INVErted [ :SOURCE]:DM:POLarity[:ALL]?
<b>Power Search Manual Auto</b>	[ :SOURCE]:POWER:ALC:SEARCh ON OFF 1 0 ONCE [ :SOURCE]:POWER:ALC:SEARCh?
<b>Q Offset</b>	[ :SOURCE]:DM:IQADjustment:QOFFset <val><unit> [ :SOURCE]:DM:IQADjustment:QOFFset?
<b>Quadrature Skew</b>	[ :SOURCE]:DM:IQADjustment:QSKew <val><unit> [ :SOURCE]:DM:IQADjustment:QSKew?
<b>Revert to Default Cal Settings</b>	:CALibration:IQ:DEFault
<b>Start Frequency</b>	:CALibration:IQ:START <val><unit> :CALibration:IQ:START?
<b>Stop Frequency</b>	:CALibration:IQ:STOP <val><unit> :CALibration:IQ:STOP?

**Table 9 LF Out Softkeys**

Key	SCPI Command
<b>Bus</b>	[ :SOURce ]:LFOutput:FUNction:SWEep:TRIGger BUS [ :SOURce ]:LFOutput:FUNction:SWEep:TRIGger?
<b>DC</b>	[ :SOURce ]:LFOutput:FUNction:SHAPE DC [ :SOURce ]:LFOutput:FUNction:SHAPE?
<b>Dual-Sine</b>	[ :SOURce ]:LFOutput:FUNction:SHAPE DUALsine [ :SOURce ]:LFOutput:FUNction:SHAPE?
<b>Ext</b>	[ :SOURce ]:LFOutput:FUNction:SWEep:TRIGger EXTERNAL [ :SOURce ]:LFOutput:FUNction:SWEep:TRIGger?
<b>Function Generator</b>	[ :SOURce ]:LFOutput:SOURce FUNCTION [ :SOURce ]:LFOutput:SOURce?
<b>Immediate</b>	[ :SOURce ]:LFOutput:FUNction:SWEep:TRIGger IMMEDIATE [ :SOURce ]:LFOutput:FUNction:SWEep:TRIGger?
<b>Internal</b>	[ :SOURce ]:LFOutput:SOURce INT[1] [ :SOURce ]:LFOutput:SOURce?
<b>LF Out Amplitude</b>	[ :SOURce ]:LFOutput:AMPLitude <val><unit> [ :SOURce ]:LFOutput:AMPLitude?
<b>LF Out Freq</b>	[ :SOURce ]:LFOutput:FUNction:FREQuency <val><unit> [ :SOURce ]:LFOutput:FUNction:FREQuency?
<b>LF Out Off On</b>	[ :SOURce ]:LFOutput:STATE ON OFF 1 0 [ :SOURce ]:LFOutput:STATE?
<b>LF Out Period</b>	[ :SOURce ]:LFOutput:FUNction:PERiod <val><unit> [ :SOURce ]:LFOutput:FUNction:PERiod?
<b>LF Out Source</b>	[ :SOURce ]:LFOutput:SOURce INT[1] FUNCTION [ :SOURce ]:LFOutput:SOURce?
<b>LF Out Start Freq</b>	[ :SOURce ]:LFOutput:FUNction:FREQuency <val><unit> [ :SOURce ]:LFOutput:FUNction:FREQuency?
<b>LF Out Stop Freq</b>	[ :SOURce ]:LFOutput:FUNction:FREQuency:ALternate <val><unit> [ :SOURce ]:LFOutput:FUNction:FREQuency:ALternate?
<b>LF Out Sweep Time</b>	[ :SOURce ]:LFOutput:FUNction:SWEep:TIME <val><unit> [ :SOURce ]:LFOutput:FUNction:SWEep:TIME?
<b>LF Out Sweep Trigger</b>	[ :SOURce ]:LFOutput:FUNction:SWEep:TRIGger IMMEDIATE BUS  EXTERNAL KEY [ :SOURce ]:LFOutput:FUNction:SWEep:TRIGger?
<b>LF Out Tone 1 Freq</b>	[ :SOURce ]:LFOutput:FUNction:FREQuency <val><unit> [ :SOURce ]:LFOutput:FUNction:FREQuency?

**Table 9 LF Out Softkeys**

Key	SCPI Command
<b>LF Out Tone 2 Ampl Percent Of Peak</b>	[ :SOURce]:LFOutput:FUNCTion:FREQuency:ALternate:AMPLitude :PERCent <val><unit> [:SOURce]:LFOutput:FUNCTion:FREQuency:ALternate:AMPLitude :PERCent?
<b>LF Out Tone 2 Freq</b>	[ :SOURce]:LFOutput:FUNCTion:FREQuency:ALternate <val><unit> [:SOURce]:LFOutput:FUNCTion:FREQuency:ALternate?
<b>LF Out Waveform</b>	[ :SOURce]:LFOutput:FUNCTion:SHAPE SINE TRIangle SQUare  RAMP NOISe DUALsine SWEPTSine [:SOURce]:LFOutput:FUNCTion:SHAPE?
<b>LF Out Width</b>	[ :SOURce]:LFOutput:FUNCTion:PWIDth <val><unit> [:SOURce]:LFOutput:FUNCTion:PWIDth?
<b>Noise</b>	[ :SOURce]:LFOutput:FUNCTion:SHAPE NOISe [:SOURce]:LFOutput:FUNCTion:SHAPE?
<b>Ramp</b>	[ :SOURce]:LFOutput:FUNCTion:SHAPE RAMP [:SOURce]:LFOutput:FUNCTion:SHAPE?
<b>Sine</b>	[ :SOURce]:LFOutput:FUNCTion:SHAPE SINE [:SOURce]:LFOutput:FUNCTion:SHAPE?
<b>Square</b>	[ :SOURce]:LFOutput:FUNCTion:SHAPE SQUare [:SOURce]:LFOutput:FUNCTion:SHAPE?
<b>Swept-Sine</b>	[ :SOURce]:LFOutput:FUNCTion:SHAPE SWEPTSine [:SOURce]:LFOutput:FUNCTion:SHAPE?
<b>Triangle</b>	[ :SOURce]:LFOutput:FUNCTion:SHAPE TRIangle [:SOURce]:LFOutput:FUNCTion:SHAPE?
<b>Trigger In Polarity Neg Pos</b>	:TRIGger[:SEQuence]:SLOPe POSitive NEGative :TRIGger[:SEQuence]:SLOPe?
<b>Trigger Key</b>	[ :SOURce]:LFOutput:FUNCTion:SWEep:TRIGger KEY [:SOURce]:LFOutput:FUNCTion:SWEep:TRIGger?
<b>Trigger Out Polarity Neg Pos</b>	:TRIGger:OUTPut:POLarity POSitive NEGative :TRIGger:OUTPut:POLarity?

**Table 10 Mod On/Off Hardkey**

Key	SCPI Command
<b>Mod On/Off (hardkey)</b>	:OUTPut:MODulation[:STATe] ON OFF 1 0 :OUTPut:MODulation[:STATe]?



**Table 11 Phase Mod Softkeys**

<b>Key</b>	<b>SCPI Command</b>
<b>φM Dev</b>	[ :SOURce]:PM[1] 2[:DEVIation] <val><unit> [:SOURce]:PM[1] 2[:DEVIation]?
<b>φM Dev Couple Off On</b>	[ :SOURce]:PM[1] 2[:DEVIation]TRACK ON OFF 1 0 [:SOURce]:PM[1] 2[:DEVIation]TRACK?
<b>φM Off On</b>	[ :SOURce]:PM[1] 2:STATE ON OFF 1 0 [:SOURce]:PM[1] 2:STATE?
<b>φM Rate</b>	[ :SOURce]:PM[1] 2:INTernAl[1]:FREQUency <val><unit> [:SOURce]:PM[1] 2:INTernAl[1]:FREQUency?
<b>φM Source</b>	[ :SOURce]:PM[1] 2:SOURce INT[1] EXT1 EXT2 [:SOURce]:PM[1] 2:SOURce?
<b>φM Start Rate</b>	[ :SOURce]:PM[1] 2:INTernAl[1]:FREQUency <val><unit> [:SOURce]:PM[1] 2:INTernAl[1]:FREQUency?
<b>φM Stop Rate</b>	[ :SOURce]:PM[1] 2:INTernAl[1]:FREQUency:ALternate <val> <unit> [:SOURce]:PM[1] 2:INTernAl[1]:FREQUency:ALternate?
<b>φM Sweep Time</b>	[ :SOURce]:PM[1] 2:INTernAl[1]:SWEep:TIME <val><unit> [:SOURce]:PM[1] 2:INTernAl[1]:SWEep:TIME?
<b>φM Sweep Trigger</b>	:TRIGger[:SEQUence]:SOURce BUS IMMediate EXTernAl KEY :TRIGger[:SEQUence]:SOURce?
<b>φM Tone 1 Rate</b>	[ :SOURce]:PM[1] 2:INTernAl[1]:FREQUency <val><unit> [:SOURce]:PM[1] 2:INTernAl[1]:FREQUency?
<b>φM Tone 2 Ampl Percent Of Peak</b>	[ :SOURce]:PM[1] 2:INTernAl[1]:FREQUency:ALternate:AMPLitude: PERCent <val><unit> [:SOURce]:PM[1] 2:INTernAl[1]:FREQUency:ALternate:AMPLitude: PERCent?
<b>φM Tone 2 Rate</b>	[ :SOURce]:PM[1] 2:INTernAl[1]:FREQUency:ALternate <val> <unit> [:SOURce]:PM[1] 2:INTernAl[1]:FREQUency:ALternate?
<b>φM Waveform</b>	[ :SOURce]:PM[1] 2:INTernAl[1]:FUNctIon:SHAPE SINE TRIangle  SQUare RAMP NOISe DUAlSine SWEptsine [:SOURce]:PM[1] 2:INTernAl[1]:FUNctIon:SHAPE?
<b>Bus</b>	[ :SOURce]:PM[1] 2:INTernAl[1]:SWEep:TRIGger BUS [:SOURce]:PM[1] 2:INTernAl[1]:SWEep:TRIGger?
<b>DCFM/DCφM Cal</b>	:CALibration:DCFM
<b>Dual-Sine</b>	[ :SOURce]:PM[1] 2:INTernAl[1]:FUNctIon:SHAPE DUAlSine [:SOURce]:PM[1] 2:INTernAl[1]:FUNctIon:SHAPE?
<b>Ext</b>	[ :SOURce]:PM[1] 2:INTernAl[1]:SWEep:TRIGger EXTernAl [:SOURce]:PM[1] 2:INTernAl[1]:SWEep:TRIGger?

**Table 11 Phase Mod Softkeys**

Key	SCPI Command
<b>Ext 1 AC-Coupled</b>	[ :SOURce]:PM[1]   2:SOURce EXT1 [ :SOURce]:PM[1]   2:EXTernal[1]:COUPling AC [ :SOURce]:PM[1]   2:EXTernal[1]:COUPling?
<b>Ext 1 DC-Coupled</b>	[ :SOURce]:PM[1]   2:SOURce EXT1 [ :SOURce]:PM[1]   2:EXTernal[1]:COUPling DC [ :SOURce]:PM[1]   2:EXTernal[1]:COUPling?
<b>Ext 2 AC-Coupled</b>	[ :SOURce]:PM[1]   2:SOURce EXT2 [ :SOURce]:PM[1]   2:EXTernal2:COUPling AC [ :SOURce]:PM[1]   2:EXTernal2:COUPling?
<b>Ext 2 DC-Coupled</b>	[ :SOURce]:PM[1]   2:SOURce EXT2 [ :SOURce]:PM[1]   2:EXTernal2:COUPling DC [ :SOURce]:PM[1]   2:EXTernal2:COUPling?
<b>FM/φM Normal High BW</b>	[ :SOURce]:PM[1]   2:BANDwidth BWIDth NORMAlHIGH [ :SOURce]:PM[1]   2:BANDwidth BWIDth?
<b>Immediate</b>	[ :SOURce]:PM[1]   2:INTernal[1]:SWEep:TRIGger IMMEDIATE [ :SOURce]:PM[1]   2:INTernal[1]:SWEep:TRIGger?
<b>Internal</b>	[ :SOURce]:PM[1]   2:SOURce INTernal[1] [ :SOURce]:PM[1]   2:SOURce?
<b>Noise</b>	[ :SOURce]:PM[1]   2:INTernal[1]:FUNctIon:SHAPE NOISE [ :SOURce]:PM[1]   2:INTernal[1]:FUNctIon:SHAPE?
<b>Ramp</b>	[ :SOURce]:PM[1]   2:INTernal[1]:FUNctIon:SHAPE RAMP [ :SOURce]:PM[1]   2:INTernal[1]:FUNctIon:SHAPE?
<b>Sine</b>	[ :SOURce]:PM[1]   2:INTernal[1]:FUNctIon:SHAPE SINE [ :SOURce]:PM[1]   2:INTernal[1]:FUNctIon:SHAPE?
<b>Square</b>	[ :SOURce]:PM[1]   2:INTernal[1]:FUNctIon:SHAPE SQUare [ :SOURce]:PM[1]   2:INTernal[1]:FUNctIon:SHAPE?
<b>Swept-Sine</b>	[ :SOURce]:PM[1]   2:INTernal[1]:FUNctIon:SHAPE SWEPTsine [ :SOURce]:PM[1]   2:INTernal[1]:FUNctIon:SHAPE?
<b>Triangle</b>	[ :SOURce]:PM[1]   2:INTernal[1]:FUNctIon:SHAPE TRIangle [ :SOURce]:PM[1]   2:INTernal[1]:FUNctIon:SHAPE?
<b>Trigger In Polarity Neg Pos</b>	:TRIGger[:SEquence]:SLOPe POSitive NEGative :TRIGger[:SEquence]:SLOPe?
<b>Trigger Key</b>	[ :SOURce]:PM[1]   2:INTernal[1]:SWEep:TRIGger KEY [ :SOURce]:PM[1]   2:INTernal[1]:SWEep:TRIGger?
<b>Trigger Out Polarity Neg Pos</b>	:TRIGger:OUTPut:POLarity POSitive NEGative :TRIGger:OUTPut:POLarity?

**Table 12 Preset Hardkey**

Key	SCPI Command
Preset (hardkey)	:SYSTem:PRESet

**Table 13 Pulse Softkeys**

Key	SCPI Command
Ext2 DC-Coupled	[ :SOURce]:PULM:SOURce EXT2 [ :SOURce]:PULM:SOURce?
Fast Pulse Off On	[ :SOURce]:PULM:FAST:STAtE ON OFF 1 0 [ :SOURce]:PULM:FAST:STAtE?
Internal Pulse	[ :SOURce]:PULM:SOURce INT [ :SOURce]:PULM:SOURce? [ :SOURce]:PULM:INTernal[1]:FUNction:SHApe PULSe [ :SOURce]:PULM:INTernal[1]:FUNction:SHApe?
Internal Square	[ :SOURce]:PULM:SOURce INT [ :SOURce]:PULM:SOURce? [ :SOURce]:PULM:INTernal[1]:FUNction:SHApe SQUare [ :SOURce]:PULM:INTernal[1]:FUNction:SHApe?
Pulse Off On	[ :SOURce]:PULM:STAtE ON OFF 1 0 [ :SOURce]:PULM:STAtE?
Pulse Period	[ :SOURce]:PULM:INTernal[1]:PERiod <val><unit> [ :SOURce]:PULM:INTernal[1]:PERiod?
Pulse Rate	[ :SOURce]:PULM:INTernal[1]:FREQuency <val><unit> [ :SOURce]:PULM:INTernal[1]:FREQuency?
Pulse Width	[ :SOURce]:PULM:INTernal[1]:PWIDth <val><unit> [ :SOURce]:PULM:INTernal[1]:PWIDth?

**Table 14 Recall Softkeys**

Key	SCPI Command
Recall Reg	*RCL <reg>[, <seq>]

**Table 15 RF On/Off Hardkey**

Key	SCPI Command
RF On/Off (hardkey)	:OUTPut[:STAtE] ON OFF 1 0 :OUTPut[:STAtE]?

**Table 16 Save Softkeys**

Key	SCPI Command
<b>Add Comment To Seq[n] Reg[nn]</b>	:MEMory:STate:COMment <reg_num>,<seq_num>,"<comment>" :MEMory:STate:COMment? <reg_num>,<seq_num>
<b>Save Seq[n] Reg[nn]</b>	*SAV <reg>[, <seq>]

**Table 17 Sweep/List Softkeys**

Key	SCPI Command
<b>#Points</b>	[:SOURce]:SWEep:POINts <val> [:SOURce]:SWEep:POINts?
<b>Ampl</b>	[:SOURce]:POWEr:MODE LIST FIXed [:SOURce]:POWEr:MODE?
<b>Ampl Start</b>	[:SOURce]:POWEr:STARt <val><unit> [:SOURce]:POWEr:STARt?
<b>Ampl Stop</b>	[:SOURce]:POWEr:STOP <val><unit> [:SOURce]:POWEr:STOP?
<b>Bus</b>	[:SOURce]:LIST:TRIGger:SOURce BUS [:SOURce]:LIST:TRIGger:SOURce?
<b>Configure List Sweep</b>	[:SOURce]:LIST:DWELL <val>{, <val>} [:SOURce]:LIST:DWELL? [:SOURce]:LIST:DWELL:POINts? [:SOURce]:LIST:FREQuency <val>{, <val>} [:SOURce]:LIST:FREQuency? [:SOURce]:LIST:FREQuency:POINts? [:SOURce]:LIST:POWEr <val>{, <val>} [:SOURce]:LIST:POWEr? [:SOURce]:LIST:POWEr:POINts?
<b>Dwell Type List Step</b>	[:SOURce]:LIST:DWELL:TYPE <val>{, <val>} [:SOURce]:LIST:DWELL:TYPE LIST STEP [:SOURce]:LIST:DWELL:TYPE?
<b>Ext Neg</b>	[:SOURce]:LIST:TRIGger:SOURce EXTernal [:SOURce]:LIST:TRIGger:SOURce? :TRIGger[:SEQuence]:SOURce EXTernal :TRIGger[:SEQuence]:SOURce? :TRIGger[:SEQuence]:SLOPe NEGative :TRIGger[:SEQuence]:SLOPe?
<b>Ext Pos</b>	[:SOURce]:LIST:TRIGger:SOURce EXTernal [:SOURce]:LIST:TRIGger:SOURce? :TRIGger[:SEQuence]:SOURce EXTernal :TRIGger[:SEQuence]:SOURce? :TRIGger[:SEQuence]:SLOPe POSitive :TRIGger[:SEQuence]:SLOPe?

**Table 17 Sweep/List Softkeys**

<b>Key</b>	<b>SCPI Command</b>
<b>Freq</b>	[ :SOURce ]:FREQuency:MODE LIST [ :SOURce ]:FREQuency:MODE?
<b>Freq&amp;Ampl</b>	[ :SOURce ]:POWer:MODE LIST [ :SOURce ]:POWer:MODE? [ :SOURce ]:FREQuency:MODE LIST [ :SOURce ]:FREQuency:MODE?
<b>Freq Start</b>	[ :SOURce ]:FREQuency:STARt <val><unit> [ :SOURce ]:FREQuency:STARt?
<b>Freq Stop</b>	[ :SOURce ]:FREQuency:STOP <val><unit> [ :SOURce ]:FREQuency:STOP?
<b>Immediate</b>	[ :SOURce ]:LIST:TRIGger:SOURce IMMEDIATE [ :SOURce ]:LIST:TRIGger:SOURce?
<b>Load List From Selected File</b>	:MEMory:LOAD:LIST "<file_name>" :MMEMory:LOAD:LIST "<file_name>"
<b>Load List From Step Sweep</b>	[ :SOURce ]:LIST:TYPE:LIST:INITialize:FSTep
<b>Manual Mode Off On</b>	[ :SOURce ]:LIST:MODE AUTO MANual [ :SOURce ]:LIST:MODE?
<b>Manual Point</b>	[ :SOURce ]:LIST:MANual <val> [ :SOURce ]:LIST:MANual?
<b>Off</b>	[ :SOURce ]:FREQuency:MODE CW FIXED [ :SOURce ]:FREQuency:MODE? [ :SOURce ]:POWer:MODE FIXED [ :SOURce ]:POWer:MODE?
<b>Point Trigger</b>	[ :SOURce ]:LIST:TRIGger:SOURce BUS IMMEDIATE EXTERNAL KEY [ :SOURce ]:LIST:TRIGger:SOURce?
<b>Preset List</b>	[ :SOURce ]:LIST:TYPE:LIST:INITialize:PRESet
<b>Rename File</b>	:MEMory:MOVE <src_file>,<dest_file> :MMEMory:MOVE <src_file>,<dest_file>
<b>Single Sweep</b>	:INITiate:CONTinuous[:ALL] ON OFF 1 0 :INITiate[:IMMEDIATE][:ALL]
<b>Step Dwell</b>	[ :SOURce ]:SWEep:DWELl <val> [ :SOURce ]:SWEep:DWELl?
<b>Store List to File</b>	:MEMory:STORe:LIST "<file_name>" :MMEMory:STORe:LIST "<file_name>"

**Table 17 Sweep/List Softkeys**

Key	SCPI Command
<b>Sweep</b>	[ :SOURce]:FREQuency:MODE CW FIXed LIST [ :SOURce]:FREQuency:MODE? [ :SOURce]:POWer:MODE FIXed LIST [ :SOURce]:POWer:MODE?
<b>Sweep Direction Down Up</b>	[ :SOURce]:LIST:DIRection UP DOWN [ :SOURce]:LIST:DIRection?
<b>Sweep Repeat Single Cont</b>	:INITiate:CONTInuous[:ALL] ON OFF 1 0 :INITiate:CONTInuous[:ALL]?
<b>Sweep Trigger</b>	:TRIGger[:SEQuence]:SOURce BUS IMMediate EXTErnal KEY :TRIGger[:SEQuence]:SOURce?
<b>Sweep Type List Step</b>	[ :SOURce]:LIST:TYPE LIST STEP [ :SOURce]:LIST:TYPE?
<b>Trigger Key</b>	[ :SOURce]:LIST:TRIGger:SOURce KEY [ :SOURce]:LIST:TRIGger:SOURce?
<b>Trigger Out Polarity Neg Pos</b>	:TRIGger:OUTPut:POLarity POSitive NEGative :TRIGger:OUTPut:POLarity?

**Table 18 Trigger Hardkey**

Key	SCPI Command
<b>Trigger (hardkey)</b>	:TRIGger[:SEQuence][:IMMediate]

**Table 19 Utility Softkeys**

Key	SCPI Command
<b>All</b>	:MEMory:CATalog[:ALL]?
<b>ARB</b>	:MMEMemory:CATalog? "ARBI:"
<b>ARB Catalog Types</b>	:MEMory:CATalog:CDMa? DMOD? DWCDma? FCDMa? FWCDma? MCDMa?  MDMod? MDWCdma? MFCDma? MFWCdma? MTONe? RCDMa? RWCDma? SEQ?  UWCDma?
<b>Binary</b>	:MEMory:CATalog:BINary?
<b>Bit</b>	:MEMory:CATalog:BIT?
<b>Brightness</b>	:DISPlay:BRIGhtness <value> :DISPlay:BRIGhtness?
<b>Burst Gate In Polarity Neg Pos</b>	:ROUte:HARDware:DGENerator:IPOLarity:BGATE POSitive NEGative :ROUte:HARDware:DGENerator:IPOLarity:BGATE?
<b>CDMA</b>	:MEMory:CATalog:CDMa?

**Table 19 Utility Softkeys**

Key	SCPI Command
<b>Clear Error Queue(s)</b>	*CLS
<b>DATA/CLK/SYNC Rear Outputs Off On</b>	:ROUte:HARDware:DGENerator:OUTPut:DCS[:STATe] ON OFF 1 0 :ROUte:HARDware:DGENerator:OUTPut:DCS[:STATe]?
<b>Data Clock Out Polarity Neg Pos</b>	:ROUte:HARDware:DGENerator:OPOLarity:CLOCK POSitive NEGative :ROUte:HARDware:DGENerator:OPOLarity:CLOCK?
<b>Data Clock Polarity Neg Pos</b>	:ROUte:HARDware:DGENerator:IPOLarity:CLOCK POSitive NEGative :ROUte:HARDware:DGENerator:IPOLarity:CLOCK?
<b>Data Out Polarity Neg Pos</b>	:ROUte:HARDware:DGENerator:OPOLarity:DATA POSitive NEGative :ROUte:HARDware:DGENerator:OPOLarity:DATA?
<b>Data Polarity Neg Pos</b>	:ROUte:HARDware:DGENerator:IPOLarity:DATA POSitive NEGative :ROUte:HARDware:DGENerator:IPOLarity:DATA?
<b>Delete All ARB Files</b>	:MEMory:DELeTe:CDma DMOD DWCDma FCDma FWCDma MCDma MDMod  MDWCdma MFCDma MFWCdma MTONE RCDma RWCDma SEQ UWCDma
<b>Delete All Binary Files</b>	:MEMory:DELeTe:BINary
<b>Delete All Bit Files</b>	:MEMory:DELeTe:BIT
<b>Delete All Files</b>	:MEMory:DELeTe:ALL
<b>Delete All FIR Files</b>	:MEMory:DELeTe:FIR
<b>Delete All FSK Files</b>	:MEMory:DELeTe:FSK
<b>Delete All IQ Files</b>	:MEMory:DELeTe:IQ
<b>Delete All List Files</b>	:MEMory:DELeTe:LIST
<b>Delete All Shape Files</b>	:MEMory:DELeTe:SHAPE
<b>Delete All State Files</b>	:MEMory:DELeTe:STATe
<b>Delete File</b>	:MEMory:DELeTe[:NAME] "<file_name>"
<b>Diagnostic Info</b>	:DIAGnostic[:CPU]:INFORmation:CCOunt:ATTenuator? :DIAGnostic[:CPU]:INFORmation:CCOunt:PON? :DIAGnostic[:CPU]:INFORmation:CCOunt:PROTEction? :DIAGnostic[:CPU]:INFORmation:DISPlay:OTIMEe? :DIAGnostic[:CPU]:INFORmation:CCOunt:OTIME? :DIAGnostic[:CPU]:INFORmation:CCOunt:SDATE? :DIAGnostic[:CPU]:INFORmation:OPTions?
<b>DMOD</b>	:MEMory:CATalog:DMOD?

**Table 19 Utility Softkeys**

<b>Key</b>	<b>SCPI Command</b>
<b>DWCDMA</b>	:MEMory:CATalog:DWCDma?
<b>Event 1 Output Polarity Neg Pos</b>	:ROUTe:HARDware:DGENERator:OPOLarity:EVEN1 POSitive NEGative :ROUTe:HARDware:DGENERator:OPOLarity:EVEN1?
<b>Event 2 Output Polarity Neg Pos</b>	:ROUTe:HARDware:DGENERator:OPOLarity:EVEN2 POSitive NEGative :ROUTe:HARDware:DGENERator:OPOLarity:EVEN2?
<b>FCDMA</b>	:MEMory:CATalog:FCDma?
<b>FIR</b>	:MEMory:CATalog:FIR?
<b>FSK</b>	:MEMory:CATalog:FSK?
<b>FWCDMA</b>	:MEMory:CATalog:FWCDma?
<b>Help Mode Single Cont</b>	:SYSTem:HELp:MODE SINGLE CONTinuous :SYSTem:HELp:MODE?
<b>8648A/B/C/D</b>	:SYSTem:LANGUage "8648" :SYSTem:LANGUage? :SYSTem:PRESet:LANGUage "8648" :SYSTem:PRESet:LANGUage?
<b>8656B,8657A/B</b>	:SYSTem:LANGUage "COMP" :SYSTem:LANGUage? :SYSTem:PRESet:LANGUage "COMP" :SYSTem:PRESet:LANGUage?
<b>8657D NADC</b>	:SYSTem:LANGUage "NADC" :SYSTem:LANGUage? :SYSTem:PRESet:LANGUage "NADC" :SYSTem:PRESet:LANGUage?
<b>8657D PDC</b>	:SYSTem:LANGUage "PDC" :SYSTem:LANGUage? :SYSTem:PRESet:LANGUage "PDC" :SYSTem:PRESet:LANGUage?
<b>8657J PHS</b>	:SYSTem:LANGUage "PHS" :SYSTem:LANGUage? :SYSTem:PRESet:LANGUage "PHS" :SYSTem:PRESet:LANGUage?
<b>GPIB Address</b>	:SYSTem:COMMunicate:GPIB:ADDDress <number> :SYSTem:COMMunicate:GPIB:ADDDress?
<b>Installed Board Info</b>	:DIAGnostic[:CPU]:INFORMation:BOARDs?
<b>Inverse Video Off On</b>	:DISPlay:INVERSE ON OFF 1 0 :DISPlay:INVERSE?
<b>I/Q</b>	:MEMory:CATalog:IQ?



**Table 19 Utility Softkeys**

<b>Key</b>	<b>SCPI Command</b>
<b>List</b>	:MEMory:CATalog:LIST?
<b>MCDMA</b>	:MEMory:CATalog:MCDma?
<b>MDMOD</b>	:MEMory:CATalog:MMod?
<b>MDWCDMA</b>	:MEMory:CATalog:MDWCdma?
<b>MFCDMA</b>	:MEMory:CATalog:MFCDma?
<b>MFWCDMA</b>	:MEMory:CATalog:MFWCdma?
<b>Modulation Catalog Types</b>	:MEMory:CATalog:IQ?   FSK?
<b>MTONE</b>	:MEMory:CATalog:MFCDma?
<b>NVARB</b>	:MMEMory:CATalog? "NVARbi:"
<b>Off</b>	:SYSTem:COMMunicate:SERial:CONTRol:RTS OFF :SYSTem:COMMunicate:SERial:CONTRol:RTS?
<b>Options Info</b>	:DIAGnostic[:CPU]:INFORMation:OPTions:DETail?
<b>Pattern Trig In Polarity Neg Pos</b>	:ROUte:HARDware:DGENerator:IPOLarity:TRIGger POSitive NEGative :ROUte:HARDware:DGENerator:IPOLarity:TRIGger?
<b>PN9 Mode Preset Normal Quick</b>	:SYSTem:PRESet:PN9 NORMal QUICK :SYSTem:PRESet:PN9?
<b>Power On Last Preset</b>	:SYSTem:PON:TYPE PRESet LAST :SYSTem:PON:TYPE?
<b>Preset Language</b>	:SYSTem:PRESet:LANGUage?
<b>Preset Normal User</b>	:SYSTem:PRESet:TYPE NORMal USER :SYSTem:PRESet:TYPE?
<b>RCDMA</b>	:MEMory:CATalog:RCDma?
<b>Receive Pace None Xon</b>	:SYSTem:COMMunicate:SERial:RECEive:PACE XON NONE :SYSTem:COMMunicate:SERial:RECEive:PACE?
<b>Remote Language</b>	:SYSTem:LANGUage?
<b>Rename File</b>	:MEMory:MOVE <src_file>,<dest_file>
<b>Reset RS-232</b>	:SYSTem:COMMunicate:SERial:RESet
<b>Reverse Power Protection Normal 8648</b>	:OUTPut:PROTEction:MODE "NORMAL" "8648" :OUTPut:PROTEction:MODE? :OUTPut:PROTEction:TRIPped? :OUTPut:PROTEction:CLEar
<b>RS-232 Baud Rate</b>	:SYSTem:COMMunicate:SERial:BAUD <number> :SYSTem:COMMunicate:SERial:BAUD?

**Table 19 Utility Softkeys**

Key	SCPI Command
<b>RS-232 Echo Off On</b>	:SYSTem:COMMunicate:SERial:ECHO ON OFF 1 0 :SYSTem:COMMunicate:SERial:ECHO?
<b>RS-232 Timeout</b>	:SYSTem:COMMunicate:SERial:TOUT <value> :SYSTem:COMMunicate:SERial:TOUT?
<b>RTS/CTS</b>	:SYSTem:COMMunicate:SERial:CONTRol:RTS?
<b>RTS/CTS Pacing</b>	:SYSTem:COMMunicate:SERial:CONTRol:RTS IBFull :SYSTem:COMMunicate:SERial:CONTRol:RTS RFR :SYSTem:COMMunicate:SERial:CONTRol:RTS?
<b>RTS On</b>	:SYSTem:COMMunicate:SERial:CONTRol:RTS ON :SYSTem:COMMunicate:SERial:CONTRol:RTS?
<b>RWCDMA</b>	:MEMory:CATalog:RWCDma?
<b>Save User Preset</b>	:SYSTem:PRESet[:USER]:SAVE
<b>SCPI</b>	:SYSTem:PRESet:LANGUage "SCPI" :SYSTem:PRESet:LANGUage? :SYSTem:LANGUage "SCPI" :SYSTem:LANGUage?
<b>Screen Saver Delay</b>	:SYSTem:SSAVer:DELay <val> :SYSTem:SSAVer:DELay?
<b>Screen Saver Mode</b>	:SYSTem:SSAVer:MODE LIGHT TEXT :SYSTem:SSAVer:MODE?
<b>Screen Saver Off On</b>	:SYSTem:SSAVer:STATe ON OFF 1 0 :SYSTem:SSAVer:STATe?
<b>Seq</b>	:MEMory:CATalog:SEQ?
<b>Shape</b>	:MEMory:CATalog:SHAPE?
<b>State</b>	:MEMory:CATalog:STATe?
<b>Symbol Sync Polarity Neg Pos</b>	:ROUTe:HARDware:DGENERator:IPOLarity:SSYNc POSitive NEGative :ROUTe:HARDware:DGENERator:IPOLarity:SSYNc?
<b>Symbol Sync Out Polarity Neg Pos</b>	:ROUTe:HARDware:DGENERator:OPOLarity:SSYNc POSitive NEGative :ROUTe:HARDware:DGENERator:OPOLarity:SSYNc?
<b>Transmit Pace None Xon</b>	:SYSTem:COMMunicate:SERial:TRANsmit:PACe XON NONE :SYSTem:COMMunicate:SERial:TRANsmit:PACe?
<b>Update in Remote</b>	:DISPlay: REMote ON OFF 1 0 :DISPlay: REMote?
<b>UWCDMA</b>	:MEMory:CATalog:UWCDma?
<b>View Next Error Message</b>	:SYSTem:ERRor[:NEXT]?
<b>WCDMA</b>	:MEMory:CATalog:WCDMa?

## Agilent 8656/57-Compatible Language

The ESG Family Signal Generators have the capability of operating in an Agilent 8656/57-compatible programming mode. The following table shows the 8656/57 programming codes that are implemented in the signal generator.

**Table 20 8656/57-Compatible Programming Codes**

8656/57 Command <sup>1</sup>	Parameter	Comments	Status
AM	Amplitude Modulation	Function Entry	Implemented
AO	Amplitude Offset	Function Entry	Implemented
AP	Amplitude (carrier)	Function Entry	Implemented
DB	dB	Units Entry	Implemented
DF	dBf	Units Entry	Implemented
DM	dBm	Units Entry	Implemented
DN	Step Down	Function Feature	Implemented <sup>2</sup>
EM	EMF	Units Entry	Implemented
FM	Frequency Modulation	Function Entry	Implemented
FR	Frequency (carrier)	Function Entry	Implemented
GT	Flexible Sequence	Feature	Implemented
HI	HI ALC	Function Feature	Not Implemented
HZ	Hz	Units Entry	Implemented
IS	Increment Set	Function Qualifier	Implemented <sup>2, 3</sup>
KZ	kHz	Units Entry	Implemented
LO	LO ALC	Function Feature	Not Implemented
MV	mV	Units Entry	Implemented
MZ	MHz	Units Entry	Implemented
P0	Digital Modulation Off	Function Entry	Implemented
P4	Digital Modulation On	Function Entry	Implemented
PC	Percent <sup>4</sup>	Units Entry	Implemented
PD	Phase Decrement	Function Feature	Implemented
PF	Pulse Modulation (Fast Mode)	Function Entry	Implemented
PI	Phase Increment	Function Feature	Implemented

**Table 20 8656/57-Compatible Programming Codes**

PM	Pulse Modulation	Function Feature	Implemented
QS	Reverse Sequence	Feature	Implemented
RC	Recall (0–9)	Feature	Implemented
RL	Recall (0–99)	Feature	Implemented
RP	Reverse Power Protection Reset <sup>5</sup>	Feature	Implemented
R0	Standby	Feature	Not Implemented
R1	On	Feature	Not Implemented
R2	RF Off	Function Feature	Implemented
R3	RF On	Function Feature	Implemented
R5	RF Dead (Full Attenuator)	Function Feature	Implemented
SQ	Sequence	Feature	Implemented
ST	Save (0–9)	Feature	Implemented
SV	Save (0–99)	Feature	Implemented
S1	External Modulation Source	Source Qualifier	Implemented
S2	Internal 400 Hz Modulation Source	Source Qualifier	Implemented
S3	Internal 1 kHz Modulation Source	Source Qualifier	Implemented
S4	Modulation Source Off	Source Qualifier	Implemented
S5	DC FM	Function Entry	Implemented
UP	Step Up	Function Feature	Implemented <sup>2</sup>
UV	μV	Units Entry	Implemented
VL	Volts	Units Entry	Implemented
0-9	Numerals 0–9	Data Entries	Implemented
–	Minus Sign	Data Entry	Implemented
.	Decimal Point	Data Entry	Implemented
%	Percent <sup>4</sup>	Units Entry	Implemented

1. Program codes can be either upper or lower case.
2. Implemented for frequency (FR) and amplitude (AP). Cannot be queried.
3. Minimum frequency IS value is 1 Hz. Maximum frequency IS value is 999.999999 kHz. Minimum amplitude IS value is 0.1 dB. Maximum amplitude IS value is 160.5 dB.
4. Either PC or % can be used.
5. The source of reverse power must be removed.

## Command Mapping

The SCPI command, :SYSTem:LANGuage “SCPI” | “COMP” | “NADC” | “PDC” | “PHS”, lets you set the signal generator remote (GPIB) language to one of the following choices:

- “SCPI” - Default language (Standard Commands for Programmable Instruments)
- “COMP” - 8656B, 8657A/B compatibility
- “NADC” - 8657D NADC compatibility
- “PDC” - 8657D PDC compatibility
- “PHS” - 8657J PHS compatibility

When you operate in an 8656/57-compatibility language, internal mapping occurs in the signal generator to effect an equivalent SCPI response. In addition, the modulation sources for the 8656/57 are not the same as for the ESG family, so when you operate in an 8656/57-compatibility language, the following mapping occurs for selecting AM and FM sources:

Modulation Sources	
8656/57	ESG Family
AM, Internal	AM1, Internal 1
AM, External	AM2, External 1
FM, Internal	FM1, Internal 1
FM, External	FM2, External 1
AM, Internal and External	AM1, Internal 1 and AM2, External 1
FM, Internal and External	FM1, Internal 1 and FM2, External 1

The 8656/57 Signal Generators allow multiple modulations to use the same input, the ESG Family Signal Generators do not. If you configure multiple modulations on the same input, the signal generator will respond by automatically disabling modulations.

The mapping between the 8656/57-compatible commands and the SCPI commands will change depending on the other parameters that are executed. Refer to the following explanations of the commands:

### AM (Amplitude Modulation)

- AM becomes the active function.
- AM1 and AM2 depth values are coupled with [:SOURCE]:AM[1] | 2[:DEPTH]:TRACk ON.
- If AM was already on, or no modulation was on, the following sequences of SCPI commands are implemented when an AM command is sent with a modulation source command:

	AM Already On	No Modulation Already On
S1	[:SOURCE]:AM2:EXTernal[1] :COUPling AC [:SOURCE]:AM2:SOURce EXTernal1	[:SOURCE]:AM2:EXTernal[1] :COUPling AC [:SOURCE]:AM2:SOURce EXTernal1 [:SOURCE]:AM2:STATe ON
S2	[:SOURCE]:AM[1]:SOURce INT[1] [:SOURCE]:AM[1]:INTernal[1] :FREQuency 400 Hz	[:SOURCE]:AM[1]:SOURce INT[1] [:SOURCE]:AM[1]:INTernal[1] :FREQuency 400 Hz [:SOURCE]:AM[1]:STATe ON
S3	[:SOURCE]:AM[1]:SOURce INT[1] [:SOURCE]:AM[1]:INTernal[1] :FREQuency 1 kHz	[:SOURCE]:AM[1]:SOURce INT[1] [:SOURCE]:AM[1]:INTernal[1] :FREQuency 1 kHz [:SOURCE]:AM[1]:STATe ON

- If FM or pulse modulation was already on, the signal generator attempts to set up AM with the same settings. In addition, the following commands are mapped:

	FM1 Already On	FM2 or Pulse Already On
S1, S2, or S3	[:SOURCE]:AM[1]:SOURce INT[1] [:SOURCE]:AM[1]:STATe ON [:SOURCE]:FM[1]:STATe OFF	[:SOURCE]:AM2 :SOURce EXTernal1 [:SOURCE]:AM2:STATe ON [:SOURCE]:FM2:STATe OFF [:SOURCE]:PULM:STATe OFF

**FM (Frequency Modulation)**

- FM becomes the active function.
- FM1 and FM2 deviation values are coupled with [:SOURCE]:FM[1] | 2[:DEVIation]:TRACk ON.
- If FM was already on, or no modulation was on, the following sequences of SCPI commands are implemented when an FM command is sent with a modulation source command:

	FM Already On	No Modulation Already On
S1	[:SOURCE]:FM2:EXTernal[1] :COUPling AC [:SOURCE]:FM2:SOURce EXTernal1	[:SOURCE]:FM2:EXTernal[1] :COUPling AC [:SOURCE]:FM2:SOURce EXTernal1 [:SOURCE]:FM2:STATe ON
S2	[:SOURCE]:FM[1]:SOURce INT[1] [:SOURCE]:FM[1]:INTernal[1] :FREQuency 400 Hz	[:SOURCE]:FM[1]:SOURce INT[1] [:SOURCE]:FM[1]:INTernal[1] :FREQuency 400 Hz [:SOURCE]:FM[1]:STATe ON
S3	[:SOURCE]:FM[1]:SOURce INT[1] [:SOURCE]:FM[1]:INTernal[1] :FREQuency 1 kHz	[:SOURCE]:FM[1]:SOURce INT[1] [:SOURCE]:FM[1]:INTernal[1] :FREQuency 1 kHz [:SOURCE]:FM[1]:STATe ON

- If AM or pulse modulation was already on, the signal generator attempts to set up FM with the same settings. In addition, the following commands are mapped:

	AM1 Already On	AM2 or Pulse Already On
S1, S2, or S3	[:SOURCE]:FM[1]:SOURce INT[1] [:SOURCE]:FM[1]:STATe ON [:SOURCE]:AM[1]:STATe OFF	[:SOURCE]:FM2 :SOURce EXTernal1 [:SOURCE]:FM2:STATe ON [:SOURCE]:AM2:STATe OFF [:SOURCE]:PULM:STATe OFF

**P0 (Digital Modulation Off)**

This command turns off digital modulation (for 8657D/J-compatibility only.) The P0 command is mapped to the following SCPI command:

```
[:SOURCE]:DM:STATe OFF
```

## P4 (Digital Modulation On)

This command turns on digital modulation (for 8657D/J-compatibility only.)  
The P4 command is mapped to the following SCPI commands:

- [:SOURce]:AM[1]:STATe OFF
- [:SOURce]:AM2:STATe OFF
- [:SOURce]:FM[1]:STATe OFF
- [:SOURce]:FM2:STATe OFF
- [:SOURce]:DM:SOURce INTernal1
- [:SOURce]:RADIO:<format>:STATe ON
- [:SOURce]:RADIO:<format>:REPeat CONT
- [:SOURce]:RADIO:<format>:DATA EXTernal
- [:SOURce]:DM:STATe ON

where <format> is either NADC, PDC, or PHS, depending on the specific compatibility language selected.

## PF (Pulse Modulation - Fast Mode) or PM (Pulse Modulation)

The ESG Family Signal Generators support only one input for pulse: EXTERNAL2. (This is a DC-coupled input.) Internal pulse modulation, therefore, is not supported in 8656/57-compatibility mode. The PF (or PM) command is mapped to the following SCPI commands:

- [:SOURce]:PULM:SOURce EXTernal2
- [:SOURce]:PULM:STATe ON

## S1 (External Modulation Source)

No action is taken until a modulation form is selected. Pulse is set to EXTERNAL2. AM and FM are set to INTERNAL1.

## S2 (Internal 400 Hz Modulation Source)

- If AM1 is on, this command is mapped to:  
[:SOURce]:AM[1]:INTernal[1]:FREQuency 400 Hz
- If FM1 is on, this command is mapped to:  
[:SOURce]:FM[1]:INTernal[1]:FREQuency 400 Hz



**S3 (Internal 1 kHz Modulation Source)**

- If AM1 is on, this command is mapped to:

```
[ :SOURce]:AM[1]:INTernal[1]:FREQuency 1 kHz
```

- If FM1 is on, this command is mapped to:

```
[ :SOURce]:FM[1]:INTernal[1]:FREQuency 1 kHz
```

**S4 (Modulation Source Off)**

- If the last active function was PM, (other than any modulation source commands), pulse modulation is disabled by mapping to the following command:

```
[ :SOURce]:PULM:STATe OFF
```

- If the last command was S2 or S3, internal modulation is turned off for whatever modulation type is currently active by mapping to the following commands:

```
[ :SOURce]:AM[1]:STATe OFF
```

```
[ :SOURce]:FM[1]:STATe OFF
```

The S2 or S3 condition is also discarded so that the next time S4 is sent, the entire modulation type will be turned off.

- If the last command was S1, external modulation is turned off for whatever modulation type is currently active by mapping to the following commands:

```
[ :SOURce]:AM2:STATe OFF
```

```
[ :SOURce]:FM2:STATe OFF
```

The S1 condition is also discarded so that the next time S4 is sent, the entire modulation type will be turned off.

- If the last active function was AM or FM, the entire appropriate modulation type is turned off by mapping to the following commands:

```
[ :SOURce]:AM[1]:STATe OFF
```

```
[ :SOURce]:AM2:STATe OFF
```

```
[ :SOURce]:FM[1]:STATe OFF
```

```
[ :SOURce]:FM2:STATe OFF
```

## S5 (DC FM)

- FM becomes the active function.
- In addition, the following commands are mapped:

```
[ :SOURce ]:FM2:SOURce EXTernal1  
[ :SOURce ]:PULM:STATe OFF  
[ :SOURce ]:AM[1]:STATe OFF  
[ :SOURce ]:AM2:STATe OFF  
[ :SOURce ]:FM2:EXTernal[1]:COUPling DC  
[ :SOURce ]:FM2:STATe ON
```

## Additional Commands

To allow configuration of the compatibility mode as well as to isolate problems, the following SCPI commands are supported while in 8656/57-compatibility mode:

- :SYSTem:LANGUage "SCPI" | "COMP" | "NADC" | "PDC" | "PHS"
- :SYSTem:LANGUage?
- :SYSTem:ERRor?

---

# Index

---

## Symbols

- \*CLS clear status command, [2-3](#)
- \*ESE standard event status enable command, [2-3](#)
- \*ESR? standard event status register query, [2-3](#)
- \*IDN? identification query, [2-3](#)
- \*OPC operation complete command, [2-3](#)
- \*OPC? operation complete query, [2-4](#)
- \*RCL recall command, [2-4](#)
- \*RST reset command, [2-4](#)
- \*SAV save command, [2-4](#)
- \*SRE service request enable command, [2-4](#)
- \*SRE? service request enable query, [2-4](#)
- \*STB? read status byte query, [2-4](#)
- \*TRG trigger command, [2-5](#)
- \*TST? self-test query, [2-5](#)
- \*WAI wait-to-continue command, [2-5](#)

## Numerics

- 1 GHz reference unlocked, [2-99](#)
- 10 MHz
  - reference, checking for cold oven, [2-99](#)
  - reference, unlocked, [2-99](#)

## A

- abort command, [1-18](#)
- ac coupling example, setting, [2-87](#)
- address, [2-76](#), [2-83](#)
- amplitude modulation SCPI commands
  - AM subsystem, [2-7](#)
  - depth, [2-8](#)
  - depth coupling, [2-8](#)
  - external source coupling, [2-8](#)
  - internal
    - alternate frequency, [2-9](#)
    - alternate frequency amplitude, [2-9](#)
    - source rate, [2-9](#)
    - sweep time, [2-9](#)
    - sweep trigger, [2-10](#)
    - waveform, [2-10](#)
  - source, [2-7](#)
  - state, [2-7](#)
  - wideband state, [2-11](#)
- annunciators
  - EXT1 HI, [2-7](#)
  - EXT1 LO, [2-7](#)
  - EXT2 HI, [2-7](#)
  - EXT2 LO, [2-7](#)
- ARB memory vs. NVARB memory, [3-2](#)

- ARB waveform file downloads, [3-4](#)
  - example programs, [3-7](#)
  - playing a downloaded waveform, [3-10](#)
  - preliminary setup, [3-5](#)
  - querying the waveform data, [3-6](#)
  - SCPI commands, [3-5](#)

## B

- backplane, [1-2](#)
- baseband synthesizer unlocked, [2-99](#)
- BERT condition register, data questionable, [1-71](#)
- binary memory and bit memory, [3-12](#)
- binary memory catalog user file downloads, [3-19](#)
- binary memory vs. bit memory, [3-12](#)
- bit memory and binary memory, [3-12](#)
- bit memory catalog user file downloads, [3-18](#)
- bit-value-vs.-output-power, ARB waveforms, [3-2](#)
- block parameter, [1-40](#)
- boolean parameters, [1-40](#)
- buffering, [1-2](#)
- burst SCPI commands
  - BURSt subsystem, [2-19](#)
  - envelope state, [2-19](#)
  - source, [2-19](#)

## C

- calibration condition register, data questionable, [1-68](#)
- calibration SCPI commands
  - CALibration subsystem, [2-12](#)
  - DCFM/DCΦM, [2-12](#)
  - default I/Q, [2-12](#)
  - full I/Q, [2-12](#)
  - I/Q, [2-13](#)
  - I/Q start frequency, [2-13](#)
  - I/Q stop frequency, [2-13](#)
- carrier frequency example, setting, [2-89](#), [2-93](#)
- carrier power example, setting, [2-89](#)
- characters, white space, [1-30](#)
- check function, [2-99](#)
- clear command
  - description, [1-21](#)
  - display example, [2-82](#)
  - pending output example, [1-6](#), [2-78](#), [2-80](#)
  - status byte register example, [2-91](#)
- cold oven, checking for, [2-99](#)
- colon, in commands, [1-30](#)
- comma, in SCPI commands, [1-30](#)
- command tree, SCPI, [1-29](#)

---

# Index

---

- commented command, 2-82
  - common commands
    - description, 1-28
    - syntax, 1-36
  - COMMunicate subsystem
    - description, 2-14
    - GP-IB address, 2-14
    - RS-232 baud rate, 2-14
    - RS-232 echo, 2-15
    - RS-232 reset, 2-14
    - RS-232 RTS control, 2-14
    - RS-232 timeout, 2-15
    - RS-232 XON handshake receive state, 2-15
    - RS-232 XON handshake transmit state, 2-15
  - condition register
    - data questionable
      - BERT, 1-71
      - calibration, 1-68
      - description, 1-55
      - frequency, 1-62
      - modulation, 1-65
      - power, 1-59
    - description, 1-46
    - standard operation, 1-52
  - connector, 2-86
  - continuous step sweep example, 2-90
  - controller, definition, 1-17
  - CW frequency query, 2-82
  - CW power query example, 2-82
- ## D
- data limitations
    - ARB waveform downloads, 3-3
    - FIR filter downloads, 3-23
    - PRAM downloads, 3-28
    - user file downloads, 3-13
  - data questionable
    - BERT
      - condition register, 1-71
      - event enable register, 1-72
      - status group, 1-70
    - calibration
      - condition register, 1-68
      - event enable register, 1-69
      - status group, 1-67
    - condition register, 1-55
    - event enable register, 1-57
    - frequency
      - condition register, 1-62
      - event enable register, 1-63
      - event register, 2-100
      - status group, 1-61
    - data questionable (Continued)*
      - modulation
        - condition register, 1-65
        - event enable register, 1-66
        - event register, 2-99
        - status group, 1-64
        - status group example, 2-99
      - power
        - condition register, 1-59
        - event enable register, 1-60
        - event register, 2-100
        - status group, 1-58, 2-100
        - status group, 1-54
  - data requirements
    - ARB waveform downloads, 3-3
    - FIR filter downloads, 3-23
    - PRAM downloads, 3-27
    - user file downloads, 3-13
  - data types, 1-37, 1-40
  - data volatility
    - ARB waveform downloads, 3-4
    - FIR filter downloads, 3-24
    - PRAM downloads, 3-28
    - user file downloads, 3-14
  - DCFM/DC $\Phi$ M calibration SCPI command, 2-12
  - default I/Q calibration SCPI command, 2-12
  - deviation example, setting, 2-87
  - DIAGnostic Subsystem
    - attenuator cycle information, 2-16
    - description, 2-16
    - detailed option information, 2-16
    - display time-on information, 2-16
    - firmware information, 2-17
    - installed board information, 2-16
    - instrument serial number information, 2-17
    - instrument time-on information, 2-17
    - option information, 2-16
    - power cycle information, 2-16
    - reverse power protection trips information, 2-16
  - discrete
    - function, querying, 2-82
    - parameters, 1-39
    - response data, 1-41
  - display example, clear command, 2-82
  - display SCPI commands
    - amplitude units, 2-18
    - brightness configuration, 2-18
    - contrast configuration, 2-18
    - DISPlay Subsystem, 2-18
    - inverse video configuration, 2-18
  - DM subsystem
    - description, 2-19

---

# Index

---

## *DM subsystem (Continued)*

- digital modulation mode state, [2-19](#)
  - digital modulation source, [2-19](#)
  - external ALC bandwidth configuration, [2-20](#)
  - high crest mode state, [2-20](#)
  - I channel offset adjustment, [2-20](#)
  - I/Q adjustments state, [2-20](#)
  - I/Q gain ratio adjustment, [2-21](#)
  - I/Q modulation phase polarity, [2-21](#)
  - Q channel offset adjustment, [2-21](#)
  - quadrature skew adjustment, [2-21](#)
- downloading
- ARB waveform data, [3-2](#)
  - FIR filter coefficient data, [3-23](#)
  - to PRAM, [3-27](#)
  - user files, [3-12](#)

## **E**

- enable register, service request, [1-46](#)
- end of sweep service request example, [2-101](#)
- endless loop, example, [2-103](#)
- enter command, [1-23](#)
- errors, instrument, reading, [1-34](#)
- event commands, description, [1-32](#)
- event enable register
  - BERT data questionable, [1-72](#)
  - calibration data questionable, [1-69](#)
  - data questionable, [1-57](#)
  - description, [1-47](#)
  - frequency data questionable, [1-63](#)
  - modulation data questionable, [1-66](#)
  - power, data questionable, [1-60](#)
  - standard operation, [1-53](#)
- event register
  - description, [1-47](#)
  - frequency, data questionable, [2-100](#)
  - modulation, data questionable, [2-99](#)
  - power, data questionable, [2-100](#)
- example programs
  - AC-coupled external FM signal, generating, [2-86](#)
  - AC-coupled internal FM signal, generating, [2-88](#)
  - CW signal, generating, [2-84](#)
  - end of sweep service request, [2-101](#)
  - external pulse modulated signal, generating, [2-92](#)
  - local lockout, [2-79](#)
  - queries, using, [2-81](#)
  - states, saving and recalling, [2-94](#)
  - status byte
    - reading, [2-97](#)
  - step-swept signal, generating, [2-90](#)

## examples

- CW frequency query, [2-82](#)
  - CW power query, [2-82](#)
  - endless loop, [2-103](#)
  - frequency mode, setting, [2-91](#)
  - local lockout, [2-80](#)
  - output, setting, [2-91](#)
  - power level, setting, [2-85](#), [2-93](#)
  - power leveling, [2-93](#)
  - pulse modulation, turning on, [2-93](#)
  - query response into variable, [2-82](#)
  - set list type, [2-91](#)
  - setting frequency, [2-85](#)
  - setting frequency modulation, [2-89](#)
- EXT1 HI annunciator, [2-7](#)
- EXT1 LO annunciator, [2-7](#)
- EXT2 HI annunciator, [2-7](#)
- EXT2 LO annunciator, [2-7](#)
- extended numeric parameter, [1-38](#)
- external
- connector, [2-86](#)
  - input, [2-92](#)
  - source, [2-87](#)
- external SCPI commands
- AM source coupling, [2-8](#)
- ## **F**
- fast pulse modulation SCPI command, [2-56](#)
- filter
- negative transition, [1-46](#)
  - positive transition, [1-47](#)
- FM subsystem
- internal frequency modulation alternate frequency amplitude, [2-24](#)
- forgiving listening, description, [1-27](#)
- frequency condition register, data questionable, [1-62](#)
- frequency event register, data questionable, [2-100](#)
- frequency examples
- mode, setting, [2-91](#)
  - modulation, setting, [2-87](#), [2-89](#)
  - setting, [2-85](#), [2-87](#)
- frequency modulation SCPI commands
- deviation, [2-22](#)
  - deviation coupling, [2-23](#)
  - external source coupling, [2-22](#)
  - FM subsystem, [2-22](#)
  - internal
    - alternate frequency, [2-24](#)
    - source rate, [2-25](#)
    - sweep time, [2-25](#)
    - sweep trigger, [2-25](#)

---

# Index

---

*frequency modulation SCPI commands, internal (Continued)*  
    waveform, 2-25  
    source, 2-23  
    state, 2-24

frequency SCPI commands, 2-27  
    continuous wave (CW), 2-27  
    fixed, 2-27  
    mode, 2-27  
    multiplier, 2-28  
    offset, 2-28  
    optimization, 2-28  
    phase adjustment, 2-29  
    phase reference, setting, 2-30  
    reference, 2-29  
    reference oscillator source query, 2-29  
    reference oscillator source state, 2-30  
    reference state, 2-29  
    start, 2-30  
    stop, 2-30

FREQUENCY subsystem, 2-27

full I/Q calibration SCPI command, 2-12

function generator SCPI commands  
    pulse period configuration, 2-31  
    pulse width configuration, 2-31  
    sweep time, 2-31

## G

group, status byte, 1-44

## H

HP 8656/57-compatible commands, 4-21

HP Basic, 1-9

HP-IB

    address, 2-76, 2-77  
    command statements  
        abort, 1-18  
        clear, 1-21  
        enter, 1-23  
        introduction, 1-18  
        local, 1-20  
        local lockout, 1-20  
        output, 1-22  
        remote, 1-19  
    querying address, 2-83  
    select code, 2-76  
    verification, 1-6

## I

I/O libraries, 1-2, 1-3

I/O, maximum, 1-2

I/Q calibration SCPI commands

    full, 2-12

    I/Q, 2-13

    start frequency, 2-13

    stop frequency, 2-13

IEEE 488.2 common commands

    \*CLS clear status, 2-3

    \*ESE standard event status enable, 2-3

    \*ESR? standard event status query, 2-3

    \*IDN? identification, 2-3

    \*OPC operation complete, 2-3

    \*OPC? operation complete query, 2-4

    \*RCL recall, 2-4

    \*RST reset, 2-4

    \*SAV save, 2-4

    \*SRE service request enable, 2-4

    \*SRE? service request enable query, 2-4

    \*STB? read status byte query, 2-4

    \*TRG trigger, 2-5

    \*TST? self-test query, 2-5

    \*WAI wait-to-continue, 2-5

    introduction, 2-3

implied commands, 1-32

instrument errors, reading, 1-34

integer response data, 1-41

interface cards, 1-2

internal amplitude modulation SCPI commands

    alternate frequency, 2-9

    alternate frequency amplitude, 2-9

    source rate, 2-9

    sweep time, 2-9

    sweep trigger, 2-10

    waveform, 2-10

internal FM source deviation example, setting, 2-89

internal FM source rate example, setting, 2-89

interrupt, example of enabling, 2-103

IQ calibration SCPI commands

    default, 2-12

## K

key versus command table, 4-2

keys, disabling, 2-79

## L

languages, 1-2

LFOutput subsystem

    function generator sweep trigger, 2-31

list example, set type, 2-91

list SCPI commands

    direction, 2-35

---

# Index

---

## *list SCPI commands (Continued)*

- dwll
    - basic command, [2-34](#)
    - points query, [2-34](#)
    - type, [2-34](#)
  - frequency
    - basic command, [2-34](#)
    - points query, [2-34](#)
  - LIST subsystem, [2-34](#)
  - load from step sweep, [2-36](#)
  - manual point, [2-36](#)
  - mode, [2-35](#)
  - power
    - basic command, [2-36](#)
    - points query, [2-36](#)
  - preset, [2-36](#)
  - trigger source, [2-35](#)
  - type, [2-35](#)
- listener definition, [1-17](#)
- local command, [1-20](#)
- local lockout
  - command, [1-20](#)
  - example, [2-80](#)
  - example program, [2-79](#)
- loop, endless, example, [2-103](#)
- low frequency output SCPI commands
  - alternate frequency, [2-32](#)
  - alternate frequency amplitude, [2-32](#)
  - amplitude, [2-32](#)
  - frequency, [2-32](#)
  - function generator pulse period configuration, [2-31](#)
  - function generator pulse width configuration, [2-31](#)
  - function generator sweep time, [2-31](#)
  - LFOutput subsystem, [2-31](#)
  - source, [2-33](#)
  - state, [2-33](#)
  - waveform, [2-33](#)

## **M**

- memory SCPI commands
- MEMory subsystem
    - all memory catalog, [2-37](#)
    - binary memory catalog, [2-38](#)
    - copy files, [2-39](#)
    - delete
      - all, [2-39](#)
      - binary, [2-40](#)
      - bit, [2-40](#)
      - filename, [2-41](#)
      - FIR, [2-41](#)
      - FSK, [2-41](#)
      - IQ, [2-41](#)

## *memory SCPI commands*

- MEMory subsystem, delete (Continued)
    - list, [2-41](#)
    - shape, [2-41](#)
    - state, [2-41](#)
  - free memory query, [2-41](#)
  - introduction, [2-37](#)
  - list memory catalog, [2-42](#)
  - load sweep list, [2-42](#)
  - memory data load, [2-42](#)
  - memory filename query, [2-42](#)
  - rename file, [2-43](#)
  - state comment, [2-43](#)
  - state memory catalog, [2-43](#)
  - store sweep list, [2-43](#)
- MEMory subsystems
- ARB Catalog Types, [2-37](#)
  - bit memory catalog, [2-39](#)
  - delete
    - ARB File Types, [2-40](#)
    - Modulation Catalog Types, [2-42](#)
- MMEemory subsystem
- all memory catalog, [2-37](#)
  - copy files, [2-39](#)
  - delete filename, [2-41](#)
  - introduction, [2-37](#)
  - load sweep list, [2-42](#)
  - memory data load, [2-42](#)
  - memory filename query, [2-42](#)
  - store sweep list, [2-43](#)
- messages, program and response, [1-27](#)
- mode
  - local lockout example, [2-80](#)
- modulation
  - condition register, data questionable, [1-65](#)
  - state, querying, [2-82](#)
  - status group example, data questionable, [2-99](#)

## **N**

- negative transition filter, [1-46](#)
- numeric parameter, [1-38](#)
- NVARB memory vs. ARB memory, [3-2](#)

## **O**

- operating systems, [1-2](#)
- optional SCPI parameters, [1-32](#)
- output
  - HP-IB command statement, [1-22](#)
  - SCPI commands
    - circuit protection
      - clear, [2-44](#)
      - mode, [2-44](#)

---

# Index

---

*output SCPI commands, circuit protection (Continued)*  
query, 2-44  
modulation state, 2-45  
OUTPut subsystem, 2-44  
state, 2-45  
setting, example, 2-91  
oven cold, checking for, 2-99  
overmodulation, 2-99

## P

parameters (SCPI)  
block, 1-40  
boolean, 1-40  
discrete, 1-39  
extended numeric, 1-38  
numeric, 1-38  
optional, 1-32  
separating in commands, 1-30  
phase adjustment, 2-29  
phase modulation SCPI commands  
bandwidth configuration, 2-46  
deviation, 2-46  
deviation coupling, 2-47  
external source coupling, 2-48  
internal  
alternate frequency, 2-49  
alternate frequency amplitude, 2-49  
source rate, 2-49  
sweep time, 2-49  
sweep trigger, 2-49  
waveform, 2-50  
PM subsystem, 2-46  
source, 2-47  
state, 2-47  
positive transition filter, 1-47  
power  
condition register, data questionable, 1-59  
event register, data questionable, 2-100  
level, example, 2-85, 2-93  
leveling, example, 2-93  
SCPI commands  
alternate amplitude  
delta, 2-51  
manual trigger, 2-51  
state, 2-51  
trigger source, 2-52  
automatic RF output level attenuation, 2-52  
define power units, 2-52  
POWer subsystem, 2-51  
RF output  
ALC bandwidth, 2-52  
ALC search reference, 2-53

*power SCPI commands, RF output (Continued)*  
ALC search state, 2-53  
ALC state, 2-53  
level amplitude offset, 2-54  
level immediate amplitude, 2-54  
mode, 2-54  
reference power, 2-54  
reference power state, 2-55  
start power, 2-55  
stop power, 2-55  
status group, data questionable, 1-58, 2-100  
power level example, setting, 2-87  
PRAM downloads  
in block format, 3-30  
preliminary setup, 3-31  
sample commands line, 3-31  
SCPI commands, 3-31  
in list format, 3-29, 3-30  
data query SCPI command, 3-30  
preliminary setup, 3-29  
SCPI commands, 3-30  
modulating and activating the carrier, 3-32  
precise talking, description, 1-27  
problems  
ARB waveform downloads, 3-38  
PRAM downloads, 3-33  
user file downloads, 3-35  
user FIR filter downloads, 3-38  
program message, definition, 1-27  
programming  
cross reference, 4-1  
introduction, 1-9  
language, HP Basic, 1-9  
pulse modulation example, 2-93  
pulse modulation SCPI commands  
internal  
pulse period configuration, 2-56  
pulse width configuration, 2-56  
source rate, 2-57  
waveform configuration, 2-57  
PULM subsystem, 2-56  
source, 2-57  
state, 2-57  
state (fast pulse), 2-56

## Q

queries  
commands, 2-81  
description of commands, 1-32  
example of using, 2-81  
examples  
CW frequency value, 2-82  
CW power, 2-82



---

# Index

---

*queries, examples (Continued)*

response, 2-82

## R

real response data, 1-40

reference oscillator source

query, 2-29

state, 2-30

register

condition, description, 1-46

contents, recalling, 2-96

event enable, 1-47

service request enable, 1-46

status byte, 1-45

status byte, overall system, 1-43

remote

annunciator, 2-77

command, 1-19

remote interface

GPIB

configuring, 1-5

for personal computers

backplane, 1-2

buffering, 1-2

I/O library, 1-2

interface cards, 1-2

languages, 1-2

maximum I/O, 1-2

operating systems, 1-2

for UNIX workstations

backplane, 1-3

buffering, 1-3

I/O library, 1-3

interface cards, 1-3

languages, 1-3

maximum I/O, 1-3

operating systems, 1-3

I/O libraries, 1-3

required equipment, 1-2

SICL, 1-3

VISA, 1-3

RS-232

configuring, for personal computer, 1-8

connecting, 1-8

operation verification, 1-8

remote programming, verifying functionality, 1-6

reset

parser example, 1-6, 2-78, 2-80

status byte register, 2-99

response data

discrete, 1-41

format, using query commands, 2-81

*response data (Continued)*

integer, 1-41

real, 1-40

string, 1-41

types, 1-40

response message, definition, 1-27

RF output example, setting, 2-87

RF output examples

setting, 2-91

turning on, 2-85, 2-89, 2-93

root-level SCPI command, 1-30

route SCPI commands

data clock output state, 2-58

data output state, 2-58

input polarity configuration

burst gate, 2-58

data, 2-59

data clock, 2-58

pattern trigger, 2-59

symbol sync, 2-59

output polarity configuration

data, 2-59

data clock, 2-58

event 1/2, 2-59

symbol sync, 2-60

ROUTE subsystem, 2-58

symbol sync output state, 2-58

## S

sample command line, 3-30

SCPI commands

ARB waveform file downloads, 3-5

example programs

HP BASIC for UNIX, 3-8

HP BASIC for Windows, 3-7

playing a downloaded waveform, 3-10

preliminary setup, 3-5

querying the waveform data, 3-6

sample command line, 3-6

command tree

levels, 1-30

paths, 1-29

root command, 1-29

commented, 2-82

common, 1-28

data types, 1-37

getting started with, 1-25

implied, 1-32

mapping, 4-23

PRAM downloads

in block format, 3-31

preliminary setup, 3-31

sample command line, 3-31

---

# Index

---

## *SCPI commands, PRAM downloads, (Continued)*

- in list format, [3-30](#)
- preliminary setup, [3-29](#)
- querying the PRAM data, [3-30](#)
  - sample command line, [3-30](#)
- modulating and activating the carrier, [3-32](#)
- query, [2-81](#)
- separating parameters, [1-30](#)
- subsystem, [1-28](#)
- syntax, [1-35](#), [2-2](#)
- terms, [1-25](#)
- types, [1-28](#), [1-29](#)
- user file downloads, [3-18](#), [3-19](#)
  - modulating and activating the carrier, [3-21](#)
  - querying the PRAM data, [3-19](#), [3-20](#)
  - sample command line, [3-19](#), [3-20](#)
  - selecting the user file for unframed transmission, [3-20](#), [3-21](#)
- user FIR file downloads, [3-24](#)
  - modulating and activating the carrier, [3-26](#)
  - querying the filter coefficients, [3-24](#)
  - sample command line, [3-24](#)
  - selecting a user FIR file, [3-25](#)
- wait, [2-91](#)
- select code, [2-76](#)
- service request enable register, [1-46](#)
- service request example, [2-101](#), [2-102](#)
- SICL, [1-3](#)
- signal generator
  - identity, [2-83](#)
  - model, [2-83](#)
  - programming, [1-9](#)
- signal polarity SCPI commands. *See* route SCPI commands
- source, [2-87](#)
- SRQ, [2-103](#)
- standard event status
  - enable register, [1-50](#)
  - group, [1-48](#)
  - register, [1-49](#)
- standard operation
  - condition register, [1-52](#)
  - event enable register, [1-53](#)
  - status group, [1-51](#)
- start/stop frequency example, setting, [2-91](#)
- states
  - saving, [2-94](#)
  - saving and recalling example, [2-94](#)
- status byte
  - example of clearing, [2-91](#)
  - example of reading, [2-97](#)
  - group, [1-44](#)

## *status byte (Continued)*

- register, [1-45](#)
- register system, [1-42](#), [1-43](#)
- reset example, [2-99](#)
- status enable register, [1-50](#)
- status group, [1-48](#), [1-51](#), [1-70](#)
  - calibration, data questionable, [1-67](#)
  - data questionable, [1-54](#)
  - frequency, data questionable, [1-61](#)
  - modulation, data questionable, [1-64](#)
  - power, data questionable, [1-58](#), [2-100](#)
- status register, [1-49](#)
- STATus subsystem
  - introduction, [2-61](#)
  - standard operation status group
    - enable, [2-67](#)
      - event register query, [2-67](#)
      - negative transition filter register enable, [2-68](#)
  - status preset, [2-61](#)
- STATus subsystem, data questionable
  - BERT status group
    - condition register query, [2-61](#)
    - enable, [2-61](#)
    - event register query, [2-61](#)
    - negative transition filter register enable, [2-62](#)
    - positive transition filter register enable, [2-62](#)
  - calibration status group
    - condition register query, [2-62](#)
    - enable, [2-62](#)
    - event register query, [2-62](#)
    - negative transition filter register enable, [2-63](#)
    - positive transition filter register enable, [2-63](#)
  - condition pos. transition filter register enable, [2-63](#)
  - condition query, [2-63](#)
  - frequency status group
    - condition register query, [2-63](#)
    - enable, [2-64](#)
    - event register query, [2-64](#)
    - negative transition filter register enable, [2-64](#)
    - positive transition filter register enable, [2-64](#)
  - modulation status group
    - condition register query, [2-64](#)
    - enable, [2-65](#)
    - event register query, [2-65](#)
    - negative transition filter register enable, [2-65](#)
    - positive filter register enable, [2-65](#)
  - power status group
    - condition register query, [2-65](#)
    - enable, [2-66](#)
    - event register query, [2-66](#)
    - negative transition filter register enable, [2-66](#)
    - positive transition filter register enable, [2-66](#)

---

# Index

---

## *STATus subsystem, data questionable (Continued)*

- status group
  - enable, [2-66](#)
  - event register query, [2-67](#)
  - negative transition filter register enable, [2-67](#)
- STATus subsystem, standard operation status
  - group condition register query, [2-67](#)
  - group positive transition filter register enable, [2-68](#)
- step sweep example, [2-90](#)
- steps example, setting, [2-91](#)
- string
  - response data, [1-41](#)
  - variable, entering response, [2-82](#)
  - variables, dimensioning example, [2-82](#), [2-95](#)
- subsystem commands, [1-28](#), [2-6](#)
- sweep
  - mode example, setting, [2-91](#)
  - step example, [2-90](#)
  - trigger, [2-103](#)
- SWEep subsystem, [2-69](#)
  - sweep dwell, [2-69](#)
  - sweep points, [2-69](#)
- syntax
  - common command, [1-36](#)
  - drawings, [1-18](#)
- synthesizer unlocked, [2-99](#)
- SYSTEM subsystem, [2-70](#)
  - error information query, [2-70](#)
  - help mode, [2-70](#)
  - persistent state and instrument state reset, [2-70](#)
  - persistent state reset, [2-70](#)
  - PN9 preset configuration, [2-70](#)
  - power on/preset conditions, [2-71](#)
  - preset language, [2-71](#)
  - preset save, [2-71](#)
  - preset type, [2-71](#)
  - remote language, [2-72](#)
  - SCPI capability query, [2-72](#)
  - SCPI version, [2-72](#)
  - screen saver delay, [2-72](#)
  - screen saver mode, [2-73](#)
  - screen saver state, [2-73](#)
  - system preset, [2-73](#)

## T

- talker, [1-17](#)
- terminators, [1-29](#)
- TRIGger subsystem, [2-74](#)
  - abort, [2-74](#)
  - continuous sweep, [2-74](#)
  - external trigger on slope, [2-74](#)

## *TRIGger subsystem (Continued)*

- immediate trigger, [2-74](#)
- single sweep, [2-75](#)
- trigger output polarity, [2-75](#)
- trigger source, [2-75](#)
- trigger sweep, [2-103](#)
- troubleshooting
  - ARB waveform downloads, [3-38](#)
  - PRAM downloads, [3-33](#)
  - user file downloads, [3-35](#)
  - user FIR filter downloads, [3-38](#)

## U

- undermodulation
  - checking for, [2-97](#)
  - creating, [2-97](#)
  - example, [2-99](#)
- unleveled output
  - checking for, [2-97](#)
  - creating, [2-97](#)
- unlocked
  - 1 GHz reference, [2-99](#)
  - 10 MHz reference, [2-99](#)
  - baseband synthesizer, [2-99](#)
  - synthesizer, [2-99](#)
- user file downloads, [3-18](#)
  - modulating and activating the carrier, [3-21](#)
  - selecting the user file as the data source, [3-20](#)
- user files
  - as data sources for frames transmissions, [3-14](#)
  - as data sources with PN sequences, [3-17](#)
  - in framed mode, [3-12](#)
  - in pattern mode, [3-12](#)
  - multiple user files as data sources, [3-16](#)
- user FIR file downloads, [3-24](#)
  - modulating and activating the carrier, [3-25](#)
  - selecting a downloaded user FIR file, [3-24](#)

## V

- VISA, [1-3](#)

## W

- wait command example, [2-91](#)
- waveform
  - downloading
    - using HP BASIC for UNIX, [3-8](#)
    - using HP BASIC for Windows, [3-7](#)
- white space characters, [1-30](#)
- wideband AM state SCPI command, [2-11](#)