

---

# Keysight 2-Port and 4-Port PNA-L Network Analyzer

N5239B 300 kHz to 8.5 GHz

N5231B 300 kHz to 13.5 GHz

N5232B 300 kHz to 20 GHz

## Documentation Warranty

THE MATERIAL CONTAINED IN THIS DOCUMENT IS PROVIDED "AS IS," AND IS SUBJECT TO BEING CHANGED, WITHOUT NOTICE, IN FUTURE EDITIONS. FURTHER, TO THE MAXIMUM EXTENT PERMITTED BY APPLICABLE LAW, KEYSIGHT DISCLAIMS ALL WARRANTIES, EITHER EXPRESS OR IMPLIED WITH REGARD TO THIS MANUAL AND ANY INFORMATION CONTAINED HEREIN, INCLUDING BUT NOT LIMITED TO THE IMPLIED WARRANTIES OF MERCHANTABILITY AND FITNESS FOR A PARTICULAR PURPOSE. KEYSIGHT SHALL NOT BE LIABLE FOR ERRORS OR FOR INCIDENTAL OR CONSEQUENTIAL DAMAGES IN CONNECTION WITH THE FURNISHING, USE, OR PERFORMANCE OF THIS DOCUMENT OR ANY INFORMATION CONTAINED HEREIN. SHOULD KEYSIGHT AND THE USER HAVE A SEPARATE WRITTEN AGREEMENT WITH WARRANTY TERMS COVERING THE MATERIAL IN THIS DOCUMENT THAT CONFLICT WITH THESE TERMS, THE WARRANTY TERMS IN THE SEPARATE AGREEMENT WILL CONTROL.

## U.S. Government Rights

U.S. Government Rights. The Software is "commercial computer software," as defined by Federal Acquisition Regulation ("FAR") 2.101. Pursuant to FAR 12.212 and 27.405-3 and Department of Defense FAR Supplement ("DFARS") 227.7202, the U.S. government acquires commercial computer software under the same terms by which the software is customarily provided to the public. Accordingly, Keysight provides the Software to U.S. government customers under its standard commercial license, which is embodied in its End User License Agreement (EULA), a copy of which can be found at <http://www.keysight.com/find/sweula>. The license set forth in the EULA represents the exclusive authority by which the U.S. government may use, modify, distribute, or disclose the Software. The EULA and the license set forth therein, does not require or permit, among other things, that Keysight: (1) Furnish technical information related to commercial computer software or commercial computer software documentation that is not customarily provided to the public; or (2) Relinquish to, or otherwise provide, the government rights in excess of these rights customarily provided to the public to use, modify, reproduce, release, perform, display, or disclose commercial computer software or commercial computer software documentation. No additional government requirements beyond those set forth in the EULA shall apply, except to the extent that those terms, rights, or licenses are explicitly required from all providers of commercial computer software pursuant to the FAR and the DFARS and are set forth specifically in writing elsewhere in the EULA. Keysight shall be under no obligation to update, revise or otherwise modify the Software. With respect to any technical data as defined by FAR 2.101, pursuant to FAR 12.211 and 27.404.2 and DFARS 227.7102, the U.S. government acquires no greater than Limited Rights as defined in FAR 27.401 or DFAR 227.7103-5 (c), as applicable in any technical data.

|   |           |
|---|-----------|
| U.S. Government Rights .....  | 2         |
| Definitions .....   | 6         |
| <b>Corrected System Performance .....</b>   | <b>7</b>  |
| System Dynamic Range and Receiver Dynamic Range.....  | 7         |
| Table 1a. System Dynamic Range (dB), All Models.....  | 8         |
| Table 1b. System Dynamic Range (dB), N5231B or N5232B.....  | 9         |
| Table 2. Receiver Dynamic Range (dB), N5239B, N5231B or N5232B - Typical.....   | 9         |
| <b>N5239B, N5231B and N5232B Corrected System Performance, All Options.....</b>   | <b>10</b> |
| Table 3. 85052B Calibration Kit .....   | 10        |
| Table 4. N4691B 2-Port Electronic Calibration Module .....  | 12        |
| Table 5. N4433A 4-Port Electronic Calibration Module .....  | 13        |
| <b>Uncorrected System Performance .....</b>   | <b>15</b> |
| Table 6a. Error Terms (dB), N5239B/31B/32B, All Ports, Option 200, 216 - Specifications .....   | 15        |
| Table 6b. Error Terms (dB), N5239B/31B/32B, All Ports, Option 200, 216 - Typical .....  | 16        |
| Table 6c. Error Terms (dB), N5231B, N5232B, All Ports, Option 400, 416 - Specifications .....   | 16        |
| Table 6d. Error Terms (dB), N5231B, N5232B, All Ports, Option 400, 416 - Typical .....  | 17        |
| <b>Test Port Output.....</b>  | <b>18</b> |
| Table 7. Frequency Information, All Options.....  | 18        |
| Table 8a. Maximum Levelled Power (dBm), All Models, All Ports <sup>1</sup> .....  | 18        |
| Table 8b. Maximum Levelled Power (dBm), N5231B or N5232B, All Ports <sup>1</sup> .....  | 18        |
| Table 9a. Power Level Accuracy (dB) at Nominal Power <sup>1</sup> , All Models,<br>Options 200 or 216, All Ports <sup>2</sup> .....       | 19        |
| Table 9b. Power Level Accuracy (dB) at Nominal Power <sup>1</sup> , N5231B or N5232B,<br>Options 400 or 416, All Ports <sup>2</sup> ..... | 19        |
| Table 10a. Power Level Linearity <sup>1</sup> (dB), All Models, Options 200 or 216, All Ports <sup>2</sup> -<br>Specification .....       | 20        |
| Table 10b. Power Level Linearity <sup>1</sup> (dB), N5231B, N5232B Option 400, 416, All Ports <sup>2</sup> -<br>Specification .....       | 20        |
| Table 11a. Power Sweep Range (dB), All Models, Option 200 or 216, All Ports <sup>1</sup> .....  | 20        |
| Table 11b. Power Sweep Range (dB), N5231B or N5232B, Option 400 or 416, All Ports <sup>1</sup> .....                                      | 21        |
| Table 12. Nominal Power (Preset, dBm), All Models, All Ports <sup>1</sup> .....   | 21        |
| Table 13. Power Resolution and Maximum/Minimum Settable Power, All Models, All Ports <sup>1</sup> ...                                     | 21        |
| Table 14. 2 <sup>nd</sup> and 3 <sup>rd</sup> Harmonics at Max Specified Power (dBc), All Ports <sup>1</sup> - Typical.....               | 22        |
| Table 15 Non-Harmonic Spurs at Nominal Power (dBc), All Models, All Options - Typical.....  | 22        |
| Table 16. Phase Noise (dBc/Hz), All Models, All Options - Typical.....  | 22        |

|   |           |
|---|-----------|
| <b>Test Port Input</b> .....  | <b>23</b> |
| Table 17. Test Port Noise Floor <sup>1</sup> (dBm) @ 10 Hz IFBW, All Models, All Ports .....                    | 23        |
| Table 18. Direct Receiver Access Input Noise Floor <sup>1</sup> (dBm), All Models, All Ports .....              | 23        |
| Table 19. 0.1 dB Receiver Compression at Test Port (dBm),<br>All Models, All Options, All Ports - Typical ..... | 24        |
| Table 20. Receiver Compression at Test Port Power, All Models, All Ports - Specification .....                  | 24        |
| Table 21a. Trace Noise <sup>1</sup> Magnitude (dB rms)/Phase (deg rms), All Models, Option 200 or 216           | 24        |
| Table 21b. Trace Noise <sup>1</sup> Magnitude (dB rms) / Phase (deg rms),<br>N5231B or N5232B, Option 400 ..... | 25        |
| Table 21c. Trace Noise <sup>1</sup> Magnitude (dB rms) / Phase (deg rms),<br>N5231B or N5232B, Option 416 ..... | 25        |
| Table 22. Reference Level Magnitude, All Models, All Options - Specification .....                              | 25        |
| Table 23a. Stability <sup>1</sup> , All Models, Options 200 or 216 - Typical .....                              | 25        |
| Table 23b. Stability <sup>1</sup> , N5231B, N5232B, Options 400, 416 - Typical .....                            | 26        |
| Table 24a. Damage Level, All Models - Specification .....   | 26        |
| Table 24b. Damage Level, All Models - Specification .....   | 26        |
| <b>Dynamic Accuracy</b> .....   | <b>27</b> |
| Table 25. Dynamic Accuracy - Specification .....  | 27        |
| Table 26. Group Delay <sup>1</sup> .....  | 29        |
| <b>General Information</b> .....  | <b>30</b> |
| Table 27. Miscellaneous Information .....   | 30        |
| Table 28. Front Panel Information, All Options .....  | 30        |
| Table 28. (Continued) Front Panel Information, All Options .....  | 31        |
| Table 29. Rear Panel Information, All Options .....   | 31        |
| Table 29. (Continued) Rear Panel Information, All Options .....   | 32        |
| Table 30. Analyzer Dimensions and Weight .....  | 33        |
| Regulatory and Environmental Information .....  | 33        |
| <b>Measurement Throughput Summary</b> .....   | <b>34</b> |
| Table 31a. Cycle Time (ms) for Measurement Completion, All Models, All Options - Typical ...                    | 34        |
| Table 31b. N5239B Cycle Time (ms) for Full-Span Measurement Completion - Typical .....                          | 34        |
| Table 31c. N5231B Cycle Time (ms) for Full-Span Measurement Completion- Typical .....                           | 35        |
| Table 31d. N5232B Cycle Time (ms) for Full-Span Measurement Completion- Typical .....                           | 35        |
| Table 32. Cycle Time vs. IF Bandwidth - Typical .....   | 36        |
| Table 33. Cycle Time vs. Number of Points - Typical .....   | 37        |
| Table 34. Data Transfer Times - Typical .....   | 38        |

|  |           |
|--|-----------|
| Specifications: Front-Panel Jumpers .....  | 39        |
| Table 35. Measurement Receiver Inputs (dBm) - Typical.....                             | 39        |
| Table 36. Reference Receiver Inputs and Reference Source Outputs (dBm) - Typical ..... | 39        |
| Table 37. Source Outputs (dBm) - Typical.....  | 40        |
| Table 38. Coupler Inputs (dB), All Options - Typical .....                             | 40        |
| <b>Test Set Block Diagrams.....</b>  | <b>41</b> |
| N5239B, N5231B and N5232B Option 200 (2-port base model).....                          | 41        |
| N5239B, N5231B and N5232B Option 216 .....   | 42        |
| N5231B and N5232B Option 400 (4-port base model).....                                  | 42        |
| N5231B and N5232B Option 416 .....   | 43        |
| Receiver Block Diagram .....   | 43        |

This is a complete list of the technical specifications for the N5239B, N5231B and N5232B PNA-L Series network analyzers with the following options:

## 2-Port, All Models

**Option 200** - 2-port base model with standard test set.

**Option 216** - To base model, adds front-panel jumpers, and source attenuators (extended power range).

## 4-Port N5231B or N5232B

**Option 400** - 4-port base model with standard test set.

**Option 416** - To base model, adds front-panel jumpers, and source attenuators (extended power range).

See block diagrams for all models and options beginning on page 41.

## Definitions

All specifications and characteristics apply over a 25 °C  $\pm$ 5 °C range (unless otherwise stated) and 90 minutes after the instrument has been turned on.

**Specification (spec.):** Warranted performance. Specifications include guardbands to account for the expected statistical performance distribution, measurement uncertainties, and changes in performance due to environmental conditions.

**Characteristic (char.):** A performance parameter that the product is expected to meet before it leaves the factory, but that is not verified in the field and is not covered by the product warranty. A characteristic includes the same guardbands as a specification.

**Typical (typ.):** Expected performance of an average unit which does not include guardbands. It is not covered by the product warranty. Typical values are produced by averaging the measured data across each frequency band.

**Nominal (nom.):** A general, descriptive term that does not imply a level of performance. It is not covered by the product warranty.

**Calibration:** The process of measuring known standards to characterize a network analyzer's systematic (repeatable) errors.

**Corrected (residual):** Indicates performance after error correction (calibration). It is determined by the quality of calibration standards and how well "known" they are, plus system repeatability, stability, and noise.

**Uncorrected (raw):** Indicates instrument performance without error correction. The uncorrected performance affects the stability of a calibration.

**Standard:** When referring to the analyzer, this includes no options unless noted otherwise.

## Notes:

This document provides technical specifications for the 85052B, N4691B and N4433A calibration kits.

Please download our free Uncertainty Calculator from [http://www.keysight.com/find/na\\_calculator](http://www.keysight.com/find/na_calculator) to generate the curves for your calibration kit and PNA setup.

## Corrected System Performance

The specifications in this section apply for measurements made with the N5231B and N5232B PNA network analyzers with the following conditions:

- 10 Hz IF bandwidth
- No averaging applied to data
- Isolation calibration with an averaging factor of 8

### System Dynamic Range and Receiver Dynamic Range

- **System Dynamic Range** is defined as the specified source maximum output power (spec) minus the noise floor (spec).
- **Extended Dynamic Range at Direct Access Input** is defined as the specified source maximum output power (spec) minus the direct receiver access input noise floor (spec).
- **Receiver Dynamic Range** is defined as the test port compression at 0.1 dB (typical) minus the noise floor (typical).

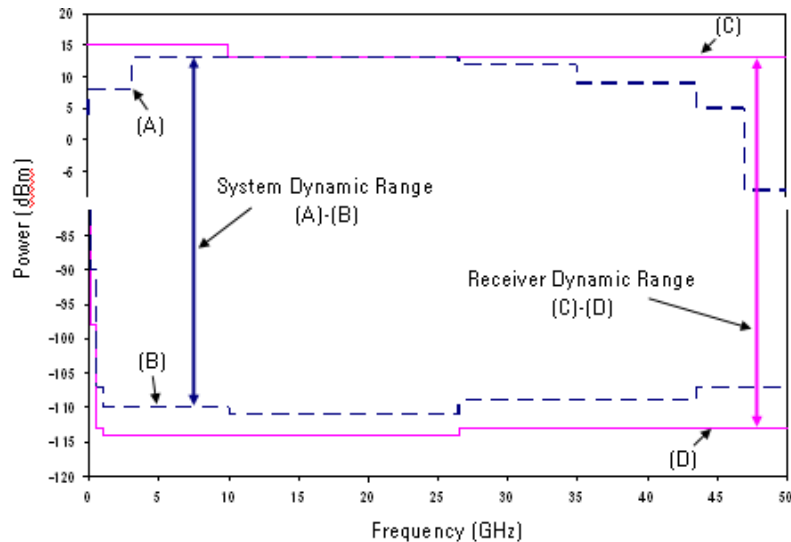

#### NOTE

The effective dynamic range must take measurement uncertainties and interfering signals into account.

The direct receiver access input extended dynamic range is calculated as the difference between the direct receiver access input noise floor and the source maximum output power. This set-up should only be used when the receiver input will never exceed its maximum receiver input. When the analyzer is in segment sweep mode, it can have predefined frequency segments which will output a higher power level when the extended dynamic range is required (i.e. devices with high insertion loss), and reduced power when the maximum receiver input level will occur (i.e. devices with low insertion loss). The extended range is only available in one-path transmission measurements.

It may typically be degraded at particular frequencies below 500 MHz due to spurious receiver residuals.

Table 1a. System Dynamic Range (dB), All Models

| Description           | Specification |            |                             | Typical    |            |                             |
|-----------------------|---------------|------------|-----------------------------|------------|------------|-----------------------------|
|                       | Option 200    | Option 216 |                             | Option 200 | Option 216 |                             |
|                       | Test Port     | Test Port  | Direct Receiver Access Port | Test Port  | Test Port  | Direct Receiver Access Port |
| 300 kHz to 3 MHz      | 105           | 104        | 117                         | 136        | 137        | 153                         |
| 3 MHz to 10 MHz       | 115           | 114        | 127                         | 138        | 139        | 155                         |
| 10 MHz to 500 MHz     | 131           | 129        | 142                         | 139        | 140        | 156                         |
| 500 MHz to 2 GHz      | 133           | 131        | 144                         | 141        | 140        | 156                         |
| 2 GHz to 6 GHz        | 133           | 131        | 144                         | 141        | 141        | 157                         |
| 6 GHz to 8.5 GHz      | 133           | 131        | 144                         | 140        | 139        | 155                         |
| 8.5 GHz to 10.5 GHz   | 128           | 126        | 139                         | 139        | 137        | 153                         |
| 10.5 GHz to 12.5 GHz  | 127           | 125        | 138                         | 139        | 137        | 153                         |
| 12.5 GHz to 13.51 GHz | 125           | 122        | 135                         | 138        | 136        | 152                         |
| 13.51 GHz to 15 GHz   | 115           | 112        | 125                         | 129        | 127        | 143                         |
| 15 GHz to 20 GHz      | 114           | 111        | 124                         | 129        | 127        | 143                         |



Table 1b. System Dynamic Range (dB), N5231B or N5232B

| Description           | Specification |            |                             | Typical    |            |                             |
|-----------------------|---------------|------------|-----------------------------|------------|------------|-----------------------------|
|                       | Option 400    | Option 416 |                             | Option 400 | Option 416 |                             |
|                       | Test Port     | Test Port  | Direct Receiver Access Port | Test Port  | Test Port  | Direct Receiver Access Port |
| 300 kHz to 3 MHz      | 102           | 101        | 114                         | 135        | 134        | 150                         |
| 3 MHz to 10 MHz       | 112           | 111        | 124                         | 138        | 137        | 153                         |
| 10 MHz to 500 MHz     | 128           | 128        | 141                         | 138        | 137        | 153                         |
| 500 MHz to 4 GHz      | 128           | 128        | 141                         | 139        | 138        | 154                         |
| 4 GHz to 6 GHz        | 127           | 126        | 139                         | 138        | 137        | 153                         |
| 6 GHz to 8.5 GHz      | 124           | 122        | 135                         | 137        | 135        | 151                         |
| 8.5 GHz to 10.5 GHz   | 122           | 120        | 133                         | 136        | 134        | 150                         |
| 10.5 GHz to 12.5 GHz  | 118           | 116        | 129                         | 133        | 130        | 146                         |
| 12.5 GHz to 13.51 GHz | 118           | 106        | 119                         | 133        | 121        | 137                         |
| 13.51 GHz to 15 GHz   | 108           | 101        | 114                         | 124        | 118        | 134                         |
| 15 GHz to 20 GHz      | 105           | 101        | 114                         | 121        | 134        | 150                         |

Table 2. Receiver Dynamic Range (dB), N5239B, N5231B or N5232B - Typical

| Description          | Options 200, 216 | Options 400, 416 |
|----------------------|------------------|------------------|
| 300 kHz to 3 MHz     | 125              | 125              |
| 3 MHz to 10 MHz      | 127              | 128              |
| 10 MHz to 500 MHz    | 132              | 133              |
| 500 MHz to 2 GHz     | 133              | 135              |
| 2 GHz to 4 GHz       | 134              | 135              |
| 4 GHz to 8.5 GHz     | 134              | 136              |
| 8.5 GHz to 10.5 GHz  | 134              | 135              |
| 10.5 GHz to 13.5 GHz | 134              | 134              |
| 13.51 GHz to 15 GHz  | 125              | 125              |
| 15 GHz to 20 GHz     | 124              | 124              |

## N5239B, N5231B and N5232B Corrected System Performance, All Options

For any  $S_{ii}$  reflection measurement:

- $S_{jj} = 0$ .

For any  $S_{ij}$  transmission measurement:

- $S_{ji} = S_{ij}$  when  $S_{ij} \leq 1$
- $S_{ji} = 1/S_{ij}$  when  $S_{ij} > 1$
- $S_{kk} = 0$  for all  $k$

Applies to the N5239B/1A/2A Option 200, 216, 400, 416 analyzers, 85131F flexible test port cable set, and a full 2-port calibration. Also applies to the following condition:

Environmental temperature  $23^\circ \pm 3^\circ \text{C}$ , with  $< 1^\circ \text{C}$  deviation from calibration temperature

Table 3. 85052B Calibration Kit

| Description                        | Specification (dB) |                   |                  |                  |                     |                    |
|------------------------------------|--------------------|-------------------|------------------|------------------|---------------------|--------------------|
|                                    | 300 kHz to 50 MHz  | 50 MHz to 500 MHz | 500 MHz to 2 GHz | 2 GHz to 8.5 GHz | 8.5 GHz to 13.5 GHz | 13.5 GHz to 20 GHz |
| Directivity                        | 48                 | 48                | 48               | 44               | 44                  | 44                 |
| Source Match                       | 40                 | 40                | 40               | 31               | 31                  | 31                 |
| Load Match                         | 48                 | 48                | 48               | 44               | 44                  | 44                 |
| Reflection Tracking <sup>1</sup>   |                    |                   |                  |                  |                     |                    |
| Mag                                | $\pm 0.003$        | $\pm 0.003$       | $\pm 0.003$      | $\pm 0.006$      | $\pm 0.006$         | $\pm 0.006$        |
| Phase ( $^\circ/\text{C}$ )        | $\pm 0.020$        | $\pm 0.020$       | $\pm 0.020$      | $\pm 0.040$      | $\pm 0.040$         | $\pm 0.040$        |
| Transmission Tracking <sup>1</sup> |                    |                   |                  |                  |                     |                    |
| Mag                                | $\pm 0.067$        | $\pm 0.017$       | $\pm 0.017$      | $\pm 0.078$      | $\pm 0.134$         | $\pm 0.131$        |
| Phase ( $^\circ/\text{C}$ )        | $\pm 0.441$        | $\pm 0.115$       | $\pm 0.115$      | $\pm 0.518$      | $\pm 0.884$         | $\pm 0.866$        |

<sup>1</sup> Temperature deviation is a characteristic value.

## Transmission Uncertainty, All Options

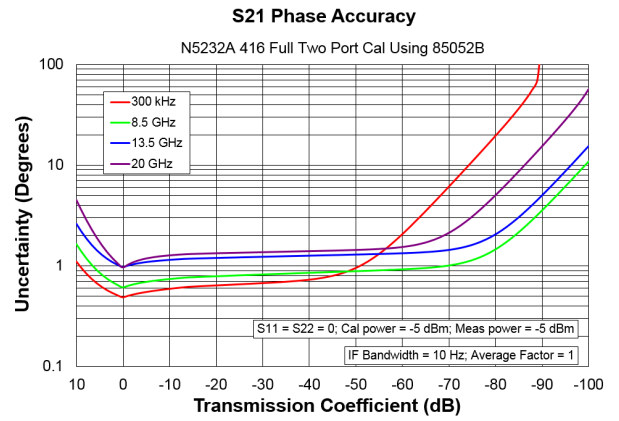
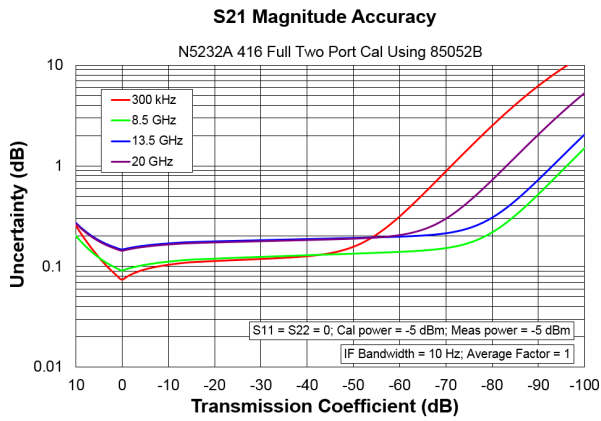

## Reflection Uncertainty, All Options

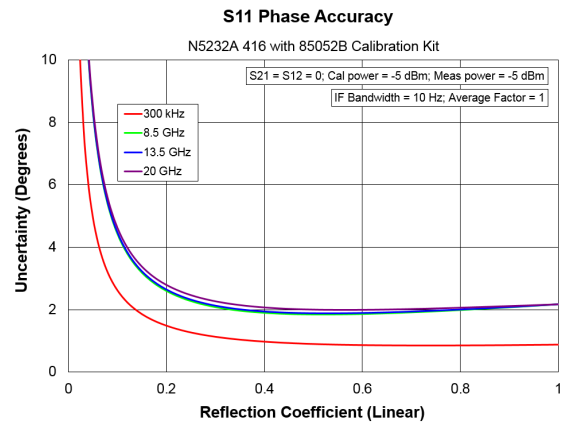
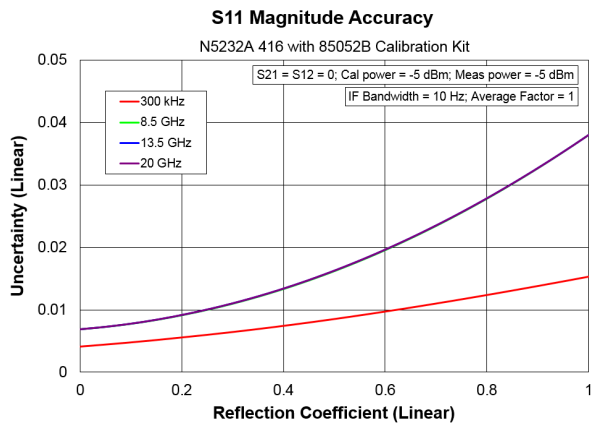
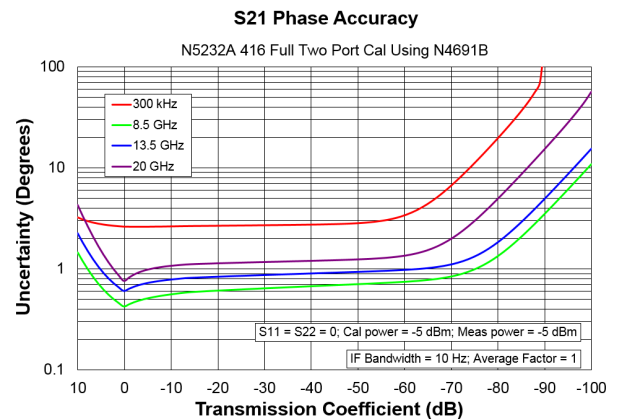
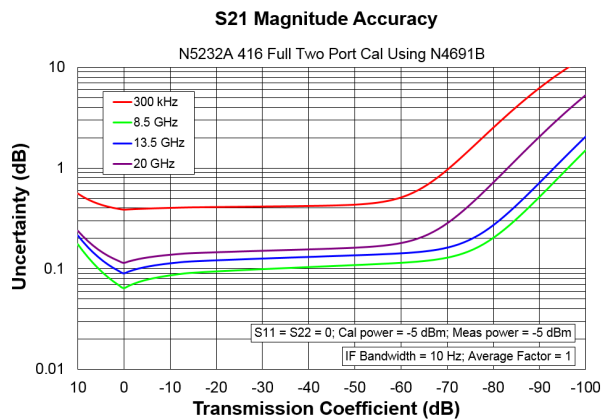

Table 4. N4691B 2-Port Electronic Calibration Module

| Description                        | Specification (dB) |                   |                  |                  |                     |                    |
|------------------------------------|--------------------|-------------------|------------------|------------------|---------------------|--------------------|
|                                    | 300 kHz to 50 MHz  | 50 MHz to 500 MHz | 500 MHz to 2 GHz | 2 GHz to 8.5 GHz | 8.5 GHz to 13.5 GHz | 13.5 GHz to 20 GHz |
| Directivity                        | 31                 | 46                | 52               | 48               | 46                  | 46                 |
| Source Match                       | 29                 | 41                | 47               | 45               | 42                  | 42                 |
| Load Match                         | 27                 | 42                | 47               | 42               | 40                  | 39                 |
| Reflection Tracking <sup>1</sup>   |                    |                   |                  |                  |                     |                    |
| Mag                                | ±0.110             | ±0.050            | ±0.020           | ±0.030           | ±0.040              | ±0.040             |
| Phase (°/°C)                       | ±0.726             | ±0.330            | ±0.132           | ±0.198           | ±0.264              | ±0.264             |
| Transmission Tracking <sup>1</sup> |                    |                   |                  |                  |                     |                    |
| Mag                                | ±0.368             | ±0.036            | ±0.026           | ±0.052           | ±0.078              | ±0.102             |
| Phase (°/°C)                       | ±2.430             | ±0.235            | ±0.174           | ±0.343           | ±0.516              | ±0.674             |

<sup>1</sup> Temperature deviation is a characteristic value.

### Transmission Uncertainty, All Options



## Reflection Uncertainty, All Options

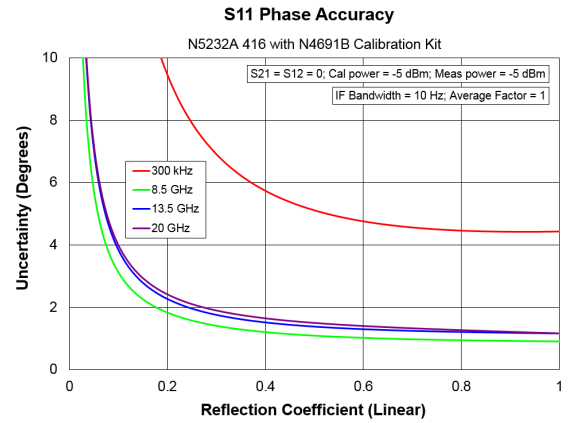
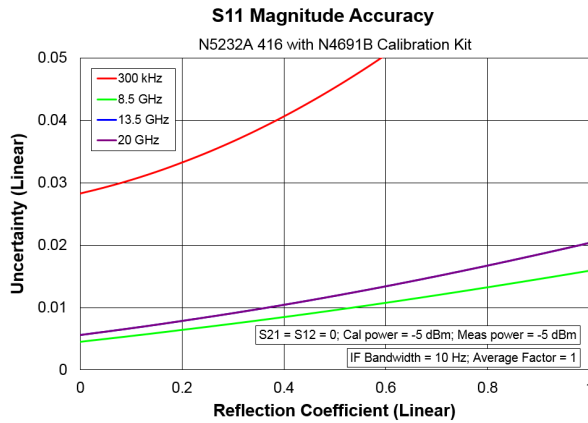

Table 5. N4433A 4-Port Electronic Calibration Module

**NOTE** Uncertainty curves for the N4433A are created using a 2-port calibration. Multiport uncertainties are not supported at this time.

| Description                        | Specification (dB) |                   |                  |                  |                     |                    |
|------------------------------------|--------------------|-------------------|------------------|------------------|---------------------|--------------------|
|                                    | 300 kHz to 50 MHz  | 50 MHz to 500 MHz | 500 MHz to 2 GHz | 2 GHz to 8.5 GHz | 8.5 GHz to 13.5 GHz | 13.5 GHz to 20 GHz |
| Directivity                        | 45                 | 50                | 50               | 47               | 45                  | 40                 |
| Source Match                       | 36                 | 42                | 42               | 39               | 37                  | 31                 |
| Load Match                         | 36                 | 43                | 43               | 40               | 38                  | 33                 |
| Reflection Tracking <sup>1</sup>   |                    |                   |                  |                  |                     |                    |
| Mag                                | ±0.100             | ±0.060            | ±0.060           | ±0.090           | ±0.100              | ±0.180             |
| Phase (°/°C)                       | ±0.660             | ±0.396            | ±0.396           | ±0.594           | ±0.660              | ±1.188             |
| Transmission Tracking <sup>1</sup> |                    |                   |                  |                  |                     |                    |
| Mag                                | ±0.176             | ±0.039            | ±0.042           | ±0.078           | ±0.118              | ±0.221             |
| Phase (°/°C)                       | ±1.161             | ±0.260            | ±0.275           | ±0.513           | ±0.776              | ±1.458             |

<sup>1</sup> Temperature deviation is a characteristic value.

## Transmission Uncertainty, All Options

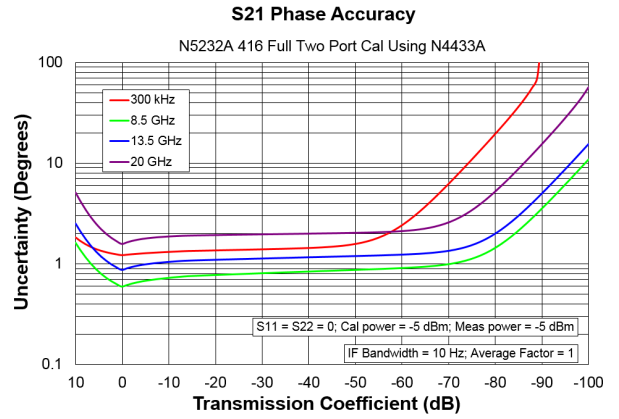
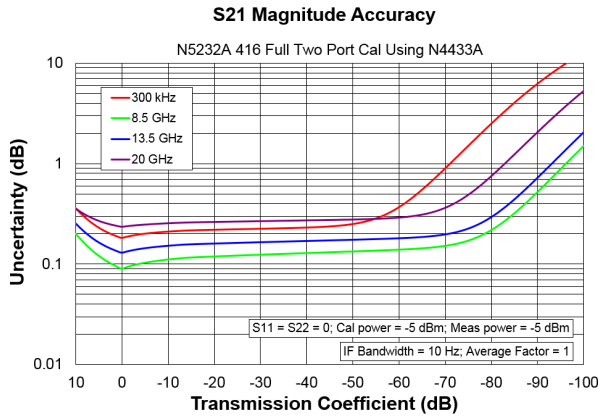

## Reflection Uncertainty, All Options

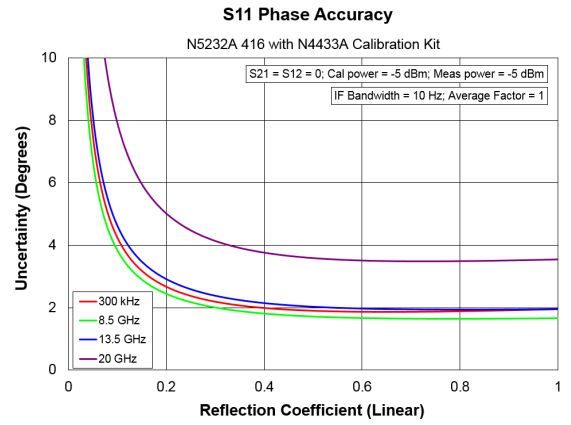
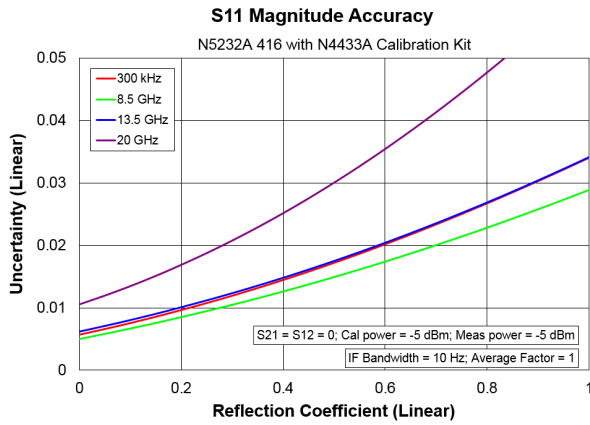

## Uncorrected System Performance

Specifications apply to following conditions:

- Cable loss not included in Transmission Tracking.
- Crosstalk measurement conditions: normalized to a thru, measured with shorts on all ports, 10 Hz IF bandwidth, averaging factor of 8, alternate mode, source power set to the specified maximum power.

Table 6a. Error Terms (dB), N5239B/31B/32B, All Ports, Option 200, 216 - Specifications

| Description         | Directivity | Source Match | Load Match | Transmission Tracking | Reflection Tracking | Crosstalk |
|---------------------|-------------|--------------|------------|-----------------------|---------------------|-----------|
| 300 kHz to 1 MHz    | 12          | 6            | 6          | --                    | --                  | --        |
| 1 MHz to 45 MHz     | 12          | 9            | 9          | --                    | --                  | --        |
| 45 MHz to 500 MHz   | 24          | 17           | 22         | --                    | --                  | --        |
| 500 MHz to 2 GHz    | 27          | 15           | 16         | --                    | --                  | --        |
| 2 GHz to 8.5 GHz    | 19          | 10           | 10         | --                    | --                  | --        |
| 8.5 GHz to 12.5 GHz | 15          | 8            | 8          | --                    | --                  | --        |
| 12.5 GHz to 20 GHz  | 15          | 8            | 9          | --                    | --                  | --        |

Table 6b. Error Terms (dB), N5239B/31B/32B, All Ports, Option 200, 216 - Typical

| Description          | Directivity | Source Match | Load Match | Transmission Tracking | Reflection Tracking | Crosstalk |
|----------------------|-------------|--------------|------------|-----------------------|---------------------|-----------|
| 300 kHz to 1 MHz     | 16          | 8            | 8          | +/-2.0                | +/-1.5              | -80       |
| 1 MHz to 5 MHz       | 16          | 17           | 17         | +/-2.0                | +/-1.5              | -85       |
| 5 MHz to 45 MHz      | 16          | 17           | 17         | +/-2.0                | +/-1.5              | -95       |
| 45 MHz to 500 MHz    | 35          | 21           | 28         | +/-2.0                | +/-1.5              | -110      |
| 500 MHz to 2 GHz     | 35          | 19           | 22         | +/-2.0                | +/-1.5              | -122      |
| 2 GHz to 8.5 GHz     | 23          | 17           | 17         | +/-2.0                | +/-1.5              | -122      |
| 8.5 GHz to 10.5 GHz  | 20          | 12           | 12         | +/-2.0                | +/-1.5              | -122      |
| 10.5 GHz to 12.5 GHz | 20          | 12           | 12         | +/-2.0                | +/-1.5              | -115      |
| 12.5 GHz to 13.5GHz  | 20          | 12           | 14         | +/-2.5                | +/-2.0              | -115      |
| 13.5 GHz to 20 GHz   | 20          | 12           | 14         | +/-2.5                | +/-2.0              | -108      |

Table 6c. Error Terms (dB), N5231B, N5232B, All Ports, Option 400, 416 - Specifications

| Description         | Directivity | Source Match | Load Match | Transmission Tracking | Reflection Tracking | Crosstalk |
|---------------------|-------------|--------------|------------|-----------------------|---------------------|-----------|
| 300 kHz to 1 MHz    | 10          | 6            | 5          | --                    | --                  | --        |
| 1 MHz to 10 MHz     | 10          | 9            | 14         | --                    | --                  | --        |
| 10 MHz to 1 GHz     | 28          | 12           | 20         | --                    | --                  | --        |
| 1 GHz to 3 GHz      | 25          | 10           | 18         | --                    | --                  | --        |
| 3 GHz to 5 GHz      | 20          | 10           | 14         | --                    | --                  | --        |
| 5 GHz to 8.5 GHz    | 17          | 10           | 12         | --                    | --                  | --        |
| 8.5 GHz to 11.5 GHz | 15          | 10           | 12         | --                    | --                  | --        |
| 11.5 GHz to 16 GHz  | 15          | 7            | 7          | --                    | --                  | --        |
| 16 GHz to 20 GHz    | 15          | 8            | 7          | --                    | --                  | --        |



Table 6d. Error Terms (dB), N5231B, N5232B, All Ports, Option 400, 416 - Typical

| Description          | Directivity | Source Match | Load Match | Transmission Tracking | Reflection Tracking | Crosstalk |
|----------------------|-------------|--------------|------------|-----------------------|---------------------|-----------|
| 300 kHz to 1 MHz     | 16          | 8            | 8          | +/-2.0                | +/-1.5              | -80       |
| 1 MHz to 5 MHz       | 16          | 17           | 17         | +/-2.0                | +/-1.5              | -85       |
| 5 MHz to 10 MHz      | 16          | 17           | 17         | +/-2.0                | +/-1.5              | -95       |
| 10 MHz to 45 MHz     | 35          | 24           | 30         | +/-2.0                | +/-1.5              | -95       |
| 45 MHz to 500 MHz    | 35          | 24           | 30         | +/-2.0                | +/-1.5              | -110      |
| 500 MHz to 1 GHz     | 35          | 24           | 30         | +/-2.0                | +/-1.5              | -122      |
| 1 GHz to 3 GHz       | 31          | 24           | 25         | +/-2.0                | +/-1.5              | -122      |
| 3 GHz to 5 GHz       | 25          | 19           | 21         | +/-2.0                | +/-1.5              | -122      |
| 5 GHz to 8.5 GHz     | 19          | 16           | 16         | +/-2.0                | +/-1.5              | -122      |
| 8.5 GHz to 10.5 GHz  | 18          | 16           | 16         | +/-2.0                | +/-1.5              | -122      |
| 10.5 GHz to 11.5 GHz | 18          | 16           | 19         | +/-2.0                | +/-1.5              | -115      |
| 11.5 GHz to 12.5 GHz | 18          | 13           | 13         | +/-2.0                | +/-1.5              | -115      |
| 12.5 GHz to 13.5 GHz | 18          | 13           | 13         | +/-2.5                | +/-2.0              | -115      |
| 13.5 GHz to 16 GHz   | 18          | 13           | 13         | +/-2.5                | +/-2.0              | -108      |
| 16 GHz to 20 GHz     | 18          | 13           | 15         | +/-2.5                | +/-2.0              | -108      |

## Test Port Output

Table 7. Frequency Information, All Options

| Description            | Specification       |            | Typical   |            |
|------------------------|---------------------|------------|---|------------|
|                        | Option 200          | Option 216 | Option 200  | Option 216 |
| N5239B Frequency Range | 300 kHz to 8.5 GHz  |            | --  |            |
| N5231B Frequency Range | 300 kHz to 13.5 GHz |            | --  |            |
| N5232B Frequency Range | 300 kHz to 20 GHz   |            | --  |            |
| Frequency Resolution   | 1 Hz                |            | --  |            |
| Frequency Accuracy     | +/- 1 ppm           |            | --  |            |
| Frequency Stability    | --                  |            | +/-0.05 ppm, -10° to 70° C <sup>1</sup><br>+/-0.1 ppm/yr maximum <sup>2</sup> |            |

<sup>1</sup> Assumes no variation in time.

<sup>2</sup> Assumes no variation in temperature.

Table 8a. Maximum Levelled Power (dBm), All Models, All Ports<sup>1</sup>

| Description         | Specification |            | Typical    |            |
|---------------------|---------------|------------|------------|------------|
|                     | Option 200    | Option 216 | Option 200 | Option 216 |
| 300 kHz to 10 MHz   | 10            | 9          | 16         | 16         |
| 10 MHz to 500 MHz   | 13            | 11         | 16         | 16         |
| 500 MHz to 6 GHz    | 13            | 11         | 17         | 17         |
| 6 GHz to 8.5 GHz    | 13            | 11         | 16         | 15         |
| 8.5 GHz to 12.5 GHz | 10            | 8          | 15         | 13         |
| 12.5 GHz to 20 GHz  | 8             | 5          | 14         | 12         |

<sup>1</sup> Any port can be used as the source port.

Table 8b. Maximum Levelled Power (dBm), N5231B or N5232B, All Ports<sup>1</sup>

| Description        | Specification |            | Typical    |            |
|--------------------|---------------|------------|------------|------------|
|                    | Option 400    | Option 416 | Option 400 | Option 416 |
| 300 kHz to 10 MHz  | 7             | 6          | 15         | 14         |
| 10 MHz to 4 GHz    | 8             | 8          | 14         | 13         |
| 4 GHz to 6 GHz     | 7             | 6          | 12         | 11         |
| 6 GHz to 10.5 GHz  | 4             | 2          | 11         | 9          |
| 10.5 GHz to 15 GHz | 1             | -1         | 9          | 6          |
| 15 GHz to 20 GHz   | -2            | -6         | 6          | 3          |

<sup>1</sup> Any port can be used as the source port.

Table 9a. Power Level Accuracy (dB) at Nominal Power<sup>1</sup>, All Models, Options 200 or 216, All Ports<sup>2</sup>

| Description         | Specification | Typical  |
|---------------------|---------------|----------|
| 300 kHz to 10 MHz   | +/- 1.8       | +/- 0.09 |
| 10 MHz to 45 MHz    | +/- 1.5       | +/- 0.06 |
| 45 MHz to 500 MHz   | +/- 1.0       | +/- 0.07 |
| 500 MHz to 2 GHz    | +/- 1.0       | +/- 0.08 |
| 2 GHz to 8.5 GHz    | +/- 1.0       | +/- 0.09 |
| 8.5 GHz to 13.5 GHz | +/- 1.5       | +/- 0.14 |
| 13.5 GHz to 16 GHz  | +/- 1.5       | +/- 0.18 |
| 16 GHz to 20 GHz    | +/- 1.5       | +/- 0.14 |

<sup>1</sup> Level accuracy at power other than nominal power, Power Level Accuracy (dB) at Nominal Power + Power Level Linearity (dB)

<sup>2</sup> Any port can be used as the source port.

Table 9b. Power Level Accuracy (dB) at Nominal Power<sup>1</sup>, N5231B or N5232B, Options 400 or 416, All Ports<sup>2</sup>

| Description          | Specification | Typical  |
|----------------------|---------------|----------|
| 300 kHz to 10 MHz    | +/- 1.5       | +/- 0.07 |
| 10 MHz to 45 MHz     | +/- 1.0       | +/- 0.12 |
| 45 MHz to 500 MHz    | +/- 1.0       | +/- 0.18 |
| 500 MHz to 2 GHz     | +/- 1.0       | +/- 0.10 |
| 2 GHz to 8.5 GHz     | +/- 1.25      | +/- 0.27 |
| 8.5 GHz to 10.5 GHz  | +/- 1.5       | +/- 0.21 |
| 10.5 GHz to 12.5 GHz | +/- 2.0       | +/- 0.43 |
| 12.5 GHz to 16 GHz   | +/- 2.5       | +/- 0.65 |
| 16 GHz to 20 GHz     | +/- 2.8       | +/- 0.72 |

<sup>1</sup> Level accuracy at power other than nominal power, Power Level Accuracy (dB) at Nominal Power + Power Level Linearity (dB)

<sup>2</sup> Any port can be used as the source port.

Table 10a. Power Level Linearity<sup>1</sup> (dB), All Models, Options 200 or 216, All Ports<sup>2</sup> – Specification

| Description       | -25 dBm ≤ P < -20 dBm | -20 dBm ≤ P < -15 dBm | P ≥ -15 dBm |
|-------------------|-----------------------|-----------------------|-------------|
| 300 kHz to 10 MHz | +/-2.0                | +/-1.5                | +/-1.5      |
| 10 MHz to 20 GHz  | +/-1.5                | +/-1.5                | +/-1.5      |

<sup>1</sup> Referenced to nominal power.

<sup>2</sup> Any port can be used as the source port.

Table 10b. Power Level Linearity<sup>1</sup> (dB), N5231B, N5232B Option 400, 416, All Ports<sup>2</sup> – Specification

| Description       | -25 dBm ≤ P < -20 dBm | -20 dBm ≤ P < -15 dBm | P ≥ -15 dBm |
|-------------------|-----------------------|-----------------------|-------------|
| 300 kHz to 10 MHz | +/-2.5                | +/-1.5                | +/-1.5      |
| 10 MHz to 20 GHz  | +/-1.5                | +/-1.5                | +/-1.5      |

<sup>1</sup> Referenced to nominal power.

<sup>2</sup> Any port can be used as the source port.

Table 11a. Power Sweep Range (dB), All Models, Option 200 or 216, All Ports<sup>1</sup>

| Description         | Specification |            | Typical    |            |
|---------------------|---------------|------------|------------|------------|
|                     | Option 200    | Option 216 | Option 200 | Option 216 |
| 300 kHz to 10 MHz   | 35            | 34         | 43         | 43         |
| 10 MHz to 50 MHz    | 38            | 36         | 43         | 43         |
| 50 MHz to 6 GHz     | 38            | 36         | 44         | 44         |
| 6 GHz to 8.5 GHz    | 38            | 36         | 43         | 42         |
| 8.5 GHz to 12.5 GHz | 35            | 33         | 42         | 40         |
| 12.5 GHz to 20 GHz  | 33            | 30         | 41         | 39         |

<sup>1</sup> Any port can be used as the source port.

Table 11b. Power Sweep Range (dB), N5231B or N5232B, Option 400 or 416, All Ports<sup>1</sup>

| Description        | Specification |            | Typical    |            |
|--------------------|---------------|------------|------------|------------|
|                    | Option 400    | Option 416 | Option 400 | Option 416 |
| 300 kHz to 10 MHz  | 32            | 31         | 42         | 41         |
| 10 MHz to 4 GHz    | 33            | 33         | 41         | 40         |
| 4 GHz to 6 GHz     | 32            | 31         | 39         | 38         |
| 6 GHz to 10.5 GHz  | 29            | 27         | 38         | 36         |
| 10.5 GHz to 15 GHz | 26            | 24         | 36         | 33         |
| 15 GHz to 20 GHz   | 23            | 19         | 33         | 30         |

<sup>1</sup> Any port can be used as the source port.

Table 12. Nominal Power (Preset, dBm), All Models, All Ports<sup>1</sup>

| Description  | Options 200, 216 | Option 400 | Option 416 |
|--------------|------------------|------------|------------|
| Preset Power | 0                | -5         | -8         |

<sup>1</sup> Any port can be used as the source port.

Table 13. Power Resolution and Maximum/Minimum Settable Power, All Models, All Ports<sup>1</sup>

| Description            | Specification (dB) | Typical (dBm) |                  |                  |
|------------------------|--------------------|---------------|------------------|------------------|
|                        | All Options        | All Options   | Options 200, 400 | Options 216, 416 |
| Power Resolution       | 0.01               | --            | --               | --               |
| Maximum Settable Power |                    | 30            | --               | --               |
| Minimum Settable Power | --                 | --            | -30              | -90              |

<sup>1</sup> Any port can be used as the source port.

Table 14. 2<sup>nd</sup> and 3<sup>rd</sup> Harmonics at Max Specified Power (dBc), All Ports<sup>1</sup> - Typical

| Description <sup>2</sup> | N5239B           | N5231B           |                  | N5232B           |                  |
|--------------------------|------------------|------------------|------------------|------------------|------------------|
|                          | Options 200, 216 | Options 200, 216 | Options 400, 416 | Options 200, 216 | Options 400, 416 |
| 600 kHz to 500 MHz       | -15              | -15              | -18              | -15              | -18              |
| 500 MHz to 1 GHz         | -17              | -17              | -18              | -17              | -18              |
| 1 GHz to 3 GHz           | -17              | -17              | -17              | -17              | -17              |
| 3 GHz to 4 GHz           | -17              | -17              | -25              | -17              | -25              |
| 4 GHz to 8.5 GHz         | -18              | -18              | -25              | -18              | -25              |
| 8.5 GHz to 13.5 GHz      | --               | -18              | -25              | -18              | -25              |
| 13.5 GHz to 20 GHz       | --               | --               | --               | -18              | -22              |

<sup>1</sup> Any port can be used as the source port.

<sup>2</sup> Listed frequency is harmonic frequency; test at max specified power

Table 15 Non-Harmonic Spurs at Nominal Power (dBc), All Models, All Options - Typical

| Description        | Based on 8 kHz offset Frac-N | Based on 100 kHz offset Frac-N |
|--------------------|------------------------------|--------------------------------|
| 300 kHz to 500 MHz | -50                          | -50                            |
| 500 MHz to 2 GHz   | -60                          | -42                            |
| 2 GHz to 4 GHz     | -57                          | -45                            |
| 4 GHz to 8 GHz     | -51                          | -39                            |
| 8 GHz to 16 GHz    | -45                          | -33                            |
| 16 GHz to 20 GHz   | -39                          | -27                            |

Table 16. Phase Noise (dBc/Hz), All Models, All Options - Typical

| Description       | 1 kHz Offset | 10 kHz Offset | 100 kHz Offset | 1 MHz Offset |
|-------------------|--------------|---------------|----------------|--------------|
| 300 kHz to 50 MHz | -95          | -101          | -101           | -117         |
| 50 MHz to 1 GHz   | -96          | -101          | -101           | -119         |
| 1 GHz to 2 GHz    | -91          | -105          | -102           | -121         |
| 2 GHz to 4 GHz    | -85          | -99           | -96            | -115         |
| 4 GHz to 8 GHz    | -79          | -93           | -90            | -109         |
| 8 GHz to 16 GHz   | -73          | -87           | -84            | -103         |
| 16 GHz to 20 GHz  | -67          | -81           | -78            | -97          |

## Test Port Input

Table 17. Test Port Noise Floor<sup>1</sup> (dBm) @ 10 Hz IFBW, All Models, All Ports

| Description                    | Specification    |                  | Typical          |                  |
|--------------------------------|------------------|------------------|------------------|------------------|
|                                | Options 200, 216 | Options 400, 416 | Options 200, 216 | Options 400, 416 |
| 300 kHz to 3 MHz <sup>2</sup>  | -95              | -95              | -120             | -120             |
| 3 MHz to 10 MHz <sup>2</sup>   | -105             | -105             | -122             | -123             |
| 10 MHz to 500 MHz <sup>2</sup> | -118             | -120             | -123             | -124             |
| 500 MHz to 2 GHz               | -120             | -120             | -123             | -125             |
| 2 GHz to 4 GHz                 | -120             | -120             | -124             | -125             |
| 4 GHz to 8.5 GHz               | -120             | -120             | -124             | -126             |
| 8.5 GHz to 10.5 GHz            | -118             | -118             | -124             | -125             |
| 10.5 GHz to 13.51 GHz          | -117             | -117             | -124             | -124             |
| 13.51 GHz to 15 GHz            | -107             | -107             | -115             | -115             |
| 15 GHz to 20 GHz               | -106             | -107             | -115             | -115             |

<sup>1</sup> Total average (rms) noise power calculated as the mean value of a linear magnitude trace expressed in dBm.

<sup>2</sup> May typically be degraded at particular frequencies below 500 MHz due to spurious receiver residuals.

Table 18. Direct Receiver Access Input Noise Floor<sup>1</sup> (dBm), All Models, All Ports

| Description                    | Specification |            | Typical    |            |
|--------------------------------|---------------|------------|------------|------------|
|                                | Option 216    | Option 416 | Option 216 | Option 416 |
| 300 kHz to 3 MHz <sup>2</sup>  | -108          | -108       | -136       | -136       |
| 3 MHz to 10 MHz <sup>2</sup>   | -118          | -118       | -138       | -139       |
| 10 MHz to 500 MHz <sup>2</sup> | -131          | -133       | -139       | -140       |
| 500 MHz to 2 GHz               | -133          | -133       | -139       | -141       |
| 2 GHz to 4 GHz                 | -132          | -132       | -140       | -141       |
| 4 GHz to 8.5 GHz               | -131          | -131       | -140       | -142       |
| 8.5 GHz to 10.5 GHz            | -131          | -131       | -140       | -141       |
| 10.5 GHz to 13.51 GHz          | -130          | -130       | -140       | -140       |
| 13.51 GHz to 15 GHz            | -120          | -120       | -131       | -131       |
| 15 GHz to 20 GHz               | -119          | -120       | -131       | -131       |

<sup>1</sup> Total average (rms) noise power calculated as the mean value of a linear magnitude trace expressed in dBm.

<sup>2</sup> May typically be degraded at particular frequencies below 500 MHz due to spurious receiver residuals.

Table 19. 0.1 dB Receiver Compression at Test Port (dBm), All Models, All Options, All Ports - Typical

| Description       | Typical |
|-------------------|---------|
| 300 kHz to 10 MHz | 5       |
| 10 MHz to 500MHz  | 9       |
| 500 MHz to 15GHz  | 10      |
| 15 GHz to 20 GHz  | 9       |

Table 20. Receiver Compression at Test Port Power, All Models, All Ports - Specification

| Description        | Test Port Power (dBm) | Options 200, 216 |                 | Options 400, 416 |                 |
|--------------------|-----------------------|------------------|-----------------|------------------|-----------------|
|                    |                       | Magnitude (dB)   | Phase (degrees) | Magnitude (dB)   | Phase (degrees) |
| 300 kHz to 10 MHz  | 8 <sup>1</sup>        | 0.4              | 1.5             | 0.4              | 1.5             |
| 10 MHz to 50 MHz   | 8                     | 0.15             | 1.0             | 0.15             | 1.0             |
| 50 MHz to 2 GHz    | 8                     | 0.25             | 2.0             | 0.25             | 2.0             |
| 2 GHz to 8.5 GHz   | 8                     | 0.25             | 2.5             | 0.25             | 2.5             |
| 8.5 GHz to 10 GHz  | 8                     | 0.25             | 3.0             | 0.25             | 3.0             |
| 10 GHz to 13.5 GHz | 8                     | 0.25             | 4.5             | 0.28             | 4.0             |
| 13.5 GHz to 16 GHz | 8                     | 0.25             | 6.5             | 0.28             | 6.0             |
| 16 GHz to 20 GHz   | 8                     | 0.35             | 11.0            | 0.28             | 9.0             |

<sup>1</sup> 6 dBm with Option 400 or 416.

Table 21a. Trace Noise<sup>1</sup> Magnitude (dB rms)/Phase (deg rms), All Models, Option 200 or 216

| Description          | Specification | Typical       |               |               |
|----------------------|---------------|---------------|---------------|---------------|
|                      |               | 1 kHz IFBW    | 100 kHz IFBW  | 600 kHz IFBW  |
| 300 kHz to 10 MHz    | 0.004 / 0.060 | 0.001 / 0.001 | 0.015 / 0.350 | 0.040 / 0.300 |
| 10 MHz to 45 MHz     | 0.004 / 0.060 | 0.004 / 0.024 | 0.006 / 0.350 | 0.105 / 0.670 |
| 45 MHz to 500 MHz    | 0.004 / 0.060 | 0.004 / 0.024 | 0.006 / 0.060 | 0.105 / 0.670 |
| 500 MHz to 13.51 GHz | 0.004 / 0.060 | 0.001 / 0.005 | 0.006 / 0.060 | 0.015 / 0.090 |
| 13.51 GHz to 20 GHz  | 0.006 / 0.060 | 0.001 / 0.005 | 0.010 / 0.080 | 0.020 / 0.120 |

<sup>1</sup> Ratioed measurement, nominal power at test port.



Table 21b. Trace Noise<sup>1</sup> Magnitude (dB rms) / Phase (deg rms), N5231B or N5232B, Option 400

| Description          | Specification | Typical       |               |               |
|----------------------|---------------|---------------|---------------|---------------|
|                      |               | 1 kHz IFBW    | 100 kHz IFBW  | 600 kHz IFBW  |
| 300 kHz to 10 MHz    | 0.015 / 0.050 | 0.001 / 0.003 | 0.055 / 0.350 | 0.070 / 0.663 |
| 10 MHz to 45 MHz     | 0.007 / 0.050 | 0.004 / 0.024 | 0.055 / 0.350 | 0.110 / 0.663 |
| 45 MHz to 500 MHz    | 0.007 / 0.020 | 0.004 / 0.005 | 0.007 / 0.080 | 0.110 / 0.080 |
| 500 MHz to 13.51 GHz | 0.007 / 0.020 | 0.001 / 0.005 | 0.007 / 0.080 | 0.015 / 0.080 |
| 13.51 GHz to 20 GHz  | 0.010 / 0.045 | 0.001 / 0.006 | 0.010 / 0.100 | 0.020 / 0.130 |

<sup>1</sup> Ratioed measurement, nominal power at test port.

Table 21c. Trace Noise<sup>1</sup> Magnitude (dB rms) / Phase (deg rms), N5231B or N5232B, Option 416

| Description          | Specification | Typical       |               |               |
|----------------------|---------------|---------------|---------------|---------------|
|                      |               | 1 kHz IFBW    | 100 kHz IFBW  | 600 kHz IFBW  |
| 300 kHz to 10 MHz    | 0.007 / 0.052 | 0.001 / 0.003 | 0.053 / 0.350 | 0.110 / 0.300 |
| 10 MHz to 45 MHz     | 0.002 / 0.052 | 0.004 / 0.024 | 0.053 / 0.350 | 0.110 / 0.670 |
| 45 MHz to 500 MHz    | 0.002 / 0.052 | 0.001 / 0.005 | 0.053 / 0.350 | 0.110 / 0.670 |
| 500 MHz to 13.51 GHz | 0.002 / 0.020 | 0.001 / 0.005 | 0.015 / 0.100 | 0.020 / 0.100 |
| 13.51 GHz to 20 GHz  | 0.003 / 0.045 | 0.001 / 0.007 | 0.025 / 0.150 | 0.030 / 0.160 |

<sup>1</sup> Ratioed measurement, nominal power at test port.

Table 22. Reference Level Magnitude, All Models, All Options - Specification

| Description | Magnitude (dB) | Phase (degrees) |
|-------------|----------------|-----------------|
| Range       | +/-500         | +/-500          |
| Resolution  | 0.001          | 0.01            |

Table 23a, Stability<sup>1</sup>, All Models, Options 200 or 216 - Typical

| Description         | Magnitude (dB/°C) | Phase (°/°C) |
|---------------------|-------------------|--------------|
| 300 kHz to 10 MHz   | 0.04              | 0.40         |
| 10 MHz to 45 MHz    | 0.01              | 0.15         |
| 45 MHz to 2 GHz     | 0.01              | 0.10         |
| 2 GHz to 4 GHz      | 0.01              | 0.15         |
| 4 GHz to 8.5 GHz    | 0.01              | 0.35         |
| 8.5 GHz to 13.5 GHz | 0.02              | 0.75         |
| 13.5 GHz to 20 GHz  | 0.03              | 0.95         |

<sup>1</sup> Stability is defined as a ratio measurement made at the test port.

Table 23b. Stability<sup>1</sup>, N5231B, N5232B, Options 400, 416 - Typical

| Description        | Magnitude (dB/°C) | Phase (°/°C) |
|--------------------|-------------------|--------------|
| 300 kHz to 10 MHz  | 0.03              | 0.40         |
| 10 MHz to 2 GHz    | 0.01              | 0.07         |
| 2 GHz to 4 GHz     | 0.01              | 0.10         |
| 4 GHz to 13.5 GHz  | 0.03              | 0.50         |
| 13.5 GHz to 16 GHz | 0.02              | 0.50         |
| 16 GHz to 19 GHz   | 0.02              | 0.60         |
| 19 GHz to 20 GHz   | 0.03              | 0.70         |

<sup>1</sup> Stability is defined as a ratio measurement made at the test port.

Table 24a. Damage Level, All Models - Specification

| Description | Option 200 |          | Option 400 |          |
|-------------|------------|----------|------------|----------|
|             | RF (dBm)   | DC (VDC) | RF (dBm)   | DC (VDC) |
| Ports 1, 2  | 30         | 40       | 27         | 16       |
| Ports 3, 4  | --         | --       | 27         | 16       |

Table 24b. Damage Level, All Models - Specification

| Description                | Option 216 |          | Option 416 |          |
|----------------------------|------------|----------|------------|----------|
|                            | RF (dBm)   | DC (VDC) | RF (dBm)   | DC (VDC) |
| Ports 1, 2, 3, 4           | 27         | 7        | 27         | 16       |
| RCVR A, B, C, D IN         | 15         | 16       | 15         | 16       |
| REF RCVR R1 IN             | 15         | 16       | 15         | 16       |
| REF SOURCE OUT             | 20         | 16       | 20         | 16       |
| PORT 1, 2, 3, 4 SOURCE OUT | 27         | 7        | 27         | 16       |
| PORT 1, 2, 3, 4 CPLR THRU  | 27         | 7        | 27         | 16       |
| PORT 1, 2, 3, 4 CPLR ARM   | 15         | 5        | 15         | 5        |

# Dynamic Accuracy

Standard receiver accuracy of the test port input power reading relative to the reference input power level. It is verified with the following measurements:

- Compression over frequency
- IF linearity at a single frequency of 99.6 MHz or 1.998765 GHz using a reference level of -20 dBm for an input power range of 0 to -60 dBm. For values below -60 dBm, refer to [VNA Receiver Dynamic Accuracy Specifications and Uncertainties](#)"

Table 25. Dynamic Accuracy - Specification

## Dynamic Accuracy, 50 MHz

Magnitude

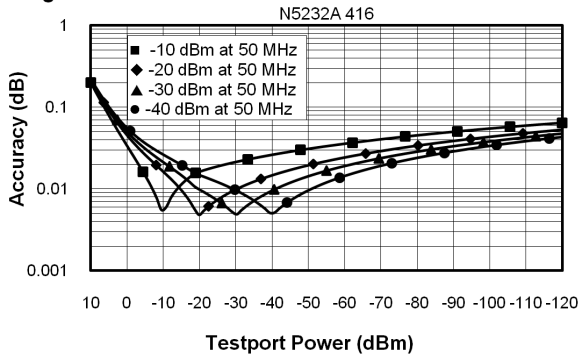

Phase

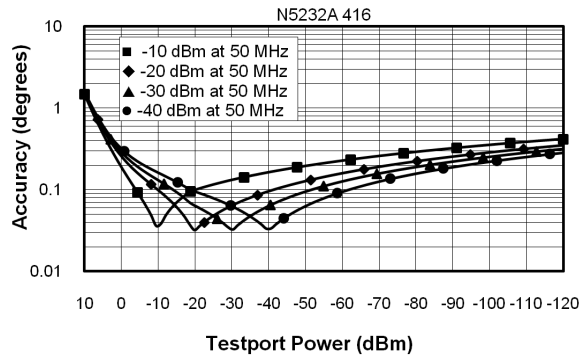

## Dynamic Accuracy, 500 MHz

Magnitude

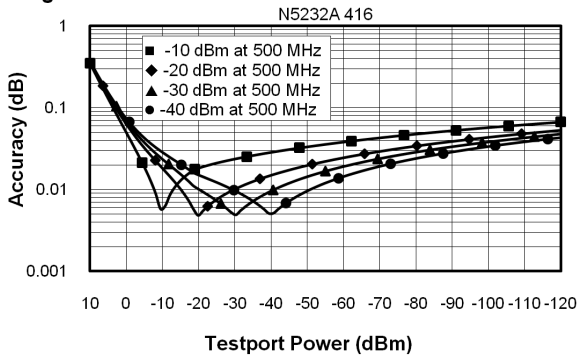

Phase

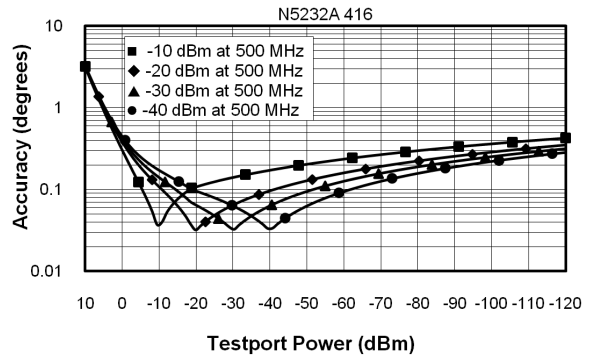

## Dynamic Accuracy, 1 GHz

Magnitude

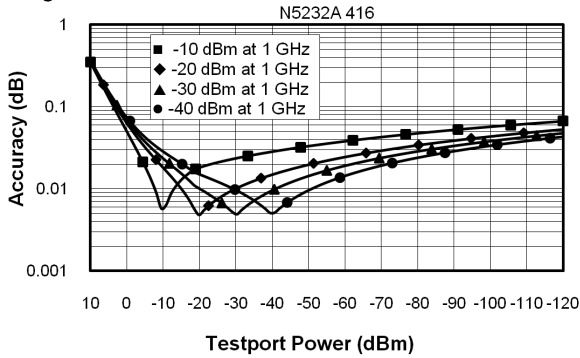

Phase

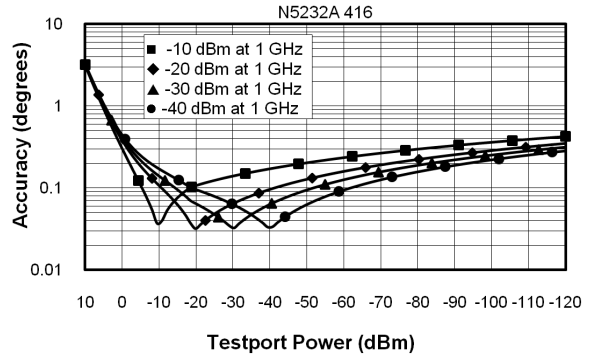

## Dynamic Accuracy, 2 GHz

Magnitude

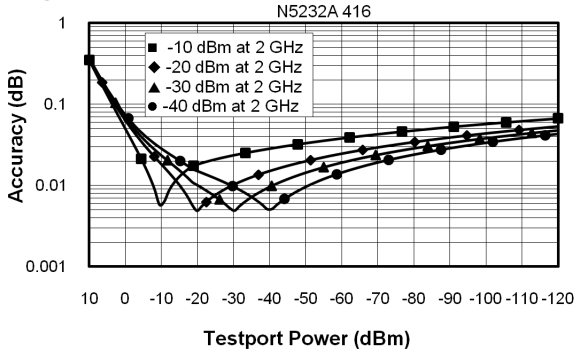

Phase

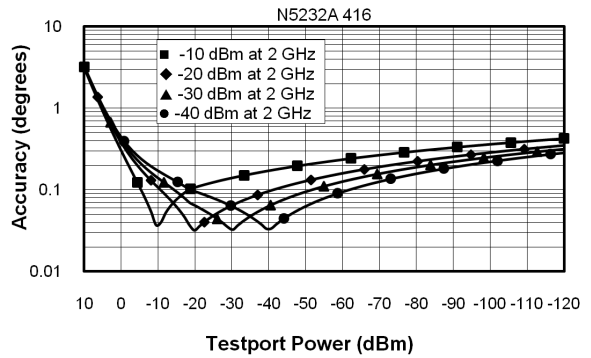

## Dynamic Accuracy, 20 GHz

Magnitude

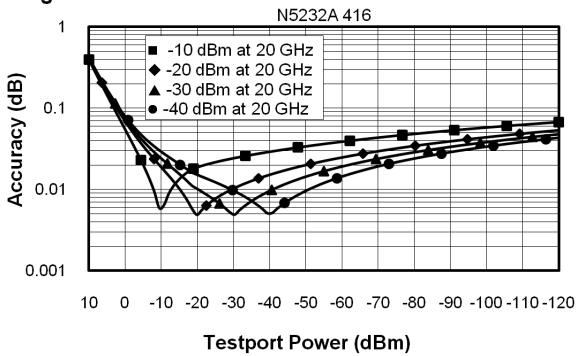

Phase

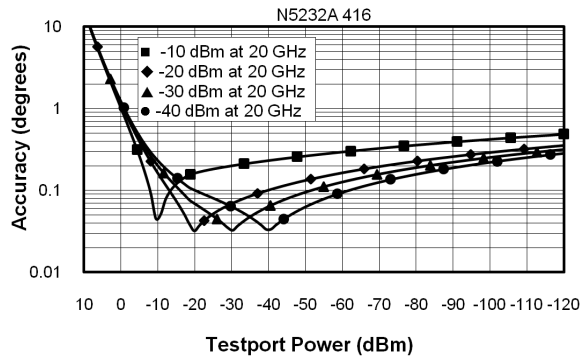

Table 26. Group Delay<sup>1</sup>

| Description           | Typical Performance  |
|-----------------------|--|
| Aperture (selectable) | (frequency span)/(number of points -1)   |
| Maximum Aperture      | 20% of frequency span  |
| Range                 | 0.5 x (1/minimum aperture)   |
| Maximum Delay         | Limited to measuring no more than 180° of phase change within the minimum aperture.) |

The following graphs show characteristic group delay accuracy with full 2-port calibration and a 10 Hz IF bandwidth. Insertion loss is assumed to be < 2 dB and electrical length to be ten meters.

For any  $S_{ij}$  Group Delay measurement,  $S_{ii} = 0$ ,  $S_{ij} = 1$ ,  $S_{ji} = 0$ ,  $S_{kl} = 0$  for all  $kl \neq ij$

### Group Delay (Typical)

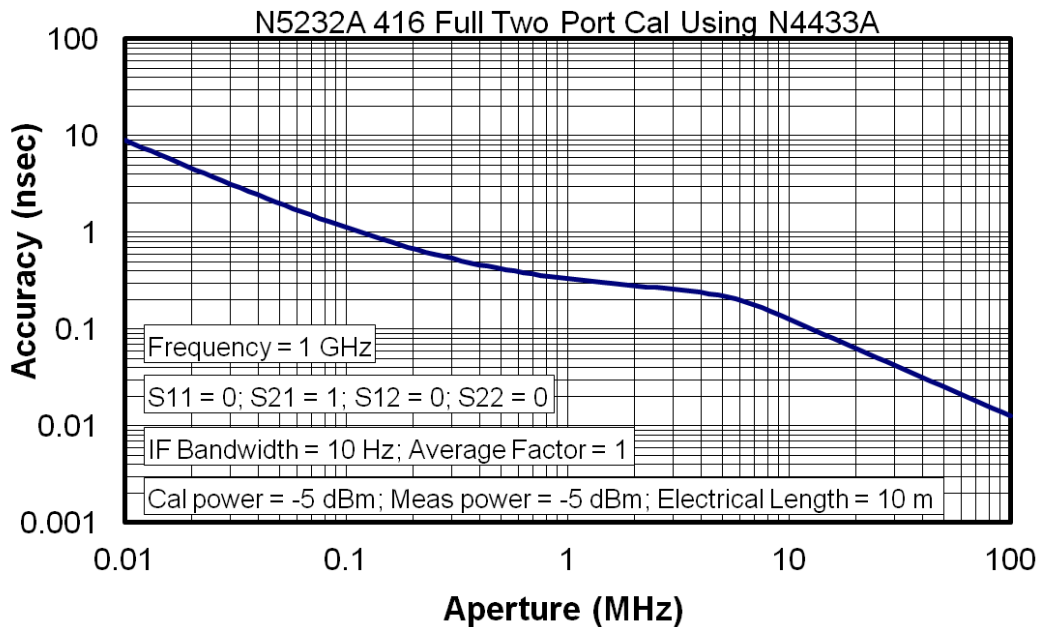

In general, the following formula can be used to determine the accuracy, in seconds, of specific group delay measurement:

$$\pm \text{Phase Accuracy (deg)} / [360 \times \text{Aperture (Hz)}]$$

Depending on the aperture and device length, the phase accuracy used is either incremental phase accuracy or worst-case phase accuracy.

<sup>1</sup> Group delay is computed by measuring the phase change within a specified frequency step (determined by the frequency span and the number of points per sweep).

## General Information

- [Miscellaneous Information](#)
- [Front Panel](#)
- [Rear Panel](#)
- [Environment and Dimensions](#)

Table 27. Miscellaneous Information

| Description               | Supplemental Information  |  |
|---------------------------|---|--|
| System IF Bandwidth Range | 1 Hz to 15 MHz, nominal   |  |
| CPU                       | For the latest information on CPUs and associated hard drives, visit: <a href="http://keysight.com">PNA Hard Drives and CPUs (keysight.com)</a> |  |
| LXI                       | CPU version 7.0, 8.0<br>Class C   | CPU version 9.0<br>LXI 1.5<br>Extended Functions:<br>HiSLIP; VSI-11 Discovery and Identification |

Table 28. Front Panel Information, All Options

| Description                             | Typical Performance   |
|---|---|
| <b>RF Connectors</b>                    |   |
| Test Ports                              | 3.5 mm (male), 50 ohm (nominal), 0.002 in. Center Pin Recession (characteristic)  |
| Jumpers (Options 216, 416)              | SMA (female) connectors with SMA (male) jumper cables   |
| <b>USB 2.0 Ports - Master (4 ports)</b> |   |
| Standard                                | Compatible with USB 2.0   |
| Connector                               | USB Type-A female   |
| <b>Display</b>                          |   |
| Size                                    | 31 cm (12.1 in) diagonal color active matrix LCD; 1280 (horizontal) X 800 (vertical) resolution   |
| Refresh Rate                            | Vertical 60 Hz; Horizontal 49.31 kHz  |
| Pixels                                  | <p>Any of the following would cause a display to be considered faulty:</p> <ul style="list-style-type: none"> <li>• A complete row or column consists of “stuck” or “dark” pixels.</li> <li>• More than six “stuck on” pixels (but not more than three green) or more than 0.002% of the total pixels are within the LCD specifications.</li> <li>• More than twelve “dark” pixels (but no more than seven of the same color) or more than 0.004% of the total pixels are within the LCD specifications.</li> <li>• Two or more consecutive "stuck on" pixels or three or more consecutive "dark" pixel (but no more than one set of two consecutive dark pixels).</li> </ul> |

- “Stuck on” pixels or more than two “dark” pixels less than 6.5 mm apart (excluding consecutive pixels).

Table 28. (Continued) Front Panel Information, All Options

| Description               | Typical Performance                 |
|---------------------------|-------------------------------------|
| <b>Display Range</b>      |                                     |
| Magnitude                 | +/-2500 dB (at 500 dB/div), max     |
| Phase                     | +/-2500° (at 500 degrees/div), max  |
| Polar                     | 10 pUnits, min<br>10,000 Units, max |
| <b>Display Resolution</b> |                                     |
| Magnitude                 | 0.001 dB/div, min                   |
| Phase                     | 0.01°/div, min                      |
| <b>Marker Resolution</b>  |                                     |
| Magnitude                 | 0.001 dB, min                       |
| Phase                     | 0.01°, min                          |
| Polar                     | 10 pUnit, min                       |

Table 29. Rear Panel Information, All Options

| Description                 | Typical Performance      |
|-----------------------------|--------------------------|
| <b>10 MHz Reference In</b>  |                          |
| Connector                   | BNC, female              |
| Input Frequency             | 10 MHz ± 10 ppm          |
| Input Level                 | -15 dBm to +20 dBm       |
| Input Impedance             | 200 Ω, nom.              |
| <b>10 MHz Reference Out</b> |                          |
| Connector                   | BNC, female              |
| Output Frequency            | 10 MHz ± 1 ppm           |
| Signal Type                 | Sine Wave                |
| Output Level                | +10 dBm ± 4 dB into 50 Ω |
| Output Impedance            | 50 Ω, nominal            |
| Harmonics                   | <-40 dBc, typical        |

Table 29. (Continued) Rear Panel Information, All Options

| Description            | Typical Performance   |   |
|------------------------|---|---|
| Trigger Inputs/Outputs | BNC(f), TTL/CMOS compatible   |   |
| Test Set IO            | 25-pin D-Sub connector, available for external test set control   |   |
| Power IO               | 9-pin D-Sub, female; analog and digital IO  |   |
| Handler IO             | 36-pin parallel I/O port; all input/output signals are default set to negative logic; can be reset to positive logic via GPIB command   |   |
| GPIB                   | Two ports - dedicated controller and dedicated talker/listener. 24-pin D-sub (Type D-24), female; compatible with IEEE-488  |   |
| <b>CPU Version</b>     | <b>CPU version 7.0, 8.0</b>   | <b>CPU version 9.0</b>  |
| PCIe                   | Cabled PCIe x4 connector is a 4-lane slot   | N/A   |
| USB Ports              | Two SuperSpeed USB ports (900 mA each), one USB port below LAN connector, and one USB device port. There are also four USB ports (500 mA each) on the front panel. The total current limit for all rear panel USB ports is 2.3 amps. The total current limit for all front panel USB ports is 2 amps. | Four SuperSpeed USB ports (900 mA each) and one USB device port. There are also four USB ports (500 mA each) on the front panel. The total current limit for all rear panel USB ports is 3.6 amps. The total current limit for all front panel USB ports is 2 amps. |
| USB-C (Host)           | N/A   | Two USB-C connectors with support for USB-3.1 (max Power Delivery of 5V@1A), Thunderbolt3 (max Power Delivery of 5V@1A) <sup>1</sup> , and Display Port (port TB1 only)   |
| LAN                    | 1G port;<br>10/100/1000 BaseT Ethernet, 8-pin configuration; auto selects between the data rates  | 1G and 10G ports;<br>10GBASE-T, Ethernet, 8-pin configuration; auto selects between the data rates. Works with Cat6/Cat7 cable.   |
| VGA Video Output       | 15-pin mini D-Sub; Drives VGA compatible monitors   | N/A   |
| Mini DisplayPort       | Miniature DisplayPort connector for connection to external displays   | N/A   |
| DisplayPort            | N/A   | Standard DisplayPort connector for connection to external displays  |
| <b>Line Power</b>      |   |   |
| Frequency, Voltage     | 50/60/400 Hz for 100 to 120 VAC<br>50/60 Hz for 220 to 240 VAC  |   |
|                        | Power supply is auto switching  |   |
| Max                    | 350 watts   |   |

<sup>1</sup> High power devices require external power supply



Table 30. Analyzer Dimensions and Weight

All models are shipped with bottom feet, handles and front and rear hardware.

| <b>Cabinet Dimensions</b>                    | <b>Metric (mm)</b> | <b>Imperial (inches)</b> |
|--|--------------------|--------------------------|
| <b>Height</b>                                |                    |                          |
| Without bottom feet: EIA RU <sup>1</sup> = 6 | 266.1              | 10.5                     |
| With bottom feet                             | 279.1              | 11                       |
| <b>Width</b>                                 |                    |                          |
| Without handles or rack-mount flanges        | 425.6              | 16.8                     |
| With handles, without rack-mount flanges     | 458.7              | 18.1                     |
| With handles and rack-mount flanges          | 482.9              | 19.0                     |
| <b>Depth</b>                                 |                    |                          |
| Without front and rear panel hardware        | 445.7              | 17.5                     |
| With front and rear panel hardware, handles  | 497.2              | 19.6                     |
| <b>Weight (nominal)</b>                      | <b>Net</b>         | <b>Shipping</b>          |
| 2-port models (Option 216)                   | 23.6 kg (52 lb)    | 34.9 kg (77 lb)          |
| 4-port models (Option 416)                   | 24 kg (53 lb)      | 35.4 kg (78 lb)          |

<sup>1</sup>Electronics Industry Association rack units. 1 RU = 1.75 in.

#### Regulatory and Environmental Information

For Regulatory and Environmental information, refer to the PNA Series Installation and Quick Start Guide, located online at <http://literature.cdn.keysight.com/litweb/pdf/E8356-90001.pdf>.

## Measurement Throughput Summary

- Typical Cycle Time for Measurement Completion
- Cycle Time vs. IF Bandwidth
- Cycle Time vs. Number of Points
- Data Transfer Time

Cycle time Includes sweep time, retrace time and band-crossing time. Analyzer display turned off with DISPLAY:ENABLE OFF. Add 21 ms for display on. Data for one trace ( $S_{11}$ ) measurement.

Table 31a. Cycle Time (ms) for Measurement Completion, All Models, All Options - Typical

| Sweep Range     | IF Bandwidth |             | Number of Points |     |      |       |       |
|-----------------|--------------|-------------|------------------|-----|------|-------|-------|
|                 |              |             | 201              | 401 | 1601 | 16001 | 32001 |
| 9 GHz to 10 GHz | 600 kHz      | Uncorrected | 6                | 6   | 9    | 55    | 106   |
|                 |              | 2-Port cal  | 7                | 9   | 17   | 111   | 216   |
|                 | 10 kHz       | Uncorrected | 29.1             | 54  | 204  | 1990  | 3980  |
|                 |              | 2-Port cal  | 56               | 106 | 404  | 3600  | 6390  |
|                 | 1 kHz        | Uncorrected | 227              | 445 | 1742 | 17010 | 33780 |
|                 |              | 2-Port cal  | 451              | 888 | 3482 | 27231 | 54100 |

Table 31b. N5239B Cycle Time (ms) for Full-Span Measurement Completion - Typical

| 300 kHz to 8.5 GHz |             | Number of Points |      |      |       |       |
|--------------------|-------------|------------------|------|------|-------|-------|
| IF Bandwidth       |             | 201              | 401  | 1601 | 16001 | 32001 |
| 600 kHz            | Uncorrected | 24.22            | 27.5 | 46   | 113   | 257   |
|                    | 2-Port cal  | 46               | 53   | 89   | 226   | 515   |
| 10 kHz             | Uncorrected | 70               | 126  | 228  | 2120  | 4088  |
|                    | 2-Port cal  | 137              | 249  | 453  | 4120  | 8020  |
| 1 kHz              | Uncorrected | 235              | 456  | 1768 | 17170 | 34098 |
|                    | 2-Port cal  | 468              | 910  | 3417 | 32057 | 54584 |

Table 31c. N5231B Cycle Time (ms) for Full-Span Measurement Completion- Typical

| 300 kHz to 13.5 GHz |             | Number of Points |     |      |       |       |
|---------------------|-------------|------------------|-----|------|-------|-------|
| IF Bandwidth        |             | 201              | 401 | 1601 | 16001 | 32001 |
| 600 kHz             | Uncorrected | 27               | 29  | 44   | 108   | 258   |
|                     | 2-Port cal  | 52               | 56  | 85   | 219   | 518   |
| 10 kHz              | Uncorrected | 72               | 130 | 236  | 2073  | 4103  |
|                     | 2-Port cal  | 141              | 257 | 470  | 4146  | 7397  |
| 1 kHz               | Uncorrected | 237              | 460 | 1781 | 17312 | 34381 |
|                     | 2-Port cal  | 472              | 917 | 3559 | 34626 | 45875 |

Table 31d. N5232B Cycle Time (ms) for Full-Span Measurement Completion- Typical

| 300 kHz to 20 GHz |             | Number of Points |     |      |       |       |
|-------------------|-------------|------------------|-----|------|-------|-------|
| IF Bandwidth      |             | 201              | 401 | 1601 | 16001 | 32001 |
| 600 kHz           | Uncorrected | 34               | 37  | 49   | 115   | 170   |
|                   | 2-Port cal  | 67               | 72  | 95   | 228   | 346   |
| 10 kHz            | Uncorrected | 75               | 134 | 337  | 2152  | 4079  |
|                   | 2-Port cal  | 147              | 266 | 672  | 3971  | 7621  |
| 1 kHz             | Uncorrected | 240              | 464 | 1790 | 17405 | 34568 |
|                   | 2-Port cal  | 478              | 926 | 3510 | 33651 | 55331 |

**Table 32. Cycle Time vs. IF Bandwidth - Typical**

Applies to the Preset condition (201 points, correction off) except for the following changes:

- CF = 7 GHz
- Span = 100 MHz
- Display off (add 21 ms for display on)

Cycle time includes sweep and retrace time.

| <b>Description</b>       |                        | <b>Option 200, 216, 400, 416</b>      |  |
|--------------------------|------------------------|---------------------------------------|--|
| <b>IF Bandwidth (Hz)</b> | <b>Cycle Time (ms)</b> | <b>Trace Noise Magnitude (dB rms)</b> |  |
| 600,000                  | 5.75                   | 0.006                                 |  |
| 100,000                  | 5.78                   | 0.005                                 |  |
| 30,000                   | 8.83                   | 0.001                                 |  |
| 10,000                   | 28.80                  | 0.0003                                |  |
| 3,000                    | 71                     | 0,0001                                |  |
| 1,000                    | 220                    | 0,0001                                |  |
| 300                      | 638                    | 0,0001                                |  |
| 100                      | 1822                   | 0,0001                                |  |
| 30                       | 5981                   | 0,0001                                |  |
| 10                       | 17828                  | 0,0001                                |  |
| 3                        | 59273                  | 0,0001                                |  |

**Table 33. Cycle Time vs. Number of Points - Typical**

Applies to the Preset condition (correction off) except for the following changes:

- CF = 7 GHz
- Span = 100 MHz
- Display off (add 21 ms for display on)

Cycle time includes sweep and retrace time.

| Description | IF Bandwidth (Hz) |       |        |        |
|-------------|-------------------|-------|--------|--------|
|             | Number of Points  | 1,000 | 10,000 | 30,000 |
| 3           | 6.80              | 5.62  | 5.51   | 5.50   |
| 11          | 15.80             | 5.72  | 5.53   | 5.53   |
| 51          | 59                | 10    | 5.57   | 5.59   |
| 101         | 113               | 16    | 6.33   | 5.63   |
| 201         | 220               | 29    | 8.83   | 5.75   |
| 401         | 443               | 54    | 13.90  | 6.00   |
| 801         | 853               | 103   | 23.80  | 6.52   |
| 1,601       | 1693              | 203   | 43.80  | 9      |
| 6,401       | 6672              | 798   | 164    | 25     |
| 16,001      | 16531             | 1990  | 403    | 56     |
| 32,001      | 32828             | 3977  | 803    | 108    |

**Table 34. Data Transfer Times - Typical**

- Values are for Real & Imaginary pairs (two values per point)
- Results measured with the analyzer display off. Values will increase slightly if the analyzer display is on.
- LAN values assume a gigabit connection and are highly dependent upon both LAN conditions and the computer used
- All values are approximate. Example values shown are actual averaged measured results and include the time required to send the command to request the data

| Description   | General Formula        | Example for 1601 Points | Example for 32001 Points |
|---|------------------------|-------------------------|--------------------------|
| <b>SCPI over GPIB<sup>1</sup> (Program executed on external PC)</b> |                        |                         |                          |
| 32-bit floating point   | 1 mS + .024 mS/point   | 39 mS                   | 755 mS                   |
| ASCII   | 1 mS + 0.185mS/point   | 300 mS                  | 5850 mS                  |
| <b>SICL over LAN (Program executed on external PC)</b>              |                        |                         |                          |
| 32-bit floating point   | 0.5 mS + 0.18 μS/point | 0.78 mS                 | 6.4 mS                   |
| ASCII   | 0.5 mS + .012 mS/point | 20.4 mS                 | 390 mS                   |
| <b>SICL (Program executed within the analyzer)</b>                  |                        |                         |                          |
| 32-bit floating point   | 0.3 mS + 0.18 μS/point | 0.64 mS                 | 6.2 mS                   |
| ASCII   | 0.3 mS + .012 mS/point | 20.2 mS                 | 388 mS                   |
| <b>COM (Program executed within the analyzer)</b>                   |                        |                         |                          |
| 32-bit floating point   | 130 μS + .012 μS/point | 0.14 mS                 | 0.5 mS                   |
| Variant type  | 130 μS + 1.7 μS/point  | 2.7 mS                  | 56 mS                    |
| <b>DCOM over LAN (Program executed on external PC)</b>              |                        |                         |                          |
| 32-bit floating point   | 350 μS + 0.17 μS/point | 0.55 mS                 | 5.7 mS                   |
| Variant type  | 350 μS + 3.4 μS/point  | 5.8 mS                  | 108 mS                   |

<sup>1</sup> Values obtained using USB-to-GPIB adapter (82357B)

**NOTE**

Internally, the PNA measurement data is handled in 32-bit (single-precision) format. Therefore, there is no need to use 64-bit transfers for most data. Frequency values however, may be rounded slightly with 32-bit transfers since there is insufficient resolution in this format to represent higher frequencies with 1 Hz accuracy. If this type of accuracy is needed for frequencies, then you should use 64-bit transfers. Specifications for Recall & Sweep Speed are not provided for the N523xB analyzers.

## Specifications: Front-Panel Jumpers

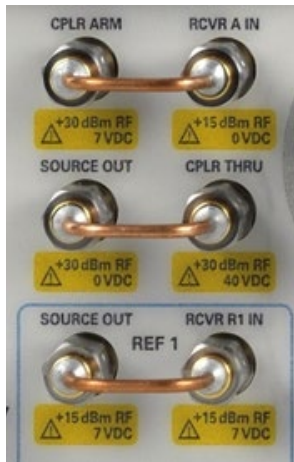

The following options have front-panel jumpers for each port:

Options 216, 416

- Measurement Receiver Inputs
- Reference Receiver Inputs and Reference Source Outputs
- Source Outputs
- Coupler Inputs

Table 35. Measurement Receiver Inputs (dBm) – Typical

(RCVR A, B, C, D IN) @ 0.1dB Typical Compression

| Description          | Option 216 | Option 416 |
|----------------------|------------|------------|
| 300 kHz to 10 MHz    | -9         | -11        |
| 10 MHz to 500 MHz    | -9         | -7         |
| 500 MHz to 8.5 GHz   | -4         | -6         |
| 8.5 GHz to 12.5 GHz  | -4         | -6         |
| 12.5 GHz to 13.5 GHz | -4         | -7         |
| 13.5 GHz to 20 GHz   | -5         | -7         |

Table 36. Reference Receiver Inputs and Reference Source Outputs (dBm) – Typical

(REF RCVR R1, R2<sup>1</sup> IN, REF 1, 2<sup>1</sup> SOURCE OUT) @ Specified Maximum Leveled Power

| Description          | Option 216 | Option 416 |
|----------------------|------------|------------|
| 300 kHz to 10 MHz    | -11        | -18        |
| 10 MHz to 2 GHz      | -9         | -15        |
| 2 GHz to 8.5 GHz     | -10        | -16        |
| 8.5 GHz to 12.5 GHz  | -13        | -19        |
| 12.5 GHz to 13.5 GHz | -16        | -21        |
| 13.5 GHz to 15 GHz   | -15        | -21        |
| 15 GHz to 20 GHz     | -15        | -26        |

<sup>1</sup> Not available with Option 416.

Table 37. Source Outputs (dBm) - Typical

(PORT 1, 2, 3, 4 SOURCE OUT) @ Specified Maximum Leveled Power

| Description          | Option 216 | Option 416 |
|----------------------|------------|------------|
| 300 kHz to 10 MHz    | 11         | 7          |
| 10 MHz to 2 GHz      | 13         | 10         |
| 2 GHz to 8.5 GHz     | 13         | 9          |
| 8.5 GHz to 12.5 GHz  | 10         | 4          |
| 12.5 GHz to 13.5 GHz | 7          | 1          |
| 13.5 GHz to 15 GHz   | 8          | 1          |
| 15 GHz to 20 GHz     | 8          | -3         |

Table 38. Coupler Inputs (dB), All Options - Typical

(PORT 1, 2, 3, 4 CPLR THRU) Insertion Loss of Coupler Thru

| Description          | Insertion Loss |
|----------------------|----------------|
| 300 kHz to 8.5 GHz   | 2.0            |
| 8.5 GHz to 10.5 GHz  | 2.3            |
| 10.5 GHz to 13.5 GHz | 2.5            |
| 13.5 GHz to 20 GHz   | 3.0            |



## Test Set Block Diagrams

NOTE: For best readability, use a color printer for printing the following graphics.

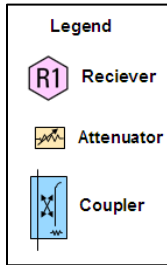

N5239B, N5231B and N5232B Option 200 (2-port base model)

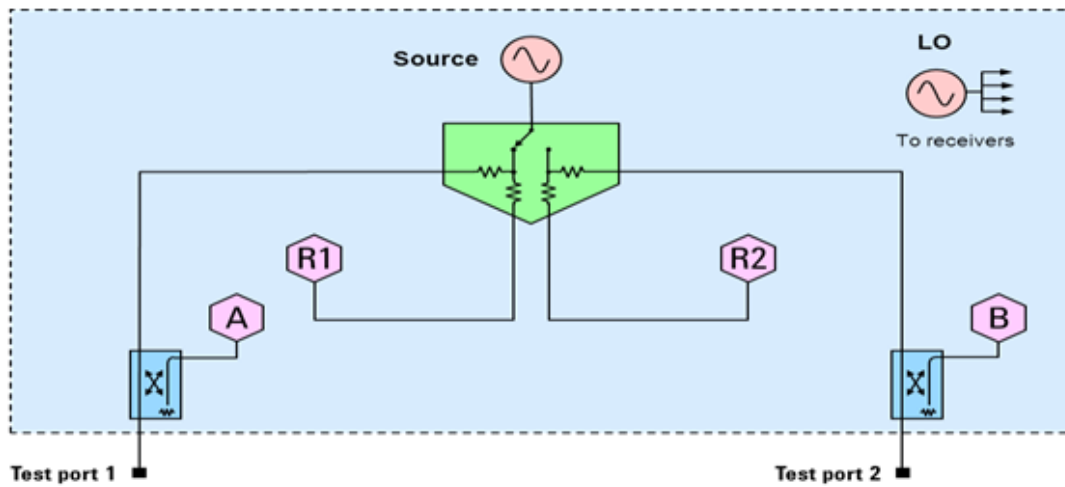

### N5239B, N5231B and N5232B Option 216

To base model, adds front-panel jumpers and source attenuators (extended power range).

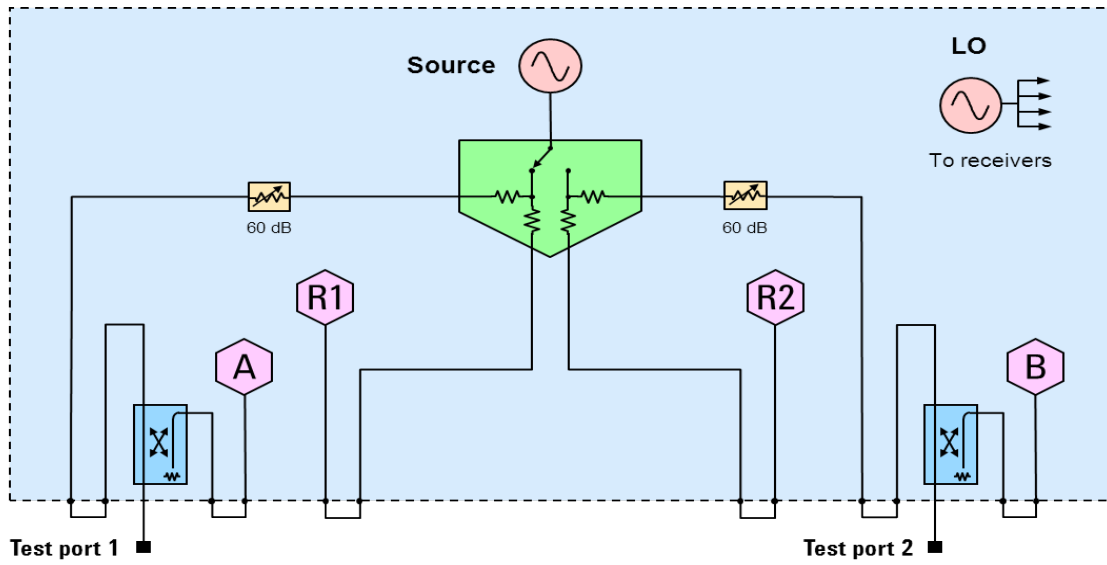

### N5231B and N5232B Option 400 (4-port base model)

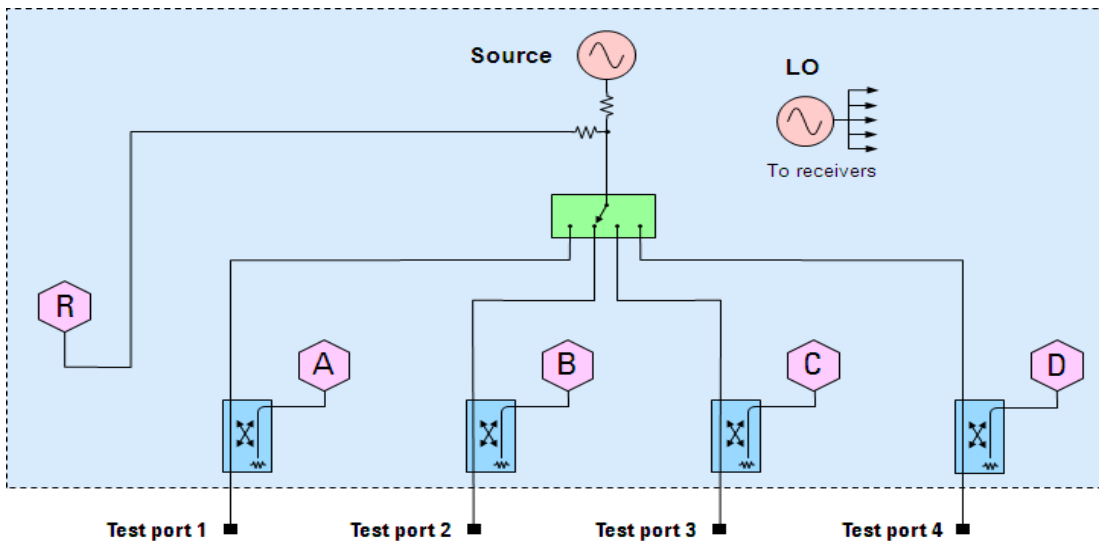

## N5231B and N5232B Option 416

To base model, adds front-panel jumpers and source attenuators (extended power range).

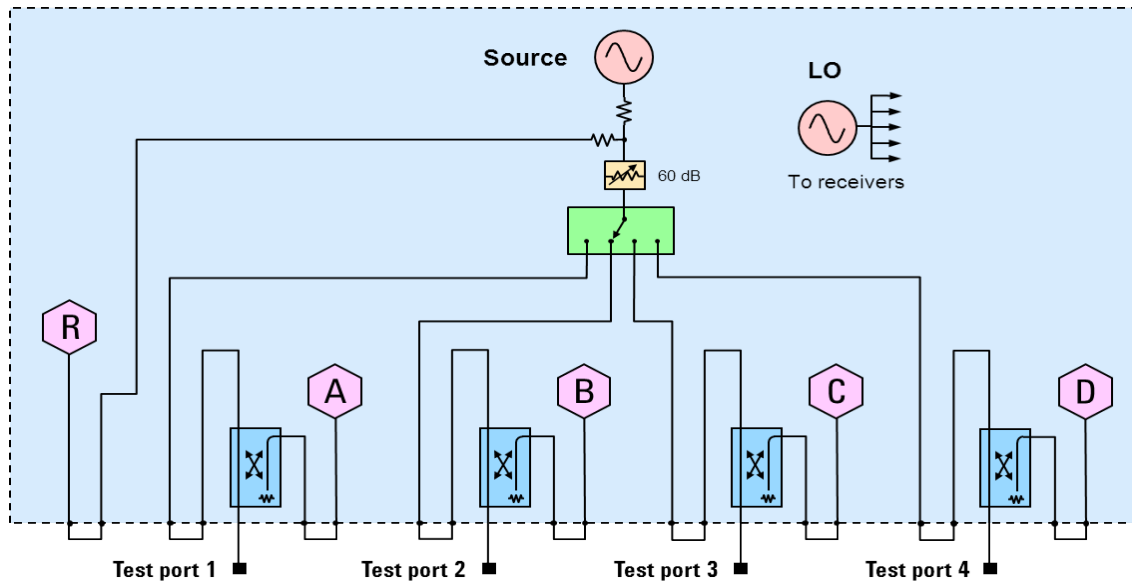

## Receiver Block Diagram

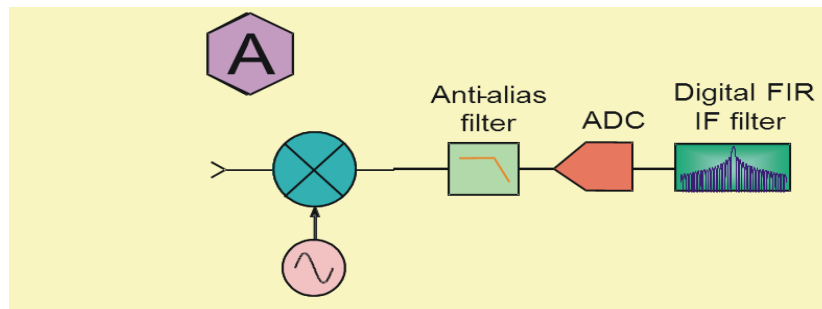



This information is subject to change without notice.  
© Keysight Technologies 2017-2023  
Print Date: January 18, 2023



N5232-90006

[www.keysight.com](http://www.keysight.com)