

IS AVB REALLY MUCH BETTER THAN CLASSIC IEEE 802.1Q QUEUING?

TECHNICAL GUIDE

Highlights

- Ethernet, best effort and quality of service
- Introduction to QoS and AVB
- Tests for classic QoS vs AVB
- Tests for classic PTP and gPTP

Learn more at: www.ixiacom.com

For more information on Ixia products, applications, or services, please contact your local Ixia or Keysight Technologies office.

The complete list is available at: www.ixiacom.com/contact/info

© Keysight Technologies

Ethernet, best effort and quality of service

- Original **Ethernet was best effort** – no guarantees with regards to delivery of datagrams
- IEEE 802.1p (later 802.1Q) added support for provisions for **quality of service (QoS) in 1998**
- IEEE 802.1BA (and others from the same standards suite), or **Audio Video Bridging (AVB)**, was created in 2011 to **enhance usability of Ethernet** for media streaming
 - Some parts of AVB were later integrated in 802.1Q-2014
- Benefits of AVB over “classic” 802.1Q queueing are unclear to many users



Purpose of this presentation

In February 2016 a group of people set out to analyze differences between AVB and QoS. Contributors included:

- Kevin Stanton, Intel
- Alon Regev, Ixia
- Anand Ram, Calnex
- Bogdan Tenea, Ixia
- Christopher Hall, Intel
- Chun Zhang, Extreme Networks
- David Moser, ESPN
- Eric Craig, Calnex
- Hugo Savino, Extreme Networks
- Kulin Shah, Arista
- Michael Francini, Arista
- Michael Johas Teener, Broadcom
- Nestor Amaya, Coveloz
- Nikhil Kallat, Arista
- Robert Welch, Arista

Plus several others

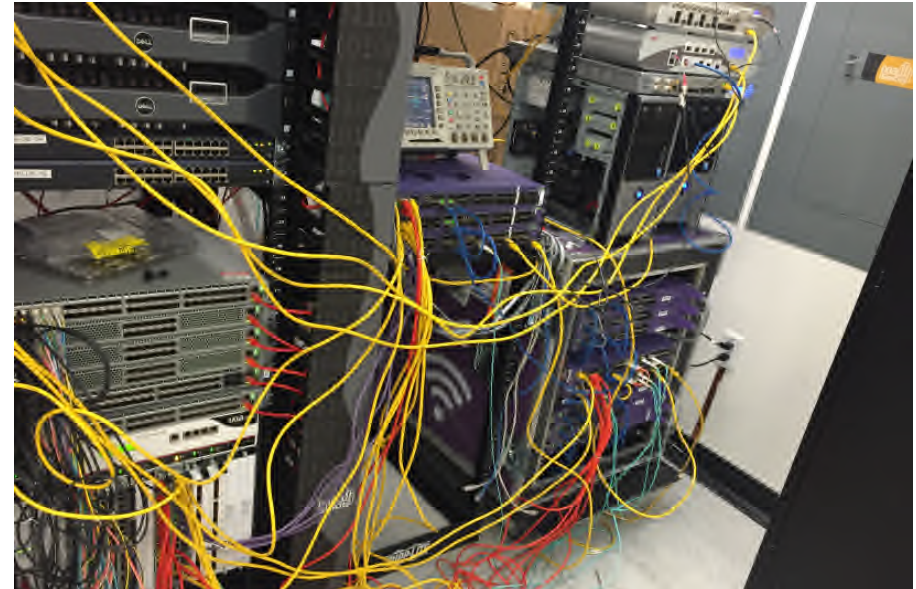

- Results focused on measuring traffic throughput and latency and time sync quality
- Tests were conducted at Ixia's [iSimCity](#) and results shared in this presentation were measured using [Ixia's IxNetwork AVB](#) tester

This presentation will:

1. Shed some light on the **technical details of QoS and AVB**
2. Show **results comparing AVB with classic QoS**

ixia

Introduction to QoS and AVB



Frames on Ethernet cables are like cars on roads

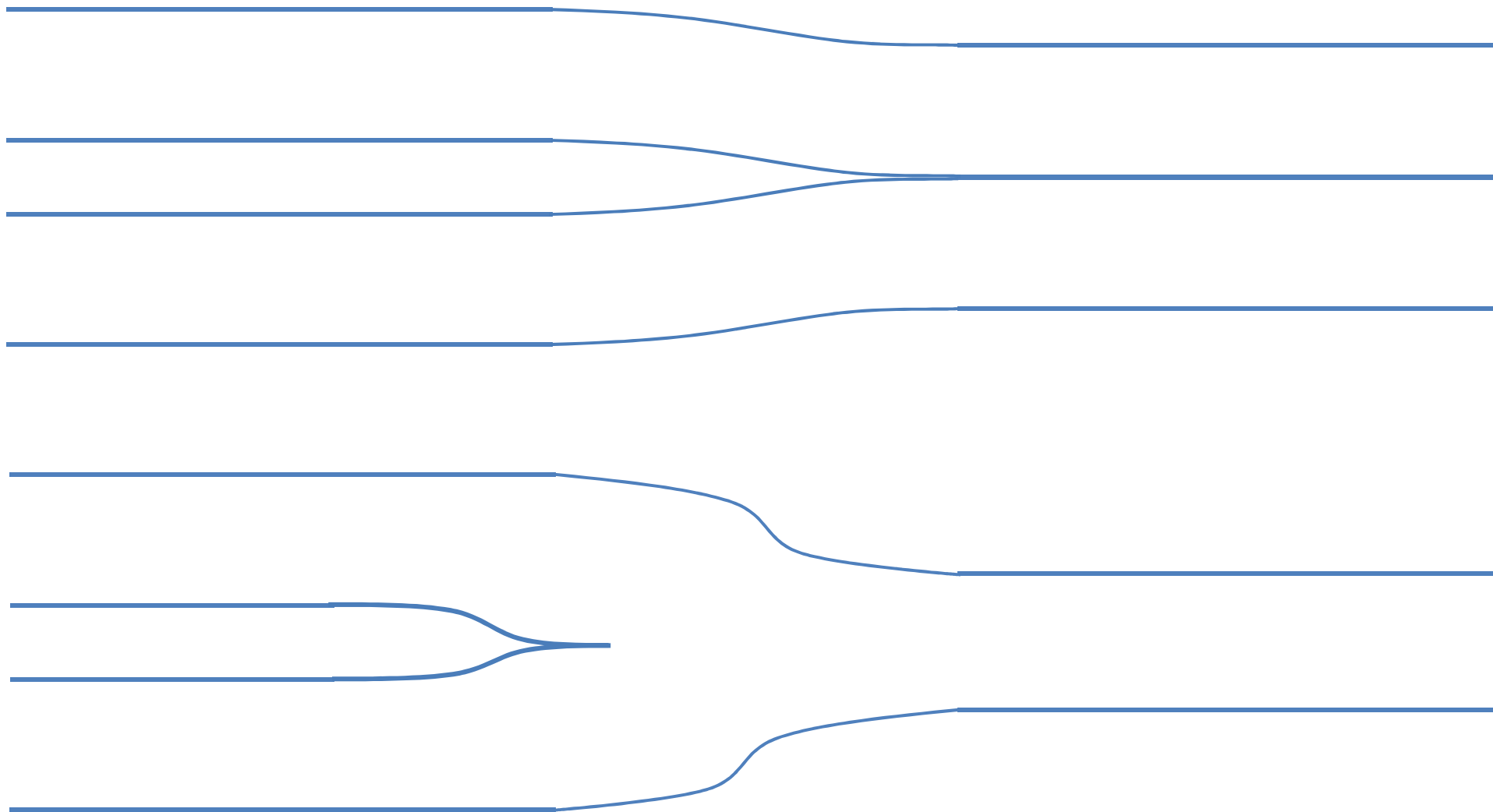

Quality of service with **Strict Priority**

- Packets with higher priority always get forwarded first

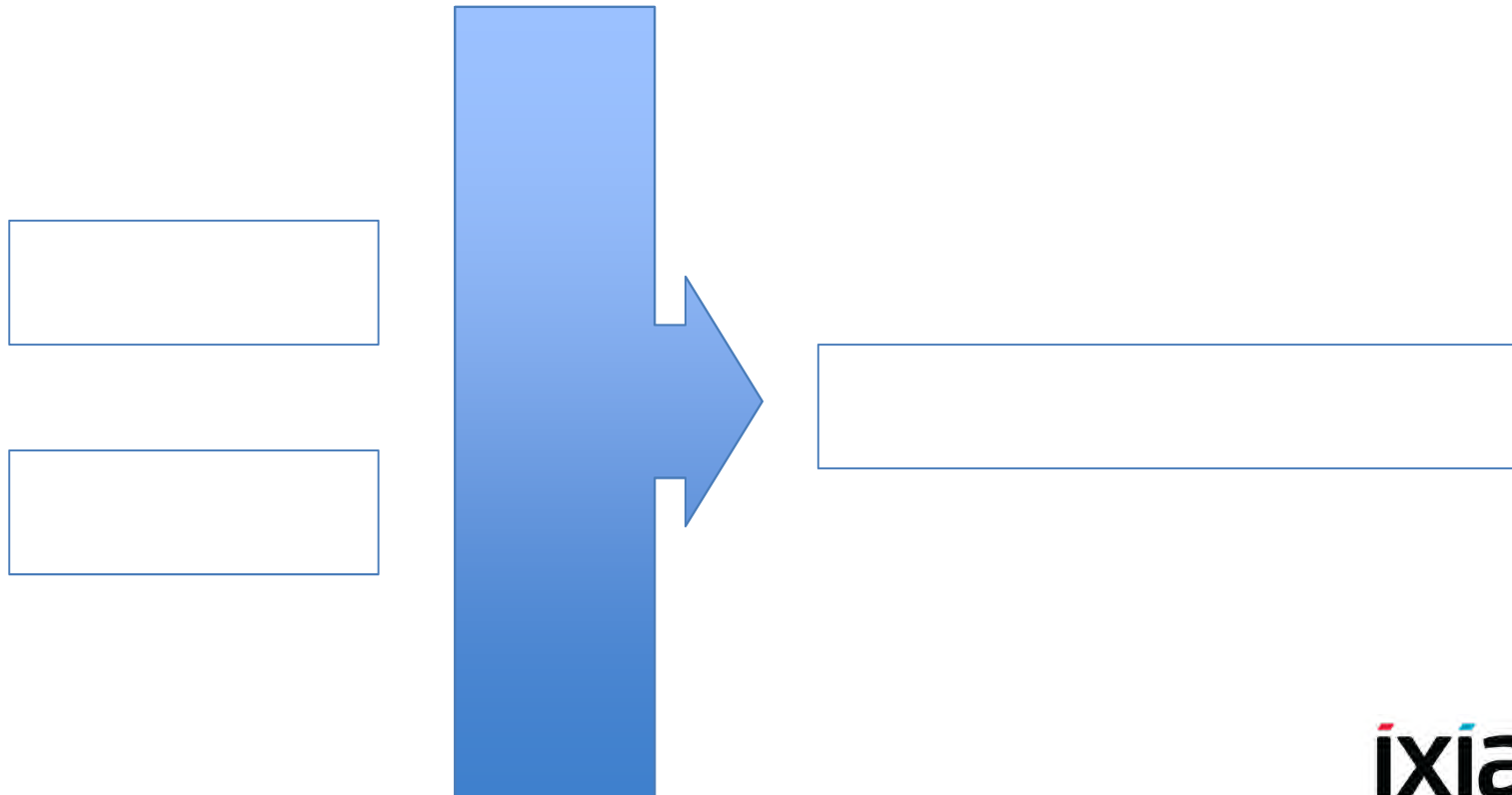

Quality of service with **Strict Priority**

- Packets with higher priority always get forwarded first
 - Packets from lower priority classes may be delayed/dropped

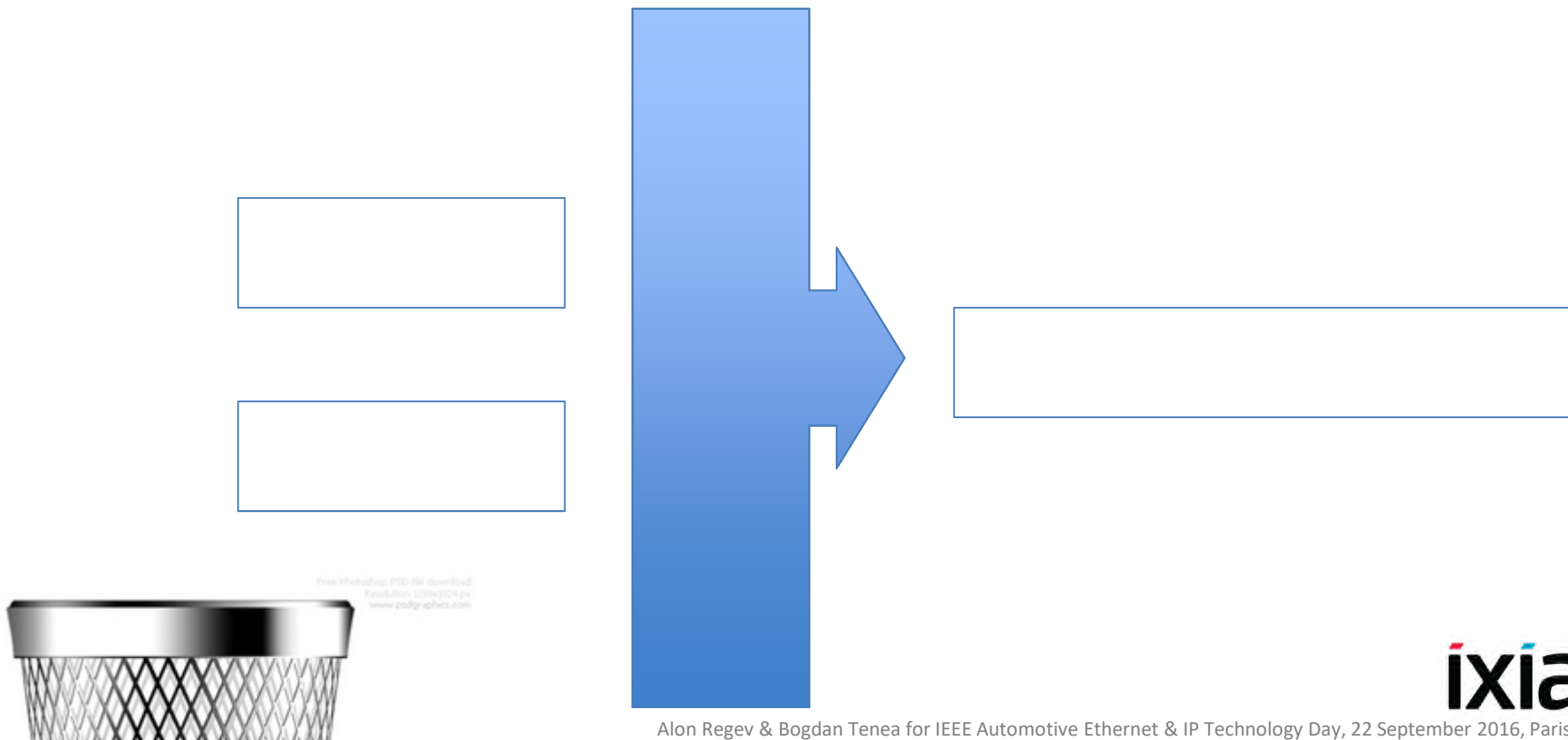

Quality of service with **Strict Priority**

- Packets with higher priority always get forwarded first
 - Packets from lower priority classes may be delayed/dropped
 - With two types of priority traffic second priority may not get guarantees

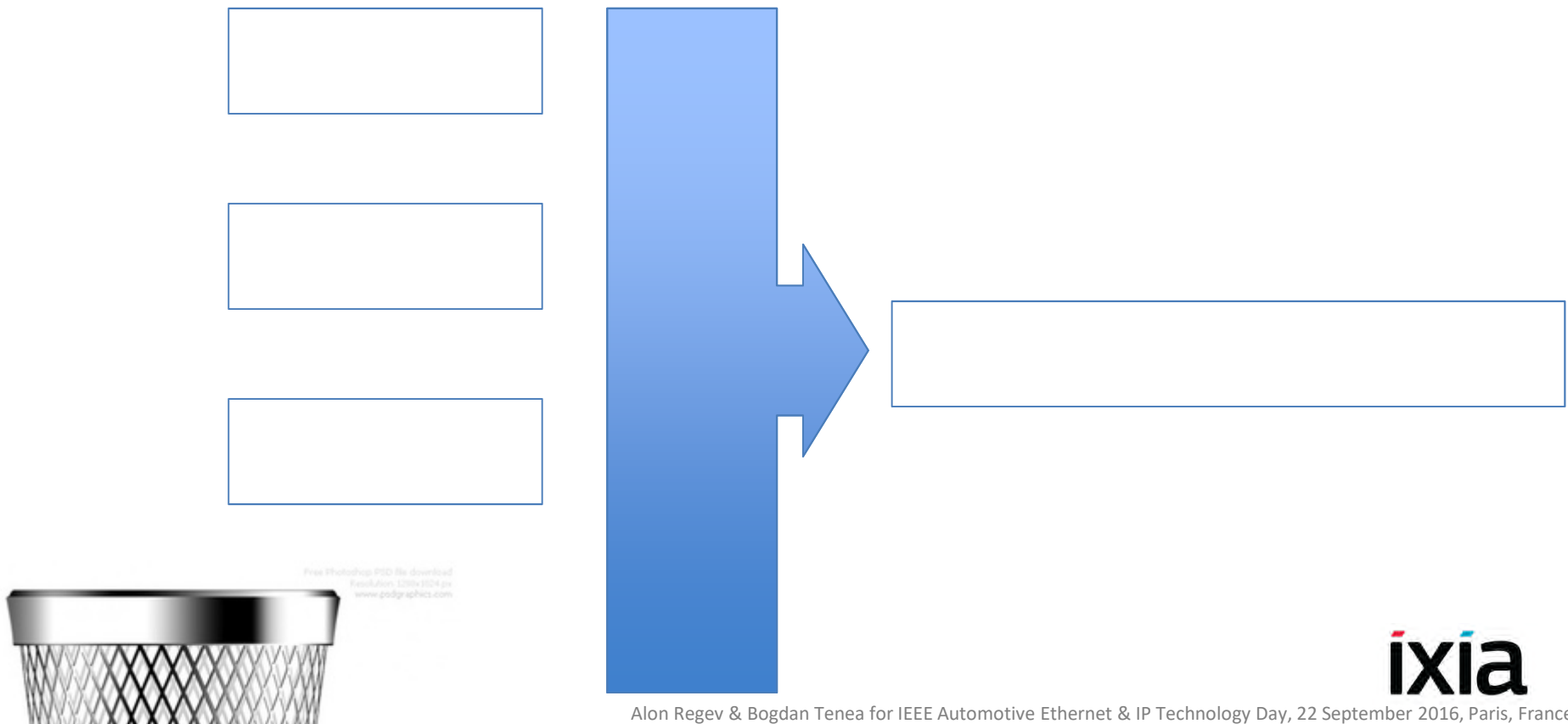

Quality of service with **Weighted Round Robin**

- A certain percent of packets or bytes get forwarded from each queue
- This guarantees minimum bandwidth, but there's no way to put a limit on maximum bandwidth per each queue
 - If other queues are empty a single queue can use all the bandwidth

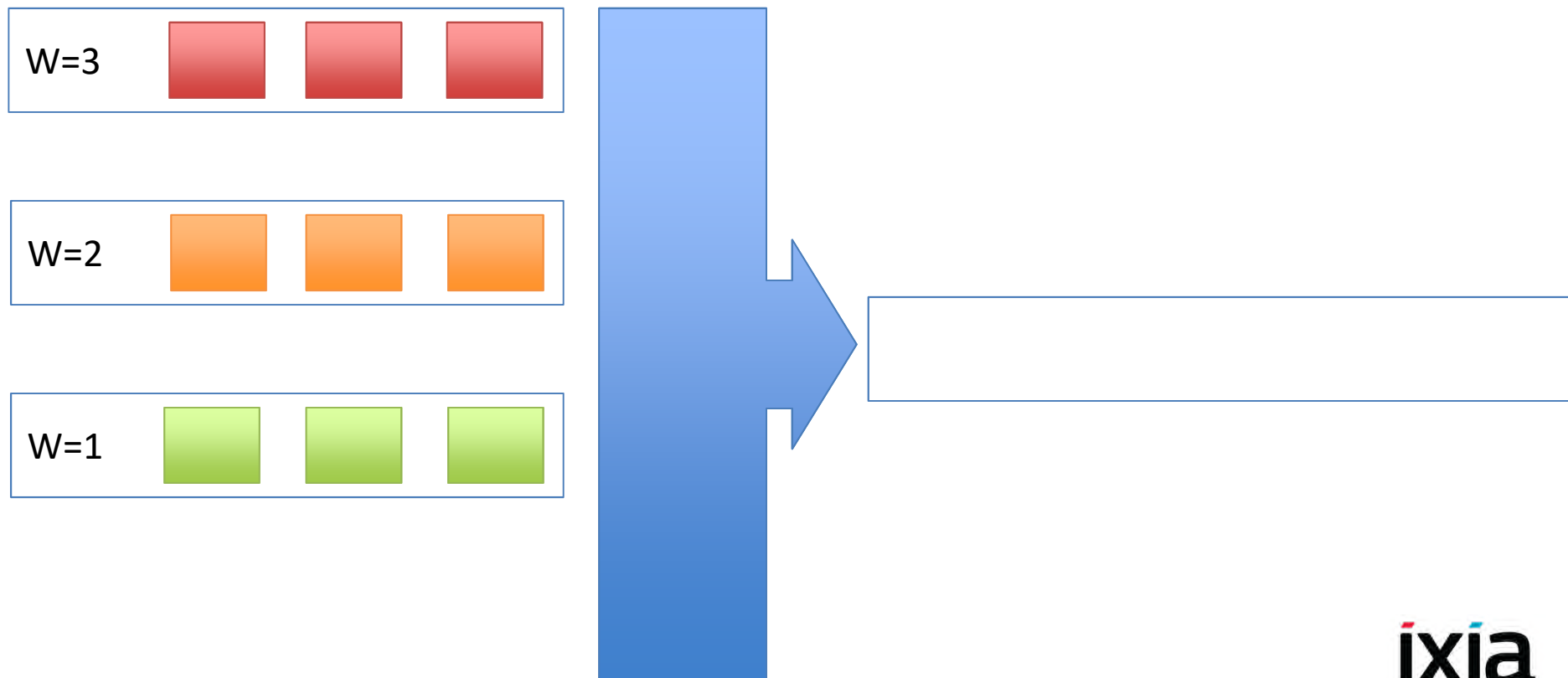

Quality of service with AVB Credit Based Shaper

- AVB divides traffic into multiple (configurable) classes of reserved traffic
- CBS guarantees a maximum bandwidth where stream/class gets priority
 - A stream/class cannot exceed the reserved limit
- Traffic from a class can only be sent when that class has 0 or positive credit, and credit is accumulated when traffic is not sent by that class
 - This has the effect of spacing out packets so as not to create bursts
 - This behavior is also required from well behaved Talker end-nodes
 - Spacing out packets means not starving other classes of traffic

Shaping Per Class

$$\text{Cls BW} = \sum_{stream\ bw=1}^n (\text{Stream BW } n)$$



AVB Credit Based Shaper



Source: Christian Boiger, Deggendorf University of Applied Sciences, IEEE 802 Tutorial
<http://www.ieee802.org/1/files/public/docs2012/tutorial-Deterministic-Ethernet-1112.ppt>

Other things that IEEE AVB brings

- **Automated stream reservation** through MSRP, and thus the possibility to say no
 - Less important for automotive as it generally uses static configuration
- **Common time for all the elements in a system**, so that all Listeners (speakers, screens) can playback the synchronized content
 - Achieved through gPTP, an adapted version of Precision Time Protocol (PTP)
 - gPTP achieves fast synchronization and allows using lower quality oscillators

Classic PTP clock chain using Phase Locked Loops

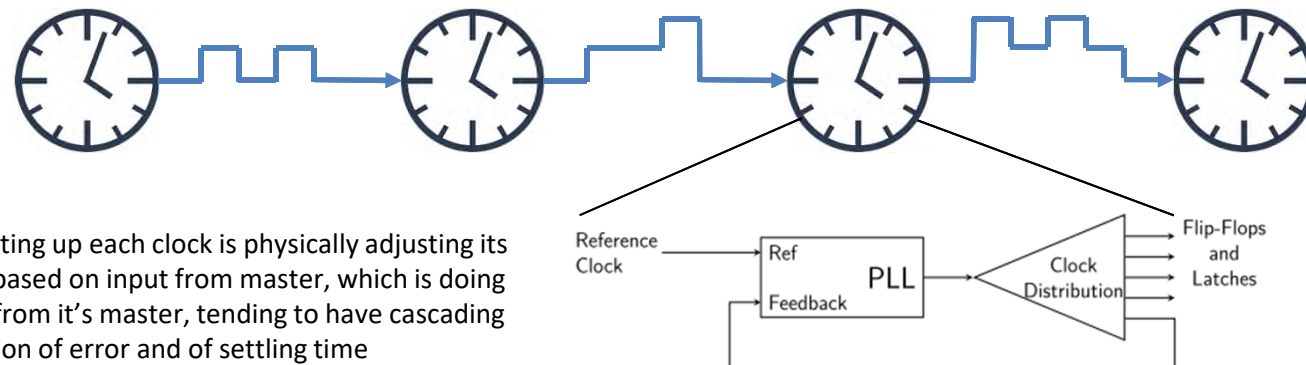

gPTP chain using residence time adjustment and neighbor rate ratio (NRR) measurement

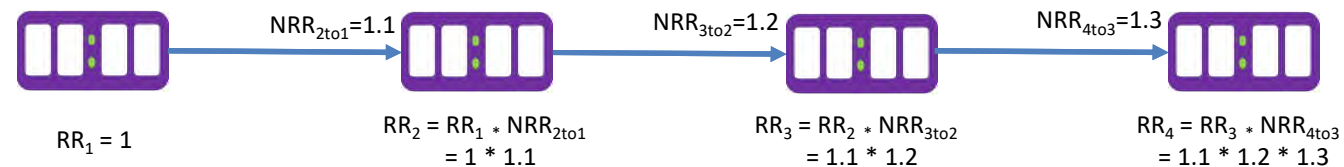

Each clock measures the frequency ratio to its neighbor (NRR) and receives cumulative ratio (RR) to Grandmaster from its master. Global clock is generated from a local clock that is free-running and ratio to Grandmaster mathematically

Tests for classic QoS vs AVB



Chained switches with video (highest), audio (medium) and other traffic (low)

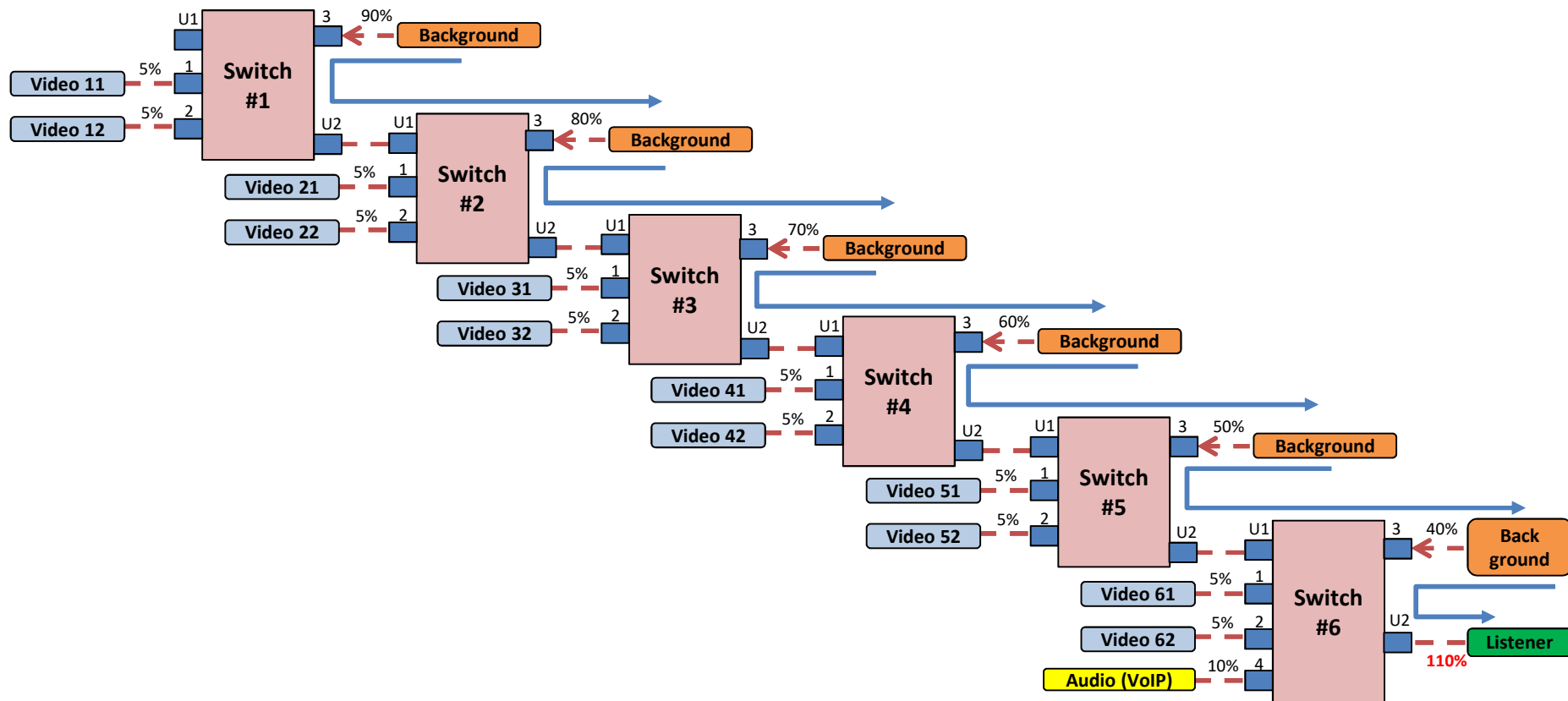

Each video talker takes 5% of the bandwidth

- 1G: 30 fps, 1230 byte packets, 49.9 Mbps
- 10G: 60 fps, 848 byte packets, 499 Mbps

Each “frame” may have a burst of packets

Frames are evenly spaced out for AVB

Speed	Max Packet loss % per stream			Max latency per stream		
	AVB	Strict Priority	WRR	AVB	Strict Priority	WRR
1G	0%	5%	7%	~350 us	~50000 us	~35000 us
10G	0%	0.2%	0.3%	~15 us	~9000 us	~9000 us

Strict Priority issues:

- latency for 2nd priority traffic can be very high
- Burst behavior can cause buffers to overflow and drop packets even when average traffic rate (per second) is within bounds

Weighted Round Robin issues:

- If background traffic is stopped it can cause buffers in switch 1-5 to empty quickly and overflow buffers in switch 6, leading to packet loss

- Strict priority is not fair, and does not work well in many scenarios
 - Only performance of the highest priority is guaranteed
- WFQ max delay depends on interaction between the queues
 - Delay grows as lower priority traffic increases
- QoS can generate bursts rather than spacing packets equally
 - If/when lower priority traffic is stopped →
 - A wave of higher priority traffic washes over the last switch
 - Buffers can overflow leading to high-priority traffic loss
 - This can lead to delays that are beyond the requirements
- AVB traffic is shaped/smoothed, so less susceptible to this effect

As opposed to traditional QoS, **AVB**:

- ✓ guarantees bandwidth and latency for critical streams of different priorities and requirements
- ✓ supports dynamic addition and removal of streams
- ✓ no need to overprovision

and ultimately **delivers high quality audio and video that does not break-up when you least expect it...** like VoIP or video over the Internet

Guaranteed bandwidth & latency



vs.



Packet loss & delays

Tests for classic PTP and gPTP



Initially set out to test:

1. Time synchronization quality

- **Time error: measure the difference between the time on a device and a reference, at the same instant**

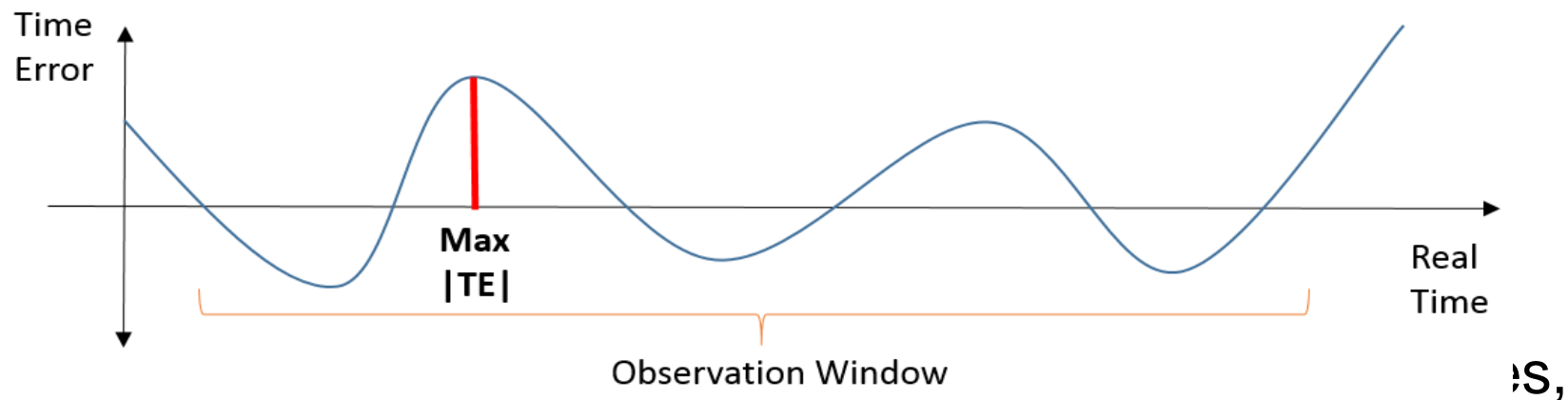

reference is Ixia emulated GM (compare first & last hop)

2. GM fail scenarios / network reconfiguration
3. Comparison with SMPTE 2059-2 broadcast profile

AVB gPTP on same topology classic PTP with Boundary or Transparent Clocks

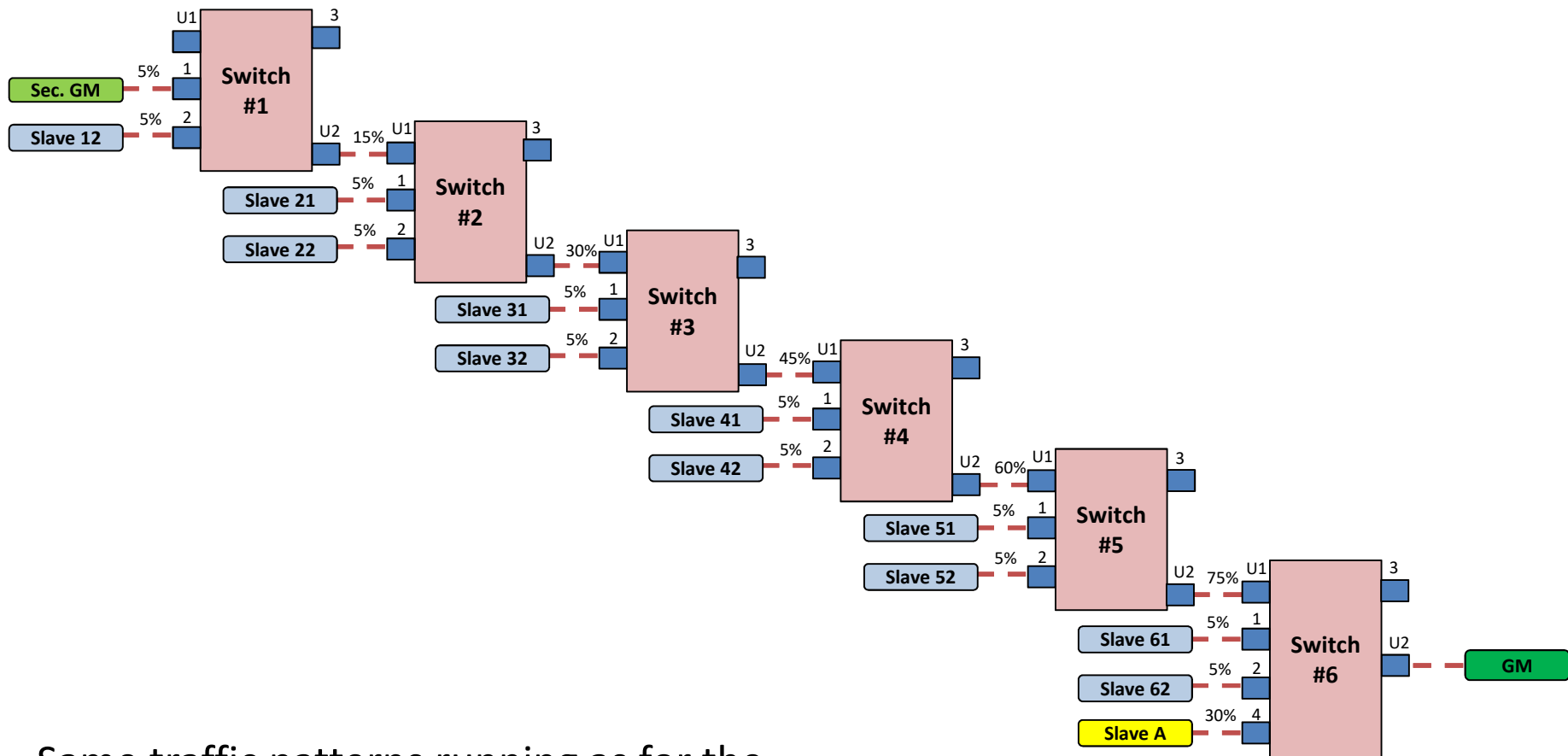

Same traffic patterns running as for the AVB vs Strict Priority vs WRR scenarios. Measure time error at different points along the chain, from the GM.

Classic PTP with Transparent and Boundary Clock and AVB gPTP compared

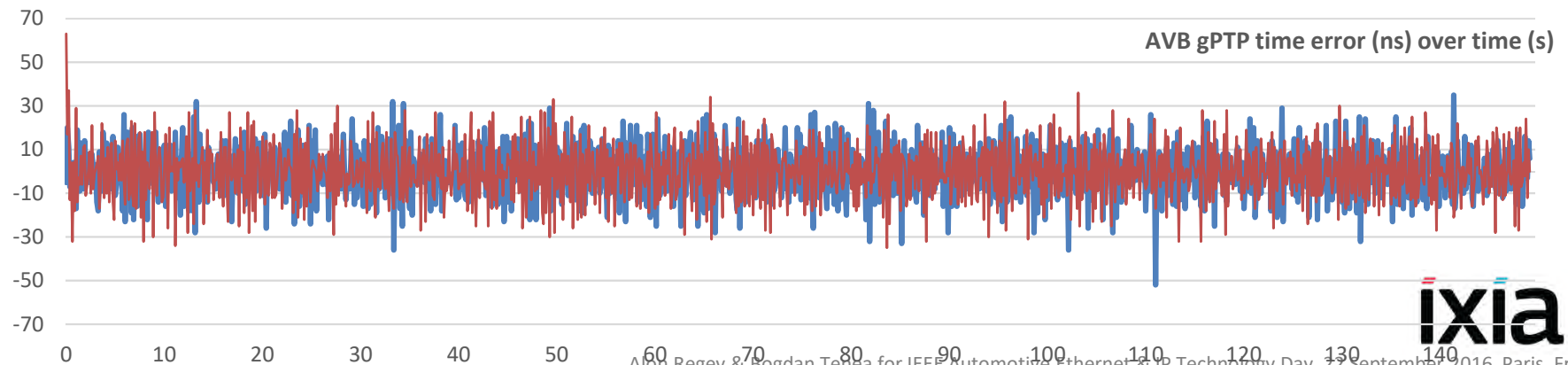
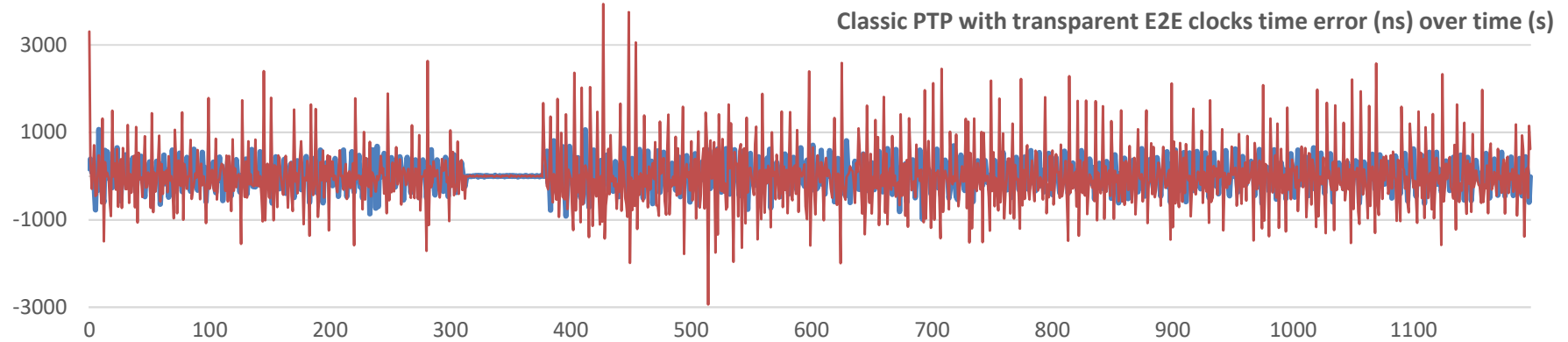
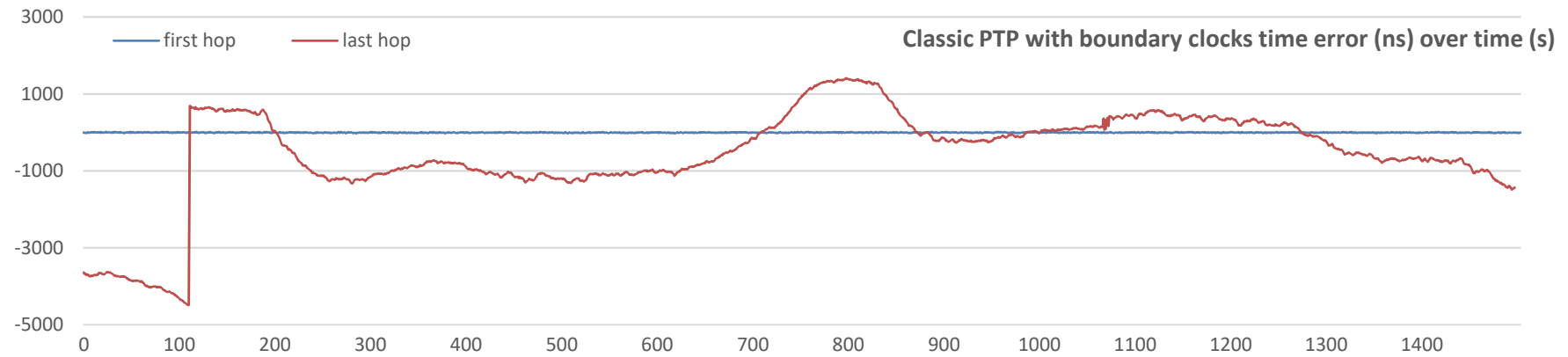

Time sync results and issues

Maximum Time Error	PTP with low volume traffic	PTP with heavy traffic	PTP with Boundary Clocks	PTP with Transparent Clocks	AVB gPTP
1 st hop			24 ns	1 000 ns	35 ns
6 th hop	10 000 ns	2 500 000 ns	4 500 ns	4 000 ns	63 ns

- Classic PTP default profile has unacceptable time errors for audio/video media synchronization, if used without PTP-enabled switches
- gPTP time error is very low, even with 6 hops in between, two orders of magnitude better than PTP with Boundary or Transparent clock support
- Even with PTP enabled switches it might not be enough for large enough networks or for networks with high or varying traffic loads
- gPTP stabilizes and locks to GM in seconds, whereas PTP with Boundary clock was still “locking” after 3+ minutes

As opposed to classic PTP, **gPTP guarantees:**

- a maximum time error over a specified number of hops, that satisfies A/V and even control applications
- fast sync lock time on network startup
- fast reconfiguration on topology changes

and ultimately **allows high quality time synchronization for audio and video such that different media sources are always in sync**