M5300A PXIe RF AWG Modules

Four CH, DC-16 GHz RF, 2 GHz IBW, 14-bits resolution



Notices

© Keysight Technologies 2026

No part of this manual may be reproduced in any form or by any means (including electronic storage and retrieval or translation into a foreign language) without prior agreement and written consent from Keysight Technologies as governed by United States and international copyright laws.

Manual Part Number

M5300-91003

Edition

Edition 1.9, April 2026

Available in electronic format only

Published by

Keysight Technologies, Inc.
1900 Garden of the Gods Road
Colorado Springs, CO 80907 USA

Technology Licenses

The hardware and/or software described in this document are furnished under a license and may be used or copied only in accordance with the terms of such license.

U.S. Government Rights

The Software is “commercial computer software,” as defined by Federal Acquisition Regulation (“FAR”) 2.101. Pursuant to FAR 12.212 and 27.405-3 and Department of Defense FAR Supplement

(“DFARS”) 227.7202, the U.S. government acquires commercial computer software under the same terms by which the software is customarily provided to the public. Accordingly, Keysight provides the Software to U.S. government customers under its standard commercial license, which is embodied in its End User License Agreement (EULA), a copy of which can

be found at:

<http://www.keysight.com/find/sweula>.

The license set forth in the EULA represents the exclusive authority by which the U.S. government may use, modify, distribute, or disclose the Software. The EULA and the license set forth therein, does not require or permit, among other things, that Keysight: (1) Furnish technical information related to commercial computer software or commercial computer software documentation that is not customarily provided to the public; or (2) Relinquish to, or otherwise provide, the government rights in excess of these rights customarily provided to the public to use, modify, reproduce, release, perform, display, or disclose commercial computer software or commercial computer software documentation. No additional government requirements beyond those set forth in the EULA shall apply, except to the extent that those terms, rights, or licenses are explicitly required from all providers of commercial computer software pursuant to the FAR and the DFARS and are set forth specifically in writing elsewhere in the EULA. Keysight shall be under no obligation to update, revise or otherwise modify the Software. With respect to any technical data as defined by FAR 2.101, pursuant to FAR 12.211 and 27.404.2 and DFARS 227.7102, the U.S. government acquires no greater than Limited Rights as defined in FAR 27.401 or DFAR 227.7103-5 (c), as applicable in any technical data.

Warranty

THE MATERIAL CONTAINED IN THIS DOCUMENT IS PROVIDED “AS IS,” AND IS SUBJECT TO BEING CHANGED, WITHOUT NOTICE, IN FUTURE EDITIONS. FURTHER, TO THE MAXIMUM EXTENT PERMITTED BY APPLICABLE LAW, KEYSIGHT DISCLAIMS ALL WARRANTIES, EITHER EXPRESS OR IMPLIED WITH REGARD TO THIS MANUAL AND ANY INFORMATION CONTAINED

HEREIN, INCLUDING BUT NOT LIMITED TO THE IMPLIED WARRANTIES OF MERCHANTABILITY AND FITNESS FOR A PARTICULAR PURPOSE. KEYSIGHT SHALL NOT BE LIABLE FOR ERRORS OR FOR INCIDENTAL OR CONSEQUENTIAL DAMAGES IN CONNECTION WITH THE FURNISHING, USE, OR PERFORMANCE OF THIS DOCUMENT OR ANY INFORMATION CONTAINED HEREIN. SHOULD KEYSIGHT AND THE USER HAVE A SEPARATE WRITTEN AGREEMENT WITH WARRANTY TERMS COVERING THE MATERIAL IN THIS DOCUMENT THAT CONFLICT WITH THESE TERMS, THE WARRANTY TERMS IN THE SEPARATE AGREEMENT WILL CONTROL.

Safety Notices

CAUTION

A CAUTION notice denotes a hazard. It calls attention to an operating procedure, practice, or the like that, if not correctly performed or adhered to, could result in damage to the product or loss of important data. Do not proceed beyond a CAUTION notice until the indicated conditions are fully understood and met.

WARNING

A WARNING notice denotes a hazard. It calls attention to an operating procedure, practice, or the like that, if not correctly performed or adhered to, could result in personal injury or death. Do not proceed beyond a WARNING notice until the indicated conditions are fully understood and met.

Safety Summary

The following general safety precautions must be observed during all phases of operation of this instrument. Failure to comply with these precautions or with specific warnings or operating instructions in the product manuals violates safety standards of design, manufacture, and intended use of the instrument. Keysight Technologies assumes no liability for the customer's failure to comply with these requirements. Product manuals are provided on the Web. Go to www.keysight.com and type in your product number in the Search field at the top of the page.

WARNING

Do not use the device if it is damaged. Contact your Keysight sales representative for replacement of device.

WARNING

Verify that all safety precautions are taken. Make all connections to the unit before applying power. Note the external markings described under “Safety symbols & instrument markings”.

WARNING

Do not operate the device in an explosive atmosphere or wet environments. Do not operate the instrument around flammable gases or fumes, vapor, or wet environments.

WARNING

Do not install substitute parts or perform any unauthorized modification to the product. Return the product to a Keysight Sales and Service Office to ensure that safety features are maintained.

CAUTION

If the device is used in a manner not specified by the manufacturer, the protection provided by the device may be impaired.

CAUTION

Do not attempt to clean the device. If cleaning the card is absolutely necessary, follow the instructions given in “**Cleaning the module**” section of this document.

Refer to **Safety information** on page 81 for module-specific safety considerations.

Environmental Conditions

This instrument is intended for “indoor use” only.







The following table shows the environmental requirements and the corresponding characteristics for the product.

Environmental Requirements	General characteristics
Temperature	Operating condition: 0°C to 40°C Storage condition: -40°C to 70°C
Maximum Relative Humidity (non-condensing)	Type tested, 95% RH up to 40°C, decreases linearly to 40% RH at 45°C
Altitude	Operating condition: Up to 10,000 ft (3048m) Storage condition: Up to 15,000 ft (4572m)
Pollution degree*	Pollution Degree 2

* See table below for Pollution Degree definitions

Pollution Degree	Description
1	No pollution or only dry, non-conductive pollution occurs. The pollution has no influence. Example: A clean room or climate-controlled office environment.
2	Normally only dry non-conductive pollution occurs. Occasionally a temporary conductivity caused by condensation may occur. Example: General indoor environment.
3	Conductive pollution occurs, or dry, non-conductive pollution occurs which becomes conductive due to condensation which is expected. Example: Sheltered outdoor environment.

Safety Symbols & Instrument Markings

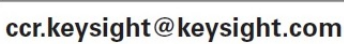
Safety Symbol / Instrument Marking	Description
	<p>The instruction manual symbol. The product is marked with this warning symbol when it is necessary for the user to refer to the instructions in the manual.</p>
	<p>The CE mark is a registered trademark of the European Community.</p>
	<p>The UK mark is a registered trademark of the United Kingdom.</p>
	<p>The RCM mark is a registered trademark of the Australian Communications and Media Authority.</p>
	<p>The KC mark is the Korean certification mark. This equipment is Class A suitable for professional use and is for use in electromagnetic environments outside of the home.</p>
	<p>Electro Static Discharge. Attach ESD protective wrist strap to avoid damage by direct contact with the equipment.</p>
	<p>China Restricted Substance Product Label. The EPUP (environmental protection use period) number in the center indicates the time period during which no hazardous or toxic substances or elements are expected to leak or deteriorate during normal use and generally reflects the expected useful life of the product.</p>
	<p>This is the Keysight email address required by EU directives applicable to our product.</p>

Compliance and Environmental Information

Table 1 Compliance and Environmental Information

Safety Symbol	Description
	<p>The crossed out wheeled bin symbol indicates that separate collection for waste electric and electronic equipment (WEEE) is required, as obligated by the EU DIRECTIVE and other National legislation.</p> <p>Refer to keysight.com/go/takeback to understand your Trade in options with Keysight in addition to product takeback instructions.</p>

Declaration of Conformity

Declarations of Conformity for this product and for the Keysight products may be downloaded from the Web. Go to <http://www.keysight.com/go/conformity>.

You can then search by product number to find the latest Declaration of Conformity.

In This Guide

This guide provides you the information to begin using the M5300A PXIe RF AWG Modules.

- **Chapter 1**, “Overview on M5300A PXIe RF AWG Modules” provides an overview of the M5300A PXIe RF AWG Module hardware and software along with an overview of the applications that enhance the module’s functionality.
- **Chapter 2**, “Setting Up the M5300A Module” describes the precautions and steps you must observe to get started with a newly procured M5300A module.
- **Chapter 3**, “Setting Up the M5300x software” describes the steps to download, install and get started with the M5300x software along with its associated software.
- **Chapter 4**, “Troubleshooting and Safety information” describes few troubleshooting steps along with some safety information you must observe while using the M5300A card and related equipment.

For more information

- For detailed information on how to use the M5300x software and its add-on applications, refer to the *M5300A PXIe RF AWG Modules User Guide*, which is available at <https://www.keysight.com/find/M5300A-TechSupport>.
- For technical assistance, reach out to your local Keysight Technologies representative at <https://www.keysight.com/find/contactus>.

Contents

Safety Summary	3
Safety Symbols & Instrument Markings	5
Compliance and Environmental Information	6
Declaration of Conformity	6
In This Guide	7

1 Overview on M5300A PXIe RF AWG Modules

About This Document	14
About M5300A PXIe RF AWG Modules	15
About License Options for M5300A AWG Modules	18
About Products Supported with M5300A Modules	19
About M5300x Software Features	22
About PathWave FPGA and BSP	23
Using PathWave FPGA	23
Using BSP With PathWave FPGA	23
About KS2201A PathWave Test Sync Executive Software	25
About HVI Technology	25
M5300A Firmware Version Requirements for HVI	26
About HVI Application Programming Interface	26
References to Help Documents	28

2 Setting Up the M5300A Module

Unpacking, Inspecting and Verifying the shipment	30
Precautions against ESD	30
Verifying shipment of M5300A module	31
Inspecting for damage	31
Returning the Module for Service	32
Installing the PXIe Module	33
Before installing the module	33
Preparing the PXIe Chassis	34
Installing the Embedded Controller	35
Connecting a remote controller PC to the chassis	37
Installing Slot Blockers and Filler Panels	38
Installing the Module	38
Powering up the Chassis and Remote Controller PC	39
LED sequence during module turn-on	40
Installing required software	40
Verifying M5300A module's operation	41
Verifying M5300A connection	41
Conducting Self test	43
Cleaning the module	46

3 Setting Up the M5300x software

Prerequisites to setting up M5300x software	48
System requirements	48
Prerequisite software requirements	48
Obtaining License Options	52
Downloading required software	53

Installing required software	54
Installing Keysight M5300x Software	54
Installing M5300A module firmware updates	60
Installing KS2201A PathWave Test Sync Executive SW	61
Installing PathWave FPGA software	62
Installing M5300A BSP	62
Launching the software	63
Launching the M5300x user interface	63
Starting M5300x API	68
Initiating PathWave Test Sync Executive software	69
Launching the PathWave FPGA BSP	70

4 Troubleshooting and Safety information

Issues during installation	74
Issue during installation of SW drivers	74
Issue with one or more M5000 series modules not appearing in NI chassis	74
Issues with Python	77
Installing M5300x Drivers on Python ver. other than 3.7	77
Installing Python after the Instrument Driver	77
Issues with performing updates	78
Issue when performing FW / FPGA updates via the SFP	78
Issue when performing SW version update	78
Issues with PathWave FPGA	79
Module-specific BSPs not installed	79
Xilinx Vivado tool not installed	79
Timing errors during k7z file generation	80
Safety information	81
General safety considerations	81

M5300A PXIe RF AWG Modules

Startup Guide

1. Overview on M5300A PXIe RF AWG Modules

[About This Document](#) / 14

[About M5300A PXIe RF AWG Modules](#) / 15

[About License Options for M5300A AWG Modules](#) / 18

[About Products Supported with M5300A Modules](#) / 19

[About M5300x Software Features](#) / 22

[About PathWave FPGA and BSP](#) / 23

[About KS2201A PathWave Test Sync Executive Software](#) / 25

[References to Help Documents](#) / 28

Section 1.1: About This Document

This document helps you get started with a brief introduction to the M5300A PXIe RF AWG module along with its associated software components. It also serves as a guide for the required preliminary setup followed by procedures to install the Keysight M5300A PXIe Module's SFP and API along with its extended components.

Section 1.2: About M5300A PXIe RF AWG Modules

The M5300A is a dual-slot PXIe module. **Figure 1** shows the front view of an actual physical M5300A module that can be procured.



Figure 1 Front view of an M5300A High-Speed PXIe AWG module

The key specifications of the M5300A module are listed in [Table 2](#). For all other characteristics of the M5300A PXIe RF AWG modules, refer to the *M5000 Series High-Performance PXI System Datasheet*.

Table 2 Key specifications of the M5300A High-Speed PXIe AWG module

Characteristics	Value / Range
RF characteristics	
Frequency range	Up to DC - 12 GHz (with option '012'), or up to DC - 16 GHz
Port match	S22 < -10 dB to 10 GHz S22 < -5 dB to 16 GHz
Performance Characteristics	
Baseband/Information bandwidth	2 GHz
DAC resolution	14-bit
Baseband sample rate, per-channel	4.8 GSa/s (2.4 GSa/s I/Q)
Waveform memory depth, per channel	1 GSa (500 MSa I and 500 MSa Q)
Number of waveforms, per channel	4096
DAC output sample rate	38.4 GSa/s
Minimum waveform length, per channel	64 Samples (I+Q), 13.3 ns
Maximum waveform length, per channel	1 GSamples (I+Q), 223 ms
NCO frequency coverage	0-18 GHz
NCO Frequency resolution	5×10^6 Hz
NCO Phase resolution	84×10^{-9} degrees
Noise floor (NSD)	-157 dBm/Hz
Phase noise	-130 dBc/Hz at 8 GHz, 10 kHz offset -125 dBc/Hz at 16 GHz, 10 kHz offset
Channel to channel isolation	80 dB to 16 GHz

Characteristics	Value / Range
Spurious Free Dynamic Range (SFDR) Excluding harmonics and DAC interleave spurs	-70 dBc to 16 GHz
Spurious Free Dynamic Range (SFDR) Excluding harmonics, including DAC interleave spurs	-55 dBc to 16 GHz
Supported PXle Chassis	M9046A

The input and output flow in the M5300A PXle AWGs is shown in **Figure 2**. It has a System Link I/O connector for synchronization and sequencing. There are four high-speed (0 to 18 GHz) AWG outputs with a DAC running at 19.2 GHz. The module allows you to control eight single-ended signals on the SMB connectors. There are two connectors for 2.4 GHz clkout and 2.4 GHz clk in to create a coherent frequency reference across multiple cards in one or more chassis.

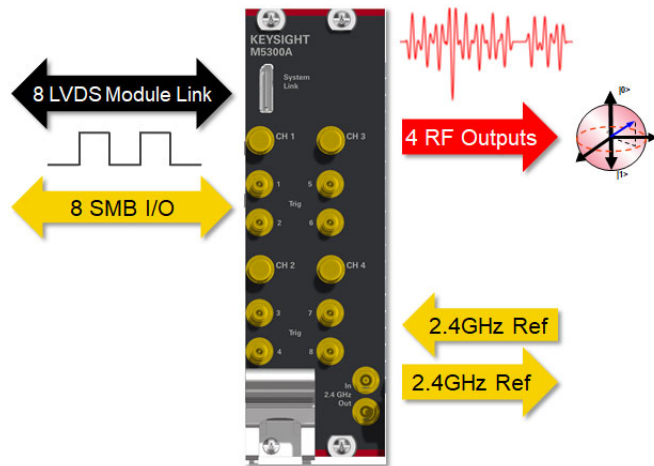

Figure 2 Functional depiction of the M5300A module

CAUTION

Use caution when mating high-density connectors to ensure proper alignment and prevent damage to the contacts.

Section 1.3: About License Options for M5300A AWG Modules

You may enable / limit certain capabilities on the M5300A modules by procuring the following licenses and activating them using the M5300x SW. Refer to the *M5300A PXIe RF AWG Modules User Guide* for more information about configuring the frequency and about the Peer-to-Peer Streaming feature on the M5300A modules.

Table 3 License options for M5300A modules

License option	Description	What it does?
M5300A-012	12 GHz RF Bandwidth Limit Adjustment	Limits bandwidth configuration range from 1 to 12 GHz only.
M5000AU-001	Backplane streaming option for RF AWG	Enables Peer-to-Peer Streaming feature on the M5300A RF AWG module

To procure these licenses, contact Keysight Sales.

To download one or more licenses, visit <https://ksm.software.keysight.com>.

To install the licenses, follow the instructions given in the email that is sent to you with the license attached.

Section 1.4: About Products Supported with M5300A Modules

You require the following (recommended) Keysight products to achieve precision and control when performing measurements. Visit the corresponding product pages on www.keysight.com to procure and refer to the respective documentation to understand how to use these modules/products.

Table 4 List of supported equipment

Required equipment	Recommended Part number(s)
PXIe Digitizer modules	M5200A
PXIe Downconverter modules	M5201A
PXIe Baseband AWG modules	M5301A
PXIe LVDS Digital IO modules	M5302A
System Sync modules	M9032A / M9033A
PXIe Chassis: High-Power, 18-slot, 24 GB/s	M9046A
High-Performance Reference Clock Source	-
Controller options (use one of the following options)	
PXIe High-Performance Embedded Controller	M9037A
External Controller*	(recommended) HP Z8 1FZ80UT#ABA 2.2 GHz Intel Xeon Silver 4114 10-Core (G4 Workstation)
Other accessories	
PXIe 5-channel Source / Measure Unit, 100 pA	M9614A
PXIe 5-channel Precision Source/Measure Unit, 500 kSa/s, 10 pA, 30 V, 500 mA	M9615A
PXIe System Modules and Cable Interface	M902xA
PCIe High-Performance Host Adapter	M9049A
PXI Network Analyzers	M980xA-series
Infiniium UXR-Series Oscilloscope: 16 GHz, 4 Channels	UXR0164A

* You may use any External Controller of your choice. Keysight recommends using the HP

Z8 G4 Workstation to scale up your system for multi-chassis operations.

To connect the HP Z8 G4 workstation as an external controller to the M9046A PXIe chassis, you require the following additional products:

- M9049A PCIe High Performance Host Adapter
- M9023A PXIe High Performance System Module
- Y1201A PCIe cable

NOTE

For information about the recommended BIOS and Windows system settings in the External Controller being used along with one or more M5000-series modules, refer to <http://www.keysight.com/find/PXIAXIePCBIOSandWindowsSettings>.

NOTE

For information about the list of tested PCs and Chassis, refer to <https://www.keysight.com/us/en/assets/7018-02925/technical-overviews/5990-7632.pdf>.

The M5000-series modules require specific Keysight cables that have been customized for connectivity with the M9032x SSM modules and M9046A PXIe high-performance chassis. **Table 5** lists the cables that you may procure for the configuration of a single/multi-chassis multi-system setup.

Table 5 Customized cables for use with M5300A PXIe RF AWG modules

Cable type	Specification	Model number
System Sync/Link	x4-x4, 0.5M	Y1320A
	x4-x4, 1.0M	Y1321A
	x8-2, x4, 0.5M	Y1323A
	x8-2, x4, 1.0M	Y1324A
	x8-x8, 0.5M	Y1326A
	x8-x8, 1.0M	Y1327A
	x8-x8, 2.0M	Y1329A

Cable type	Specification	Model number
MCX(m) to MCX(m)	phase stable, 0.3m	Y1330A
	phase stable, 1.0m	Y1331A
	phase stable, 2.0m	Y1332A
SMA(m)-SMP(f)	0.3m	Y1333A
Cat-5	RJ-45 connectors (to interconnect chassis)	

NOTE

When configuring with the M9046A-QS1 option, all cables must be the same length to ensure proper functioning of the clocking mechanism.

The complexity of your quantum computing system shall determine the quantity of modules and cables that should be procured.

For more information about the cables that you wish to procure, contact Keysight Support.

Section 1.5: About M5300x Software Features

The Keysight M5300x software, which comprises of drivers, programming libraries and Software Front Panel for the M5300A module, provides a comprehensive platform to perform the basic operations pertaining to RF AWG modules. The M5300x software also supports the Hardware FPGA reprogramming, which is done using the PathWave FPGA Board Support Package. Moreover, the M5300x software API is powered by the KS2201A PathWave Test Sync Executive software for performing real-time operations and HVI sequencing.

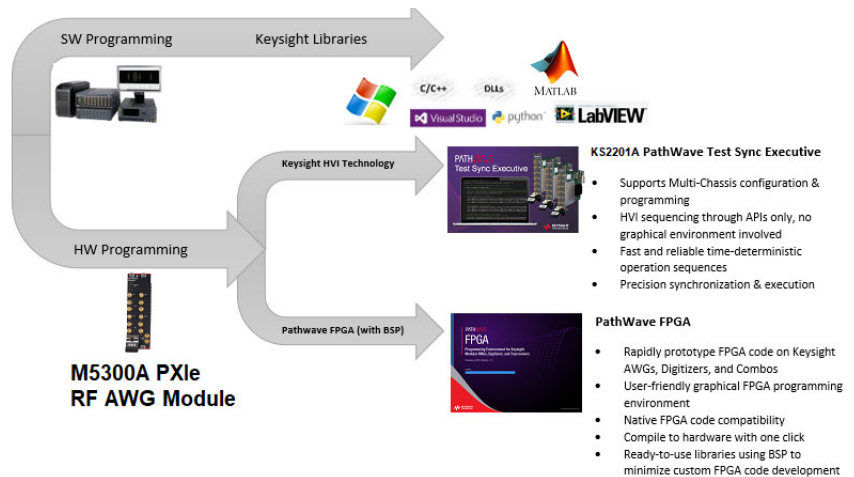

Figure 3 Model depicting the M5300x software capabilities

Section 1.6: About PathWave FPGA and BSP

1.6.1: Using PathWave FPGA

The M5300x software supports the KF9000B PathWave FPGA Programming Environment (commonly known as PathWave FPGA) to program custom logic into the instrument FPGA.

PathWave FPGA provides a complete FPGA design flow from design creation to simulation to GateWare deployment to Hardware/Gateware verification. This environment provides an easy-to-use GUI, where you may create bitstream images targeted to a sandbox in the Keysight FPGA.

Refer to [Downloading required software](#) on page 53 for information about Keysight's landing page for PathWave FPGA software installer. For more information regarding the PathWave FPGA software, refer to the embedded help file or the documentation available on the [KF9000B PathWave FPGA Technical Support](#) page.

NOTE

The KF9000B PathWave FPGA is a licensed software. Contact Keysight Support for more information on procuring the respective licenses.

1.6.2: Using BSP With PathWave FPGA

PathWave FPGA, by itself, does not provide access to any of the controls, which are associated with the Keysight M5300A PXIe modules. You must install the Board Support Package (BSP) to leverage the features within the PathWave FPGA software for your design.

The Board Support Package (BSP) comprises of two parts—an FPGA Support Package (FSP) and a Runtime Support Package (RSP). These are installed separately from PathWave FPGA.

The FSP is that portion of the BSP that allows you to build a bit file for the target FPGA. It is consumed by PathWave FPGA to support design creation and sandbox compilation; everything that is performed without the physical hardware.

The RSP is that portion of the BSP that allows you to control your target FPGA. It provides an API that you can use to download and verify your FPGA bit image. You may use the RSP to load design images onto the hardware and perform simple register and streaming accesses to one or more sandboxes.

The FPGA design consists of two regions: the static region and the sandbox region. The static region for each supported module is defined within BSP and cannot be modified. This region defines the implementation of the FPGA interfaces to external resources, and defines the interfaces to the sandbox. A static region implementation can define one or more sandbox regions in an FPGA design. The sandbox region contains the user specific FPGA design. The interface of the sandbox depends on the static region implementation. A specific design flow is promoted by PathWave FPGA, called Partial Reconfiguration (PR). In a PR flow, a full FPGA reconfiguration is only necessary once for a given static region version. The sandboxes can be reconfigured anytime, without a full reconfiguration, and without stopping the current operation of the FPGA.

To perform FPGA designing, the BSP must be installed on the same machine as the PathWave FPGA software. Both PathWave FPGA software and the BSP function together and cannot be used individually.

To control the front panel IO on the M5300A modules, the M5300x API allows you to control the hardware.

For more information regarding the PathWave FPGA interface available for the Board Support Package corresponding to the M5300A module, refer to the respective help file embedded in the PathWave FPGA software.

Section 1.7: About KS2201A PathWave Test Sync Executive Software

The KS2201A PathWave Test Sync Executive software is a programming environment based on Keysight's Hard Virtual Instrument (HVI) technology, that enables you to develop and execute synchronous real-time operations across multiple instruments. The real-time sequencing and synchronization capabilities of the PathWave Test Sync Executive software make it a powerful tool for *Multi-Input Multi-Output (MIMO)* applications that require tight synchronization and real-time control and feedback in areas such as Quantum Computing.

1.7.1: About HVI Technology

HVI technology enables you to program one or multiple instruments to execute time-deterministic sequences of operations and execute them with precise synchronization. It achieves this by deploying an executable code into each instrument's HW to be executed by the HVI engine or processor included integrated into the instrument. The code executes on these engines in parallel, across multiple instruments. The new user-defined HW operation of the group of instruments is called a Hard Virtual Instrument or just HVI. The sequences of operations or instructions executed by the HVI engines are called HVI sequences. On top of the advantages inherent of the new use model, several other features have been added, such as extended multi-chassis capabilities and expanded product support.

When creating an HVI, you can include any instrument, similar to Keysight's M5300A PXIe RF AWG modules, that have HVI support.

1.7.2: M5300A Firmware Version Requirements for HVI

Table 6 summarizes the M5300x software and firmware versions that are compatible for HVI programming with the most recent version of the KS2201A software.

Table 6 Firmware Version Requirements

Instrument	Drivers, Firmware & Software Page	KS2201A SW version	M5300A SW version*
M5300A	https://www.keysight.com/find/M5300A-Driver	https://www.keysight.com/find/KS2201A-drivers	Visit site for the latest available version.

*Firmware upgrade/downgrade and M5300x software upgrade/downgrade can be performed manually. There is no need to return the module to Keysight.

1.7.3: About HVI Application Programming Interface

The HVI Application Programming Interface (API) is the set of programming classes and methods that allows the user to create and program an HVI instance. Refer to the *KS2201A PathWave Test Sync Executive User Guide* to know more about the HVI Python API.

NOTE

HVI programming is supported with 64-bit Python versions 3.7, 3.8, 3.9, 3.10, 3.11 and 3.12 along with their subversions. Multiple versions are also supported.

HVI core functionality is extended by each instrument with an instrument specific API. The core API is common to all products and only the instrument specific HVI API will change (instrument instructions, actions, events), depending on the products. It is important to differentiate between the core HVI features and the instrument specific extensions, which allow a heterogeneous array of instruments and resources to coexist on a common framework.

The HVI Core API exposes all HVI functions and is a common API for all products. It defines the base interfaces and classes that are used to create an HVI, control the hardware execution flow, and operate with data, triggers, events and actions, but it alone does not include the ability to

control instrument specific operations. The core API defines the hardware virtual instrumentation framework, and it is the job of the product-specific HVI instrument extensions to enable instrument functionalities in an HVI.

When Keysight M5300x is installed on a PXI system, it installs the drivers required to interact with the M5300A modules. Additionally, the graphical environment for the Keysight M5300x SFP provides a visual representation of most of the M5300x API's features.

The M5300x API classes contains HVI add-on API interfaces provided as an extension of the instrument. These add-on interfaces provide access to instrument specific HVI features such as Setting AWG queue waveforms, and so on.

For installation and usage instructions regarding the KS2201A PathWave Test Sync Executive software, refer to the *KS2201A PathWave Test Sync Executive User Guide*.

Section 1.8: References to Help Documents

Table 7 Reference document titles and access links

Document Reference	Filename / Format	Reference location
M5300A PXle RF AWG Modules Startup Guide	PDF	
M5300A PXle RF AWG Modules Security Guide		https://www.keysight.com/find/M5300A-TechSupport
M5300A PXle RF AWG Modules User Guide (including SFP Help)	PDF	
M5300x IVI-C Help	KtM5300x.chm	
M5300x IVI.NET Help	Keysight_KtM5300x_Fx45.chm	Click Start > Keysight M5300x PCIe Module
M5300x HVI Add-on Help	Keysight_KtM5300xHvi_Fx45.chm	or, go to C:\Program Files\Keysight\M5300x\Help
M5300x C++ API Help	index.html	
ktM5300x LabVIEW API Help	KtM5300x_LabVIEW_Help.chm	C:\Program Files\Keysight\M5300x\LABVIEW_DRIVER_HELP
M5300x Python API Help	index.html	Click Start > Keysight M5300x PCIe Module or, go to C:\Program Files\Keysight\M5300x\python\html
M5000-Series PXle Modules Data Sheet	PDF	
M5300A PXle RF AWG module BSP Help	PDF	Help menu of the <i>KF9000B PathWave FPGA</i> design environment
KS2201A PathWave Test Sync Executive User Guide	PDF	KS2201A PathWave Test Sync Executive Document Library
KF9000B PathWave FPGA Customer Documentation	PDF	KF9000B PathWave FPGA Programming Environment Document Library or, Help menu of the <i>KF9000B PathWave FPGA</i> design environment

2. Setting Up the M5300A Module

Unpacking, Inspecting and Verifying the shipment / 30

Installing the PXIe Module / 33

Verifying M5300A module's operation / 41

Cleaning the module / 46

Section 2.1: Unpacking, Inspecting and Verifying the shipment

The module arrives packed in one small box. Before unpacking your module(s), inspect the packaging container for evidence of mishandling during transit. Inspect the carton carefully for any damage, or signs of rough handling.

Remove the M5300A module from the packaging container and ensure that all accessories are included. Inspect the module and accessories for damage. If the contents appear damaged, notify your local Keysight Technologies Inc. representative.

CAUTION

The module is shipped in materials which prevent damage from static. The module should only be removed from the packaging in an anti-static area ensuring that correct anti-static precautions are taken. Store the module in an anti-static envelope when not in use.

2.1.1: Precautions against ESD

Electrostatic discharge (ESD) can damage or destroy electronic components. Use a static-safe workstation to perform all work on electronic assemblies.

CAUTION

Make sure the cables are discharged before connecting them to the module. A momentary connection to a load or short will discharge the cable prior to connecting the cable to the module inputs.

Figure 4 shows a static-safe workstation using two types of ESD protection:

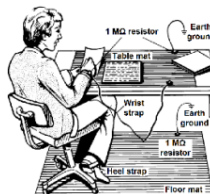

Figure 4 Static-safe workstation for ESD protection

- Conductive table-mat and wrist-strap combination
- Conductive floor-mat and heel-strap combination

Both types, when used together, provide a significant level of ESD protection. Of the two, only the table-mat and wrist-strap combination provides adequate ESD protection when used alone. To ensure user safety, the static-safe accessories must provide at least 1 M Ω of isolation from ground.

WARNING

DO NOT use these techniques for a static-safe workstation when working on circuitry with a voltage potential greater than 500 volts.

2.1.2: Verifying shipment of M5300A module

Table 8 lists the items included in your M5300A module shipment:

Table 8 Verifying M5300A module shipment items

Qty.	Keysight Part number	Description
1	M5300A	Keysight M5300A PXIe RF AWG Module
1	M5300-92000	Keysight M5300A PXIe RF AWG Module Quick Start Guide
1	5972-3335	PXI Modular Product Startup Quick Reference
1	9320-6715	China RoHS Addendum for Modules
1	9320-6797	Keysight safety leaflet

2.1.3: Inspecting for damage

After unpacking an instrument, inspect it for any shipping damage. Report any damage to the shipping agent immediately, as such damage is not covered by the warranty (Refer to the warranty information at beginning of this document).

CAUTION

To avoid damage when handling the M5300A module, do not touch exposed connector pins.

Visit www.keysight.com/find/tips for information on preventing damage to your Keysight equipment.

2.1.4: Returning the Module for Service

If you find it necessary to return the M5300A module for repair or service, follow the steps below:

NOTE

The M5300A is factory tested, aligned, adjusted, and shipped as a single module.

- 1 Review the warranty information shipped with your M5300A module.
- 2 Contact Keysight to obtain a Return Material Authorization (RMA) and return address. For assistance with finding the required contact information, visit www.keysight.com/find/assist.
- 3 Write the following information on a tag and attach it to the malfunctioning equipment:
 - Name and address of the owner. A P.O. box is not acceptable as a return address.
 - Description of failure or service required.
- 4 Pack the instrument in its original packaging. Include all cables. If the original packaging material is not available, use anti-static bubble wrap or packing peanuts. Place the instrument in a sealed container and mark the container "FRAGILE".
- 5 On the shipping label, write ATTENTION REPAIR DEPARTMENT and the RMA number.
- 6 In your correspondence, refer to the module by serial number.

Section 2.2: Installing the PXIe Module

Proceed through this section in the following order:

- 1 Review **Before installing the module** to understand installation guidelines and precautions.
- 2 Prepare the PXIe Chassis for the installation process.
- 3 Install the Controller (embedded or external).
- 4 Install the PXIe Module.
- 5 Install slot blockers and filler panels in the empty PXIe chassis slots.
- 6 Power up the PXIe chassis.

For more information about the appropriate configuration of your single chassis and multi-chassis systems, visit www.keysight.com/find/pxie-multichassis.

2.2.1: Before installing the module

CAUTION

PXIe hardware does not support “hot-swap” (changing modules while power is applied to the chassis) capabilities. Before installing or removing a module to/from the chassis, power down the chassis to prevent damage to the module.

Best practices for cooling chassis and M5300A module

The following are the recommended best practices to ensure proper and safe module operating conditions:

- Ensure that the ambient air temperature around the chassis does not exceed 40°C.
- To maintain proper airflow within the chassis, all empty chassis slots must be fitted with slot blockers (Keysight model **Y1212A**, 5 per kit) and EMC filler panels (Keysight model **Y1213A**, 5 per kit). This includes any empty slots to the left of slot 1.
- Ensure that adequate clearance is provided around all chassis vents, both air intake vents, and air exhaust vents, including any vents at the bottom of the chassis. For more information, refer to the documentation associated with the Chassis you are using.
- Ensure that all the fan filters are clean and unobstructed.

- To the extent possible, install the chassis in a location with lower ambient temperatures. For example, avoid the situation where the exhaust air from another chassis feeds into the air intake for this chassis.
- If you have multiple M5300A modules and space is available in your chassis, leave an empty slot between modules to enhance airflow. Ensure that a slot blocker and a filler panel are installed in the empty slots. Be aware that leaving an empty slot between modules changes the length of inter-module cables, if any, and may also cause the modules to be on different chassis backplane PXI_TRIG trigger bus segments.
- Set the fan speed switch on the chassis such that the module may receive sufficient airflow for adequate cooling. If not, it can result in a thermal shutdown of the M5300A module. Setting the fan speed to the maximum limit ensures maximum cooling with all chassis.

The Keysight Chassis have multiple air intakes. They are located at the lower sides, lower front and bottom of the chassis. Refer to the documentation of the Chassis you are using to know about cooling.

2.2.2: Preparing the PXIe Chassis

- 1 Make sure that the line cord is plugged into a grounded outlet to establish earth ground.



Figure 5 Establishing earth ground to the chassis

- 2 Make sure that the chassis power switch is **Off**.
- 3 Before inserting a module into the chassis, back the mounting screws out to ensure that there is no interference between the screws and the mounting rails.
- 4 Make sure that the PXIe chassis fans are operable and free of dust and other contaminants that may restrict airflow.

2.2.3: Installing the Embedded Controller

Before installing the module, remove plastic thread protectors on the top and bottom of mounting screws. Use the appropriate instructions below for installing the embedded controller or the remote controller.

CAUTION

Do not power up the controller until instructed to do so later in this document.



Figure 6 Front panel view of M9037A Embedded Controller

If your configuration contains a Keysight Embedded Controller (for example, M9037A), follow the procedure below. For additional details, refer to the instructions in the [M9037A Startup Guide](#).

- 1 Remove the M9037A module from its ESD protective bag. See [“Precautions against ESD”](#) on page 30.
- 2 Install the embedded controller in Slot 1 (see the ▲ icon above the slot) in the chassis.

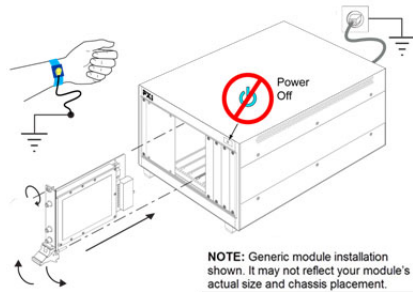

Figure 7 Depiction of installing a PXle embedded controller module

- While holding the module by the injector/ejector handle and making sure the injector/ejector handle is pushed down in the unlatched (downward) position, slide the controller module into chassis, using the slot guides (top and bottom).
 - Sliding the module into position, when you begin to feel resistance, pull up on the injector/ejector handle to fully inject the module into the chassis backplane connectors.
 - Tighten the module retaining screws (top and bottom) and torque them to 5 Lb-In (0.57 N-m).
- 3 Install a blank Y1213A filler panel in the empty slot to the left of the controller.
 - 4 Connect peripherals (mouse, keyboard, and monitor).

2.2.4: Connecting a remote controller PC to the chassis

A remote controller is an external, Windows-based PC that connects to the chassis through a PCIe cable. The remote controller can be a desktop PC, a laptop PC, or a rack-mounted PC. If your configuration contains a Keysight Cable Interface module, follow the procedure below.

NOTE

The following procedure addresses using a cabled PCIe interface between the chassis and an external host computer. However, if you intend to use a system module to control a subordinate downstream chassis or RAID configuration:

1. Install the module in an x8 hybrid slot in the PXIe chassis.
2. Reverse the switch settings from those noted in this procedure: On the module, set both the S301 switches to “Host” and set the S201 rocker switch to the left-hand position. On the chassis backplane, set the controller slot power-supply switch to the left.

-
- 1 Locate slot 1 in the chassis, with the ▲ icon above the slot.
 - 2 Set the chassis controller slot power supply switch to the right-hand position. This provides power to slot 1 for the benefit of the PCIe interface card.
 - 3 Remove the interface module from its protect bag. See “[Precautions against ESD](#)” on page 30.
 - 4 On the module, set both S301 switches to the Host (right-hand) position and set the S201 rocker switch to the left-hand position.
 - 5 Install the Cable Interface module into the chassis:
 - While holding the module by the injector/ejector handle and making sure the injector/ejector handle is pushed down in the unlatched (downward) position, slide the module into chassis, using the slot guides (top and bottom).
 - Sliding the module into position, when you begin to feel resistance, pull up on the injector/ejector handle to fully inject the module into the chassis backplane connectors.
 - Tighten the module retaining screws (top and bottom) and torque them to 5 Lb-In (0.57 N-m).
 - 6 Connect the Interface module to your laptop or desktop PC.

2.2.5: Installing Slot Blockers and Filler Panels

To assure proper operating temperatures, install slot blockers (Keysight model **Y1212A**, 5 per kit) and EMC filler panels (Keysight model **Y1213A**, 5 per kit) in empty module slots.

2.2.6: Installing the Module

Plan your module position. Before installing the module, remove plastic thread protectors on the top and bottom of mounting screws. Install the left-most module first and continue installing modules from left to right, similar to installing the embedded controller, as shown in [Figure 7](#). Also, [Figure 8](#) illustrates an x-ray view of the direction and position of the module inside the chassis during insertion.

When installing the M5300A module:

- 1 Hold the module by the injector/ejector handle and make sure that the injector/ejector handle is pushed down in the unlatched (downward) position. Slide the module into chassis, using the slot guides (top and bottom).
- 2 Slide the module into position. When you begin to feel resistance, pull up the injector/ejector handle to fully inject the module into the chassis backplane connectors.
- 3 Tighten the module retaining screws (top and bottom) and torque them to 5 Lb-In (0.57 N-m).

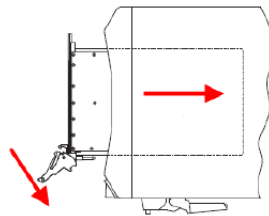

Figure 8 X-ray illustration of installing a PXIe module

NOTE

The images above shows generic module installation. It may not reflect your module's actual size and chassis placement.

2.2.7: Powering up the Chassis and Remote Controller PC

When powering up the system, the chassis should be powered up first. After powering up the chassis, you should wait at least three seconds before powering on the PC. The chassis front panel temperature LED, which is on for three seconds after the chassis is powered up, provides a convenient way to measure this delay.

- 1 Make sure that the line cord is plugged into a grounded outlet to establish earth ground.

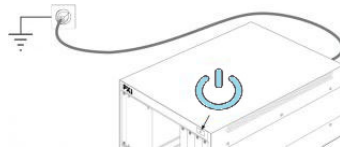

Figure 9 Establishing earth ground to the chassis

- 2 Make sure all cable connections are secure and modules/controller inserted properly.
- 3 Press the power button on the chassis.

CAUTION

If you are using a remote controller and you have installed the interface cable, you must power up the chassis before you power up the PC. When you power down your chassis, shut down the PC before you power down the chassis.

The temperature LED, which is on for the first three seconds after the chassis is powered up, can be used as an indicator of when to power on the PC. When the LED goes off, the PC can be powered on.

- 4 Power on the PC.

CAUTION

PXle hardware does not support “hot-swap” (changing modules while power is applied to the chassis) capabilities. Before installing or removing a module to/from the chassis, power down the chassis to prevent damage to the module.

The PC should be shut down before the chassis is powered down. This will prevent the chassis, as it's being powered down, from disrupting operation of the PC.

In brief, the PC should be off whenever the chassis is powered up or down. Because chassis modules are not hot-swappable, chassis modules should only be added or removed when the chassis is powered down. The power sequence described above doesn't apply to an embedded controller installed in the chassis because the embedded controller and chassis are powered together.

2.2.8: LED sequence during module turn-on

Following is the LED color sequence seen on the M5300A module when it is powering on. The LED is off, if the module is powered off or if the FPGA has not loaded yet.

- Turns Blue when the FPGA is loaded.
- Turns Green when the module driver connects.
- If the FPGA overheats and turns off, the LED switches off (this is the only option in this case).
- Changes from Green to Blue when module driver disconnects.

2.2.9: Installing required software

After the PC boots up and Windows desktop appears, you must install the software required for programming the M5300A modules. See [Chapter 3](#), "Setting Up the M5300x software".

Section 2.3: Verifying M5300A module's operation

The operation of the M5300A module must be verified after you ensure that all required software is installed, the chassis is powered on, and all cabling is correct.

2.3.1: Verifying M5300A connection

The Keysight Connection Expert (installed with IO Libraries Suite) helps you check the connection of the M5300A PXIe RF AWG modules. To check if the module and its slot location are visible in the Keysight Connection Expert, click **Start > Keysight Connection Expert**.

As shown in [Figure 10](#), the connected instruments are visible in the Connection Expert, including one or more M5300A modules in their respective slots.

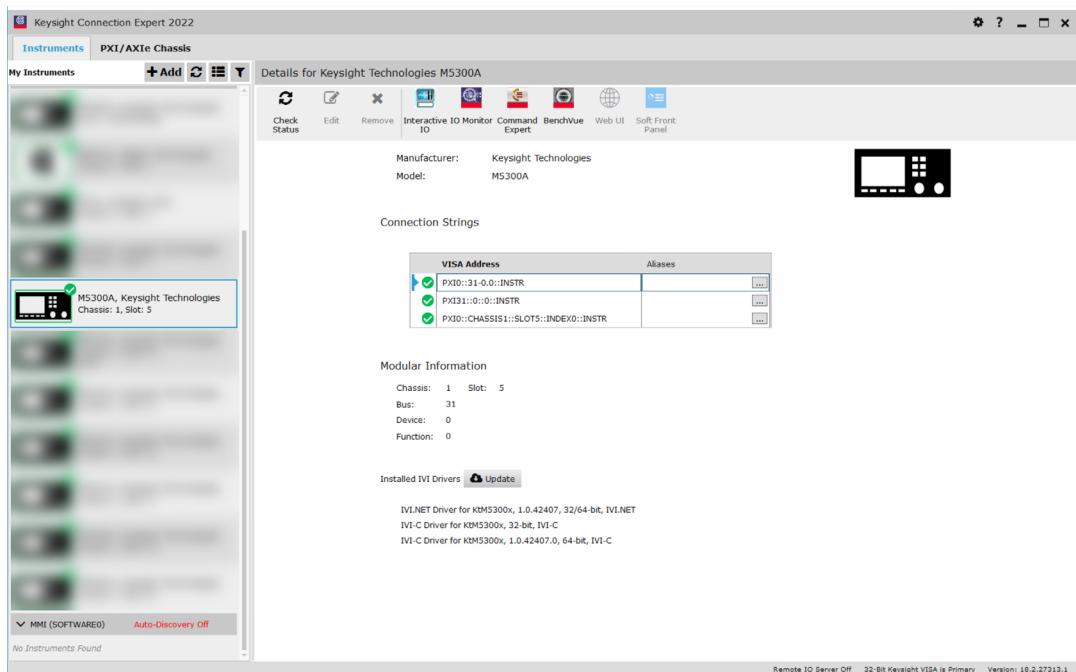



Figure 10 Checking M5300A module connection in Connection Expert

If any or all modules and their slot locations are still not visible in Connection Expert, click the  icon to scan.

You may also launch the M5300x Soft Front Panel (SFP) software to check the M5300A module connection status.

Click **Start > Keysight M5300x PCIe Module > M5300x SFP (x64)**.

The “Connect to Instrument” window appears by default and if connected, it displays the M5300A modules along with the respective slots and VISA address.

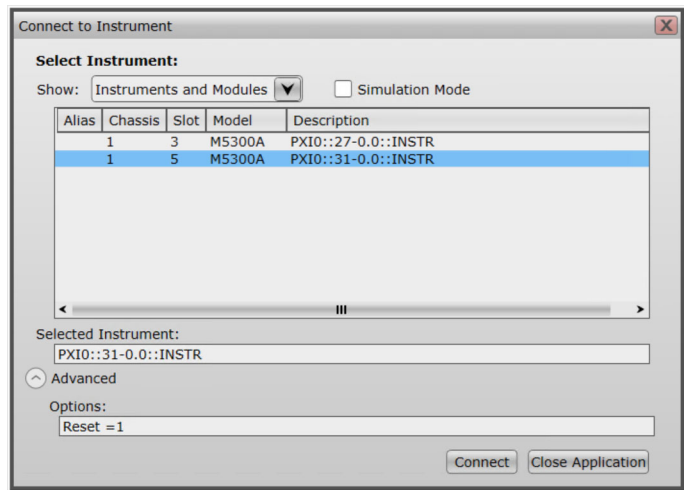

Figure 11 Checking M5300A connection in M5300x SFP

If you are still unable to communicate with the M5300A modules, verify that the following software and hardware has been correctly installed:

- Keysight IO Libraries Suite
- M5300x SFP (x64)
- Module and chassis drivers
- System Interface Card, cable and PC PCIe card connections, if you are using an external host PC

2.3.2: Conducting Self test

The next step in this process is to conduct a Self Test of the M5300A module.

- 1 Click **Start > Keysight M5300x PCIe Module > M5300x SFP (x64)** to launch the M5300x SFP.
- 2 On the **Connect to Instrument** window that appears, select the M5300A module you wish to run the self test on, and click **Connect**.

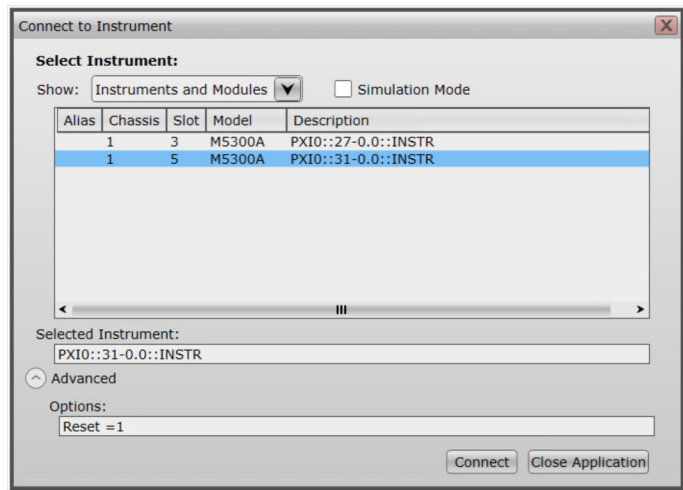

Figure 12 Viewing module connections in M5300x SFP

NOTE

If the module and its slot location is not visible in the “Connect to Instrument” dialog box, close the SFP and perform the steps described in the “Verifying M5300A connection” section. After running Keysight Connection Expert, you may restart the SFP.

- 3 From the main menu of the M5300x SFP, click **Utilities > Self Test...**

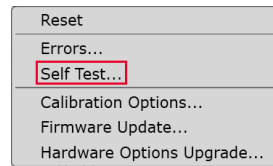

Figure 13 Viewing module connections in M5300x SFP

- 4 On the **Self Test** window that appears, click **Run Self Test**.

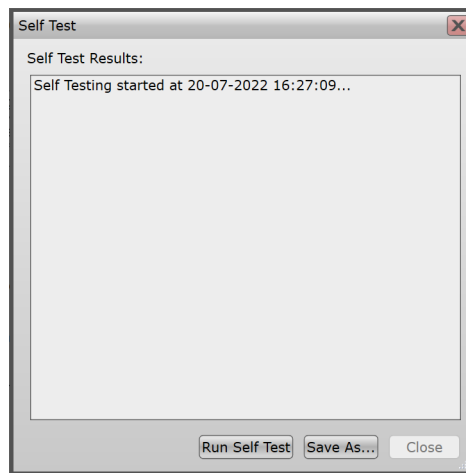

Figure 14 Starting Self test on the selected M5300A module

If the self test is successful, the Self Test window appears as shown below.

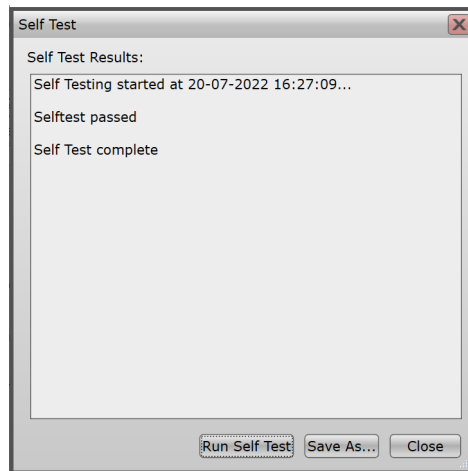

Figure 15 Self test passed status on the selected M5300A module

5 Click **Close** to exit the **Self Test** window.

If the Self Test fails, it indicates that the module likely needs service. In such cases, you must return the faulty module. Refer to [“Returning the Module for Service”](#) on page 32.

Section 2.4: Cleaning the module

WARNING

Do not attempt to clean the card. If cleaning is absolutely necessary, to prevent electrical shock, disconnect the power cord from the mains before removing the modules from the chassis.

- 1 Power off the chassis and remove the M5300A module.
- 2 Use either a dry lint free cloth, or compressed air to clean the front plate (face-plate) only of the M5300A module.
- 3 If a damp cloth is used, or if there is condensation from the compressed air, make sure that the card is completely dry before reinserting the card into the chassis.

3. Setting Up the M5300x software

[Prerequisites to setting up M5300x software](#) / 48

[Obtaining License Options](#) / 52

[Downloading required software](#) / 53

[Installing required software](#) / 54

[Launching the software](#) / 63

Section 3.1: Prerequisites to setting up M5300x software

3.1.1: System requirements

- Windows 10 (x64 bit) / Windows 11 (x64 bit)

3.1.2: Prerequisite software requirements

Table 9 Software to be installed prior to M5300x SW

S. No.	Prerequisite software name (click to navigate)	License (Free / Procured)
1	Keysight IO Libraries Suite 2018 (version 18.1.23218 or later)	Free
2	M9046A PXIe Chassis Drivers	Free
3	Xilinx Vivado Design Suite (2017.3 or later)	Refer to PathWave FPGA Customer Documentation for installation and licensing information
4*	Python 64-bit version 3.7, 3.8, 3.9, 3.10, 3.11 and 3.12 along with their subversions. Multiple versions are also supported.	-
5*	(optional) Any C# / .NET compiler	-
6*	(optional) Any C / C++ compiler	-

*Install this programming interface only if it meets your requirements.

** See the section "Instructions for Python users".

NOTE

Prior to installing any other software/drivers, Keysight recommends installing the IO Libraries Suite whose IO Control Bundle comprises of several elements that support the module drivers.

General installation steps for prerequisite software

Perform these steps for installing the software in the sequence shown in [Table 9](#).

- 1 On the Technical Support page, click the “Download” button and save the installer.
- 2 Run the downloaded installer.
- 3 Follow the on-screen instructions.

For PXIe Chassis drivers and firmware

- 1 When installing the Keysight Chassis Family Driver, PXIe Chassis SFP (Software Front Panel) software is automatically installed.
 - Chassis firmware version can be checked and updated using PXIe Chassis SFP.
- 2 For any other chassis model being used, Keysight recommends installing the required firmware version and its compatible chassis driver separately.

Instructions for Python users

- 1 Double-click the Python installer, which you have downloaded on your local machine.

The Python Setup window appears.



Figure 16 Initial Python Setup window

- 2 Make sure that both options “Install launcher for all users (recommended)” and “Add Python 3.7 to PATH” are checked. By default, the check box for the former option is selected and it is clear for the latter option.
- 3 Click “Install Now” to install the required Python libraries.

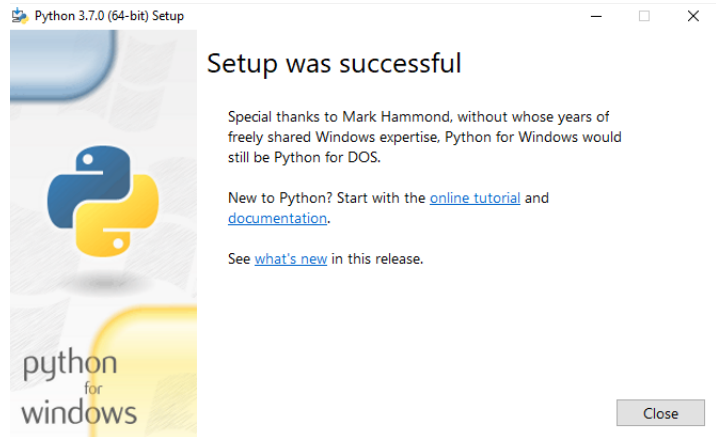

Figure 17 Final Python Setup window

- 4 On the final window pertaining to Python Setup, click “Close” to exit.
- 5 To verify if the Python installation is successful,
 - a Launch the command prompt.
 - b On the root directory, type *python* and press <Enter>. See Figure 18.

The version information of the current Python installation is displayed.

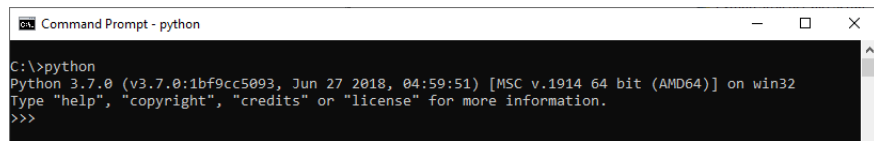

Figure 18 Python installation verification on command prompt window

- c Ensure that Python has been added to the 'PATH' in 'System Variables'. If it does not appear, you must manually add an entry.

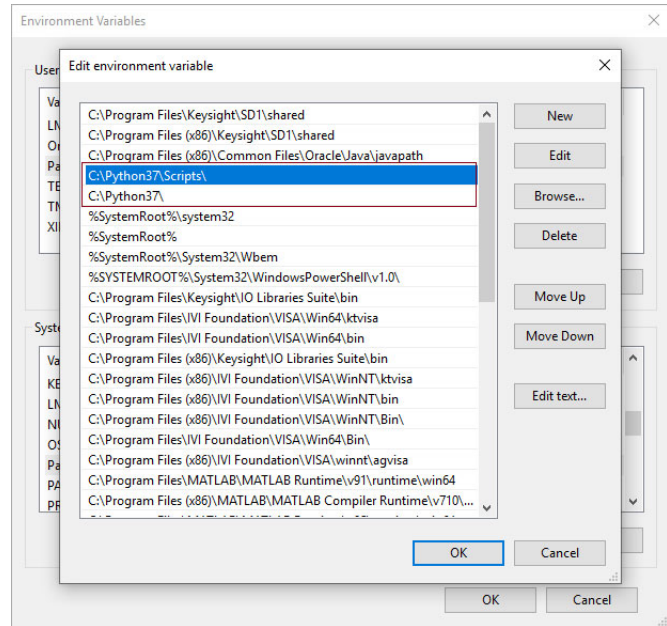

Figure 19 Verifying addition of Python to PATH environment variable

- 6 On the command prompt window shown in [Figure 18](#), you may optionally enter the following commands to install the 'NumPy', 'SciPy' and 'Matplotlib' libraries:

- `python -m pip install numpy`
- `python -m pip install scipy`
- `python -m pip install matplotlib`

After each library is installed, you should see a message "Successfully installed...". If you encounter any error, exit the command prompt window and launch a new one to repeat steps 5b and 6.

The procedure for downloading and installing the M5300x software, Module firmware, PathWave FPGA Board Support Package and KS2201A PathWave Test Sync Executive software are described further in this chapter.

Section 3.2: Obtaining License Options

Keysight M5300x software does not require any license to be installed. However, the software used with M5300x software require specific license options that you must procure. Visit the respective product page on www.keysight.com for pricing details and purchasing Keysight products.

Table 10 Software License Options required for supported Software (other than M5300x)

Software	License option
KS2201A PathWave Test Sync Executive software	<i>KS2201A PathWave Test Sync Executive User Manual</i>
KF9000B PathWave FPGA	<i>PathWave FPGA Customer Documentation</i>
Xilinx Vivado Design Suite (2017.3 or later)	

Section 3.3: Downloading required software

The following list points to the web pages on Keysight website, where you can download the respective software installer files from. Install each software in the sequence shown in [Table 11](#). Prior to installing one or more of these software files, you must have installed the software listed under the section, “[Prerequisite software requirements](#)” on page 48.

Table 11 Required software and installer pages

Sequence	Prerequisite software	Web Page to download installer from
1	Keysight M5300x software	Click here to visit page.
2	KS2201A PathWave Test Sync Executive software	Click here to visit page.
3	KF9000B PathWave FPGA Programming Environment	Click here to visit page.

Section 3.4: Installing required software

The following sections show installation procedure for each software in the sequence listed in [Table 11](#). Before you begin installing the M5300x software, you must ensure that all other software listed in “[Prerequisite software requirements](#)” on page 48 are installed on the same machine.

3.4.1: Installing Keysight M5300x Software

- 1 After you have downloaded the executable file from Keysight.com, double-click the installer for M5300x Software.

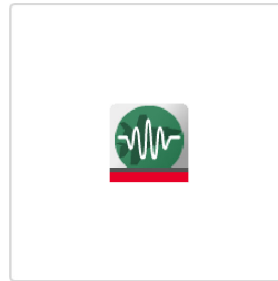

M5300xSetup1.9.10149.0_win

Figure 20 Icon for the M5300x software installers

The Welcome screen on the M5300x Setup Wizard appears.

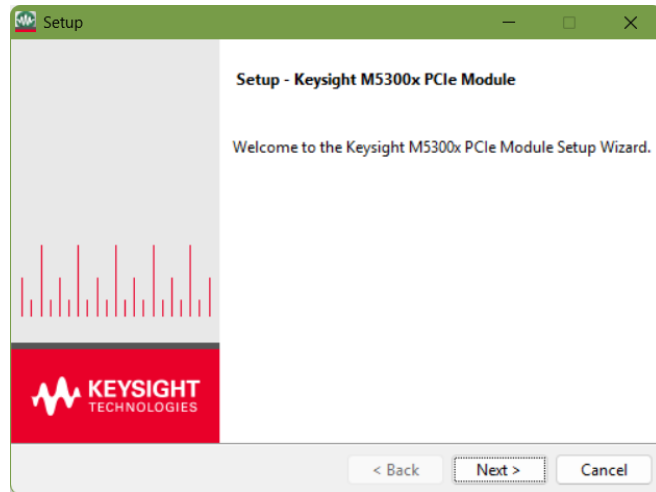

Figure 21 Welcome window on the M5300x Setup Wizard

- 2 Click **Next >**. The terms of the License Agreement are displayed.

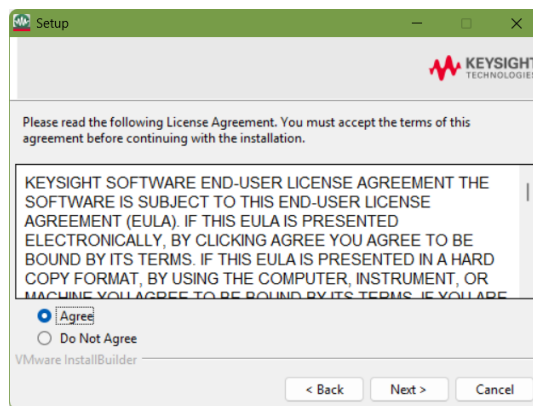

Figure 22 License Agreement window on the M5300x Setup Wizard

- 3 Select **Agree** to proceed.
- 4 Click **Next >**.

Based on your preferences, the Setup window displays various components of the M5300x SW that you may select to install or clear to refrain from installation. Clearing components from installation helps you save disk storage space on your machine. Selecting / clearing one or more entries is optional.

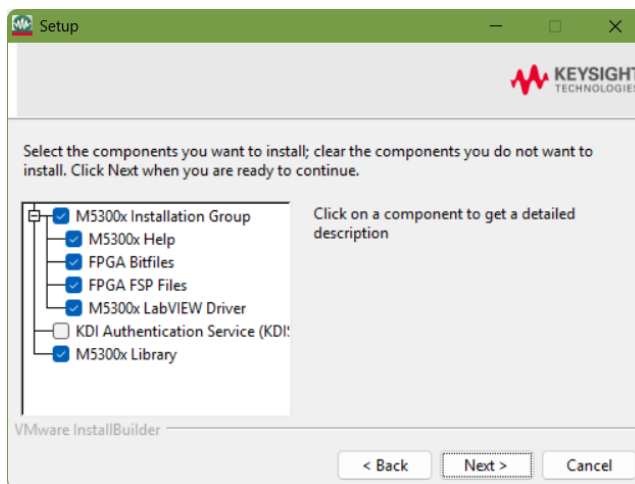

Figure 23 Selecting / clearing components during M5300x SW installation

By default, all components but KDIS Authentication Service are selected.

If you wish to set your machine as the KDIS root node, select the “KDIS Authentication Service” component. For more information about Keysight Distributed Infrastructure Service (KDIS), refer to the *M5300A PXIe RF AWG Modules User Guide*.

- 5 Click **Next >**. The Setup window informs you that the wizard is ready to begin installation of the M5300x SW drivers.

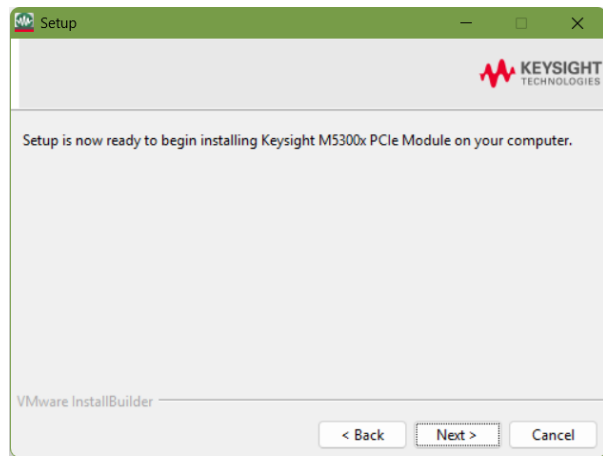

Figure 24 Information displayed on the M5300x Setup Wizard

6 Click **Next >**. A progress bar appears indicating the installation status.

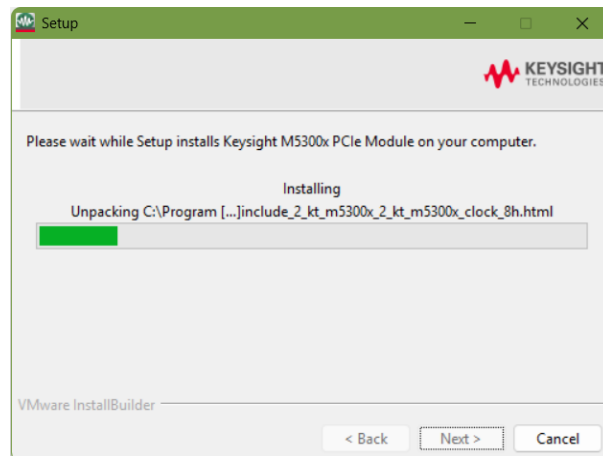

Figure 25 Progress bar on the M5300x Setup Wizard

The completion window on the M5300x Setup Wizard is displayed.

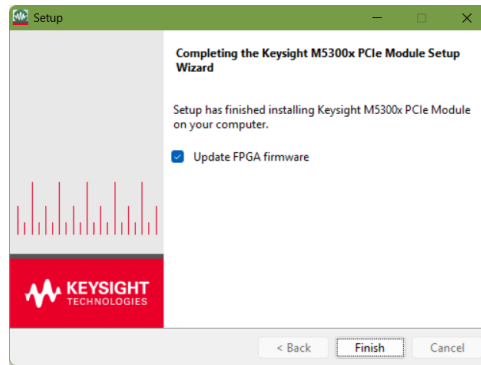

Figure 26 Completion window on the M5300x Setup Wizard

Note that the final window displays an option, which is enabled by default, to **Update FPGA firmware**. Perform one of the following steps:

- i With the **Update FPGA firmware** enabled, click **Finish** to complete the software installation, to exit the M5300x Setup Wizard and to allow the installer to proceed with updating the FPGA firmware revision on the M5300A modules.

The following prompt is displayed during FPGA firmware update.

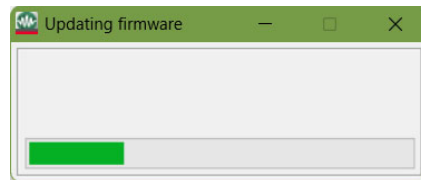

Figure 27 Updating firmware prompt in the M5300x Setup Wizard

- ii Clear the **Update FPGA firmware** check box, click **Finish** to complete the software installation and exit the M5300x Setup Wizard

Obtaining DLL files

To obtain the DLL files, do the following:

- 1 Install the M5300x software version 1.9 or later.
- 2 Navigate to `C:\ProgramData\Keysight\NuGetPackages`.

- 3 Convert the module's .nupkg file to .zip.
- 4 Extract the contents of the .zip file in the same location.
- 5 You can find the DLL at the following path: *C:\ProgramData\Keysight\NugetPackages\Keysight.KtM5300x.1.9.xxxx\lib\net8.0-windows7.0.*

3.4.2: Installing M5300A module firmware updates

Prerequisite

The Keysight M5300x software must be installed to update your module firmware.

Downloading the Firmware

The latest firmware for the M5300A module is included in the Keysight M5300x software package.

Modifying the Firmware

To update the FPGA firmware, you may follow the steps defined in the previous section.

Based on your programming requirements, you may either upgrade or downgrade the Firmware version on an M5300A module, using the SW driver APIs or the M5300x SFP. The APIs to perform firmware update are defined in the Online Help of the respective programming language you may be using. The steps to perform firmware update using the SFP are given below.

- 1 Launch the Keysight M5300x SFP software from the **Start** menu.
- 2 From the main menu of the M5300x software, click **Utilities > Firmware Update...**

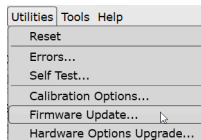

Figure 28 Accessing Firmware Update option in SFP

NOTE

Currently, the firmware version on the M5300A modules is up-to-date. The next firmware version will be available in the next release of the M5300x software.

3.4.3: Installing KS2201A PathWave Test Sync Executive SW

Note that the KS2201A PathWave Test Sync Executive software is not a standalone software. It enhances the Keysight M5300x API to support HVI technology by adding the DLLs required for programming libraries. Therefore, the Keysight M5300x software must already be installed on the same machine.

Refer to the *KS2201A PathWave Test Sync Executive User Manual* available at [KS2201A PathWave Test Sync Executive Technical Support](#) page for installation instructions and to know about the licenses that you must procure for the KS2201A PathWave Test Sync Executive software.

3.4.4: Installing PathWave FPGA software

NOTE

The KF9000B PathWave FPGA 2022 is a licensed software for FPGA programming using module-specific BSPs and for programming with M5300x software. Contact Keysight Support for more information on procuring the respective licenses.

For instructions on installing the KF9000B PathWave FPGA 2022 software on your machine, refer to the *PathWave FPGA 2022 User Guide* available at the [KF9000B PathWave FPGA Technical Support](#) page.

3.4.5: Installing M5300A BSP

The latest BSP file required to design the M5300A module's FPGA is included in the Keysight M5300x software package. There is no separate BSP installer for M5300A modules.

The M5300A BSP can be accessed only within the PathWave FPGA Design Environment and not separately. The PathWave FPGA 2020 software (along with *Xilinx Vivado Design Suite*) must be installed on the same machine as the M5300x software.

Also, see "[Xilinx Vivado tool not installed](#)" on page 79 and "[Timing errors during k7z file generation](#)" on page 80.

Section 3.5: Launching the software

3.5.1: Launching the M5300x user interface

Once you have installed the Keysight M5300x software, you can launch the Soft Front Panel (SFP) from the **Start** menu.

- 1 On your Windows OS, click **Start** > **Keysight M5300x PCIe Module** > **M5300x SFP (x64)**.

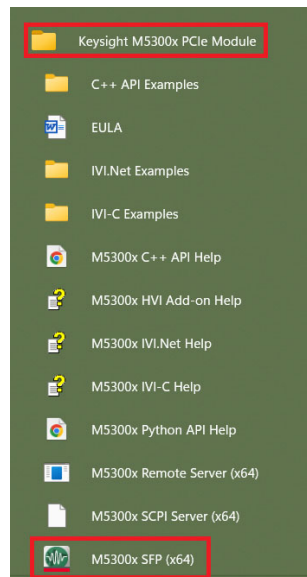

Figure 29 Launching SFP from the Start Menu

The Connect to Instrument window is displayed, as shown in [Figure 30](#) and [Figure 31](#).

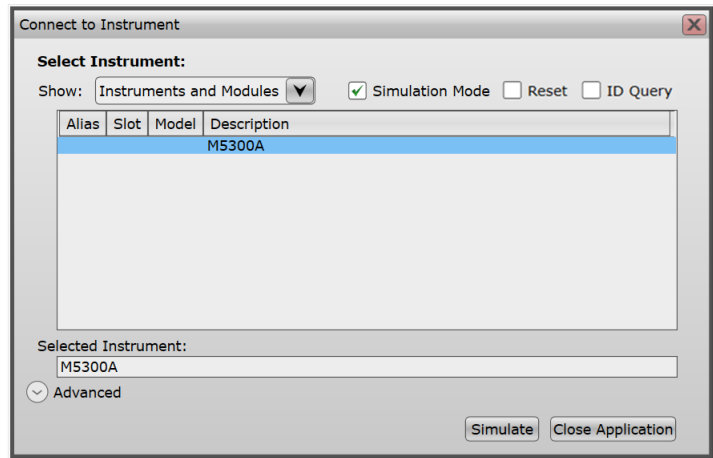

Figure 30 Default window without any active cards

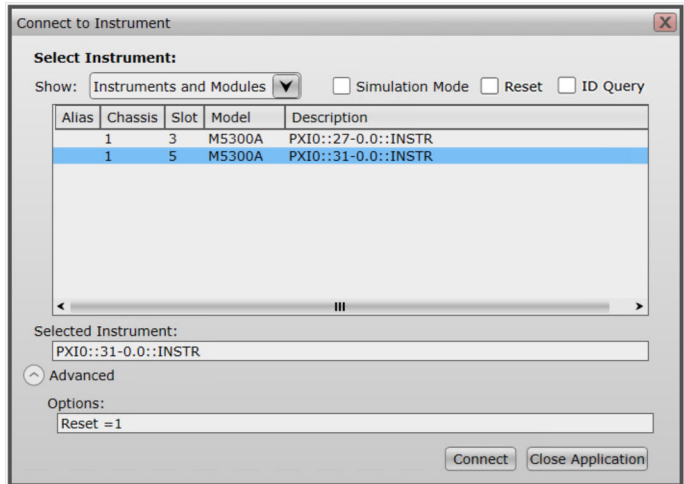

Figure 31 Default window with active cards

As shown in [Figure 31](#), while launching, the Keysight M5300x software auto-detects any active M5300A cards that are connected to the chassis. All such cards are displayed along with the chassis, slot number and VISA address on the **Connect to Instrument** window.

There are two modes that the M5300x SFP can be operated in.

- ‘Simulation mode’ enabled—This is the default mode of SFP operation. The **Simulation Mode** check box is selected by default and the **Simulate** button is displayed on the window. This mode is used for offline SFP operations. In this mode, even if you select an active module (which is connected to a chassis in powered on state), toggling the SFP controls does not affect the signal state on the module. The status bar on the main window shows ‘Simulation Mode’, as shown in [Figure 32](#).

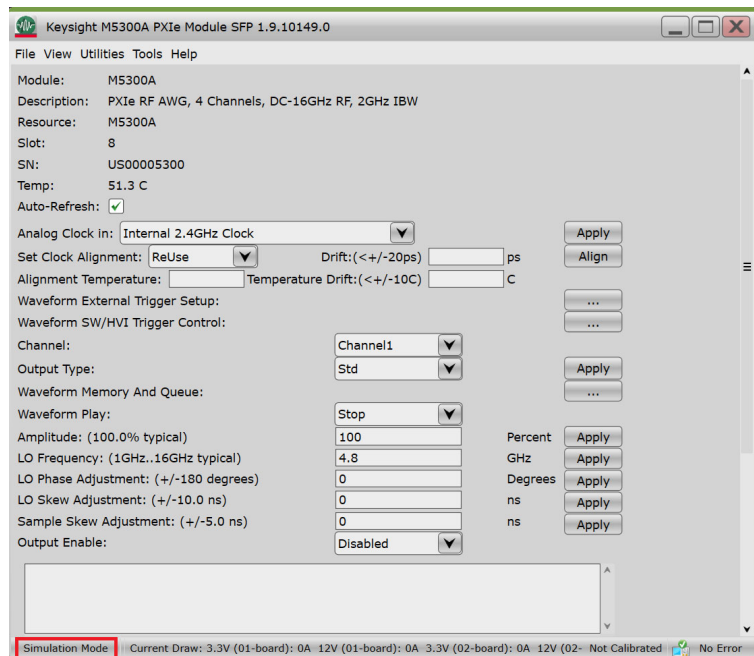

Figure 32 “Simulation Mode” in the status bar on the main window

Note that a demo ‘M5300A’ module only is displayed in [Figure 30](#) and in [Figure 31](#) along with other active cards. This entry appears when “Simulation Mode” is enabled only, irrespective of state of the chassis (On / Off) or the modules inserted in them.

- ‘Simulation mode’ disabled—This is the active mode of SFP operation and is available when the **Simulation Mode** check box is manually cleared. The **Simulate** button is replaced with the **Connect** button on the **Connect to Instrument** window, as shown in [Figure 33](#). In this mode, only the active modules are displayed along with the respective chassis number, slot number and VISA address.

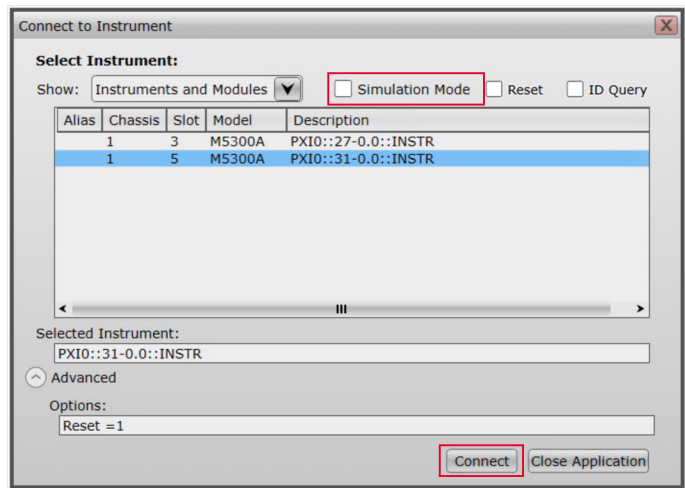

Figure 33 Connect to Instrument with "Simulation Mode" disabled

This mode is used for active SFP operations. In this mode, toggling the SFP controls changes the signal state on the selected module. The status bar on the main window shows 'Connected to <VISA-address>' to indicate the module that has been selected, as shown in [Figure 34](#).

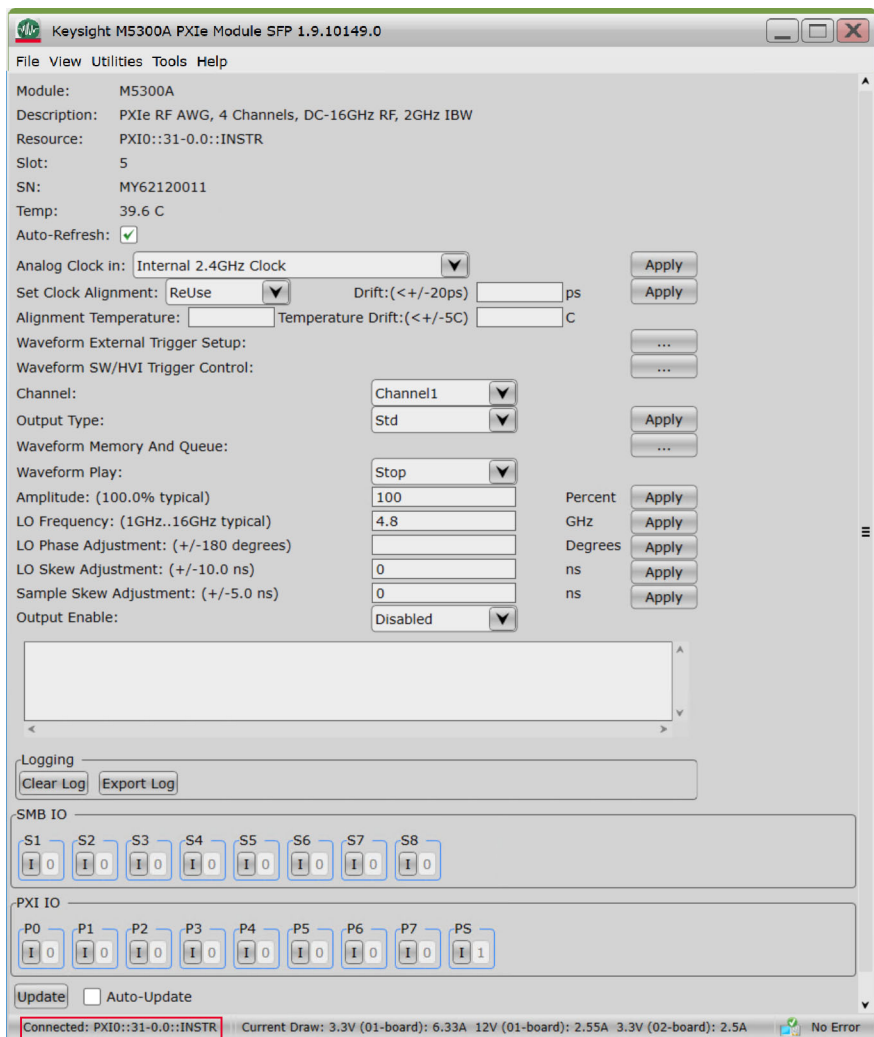

Figure 34 “Connected to <VISA address>” in the status bar on the main window

For more information regarding the features and functionality of the Keysight M5300x SFP, refer to the *M5300A PXIe RF AWG Modules User Guide*, which can be accessed via the **Help** menu of the M5300x SFP.

3.5.2: Starting M5300x API

You may access the M5300x API to control and configure the connected instruments using the 'ktM5300x' Library available in Python, C/C++ and .NET programming languages.

The following work flow, using Python commands, shows how to use Keysight M5300x Programming Libraries:

- 1 Import required system components and python libraries (as needed).

Examples:

```
import sys
import os
import numpy as np # For keysight_ktm5300x arrays
```

- 2 Import the M5300x Python library for programming the M5300A card.

Example:

```
import keysight_ktm5300x as m5300x
```

- 3 Proceed with creating module objects and defining other M5300x functions.

NOTE

For both simulation and non-simulation modes, when defining options in either C, C#, Visual Basic, C++ or MATLAB programming languages, make sure to include the "DriverSetup= Model=M5300A" string prior to including the other required options.

For example, the options in your C# script must appear as:

```
var options = "DriverSetup= Model=M5300A, QueryInstrStatus=true, RangeCheck=true, Simulate=false";
```

Also, when programming using IVI-C, IVI-.NET and Python, make sure to rename the property "reset" used in options to "DriverReset". For example, the options in your Python script can be written as:

```
options = "DriverSetup=Model=M5300A, Simulate=False, DriverReset=True"
```

For more information regarding M5300x API programming functions, refer to the Help files, which are available in *C:\Program Files\Keysight\M5300x*, for each programming language.

3.5.3: Initiating PathWave Test Sync Executive software

As mentioned earlier, the KS2201A PathWave Test Sync Executive software is not a standalone software. It enhances the Keysight M5300x API to support HVI technology by adding the DLL files required for Python libraries. After you install the KS2201A PathWave Test Sync Executive software, you can find the library in *C:\Program Files\Keysight\HVI\api\python\keysight_pathwave_hvi*.

The HVI API within the KS2201A PathWave Test Sync Executive software consists of classes that provide native HVI functionalities that are common across any measurement instrument deployed within an HVI system.

NOTE

HVI programming is supported with 64-bit Python versions 3.7, 3.8, 3.9, 3.10, 3.11 and 3.12 along with their subversions. Multiple versions are also supported.

To use the HVI API in Python, import the HVI API Python package that is included with the HVI installer. This will be your first part of your code in each of your files. Unless this package is imported, the HVI API will not be found.

The following work flow, using Python commands, shows how to add HVI library to an application and create an HVI instance.

- 1 Import required system components and python libraries (as needed).

Examples:

```
import sys
import os
import numpy as np # For keysight_ktm5300x arrays
```

- 2 Import the M5300x Python library for programming the M5300A card.

Example:

```
import keysight_ktm5300x as m5300x
```

- 3 Import the HVI library to create an HVI instance.

Example:

```
import keysight_hvi as kthvi
```

- 4 Create KtHvi instance

Example:

```
module_resource_name = 'KtHvi'
hvi = kthvi.Hvi(module_resource_name)
```

- 5 Add each engine to the KtHvi instance

Example:

```
hvi.engines.add(module.hvi.engines.main_engine, "engine_name")
```

- 6 Based on your requirements, you may proceed with defining HVI resources (actions, events, triggers), programming HVI sequences and compiling, loading and executing the HVI application.

The HVI functions corresponding to M5300x API can be found in the *M5300x HVI Add-On Help* in *C:\Program Files\Keysight\M5300x\Help*.

The complete description of the HVI Python API can be found in the help file that is provided with the HVI installer, available in:

C:\Program Files\Keysight\HVI\api\python\doc

3.5.4: Launching the PathWave FPGA BSP

The KF9000B PathWave FPGA software and the Board Support Package (BSP) are inter-dependent. The BSP file is accessible within the KF9000B PathWave FPGA design environment to achieve the desired output.

Once you have installed the PathWave FPGA software, you can launch its user interface from the **Start** menu.

The BSP for M5300A modules is installed as part of the M5300x software installation, which lets you proceed further with creating a new project in PathWave FPGA to design the sandbox region for the corresponding module. If you are unable to create a new project, see “[Module-specific BSPs not installed](#)” on page 79.

For instructions to create a new project to design your custom FPGA logic and to generate the Bitstream (.k7z) file, which can then be loaded onto the M5300A sandbox using the KF9000B PathWave Test Sync Executive software, refer to *Chapter 3: Using the PathWave FPGA Board Support Package (BSP)* in the *M5300A PXIe RF AWG Modules User Guide*.

To understand the features of the PathWave FPGA design environment, refer to the PathWave FPGA Help file accessible via the Help menu of the KF9000B *PathWave FPGA* software or visit the [KF9000B PathWave FPGA Technical Support](#) page for documentation.

Once the Bitstream (.k7z) file is generated successfully, use the M5300x SW API to load the k7z file onto the M5300A module’s sandbox.

To know about BSP interfaces required to build a custom FPGA logic, refer to the BSP User Guide for the M5300A module, which can be accessed via **Help > BSP Help** menu options in the *KF9000B PathWave FPGA* software.

For information about APIs associated with FPGA operations in the M5300A modules, refer to the Python API Help (*index.html*) located in *C:\Program Files\Keysight\M5300x\python\html*.

4. Troubleshooting and Safety information

[Issues during installation](#) / 74

[Issues with Python](#) / 77

[Issues with performing updates](#) / 78

[Issues with PathWave FPGA](#) / 79

[Safety information](#) / 81

This sections guides you to perform certain troubleshooting steps if you run into an error caused by a specific known limitation of the software.

Section 4.1: Issues during installation

4.1.1: Issue during installation of SW drivers

- If you receive the following error: “Another IVI-C driver for this instrument is already installed.”, the possible reason is that the IVI-C driver from the previous installation was not removed for some unknown reason. To fix this issue, try one of the following fixes:
 - Make sure that the all the older instances of the IVI-C driver for the M5300A modules are removed from the Control Panel.
 - Navigate to *C:\Program Files\IVI Foundation\IVI\Bin* and delete any DLL files named *KtM5XXXx_64.dll*, if found.
 - Navigate to *C:\Program Files\IVI Foundation\IVI\Drivers* and delete any directory named *KtM5XXXx*, if found.
 - Navigate to *C:\Program Files\IVI Foundation\IVI\Microsoft.NET\Framework64\v4.5.50709* and delete any directory named *Keysight.KtM5XXXx <version>*, if found.
- If installing the complete/hardware install and the installer is stalling for long periods or failing installing Keysight IO Libraries, try downloading and installing Keysight IO Libraries directly from <https://www.keysight.com/find/iolib>.
- For Keysight support for help with tools and documentation or to connect with a technical support expert for product and service support, see <https://www.keysight.com/find/support>.

4.1.2: Issue with one or more M5000 series modules not appearing in NI chassis

This issue is specific to the users who have installed one or more M5000 series modules in the National Instruments (NI) chassis. The modules may be detected by the Keysight IO Libraries Suite. However, if you do not see those under “Devices and Interfaces” in the NI – Measurement & Automation Explorer (MAX) Interface and see VISA error, as shown in [Figure 35](#), the possible reason is that the NI associated drivers were not installed properly.

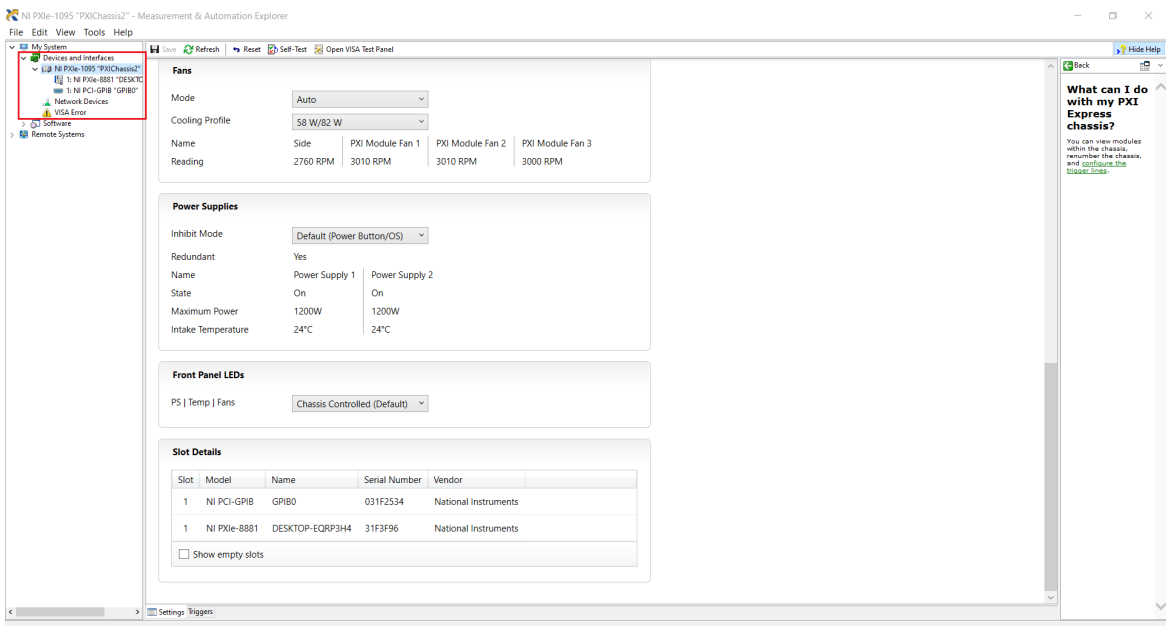

Figure 35 Non appearance of M5000 series modules in NI MAX interface

To fix this issue, perform the following steps:

NOTE

You must have administrator privileges to install/remove the applications.

- 1 Remove all the applications related to NI, such as LabVIEW and the NI associated drivers.
- 2 Disconnect the NI chassis from your computer.
- 3 Install the following drivers:
 - LabVIEW
 - VISA
 - NI 488.2
- 4 Make sure that the M5000 series module(s) is properly installed in the NI chassis.
- 5 Reconnect the NI chassis to your computer.

NOTE

Check the firewall in the WinOS for any exceptions if you still do not see the M5000 series modules.

After you perform the steps above, the M5000 series modules appear in the NI MAX interface, as shown in [Figure 36](#).

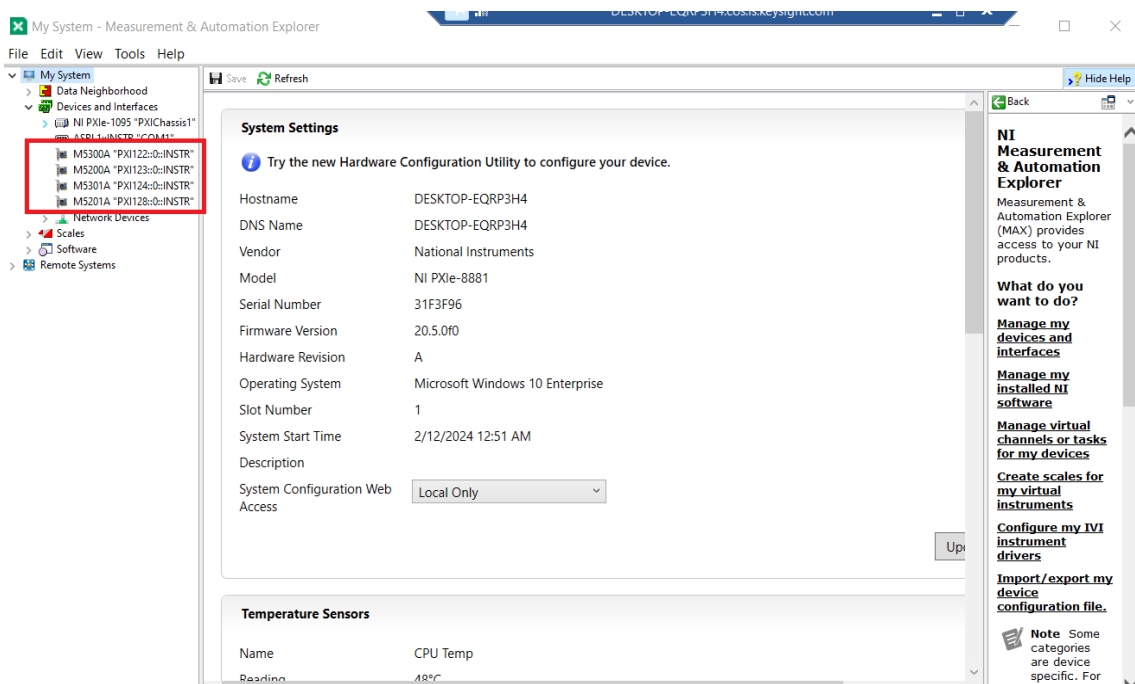

Figure 36 NI MAX showing the M5000 series modules after troubleshoot

For more details about National Instruments, see <https://www.ni.com/en.html>.

Section 4.2: Issues with Python

4.2.1: Installing M5300x Drivers on Python ver. other than 3.7

M5300x instrument drivers include the binary distribution for Python 3.7.x running on a 64-bit version of windows. For other versions of Python, the Python shim is created that will allow Python to access the instrument driver. In order to correctly compile the shim, you require a version of Visual Studio 2017 installed (the community edition is sufficient for this) with the C++ Desktop Development workload installed. Once the appropriate prerequisites are installed, you must navigate to the instrument driver python folder and install the python module's *.tar.gz* file, as shown:

```
C:\Program Files\Keysight\M5300x\python>pip install  
keysight_ktm5300x-1.0.42409.tar.gz
```

4.2.2: Installing Python after the Instrument Driver

The installers for M5300A module drivers attempt to install Python during installation. However, there are various reasons, including the ones listed below, that this may not work for you.

- 1 Python 3.7.x is not set as the default Python interpreter on the system.
- 2 Python is installed after installing the instrument driver.

In such cases, it may be necessary for you to manually install the Python module containing the instrument driver. To do this, navigate to the instrument driver python folder and install the Python's *.whl* file, as shown:

```
C:\Program Files\Keysight\M5300x\python>pip install  
keysight_ktm5300x-1.0.42409-cp37-cp37m-win_amd64.whl
```

NOTE

For offline installation, the M5300A module drivers require that the Python module *numpy* be already installed and will fail, if it has not already been installed.

Section 4.3: Issues with performing updates

4.3.1: Issue when performing FW / FPGA updates via the SFP

You might see unexpected interrupts or error message prompts when performing FPGA updates via the SFP.

In such cases, ignore the interrupts or error prompts to continue with the firmware update.

4.3.2: Issue when performing SW version update

During SW version update, selecting FPGA firmware update may return error code: "Segmentation Violation".

In such cases, in the "Connect to Instrument" window, enter "Initialize=0" in the Advanced Options and manually perform Firmware update using the SFP.



Figure 37 Setting option 'Initialize=0' to perform firmware update through SFP

Section 4.4: Issues with PathWave FPGA

4.4.1: Module-specific BSPs not installed

If the BSP file for either of the supported modules is not installed, the KF9000B PathWave FPGA SW prompts the error shown in [Figure 38](#), when you try to create a new project.

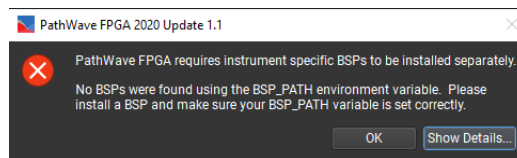

Figure 38 Error prompted by PathWave FPGA SW if BSP is not installed

To fix this issue, install / reinstall the SW drivers for the required driver. See [Installing required software](#) on page 54.

4.4.2: Xilinx Vivado tool not installed

If you do not have the *Xilinx Vivado Design Suite* on the same machine where the KF9000B PathWave FPGA software and BSP are installed, the following error is prompted, when you click the **Generate Bit File...** icon.

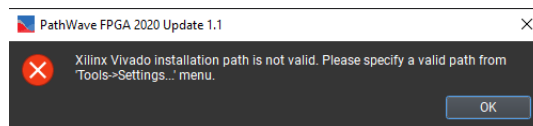

Figure 39 Error prompted by PathWave FPGA SW if Vivado is not installed

In such cases, contact Xilinx support or download Vivado Design Suite from <https://www.xilinx.com/>.

4.4.3: Timing errors during k7z file generation

If you encounter timing closure errors during sandbox design compilation, change the `place_design -directive` options in the `keysight_common_build.tcl` file, located at `C:\Program Files\Keysight\M5300A\BSP\<GW-version>\scripts`. See [Figure 40](#).

The `place_design -directive` options available are:

```
# AltSpreadLogic_medium
# AltSpreadLogic_high
# AltSpreadLogic_low
# ExtraNetDelay_low
# ExtraNetDelay_high
# Explore
```

After changing this option, close the PathWave FPGA interface and relaunch the application for the changes to take effect.

```

652
653 ..#Run the design up to routing.
654 ..opt_design -directive Explore
655
656 ..#Set the estimated build progress
657 ..setProgress 30
658
659 ..processHook $pre_place_hook
660
661 ..#Try other placer options to close timing.
662 ..#AltSpreadLogic_medium - current
663 ..#AltSpreadLogic_high
664 ..#AltSpreadLogic_low
665 ..#ExtraNetDelay_low
666 ..#ExtraNetDelay_high
667 ..#Explore
668 ..place_design -directive AltSpreadLogic_medium
669
670 ..#Set the estimated build progress
671 ..setProgress 60

```

Figure 40 Changing `place_design -directive` in the `keysight_common_build.tcl` file

Section 4.5: Safety information

IMPORTANT

The safety of any system incorporating the equipment is the responsibility of the assembler of the system.

Maintenance To remove dirt or dust from the M5300A module, follow the instructions given in [Cleaning the module](#) on page 46 of this document.

4.5.1: General safety considerations

Before applying power

WARNING

If this product is not used as specified, the protection provided by the equipment could be impaired. This product must be used in a normal condition (in which all means for protection are intact) only.

CAUTION

The measuring terminals on this instrument are designed to be used with external signals described in Mains-isolated secondary circuits, but NOT with external signals described in Categories II, III, and IV. The input of this instrument cannot be connected to the mains.

Table 12 Description of Measurement Category II, III and IV

Measurement Category	Description
II	Applicable to testing and measuring circuits connected directly to utilization points (socket outlets and similar points) of the low-voltage mains installation. Example: Measurements on MAINS CIRCUITS of household appliances, portable tools and similar equipment and on the consumer side only of socket-outlets in the fixed installation.
III	Applicable to test and measuring circuits connection to the distribution part of the building's low-voltage mains installation. To avoid risks caused by the hazards arising from these higher short-circuit currents, additional insulation and other provisions are required. Example: Measurements on distribution boards (including secondary meters), photovoltaic panels, circuit breakers, wiring, including cables, bus-bars, junction boxes, switches, socket-outlets in the fixed installation, equipment for industrial use and some other equipment such as stationary motors with permanent connection to the fixed installation. NOTE: For equipment that is part of a fixed installation, the fuse or circuit breaker of the installation can be considered to provide adequate protection against short-circuit currents.
IV	Applicable to test and measuring circuits connected at the source of the building's low-voltage mains installation. Due to these high short-circuit currents, which can be followed by a high energy level, measurements made within these locations are extremely dangerous. Great precautions shall be made to avoid any chance of a short circuit. Example: Measurements on devices installed before the main fuse or circuit breaker in the building installation.

Servicing

WARNING

Servicing of the modules must be performed by qualified personnel only. To avoid electrical shock, do not perform any servicing manually. Return the module to Keysight Service Center.

Equipment and accessories

WARNING

For safety reasons, only Keysight approved equipment and accessories should be used with the module.

NOTE

Position chassis to ensure easy access to remove the modules.

