

1130B-Series Differential & Single-Ended Probes

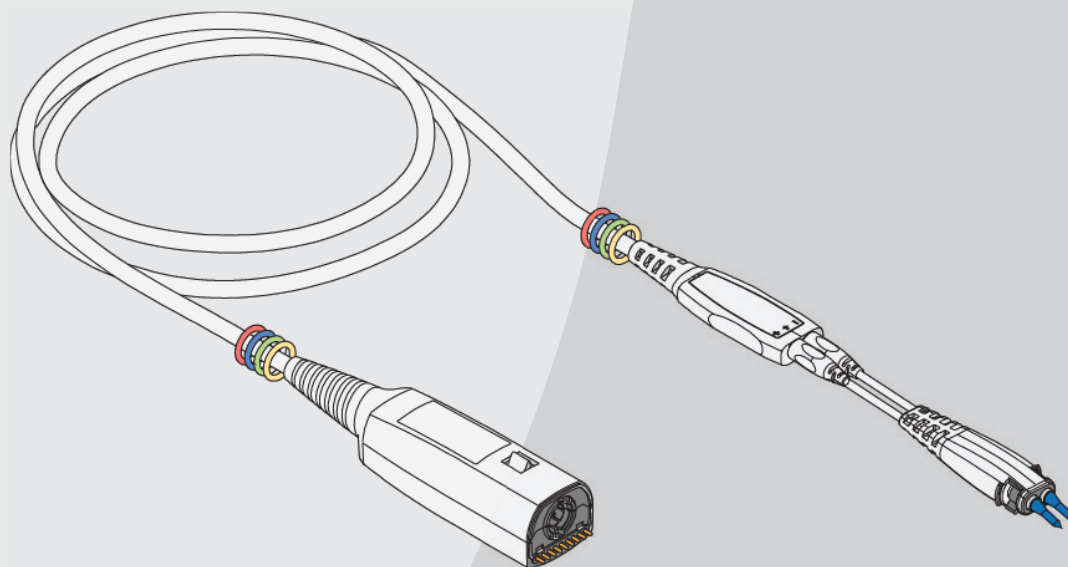

Notices

© Keysight Technologies, 2016-2019, 2023

No part of this manual may be reproduced in any form or by any means (including electronic storage and retrieval or translation into a foreign language) without prior agreement and written consent from Keysight Technologies, Inc. as governed by United States and international copyright laws.

Manual Part Number

01130-97014

Edition

Tenth Edition, October 2023

Available in electronic format only

Published by:

Keysight Technologies, Inc.

1900 Garden of the Gods Road
Colorado Springs, CO 80907 USA

Warranty

The material contained in this document is provided “as is,” and is subject to being changed, without notice, in future editions. Further, to the maximum extent permitted by applicable law, Keysight disclaims all warranties, either express or implied, with regard to this manual and any information contained herein, including but not limited to the implied warranties of merchantability and fitness for a particular purpose. Keysight shall not be liable for errors or for incidental or consequential damages in connection with the furnishing, use, or performance of this document or of any information contained herein. Should Keysight and the user have a separate written agreement with warranty terms covering the material in this document that conflict with these terms, the warranty terms in the separate agreement shall control.

Technology Licenses

The hardware and/or software described in this document are furnished under a license and may be used or copied only in accordance with the terms of such license.

U.S. Government Rights

The Software is "commercial computer software," as defined by Federal Acquisition Regulation ("FAR") 2.101. Pursuant to FAR 12.212 and 27.405-3 and Department of Defense FAR Supplement ("DFARS") 227.7202, the U.S. government acquires commercial computer software under the same terms by which the software is customarily provided to the public. Accordingly, Keysight provides the Software to U.S. government customers under its standard commercial license, which is embodied in its End User License Agreement (EULA), a copy of which can be found at <http://www.keysight.com/find/sweula>. The license set forth in the EULA represents the exclusive authority by which the U.S. government may use, modify, distribute, or disclose the Software. The EULA and the license set forth therein, does not require or permit, among other things, that Keysight: (1) Furnish technical information related to commercial computer software or commercial computer software documentation that is not customarily provided to the public; or (2) Relinquish to, or otherwise provide, the government rights in excess of these rights customarily provided to the public to use, modify, reproduce, release, perform, display, or disclose commercial computer software or commercial computer software documentation. No additional government requirements beyond those set forth in the EULA shall apply, except to the extent that those terms, rights, or licenses are explicitly required from all providers of commercial computer software pursuant to the FAR and the DFARS and are set forth specifically in writing elsewhere in the EULA. Keysight shall be under no obligation to update, revise or otherwise modify the Software. With respect to any technical data as defined by FAR 2.101, pursuant to FAR 12.211 and 27.404.2 and DFARS 227.7102, the U.S. government acquires no greater than Limited Rights as defined in FAR 27.401 or DFAR 227.7103-5 (c), as applicable in any technical data. 52.227-14

(June 1987) or DFAR 252.227-7015 (b)(2) (November 1995), as applicable in any technical data.

Safety Notices

CAUTION

A **CAUTION** notice denotes a hazard. It calls attention to an operating procedure, practice, or the like that, if not correctly performed or adhered to, could result in damage to the product or loss of important data. Do not proceed beyond a **CAUTION** notice until the indicated conditions are fully understood and met.

WARNING

A **WARNING** notice denotes a hazard. It calls attention to an operating procedure, practice, or the like that, if not correctly performed or adhered to, could result in personal injury or death. Do not proceed beyond a **WARNING** notice until the indicated conditions are fully understood and met.

Contents

1 Getting Started

- Introduction **8**
- Probe Handling **13**
- Using Offset With InfiniiMax Active Probes **17**
- Slew Rate Requirements for Different Technologies **19**
- Available Accessories **21**
- Safety Information **32**
- Troubleshooting **34**

2 Using Probe Heads

- Recommended Configurations at a Glance **38**
- 1. MX0100A InfiniiMax Micro Probe Head **40**
- 2. E2677B Differential Solder-in Head with Full BW Resistors **51**
- 3. E2678B Differential Socketed Head **53**
- 4. E2675B Differential Browser **56**
- 5. N5380B SMA Head (Discontinued) **59**
- 6. N2851A QuickTip Probe Head **62**
- 7. E2679B Single-Ended Solder-In Head **66**
- 8. E2676B Single-Ended Browser **67**
- 9. E2677B Differential Solder-In Head with Medium BW Resistors **69**
- 10. E2679B Single-Ended Solder-In Head with Long Wire **71**
- 11. E2678B Differential Socketed Head with Damped Wire Accessory **73**
- 12. E2678B Differential Socketed Head with Header Adapter **75**
- Replacing Resistors on E2677B/9B Solder-In Probe Heads **76**

3 Calibrating Probes

- Calibration for Solder-In and Socketed Probe Heads **82**
- Calibration for Hand-held Browser Probe Heads **89**
- Calibration for N5380A/B SMA Probe Heads **91**

4 Characteristics and Specifications

- General **94**
- Environmental **96**
- Regulatory **97**
- Probe Dimensions **98**
- MX0100A Probe Head Dimensions **99**

5 1130B Performance Data Plots

- E2675B Differential Browser **102**
- E2676B Single-Ended Browser **105**

E2677B Differential Solder-in Probe Head (Full BW)	108
E2677B Differential Solder-in Probe Head (Medium BW)	111
E2678A/B Differential Socketed Probe Head (Full BW)	114
E2678A/B Differential Socketed Probe Head with Damped Wire Accessory	117
E2679B Single-Ended Solder-in Probe Head (Full BW)	120
E2679B Single-Ended Solder-in Probe Head (Medium BW)	123
N2851A QuickTip Head with N2849A QuickTip	126

6 1131B Performance Data Plots

E2675B Differential Browser	128
E2676B Single-Ended Browser	131
E2677B Differential Solder-in Probe Head (Full BW)	134
E2677B Differential Solder-in Probe Head (Medium BW)	137
E2678A/B Differential Socketed Probe Head (Full BW)	140
E2678A/B Differential Socketed Probe Head with Damped Wire Accessory	143
E2679B Single-Ended Solder-in Probe Head (Full BW)	146
E2679B Single-Ended Solder-in Probe Head (Medium BW)	149
N2851A QuickTip Head with N2849A QuickTip	152

7 1132B Performance Data Plots

E2675B Differential Browser	154
E2676B Single-Ended Browser	157
E2677B Differential Solder-in Probe Head (Full BW)	160
E2677B Differential Solder-in Probe Head (Medium BW)	163
E2678A/B Differential Socketed Probe Head (Full BW)	166
E2678A/B Differential Socketed Probe Head with Damped Wire Accessory	169
E2679B Single-Ended Solder-in Probe Head (Full BW)	172
E2679B Single-Ended Solder-in Probe Head (Medium BW)	175
N2851A QuickTip Head with N2849A QuickTip	178

8 1134B Performance Data Plots

E2675B Differential Browser	180
E2676B Single-Ended Browser	183
E2677B Differential Solder-in Probe Head (Full BW)	186
E2677B Differential Solder-in Probe Head (Medium BW)	189
E2678A/B Differential Socketed Probe Head (Full BW)	192
E2678A/B Differential Socketed Probe Head with Damped Wire Accessory	195
E2679B Single-Ended Solder-in Probe Head (Full BW)	198
E2679B Single-Ended Solder-in Probe Head (Medium BW)	201
N5380B SMA Probe Head	204
N2851A QuickTip Head with N2849A QuickTip	206

9 Performance Verification

Using the 8720ES VNA successfully	208
Procedure	209
Performance Test Record	216

10 SPICE Models

- SPICE Model for Differential Probe Heads **219**
- SPICE Model for Single-Ended Probe Heads **220**
- SPICE Deck and Measured/Modeled Data Matching **221**

11 Replacement Parts

- E2675B Differential Browser Probe Head **232**
- E2677B Differential Solder-In Probe Head **232**
- E2678A/B Differential Socketed Probe Head **233**
- E2679B Single-Ended Solder-in Probe Head **233**
- Other Accessories **234**

Index

1 Getting Started

Introduction	8
Probe Handling	13
Using Offset With InfiniiMax Active Probes	17
Slew Rate Requirements for Different Technologies	19
Available Accessories	21
E2668B Single-Ended Connectivity Kit	21
E2669B Differential Connectivity Kit	22
N5450B Extreme Temp Cable Extension Kit	24
N2880A InfiniiMax In-Line Attenuator Kit	25
N2881A InfiniiMax DC Blocking Caps	29
MX0102A Soldering Toolkit	30
Safety Information	32
Troubleshooting	34

The 1130/1/2/4B InfiniiMax active probes are designed for probing differential and single-ended high-frequency signals. The probes are compatible with the Infiniium AutoProbe Interface which completely configures the Infiniium series of oscilloscopes for the probes.

WARNING

Before using the probe, refer to **“Safety Information”** on page 32.

CAUTION

Before using the probes, refer to **“Probe Handling”** on page 13.

Introduction

Before you can use the probe, you must connect one of the available probe heads to an 1130/1/2/4B probe amplifier.

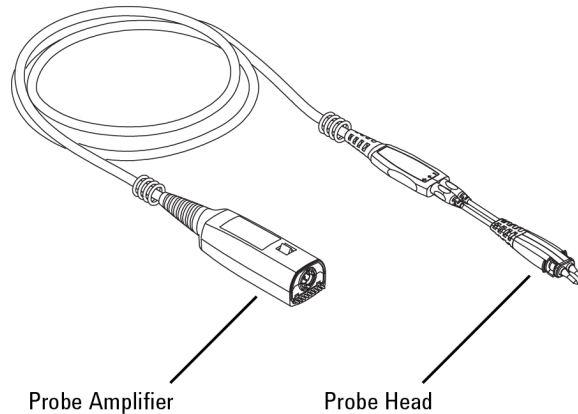

Figure 1 Probe Amplifier with Attached Head

Probe Heads

The available probe heads are shown in **Figure 2** on page 9 and are documented in **Chapter 2**, “Using Probe Heads”. The InfiniiMax I probe heads are designed specifically for the 1130/1/2/4B probe amplifiers. The InfiniiMax II probe heads are designed for 1168/9B probe amplifiers, but can also be used with the 1130/1/2/4B probe amplifiers.

The probe heads can be ordered at the same time as 1130/1/2/4B probe amplifiers. The E2669B and E2668B connectivity kits, described on **page 22** and **page 21** conveniently package multiple probe heads and their accessories.

Differential probe heads offer easy measurement of differential signals and greatly improve the measurement of single-ended signals. Single-ended probe heads offer extremely small size for probing single-ended signals in confined spaces.

Compatible Oscilloscopes

Table 1 on page 10 lists the oscilloscopes that are compatible with the 1130/1/2/4B probes. Is Your Oscilloscope Software Up-to-Date? Keysight periodically releases Oscilloscope software updates to support your probe, fix known defects, and incorporate product enhancements. To download the latest firmware, go to www.keysight.com and search for your oscilloscope’s topic. Click on the “Drivers, Firmware & Software” tab.

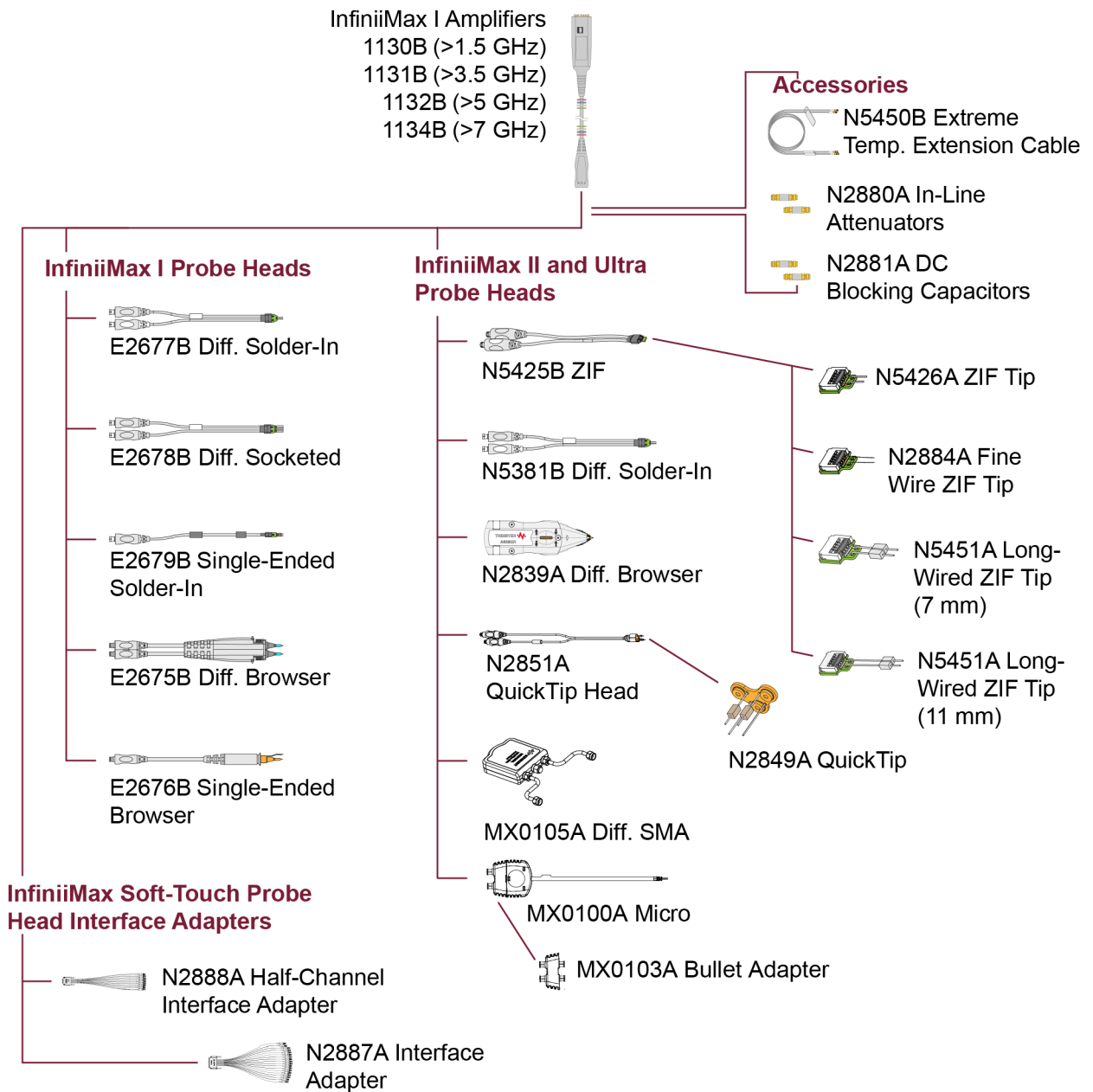

Figure 2 Available Probe Heads and Accessories

NOTE

N2849A QuickTips are also compatible with the N2848A InfiniiMode probe heads which are designed for N2830/1/2A InfiniiMax III+ and N2800/1/2/3A InfiniiMax III probes.

Table 1 Compatible Oscilloscopes

Oscilloscope	Adapter Required
Infiniium Oscilloscopes	
UXR-Series	With N5442A adapter cascaded with the N2852A adapter when using with UXR-Series 40 GHz or higher
	With N5442A adapter when using with UXR-Series 13 GHz to 33 GHz
EXR-Series	none
MXR-Series	none
S-Series	none
90000 X- and Q-Series	N5442A
90000A Series	none
86100C/D Series	N1022A/B
9000 H-Series	none
9000A-Series	none
8000A-Series	none
InfiniiVision Oscilloscopes	
6000 X-Series	none
4000 X-Series	none
3000 X-Series	none
7000A Series	none
6000A Series (350 MHz – 1 GHz)	none
5000A Series	none

Channel Identification Rings

When multiple probes are connected to the oscilloscope, use the channel identification rings to associate the channel inputs with each probe. Place one colored ring near the probe's channel connector and place an identical color ring near the probe head.

Inspecting the Probe

Figure 3 on page 11 shows the accessories that are shipped with the 1130/1/2/4B probe amplifiers. The probe amplifiers do not come with a probe head *unless* selected at the time of order. Any head shown in **Figure 2** on page 9 can be ordered at any time for any 1130/1/2/4B probes.

- Inspect the shipping container for damage.
Keep the damaged shipping container or cushioning material until the contents of the shipment have been checked for completeness and the probe has been checked mechanically and electrically.
- Check the accessories.
- If the contents are incomplete or damaged, notify your Keysight Technologies Sales Office.
- Inspect the probe. If there is mechanical damage or defect, or if the probe does not operate properly or pass calibration tests, notify your Keysight Technologies Sales Office.

If the shipping container is damaged, or the cushioning materials show signs of stress, notify the carrier as well as your Keysight Technologies Sales Office. Keep the shipping materials for the carrier's inspection. The Keysight Technologies office will arrange for repair or replacement at Keysight Technologies' option without waiting for claim settlement.

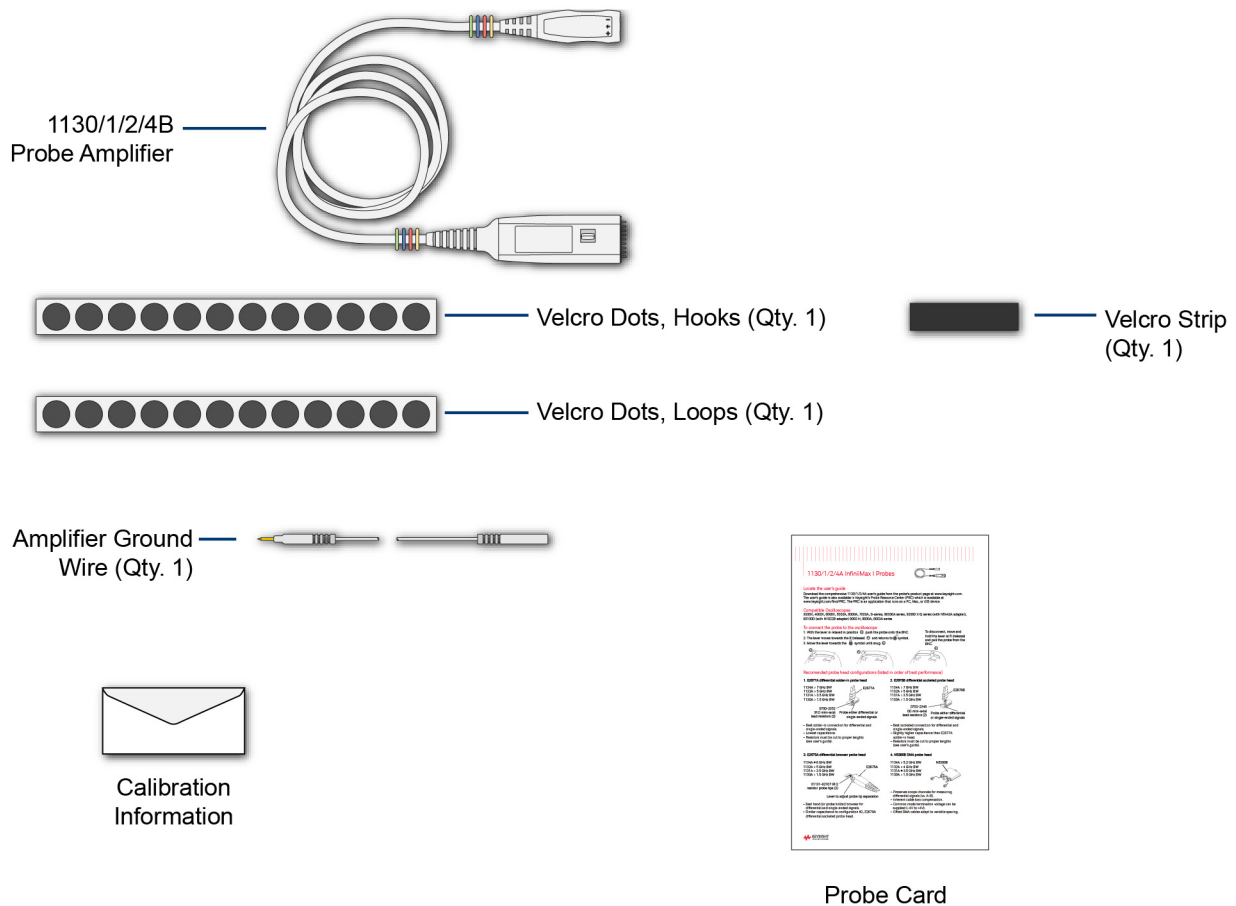

Figure 3 Accessories Supplied With the Probe Amplifier

Cleaning the probe

If the probe requires cleaning, disconnect it from the oscilloscope and clean it with a soft cloth dampened with a mild soap and water solution. Make sure the probe is completely dry before reconnecting it to the oscilloscope.

Probe Handling

This probe has been designed to withstand a moderate amount of physical and electrical stress. However, with an active probe, the technologies necessary to achieve high performance do not allow the probe to be unbreakable. Treat the probe with care. It can be damaged if excessive force is applied to the probe tip. This damage is considered to be abuse and will void the warranty when verified by Keysight Technologies service professionals.

- Exercise care to prevent the probe end from receiving mechanical shock.
- Store the probe in a shock-resistant case such as the foam-lined shipping case which came with the probe.

Connecting and Disconnecting Probe Heads

When disconnecting a probe head from an amplifier, pull the probe head connectors straight out of the sockets as shown in **Figure 4**. When connecting a probe head to an amplifier, push straight in. Always grasp the indentations located on the sides of the amplifier as shown in **Figure 4**. There are also indentations on many of the probe head sockets so you have a convenient place to grasp there as well.



Figure 4 Properly Pulling the Probe Head Straight Out

CAUTION

Avoid damaging the connection pins. Never bend the probe head in order to “pop” it loose from the amplifier. Do not wiggle the probe head up and down or twist it to remove the connectors from the sockets.

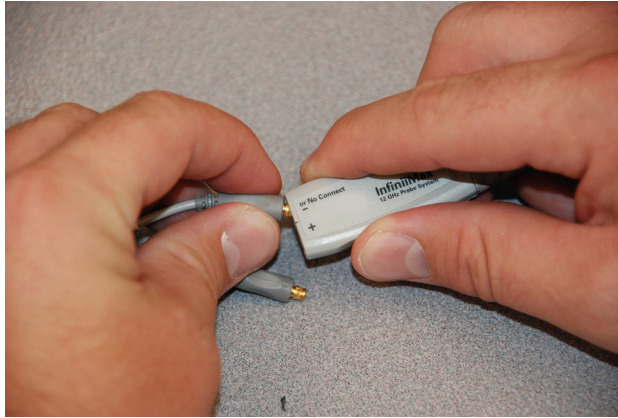

Figure 5 Improperly Disconnecting a Probe Head From an Amplifier

Handling the Probe Cable

CAUTION

Avoid degrading the probe's performance. Do not twist, kink, or tightly bend the probe's cable.

CAUTION

When the probe is attached to an oscilloscope, avoid letting object hit the probe cable where the cable exits the probe amplifier and bend it well beyond its limit.

When storing the probe, coil the cable in a large loops and avoid twisting the cable. Coil the cable in a similar manner to how garden hoses or extension cords are typically coiled. You can start by wrapping the cable around your thumb as shown in **Figure 6**. Then continue to circle your thumb, but provide a slight twist with each rotation. This allows the cable rotations to lie flat against each other and will eliminate the net twisting of the cable in the end.



Figure 6 Recommended Coil for Storage

CAUTION

Make the coil's radius fairly large so it does not induce kinking or bending.

Connecting the Probe to an Oscilloscope

The probes are only meant to be plugged into gold plated BNCs (like those on Infiniium oscilloscopes). To connect the probe to the oscilloscope, simply push the probe into the BNC connector and the locking mechanism automatically engages. To disconnect the probe, push and hold the locking lever to the left and then remove the probe.

Handling the Probe Amplifier

The probe amplifier contains a delicate circuit board. Treat it carefully and take standard precautions (for example, not dropping it repeatedly or from large heights, not getting it wet, not smashing it with heavy objects, etc.). These probes are sensitive ESD devices so standard precautions need to be used to not ruin the probe from the build-up of static charges.

Securing Probe Heads and Amplifiers to Your DUTs

When soldering a probe head to a circuit, first provide strain relief by using low temperature hot glue (use as little as possible) or non-conductive double-sided tape. Do not use super glue and do not get the low temperature hot glue on the actual probe head tip as this can damage the precision components of your probing system (only use the low temperature hot glue on the probe head cables). The provided velcro pads can be used to secure your probe amplifier casing to the board.

Once strain relief has been provided, solder the probe tip to the circuit board and then plug the probe head into the probe amplifier.

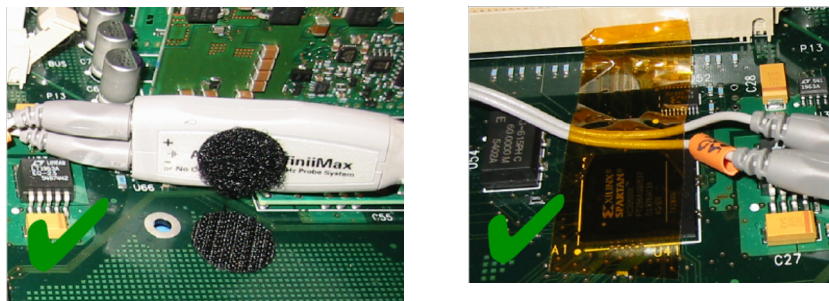

Figure 7 Correct Securing Methods

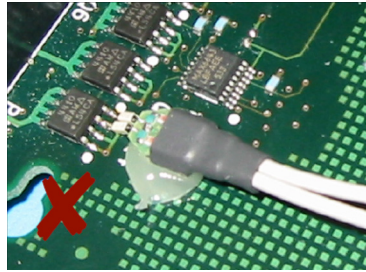

Figure 8 Incorrect Securing Method Because Glue is Placed on the Probe Head Tip

The velcro dots can be used to secure the probe amplifier to a circuit board removing the weight of the probe from the circuit connection. Attach a Velcro dots to both the probe amplifier and the circuit board as shown in **Figure 9** on page 16.

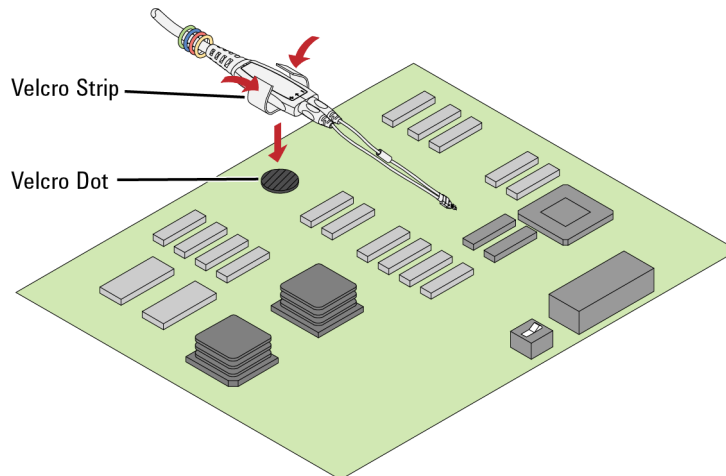

Figure 9 Using the Velcro Dots

Using Offset With InfiniiMax Active Probes

It is important to understand how the 113xA probes behave with respect to offset when different probe head / signal combinations are used.

The purpose of offset in active probes or oscilloscope front ends is to allow the subtraction of most or all of the dc component of the input signal so the signal can better utilize the dynamic range of the input. When using an InfiniiMax probe with an Infiniium oscilloscope, you can select the case (see the three cases described below) that applies for your measurement by selecting the **Probes** button under the channel setup menu. This allows you to select which type of probe head is being used and, if it is a differential probe head, allows you to select whether you are probing a differential or single-ended signal. With these inputs, the oscilloscope will use the proper type of offset for your measurement case. The specifics for each case are discussed below.

As an important side note, whenever adjusting the offset for a particular probe head, make sure to have a triggered signal.

Case 1. A single-ended probe head probing a single-ended signal

For this case, the offset control on the oscilloscope controls the probe offset and the channel offset is set to zero. This allows the offset voltage to be subtracted from the input signal before the signal gets to the differential amplifier. Since this subtraction is done before any active circuits, the offset range is large ($\pm 12\text{V}$ for the 113X amplifiers and $25\text{-k}\Omega$ probe heads). Note that the minus probe tip is not present when using a single-ended probe head which means nothing is plugged into the "-" input of the probe amp. This is normal and causes no problems.

Case 2. A differential probe head probing a single-ended signal

For this case, the offset control on the oscilloscope controls the probe offset and the channel offset is set to zero. This allows the offset voltage to be subtracted from the input signal before the signal gets to the differential amplifier. Since this subtraction is done before any active circuits, the offset range is large ($\pm 12\text{V}$ for the 113X amplifiers and $25\text{-k}\Omega$ probe heads). A differential probe can make higher bandwidth and more accurate measurements on single-ended signals than a single-ended probe and this method of applying offset to only the plus side of a differential probe means there is no sacrificing of offset range.

Case 3. A differential probe head probing a differential signal

For this case, the offset control on the oscilloscope controls the oscilloscope channel offset. The probe offset is not used and set to zero. Since the plus and minus sides of differential signals have the same dc component, it will be subtracted out and the output of the probe will by definition be centered around ground.

The channel offset allows the waveform seen on screen to be moved as desired. The allowable dc component in the plus and minus signals is determined by the common mode range of the probe which for the 113x probe amps and 25 k Ω probe heads is ± 6.75 V.

Slew Rate Requirements for Different Technologies

The following table shows the slew rates for several different technologies. The maximum allowed input slew rate is 18 V/ns for single-ended signals and 30 V/ns for differential signals. **Table 2** shows that the maximum required slew rate for the different technologies is much less than that of the probe.

Table 2 Slew Rate Requirements

Name of Technology	Differential Signal	Max Single-Ended Slew Rate* (V/ns)	Max Differential Slew Rate† (V/ns)	Driver Min Edge Rate (20%-80% ps)	Max Transmitter Level (Diff V)
PCI Express (3GIO)	YES	9.6	19.2	50	1.6
RapidIO Serial 3.125Gb	YES	8.0	16.0	60	1.6
10GbE XAUI (4x3.125Gb)	YES	8.0	16.0	60	1.6
1394b	YES	8.0	16.0	60	1.6
Fibre Channel 2125	YES	8.0	16.0	75	1
Gigabit Ethernet 1000Base-CX	YES	7.8	15.5	85	2.2
RapidIO 8/16 2Gb	YES	7.2	14.4	50	1.2
Infiniband 2.5Gb	YES	4.8	9.6	100	1.6
HyperTransport 1.6Gb	YES	4.0	8.0	113	1.5
SATA (1.5Gb)	YES	1.3	2.7	134	0.6
USB 2.0	YES	0.9	1.8	375	1.1
DDR 200/266/333	NO	7.2	n/a	300	3.6
PCI	NO	4.3	n/a	500	3.6
AGP-8X	NO	3.1	n/a	137	0.7

* The probe specification is 18 V/ns

† The probe specification is 30 V/ns

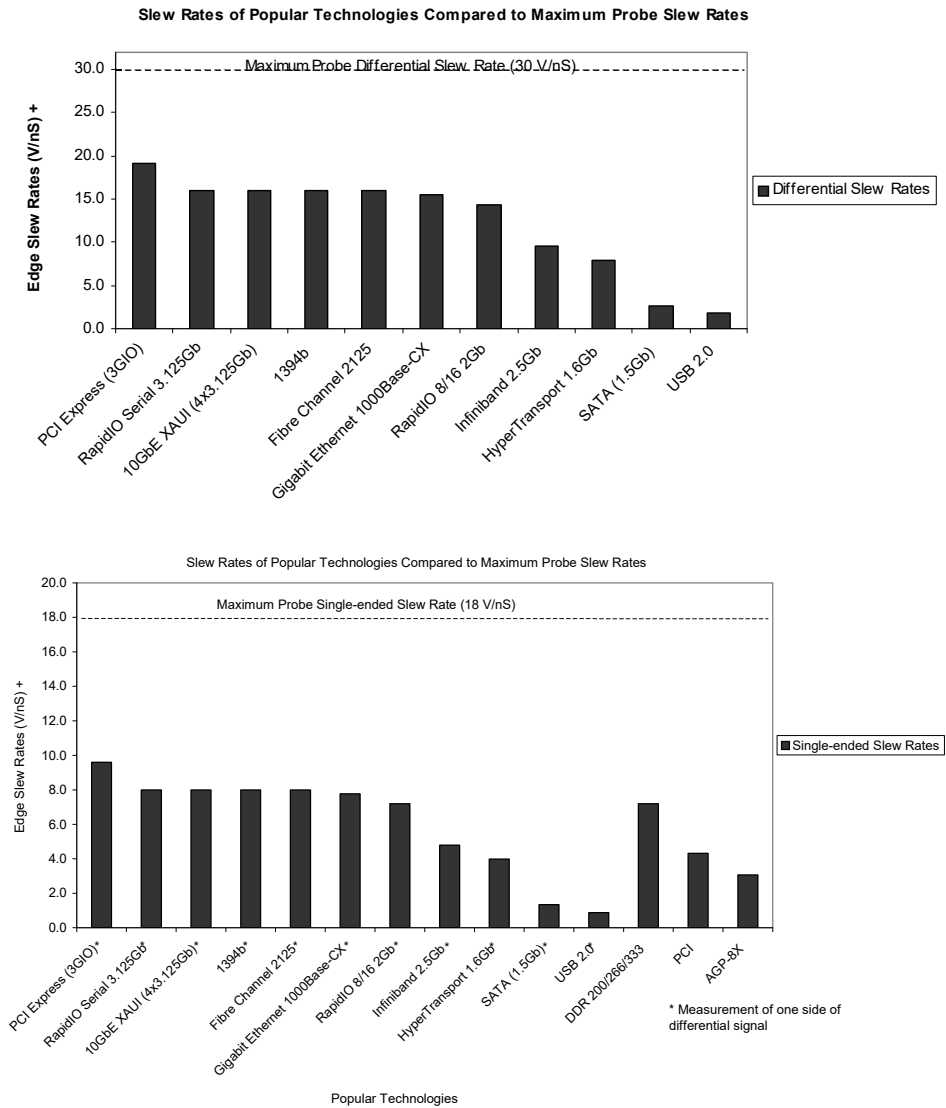

Figure 10 Slew Rates of Popular Technologies Compared to Maximum Probe Slew Rates

$$\frac{\text{Maximum Edge Amplitude} \times 0.6}{\text{Minimum 20\% to 80\% Rise Time}}$$

Available Accessories

This section lists accessories that are available in addition to the probe heads described in [Chapter 2](#), “Using Probe Heads”.

E2668B Single-Ended Connectivity Kit

The optional E2668B single-ended connectivity kit is an accessory that provides the three probe heads shown in [Figure 11](#). A single-ended socket-tip probe head was not developed since it did not offer a significant size advantage. The kit can be ordered at the same time as 1130/1/2/4B probe amplifiers.

E2679B Single-Ended Solder-In (quantity 1)

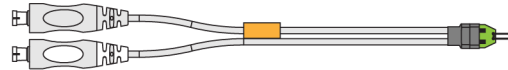

E2678B Differential Socketed (quantity 1)

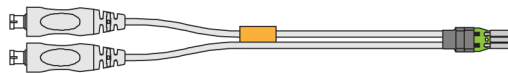

E2676B Single-Ended Browser (quantity 1)



Figure 11 E2668B Single-Ended Connectivity Kit (*not to scale*)

Table 3 Supplied Accessories (Sheet 1 of 2)

Description	Qty Supplied	Used With			Part Number *
		E2679B	E2678B	E2676B	
E2679B Single-Ended Solder-In Head	1	–	–	–	–
E2678B Differential Socketed Head	1	–	–	–	–
E2676B Single-Ended Browser	1	–	–	–	–
91Ω resistor for full bandwidth	16	✓			1NC3-1091
150Ω resistor for medium bandwidth	8	✓			1NC3-1150
0Ω resistor for full and medium bandwidth	24	✓			1NC3-1000
91Ω resistor template	2	✓			01131-94311
150Ω resistor template	2	✓			01131-94308
160Ω damped wire accessory	6		✓		01130-21303
82Ω resistor for full bandwidth	48		✓		01130-81506

Table 3 Supplied Accessories (Sheet 2 of 2)

Description	Qty Supplied	Used With			Part Number *
		E2679B	E2678B	E2676B	
Socket for 25 mil (25/1000 inch) square pins, female on both ends	4		✓		01131-85201
25 mil female socket w/20 mil round male pin on other end	4		✓		01131-85202
Heat shrink tubing for square-pin socket accessory	4		✓		01130-41101
Header adapter, 91Ω	2		✓		01130-63201
82Ω resistor template	1		✓		01131-94309
Resistive tip (blue), 91Ω	10			✓	01131-62107
Ergonomic handle	1			✓	01130-43202
Ground collar assembly for single-ended browser	2			✓	01130-60012
Socketed ground lead 6 inches	1			✓	E2676-21301

* Not orderable.

E2669B Differential Connectivity Kit

The optional E2669B differential connectivity kit provides multiple quantities of the three probe heads as shown in **Figure 12**. These probe heads allow full bandwidth probing of differential and single-ended signals. The kit can be ordered at the same time as 1130/1/2/4B probe amplifiers.

E2678B Differential Socketed
(quantity 2)

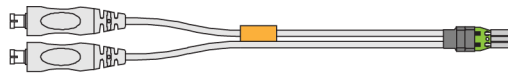

E2677B Differential Solder-In
(quantity 4)

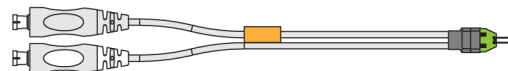

E2675B Differential Browser
(quantity 1)

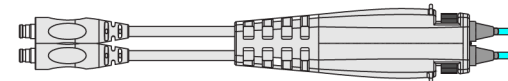

Figure 12 E2669B Differential Connectivity Kit (*not to scale*)

Table 4 Supplied Accessories

Description	Qty Supplied	Used With			Part Number *
		E2678B	E2677B	E2675B	
E2678B Differential Socketed Head	2	–	–	–	–
E2677B Differential Solder-In Head	4	–	–	–	–
E2675B Differential Browser	1	–	–	–	–
160 Ω damped wire accessory	12	✓			01130-21303
82 Ω resistor for full bandwidth	96	✓			01130-81506
Socket for 25 mil (25/1000 inch) square pins, female on both ends	8	✓			01131-85201
25 mil female socket w/20 mil round male pin on other end	8	✓			01131-85202
Heat shrink socket accessory	8	✓			01130-41101
Header adapter, 91 Ω	4	✓			01130-63201
82 Ω resistor template	1	✓			01131-94309
91 Ω resistor for full bandwidth	80		✓		1NC3-1091
150 Ω resistor for medium bandwidth	40		✓		1NC3-1150
91 Ω resistor template	1		✓		01131-94311
150 Ω resistor template	1		✓		01131-94308
Resistive tip (blue), 91 Ω	20			✓	01131-62107
Ergonomic handle	1			✓	01131-43201

* *Not orderable.*

NOTE

Resistor performance. The S2 resistors were changed from 100 Ω to 91 Ω for slightly better performance. Either value produces a response that is well within specifications. If you have some of the older 100 Ω resistors, ensure that you use either two 100 Ω or two 91 Ω resistors. Do not mix them.

N5450B Extreme Temp Cable Extension Kit

The extreme temperature cable extension kit is an accessory that allows an oscilloscope probe to be used to monitor a device in a temperature chamber. Keysight's Infiniimax probe amplifiers have a specified operating temperature range from 5° C to 40° C, but the probe heads can be operated over a much larger range of temperatures. Use the extension cables to physically separate the amplifier from the probe head which allows you to operate the probe head inside a temperature chamber while the probe amplifier remains outside the chamber.



To ensure a high-quality measurement, the N5450B cable set have been phase-matched at the factory. A coupling tag is included with the cables to ensure the cables stay as a matched pair. To install the coupling tag, slip the small end of each cable through the holes in the tag. The tag can be positioned anywhere along the length of the cable and can withstand the temperature ranges specified.

Table 5 Probing Temperature Ranges

Probe Head Configuration*	Operating Temperature Range (°C)	Expected Lifetime of the Probe Head (cycles)
E2677B	-25 to +80	> 1000
E2678A/B	-25 to +80	> 1000
N5425B + N5426A	-40 to +85	> 500
N5451A	-25 to +80	> 1000
MX0100A	-55° C dwell, 1000 hours minimum +150° C dwell, 1000 hours minimum -55° C to 150° C cycles, 1000 cycles minimum (as per JEDEC JESD22-A104 revision E)	> 1000

* Refers to the probe head or tip that is attached to the cable extension kit.

CAUTION Avoid rapid changes in temperature that can lead to moisture accumulating in the form of condensation on the probe components, as well as the DUT. If this occurs, wait until the moisture has evaporated before making any measurements.

CAUTION Additional care must be taken when handling probe heads used during extreme temperature cycling because this process makes the probe heads less robust.

CAUTION Secure the ends of the extension cable near the probe head in the temperature chamber such that the probe head legs are not tugged or moved around significantly.

CAUTION

Prevent abrasion and tears in the cable's jacket, do not rest the extension cables on any metal objects or objects with sharp edges.

CAUTION

Do not kink the cables. The cables are designed to be flexible, but are not designed to be bent sharply.

NOTE

Keep your extreme temperature testing probes separate from the probes they use under milder conditions. This is because cycling probe heads through extreme temperature ranges has a marked affect on their lifetimes as listed in [Table 5](#). Only the lifetime of the probe head is affected by temperature cycling. The extension cables and probe amplifier should not need to be replaced with extended temperature cycling.

NOTE

Discoloration or texture changes are possible with the extension cables. These changes do not, however, affect the performance or the quality of a measurement.

N2880A InfiniiMax In-Line Attenuator Kit

The in-line attenuators are an accessory for probes. The maximum input range of the 1130B probes are $5 V_{p-p}$. If you need to measure larger signals, the probe's design allows you to add the N2880A InfiniiMax in-line attenuators between the probe head and probe amplifier to increase the maximum input range (as listed in [Table 6](#) on page 26). Additionally, these attenuators enable you to increase the offset range of the probe as specified in [Table 6](#) on page 26. When using the N2880A In-Line Attenuators, the bandwidth and rise time of your probing system is not affected. There is, however, a trade-off in noise (refer to [Table 6](#)) and in the accuracy of DC offset relative to the input.

The N2880A provides a pair of 6 dB, 12 dB, and 20 dB attenuators. The attenuators come as matched pairs and should only be used with each other. Each attenuator has a serial number. The pair of matching attenuators in each set will have the same four digit numeric prefix and will differ by the last letter (one attenuator in the matched pair will be labeled A and the other will be labeled B).



Figure 13 Placement of Attenuators Between Probe Amplifier and Head

Compatibility with probe heads and amplifiers

All InfiniiMax I probe heads and amplifiers are compatible with the N2880A In-line attenuators. However, the following two limitations should be considered when planning to use N2880A attenuators.

- The maximum input voltage of the InfiniiMax probe heads is ± 30 Vdc (depending on the frequencies of your signal, the maximum allowed slew rate (see table below) may require that the maximum input voltage magnitude be less than 30V), so they should not be used to measure signals that exceed this range. This places a practical limit of 20 dB on the attenuators used with the InfiniiMax probing system. Larger attenuation ratios will only degrade the noise performance and gain of the system.
- Due to the N5380B dual-SMA probe head's maximum input voltage specification of $2.28 V_{RMS}$, the N5380B is not suitable for measuring signals large enough to require an added attenuator.

Table 6 N2880A With 1130B-Series Probe Amplifiers

Added Attenuator	Maximum Input Range (mains isolated circuits only)	Offset Range	Typical Noise Referred to	Maximum Allowed Input Slew Rate* (se = single-ended) (diff = differential)	Nominal DC Attenuation of Probe System
None	5 Vp-p	± 12 V	3 mV RMS	se: 18 V/ns, diff: 30 V/ns	10:1
6 dB (2:1)	10 Vp-p	± 24 V	7.8 mV RMS	se: 36 V/ns, diff: 60 V/ns	20:1
12 dB (4:1)	20 Vp-p	± 30 V [†]	16.7 mV RMS	se: 72 V/ns, diff: 120 V/ns	40:1
20 dB (10:1)	50 Vp-p	± 30 V	41.7 mV RMS	se: 180 V/ns, diff: 300 V/ns	100:1

* These slew rate do not apply when the N5380B SMA probe head is used with the InfiniiMax amplifiers.

† The actual range of DC voltage for these attenuators is greater than ± 30 V, but the usable range of DC voltage at the probe input is limited to ± 30 Vdc. Also, depending on the frequencies of your signal, the maximum allowed slew rate may require that the maximum input voltage magnitude be less than 30 V.

NOTE

The values shown above do not apply to the N5380B dual-SMA probe head. Due to the maximum input voltage specification of $2.28 V_{RMS}$ (mains isolated circuits only) for the N5380B, it is not suitable for measuring signals large enough to require an added attenuator.

Calibrating and Configuring Attenuators on an Infiniium Series Oscilloscope

The software in the Infiniium and InfiniiVision oscilloscopes will detect a probe when it is connected and by default will assume that no additional attenuators are installed. If you want to scale readings and settings on the oscilloscope so they are correct with the attenuators installed, refer to the procedures below for your specific oscilloscope series.

Configuring Attenuators on a Infiniium Scope

You cannot calibrate your InfiniiMax probes with the attenuators attached. Calibrate the InfiniiMax probes as you normally would (with no attenuators), configure the attenuators as discussed in the next section, and begin probing.

First, plug your InfiniiMax probe amplifier / probe head into one of the oscilloscope channels with the attenuators connected. Then enter the Probe Setup dialog box (can be reached via Setup > Probes on the oscilloscope menu). Press the Configure Probing System button. A pop-up window will appear where you can select External Scaling. Click the Decibel radio button under the External Scaling section and then set the Gain field to either -6 dB, -12 dB, or -20 dB depending on the attenuator you are using (be sure to include the negative sign). Finally, you will need to manually set the Offset field in this dialog box to zero out the signal.

Calibrating Probe with Attenuators on a InfiniiVision Scope

The following instructions only apply if you have InfiniiVision software release 5.25 or newer installed on your oscilloscope.

- 1 Plug your InfiniiMax probe amplifier / probe head into one of the oscilloscope channels with the attenuators attached.
- 2 Press the Channel on/off key to turn the channel on (if the channel is off).
- 3 Press the Probe softkey in the Channel menu. A series of probe related softkeys will appear.
- 4 Repeatedly press the second softkey from the left softkey until the probe head selection matches the attenuator you are using. The choices are:
 - 10:1 single-ended browser
 - 10:1 differential browser
 - 10:1 (+6 dB Atten) single-ended browser
 - 10:1 (+6 dB Atten) differential browser
 - 10:1 (+12 dB Atten) single-ended browser
 - 10:1 (+12 dB Atten) differential browser
 - 10:1 (+20 dB Atten) single-ended browser
 - 10:1 (+20 dB Atten) differential browser

Once the probe head configuration has been selected, you can press the Calibration key in the same probe menu and follow the on-screen instructions to calibrate the probe/attenuator setup.

Frequency Response Plots

Figure 14 on page 28 shows the frequency response plots for four setups: the probe without any attenuators, the probe with the 6 dB attenuators, the probe with the 12 dB attenuators, and the probe with the 20 dB attenuators.

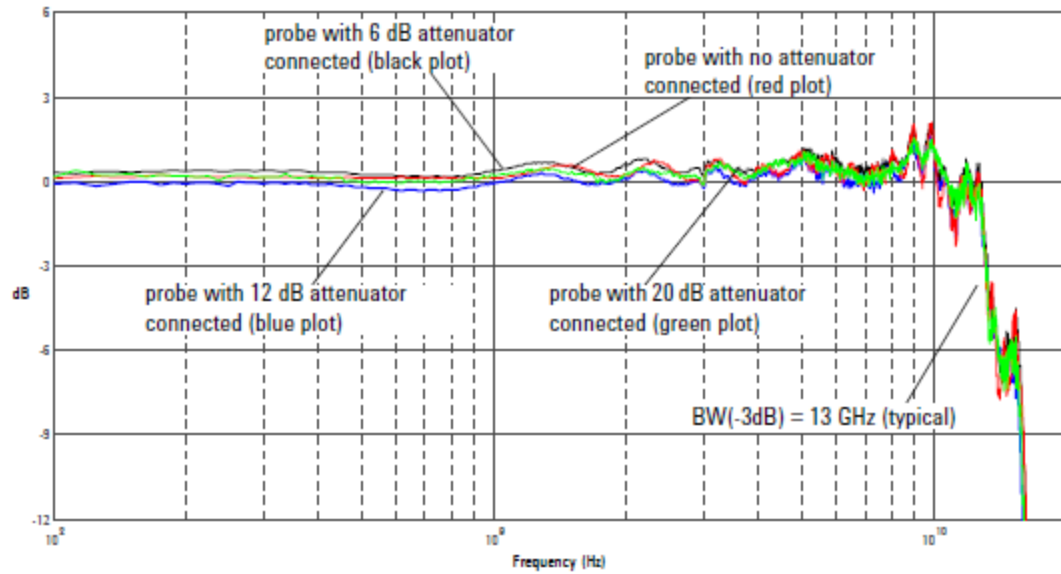

Red = $\text{dB}(V_{\text{out}}/V_{\text{in}}) + 10.8 \text{ dB of probe}$

Black = $\text{dB}(V_{\text{out}}/V_{\text{in}}) + 6\text{dB attenuator} + 10.8 \text{ dB}$

Blue = $\text{dB}(V_{\text{out}}/V_{\text{in}}) + 12 \text{ dB attenuator} + 10.8 \text{ dB of probe}$

Green = $\text{dB}(V_{\text{out}}/V_{\text{in}}) + 20 \text{ dB attenuator} + 10.8 \text{ dB of probe}$

Figure 14 Frequency Response

N2881A InfiniiMax DC Blocking Caps

The DC blocking capacitors are an accessory for the probes. The architecture of the InfiniiMax probing system allows you to place the N2881A DC Blocking Caps in between the probe amplifier and the probe head (as shown in the picture below). These N2881A InfiniiMax DC Blocking Caps block out the DC component of the input signal (up to 30 Vdc). The N2881A InfiniiMax DC Blocking Caps can be used with the N2880A In-Line Attenuators. The order of the two products in the probing system (i.e. which one is closest to the probe amplifier) does not matter.



Figure 15 Placement of DC Blocking Caps Between Probe Amplifier and Head

Figure 16 on page 29 shows the frequency response plot of the N2881A DC Blocking Caps (no probe included).

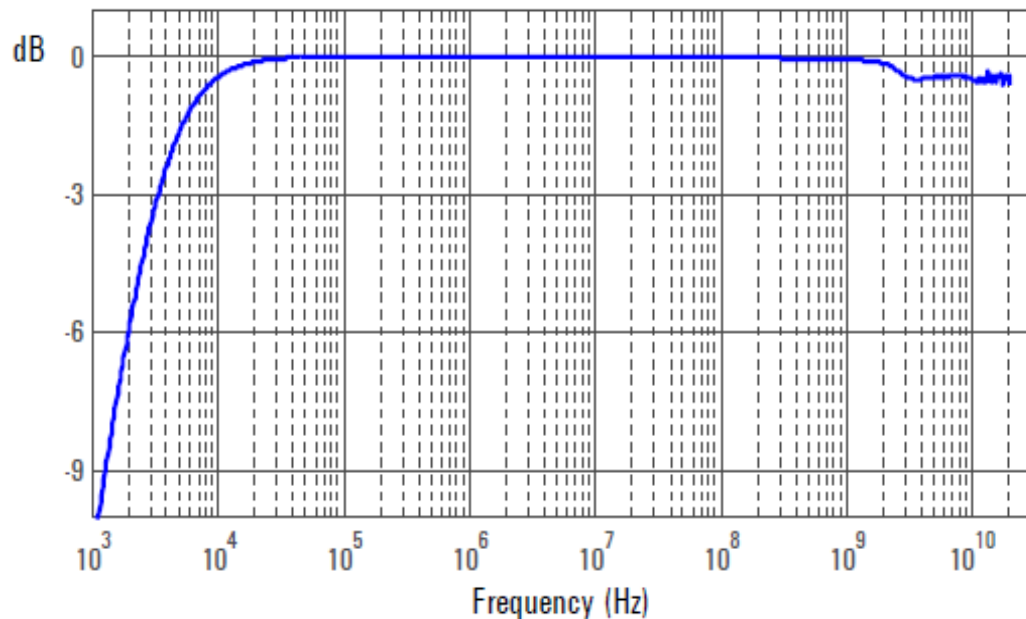

Figure 16 Graph of DC Blocking Cap insertion loss (S2,1) versus frequency (DC Blocking Cap only)

MX0102A Soldering Toolkit

The optional MX0102A soldering toolkit provides tools that can make soldering tasks easier. For instance, you can use the tools available in this kit while soldering the lead wires of the MX0100A Micro probe head to a DUT (see [page 43](#)).

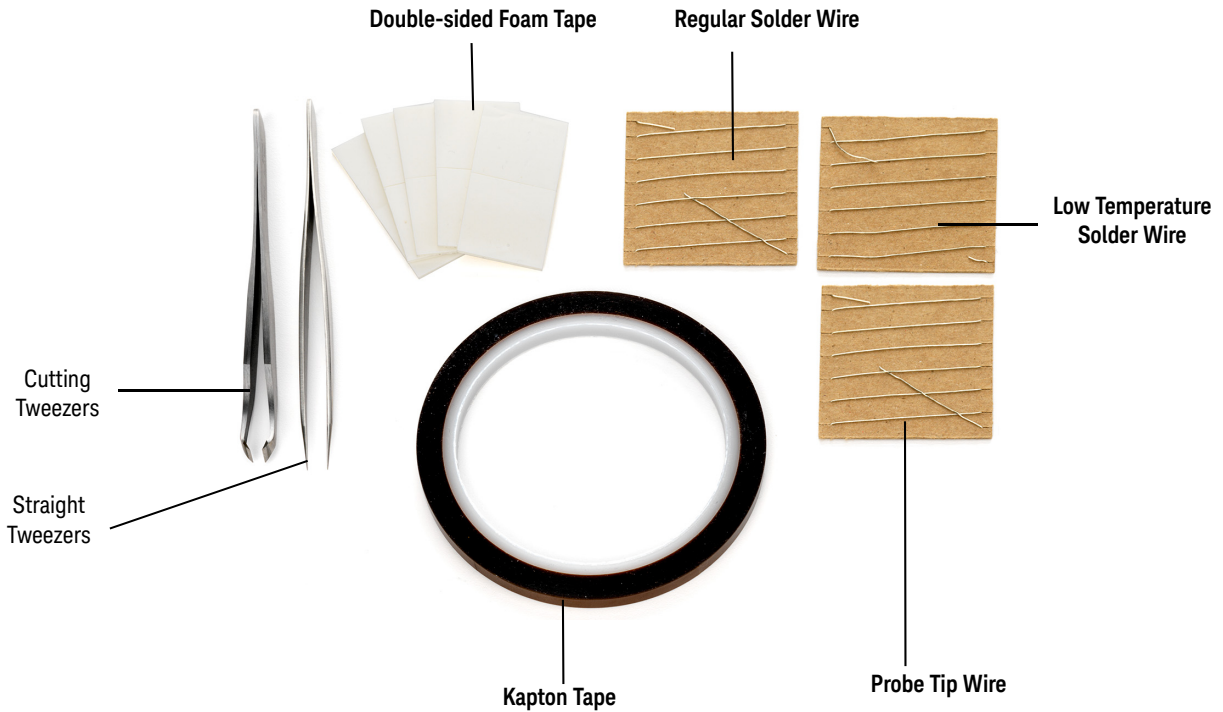

Table 7 Accessories supplied in the soldering toolkit

Description	Qty Supplied	Part Number *
Straight Tweezers (Anti-magnetic straight pointed tip 120mm) For general purpose manipulation / movement of components such as probe tip wires and probe head.	1	8710-2837
Cutting Tweezers (Narrow oblique head 115mm) To cut a probe tip wire to a desired length.	1	8710-2838
Kapton Tape (36 yards roll) To provide strain-relief to the neck portion of the probe head by taping it to a flat surface (such as a DUT circuit board).	1	0460-3121

Description	Qty Supplied	Part Number *
<p>Double-sided Foam Tape To provide strain-relief to either the neck portion of the probe head or the plastic housings by taping it to a flat surface such as a tabletop or a DUT circuit board.</p>	10	0460-3122
<p>Regular Solder Wire Lead free, .009" diameter, 2 feet long To attach the probe tip wires to a DUT using standard lead-free soldering temperatures (330 °C to 350 °C). (NOTE: This alloy melts at 217 °C.)</p>	1	MX0102-21302
<p>Low Temperature Solder Wire Lead free, .010" diameter, 2 feet long To attach the probe tip wires to a DUT using a low temperature setting on your soldering iron. (NOTE: This alloy melts at 138 °C.)</p>	1	MX0102-21303
<p>Probe Tip Wire .004" diameter, 2 feet long To add ground wires to your probe tip if InfiniiMode measurements (differential, single ended, and common mode signals with a single probe tip) are desired. Clip as short as possible using the cutting tweezers included in the kit.</p>	1	MX0102-21301

* You can reorder these items using the part numbers included in the table above.

Safety Information



This manual provides information and warnings essential for operating this probe in a safe manner and for maintaining it in safe operating condition. Before using this equipment and to ensure safe operation and to obtain maximum performance from the probe, carefully read and observe the following warnings, cautions, and notes.

This product has been designed and tested in accordance with accepted industry standards, and has been supplied in a safe condition. The documentation contains information and warnings that must be followed by the user to ensure safe operation and to maintain the product in a safe condition.

Note the external markings on the probe that are described in this document.

To avoid personal injury and to prevent fire or damage to this product or products connected to it, review and comply with the following safety precautions.

WARNING

Use Only Grounded Instruments.

Do not connect the probe's ground lead to a potential other than earth ground. Always make sure the probe and the oscilloscope are grounded properly.

WARNING

Connect and Disconnect Properly.

Connect the probe to the oscilloscope and connect the ground lead to earth ground before connecting the probe to the circuit under test. Disconnect the probe input and the probe ground lead from the circuit under test before disconnecting the probe from the oscilloscope.

WARNING

Observe Probe Ratings.

Do not apply any electrical potential to the probe input which exceeds the maximum rating of the probe. Make sure to comply with the voltage versus frequency derating curve found in this manual.

These Probe assemblies are not intended for measurements on mains circuits (CAT II, CAT III, and CAT IV).

WARNING

Indoor Use Only.

Do not operate in wet/damp environments. Keep product surfaces dry and clean.

WARNING

Periodically inspect the probe and probe wires to check for any damage. Do Not Operate With Visible or Suspected Failures. If you suspect there is damage, have it inspected by a Keysight authorized service personnel.

WARNING

Never leave the probe connected to a conductor while it is not connected to an oscilloscope or voltage measuring instrument.

WARNING

Do not install substitute parts or perform any unauthorized modification to the probe.

WARNING

Do not operate the probe or oscilloscope in the presence of flammable gasses or fumes. Operation of any electrical instrument in such an environment constitutes a definite safety hazard.

WARNING

If the probe is used in a manner not specified by the manufacturer, the protection provided by the probe assembly may be impaired.

WARNING

Do not attempt internal service or adjustment. Service should be carried out by a Keysight Technologies authorized service personnel. For any service needs, contact Keysight Technologies.

CAUTION

The probe cable is a sensitive part of the probe and, therefore, you should be careful not to damage it through excessive bending or pulling. Avoid any mechanical shocks to this product in order to guarantee accurate performance and protection.

Concerning the Oscilloscope or Voltage Measuring Instrument to Which the Probe is Connected

WARNING

Whenever it is likely that the ground protection is impaired, you must make the instrument inoperative and secure it against any unintended operation.

WARNING

If you energize the instrument by an auto transformer (for voltage reduction or mains isolation), the ground pin of the input connector terminal must be connected to the earth terminal of the power source.

WARNING

Before turning on the instrument, you must connect the protective earth terminal of the instrument to the protective conductor of the (mains) power cord. The mains plug shall only be inserted in a socket outlet provided with a protective earth contact. You must not negate the protective action by using an extension cord (power cable) without a protective conductor (grounding). Grounding one conductor of a two-conductor outlet is not sufficient protection.

WARNING

Capacitors inside the instrument may retain a charge even if the instrument is disconnected from its source of supply.

Troubleshooting

The following symptoms may indicate a problem with the probe or the way it is used. The probe is a high frequency device with many critical relationships between parts. For example, the frequency response of the amplifier on the hybrid is trimmed to match the output coaxial cable. As a result, to return the probe to optimum performance requires factory repair. If the probe is under warranty, normal warranty services apply.

Probe Calibration Fails

Probe calibration failure with an oscilloscope is usually caused by improper setup. If the calibration will not pass, check the following:

- Check that the probe passes a waveform with the correct amplitude.
- If the probe is powered by the oscilloscope, check that the offset is approximately correct. The probe calibration cannot correct major failures.
- Be sure the oscilloscope passes calibration without the probe.

Incorrect Pulse Response (flatness)

If the probe's pulse response shows a top that is not flat, check for the following:

- Output of probe must be terminated into a proper 50Ω termination. If you are using the probe with an Infiniium oscilloscope, this should not be a problem. If you are using the probe with other test gear, ensure the probe is terminated into a low reflectivity 50Ω load ($\sim \pm 2\%$).
- If the coax or coaxes of the probe head in use has excessive damage, then reflections may be seen within ~ 1 ns of the input edge. If you suspect a probe head, swap it with another probe head and see if the non-flatness problem is fixed.
- If the one of the components in the tip have been damaged there may be a frequency gain non-flatness at around 40 MHz. If you suspect a probe head, swap it with another probe head and see if the non-flatness problem is fixed.

Incorrect Input Resistance

The input resistance is determined by the probe head in use. If the probe head is defective, damaged, or has been exposed to excessive voltage, the input resistor may be damaged. If this is the case, the probe head is no longer useful. A new probe head will need to be obtained either through purchase or warranty return.

Incorrect Offset

Assuming the probe head in use is properly functioning, incorrect offset may be caused by defect or damage to the probe amplifier or by lack of probe calibration with the oscilloscope.

Returning the Probe for Service

If the probe is found to be defective we recommend sending it to an authorized service center for all repair and calibration needs. Perform the following steps before shipping the probe back to Keysight Technologies for service.

- 1 Contact your nearest Keysight sales office for information on obtaining an RMA number and return address.
- 2 Write the following information on a tag and attach it to the malfunctioning equipment.
 - Name and address of owner
 - Product model number (for example, 1130B)
 - Product Serial Number (for example, MYXXXXXXXX)
 - Description of failure or service required

NOTE

Include probing and browsing heads if you feel the probe is not meeting performance specifications or a yearly calibration is requested.

- 3 Protect the probe by wrapping in plastic or heavy paper.
- 4 Pack the probe in the original carrying case or if not available use bubble wrap or packing peanuts.
- 5 Place securely in sealed shipping container and mark container as "FRAGILE".

NOTE

If any correspondence is required, refer to the product by serial number and model number.

Contacting Keysight Technologies

For technical assistance, contact your local Keysight Call Center.

- In the Americas, call 1 (800) 829-4444
- In other regions, visit <http://www.keysight.com/find/assist>

Before returning an instrument for service, you must first call the Call Center at 1 (800) 829-4444.

1 Getting Started

2 Using Probe Heads

Recommended Configurations at a Glance	38
1. MX0100A InfiniiMax Micro Probe Head	40
2. E2677B Differential Solder-in Head with Full BW Resistors	51
3. E2678B Differential Socketed Head	53
4. E2675B Differential Browser	56
5. N5380B SMA Head (Discontinued)	59
6. N2851A QuickTip Probe Head	62
7. E2679B Single-Ended Solder-In Head	66
8. E2676B Single-Ended Browser	67
9. E2677B Differential Solder-In Head with Medium BW Resistors	69
10. E2679B Single-Ended Solder-In Head with Long Wire	71
11. E2678B Differential Socketed Head with Damped Wire Accessory	73
12. E2678B Differential Socketed Head with Header Adapter	75
Replacing Resistors on E2677B/9B Solder-In Probe Heads	76

NOTE

Graphs showing the performance of the heads for each probe amplifier are shown in [Chapter 5](#), [Chapter 6](#), [Chapter 7](#), and [Chapter 8](#).

This chapter describes the various probe heads. The probe configurations are listed in the order of the best performance to the least performance. The recommended configurations are designed to give the best probe performance for different probing situations. This allows you to quickly make the measurements you need with confidence in the performance and signal fidelity. Using the recommended connection configurations is your key to making accurate oscilloscope measurements with known performance levels.

Recommended Configurations at a Glance

Table 8 Configurations at a Glance (Sheet 1 of 2)

Recommended Order of Use	BW (GHz)	Cdiff* (pF)	Cse† (pF)	Usage
MX0100A InfiniiMax Micro Probe Head (Refer to page 40.)				
1	1134B: 7 1132B: 5 1131B: 3.5 1130B: 1.5	0.17	0.26	Differential and Single-ended signals Lowest input loading Pre-wired micro solder-in probe head kit Light, flexible, small, and reusable Designed to access small geometry target devices
E2677B Differential Solder-In (full bandwidth resistors) (Refer to page 51.)				
2	1134B: 7 1132B: 5 1131B: 3.5 1130B: 1.5	0.27	0.44	Differential and Single-ended signals Solder-in hands free connection Hard to reach targets Very small fine pitch targets Characterization
E2678B Differential Socketed (full bandwidth resistors) (Refer to page 53.)				
3	1134B: 7 1132B: 5 1131B: ~3.5 1130B: 1.5	0.34	0.56	Differential and Single-ended signals Removable connection using solder-in resistor pins Hard to reach targets
E2675B Differential Browser (Refer to page 56.)				
4	1134B: ~6 1132B: 5 1131B: ~3.5 1130B: 1.5	0.32	0.57	Differential and Single-ended signals Hand-held browsing Probe holders General purpose troubleshooting Ergonomic handle available
N5380B Differential SMA Head (Refer to page 59.) (Discontinued and replaced by MX0105A Differential SMA Head)				
5	1134B: 6 1132B: 5 1131B: 3.5 1130B: 1.5	N/A	N/A	Full bandwidth Preserve oscilloscope channels as opposed to using the A minus B mode. Removes inherent cable loss through compensation. Common mode termination voltage can be applied Offset matched sma cables adapt to variable spacing
N2851A QuickTip Probe Head (Refer to page 62.)				
6	1134B: 7 1132B: 5 1131B: 3.5 1130B: 1.5	340 fF	200 fF	Easy, secure magnetic connection between head and tip. Use N2848A and N2849A with InfiniiMax III+ amplifier for InfiniiMode function.
E2679B Single-Ended Solder-In (full bandwidth resistors) (Refer to page 66.)				

Table 8 Configurations at a Glance (Sheet 2 of 2)

Recommended Order of Use	BW (GHz)	Cdiff* (pF)	Cse† (pF)	Usage
7	1134B: ~ 5.2 1132B: 5 1131B: ~ 3.5 1130B: 1.5	N/A	0.50	Single-ended signals only Solder-in hands free connection when physical size is critical Hard to reach targets Very small fine pitch targets
E2676B Single-Ended Browser (Refer to page 67.)				
8	1134B: ~ 5.5 1132B: 5 1131B: ~3.5 1130B: 1.5	N/A	0.65	Single-ended signals only Hand or probe holder where physical size is critical General purpose troubleshooting Ergonomic handle available
E2677B Differential Solder-In (medium bandwidth resistors) (Refer to page 69.)				
9	1134B: ~ 2.9 1132B: ~ 2.9 1131B: ~ 2.9 1130B: 1.5	0.33	0.52	Differential and Single-ended signals Solder-in hands free connection Larger span and reach than #1 Very small fine pitch targets
E2679B Single-Ended Solder-In with Long Wire (Refer to page 71.)				
10	1134B: ~ 2.2 1132B: ~ 2.2 1131B: ~ 2.2 1130B: 1.5	N/A	0.58	Single-ended signals only Solder-in hands free connection when physical size is critical Larger span and reach than #4 Hard to reach targets Very small fine pitch targets
E2678B Differential Socketed with Damped Wire Accessory (Refer to page 73.)				
11	1134B: ~ 1.2 1132B: ~ 1.2 1131B: ~ 1.2 1130B: ~ 1.2	0.63	0.95	Differential and Single-ended signals For very wide spaced targets Connection to 25 mil square pins when used with supplied sockets
E2678B Differential Socketed with Header Adapter (Refer to page 75.)				
12	1134B: ~ 1.2 1132B: ~ 1.2 1131B: ~ 1.2 1130B: ~ 1.2	0.70	0.97	Differential and Single-ended signals For very wide spaced targets Connection to 25 mil square pins when used with supplied sockets

* Capacitance seen by differential signals

† Capacitance seen by single-ended signals

1. MX0100A InfiniiMax Micro Probe Head



The MX0100A is a small, flexible, and lightweight solder-in probe head that allows you to conveniently probe denser and smaller-sized target devices.

The micro size and flexibility features of this probe head overcome the probing challenges faced with the smaller pads and narrower spacing in such small devices..



This probe head configuration supports the highest bandwidth and provides the full bandwidth signals (1134B: 7 GHz, 1132B: 5 GHz, 1131B: 3.5 GHz, and 1130B: 1.5 GHz) and the lowest capacitive loading for measuring both single-ended and differential signals.

This probe head connects easily to an InfiniiMax probe amplifier using the bullet adapter shipped with the probe head.

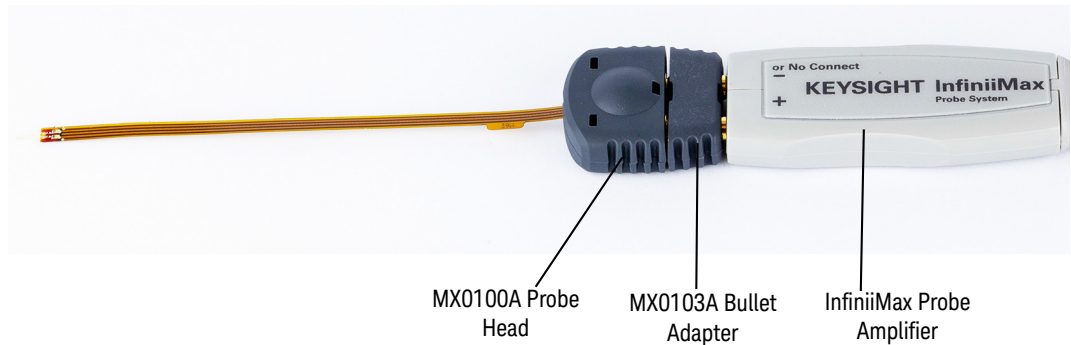

For connection to a DUT, it has pre-wired probe tip leads that allow solder-in connection to very small, fine pitch targets.

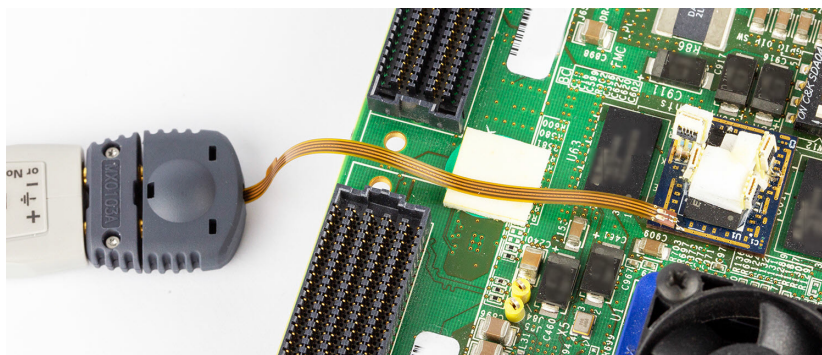

Figure 17 MX0100A probe head connected to DUT and InfiniiMax probe amplifier

NOTE

When probing differential signals, the + and – connection of the MX0100A probe head can be determined when the probe head is plugged into the probe amplifier. The + and - indicators on the probe amplifier represent the + and - inputs on MX0100A probe head. When probing single-ended signals, ensure that the - input of the probe amplifier is connected to the ground of the DUT.

Extreme Temperature Testing with MX0100A Probe Head

The MX0100A probe head can withstand temperatures from -55°C to $+150^{\circ}\text{C}$ thereby making it suitable for extreme temperature environments such as temperature chambers. For extreme temperature testing, use the MX0100A probe head with the N5450B InfiniiMax extreme temperature extension cable.

CAUTION

InfiniiMax probe amplifiers cannot withstand extreme temperatures (-55°C to $+150^{\circ}\text{C}$) that the MX0100A probe head can withstand. Be cautious not to subject these probe amplifiers to extreme temperatures. Using the N5450B extension cable with the MX0100A probe head physically separates the amplifier from the probe head and therefore eliminates the chances of amplifier's exposure to extreme temperatures.

To know more about the N5450B extension cable and cautions associated with using an InfiniiMax probe head in extreme temperature testing, refer to "[N5450B Extreme Temp Cable Extension Kit](#)" on page 22".

The MX0100A probe head components may undergo discoloration when used under high temperatures. Such changes do not, however, affect the probe head's performance or measurement quality. The probe head maintains its specified frequency response and bandwidth over the operating temperature range (-55°C to $+150^{\circ}\text{C}$), without any need for compensation or correction.



Before usage under high temperatures



Discoloration after usage under high temperatures

Required Infiniium Software Version

The MX0100A probe head requires the Infiniium software version 6.3 or higher.

Table 9 MX0100A Probe Head Kit Components

Component	Quantity *			Part Number
	Option 001	Option 002	Option 003	
Micro Probe Heads (with pre-wired probe tips) *	5	25	50	MX0100A
Probe Tip Wire (.004" diameter) (To make ground connections)	1 wire spool	5 wire spools	10 wire spools	MX0102-21301
Bullet Adapter	1	5	10	MX0103A
Trim Gauge Template (see Figure 18)	1	5	10	MX0100-94302

* Quantity varies based on the purchased option.

NOTE

If the probe tip lead wire is damaged or worn out, replace the lead wire using the procedure [“Replacing an MX0100A Probe Tip Lead Wire”](#) on page 48”.

To know how to avoid damage to the MX0100A probe head, refer to the topic [“MX0100A Probe Head Handling Precautions”](#) on page 45”.

Trimming the Lead Wires of MX0100A Probe Head

Before soldering, trim the probe head’s lead wires matching your DUT’s geometry. You can choose from the following lead wire lengths:

- **135 mil (3.4 mm)** - The probe head is shipped with this factory-trimmed standard length. Use this lead wire length to accommodate variable-pitch targets. With this length, you get the maximum convenience in terms of longer reach and the available bandwidth is the full bandwidth of the probe amplifier being used (1134B: 7 GHz, 1132B: 5 GHz, 1131B: 3.5 GHz, and 1130B: 1.5 GHz).
- **60 mil (1.5 mm)** - If your DUT’s geometry allows you to use shorter lead wire length, trim the wires to this length to get the maximum performance. Use this lead wire length to accommodate small fine-pitch targets. The available bandwidth is the full bandwidth of the probe amplifier being used (1134B: 7 GHz, 1132B: 5 GHz, 1131B: 3.5 GHz, and 1130B: 1.5 GHz).

NOTE

You need to specify your choice of lead wire length (3.4 mm or 1.5 mm) in the Probe Configuration dialog box of the Infiniium software GUI. This allows the software to load the appropriate s parameter file applicable to that wire length. The s parameter file adjusts the frequency response to enhance the measurements accuracy.

To properly trim the probe head's lead wires

- 1 Use the Keysight supplied trim gauge template that is included as part of the MX0100A probe head kit.

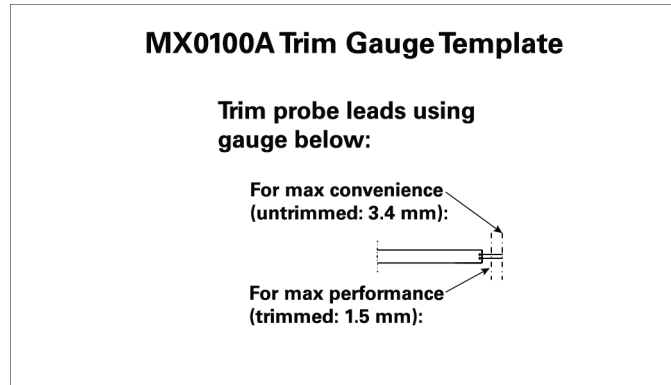

Figure 18 MX0100A Trim Gauge Template (MX0100-94302)

- 2 Using tweezers, place the lead wire over the outline of the lead wires as shown on the trim gauge template. The trim gauge template displays two lengths: 3.4 mm and 1.5 mm. Choose the correct length as per your DUT.
- 3 Using the cutting tweezers, trim the lead wires even with the trim lines.

NOTE

You can spread the probe head's lead wires within the range of 0mm to 7mm span without causing any significant variation in its available bandwidth.

Soldering an MX0100A Probe Head to DUT

NOTE

The tools included in the MX0102A soldering toolkit can be of great use while soldering the MX0100A probe head to DUT (see [page 30](#)). You may purchase this toolkit separately.

To solder the probe tip lead wires to DUT

- 1 Trim the length of the MX0100A probe head lead wires to match your DUT's geometry (see [page 42](#)). You may use the cutting tweezers (Keysight part number 8710-2838) included in the Soldering toolkit.

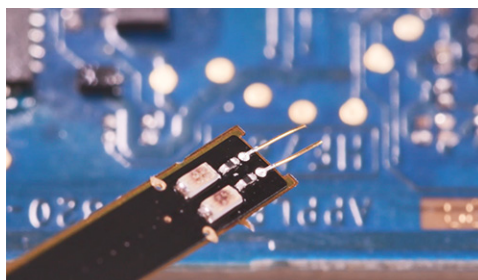

- 2 Apply flux to both DUT and MX0100A probe tip lead wires. Always use plenty of flux, even if your solder already contains flux. This cleans the solder joint and allows for easier flowing solder and quicker dwell times.

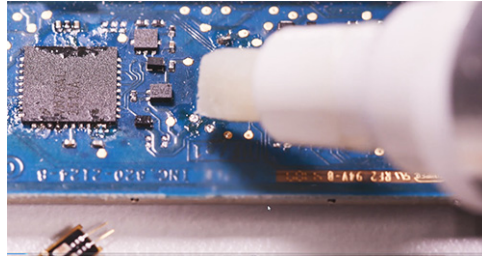

- 3 Add solder to existing test points on DUT, if necessary. Heat momentarily and do not dwell any longer than necessary!

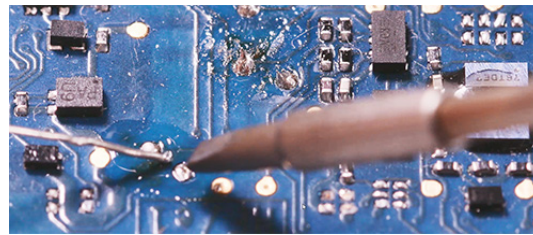

- 4 Connect the MX0100A probe head's lead wires to DUT by positioning these wires on DUT and then reflowing joint while heating momentarily. .

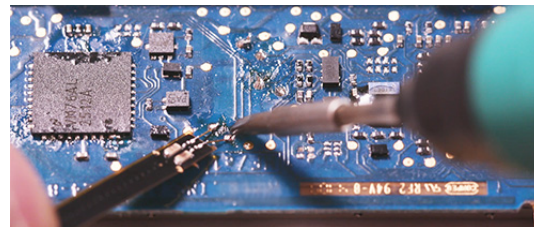

NOTE

Keep the temperature as low as possible while still reflowing the solder at the joint of concern. The following are some of the useful tips to maintain low temperature during soldering.

- A temperature-controlled soldering iron is the best way to do this. Set it for no more than 350°C if using standard lead-free solders and 150°C for tin-bismuth solder.

- Do not rest a soldering iron on a probe joint for more than a few seconds.

- 5 Provide strain-relief to the probe head by taping its mid portion to a flat surface such as a tabletop using the double-sided foam tape (such as Keysight part

number 0460-3122 included in the MX0102A Soldering Toolkit). You can also use putty, Velcro or low temperature hot glue instead.

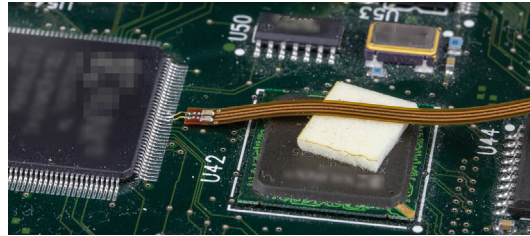

- 6 Connect the soldered MX0100A probe head to the InfiniMax probe amplifier using the supplied MX0103A bullet adapter.



- 7 Provide strain-relief to the probe head and probe amplifier plastic housings by using a double-sided foam tape (Keysight part number 0460-3122 included in the MX0102A Soldering Toolkit)..



NOTE

To view a demo on how to solder the lead wires to the DUT, visit www.keysight.com/find/MX0100A and click the demo file displayed under Document Library.

MX0100A Probe Head Handling Precautions

One of the advantages of the MX0100A probe head is its reusability feature. This section describes some of the cautions and tips on how to properly handle the MX0100A probe head to prevent damage and maintain high performance and reusability of the probe head.

To prevent damage and ensure reusability of the MX0100A probe head

- After you have connected the MX0100A probe head electrically to a DUT via solder, it is best to secure it mechanically as well. Always provide strain relief to the probe head setup using putty, velcro, low temperature hot glue, or double-sided foam tape to prevent any unnecessary strain to the probe head and to protect delicate connections.
- Strain relief is recommended at the probe head and amplifier housings as well as at the probe head cable.

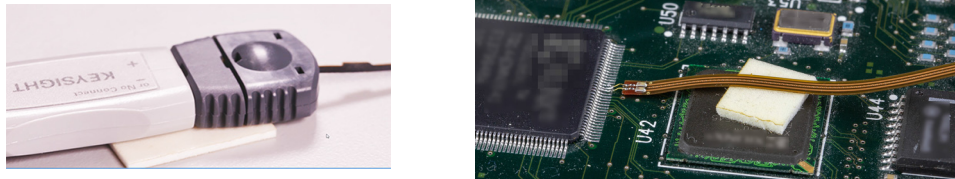

Figure 19 Example of a properly strain-relieved MX0100A probe head setup

- While moving a soldered MX0100A probe head, always ensure that you do not twist, pull, tightly bend, or apply force near the probe head's cable housing.

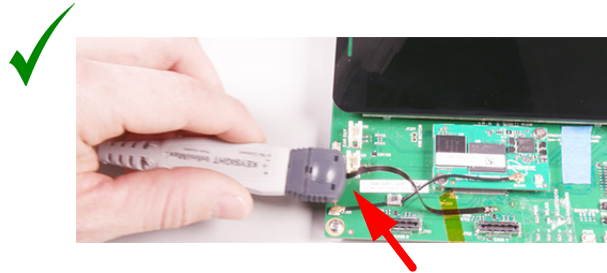

Figure 20 Example of correct movement of MX0100A probe head

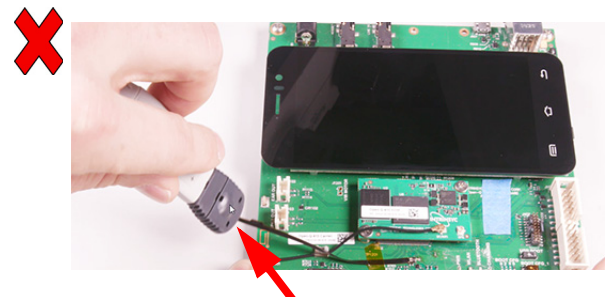
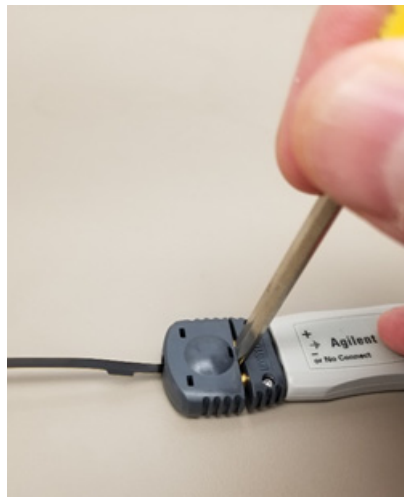

Figure 21 Example of incorrect movement of MX0100A probe head

- Use a microscope setup while performing soldering/de-soldering tasks. A microscope with the following features is recommended.
 - Binocular eyepieces
 - Adjustable magnification (at least 20x)

- Good working distance from the sample (at least 4 inches)
- Adjustable arm
- Integrated ring light around the objective lens
- Ensure that there is less thermal stress on the probe head as well as DUT by:
 - Using a high quality temperature controlled soldering iron with the tip temperature set as low as possible (just high enough to melt the alloy).
 - Using a low temperature solder alloy such as SAC (Tin / Silver / Copper) with 220 °C melting point), or tin-bismuth solder with 138 °C melting point.
- Do not apply heat on the probe tip leads for a time period longer than two seconds.
- Use a small solder iron tip (<1mm is recommended).
- No clean (non-conductive) and less acidic flux is recommended.
- While disconnecting the probe head from the MX0103A bullet adapter:
 - either gently pull the bullet adapter from the probe head by hand
 - or engage a flat screwdriver on the notch provided on the bullet adapter and gently disconnect the probe head from bullet adapter.



To check the MX0100A probe head for any damage

You can use a Digital Multimeter to check the resistance measurement of your MX0100A probe head. If the resistance measurement between the probe head’s tip and tail is 25.2 kohm, then the probe head is usable,



Figure 22 Resistance measurement for an undamaged MX0100A probe head

For a damaged probe head, the resistance measurement between the MX0100A probe head tip wire and the center conductor of the SMP connector of the MX0100A is displayed as Infinite.



Figure 23 Resistance measurement for a damaged MX0100A probe head

Replacing an MX0100A Probe Tip Lead Wire

Use the following procedure to install or replace the lead wires on the MX0100A probe head in the event of damage or break off due to use. Depending on your probing application, you can order either 9 mil or 10 mil wire as listed in the following table. These wires are also included in the Keysight MX0102A Soldering Toolkit (see [page 30](#) for details).

Table 10 Required Wire Types

Wire Type	Wire Diameter	Part Number
Regular Solder Wire (lead free) Requires standard lead-free soldering temperatures (330 °C to 350 °C). (NOTE: This alloy melts at 217 °C.)	.009" diameter	MX0102-21302

Table 10 Required Wire Types

Wire Type	Wire Diameter	Part Number
Low Temperature Solder Wire (lead free) Requires a low temperature setting on your soldering iron. (NOTE: This alloy melts at 138 °C.)	.010" diameter	MX0102-21303

- 1 Secure the tip of the MX0100A probe head on a raised off position from the table. You may use a double-sided foam tape (Keysight part number 0460-3122 included in the MX0102A Soldering Toolkit). Keep the lead wires solder joints off the raised base to facilitate soldering. Cover the entire probe head tip with Kapton tape while ensuring that the lead wires solder joints are fully exposed for soldering.

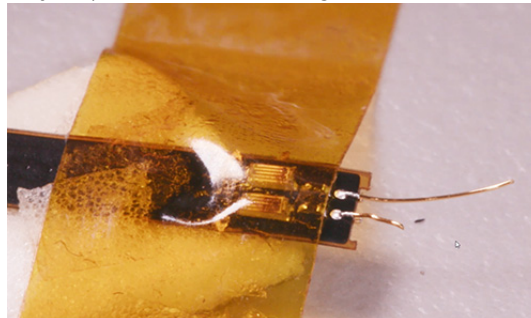

- 2 Remove the damaged lead wire from the via by grabbing it with tweezers and pulling up very gently. Touch the soldering iron to the solder joint just long enough for the lead wire to come free of the probe head tip.

CAUTION

To avoid burning and damage to the probe head, do not keep the soldering iron in contact with the tip any longer than necessary. The solder joint quickly melts and releases the wire.

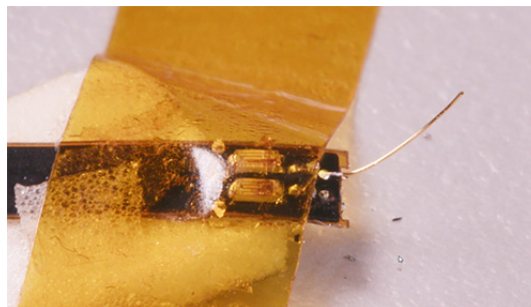

- 3 Position the end of the new lead wire (Keysight part number MX0102-21302 or MX0102-21303 included in the MX0102A Soldering Toolkit) over the via hole. Touch the soldering iron to the side of the hole. When the solder in the hole

melts, the lead wire will fall into the hole. Remove soldering iron as soon as the lead wire falls into the hole..

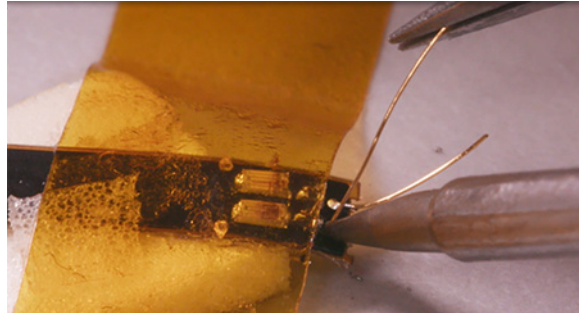

- 4 Apply flux on the solder joint, Then apply a small amount of solder to the tip of the soldering iron. Touch the solder tip (with the solder on it) to the solder joint. Do not dwell on the joint with the solder iron any longer than needed. The solder should flow off the soldering iron tip into the joint. If it does not flow, then sufficient flux may not have been used.

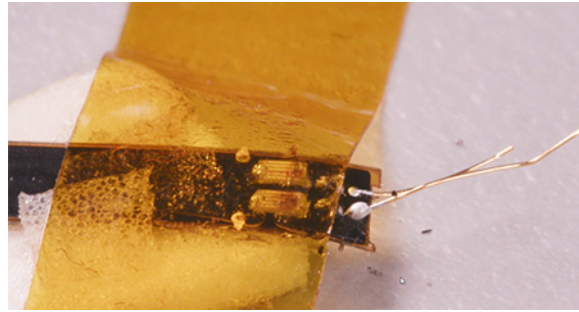

- 5 Cut the extra wire off using a cutting tweezer (Keysight part number 8710-2838 included in the MX0102A Soldering Toolkit).

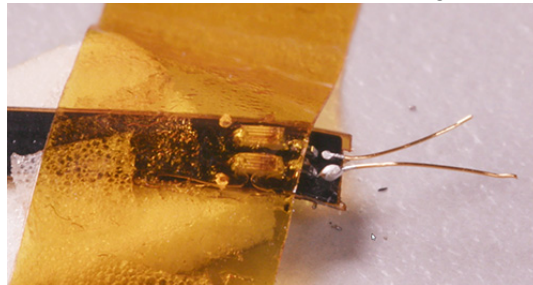

- 6 Remove the Kapton tape.

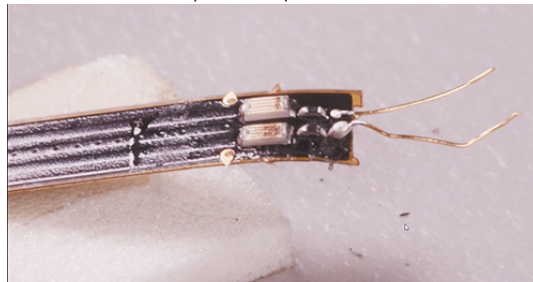

2. E2677B Differential Solder-in Head with Full BW Resistors



This probe configuration provides the full bandwidth signals and the lowest capacitive loading for measuring both single-ended and differential signals.

This head allows a soldered connection into a system for a reliable, hands-free connection. At the tip it uses a miniature axial lead resistor with 8 mil diameter leads which allows connection to very small, fine pitch targets.

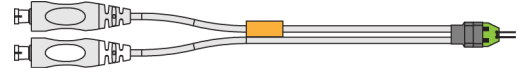

Table 11 Bandwidth

Probe Amplifier	BW (GHz)	Probe Amplifier	BW (GHz)
1130B	1.5	1132B	5
1131B	3.5	1134B	7

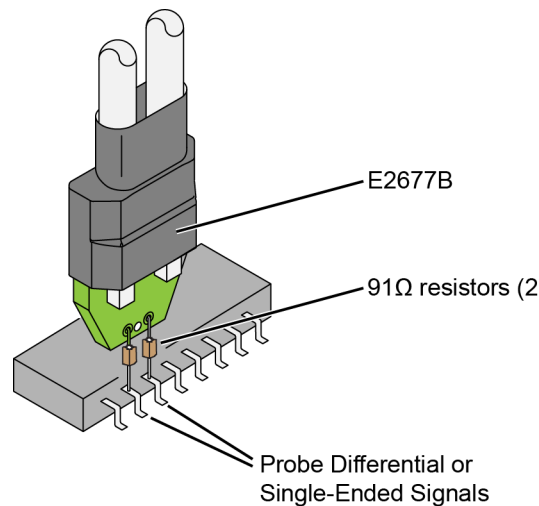

Figure 24 E2677B

The probe head resistors must be soldered to the circuit that you are measuring. Because of the small size of the resistor leads, it is easy to solder them to very small geometry circuits.

NOTE

To install or repair resistor leads. Refer to [“Replacing Resistors on E2677B/9B Solder-In Probe Heads”](#) on page 76”.

NOTE

Performance plots. Refer to [Chapter 5](#), “1130B Performance Data Plots, [Chapter 6](#), “1131B Performance Data Plots, [Chapter 7](#), “1132B Performance Data Plots, and [Chapter 8](#), “1134B Performance Data Plots.

CAUTION

Do not solder in resistor leads with a big ball of solder right next to the resistor body. Normally the nickel lead will limit the heat transfer to the resistor body and protect the resistor, but if a ball of solder is right next to the resistor body on the lead, the resistor may come apart internally.

CAUTION

When soldering leads to DUT always use plenty of flux. The flux will ensure a good, strong solder joint without having to use an excessive amount of solder.

CAUTION

Strain relieve the micro coax leading away from the solder-in tips using hook-and-loop fasteners or adhesive tape to protect delicate connections.

NOTE

Before using the resistors, the resistor wires must be cut to the correct dimensions. For the correct dimensions see [“Replacing Resistors on E2677B/9B Solder-In Probe Heads”](#) on page 76”.

Table 12 Supplied Accessories

Description	Qty Supplied	Part Number
91Ω resistor for full bandwidth	20	1NC3-1091 <i>(not orderable)</i>
150Ω resistor for medium bandwidth	10	1NC3-1150 <i>(not orderable)</i>
91Ω resistor template	1	01131-94311 <i>(not orderable)</i>
150Ω resistor template	1	01131-94308 <i>(not orderable)</i>

3. E2678B Differential Socketed Head



This probe configuration allows a removable, hands-free connection that provides full bandwidth with a minor increase in capacitance over the probe head for probing differential and single-ended signals. Additionally, 3.6 cm resistor tip wire accessories are provided for high fidelity lower bandwidth probing of signals with very wide spacing. It is recommended that a 25 mil diameter plated through hole on the board for mounting the lead resistors.

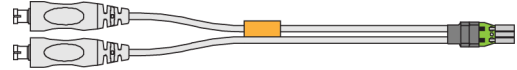

NOTE

The E2678B is a direct replacement for the E2678A that provides a more robust connection between the E2678B head's socket and printed circuit board. The E2678B's performance and fit are identical to that of the E2678A.

Table 13 Bandwidth

Probe Amplifier	BW (GHz)	Probe Amplifier	BW (GHz)
1130B	1.5	1132B	5
1131B	~3.5	1134B	7

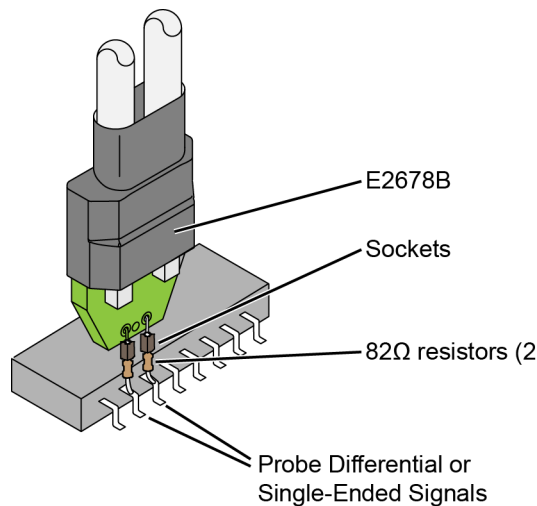

Figure 25 E2678B

The 82Ω axial lead resistors are soldered to the circuit that you are measuring. The socketed differential probe head is plugged onto the resistors. This makes it easier to move the probe from one location to another. Because of the larger size of the resistor leads, the target for soldering must be larger than the solder-in probe heads.

NOTE

To install or repair resistor leads. Refer to the information found in this section.

NOTE

Performance plots. Refer to [Chapter 5](#), “1130B Performance Data Plots, [Chapter 6](#), “1131B Performance Data Plots, [Chapter 7](#), “1132B Performance Data Plots, and [Chapter 8](#), “1134B Performance Data Plots.

PC Board Target Dimensions

The spacing for the socketed tip differential probe head is 0.100 inch (2.54 mm). For soldering on a PC board, the targets can be two vias that can accept the 0.020 inch (0.508 mm) diameter resistor leads. A via of 0.025 inch (0.0635 mm) diameter is recommended. If soldering a resistor lead to a surface pad on your PC board, the resistor leads can be bent in an "L" shape and soldered down. A pad size of at least 0.030 x 0.030 inch (0.762 mm x 0.762 mm) is recommended.

Shaping the Resistors

Before installing the 82Ω resistors (01130-81506) onto your device under test, the resistor wires must be trimmed using diagonal cutters and bent to the correct dimensions as shown in [Figure 26](#). Use tweezers, to place the resistor body inside the rectangle of the supplied trim guage. Use diagonal cutters to trim the leads even with the trim lines.

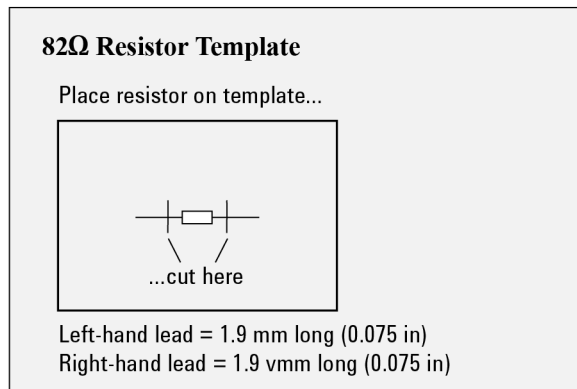
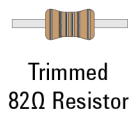

Figure 26 Resistor Trim Dimensions and Trim Guage

Table 14 Supplied Accessories

Description	Qty Supplied	Part Number
160 Ω damped wire accessory	6	01130-21303
82 Ω resistor for full bandwidth	48	01130-81506 <i>(not orderable)</i>
Socket for 25 mil (25/1000 inch) square pins, female on both ends	4	01131-85201 <i>(not orderable)</i>
25 mil female socket w/20 mil round male pin on other end	4	01131-85202 <i>(not orderable)</i>
Heats hrink socket accessory	4	01130-41101 <i>(not orderable)</i>
Header adapter, 91 Ω	2	01130-63201
82 Ω resistor template	1	01131-94309

4. E2675B Differential Browser



The E2675B differential browser configuration is the best choice for general purpose troubleshooting of a circuit board. This probe head provides the highest performance hand-held browser for measuring differential and single-ended signals while maintaining excellent usability due to the adjustable tip spacing and full z-axis compliance. The tab on the side of the probe allows the probe tips to be adjusted for different circuit geometries.

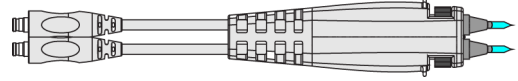

Table 15 Bandwidth

Probe Amplifier	BW (GHz)	Probe Amplifier	BW (GHz)
1130B	1.5	1132B	5
1131B	~3.5	1134B	6

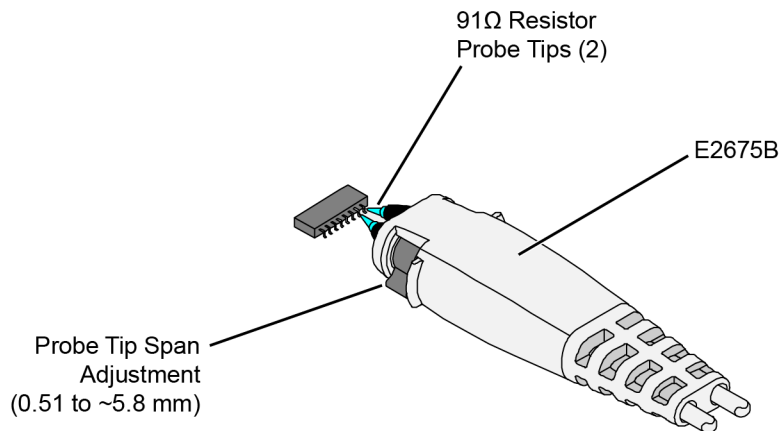

Figure 27 Differential Browser

NOTE

Performance plots. Refer to [Chapter 5](#), “1130B Performance Data Plots, [Chapter 6](#), “1131B Performance Data Plots, [Chapter 7](#), “1132B Performance Data Plots, and [Chapter 8](#), “1134B Performance Data Plots.

CAUTION

Do not use the E2675B probe head as a tool to scrape solder mask or other items off of a circuit board. The blue tips can easily be broken off if the browser is not used properly. Always hold the probe head so that the blue tips remain vertical during measurements as shown in [Figure 28](#).



Figure 28 Proper Vertical Orientation of the Blue Tips

When holding the E2675B for extended periods of time, use the supplied ergonomic handle. **Figure 29** on page 57 and **Figure 30** on page 57 show how to attach and remove the handle from the probe head.

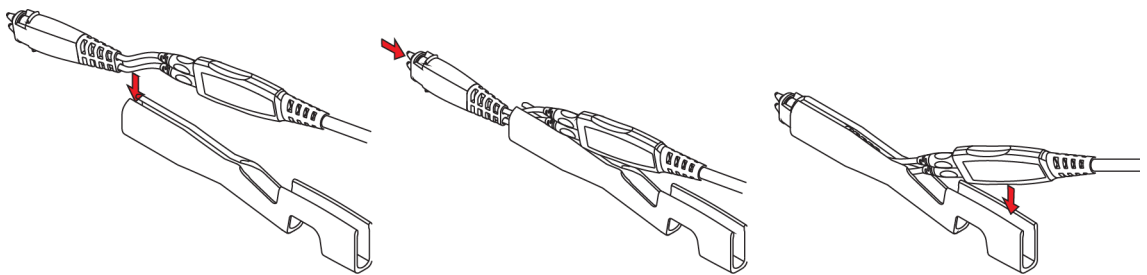

Figure 29 Inserting the Probe

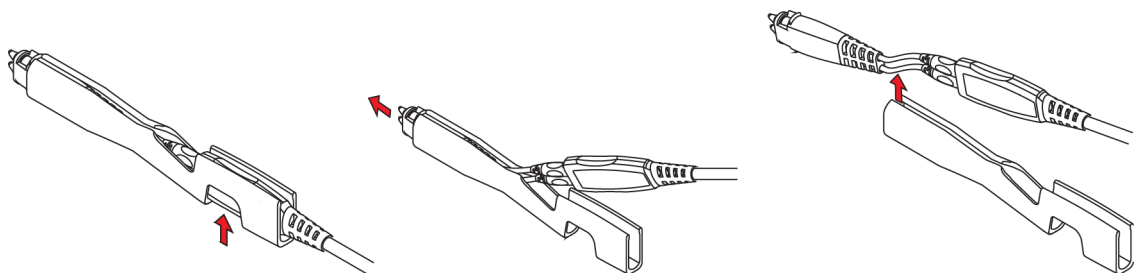

Figure 30 Removing the Probe

Table 16 Supplied Accessories

Description	Qty Supplied	Part Number
Resistive tip (blue), 91Ω	20	01131-62107
Ergonomic handle	1	01131-43201

5. N5380B SMA Head (Discontinued)

This probe head has been replaced by MX0105A SMA head. Refer to the MX0105A page in the Probe Resource Center (PRC) <https://www.keysight.com/find/PRC> to know more.

The N5380B SMA probe head provides the highest bandwidth for connecting to SMA connectors. The input resistance is 50Ω on both inputs. A shorting cap connects one side of both resistances to ground. For applications that require the resistances to be referenced to a voltage other than ground, the shorting cap can be removed and a dc voltage can be applied.



NOTE

The E2695A 8 GHz SMA head for InfiniiMax I probe amplifiers was discontinued in December 2013 and replaced by the N5380B 12 GHz SMA head.

Table 17 Bandwidth

Probe Amplifier	BW (GHz)	Probe Amplifier	BW (GHz)
1130B	1.5	1132B	5
1131B	~3.5	1134B	5.2

NOTE

Performance plots. Refer to "N5380B SMA Probe Head" on page 204".

Disconnecting the N5380B

When disconnecting a probe amplifier from the N5380B SMA probe head, grasp the probe amplifier as shown in **Figure 31** on page 60 and pull it straight away from the SMA probe head without any rocking (either side-to-side or up-and-down).

CAUTION

Pulling on the probe amplifier cable or strain relief, or rocking the probe amplifier to remove it, may damage the probe head or probe amplifier.

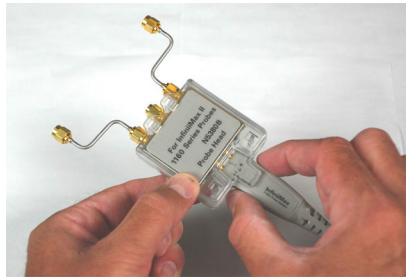

Figure 31 Disconnecting the N5380B

N5380A/B Head Support

The probe amplifier can become damaged if the N5380A/B does not have an N5380-64701 SMA head support attached. N5380B heads come with the SMA head support already attached. For older N5380A heads, the head support can be ordered. As shown in **Figure 32**, the current design of the N5380-64701 has been changed from the original design. The original design is no longer offered. Both the original and new design provide the same level of protection for the probe amplifier and can be attached to both N5380B and N5380A heads.

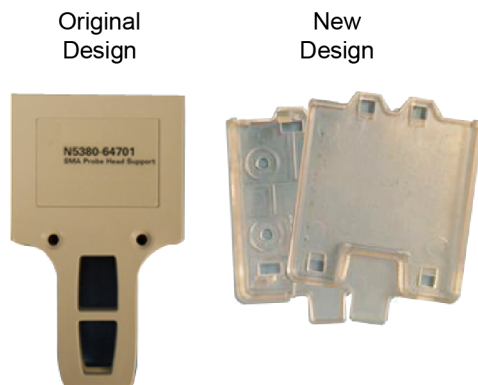

Figure 32 Original and New Head Support Designs

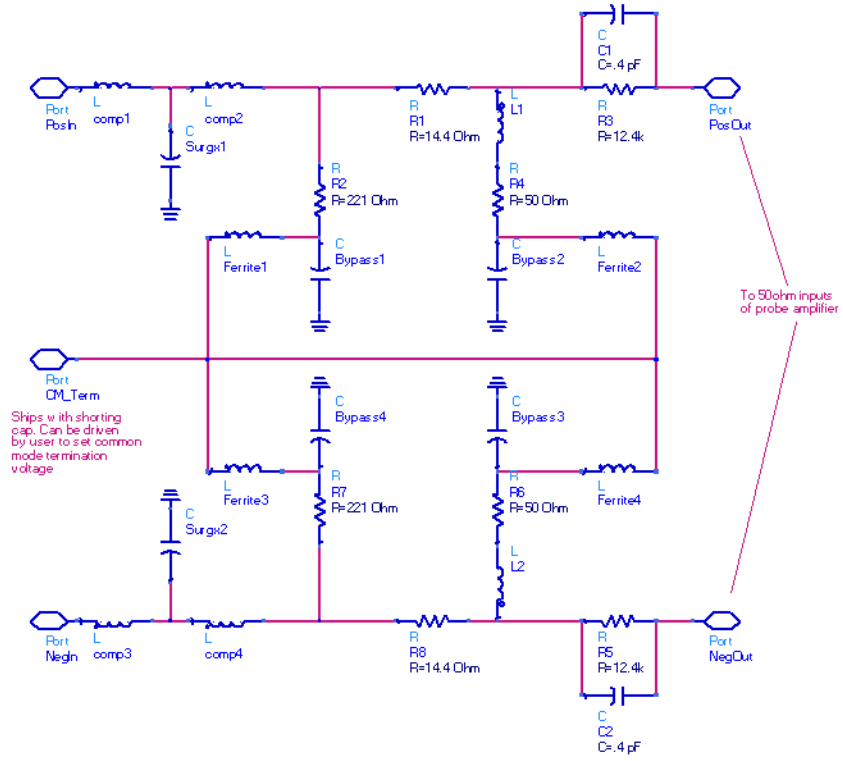

Figure 33 N5380B Schematic

6. N2851A QuickTip Probe Head

The N2851A QuickTip probe head is used with an N2849A QuickTip and together they provide the following advantages:



- Easy-to-make secure magnetic mechanical connection between the probe head and QuickTip. Three magnets in the head connect the two sides of a differential signal and a ground. No latch lever is used!

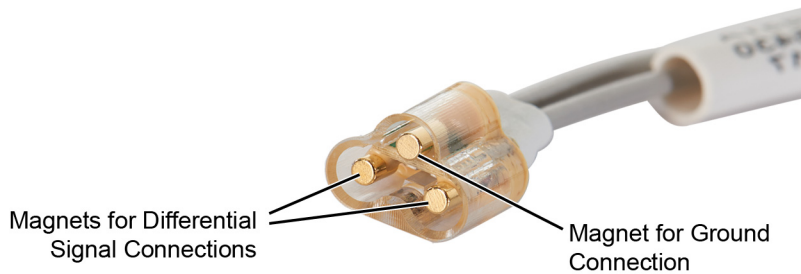

Figure 34 Magnet Connections in Probe Head

- Extreme temperature environments such as temperature chambers.

Table 18 Bandwidth

Probe Amplifier	BW (GHz)	Probe Amplifier	BW (GHz)
1130B	1.5	1132B	5
1131B	3.5	1134B	7

Permanently solder any number of QuickTips to your DUT as shown in [Figure 35](#) on page 63. Because the probe head is magnetically connected (instead of mechanically connected) to the QuickTip, you can effortlessly connect and disconnect to each QuickTip. For best performance, position the QuickTip vertically on the DUT. The N2849A QuickTip has two signal leads and two ground leads. The ground leads have minimal effect on your differential measurements. However, if you are making only differential measurements you can optionally cut off the ground leads or fold them out of the way. Be aware that without the ground leads, the mechanical stability of the QuickTip will be reduced and you will need to stabilize the probe head.

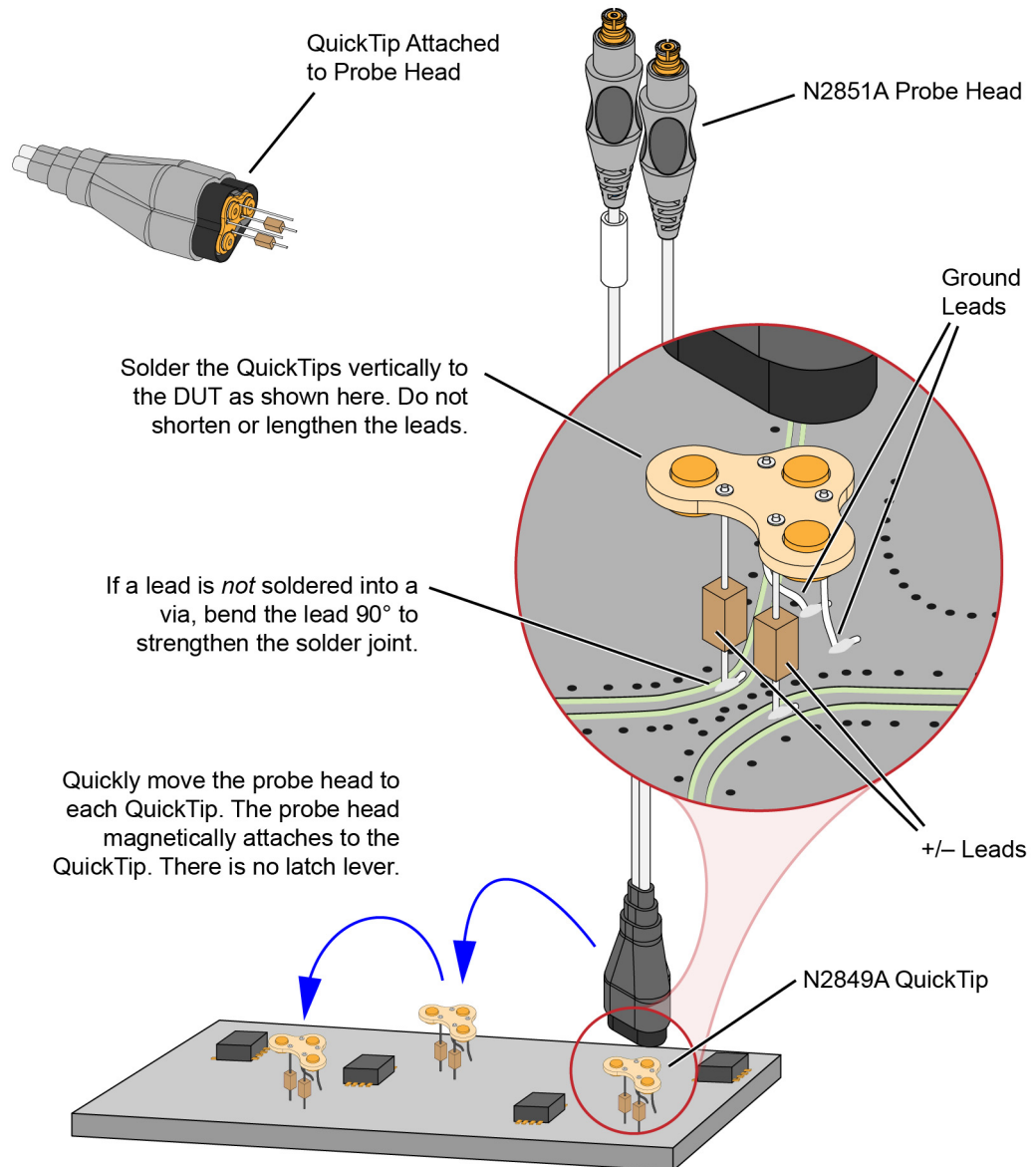

Figure 35 Probing with the N2851A Probe Head and N2849A QuickTip

NOTE

N2849A QuickTips are also compatible with N2848A QuickTip InfiniiMode Probe Heads, which are designed for N2800/1/2/3A, N2830/1/2A, and N7000/1/2/3A probes.

CAUTION

Do not replace or repair the N2849A QuickTip's resistor or ground leads. Attempting to do so will damage the ability of the tip to mate with the N2851A probe head.

NOTE

The N2851A does not include any N2849A QuickTips. The N2849A must be ordered separately.

NOTE

Before connecting the QuickTip head to the tip, use the tack-putty (N5439-65201) included with the N2848A QuickTip probe head or the N2787A 3D probe positioner for securing the probe amplifier to a rigid body near the DUT.

Connecting a QuickTip to the DUT

Use the following tips when soldering the QuickTips to your DUT:

- Orient the QuickTip vertically as shown in **Figure 35** on page 63.
- Solder the four leads to vias or surfaces.

CAUTION

Always mechanically strain-relieve the QuickTip head *before* using to protect both your probe accessories and DUT from damage.

NOTE

Resistor and wire leads on the QuickTip are factory trimmed to the proper length for use. Adding wire length to the tip of the mini-axial lead resistors or to the ground leads will degrade the performance of the probe.

NOTE

Soldering the ground wires is not required when making differential or single-ended (+ or - leads) measurements.

- When soldering to a via, always trim the lead close to the via's underside.
- If a lead is to be soldered to a surface and *not* a via, make a stronger solder joint by bending the end of the lead 90°. For signal leads, bend the wire approximately half way between the resistor and the end of the wire. Bend the ground leads at about the same distance.

CAUTION

Be careful not to damage the tip wires when handling the QuickTips. Wires can be carefully reshaped with tweezers or fingers if necessary.

CAUTION

The QuickTips are very fragile. They must be manufactured in this way in order to meet the high-performance, high bandwidth applications they are intended for. Be extremely careful when handling.

Cleaning the Magnetic Connections

If the three magnetic connections in the head become dirty, clean the connections using the following steps:

- 1 Use compressed air or a cloth to remove any loose dirt.
- 2 Gently rub a small piece of tack putty (supplied with the probe) against the magnetic connections to clean off any remaining surface grime.

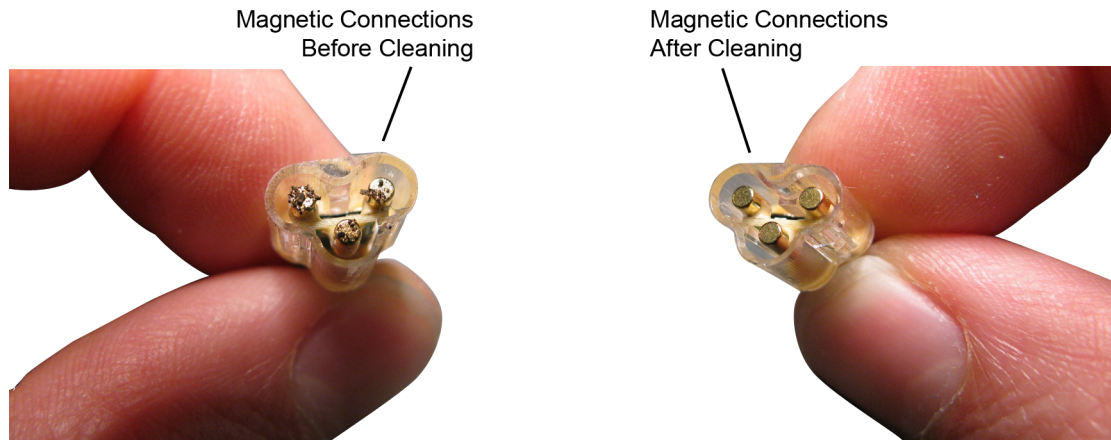
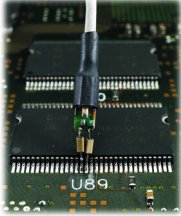

Figure 36 N2851A Head Before and After Cleaning

7. E2679B Single-Ended Solder-In Head



The E2679B probe head provides good bandwidth measurements of single-ended signals only with a probe head that is physically very small. The probe head resistors must be soldered to the circuit that you are measuring. Because of the small size of the resistor leads, it is easy to solder them to very small geometry circuits.

Table 19 Bandwidth

Probe Amplifier	BW (GHz)	Probe Amplifier	BW (GHz)
1130B	1.5	1132B	5
1131B	~3.5	1134B	5.2

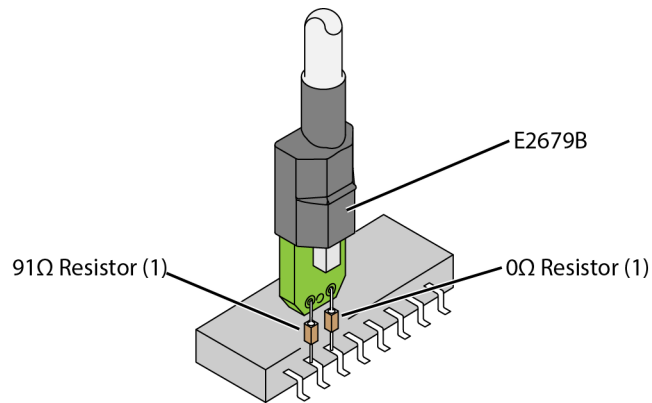

Figure 37 E2679B

NOTE

To install or repair resistor leads. Refer to [“Replacing Resistors on E2677B/9B Solder-In Probe Heads”](#) on page 76”.

NOTE

Performance plots. Refer to [Chapter 5](#), “1130B Performance Data Plots, [Chapter 6](#), “1131B Performance Data Plots, [Chapter 7](#), “1132B Performance Data Plots, and [Chapter 8](#), “1134B Performance Data Plots.

8. E2676B Single-Ended Browser



The E2676B single-ended browser is a good choice for general purpose probing of single-ended signals when physical size is critical. This browser has lower bandwidth than the differential browser, but is very small which allows probing in tight areas.

Table 20 Bandwidth

Probe Amplifier	BW (GHz)	Probe Amplifier	BW (GHz)
1130B	1.5	1132B	5
1131B	~3.5	1134B	5.5

For wider span, non-performance critical browsing (rise times greater than ~0.5 ns), the E2676-21301 socketed ground lead can be used in place of the 01130-60012 ground collar.

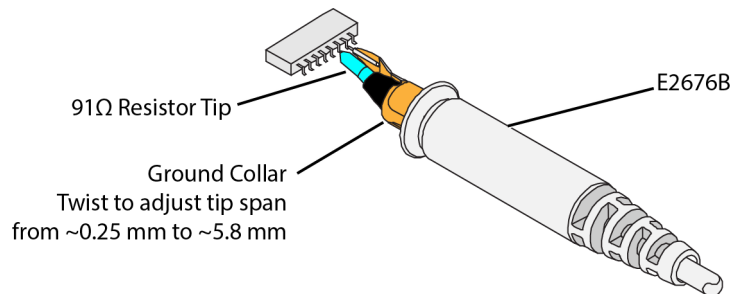

Figure 38 E2676B

When holding the E2676B for extended periods of time, use the supplied ergonomic handle. **Figure 39** and **Figure 40** show how to attach and remove the handle from the probe head.

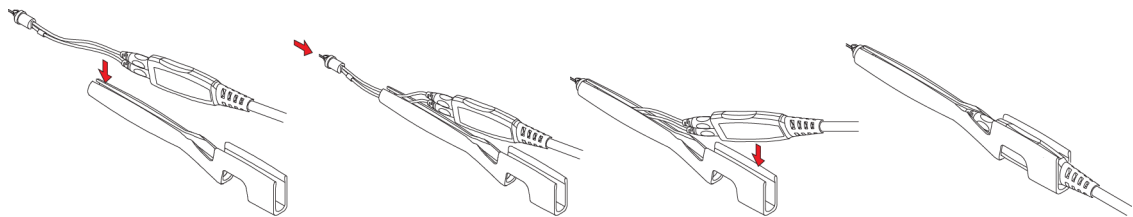

Figure 39 Inserting the Probe into the Handle

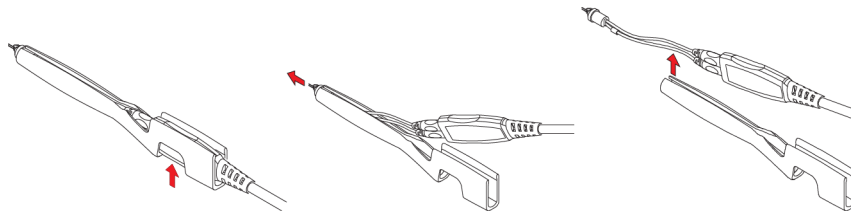

Figure 40 Removing the Probe from the Handle

9. E2677B Differential Solder-In Head with Medium BW Resistors



The E2677B with medium BW resistors (150Ω mini-axial lead) probe configuration provides medium bandwidth measurements of differential or single-ended signals.

Table 21 Bandwidth

Probe Amplifier	BW (GHz)	Probe Amplifier	BW (GHz)
1130B	1.5	1132B	~2.9
1131B	~2.9	1134B	~2.9

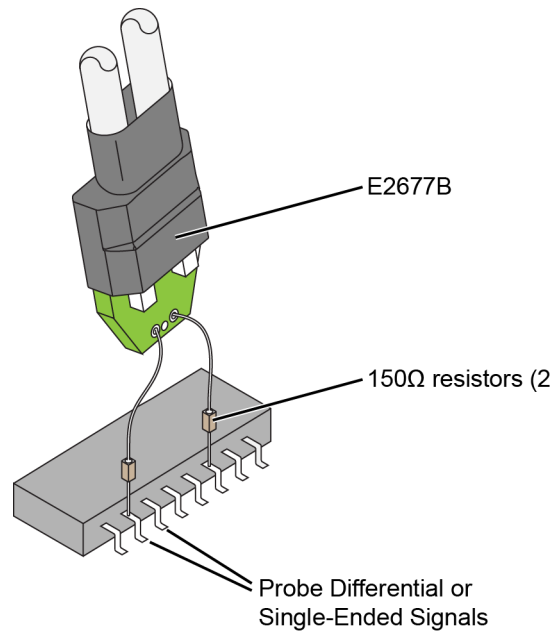

Figure 41 Solder-in Differential Probe Head (Medium Bandwidth)

The longer resistor length allows connection to widely spaced points or points in tight areas. The probe head resistors must be soldered to the circuit that you are measuring. Because of the small size of the resistor leads, it is easy to solder them to very small geometry circuits. This configuration can probe circuit points that are farther apart than the full bandwidth configurations.

NOTE

To install or repair resistor leads. Refer to **“Replacing Resistors on E2677B/9B Solder-In Probe Heads”** on page 76”.

NOTE

Performance plots. Refer to [Chapter 5](#), “1130B Performance Data Plots”, [Chapter 6](#), “1131B Performance Data Plots”, [Chapter 7](#), “1132B Performance Data Plots”, and [Chapter 8](#), “1134B Performance Data Plots”.

10. E2679B Single-Ended Solder-In Head with Long Wire

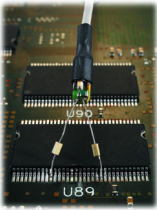

The E2679B probe head with long wire leads provides medium bandwidth measurements of single-ended signals. The longer resistor lead length allows connection to widely spaced points or points in tight areas.

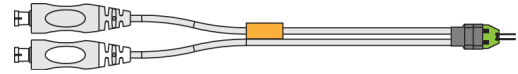

Table 22 Bandwidth

Probe Amplifier	BW (GHz)	Probe Amplifier	BW (GHz)
1130B	1.5	1132B	~2.9
1131B	~2.9	1134B	~2.9

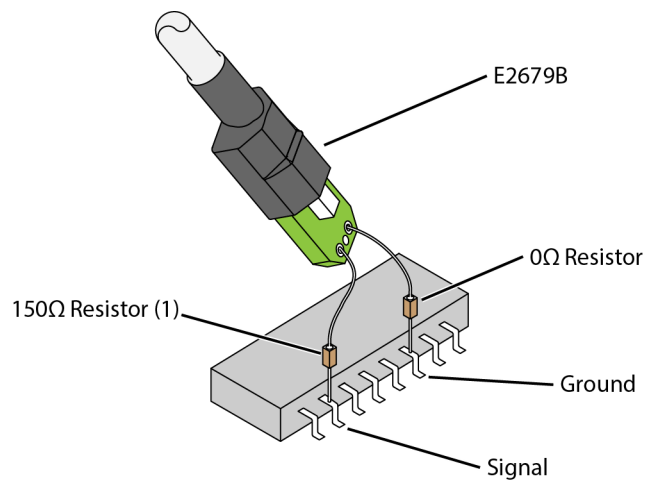

Figure 42 E2679B (Medium Bandwidth)

The probe head resistors must be soldered to the circuit that you are measuring. Because of the small size of the resistor leads, it is easy to solder them to very small geometry circuits. This configuration can probe circuit points that are farther apart than the full bandwidth configurations.

NOTE

To install or repair resistor leads. Refer to [“Replacing Resistors on E2677B/9B Solder-In Probe Heads”](#) on page 76”.

Table 23 Supplied Accessories

Description	Qty Supplied	Part Number *
91Ω resistor for full bandwidth	16	1NC3-1091
150Ω resistor for medium bandwidth	8	1NC3-1150
0Ω resistor for full and medium bandwidth	24	1NC3-1000
91Ω resistor template	2	01131-94311
150Ω resistor template	2	01131-94308

* *Not orderable.*

11. E2678B Differential Socketed Head with Damped Wire Accessory



This E2678A/B probe configuration provides maximum connection reach and flexibility with good signal fidelity but lower bandwidth for measuring differential or single-ended signals.

Table 24 Bandwidth

Probe Amplifier	BW (GHz)	Probe Amplifier	BW (GHz)
1130B	~1.2	1132B	~1.2
1131B	~1.2	1134B	~1.2

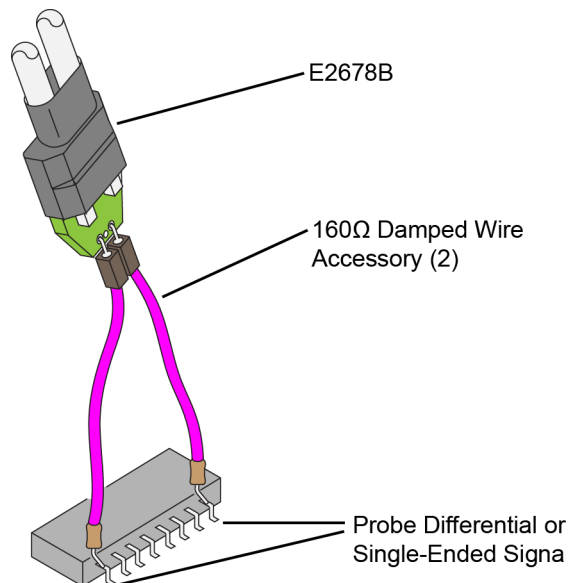

Figure 43 E2678B with Damped Wire Accessory

NOTE

The E2678B is a direct replacement for the E2678A that provides a more robust connection between the E2678B head's socket and printed circuit board. The E2678B's performance and fit are identical to that of the E2678A.

The damped wires must be soldered to the circuit that you are measuring. This configuration can probe circuit points that are farther apart than other configurations. This probe head come with a damped wire accessory that includes two 160 Ω resistors.

NOTE

Performance plots. Refer to [Chapter 5](#), “1130B Performance Data Plots, [Chapter 6](#), “1131B Performance Data Plots, [Chapter 7](#), “1132B Performance Data Plots, and [Chapter 8](#), “1134B Performance Data Plots.

12. E2678B Differential Socketed Head with Header Adapter

This probe configuration can be used to connect to 25 mil square pin headers with 100 mil spacing such as those used in USB testing. The header adapter is recommended for use with the 1130B and 1131B InfiniiMax probes.

NOTE

If the header adapter is used with higher bandwidth probe amplifiers such as the 1132B (5 GHz) or the 1134B (7GHz), the rise time of the input signal should be slower than ~150 ps (10% to 90%) to limit the effects of resonances in the adapter.

NOTE

The E2678B is a direct replacement for the E2678A that provides a more robust connection between the E2678B head's socket and printed circuit board. The E2678B's performance and fit are identical to that of the E2678A.

All of the specifications and characteristics of the header adapter are the same as those for the socketed differential probe head except for the input capacitance shown in [Table 25](#).

Table 25 Characteristic Capacitance

Identification	Capacitance	Description
C _m	0.43 pF	Model for input C is C _m between the tips and C _g to ground each tip
C _g	0.54 pF	
C _{diff}	0.70 pF	Differential mode capacitance is C _m + C _g /2
C _{se}	0.97 pF	Single-ended mode capacitance is C _m + C _g

To adapt the 01130-21303 damped wire accessory from solder-in to plug-on, solder the tip into the 01131-85201 square pin socket and then slip the 01131-41101 heat-shrink sleeve over the solder joint and heat the heat-shrink tubing with a heat gun. This allows the damped wire accessories to be used to plug onto 25 mil square pins.

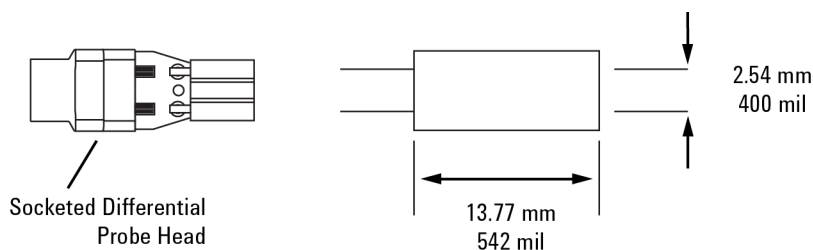

Figure 44 01130-63201 Header Adapter Dimensions

Replacing Resistors on E2677B/9B Solder-In Probe Heads

Use the following procedure to install or replace the wire leads when the mini-axial resistors become damaged or break off due to use.

Table 26 Resistors and Bandwidth

Resistor	For Bandwidth
91 Ω	Full
150 Ω	Medium
0 Ω	Full and Medium

NOTE

Resistor performance. The 91 Ω resistors were changed from 100 Ω to 91 Ω for slightly better performance. Either value produces a response that is well within specifications.

Table 27 Recommended Equipment

Equipment
Vise or clamp for holding tip
Metcal STTC-022 (600 °C) or STTC-122(700 °C) tip soldering iron or equivalent. The 600 °C tip will help limit burning of the FR4 tip PC board.
0.381 mm (0.015 in) diameter RMA flux standard tin/lead solder wire
Fine stainless steel tweezers
Rosin flux pencil, RMA type (Kester #186 or equivalent)
Diagonal cutters
Magnifier or low power microscope
Keysight supplied trim gauge (01131-94311)

Procedure

- 1 Use the vise or clamp to position the tip an inch or so off the work surface for easy access.

CAUTION

If using a vise, grip the tip on the sides with light force. When tightening the vise, use light force to avoid damaging the solder-in probe head. If using a tweezers clamp, grip the tip either on the sides or at the top and bottom.

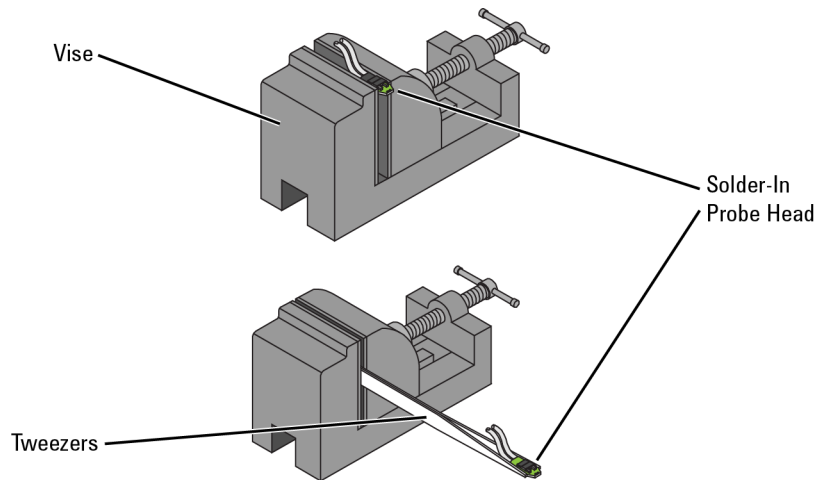

Figure 45 Clamping the Probe Head

- 2 If you need to remove an existing or damaged lead wire, grab each resistor lead or body with tweezers and pull very gently up. Touch the soldering iron to the solder joint just long enough for the resistor to come free of the probe head tip.

CAUTION

To avoid burning and damage to the pc board, do not keep the soldering iron in contact with the tip any longer than necessary. The solder joint has very low thermal mass, so the joint quickly melts and releases the wire.

NOTE

Make sure soldering iron tip is free of excess solder.

- 3 In needed, fill the mounting hole with solder in preparation for the new wire.
- 4 Use the flux pencil to coat the solder joint area with flux.
- 5 Prepare the mini-axial lead resistor for attachment to the head's pc board. The lead to be attached to head's pc board will have a 90° bend to go into through hole in the tip pc board.
- 6 Using tweezers, place the resistor body inside the rectangle of the trim template.

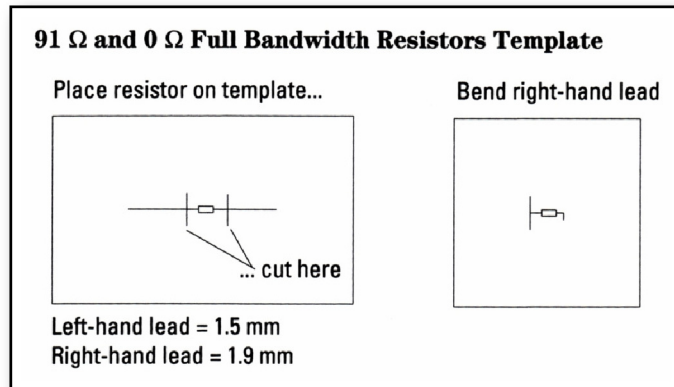

Figure 46 Keysight Supplied Template Included With Resistors

- 7 Using a knife, trim the leads even with the trim lines.
- 8 Place resistor body inside the rectangle of the bend template.
- 9 Using another pair of tweezers, bend the 1.90 mm or 8.89 mm lead 90° as shown in **Figure 47** and **Figure 48**.

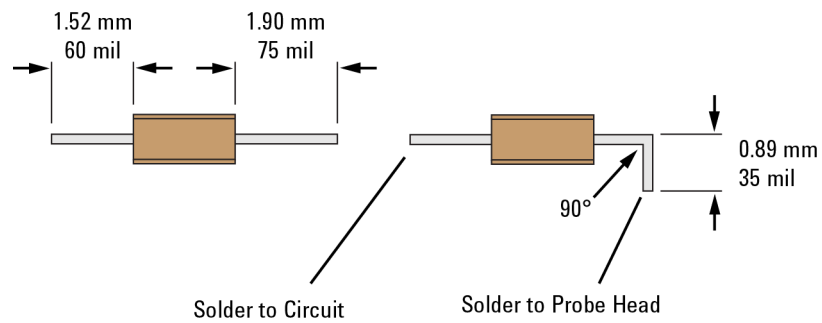

Figure 47 91Ω and 0Ω Combination Resistor Trim Dimensions

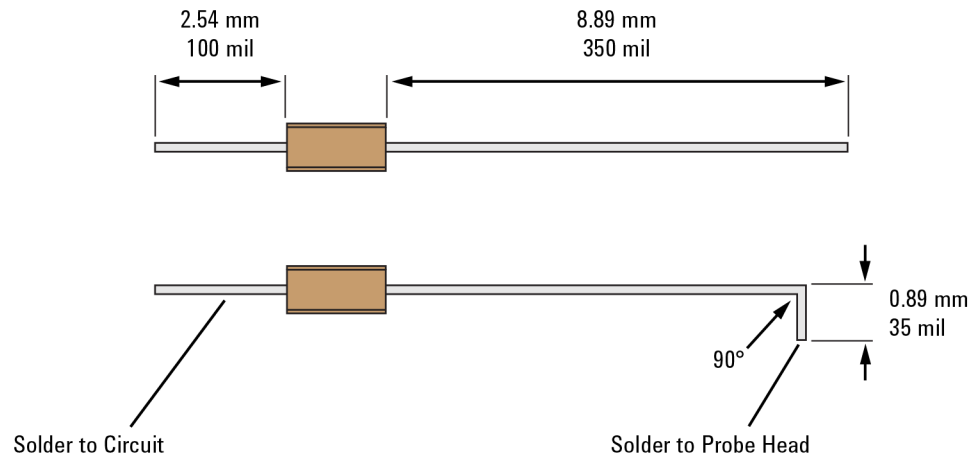

Figure 48 150 Ω and 0 Ω Combination Resistor Trim Dimensions

NOTE

Do not use the wrong value of resistor at the wrong length.

10 Holding the resistor lead or wire in one hand and soldering iron in the other, position the end of the resistor lead (after the 90° bend) over the solder filled hole. Touch the soldering iron to the side of the hole. When the solder in the hole melts, the resistor lead will fall into the hole. Remove soldering iron as soon as lead falls into the hole.

CAUTION

The thermal mass of the joint is very small, so taking extra time with the soldering iron in an attempt to ensure a good joint is not needed.

NOTE

Make sure the zero ohm resistor is used for ground leads on the E2679B single-ended probe head.

NOTE

For the E2677B differential solder-in probe head, the + and - connection can be determined when the probe head is plugged into the probe amplifier, so which way the tip is soldered in is not important.

2 Using Probe Heads

3 Calibrating Probes

Calibration for Solder-In and Socketed Probe Heads **82**

Calibration for Hand-held Browser Probe Heads **89**

Calibration for N5380A/B SMA Probe Heads **91**

Calibrating the InfiniiMax probes (1168B, 1169B, 1130B, 1131B, 1132B, 1134B) is done using the E2655C Deskew and Calibration Kit. The kit contains the following parts:

- SMA (male) to SMA (male) adapter
- SMA (male) to BNC (female) adapter
- BNC (male) to SMA (male) adapter
- 50 Ω SMA Terminator
- De-skew Fixture

When the probe has been calibrated, the dc gain, offset zero, and offset gain will be calibrated. The degree of accuracy specified at the probe tip is dependent on the oscilloscope system specifications.

This chapter contains procedures showing vertical and skew calibration for solder-in differential probe head, the differential browser probe head, and the SMA probe head. The procedures can also be applied to all of the different InfiniiMax probe configurations and for the 11560 and 1150A series active probe configurations.

Calibration for Solder-In and Socketed Probe Heads

Calibration of the solder-in and socketed probe heads consists of a vertical calibration and a skew calibration. The vertical calibration should be performed before the skew calibration. Both calibrations should be performed for best probe measurement performance.

NOTE

Before calibrating the probe, verify that the Infiniium oscilloscope has been calibrated recently and that the calibration Δ temperature is within $\pm 5^{\circ}\text{C}$. If this is not the case, calibrate the oscilloscope before calibrating the probe. This information is found in the Infiniium Calibration dialog box.

Step 1- Connecting the Probe for Calibration

The calibration procedure requires the following parts.

- BNC (male) to SMA (male) adapter
 - Deskew fixture
 - 50Ω SMA terminator
- 1 As shown in **Figure 49** on page 83, connect BNC (male) to SMA (male) adapter to the deskew fixture on the connector closest to the yellow pincher.
 - 2 Connect the 50Ω SMA terminator to the connector farthest from the yellow pincher.
 - 3 Connect the BNC side of the deskew fixture to the Aux Out BNC of the Infiniium oscilloscope.
 - 4 Connect the probe to an oscilloscope channel.
 - 5 To minimize the wear and tear on the probe head, the probe head should be placed on a support to relieve the strain on the probe head cables.
 - 6 Push down on the back side of the yellow pincher. Insert the probe head resistor lead underneath the center of the yellow pincher and over the center conductor of the deskew fixture. The negative probe head resistor lead or ground lead must be underneath the yellow pincher and over one of the outside copper conductors (ground) of the deskew fixture. Make sure that the probe head is approximately perpendicular to the deskew fixture.

NOTE

For the socketed probe head, insert two properly trimmed 82Ω resistors into the sockets.

- 7 Release the yellow pincher.

NOTE

To ensure contact, pull up on the back side of the yellow pincher to ensure good contact between resistor leads and the deskew fixture.

Step 2. Verifying the Connection

- 1 On the Infiniium oscilloscope, press the autoscale button on the front panel.
- 2 Set the volts per division to 100 mV/div.
- 3 Set the horizontal scale to 1.00 ns/div.
- 4 Set the horizontal position to approximately 3 ns. You should see a waveform similar to that in [Figure 50](#) on page 84.

If you see a waveform similar to that of [Figure 51](#), then you have a bad connection and should check all of your probe connections.

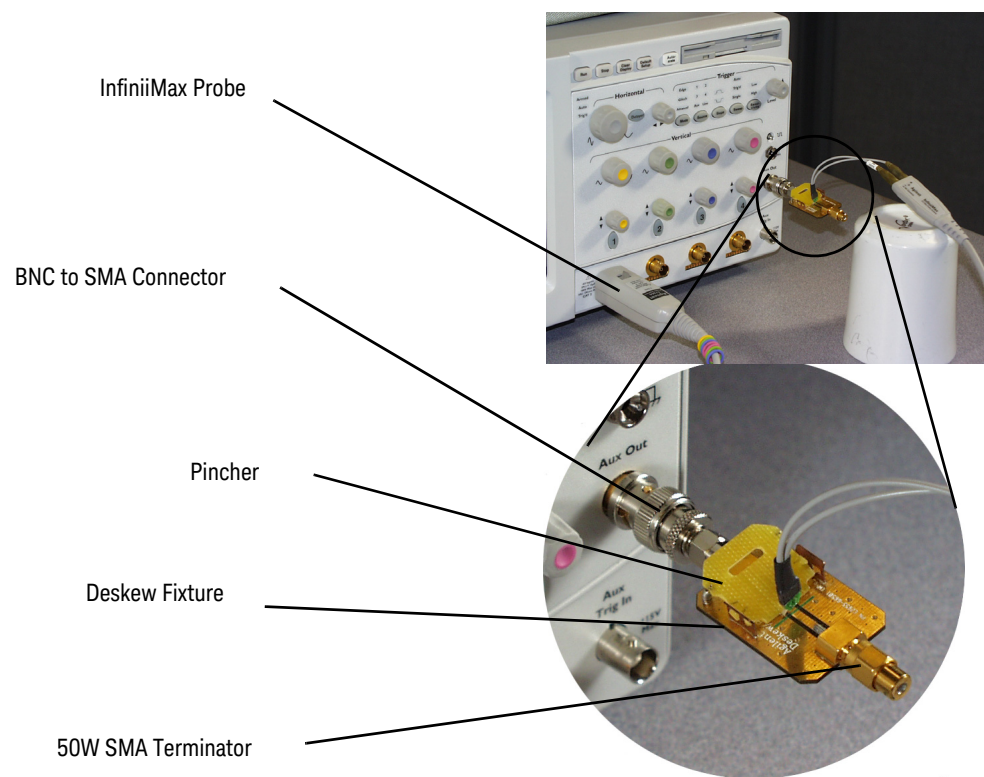

Figure 49 Connecting the Probe and Deskw Fixture



Figure 50 Good Connection

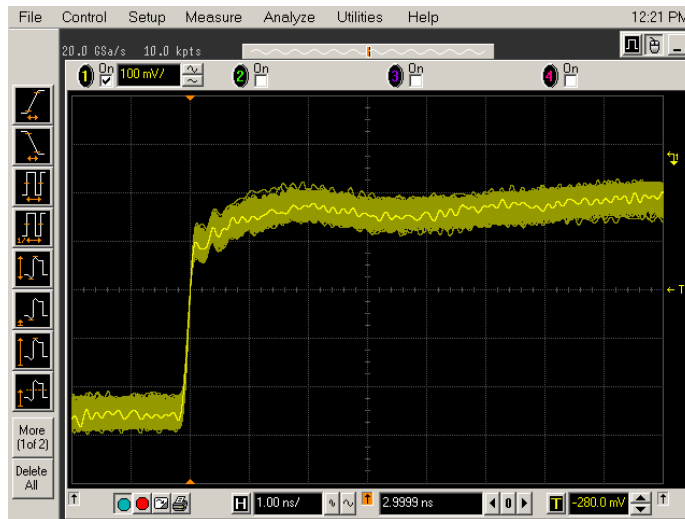

Figure 51 Bad Connection

Step 3. Running the Probe Calibration and Deskew

- 1 On the Infiniium oscilloscope in the Setup menu, select the channel connected to the probe.
- 2 In the Channel Setup dialog box select the Probes... button.
- 3 In the Probe Setup dialog box select the Calibrate Probe... button.
- 4 In the Probe Cal dialog box select the Calibrated Atten/Offset radio button.
- 5 Select the Start Atten/Offset Calibration... button and follow the on-screen instructions for the vertical calibration procedure.

- 6 Once the vertical calibration has successfully completed, select the Calibrated Skew... button.
- 7 Select the Start Skew Calibration... button and follow the on-screen instructions for the skew calibration. At the end of each calibration the oscilloscope will inform you if the calibration was or was not successful.

Verifying the Probe Calibration

If you have just successfully calibrated the probe, it is not necessary to perform this verification. However, if you want to verify the probe was properly calibrated, the following procedure will help you verify the calibration.

The calibration procedure requires the following parts.

- BNC (male) to SMA (male) adapter
- SMA (male) to BNC (female) adapter
- BNC (male) to BNC (male) 12 inch cable such as the Keysight 8120-1838 (not included in this kit)
- Keysight 54855-61620 calibration cable (Infiniium oscilloscopes with bandwidths of 6 GHz and greater only)
- Keysight 54855-67604 precision 3.5 mm adapters (Infiniium oscilloscopes with bandwidths of 6 GHz and greater only)
- Deskew fixture

For the following procedure, refer to **Figure 49** on page 83.

- 1 As shown in **Figure 52** on page 87, connect BNC (male) to SMA (male) adapter to the deskew fixture on the connector closest to the yellow pincher.
- 2 Connect the SMA (male) to BNC (female) to the connector farthest from the yellow pincher.
- 3 Connect the BNC (male) to BNC (male) cable to the BNC connector on the deskew fixture to one of the unused oscilloscope channels. For Infiniium oscilloscopes with bandwidths of 6 GHz and greater, use the 54855-61620 calibration cable and the two 54855-67604 precision 3.5 mm adapters.
- 4 Connect the BNC side of the deskew fixture to the Aux Out BNC of the Infiniium oscilloscope.
- 5 Connect the probe to an oscilloscope channel.
- 6 To minimize the wear and tear on the probe head, the probe head should be placed on a support to relieve the strain on the probe head cables.
- 7 Push down on the back side of the yellow pincher. Insert the probe head resistor lead underneath the center of the yellow pincher and over the center conductor of the deskew fixture. The negative probe head resistor lead or ground lead must be underneath the yellow pincher and over one of the outside copper conductors (ground) of the deskew fixture. Make sure that the probe head is approximately perpendicular to the deskew fixture.

NOTE

For the socketed probe head, insert two properly trimmed 82Ω resistors into the sockets.

8 Release the yellow pincher.

NOTE

To ensure contact, pull up on the back side of the yellow pincher to ensure good contact between resistor leads and the deskew fixture.

- 9** On the oscilloscope, press the autoscale button on the front panel.
- 10** Select Setup menu and choose the channel connected to the BNC cable from the pull-down menu.
- 11** Select the Probes... button.
- 12** Select the Configure Probe System button.
- 13** Select User Defined Probe from the pull-down menu.
- 14** Select the Calibrate Probe... button.
- 15** Select the Calibrated Skew radio button.
- 16** Once the skew calibration is completed, close all dialog boxes.
- 17** Select the Start Skew Calibration... button and follow the on-screen instructions.
- 18** Set the vertical scale for the displayed channels to 100 mV/div.
- 19** Set the horizontal range to 1.00 ns/div.
- 20** Set the horizontal position to approximately 3 ns.
- 21** Change the vertical position knobs of both channels until the waveforms overlap each other.
- 22** Select the Setup menu choose Acquisition... from the pull-down menu.
- 23** In the Acquisition Setup dialog box enable averaging. When you close the dialog box, you should see waveforms similar to that in **Figure 53** on page 88.

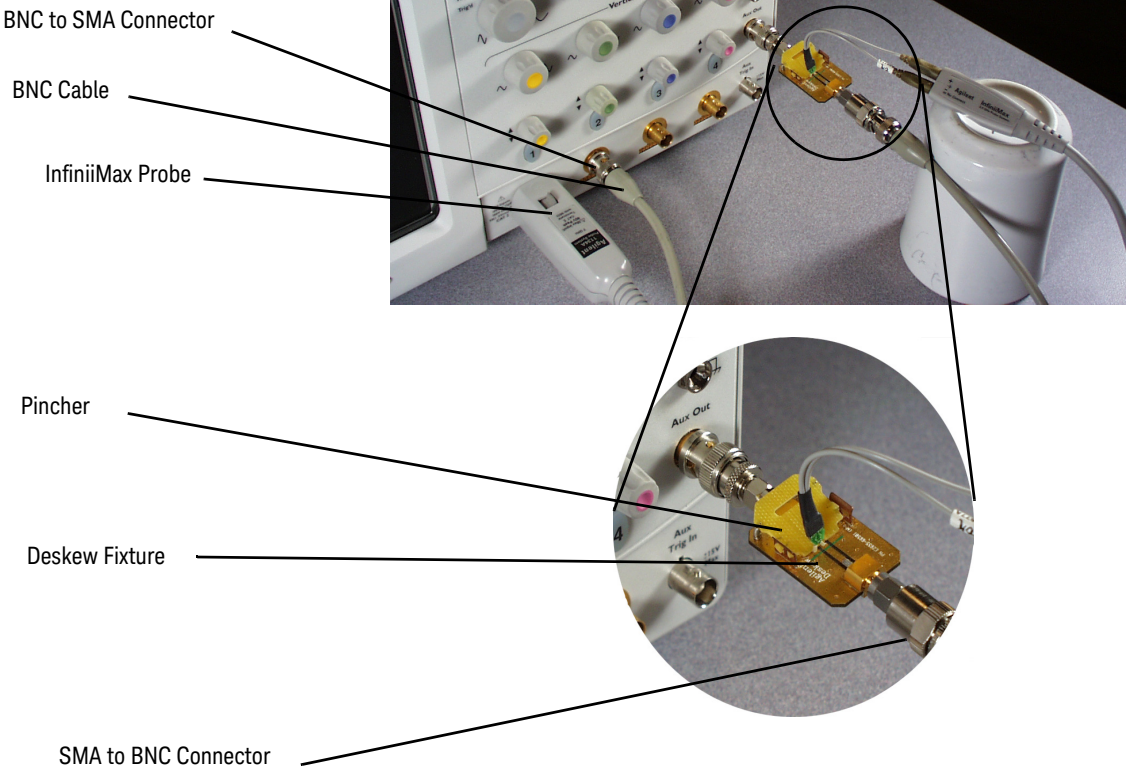

Figure 52 Connecting the Probe

3 Calibrating Probes

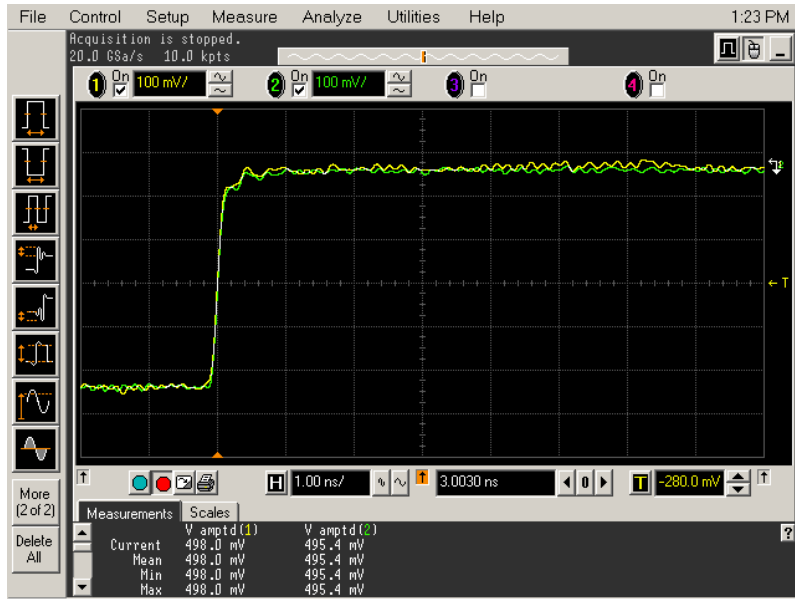

Figure 53 Overlapping Waveforms

Calibration for Hand-held Browser Probe Heads

Calibration of the hand-held browser probe heads consists of a vertical calibration and a skew calibration. The vertical calibration should be performed before the skew calibration. Both calibrations should be performed for best probe measurement performance.

NOTE

Before calibrating the probe, verify that the Infiniium oscilloscope has been calibrated recently and that the calibration Δ temperature is within ± 5 °C. If this is not the case, calibrate the oscilloscope before calibrating the probe. This information is found in Infiniium Calibration dialog box.

Calibration Setup

The calibration procedure requires the following parts.

- BNC (male) to SMA (male) adapter
 - Deskew fixture
 - 50 Ω SMA terminator
- 1 As shown in **Figure 54** on page 90, connect BNC (male) to SMA (male) adapter to the deskew fixture on the connector closest to the yellow pincher.
 - 2 Connect the 50 Ω SMA terminator to the connector farthest from the yellow pincher.
 - 3 Connect the BNC side of the deskew fixture to the Aux Out of the Infiniium oscilloscope.
 - 4 Connect the probe to an oscilloscope channel.
 - 5 Place the positive resistor tip of the browser on the center conductor of the deskew fixture between the green line and front end of the yellow pincher. The negative resistor tip or ground pin of the browser must be on either of the two outside conductors (ground) of the deskew fixture.
 - 6 On the Infiniium oscilloscope in the Setup menu, select the channel connected to the probe.
 - 7 In the Channel Setup dialog box select the Probes... button.
 - 8 In the Probe Setup dialog box select the Calibrate Probe... button.
 - 9 In the Probe Cal dialog box select the Calibrated Atten/Offset radio button.
 - 10 Select the Start Atten/Offset Calibration... button and follow the on-screen instructions for the vertical calibration procedure.
 - 11 Once the vertical calibration has successfully completed, select the Calibrated Skew... button.
 - 12 Select the Start Skew Calibration... button and follow the on-screen instructions for the skew calibration.

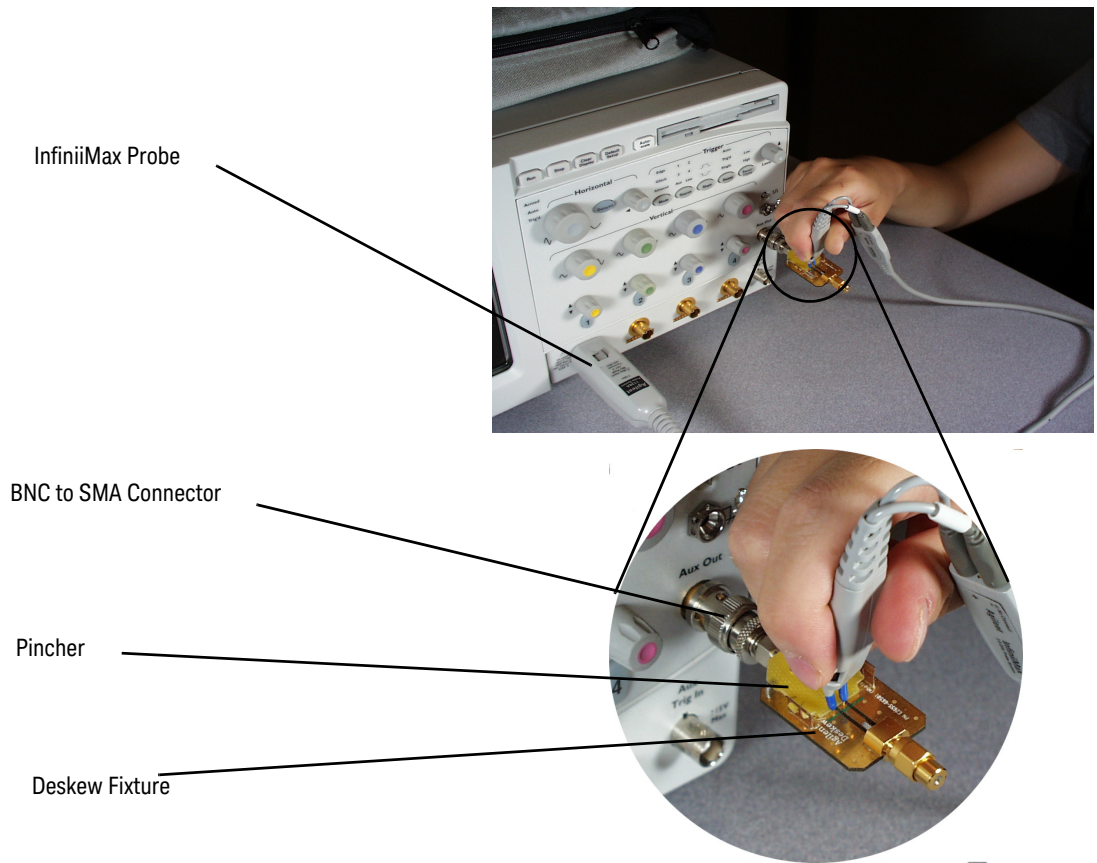

Figure 54 Placing the Probe on the Fixture

Calibration for N5380A/B SMA Probe Heads

Equipment Required

This calibration procedure requires the following equipment.

- SMA to BNC (male) adapter
- E2655C Deskew Fixture, or SMA (female) to SMA (female) adapter
- N5380A/B SMA Probe Head
- Shorting Cap
- InfiniiMax Probe Amplifier

Calibration Setup

- 1 Connect the SMA to BNC adapter to one of the SMA connectors of the deskew fixture (or the SMA (female) to SMA (female) adapter if you are using it instead).
- 2 Connect the shorting cap to the center SMA connector of the SMA probe head.
- 3 Connect the other end of the deskew fixture (or SMA to SMA adapter if you are using it instead) to one of the SMA connectors of the N5380A/B SMA probe head.
- 4 Connect the BNC connector of the SMA to BNC adapter to the Aux Out on the Infiniium oscilloscope.
- 5 Connect the InfiniiMax probe amplifier to the GPO (SMP) connector of the N5380A/B SMA probe head. Be sure to connect the positive (+) side to the side connected to the Aux Out of the oscilloscope.
- 6 Start the calibration by selecting the Atten/Offset **Cal...** button in the Probe Configuration dialog box (**Setup > Probe Configuration...**)



Figure 55 Connecting the SMA Probe Head and Deskew Fixture

3 Calibrating Probes

4 Characteristics and Specifications

General	94
Environmental	96
Regulatory	97
Probe Dimensions	98

All warranted specifications are denoted by a footnote reference number. All other characteristics are typical values.

General

Table 28 Characteristics and Specifications (Sheet 1 of 2)

Item	Characteristic *	Description
Bandwidth (-3 dB) (specification)		
1134B	7 GHz (specification) ^b	
1132B	5 GHz (specification) ^b	
1131B	3.5 GHz (specification) ^b	
1130B	1.5 GHz (specification) ^b	
Rise and Fall Time (10% to 90%)		
1134B	60 ps	
1132B	86 ps	
1131B	100 ps	
1130B	233 ps	
Oscilloscope and Probe System Bandwidth (-3 dB)		
1134B with 54855	6 GHz	
1132B with 54854	4 GHz	
1131B with 54853	2.5 GHz	
1131B with 54852	2 GHz	
1130B with 54833	2 GHz	
1130B with 54832	1 GHz	
Input Capacitance		
C _m	0.10 pF	Model for input C is C _m is between tips and C _g is to ground for each tip
C _g	0.34 pF	
C _{diff}	0.27 pF	Differential mode capacitance (capacitance when probing a differential signal = C _m + C _g /2)
C _{se}	0.44 pF	Single-ended mode capacitance (capacitance when probing a single-ended signal = C _m + C _g)

Table 28 Characteristics and Specifications (Sheet 2 of 2)

Item	Characteristic *	Description
Input Resistance		
Differential mode resistance	50 k Ω \pm 2%	
Single-ended mode resistance each side to ground	25 k Ω \pm 2%	
Input Dynamic Range	\pm 2.5 V	Differential or single-ended
Input Common Mode Range	\pm 6.75 V \pm 1.25 V	dc to 100 Hz > 100 Hz to probe bandwidth (<i>should not exceed the maximum signal slew rate</i>)
Maximum Signal Slew Rate (SR _{max}) [†]	18 V/ns 30 V/ns	When probing a single-ended signal When probing a differential signal
DC Attenuation	10:1 \pm 3% before calibration on oscilloscope 10:1 \pm 1% after calibration on oscilloscope	
Zero offset error referred to input	< 30 mV before calibration on oscilloscope < 5 mV after calibration on oscilloscope	
Offset Range	\pm 12.0 V	When probing single-ended
Offset Accuracy	< 3% of setting before calibration on oscilloscope < 1% of setting after calibration on oscilloscope	
Noise referred to input	3.0 mVrms	
Propagation Delay	6 ns	
Maximum Input Voltage	30V Peak (mains isolated)	Maximum non-destructive voltage on each input ground
ESD Tolerance	> 8 kV from 100 pF, 300 Ω HBM	

* Values shown are for the probe amp and solder-in differential probe head with full bandwidth resistor.

b > - Denotes that bandwidth is a warranted specification, all others are typical. Measured using the probe amplifier and solder-in differential probe head with full bandwidth resistor.

† SR_{max} of a sine wave = 2 P(Amp x frequency or SR_{max}) of a step @ Amp x 0.6 / trise (20 to 80%) for more information refer to [Table 2](#) on page 19.

Environmental

The following general characteristics apply to the active probe.

Table 29 Environmental Characteristics

Environmental Conditions	Operating Characteristic	Non-Operating Characteristic
Temperature	5 °C to +40 °C	-40 °C to +70 °C
Humidity	up to 95% relative humidity (non-condensing) at +40 °C	up to 90% relative humidity at +65 °C
Altitude	Up to 4,600 meters	Up to 15,300 meters
Power Requirements (voltages supplied by AutoProbe Interface)	+12 Vdc @ 11 mA -12 Vdc @ 5 mA +5 Vdc @ 28 mA -5 Vdc @ 92 mA 0.84 W	–
Weight	approximately 0.69 kg	
Dimensions	Refer to the outline in Figure 56 on page 98	
Pollution degree 2	Normally only non-conductive pollution occurs. Occasionally, however, a temporary conductivity caused by condensation must be expected.	
Use	Indoor Only	

Regulatory

Measurement Category Definitions

Mains Isolated: Other circuits that are not connected directly to mains.

CAT II: Circuits connected to mains socket outlets and similar points in the mains installation.

CAT III: Mains distribution parts of the building.

CAT IV: Source of the mains installation in the building.

WARNING

Do not use this probe for measurements within measurement categories II, III, and IV.

WEEE Compliance



This symbol indicates the Environmental Protection Use Period (EPUP) for the product's toxic substances for the China RoHS requirements.



The CE mark is a registered trademark of the European Community. ISM GRP 1-A denotes the instrument is an Industrial Scientific and Medical Group 1 Class A product. ICES/NMB-001 indicates product compliance with the Canadian Interference-Causing Equipment Standard.



This product complies with the WEEE Directive (2002/96/EC) marking requirements. The affixed label indicates that you must not discard this electrical/electronic product in domestic household waste.

Product Category: With reference to the equipment types in the WEEE Directive Annex I, this product is classed as a "Monitoring and Control Instrumentation" product.

Do not dispose in domestic household waste. To return unwanted products, contact your local Keysight office, or see www.keysight.com for more information.

Probe Dimensions

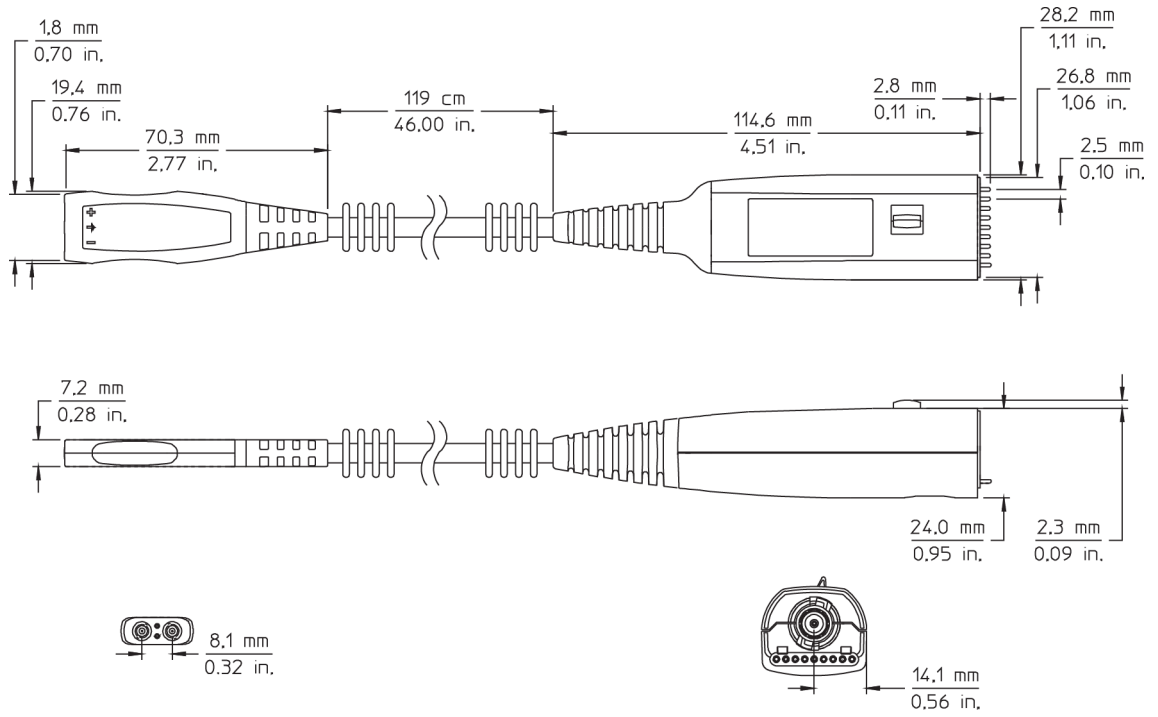

Figure 56 Probe Dimensions

MX0100A Probe Head Dimensions

All dimensions are in mm [inches].

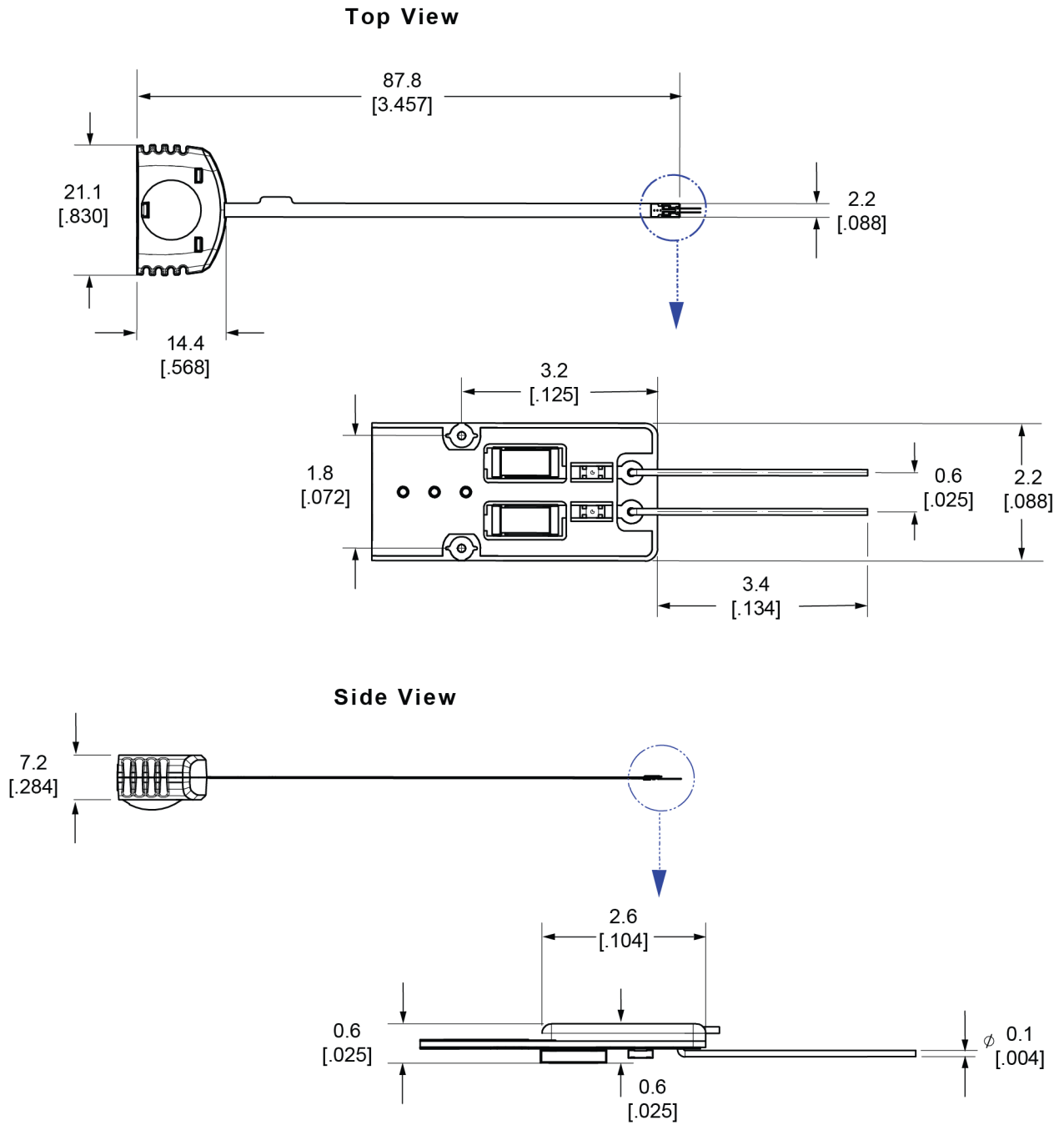

Figure 57 MX0100A Probe Head Dimensions

4 Characteristics and Specifications

5 1130B Performance Data Plots

E2675B Differential Browser	102
E2676B Single-Ended Browser	105
E2677B Differential Solder-in Probe Head (Full BW)	108
E2677B Differential Solder-in Probe Head (Medium BW)	111
E2678A/B Differential Socketed Probe Head (Full BW)	114
E2678A/B Differential Socketed Probe Head with Damped Wire Accessory	117
E2679B Single-Ended Solder-in Probe Head (Full BW)	120
E2679B Single-Ended Solder-in Probe Head (Medium BW)	123
N2851A QuickTip Head with N2849A QuickTip	126

This chapter provides graphs of the performance characteristics of the 1130B probes using the different probe heads that come with the E2668b single-ended and E2669B differential connectivity kits.

NOTE

All rise times shown are measured from the 10% to the 90% amplitude levels.

E2675B Differential Browser

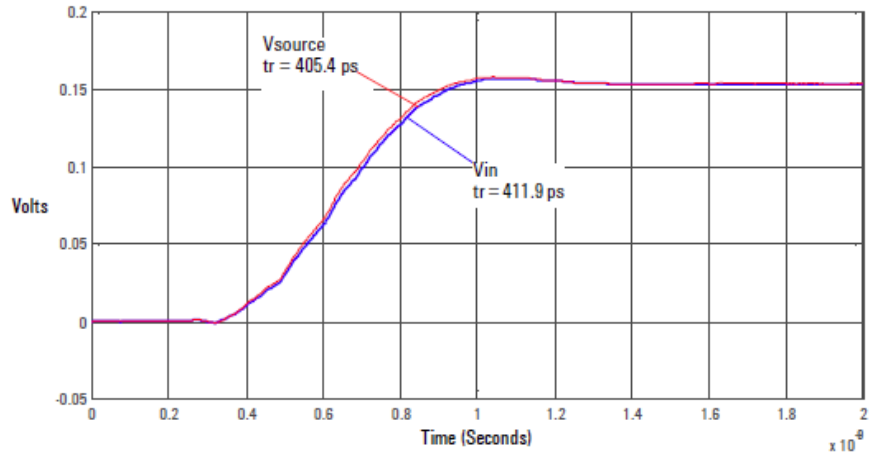

Figure 58 Graph of 25 ohm 405.4 ps step generator with and without probe connected.

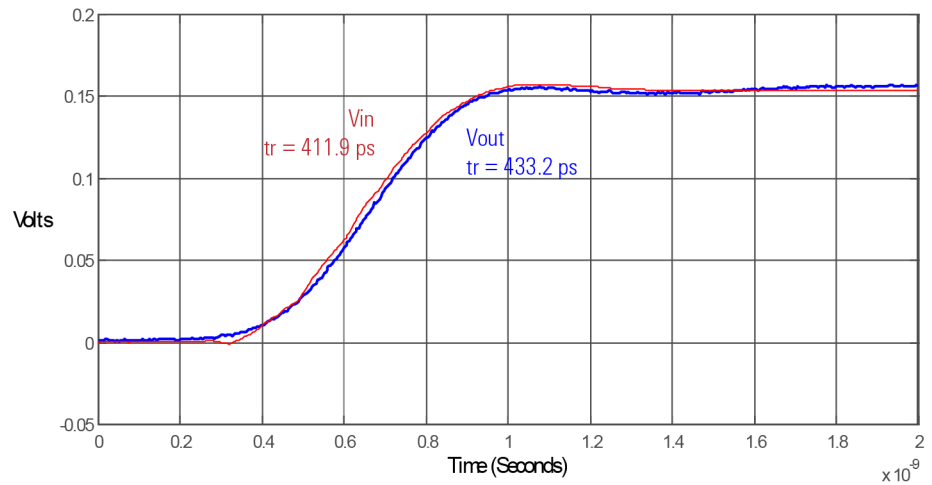

Figure 59 Graph of V_{in} and V_{out} of probe with a 25 ohm 405.4 ps step generator.

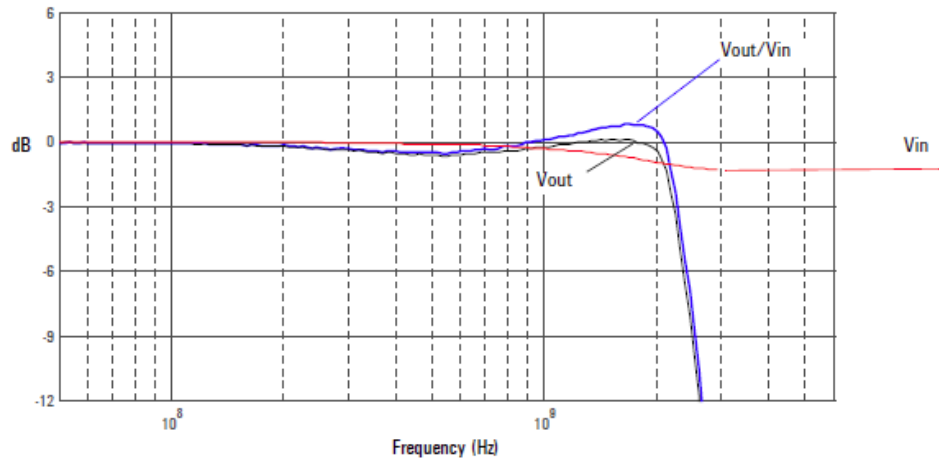

Figure 60 Graph of Vin and Vout of probe with a 25 ohm source and Vout/Vin frequency response.

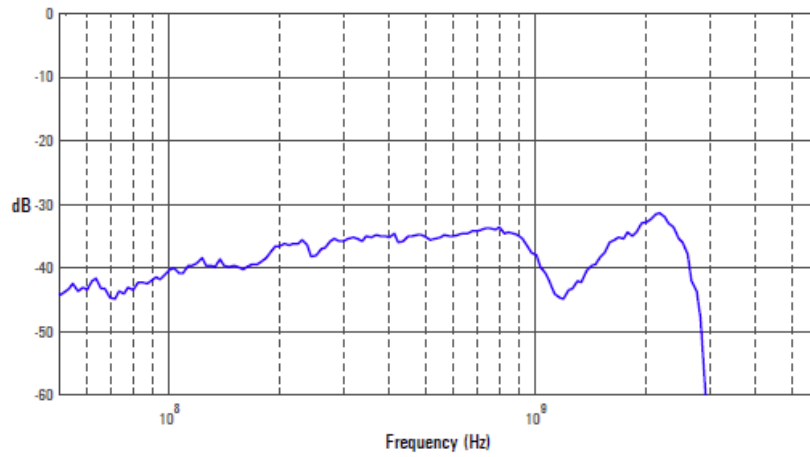

Figure 61 Graph of Vout/Vin frequency response when inputs driven in common (common mode rejection).

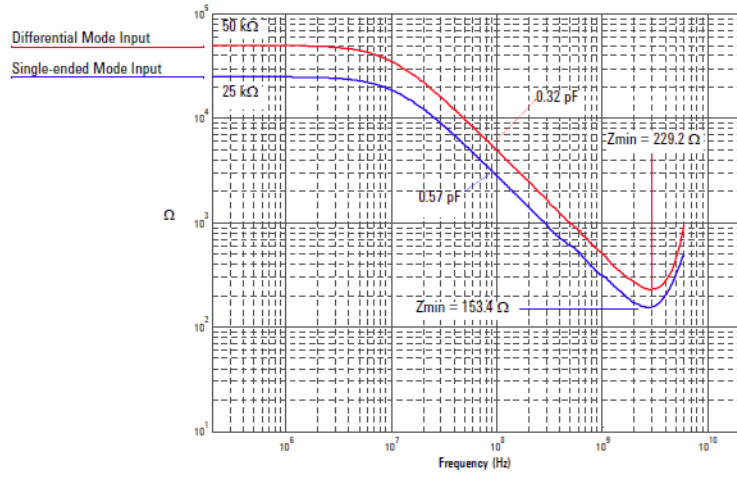

Figure 62 Magnitude plot of probe input impedance versus frequency.

E2676B Single-Ended Browser

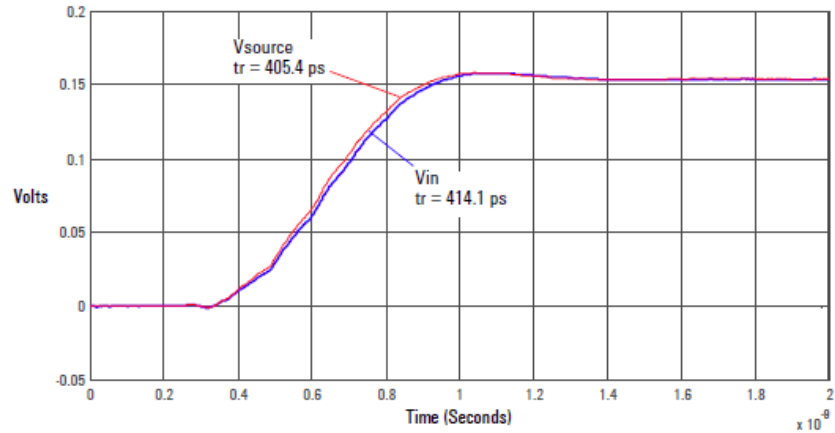

Figure 63 Graph of 25 ohm 405.4 ps step generator with and without probe connected.

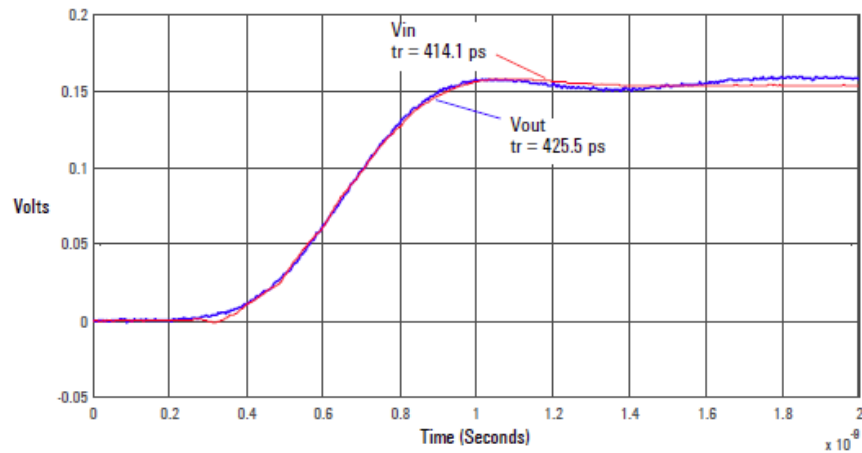

Figure 64 Graph of V_{in} and V_{out} of probe with a 25 ohm 405.4 ps step generator.

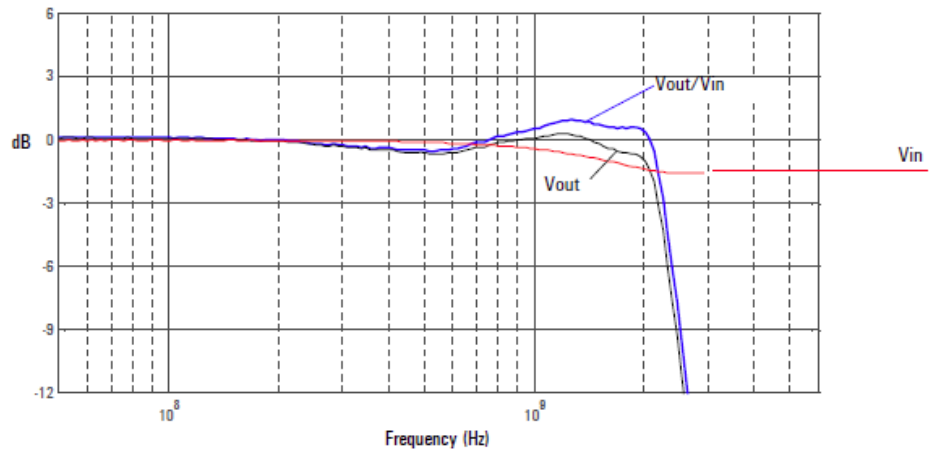

Figure 65 Graph of Vin and Vout of probe with a 25 ohm source and Vout/Vin frequency response.

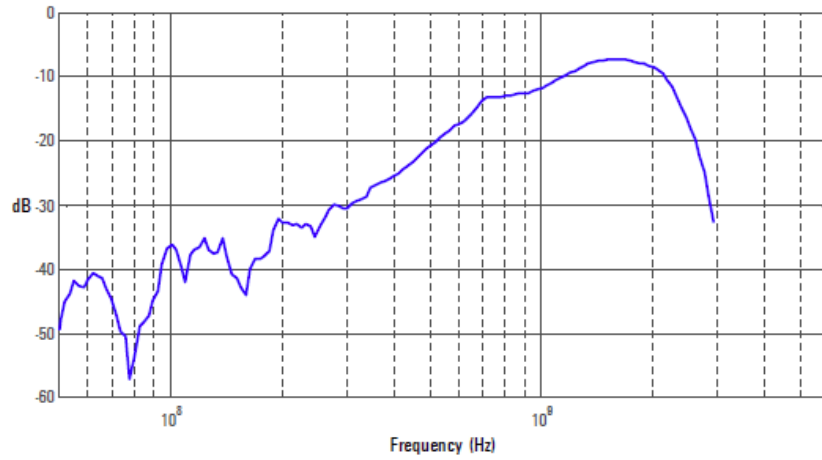

Figure 66 Graph of Vout/Vin frequency response when inputs driven in common (common mode rejection).

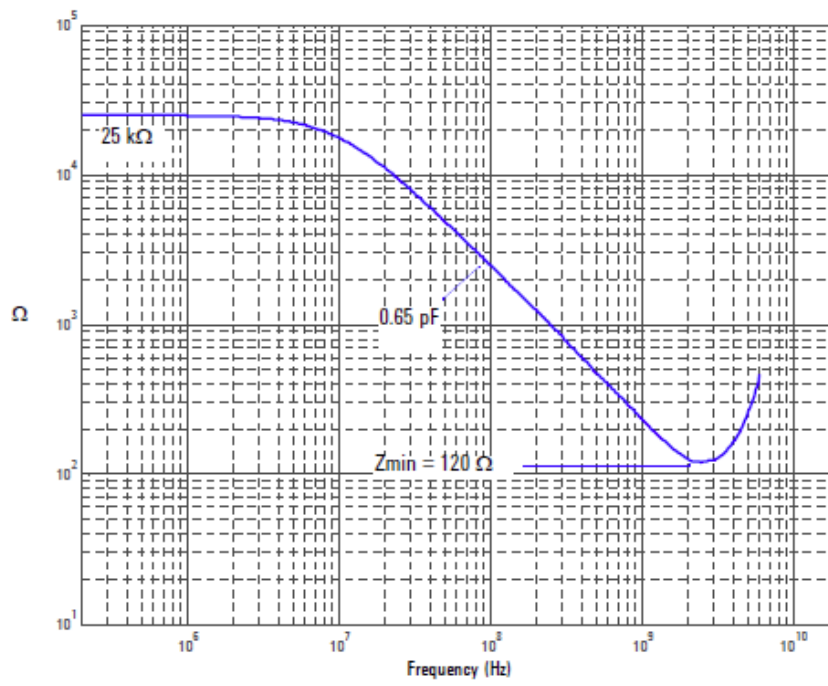

Figure 67 Magnitude plot of probe input impedance versus frequency.

E2677B Differential Solder-in Probe Head (Full BW)

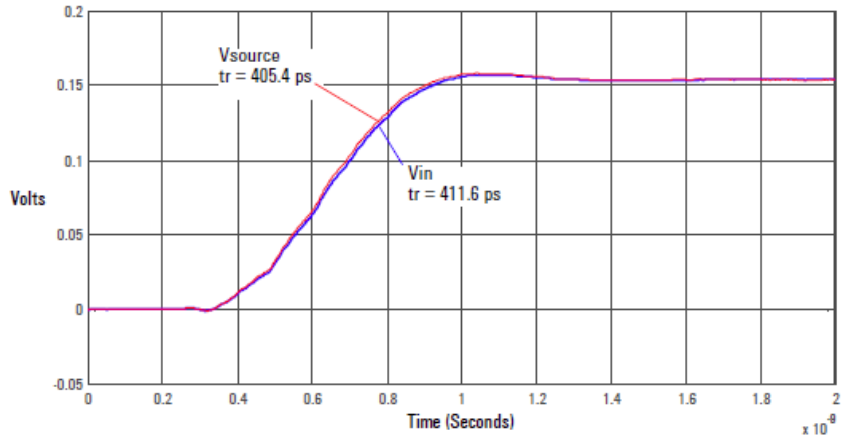

Figure 68 Graph of 25 ohm 100 ps step generator with and without probe connected.

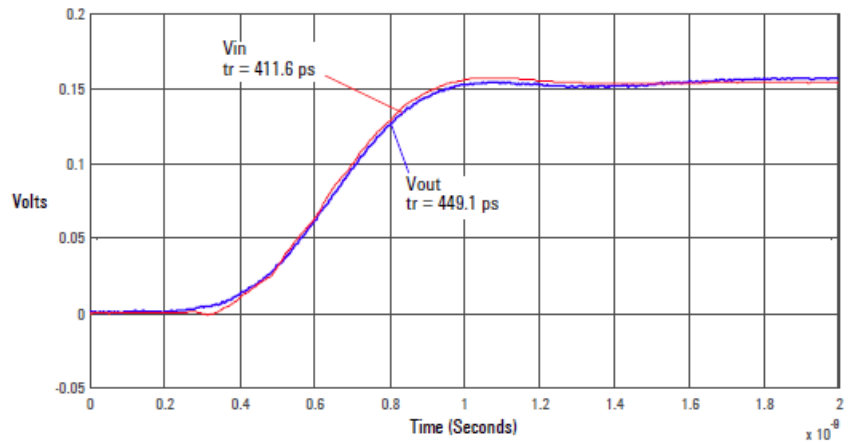

Figure 69 Graph of V_{in} and V_{out} of probe with a 25 ohm 405.4 ps step generator.

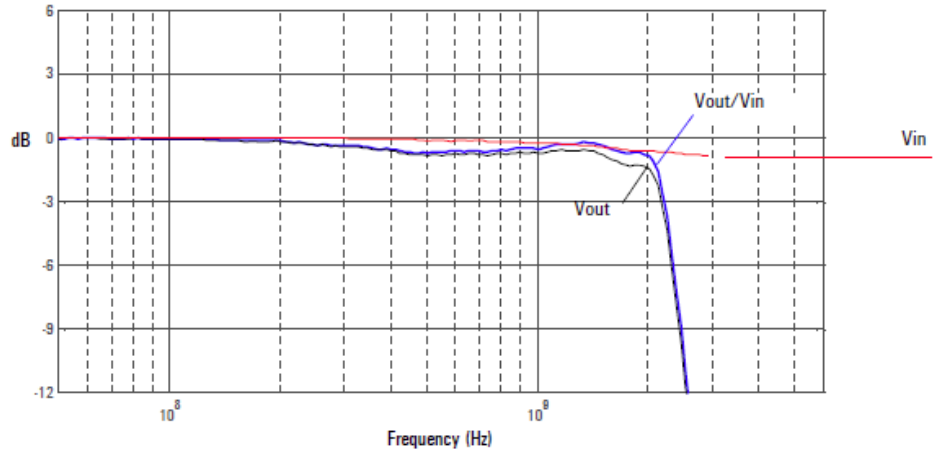

Figure 70 Graph of Vin and Vout of probe with a 25 ohm source and Vout/Vin frequency response.

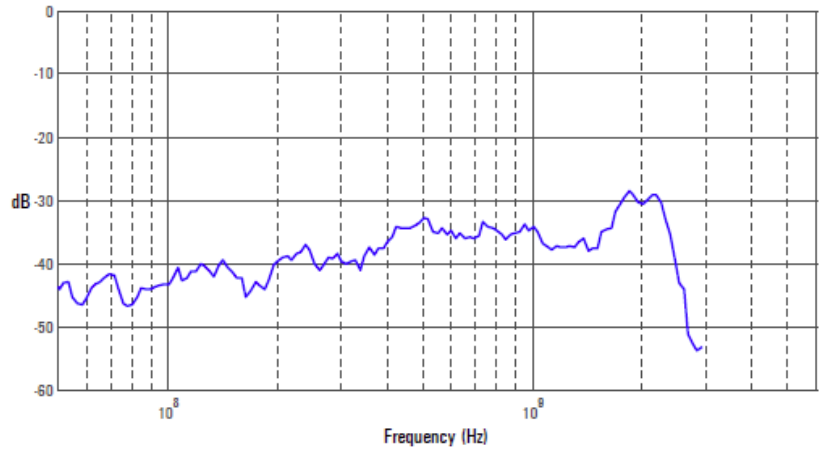

Figure 71 Graph of Vout/Vin frequency response when inputs driven in common (common mode rejection).

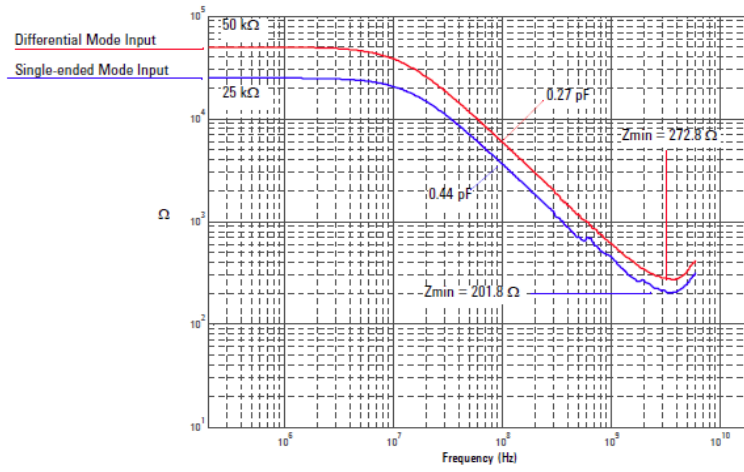

Figure 72 Magnitude plot of probe input impedance versus frequency.

E2677B Differential Solder-in Probe Head (Medium BW)

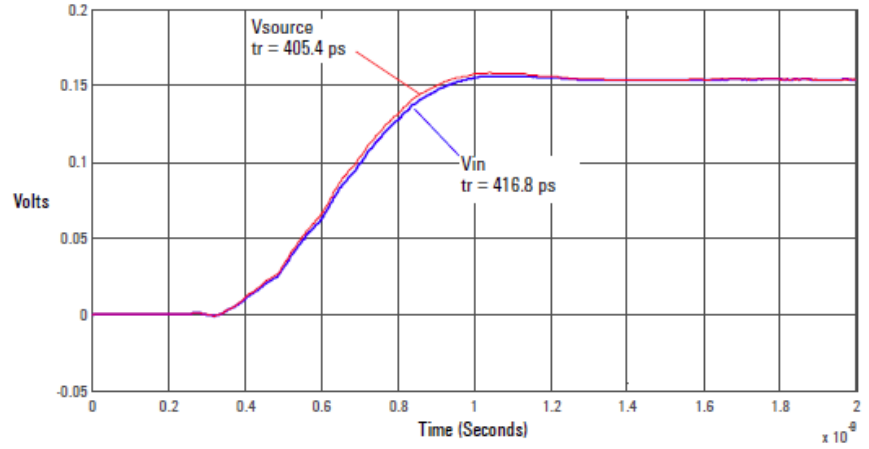

Figure 73 Graph of 25 ohm 405.4 ps step generator with and without probe connected.

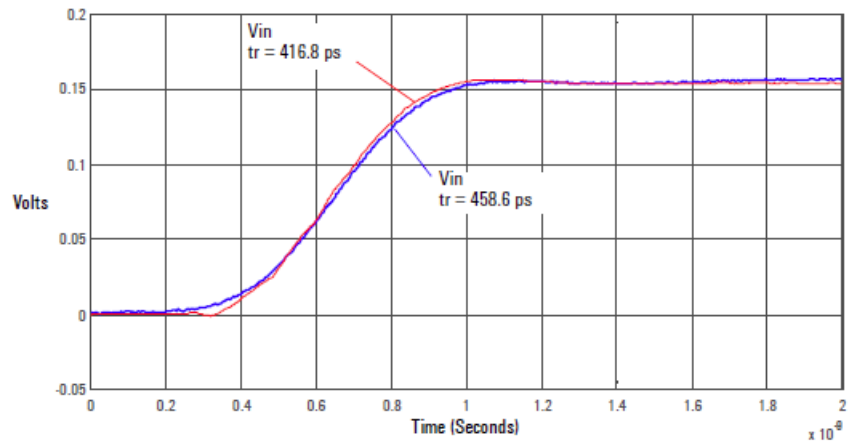

Figure 74 Graph of V_{in} and V_{out} of probe with a 25 ohm 405.4 ps step generator.

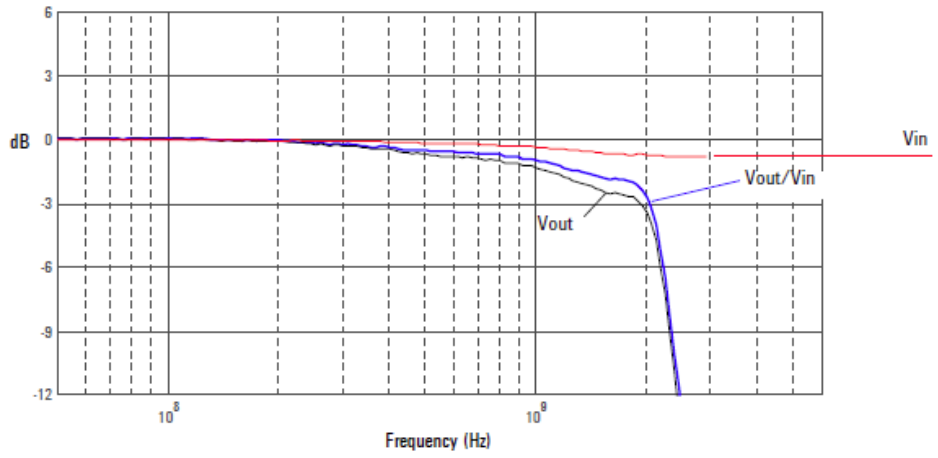

Figure 75 Graph of V_{in} and V_{out} of probe with a 25 ohm source and V_{out}/V_{in} frequency response.

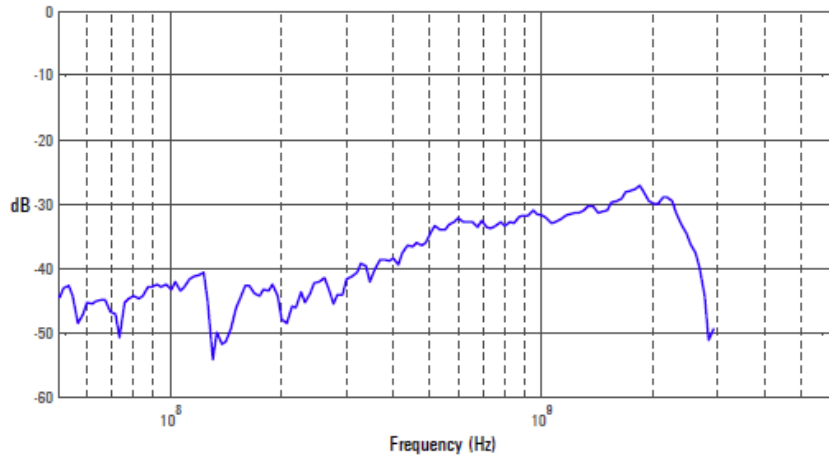

Figure 76 Graph of V_{out}/V_{in} frequency response when inputs driven in common (common mode rejection).

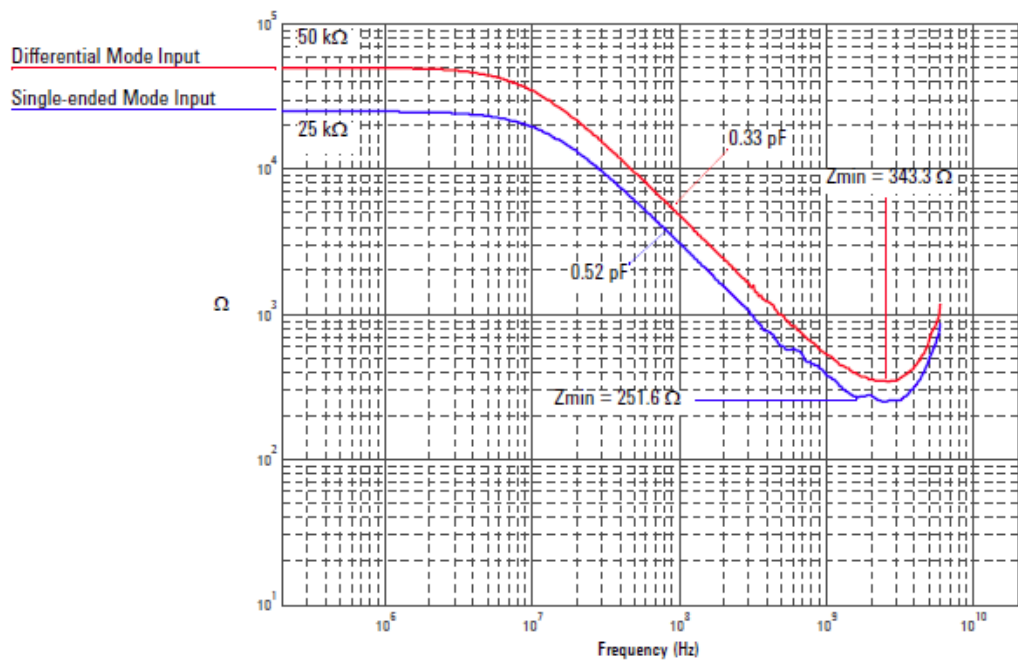

Figure 77 Magnitude plot of probe input impedance versus frequency.

E2678A/B Differential Socketed Probe Head (Full BW)

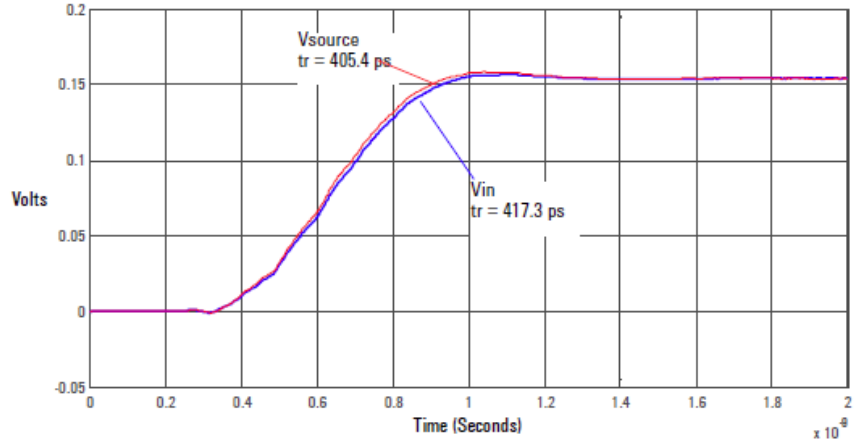

Figure 78 Graph of 25 ohm 405.4 ps step generator with and without probe connected.

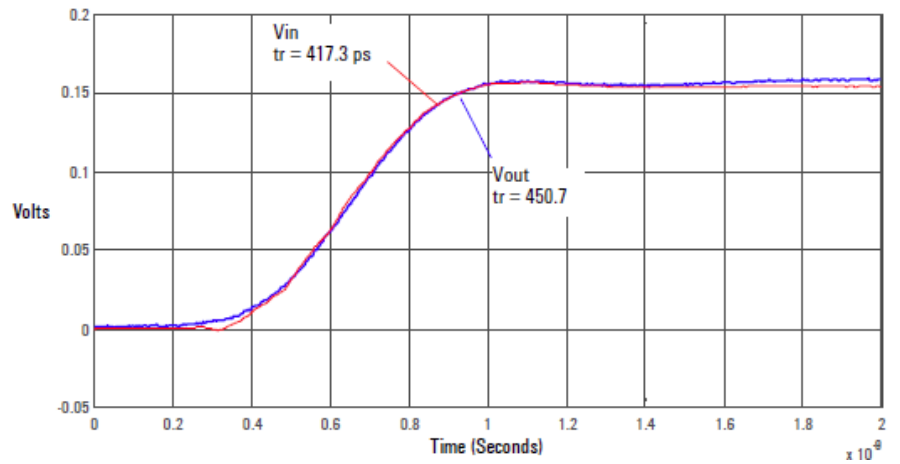

Figure 79 Graph of V_{in} and V_{out} of probe with a 25 ohm 405.4 ps step generator.

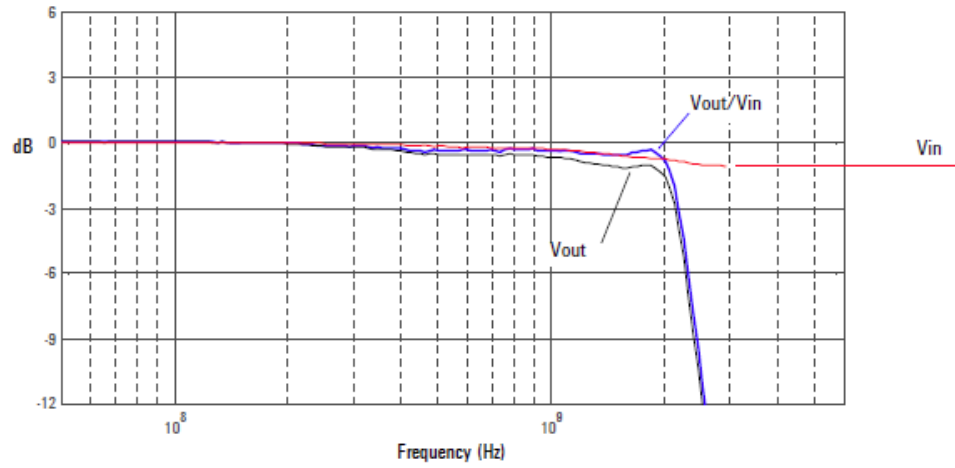

Figure 80 Graph of Vin and Vout of probe with a 25 ohm source and Vout/Vin frequency response.

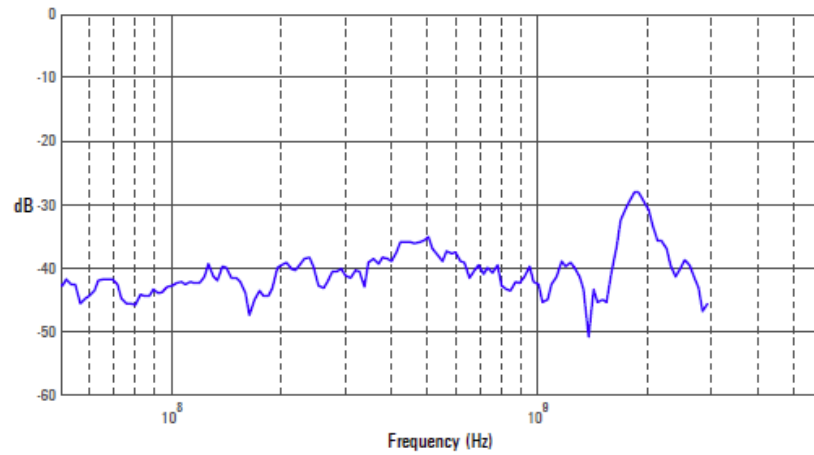

Figure 81 Graph of Vout/Vin frequency response when inputs driven in common (common mode rejection).

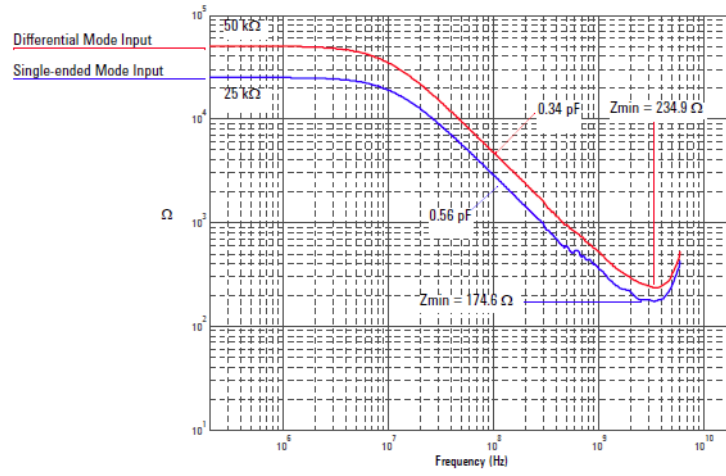

Figure 82 Magnitude plot of probe input impedance versus frequency.

E2678A/B Differential Socketed Probe Head with Damped Wire Accessory

NOTE

Due to reflections on the long wire accessories, signals being probed should be limited to ≥ 240 ps rise time measured at the 10% and 90% amplitude levels. This is equivalent to ≤ 4.5 GHz bandwidth.

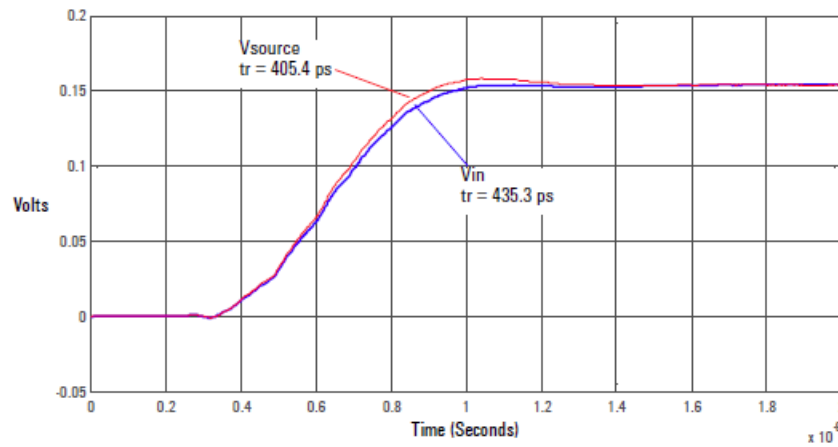

Figure 83 Graph of 25 ohm 240 ps step generator with and without probe connected.

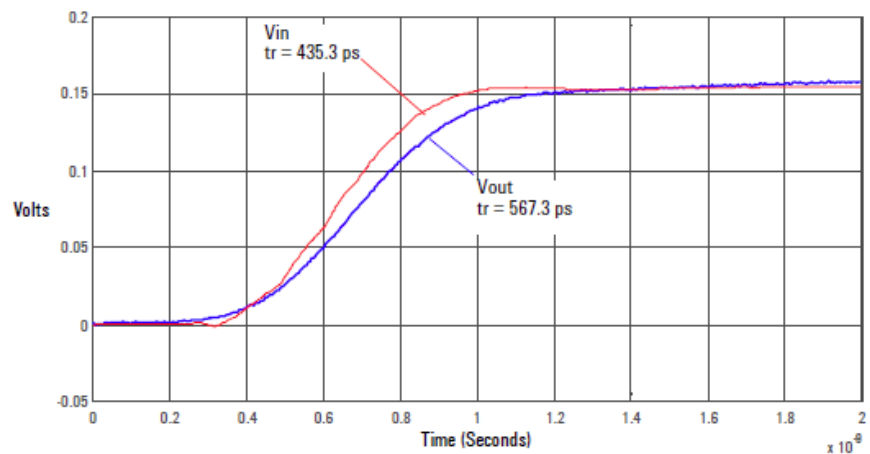

Figure 84 Graph of Vin and Vout of probe with a 25 ohm 240 ps step generator.

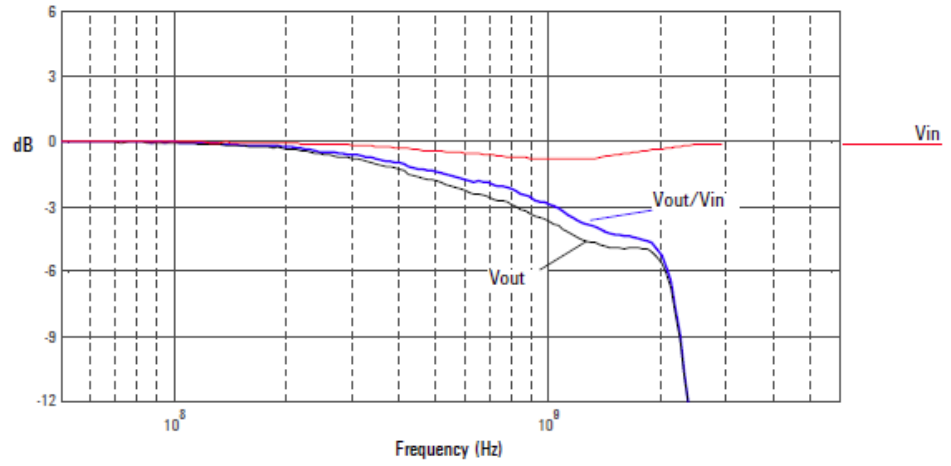

Figure 85 Graph of Vin and Vout of probe with a 25 ohm source and Vout/Vin frequency response.

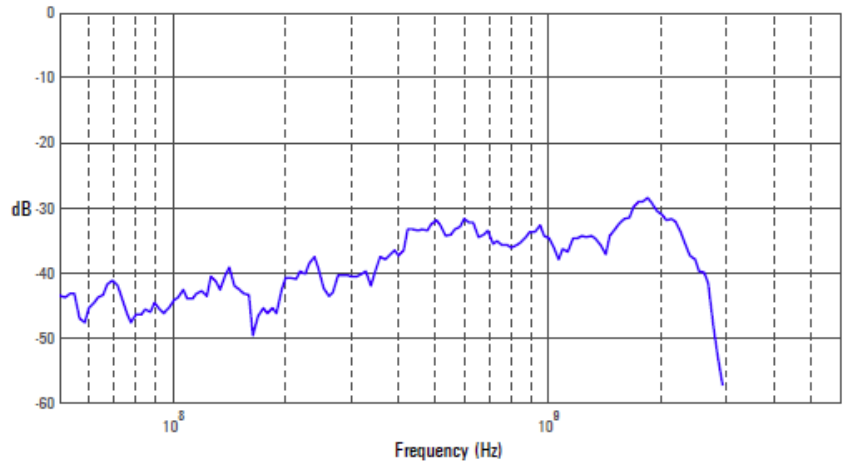

Figure 86 Graph of Vout/Vin frequency response when inputs driven in common (common mode rejection).

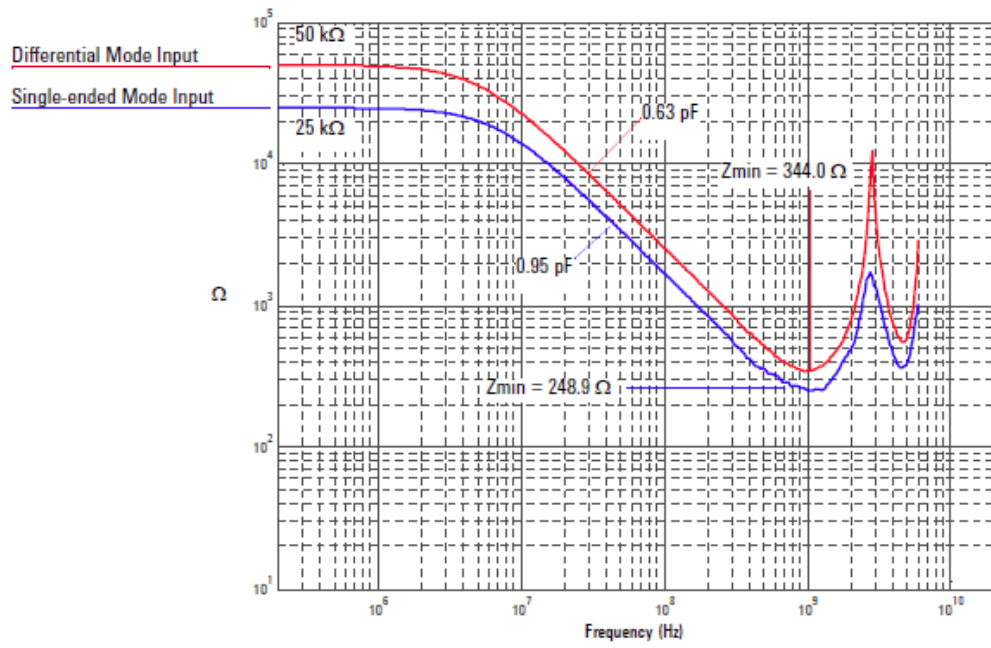

Figure 87 Magnitude plot of probe input impedance versus frequency.

E2679B Single-Ended Solder-in Probe Head (Full BW)

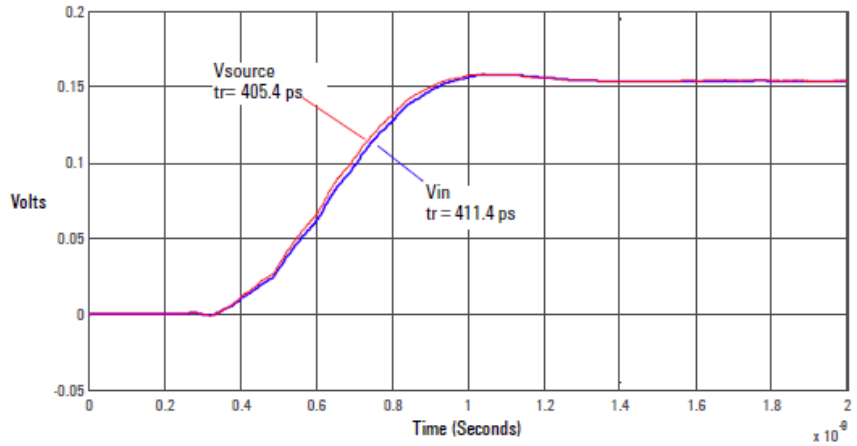

Figure 88 Graph of 25 ohm 405.4 ps step generator with and without probe connected.

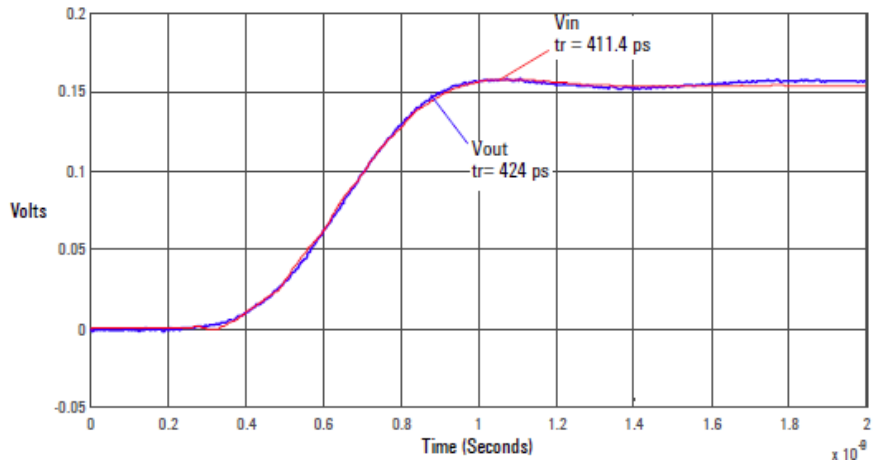

Figure 89 Graph of V_{in} and V_{out} of probe with a 25 ohm 405.4 ps step generator.

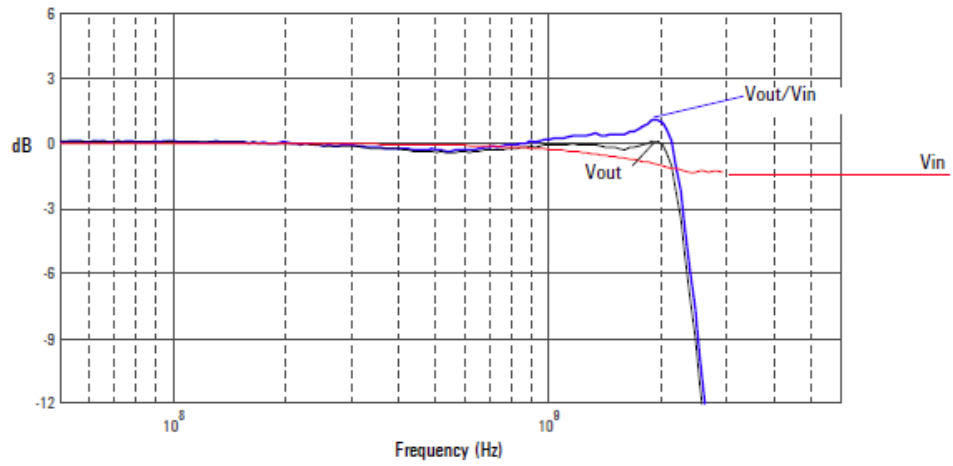

Figure 90 Graph of V_{in} and V_{out} of probe with a 25 ohm source and V_{out}/V_{in} frequency response.

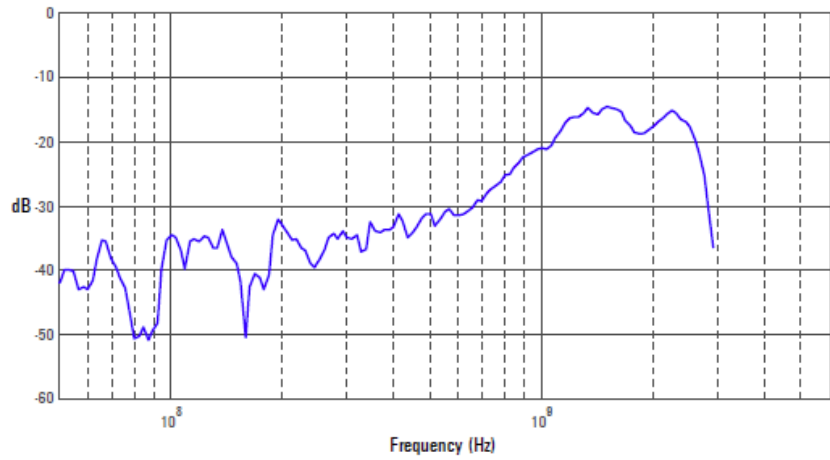

Figure 91 Graph of V_{out}/V_{in} frequency response when inputs driven in common (common mode rejection).

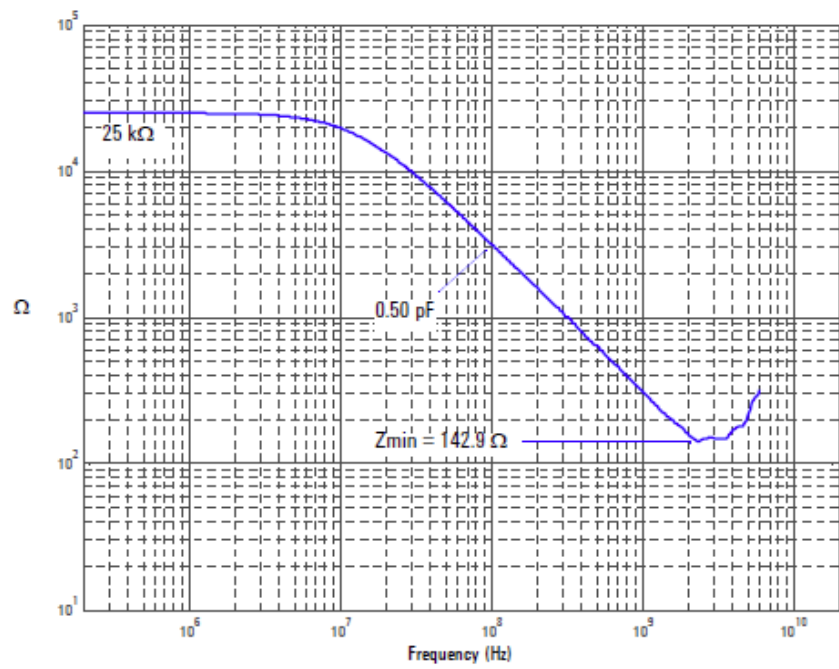

Figure 92 Magnitude plot of probe input impedance versus frequency.

E2679B Single-Ended Solder-in Probe Head (Medium BW)

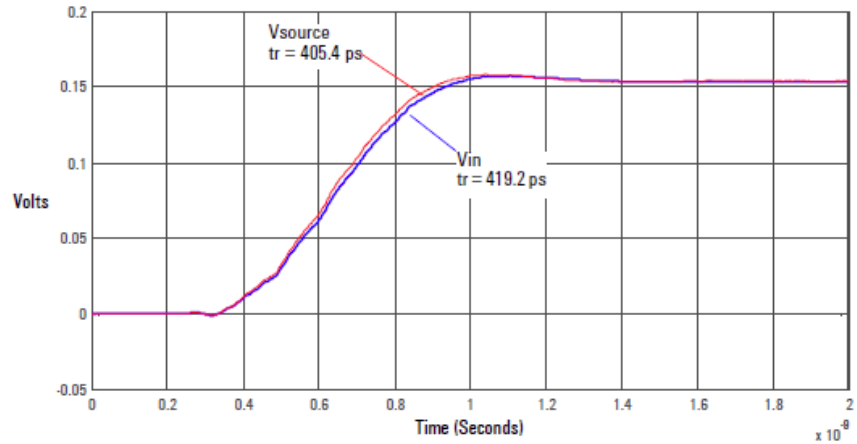

Figure 93 Graph of 25 ohm 405.4 ps step generator with and without probe connected.

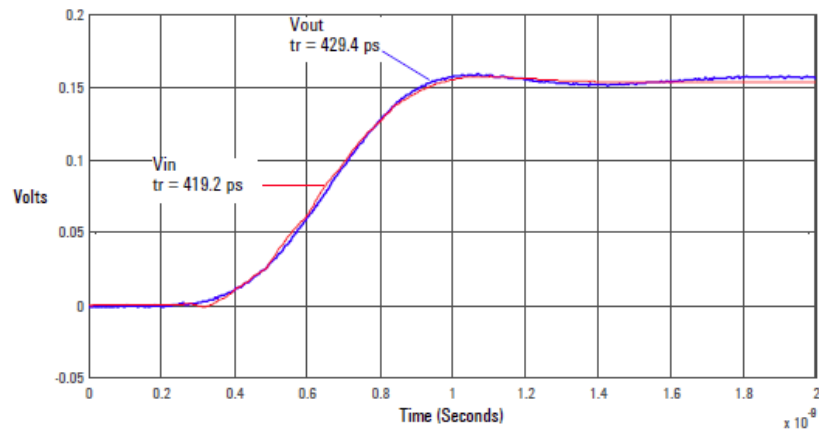

Figure 94 Graph of V_{in} and V_{out} of probe with a 25 ohm 405.4 ps step generator.

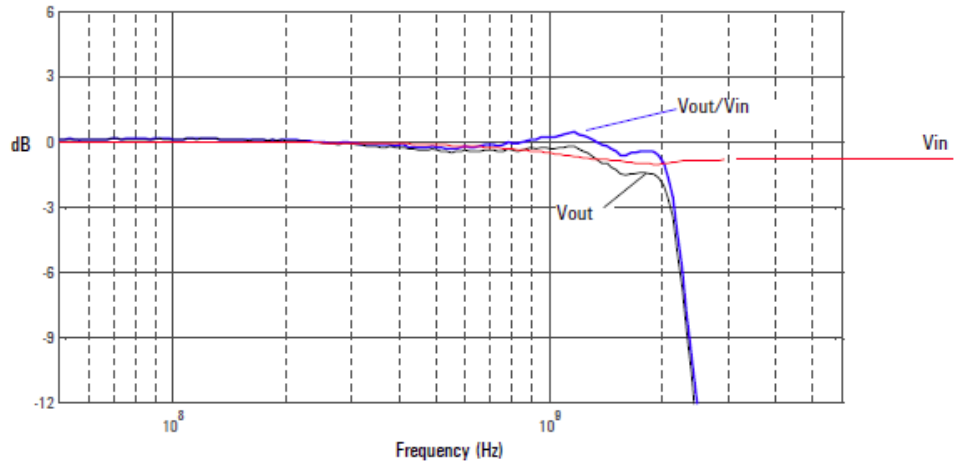

Figure 95 Graph of V_{in} and V_{out} of probe with a 25 ohm source and V_{out}/V_{in} frequency response.

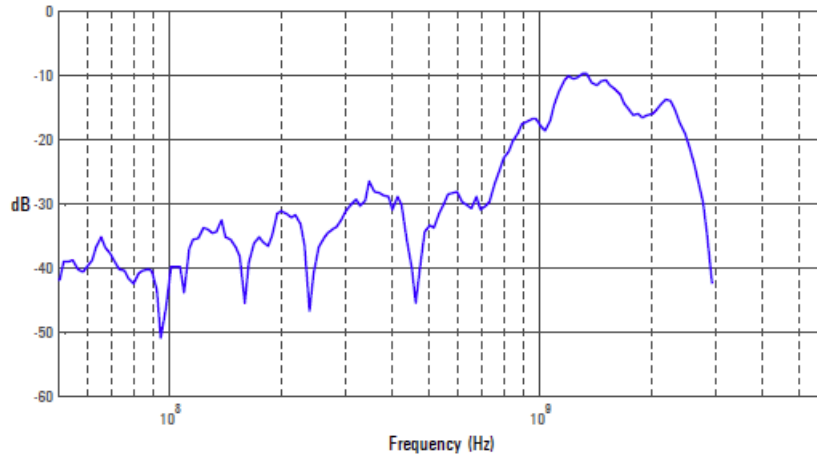

Figure 96 Graph of V_{out}/V_{in} frequency response when inputs driven in common (common mode rejection).

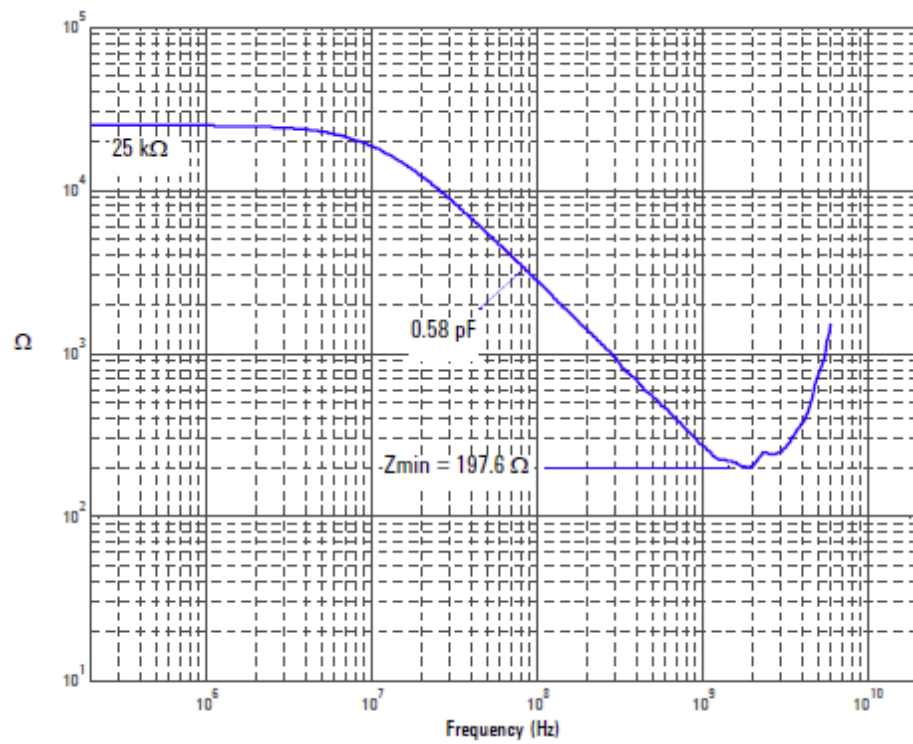

Figure 97 Magnitude plot of probe input impedance versus frequency.

N2851A QuickTip Head with N2849A QuickTip

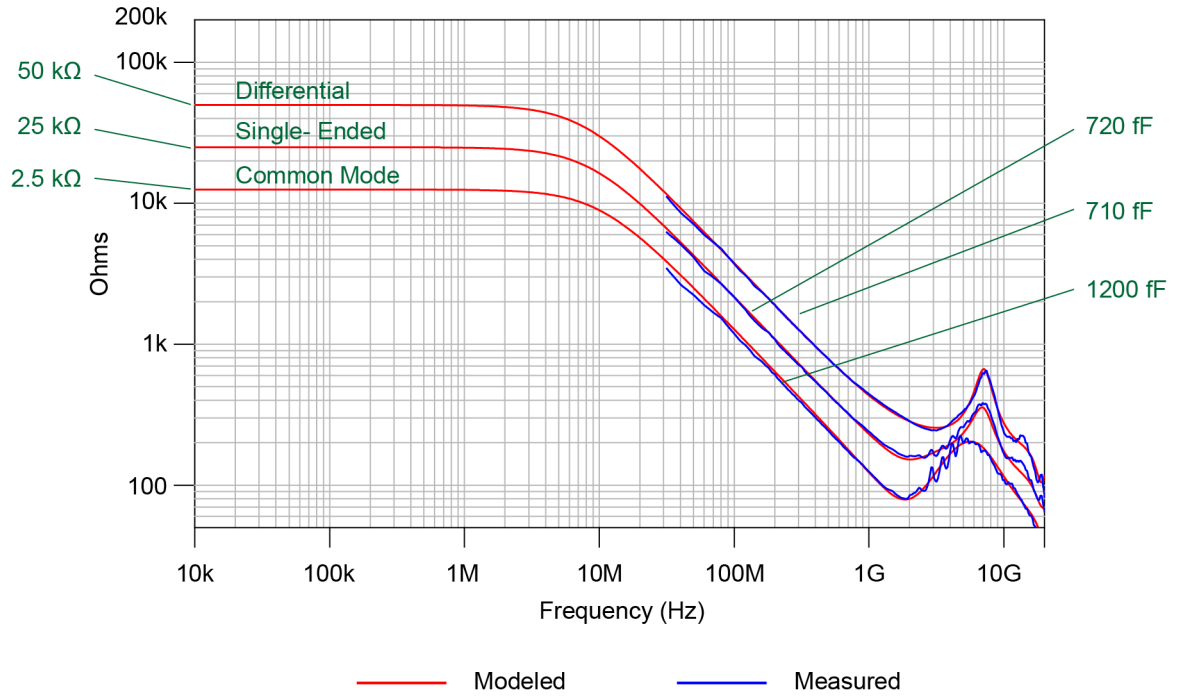

Figure 98 Input Impedances (Modeled and Measured)

6 1131B Performance Data Plots

E2675B Differential Browser	128
E2676B Single-Ended Browser	131
E2677B Differential Solder-in Probe Head (Full BW)	134
E2677B Differential Solder-in Probe Head (Medium BW)	137
E2678A/B Differential Socketed Probe Head (Full BW)	140
E2678A/B Differential Socketed Probe Head with Damped Wire Accessory	143
E2679B Single-Ended Solder-in Probe Head (Full BW)	146
E2679B Single-Ended Solder-in Probe Head (Medium BW)	149
N2851A QuickTip Head with N2849A QuickTip	152

This chapter provides graphs of the performance characteristics of the 1131B probes using the different probe heads that come with the E2668B single-ended and E2669B differential connectivity kits.

NOTE

All rise times shown are measured from the 10% to the 90% amplitude levels.

E2675B Differential Browser

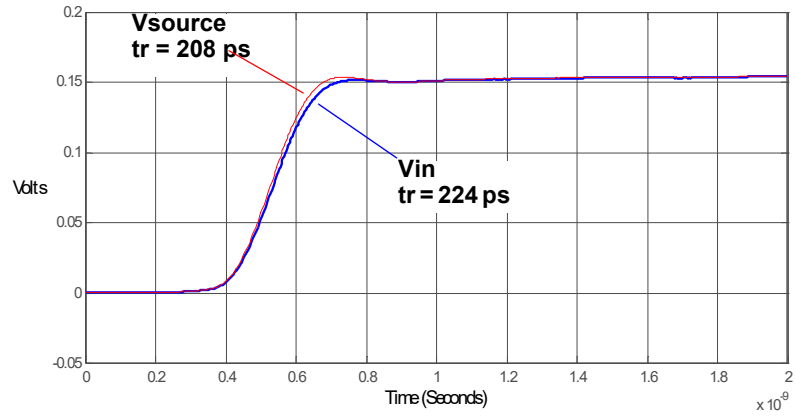

Figure 99 Graph of 25Ω 200 ps step generator with and without probe connected.

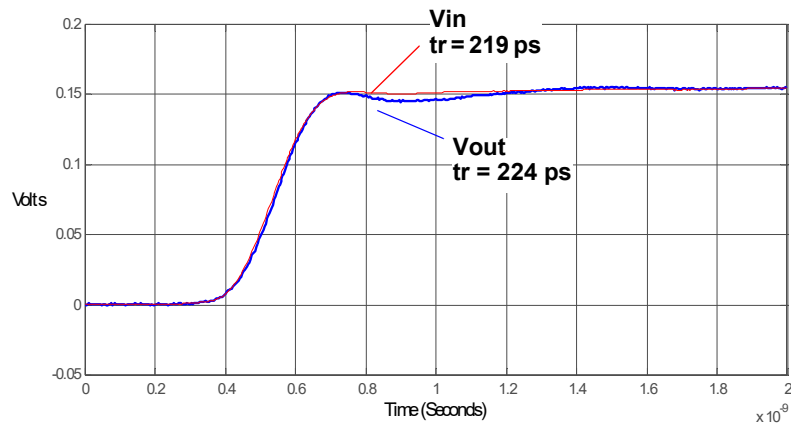

Figure 100 Graph of Vin and Vout of probe with a 25Ω 200 ps step generator.

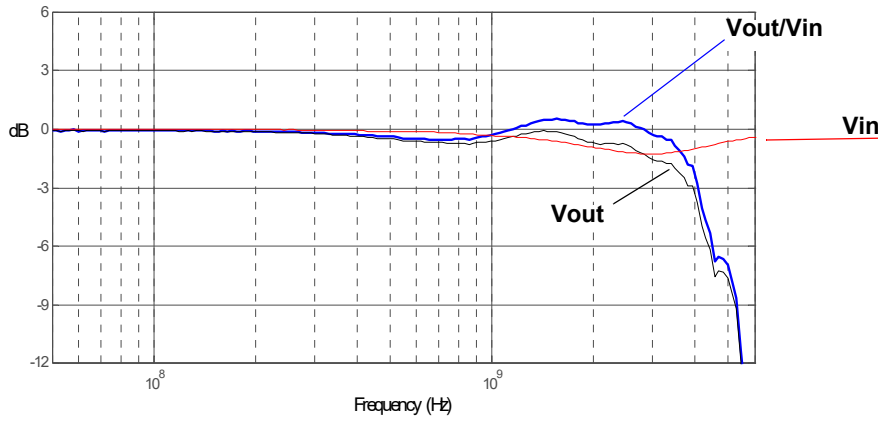

Figure 101 Graph of V_{in} and V_{out} of probe with a 25Ω source and V_{out}/V_{in} frequency response.

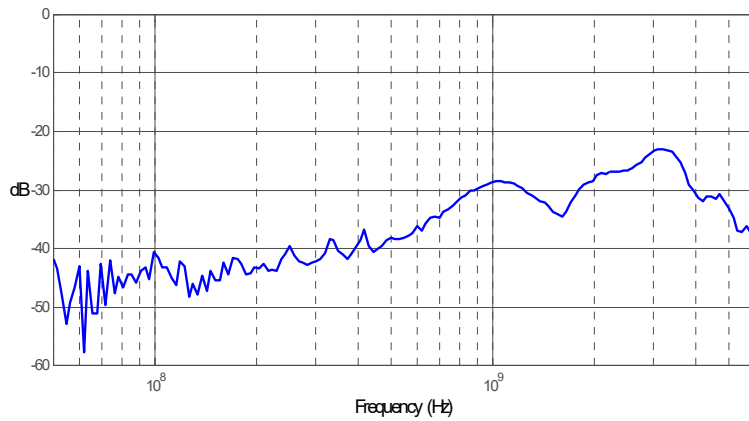

Figure 102 Graph of V_{out}/V_{in} frequency response when inputs driven in common (common mode rejection).

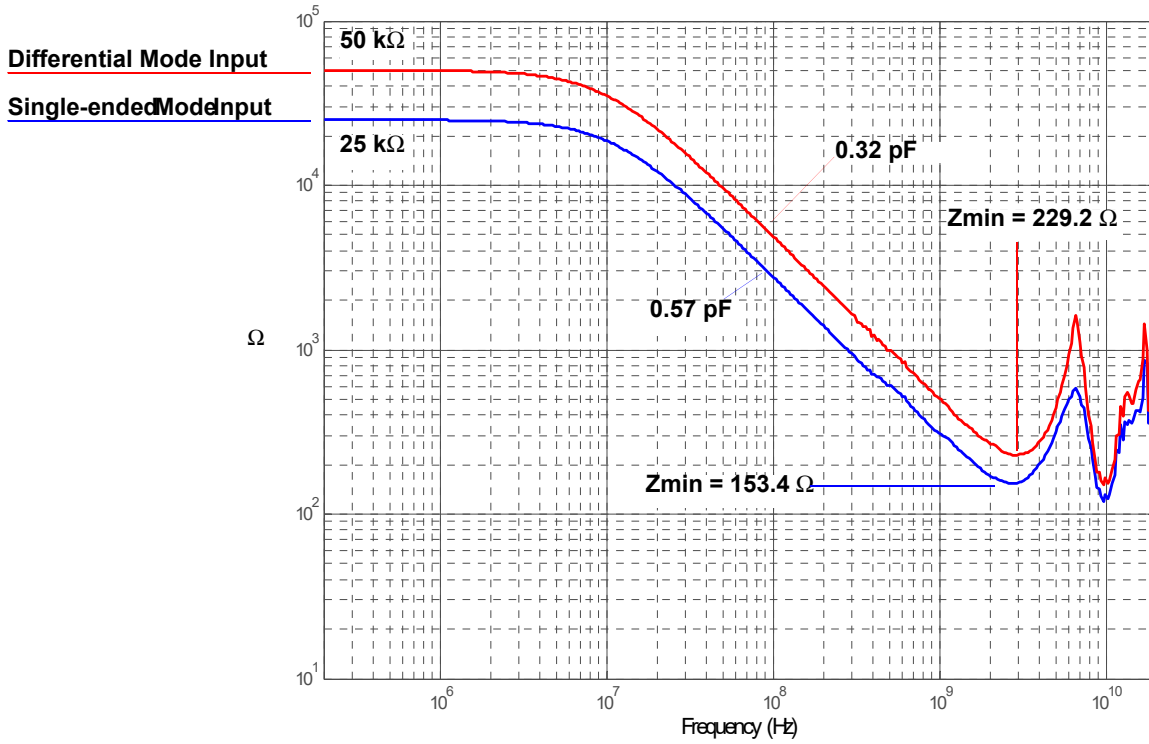

Figure 103 Magnitude plot of probe input impedance versus frequency.

E2676B Single-Ended Browser

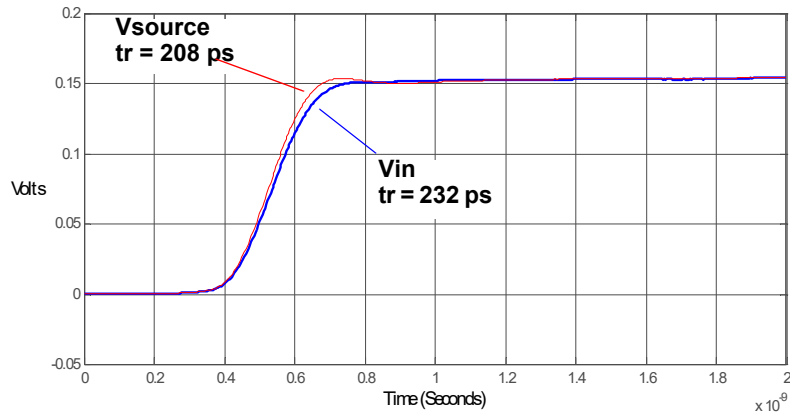

Figure 104 Graph of 25Ω 200 ps step generator with and without probe connected.

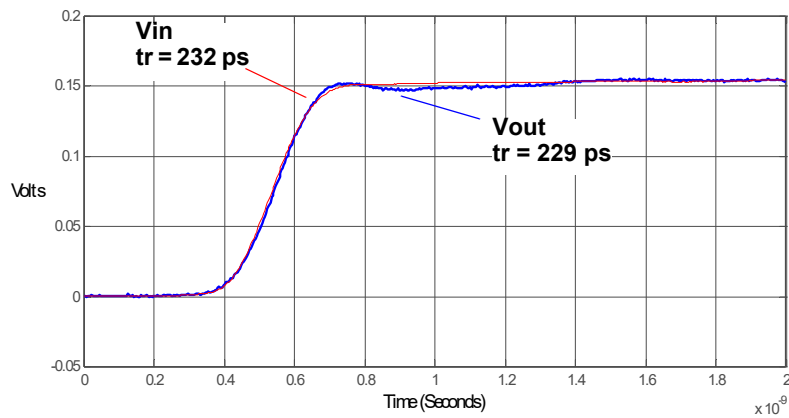

Figure 105 Graph of Vin and Vout of probe with a 25Ω 200 ps step generator.

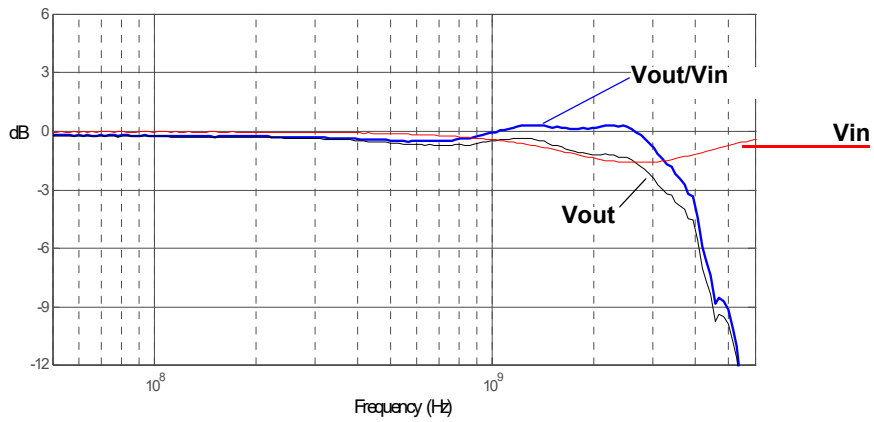

Figure 106 Graph of Vin and Vout of probe with a 25Ω source and Vout/Vin frequency response.

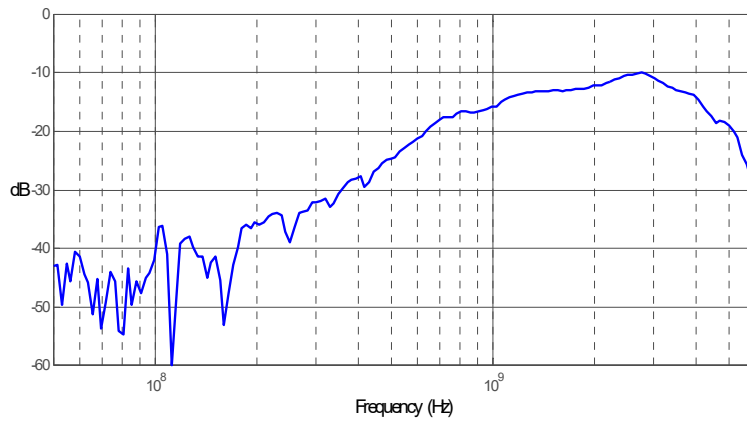

Figure 107 Graph of Vout/Vin frequency response when inputs driven in common (common mode rejection).

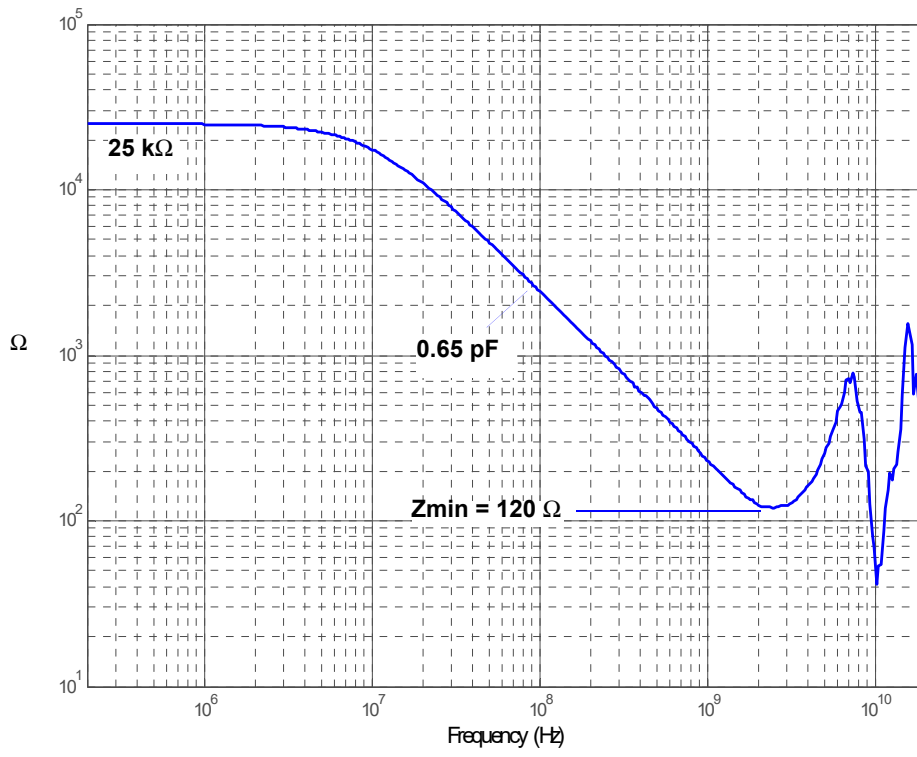

Figure 108 Magnitude plot of probe input impedance versus frequency.

E2677B Differential Solder-in Probe Head (Full BW)

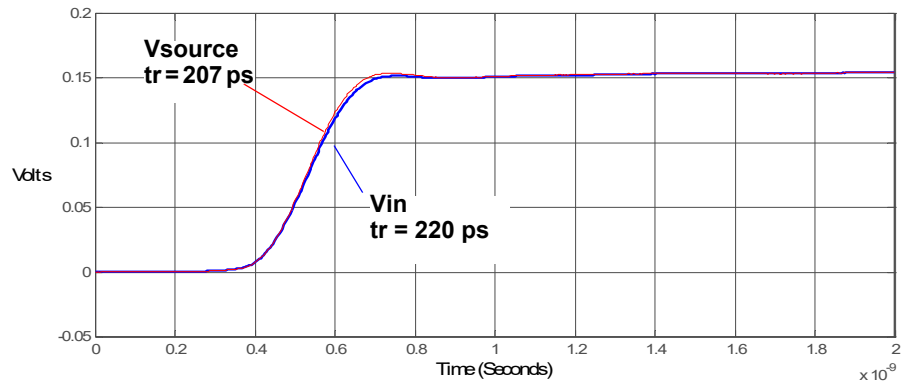

Figure 109 Graph of 25 ohm 200 ps step generator with and without probe connected.

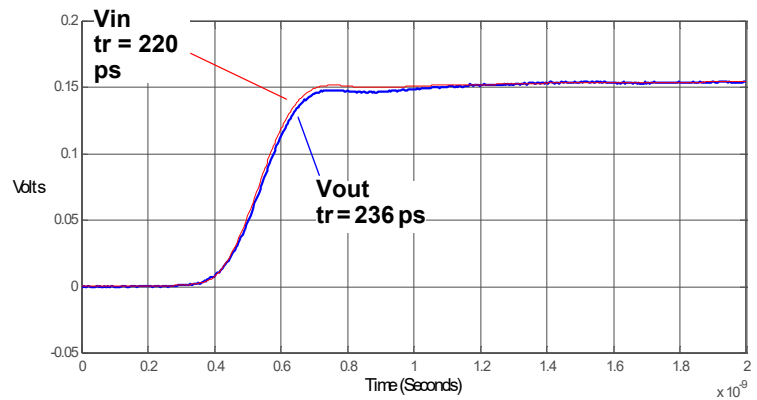

Figure 110 Graph of Vin and Vout of probe with a 25 ohm 200 ps step generator.

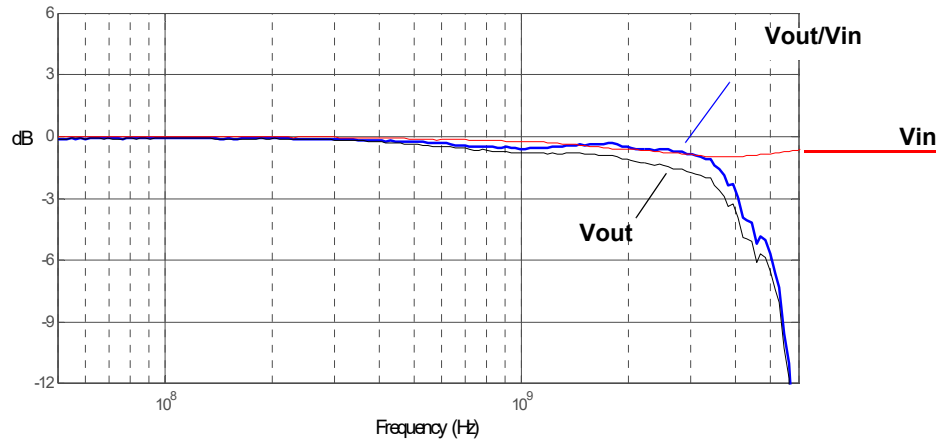

Figure 111 Graph of Vin and Vout of probe with a 25 ohm source and Vout/Vin frequency response.

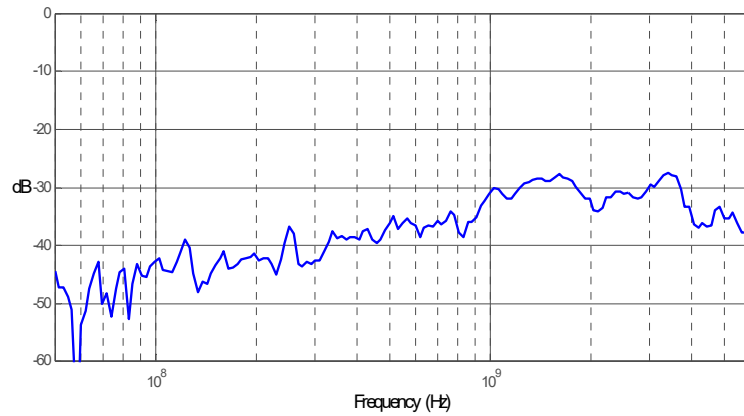

Figure 112 Graph of Vout/Vin frequency response when inputs driven in common (common mode rejection).

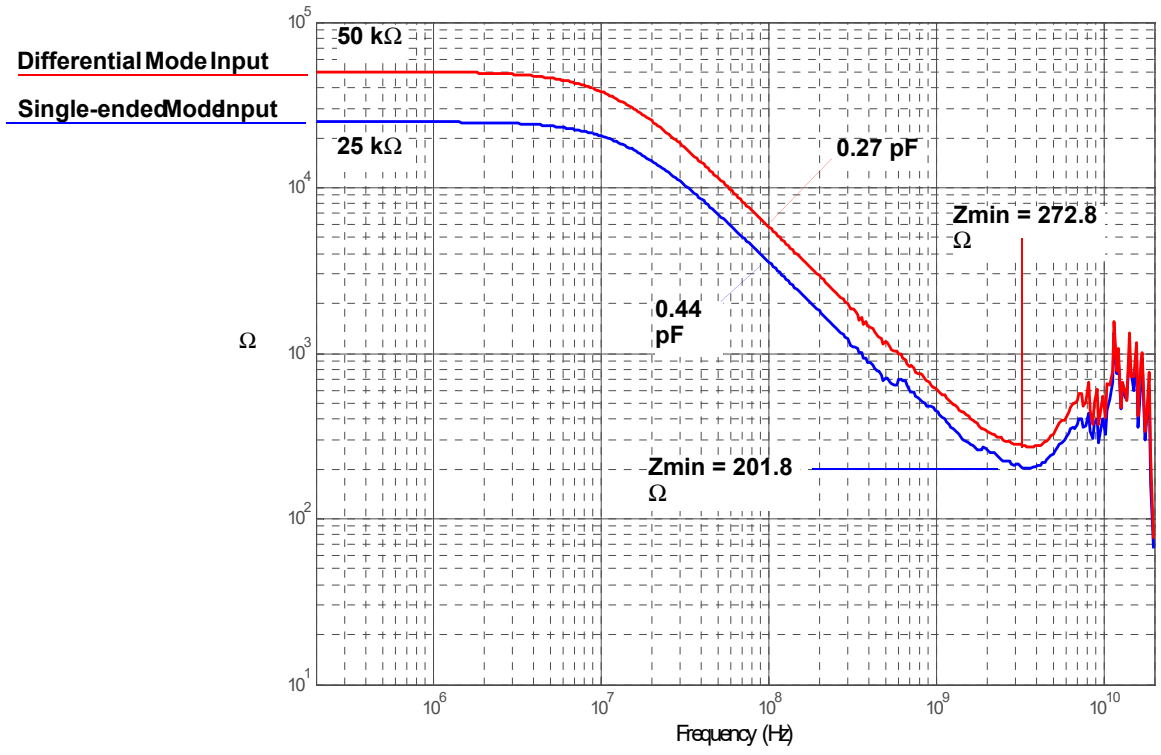

Figure 113 Magnitude plot of probe input impedance versus frequency.

E2677B Differential Solder-in Probe Head (Medium BW)

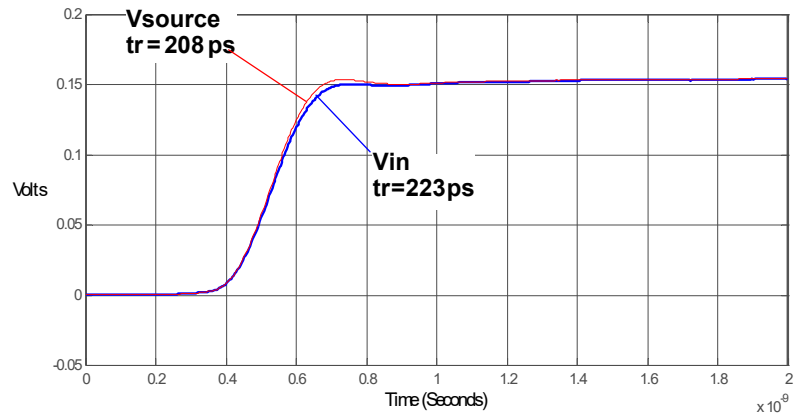

Figure 114 Graph of 25Ω 200 ps step generator with and without probe connected.

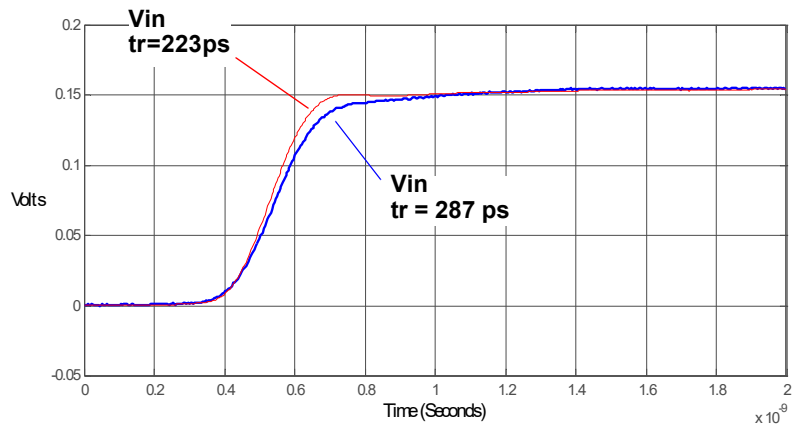

Figure 115 Graph of Vin and Vout of probe with a 25Ω 200 ps step generator.

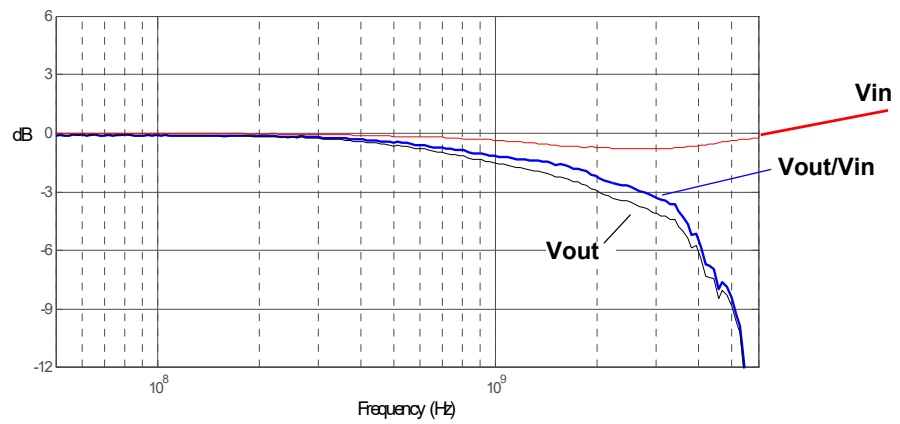

Figure 116 Graph of V_{in} and V_{out} of probe with a 25Ω source and V_{out}/V_{in} frequency response.

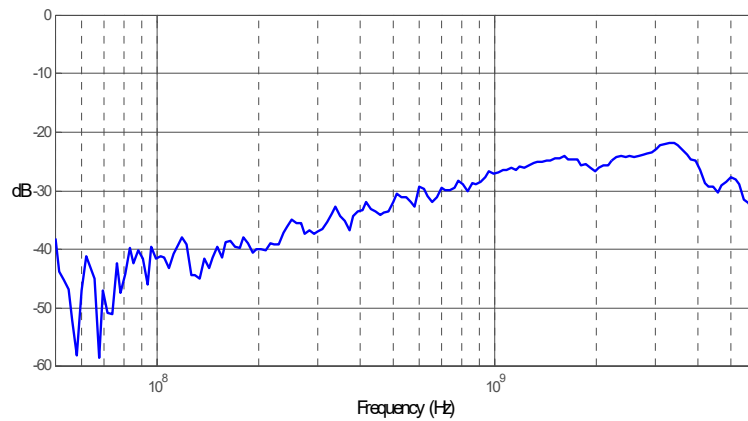

Figure 117 Graph of V_{out}/V_{in} frequency response when inputs driven in common (common mode rejection).

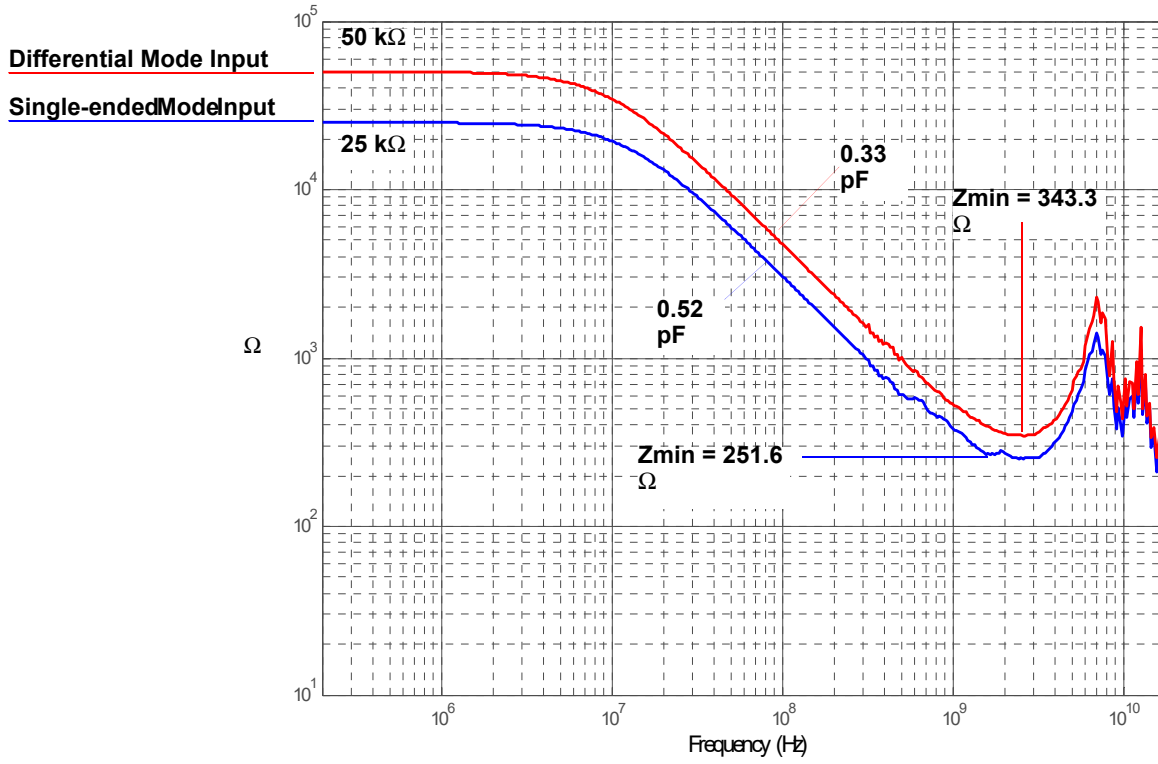

Figure 118 Magnitude plot of probe input impedance versus frequency.

E2678A/B Differential Socketed Probe Head (Full BW)

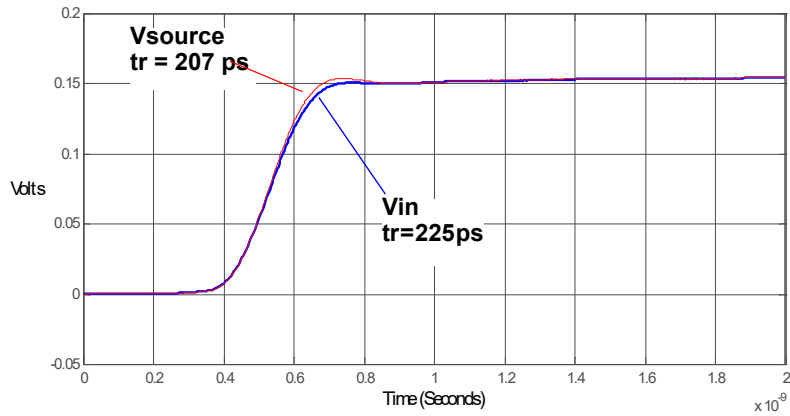

Figure 119 Graph of 25Ω 200 ps step generator with and without probe connected.

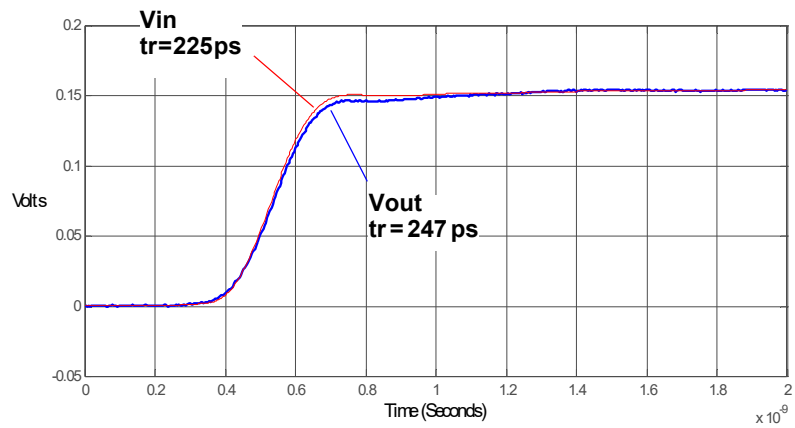

Figure 120 Graph of Vin and Vout of probe with a 25Ω 200 ps step generator.

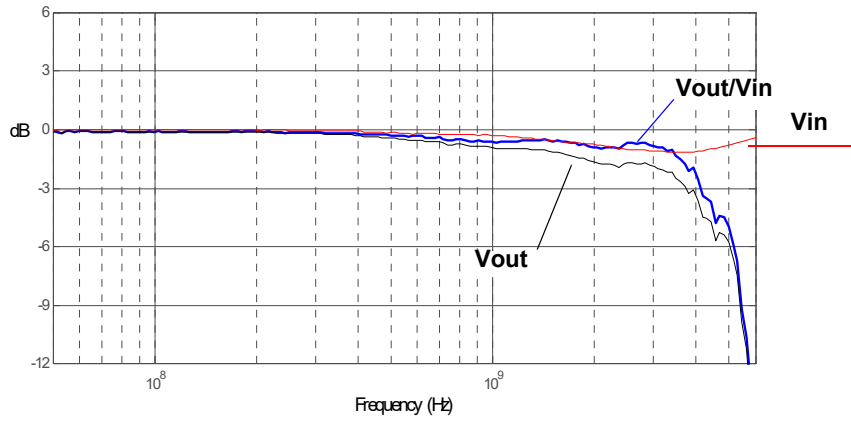

Figure 121 Graph of V_{in} and V_{out} of probe with a 25Ω source and V_{out}/V_{in} frequency response.

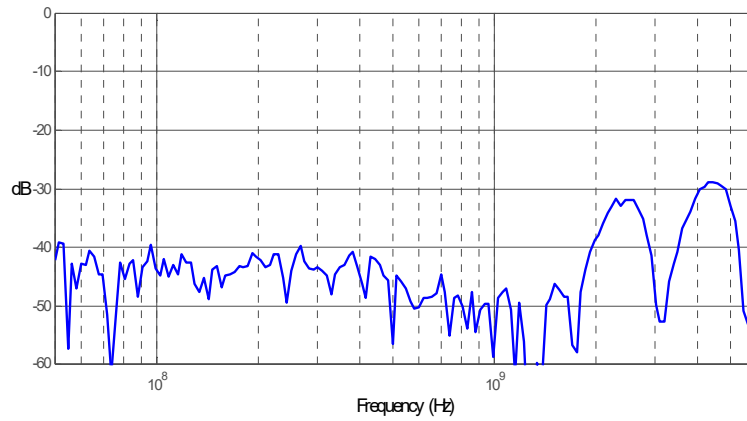

Figure 122 Graph of V_{out}/V_{in} frequency response when inputs driven in common (common mode rejection).

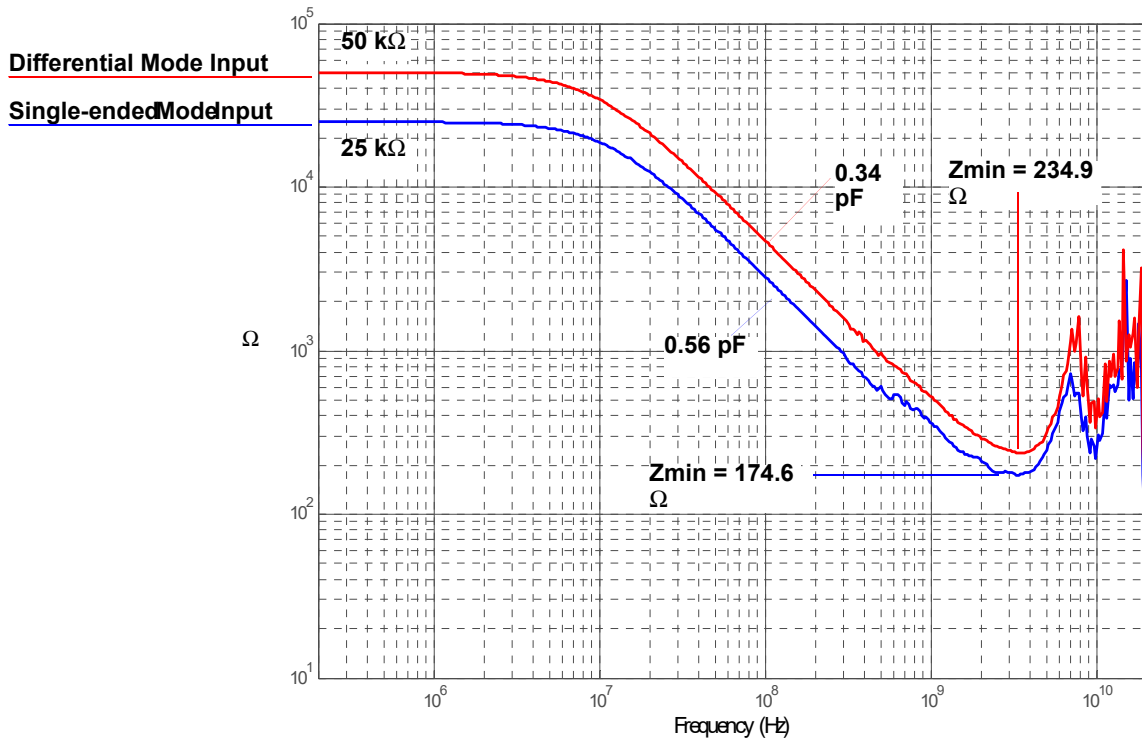

Figure 123 Magnitude plot of probe input impedance versus frequency.

E2678A/B Differential Socketed Probe Head with Damped Wire Accessory

NOTE

Due to reflections on the long wire accessories, signals being probed should be limited to ≥ 240 ps rise time measured at the 10% and 90% amplitude levels. This is equivalent to ≤ 1.5 GHz bandwidth.

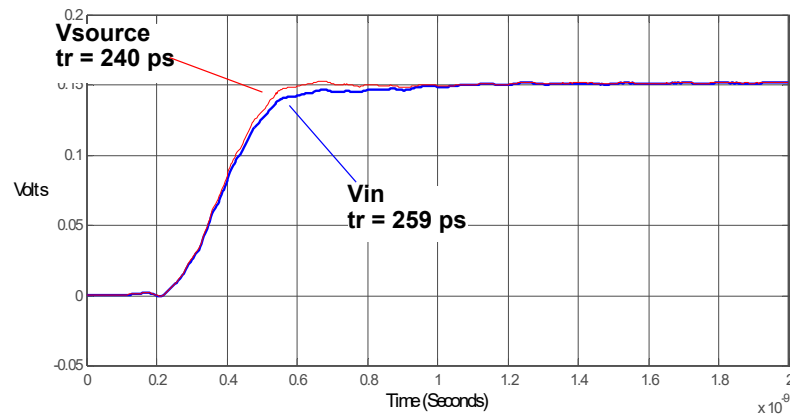

Figure 124 Graph of 25Ω 240 ps step generator with and without probe connected.

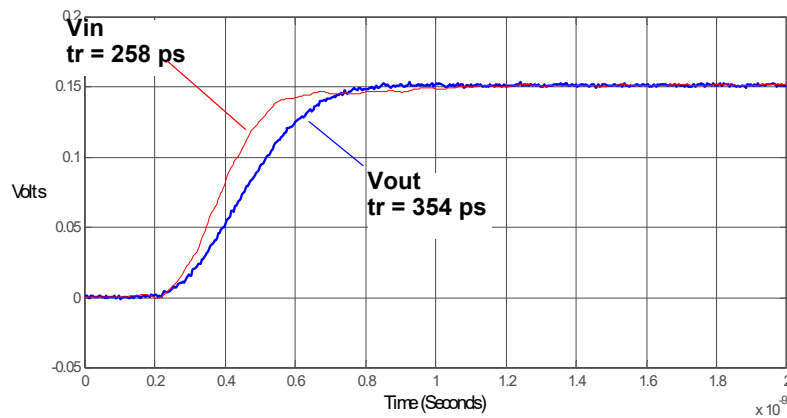

Figure 125 Graph of V_{in} and V_{out} of probe with a 25Ω 240 ps step generator.

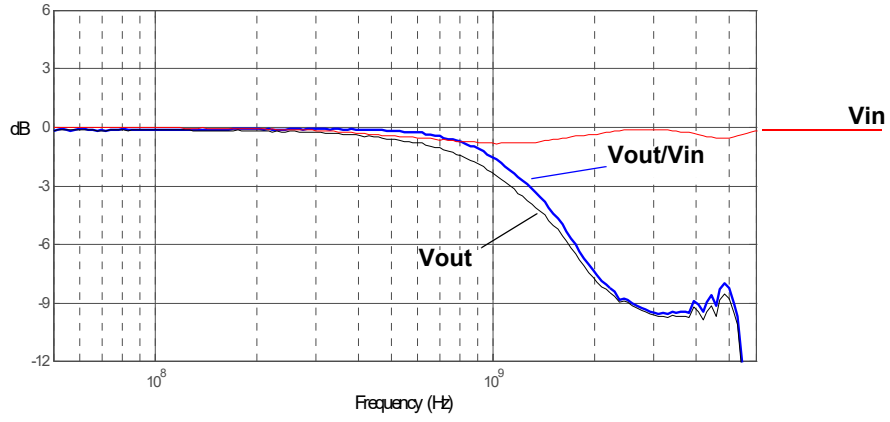

Figure 126 Graph of Vin and Vout of probe with a 25Ω source and Vout/Vin frequency response.

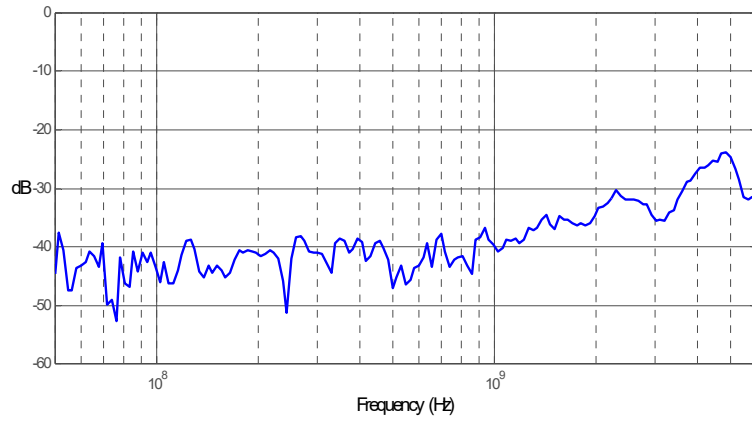

Figure 127 Graph of Vout/Vin frequency response when inputs driven in common (common mode rejection).

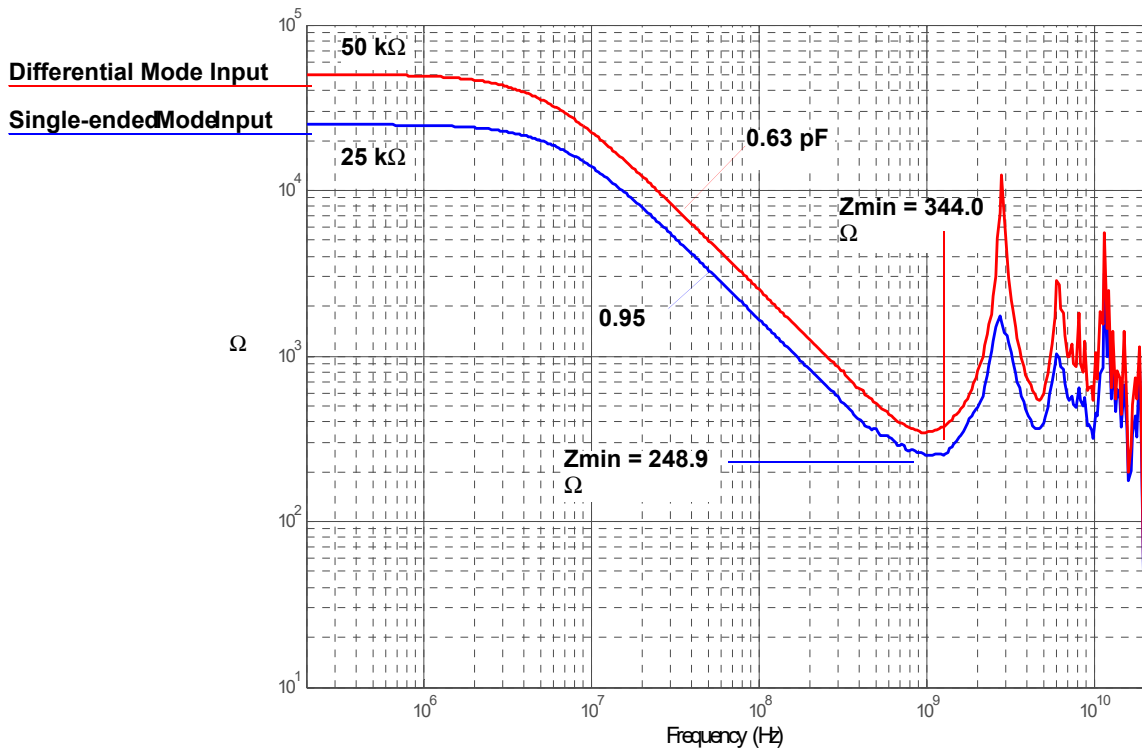

Figure 128 Magnitude plot of probe input impedance versus frequency.

E2679B Single-Ended Solder-in Probe Head (Full BW)

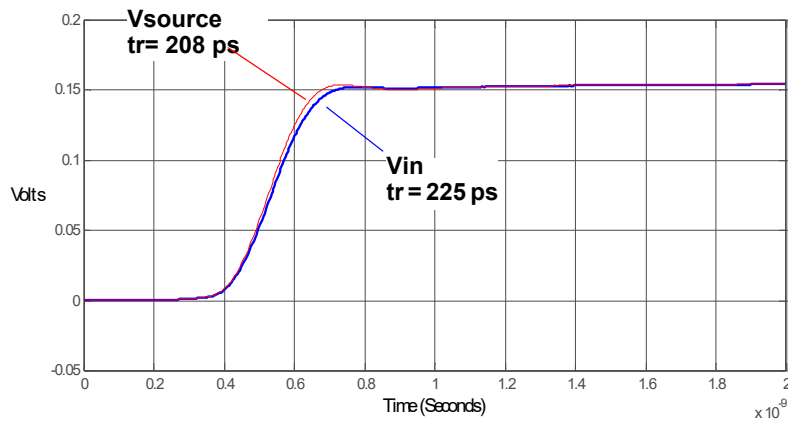

Figure 129 Graph of 25Ω 200 ps step generator with and without probe connected.

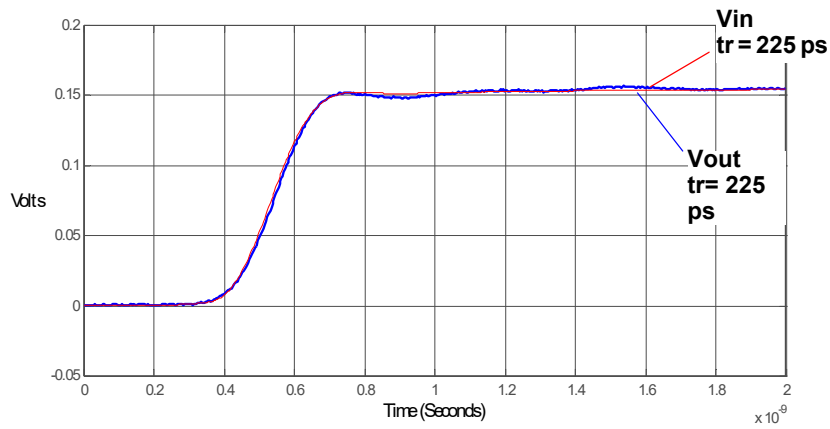

Figure 130 Graph of Vin and Vout of probe with a 25Ω 200 ps step generator.

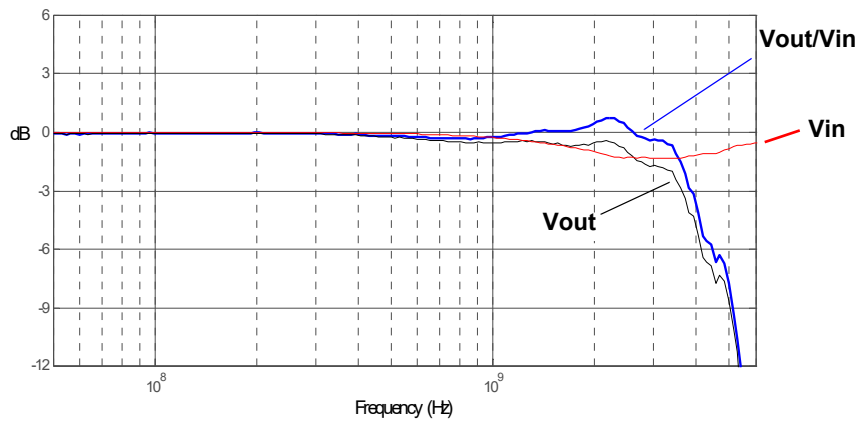

Figure 131 Graph of Vin and Vout of probe with a 25Ω source and Vout/Vin frequency response.

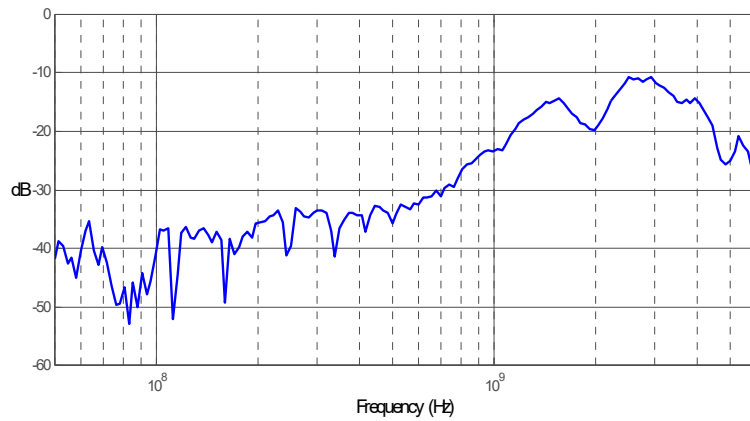

Figure 132 Graph of Vout/Vin frequency response when inputs driven in common (common mode rejection).

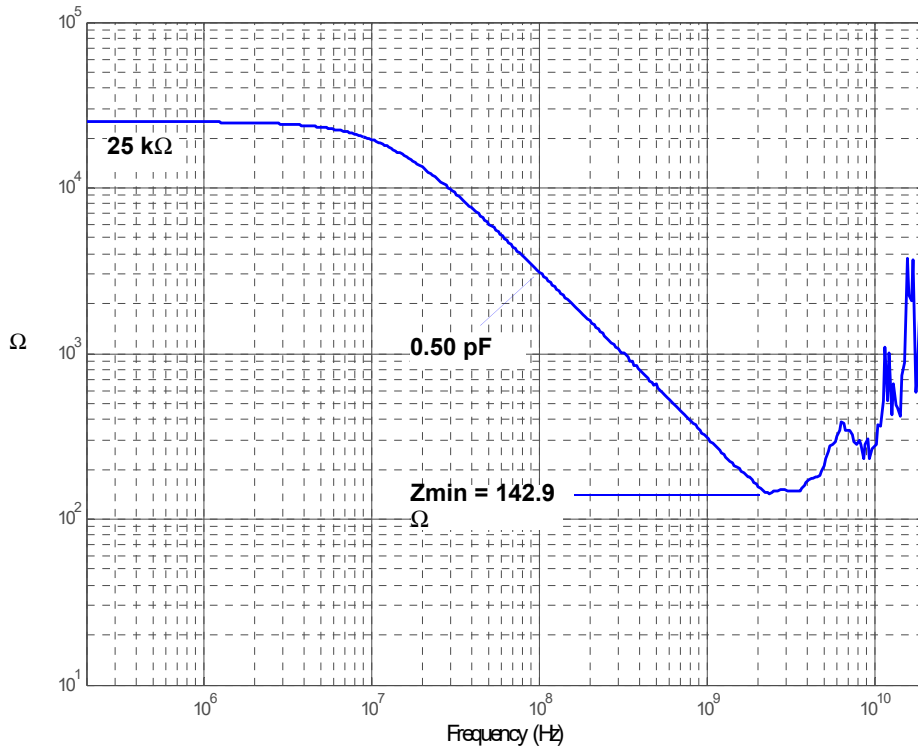

Figure 133 Magnitude plot of probe input impedance versus frequency.

E2679B Single-Ended Solder-in Probe Head (Medium BW)

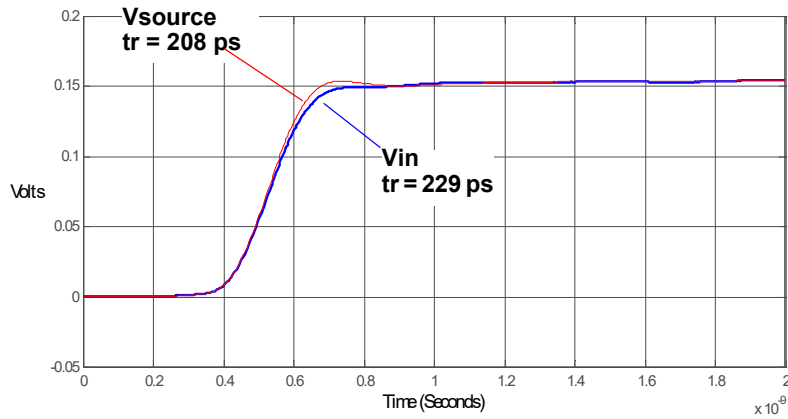

Figure 134 Graph of 25Ω 200 ps step generator with and without probe connected.

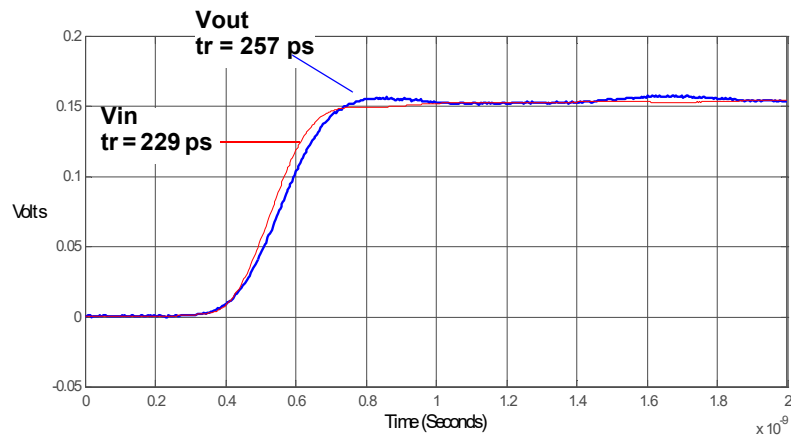

Figure 135 Graph of Vin and Vout of probe with a 25Ω 200 ps step generator.

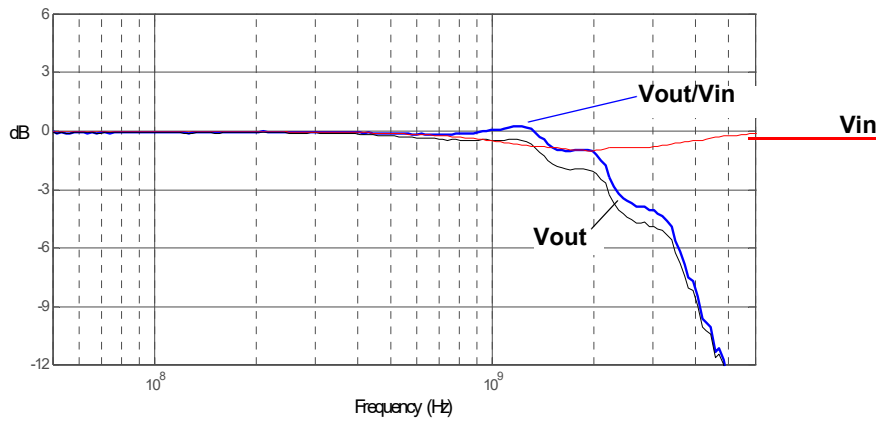

Figure 136 Graph of V_{in} and V_{out} of probe with a 25Ω source and V_{out}/V_{in} frequency response.

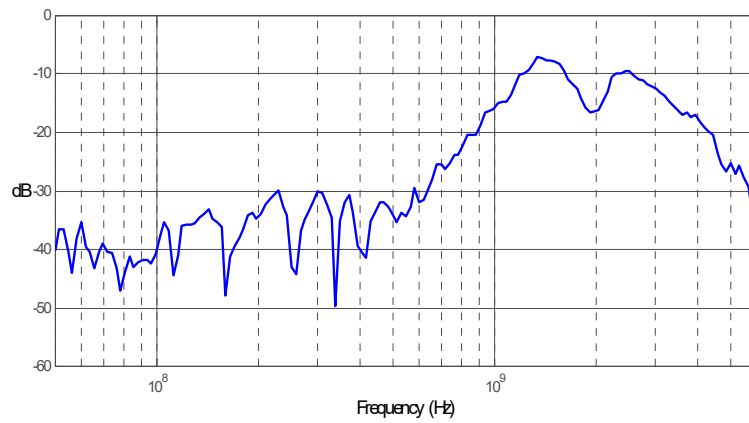

Figure 137 Graph of V_{out}/V_{in} frequency response when inputs driven in common (common mode rejection).

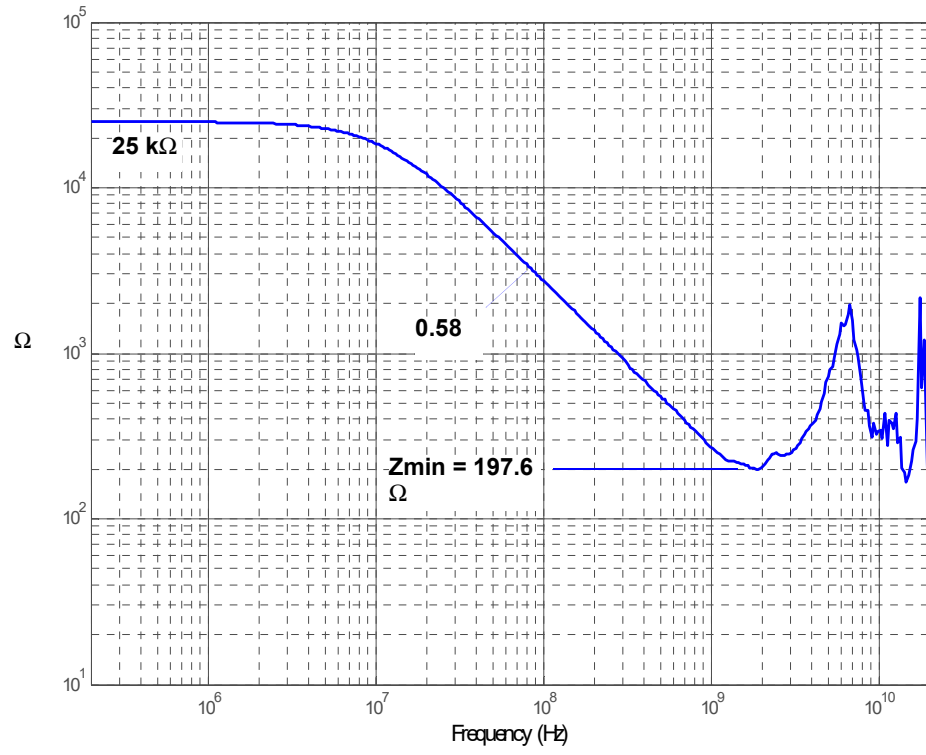

Figure 138 Magnitude plot of probe input impedance versus frequency.

N2851A QuickTip Head with N2849A QuickTip

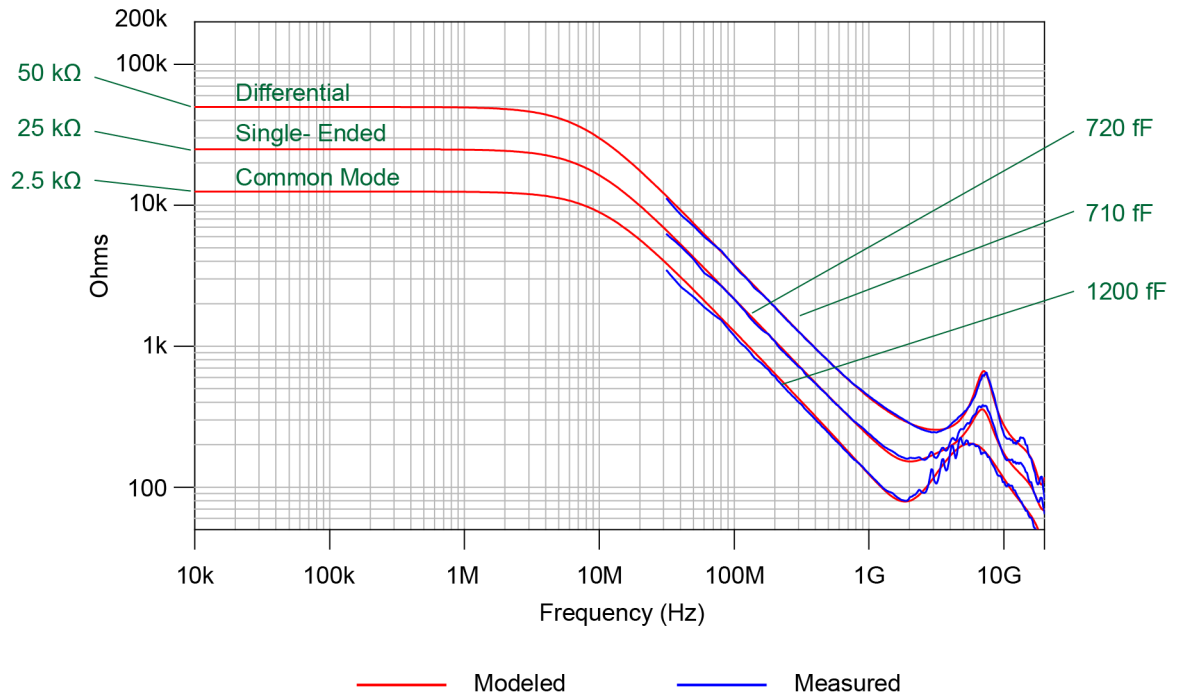

Figure 139 Input Impedances (Modeled and Measured)

7 1132B Performance Data Plots

E2675B Differential Browser	154
E2676B Single-Ended Browser	157
E2677B Differential Solder-in Probe Head (Full BW)	160
E2677B Differential Solder-in Probe Head (Medium BW)	163
E2678A/B Differential Socketed Probe Head (Full BW)	166
E2678A/B Differential Socketed Probe Head with Damped Wire Accessory	169
E2679B Single-Ended Solder-in Probe Head (Full BW)	172
E2679B Single-Ended Solder-in Probe Head (Medium BW)	175
N2851A QuickTip Head with N2849A QuickTip	178

This chapter provides graphs of the performance characteristics of the 1132B probes using the different probe heads that come with the E2668B single-ended and E2669B differential connectivity kits.

NOTE

All rise times shown are measured from the 10% to the 90% amplitude levels.

E2675B Differential Browser

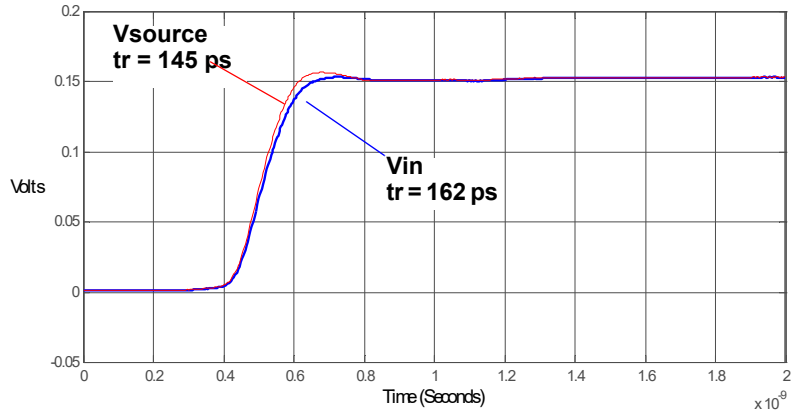

Figure 140 Graph of 25Ω 100 ps step generator with and without probe connected.

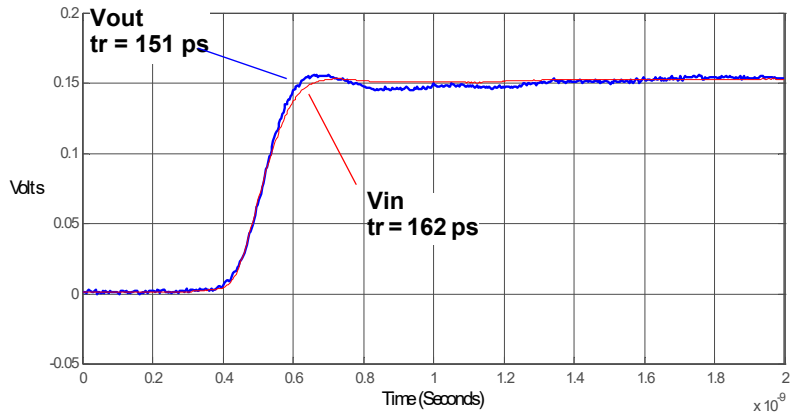

Figure 141 Graph of Vin and Vout of probe with a 25Ω 100 ps step generator.

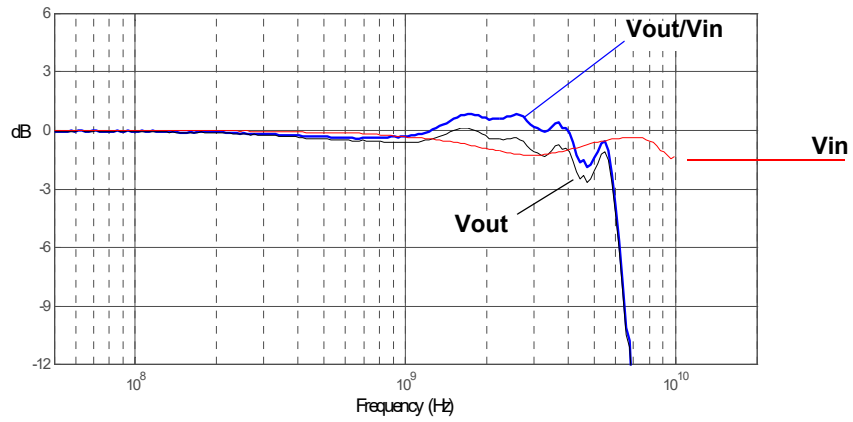

Figure 142 Graph of Vin and Vout of probe with a 25Ω source and Vout/Vin frequency response.

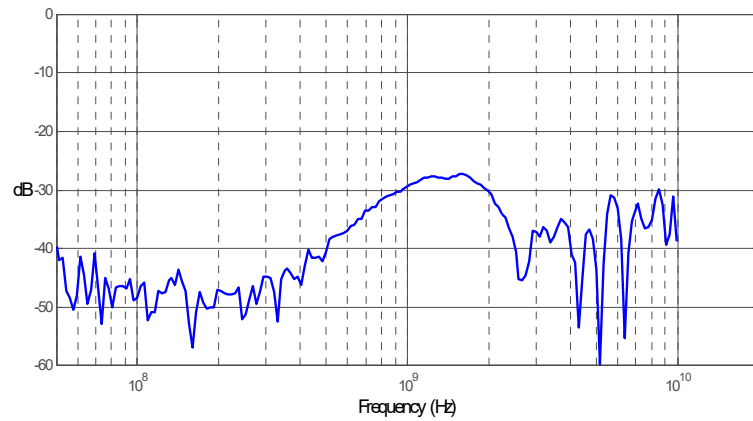

Figure 143 Graph of Vout/Vin frequency response when inputs driven in common (common mode rejection).

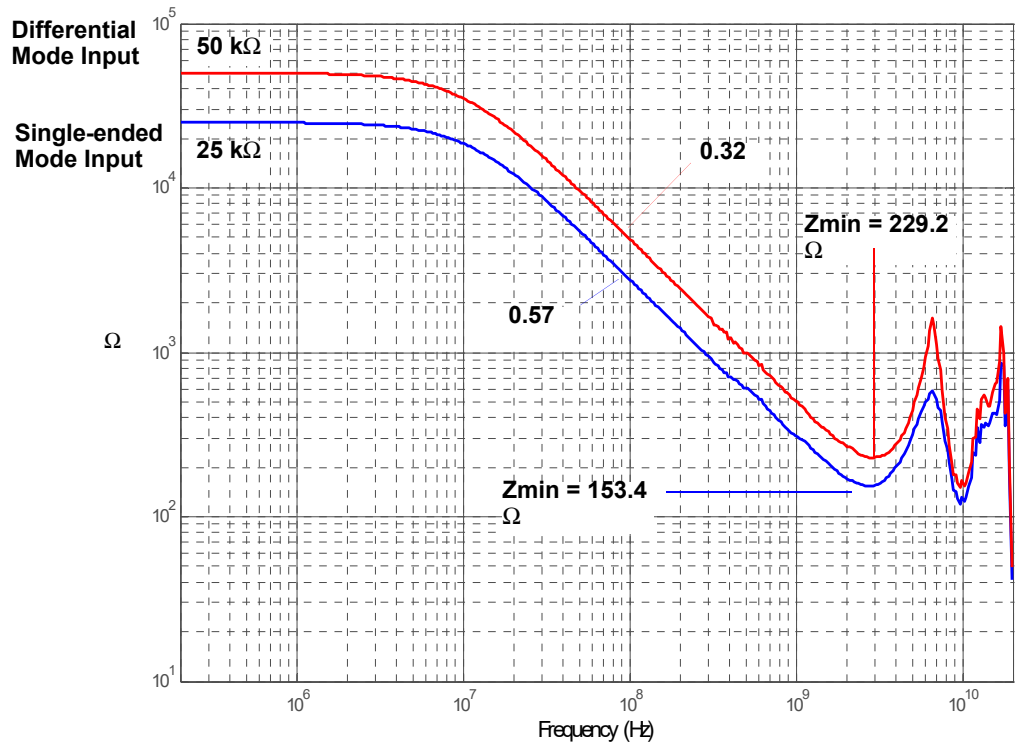

Figure 144 Magnitude plot of probe input impedance versus frequency.

E2676B Single-Ended Browser

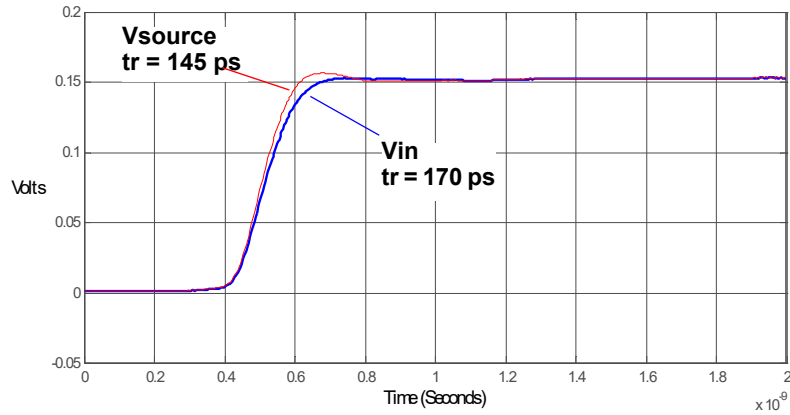

Figure 145 Graph of 25Ω 100 ps step generator with and without probe connected.

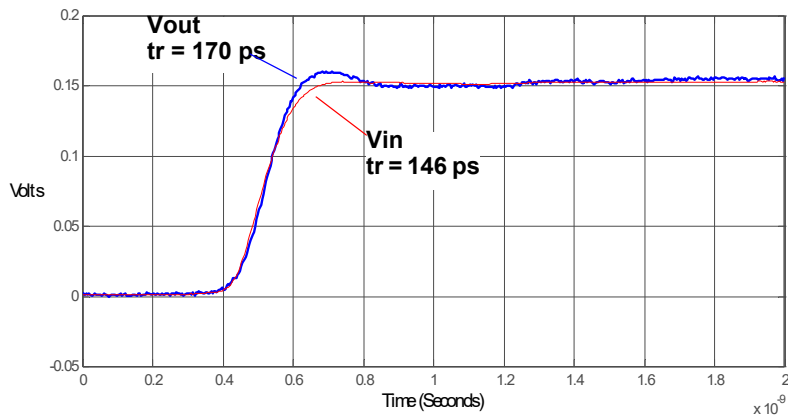

Figure 146 Graph of V_{in} and V_{out} of probe with a 25Ω 100 ps step generator.

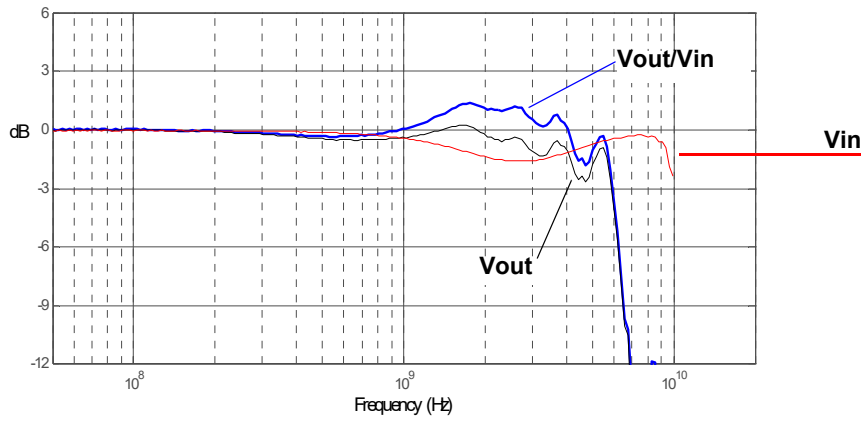

Figure 147 Graph of V_{in} and V_{out} of probe with a 25Ω source and V_{out}/V_{in} frequency response.

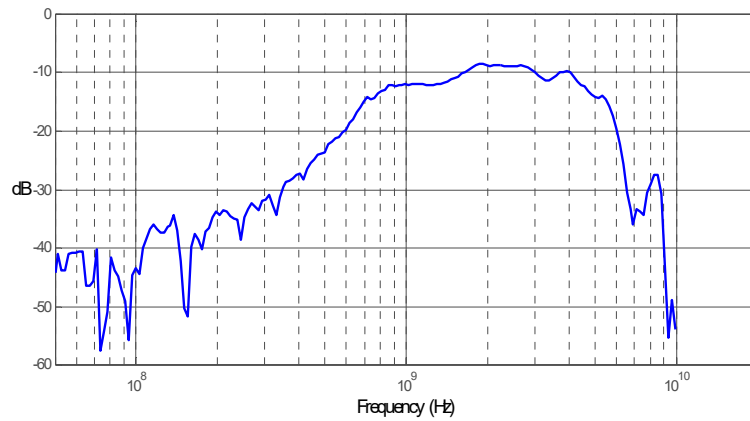

Figure 148 Graph of V_{out}/V_{in} frequency response when inputs driven in common (common mode rejection).

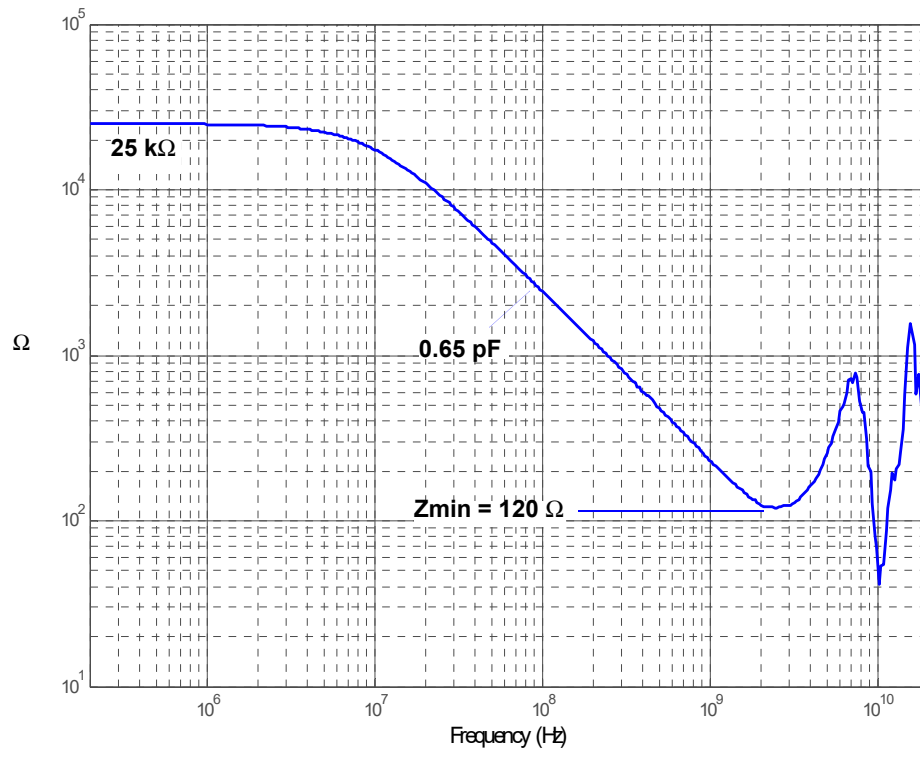

Figure 149 Magnitude plot of probe input impedance versus frequency.

E2677B Differential Solder-in Probe Head (Full BW)

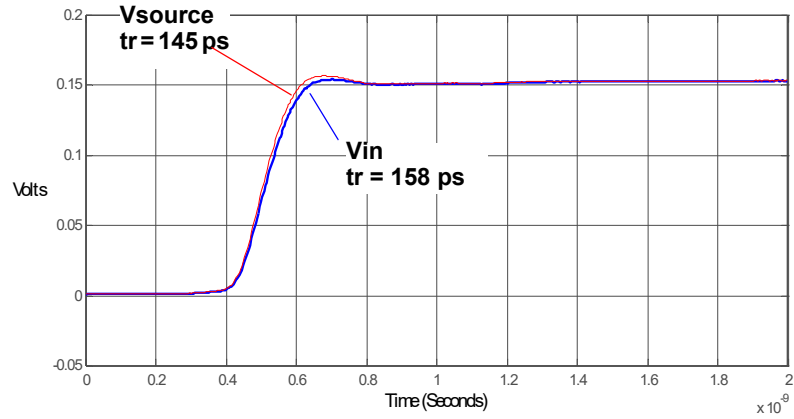

Figure 150 Graph of 25Ω 100 ps step generator with and without probe connected.

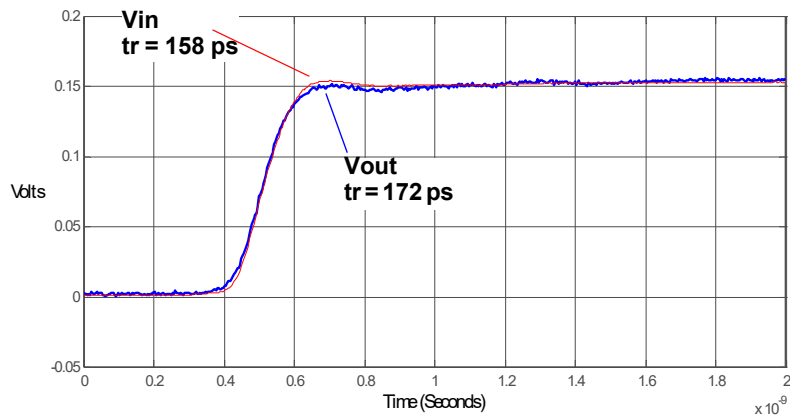

Figure 151 Graph of Vin and Vout of probe with a 25Ω 100 ps step generator.

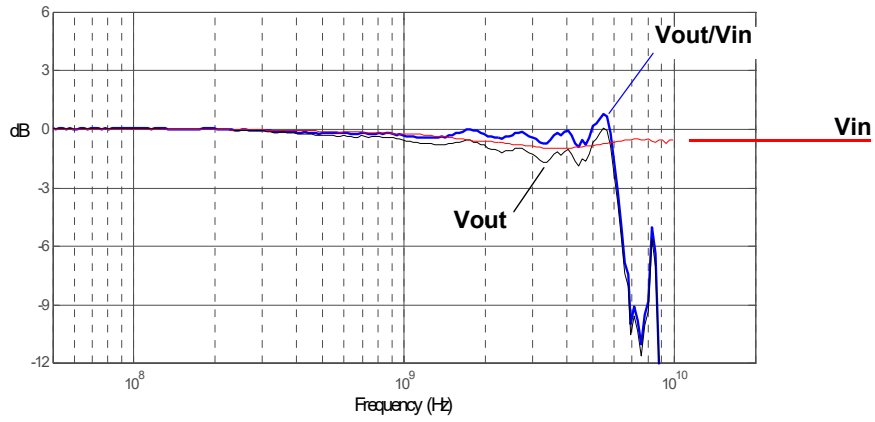

Figure 152 Graph of Vin and Vout of probe with a 25Ω source and Vout/Vin frequency response.

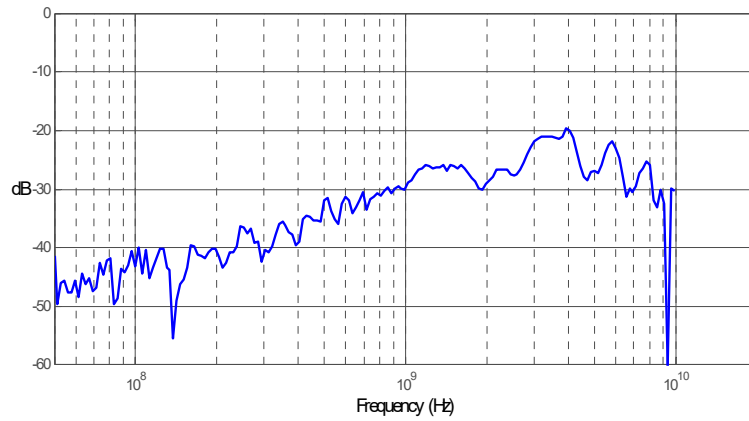

Figure 153 Graph of Vout/Vin frequency response when inputs driven in common (common mode rejection).

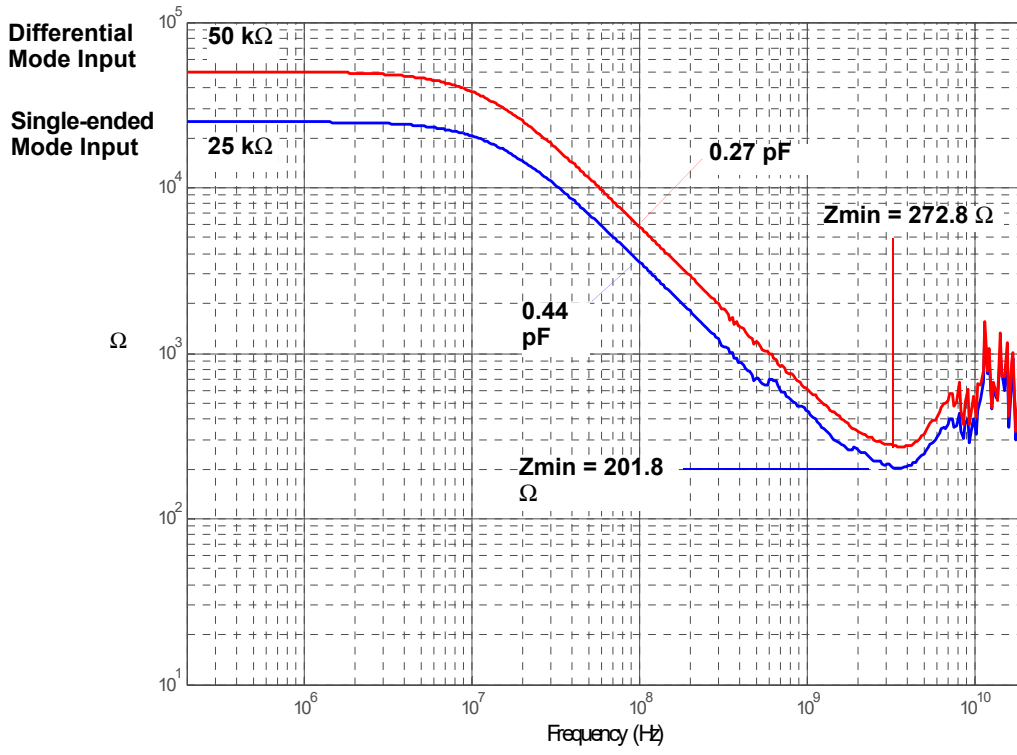

Figure 154 Magnitude plot of probe input impedance versus frequency.

E2677B Differential Solder-in Probe Head (Medium BW)

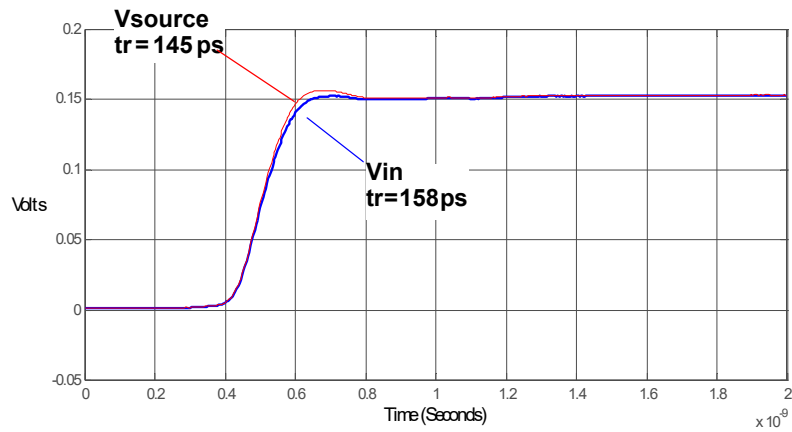

Figure 155 Graph of 25Ω 100 ps step generator with and without probe connected.

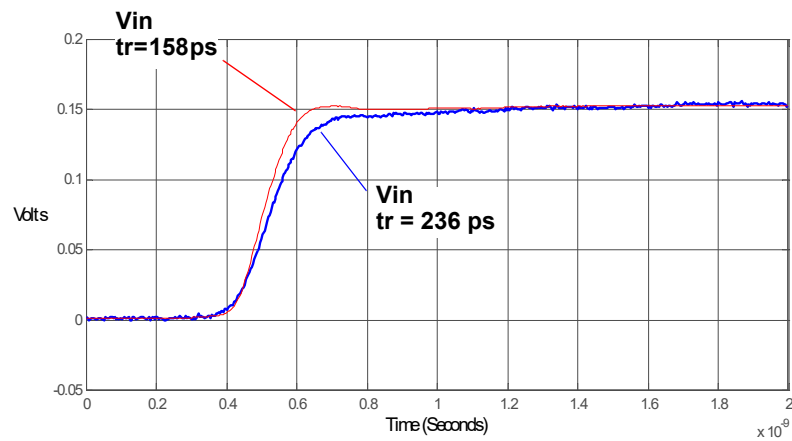

Figure 156 Graph of Vin and Vout of probe with a 25Ω 100 ps step generator.

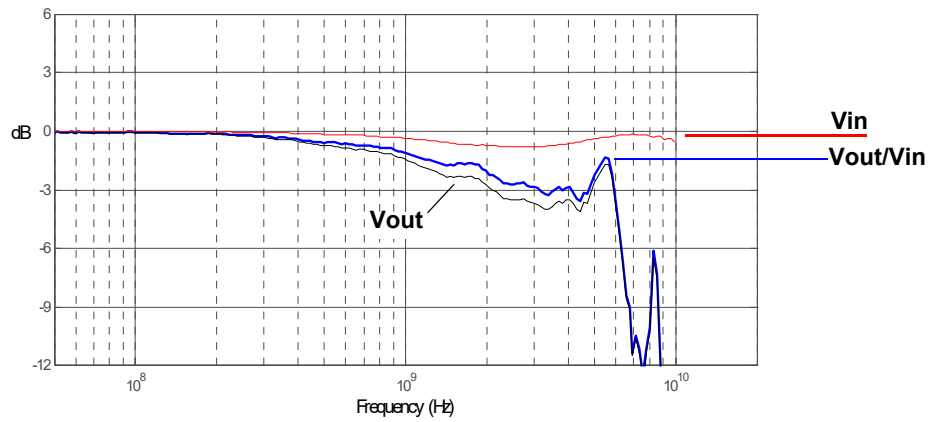

Figure 157 Graph of V_{in} and V_{out} of probe with a 25Ω source and V_{out}/V_{in} frequency response.

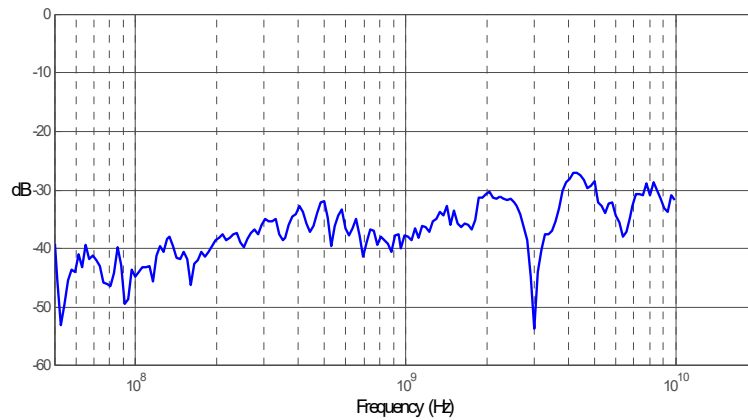

Figure 158 Graph of V_{out}/V_{in} frequency response when inputs driven in common (common mode rejection).

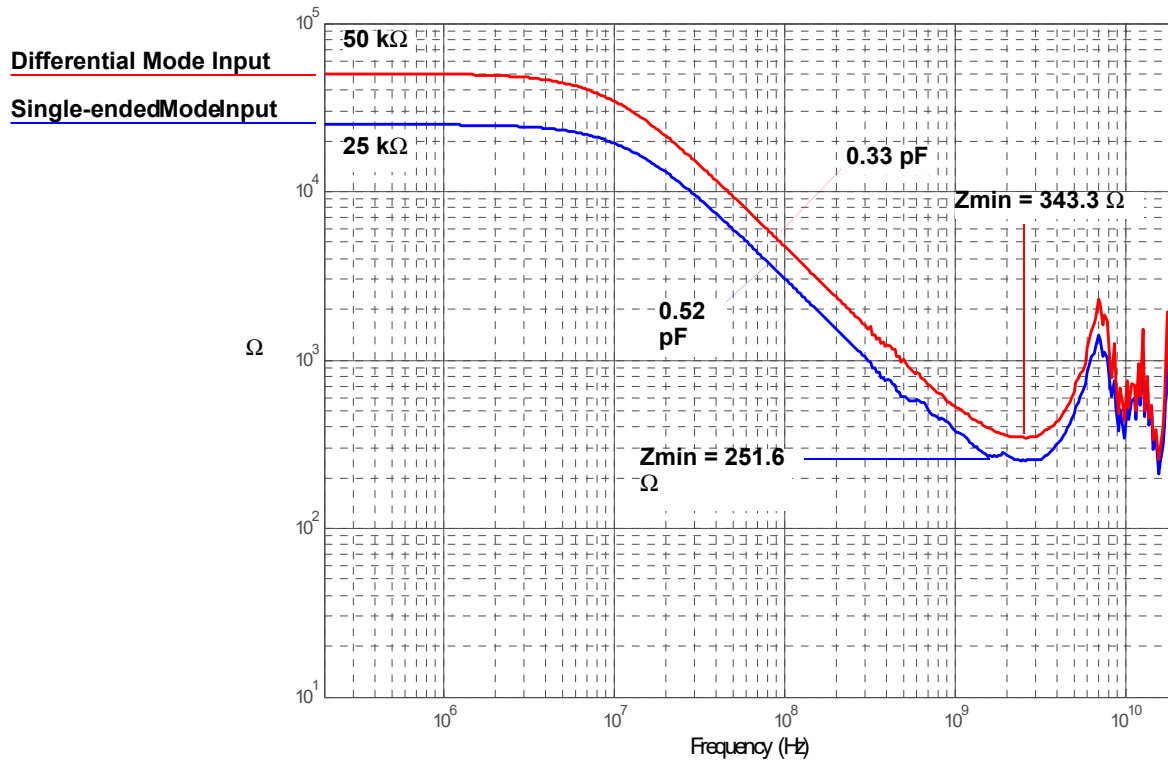

Figure 159 Magnitude plot of probe input impedance versus frequency.

E2678A/B Differential Socketed Probe Head (Full BW)

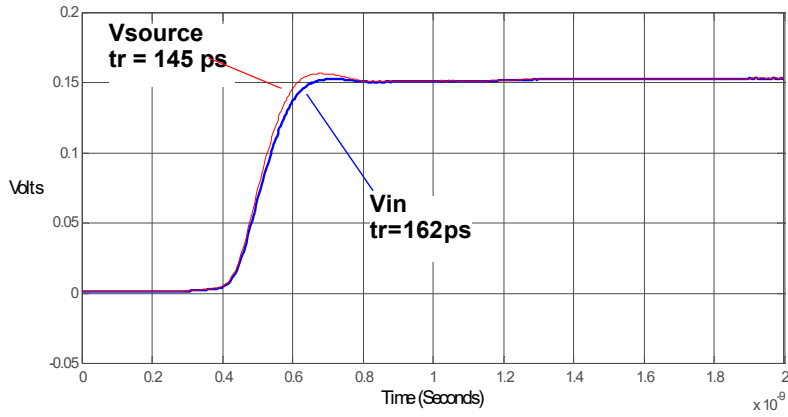

Figure 160 Graph of 25Ω 100 ps step generator with and without probe connected.

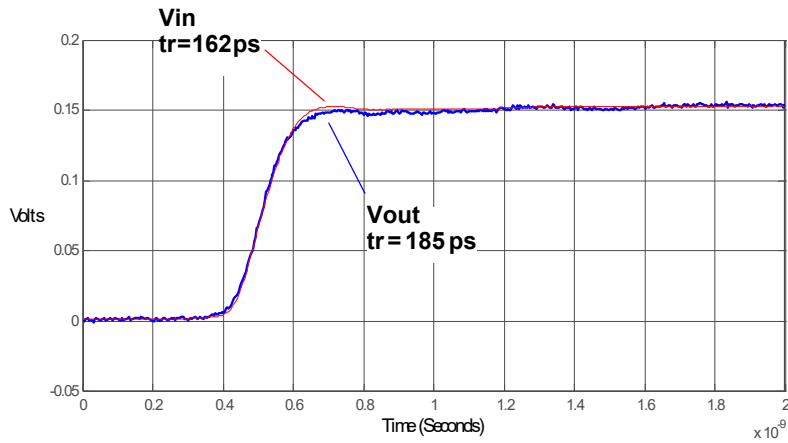

Figure 161 Graph of Vin and Vout of probe with a 25Ω 100 ps step generator.

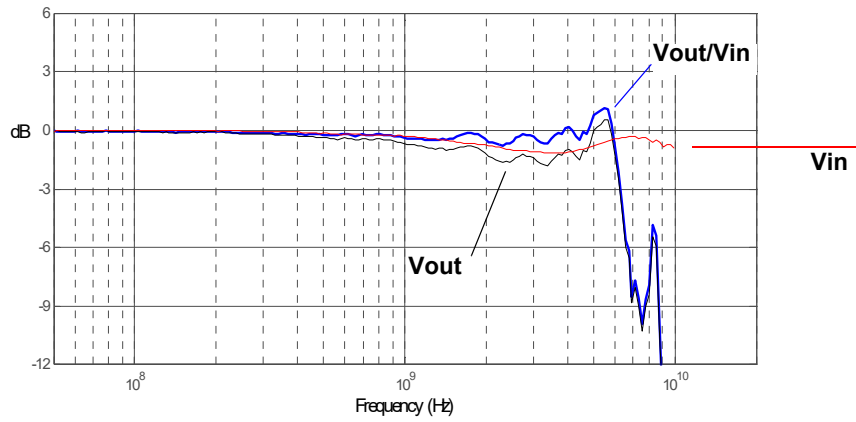

Figure 162 Graph of V_{in} and V_{out} of probe with a 25Ω source and V_{out}/V_{in} frequency response.

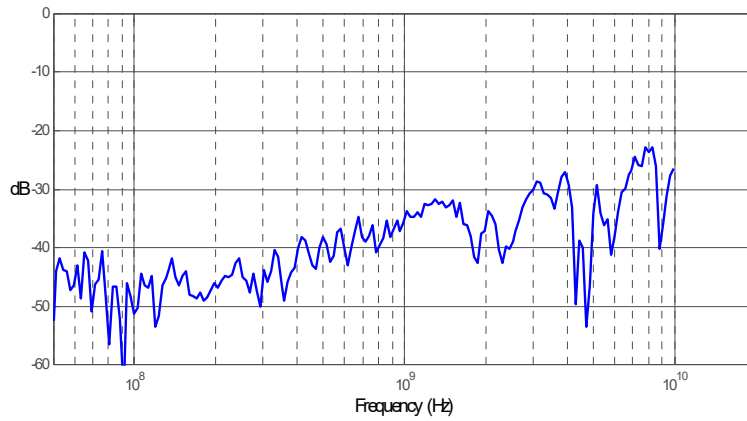

Figure 163 Graph of V_{out}/V_{in} frequency response when inputs driven in common (common mode rejection).

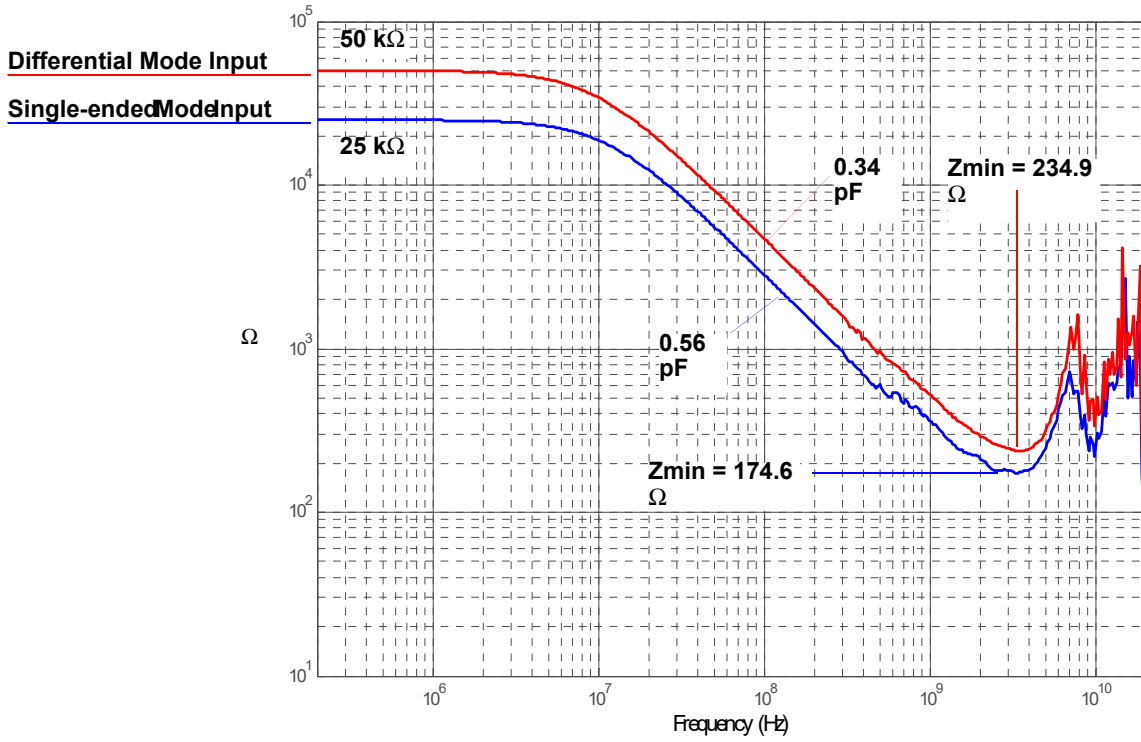

Figure 164 Magnitude plot of probe input impedance versus frequency.

E2678A/B Differential Socketed Probe Head with Damped Wire Accessory

NOTE

Due to reflections on the long wire accessories, signals being probed should be limited to approximately ≥ 240 ps rise time measured at the 10% and 90% amplitude levels. This is equivalent to approximately ≤ 1.5 GHz bandwidth.

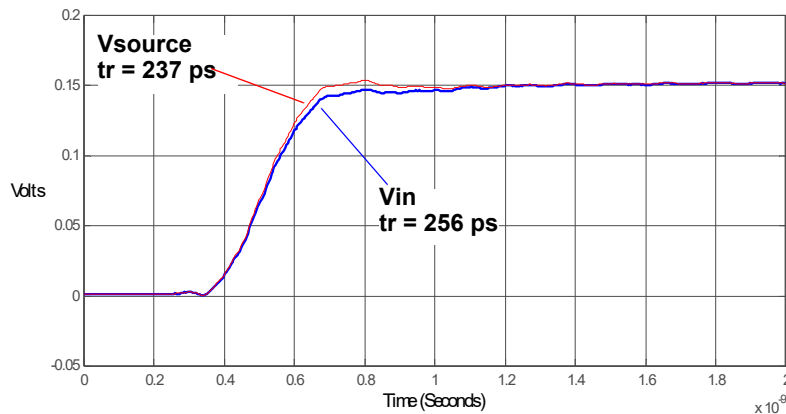

Figure 165 Graph of 25Ω 240 ps step generator with and without probe connected.

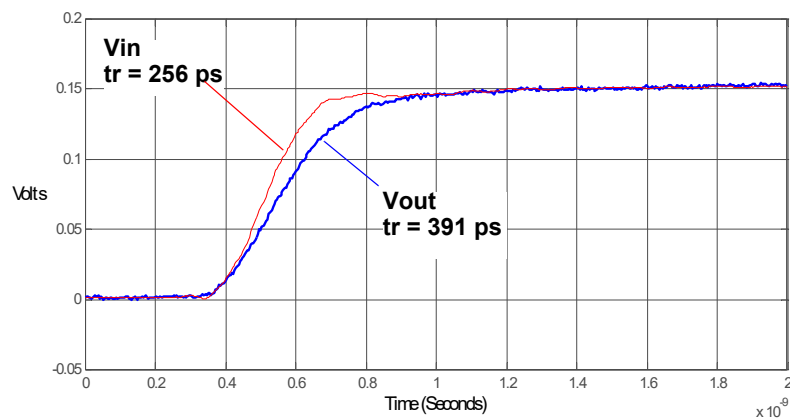

Figure 166 Graph of Vin and Vout of probe with a 25Ω 240 ps step generator.

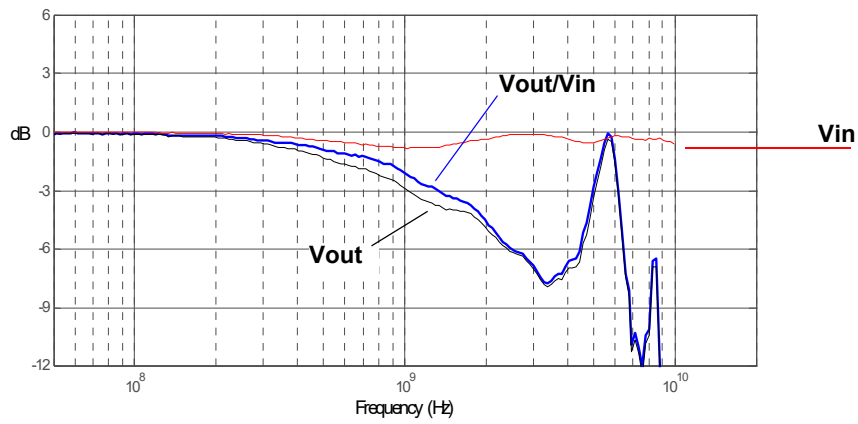

Figure 167 Graph of V_{in} and V_{out} of probe with a 25Ω source and V_{out}/V_{in} frequency response.

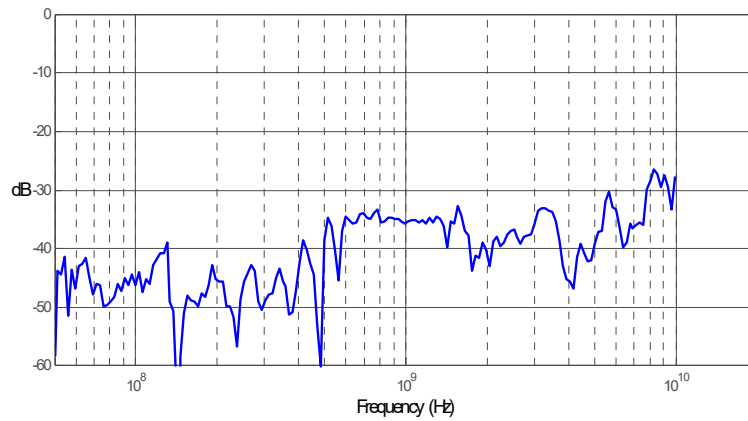

Figure 168 Graph of V_{out}/V_{in} frequency response when inputs driven in common (common mode rejection).

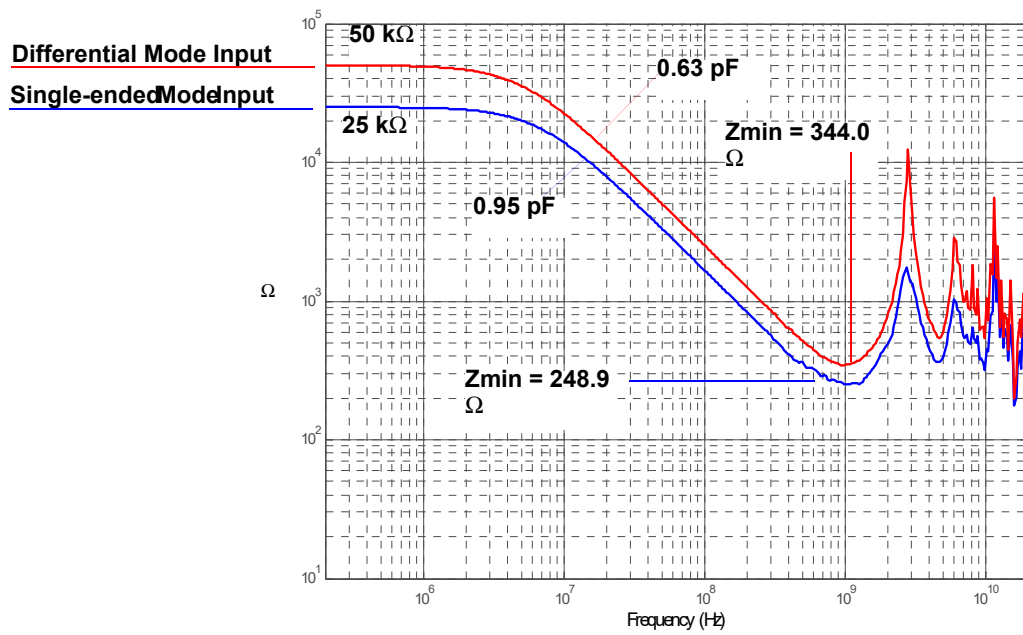

Figure 169 Magnitude plot of probe input impedance versus frequency.

E2679B Single-Ended Solder-in Probe Head (Full BW)

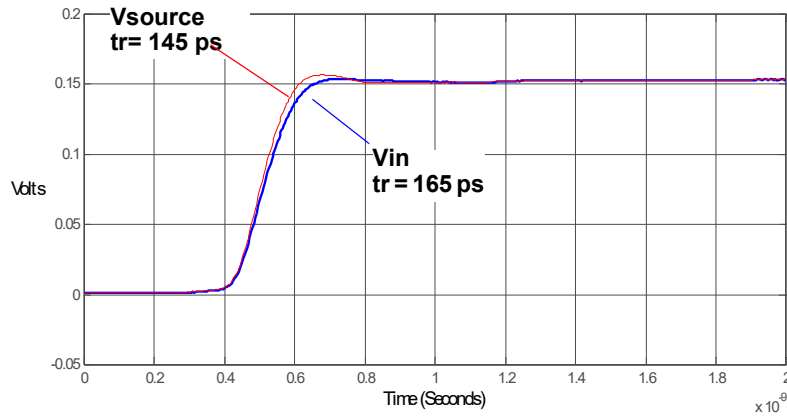

Figure 170 Graph of 25Ω 100 ps step generator with and without probe connected.

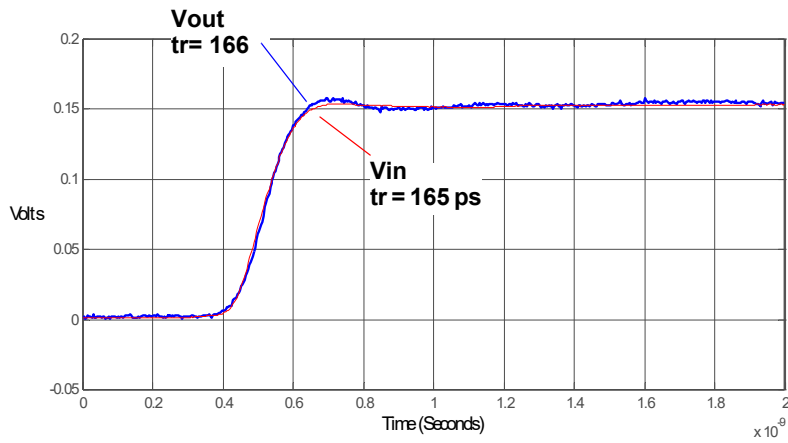

Figure 171 Graph of Vin and Vout of probe with a 25Ω 100 ps step generator.

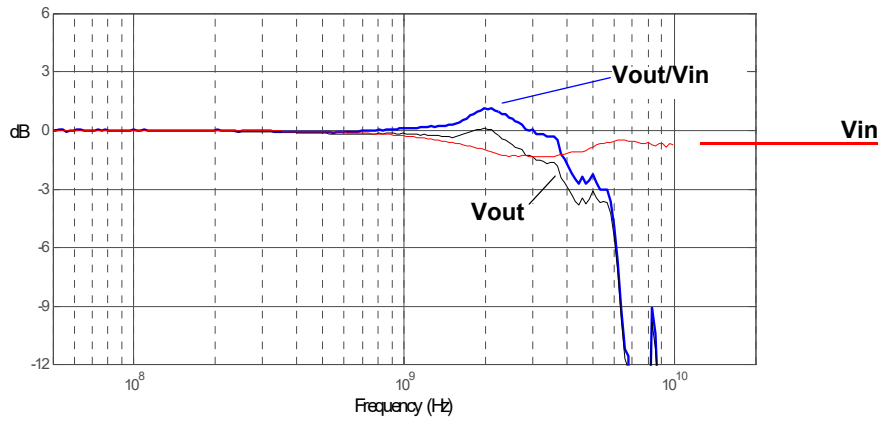

Figure 172 Graph of Vin and Vout of probe with a 25Ω source and Vout/Vin frequency response.

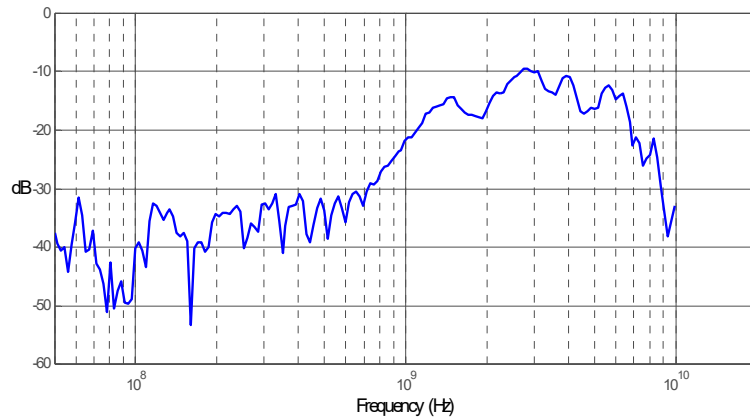

Figure 173 Graph of Vout/Vin frequency response when inputs driven in common (common mode rejection).

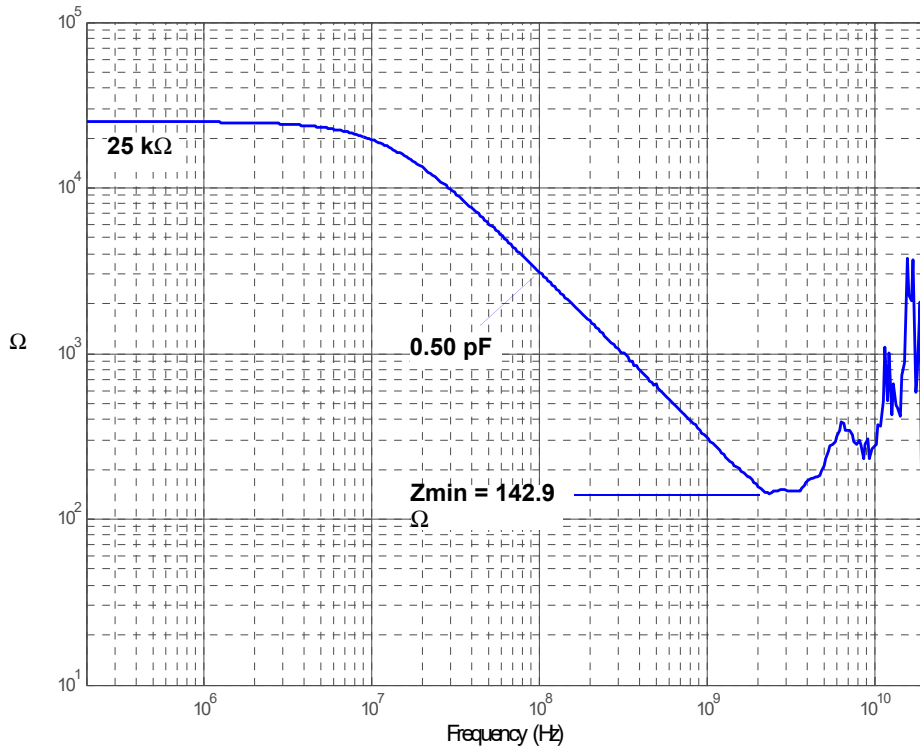

Figure 174 Magnitude plot of probe input impedance versus frequency.

E2679B Single-Ended Solder-in Probe Head (Medium BW)

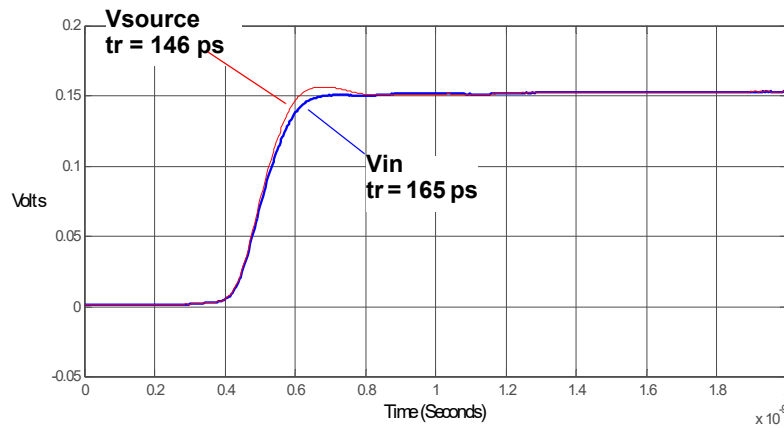

Figure 175 Graph of 25Ω 100 ps step generator with and without probe connected.

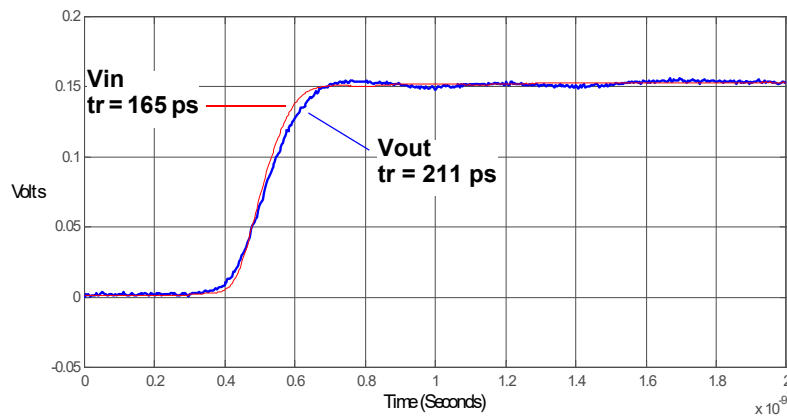

Figure 176 Graph of V_{in} and V_{out} of probe with a 25Ω 100 ps step generator.

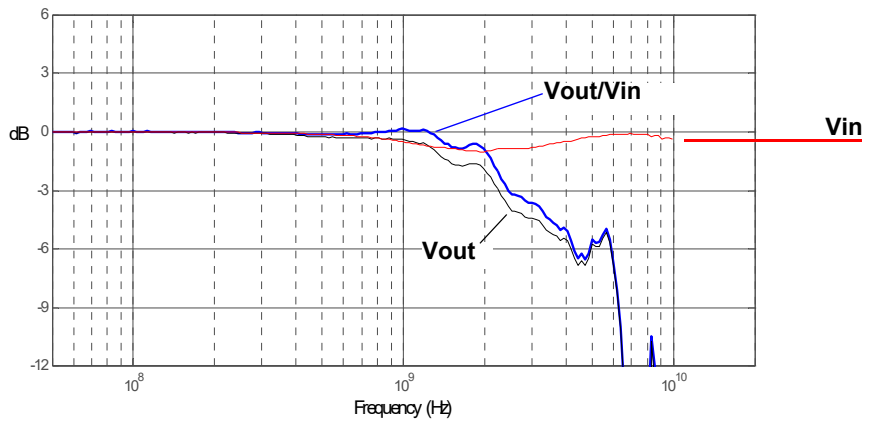

Figure 177 Graph of Vin and Vout of probe with a 25Ω source and Vout/Vin frequency response.

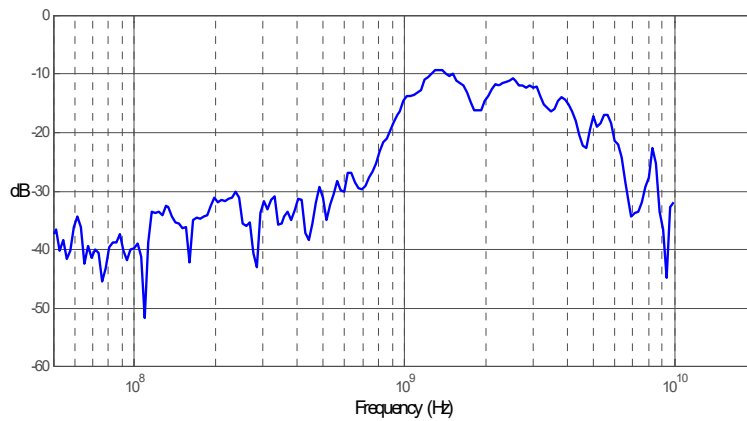

Figure 178 Graph of Vout/Vin frequency response when inputs driven in common (common mode rejection).

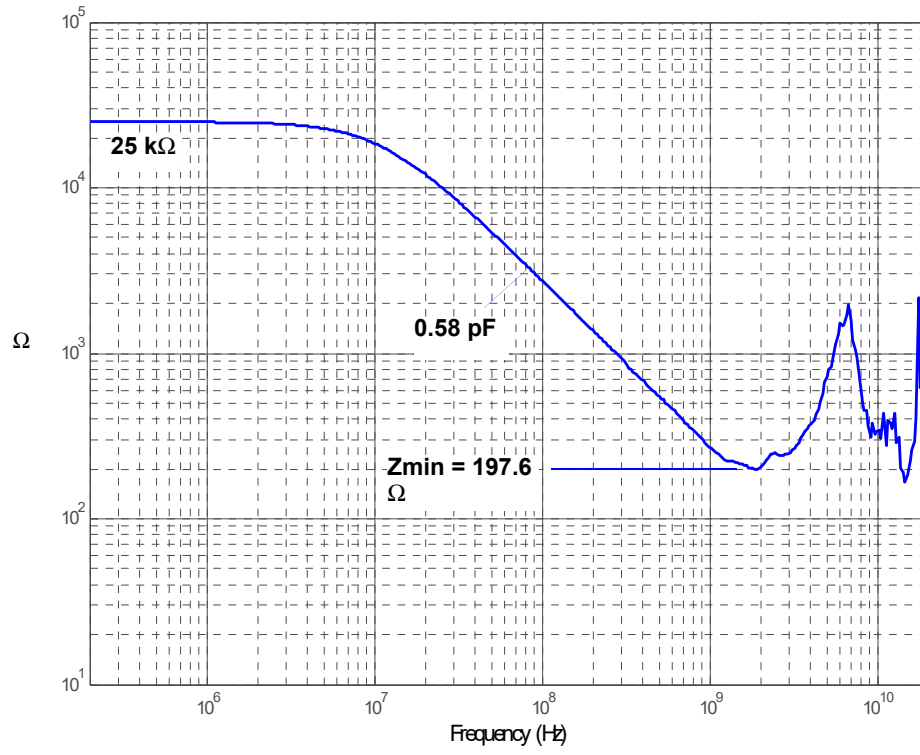

Figure 179 Magnitude plot of probe input impedance versus frequency.

N2851A QuickTip Head with N2849A QuickTip

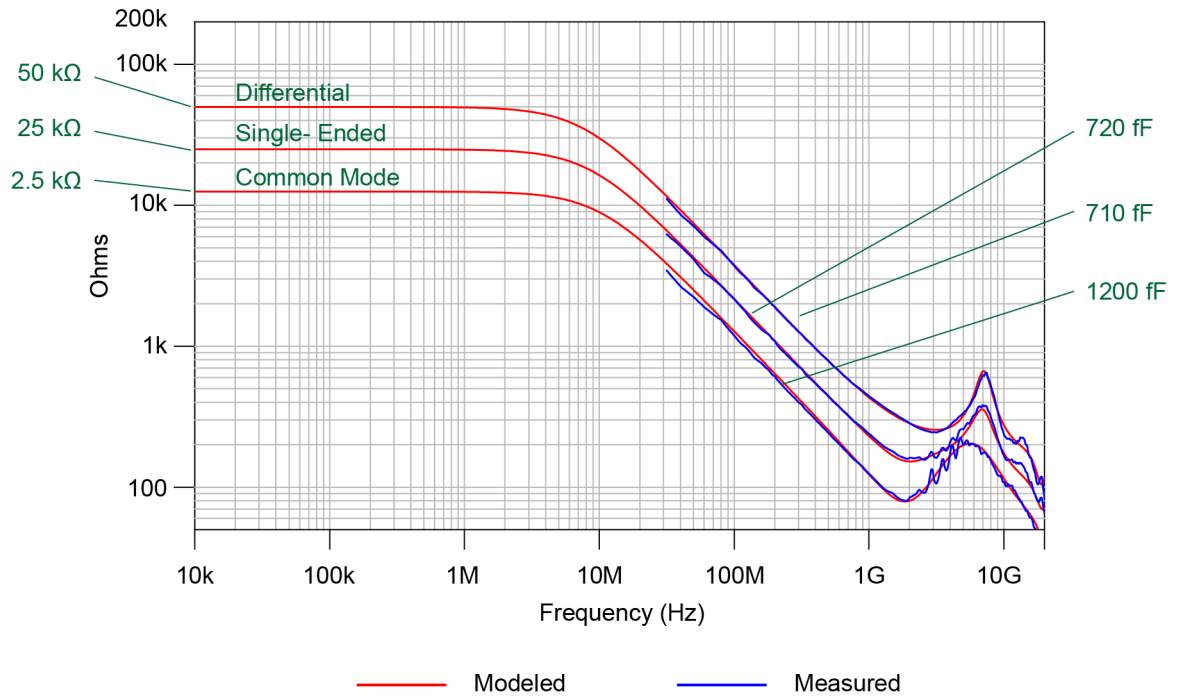

Figure 180 Input Impedances (Modeled and Measured)

8 1134B Performance Data Plots

E2675B Differential Browser	180
E2676B Single-Ended Browser	183
E2677B Differential Solder-in Probe Head (Full BW)	186
E2677B Differential Solder-in Probe Head (Medium BW)	189
E2678A/B Differential Socketed Probe Head (Full BW)	192
E2678A/B Differential Socketed Probe Head with Damped Wire Accessory	195
E2679B Single-Ended Solder-in Probe Head (Full BW)	198
E2679B Single-Ended Solder-in Probe Head (Medium BW)	201
N5380B SMA Probe Head	204
N2851A QuickTip Head with N2849A QuickTip	206

This chapter provides graphs of the performance characteristics of the 1134B probes using the different probe heads that come with the E2668B single-ended and E2669B differential connectivity kits.

NOTE

All rise times shown are measured from the 10% to the 90% amplitude levels.

E2675B Differential Browser

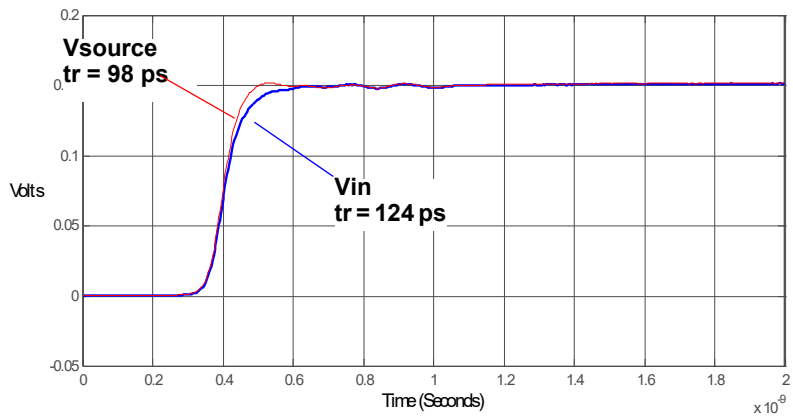

Figure 181 Graph of 25Ω 100 ps step generator with and without probe connected.

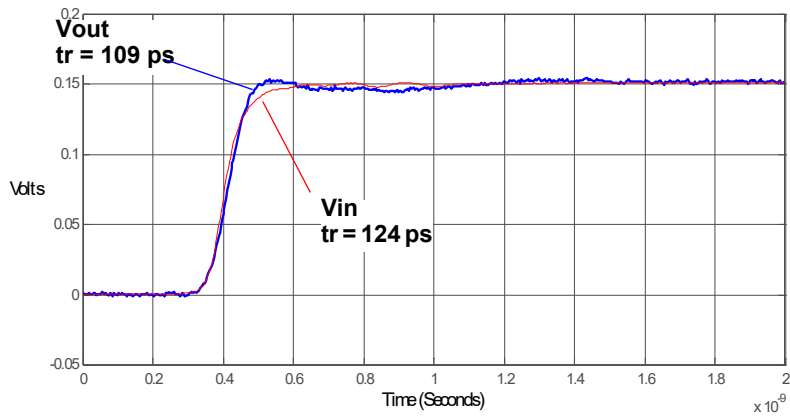

Figure 182 Graph of Vin and Vout of probe with a 25Ω 100 ps step generator.

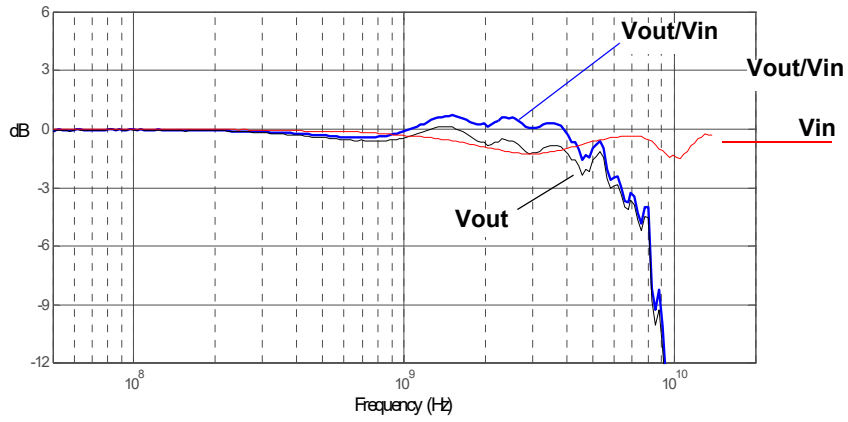

Figure 183 Graph of V_{in} and V_{out} of probe with a 25Ω source and V_{out}/V_{in} frequency response.

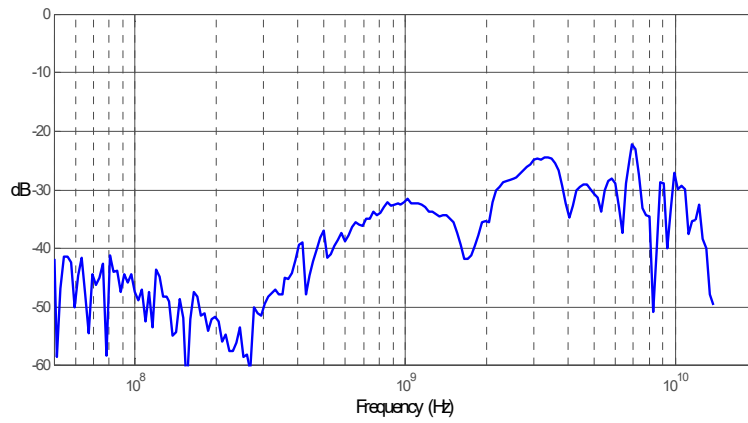

Figure 184 Graph of V_{out}/V_{in} frequency response when inputs driven in common (common mode rejection).

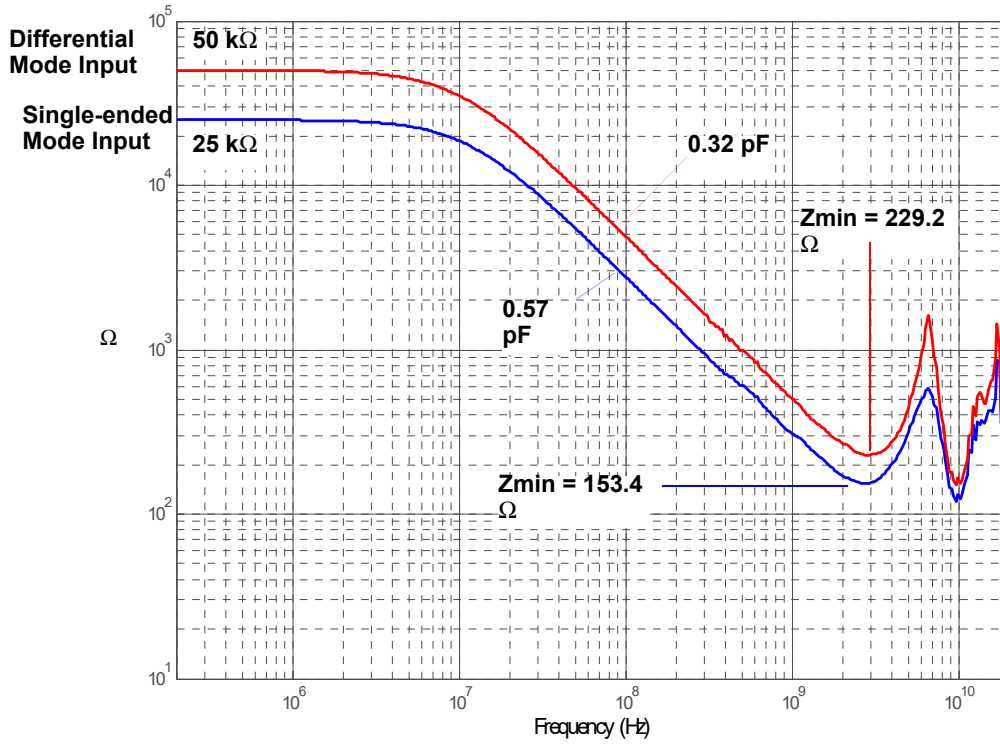

Figure 185 Magnitude plot of probe input impedance versus frequency.

E2676B Single-Ended Browser

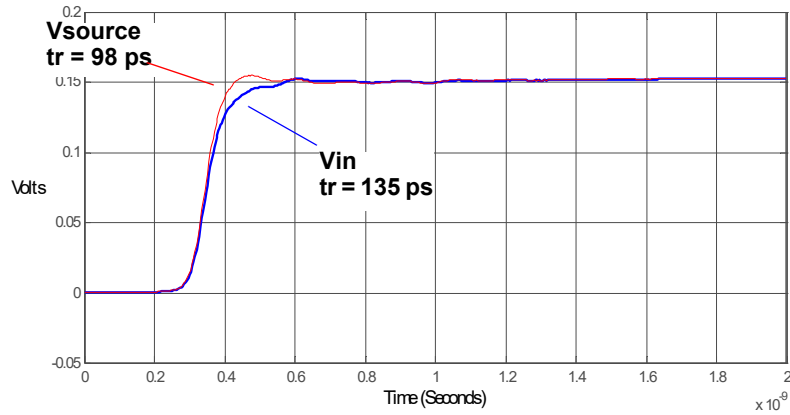

Figure 186 Graph of 25Ω 100 ps step generator with and without probe connected.

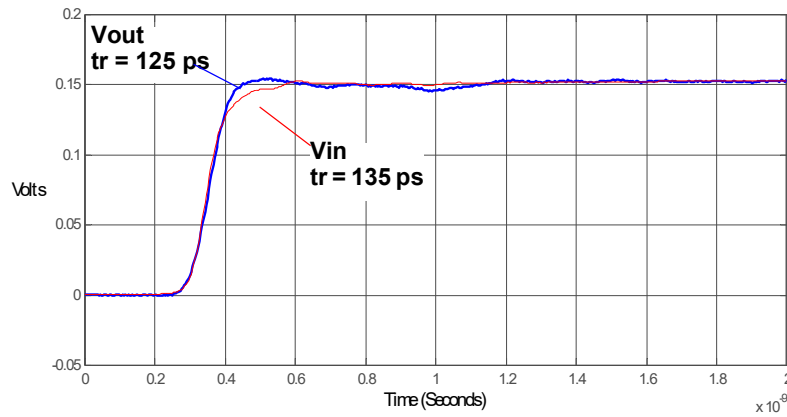

Figure 187 Graph of Vin and Vout of probe with a 25Ω 100 ps step generator.

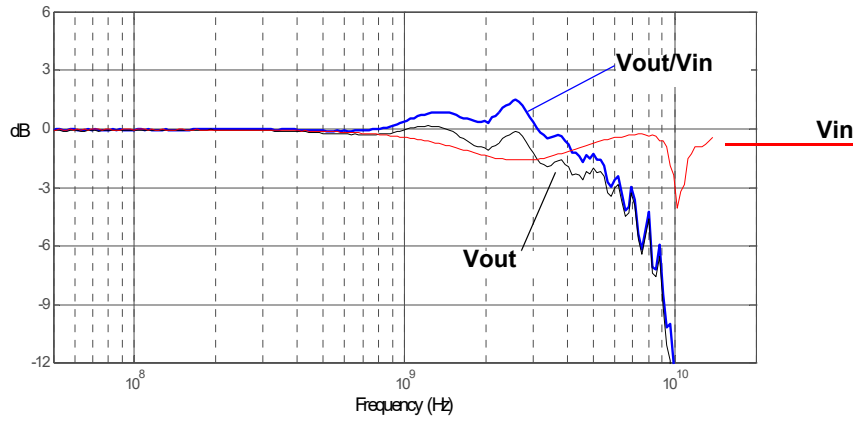

Figure 188 Graph of V_{in} and V_{out} of probe with a 25Ω source and V_{out}/V_{in} frequency response.

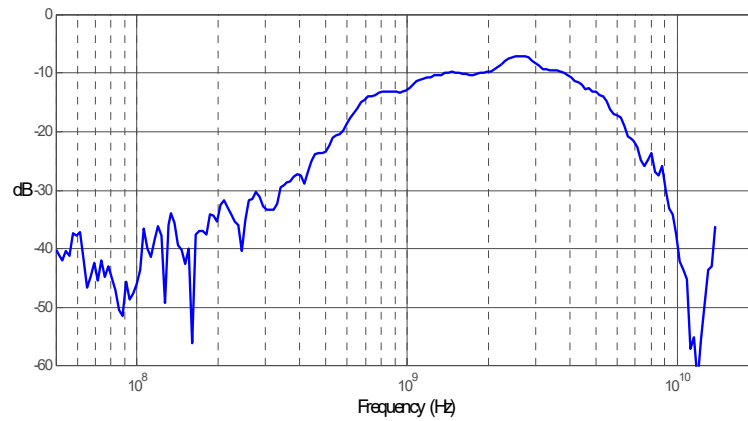

Figure 189 Graph of V_{out}/V_{in} frequency response when inputs driven in common (common mode rejection).

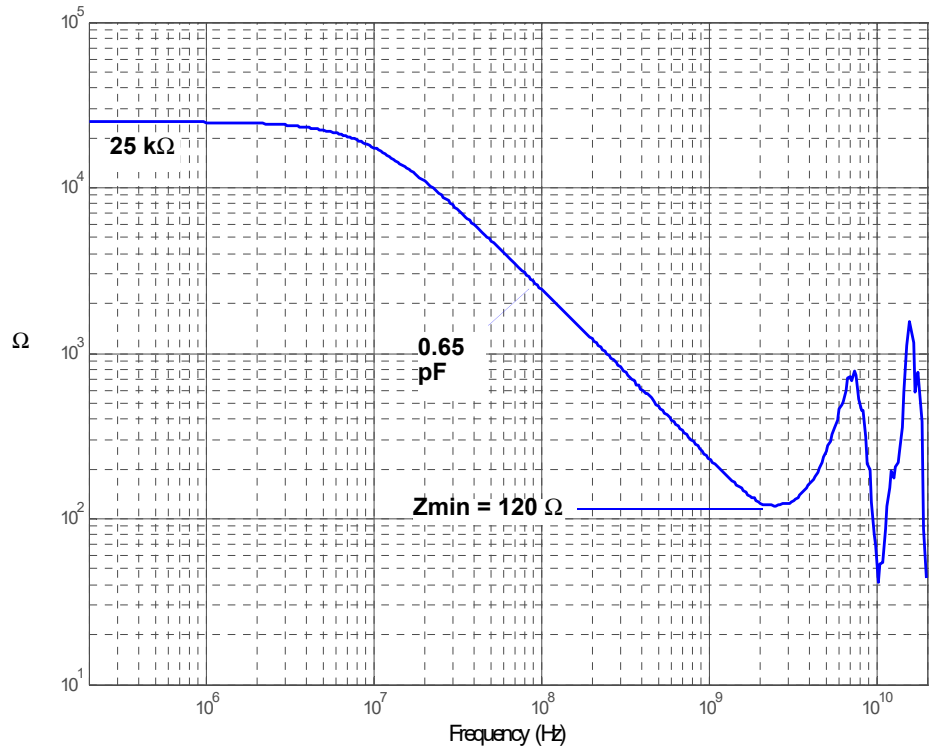

Figure 190 Magnitude plot of probe input impedance versus frequency.

E2677B Differential Solder-in Probe Head (Full BW)

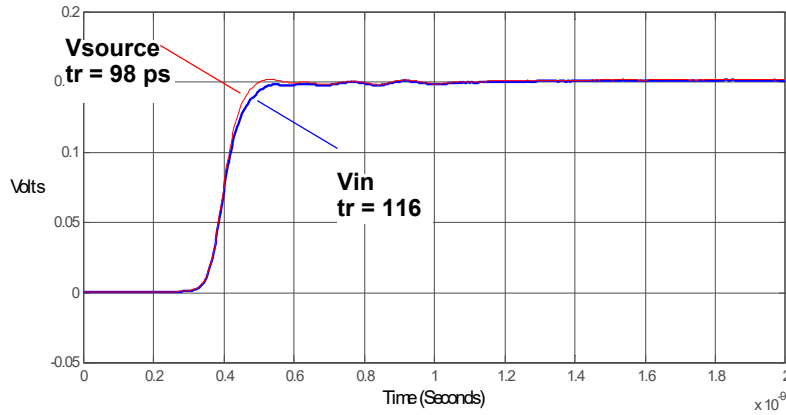

Figure 191 Graph of 25Ω 100 ps step generator with and without probe connected

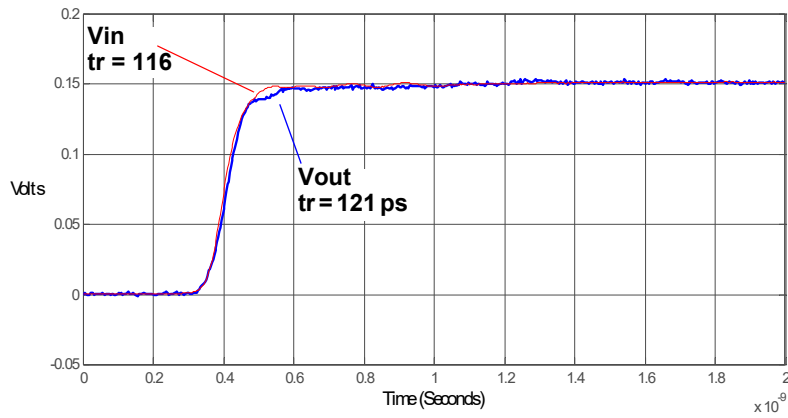

Figure 192 Graph of Vin and Vout of probe with a 25Ω 100 ps step generator.

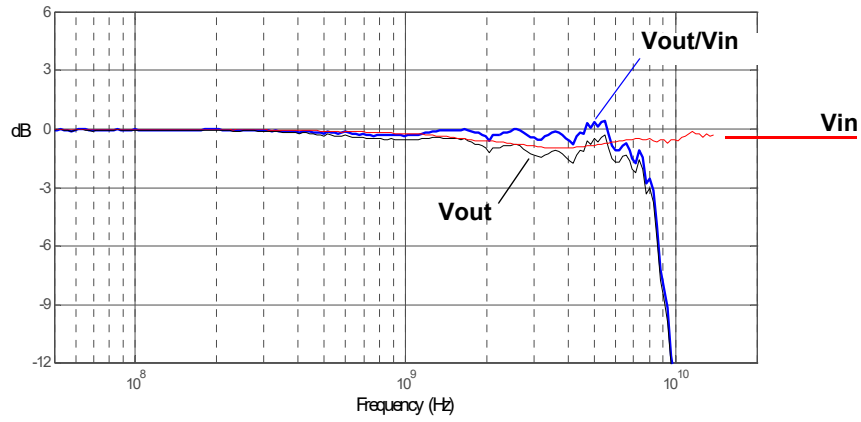

Figure 193 Graph of V_{in} and V_{out} of probe with a 25Ω source and V_{out}/V_{in} frequency response.

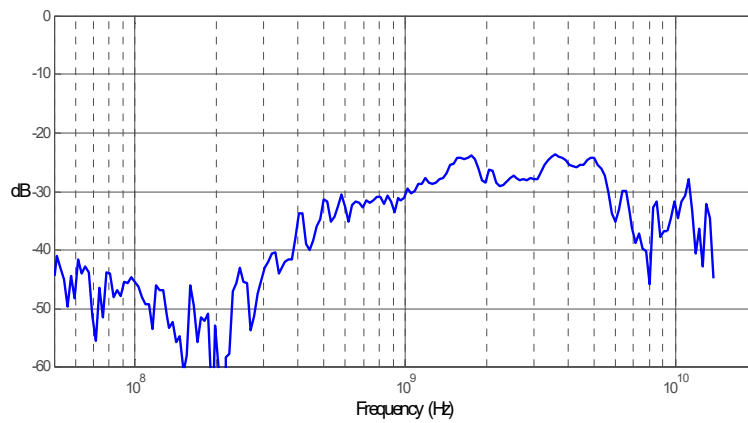

Figure 194 Graph of V_{out}/V_{in} frequency response when inputs driven in common (common mode rejection).

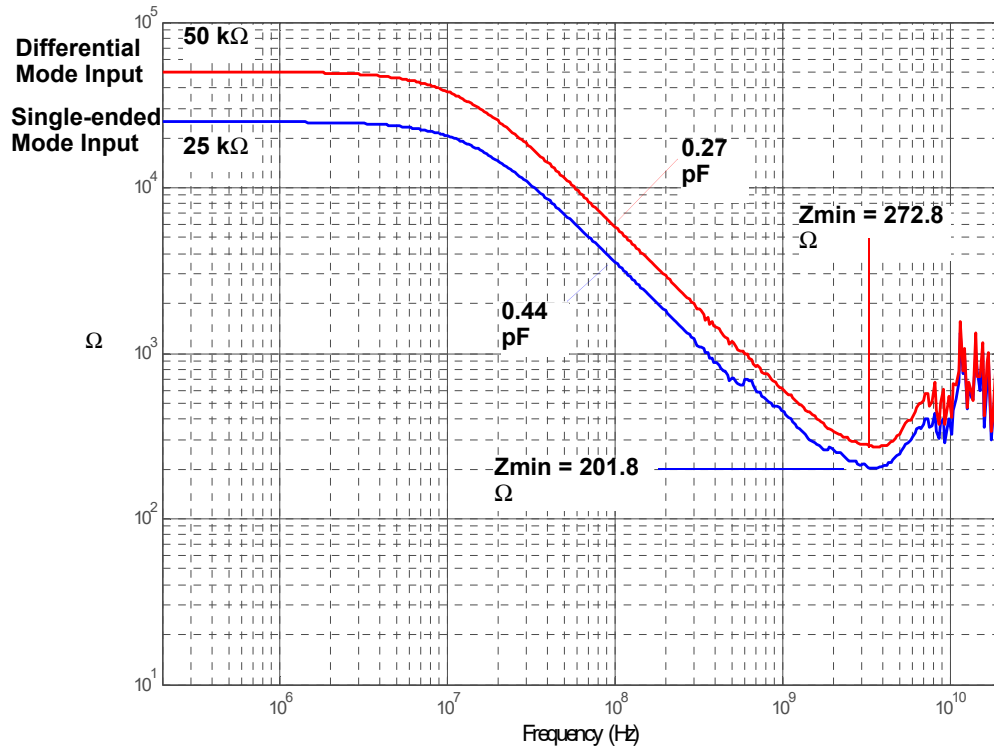

Figure 195 Magnitude plot of probe input impedance versus frequency.

E2677B Differential Solder-in Probe Head (Medium BW)

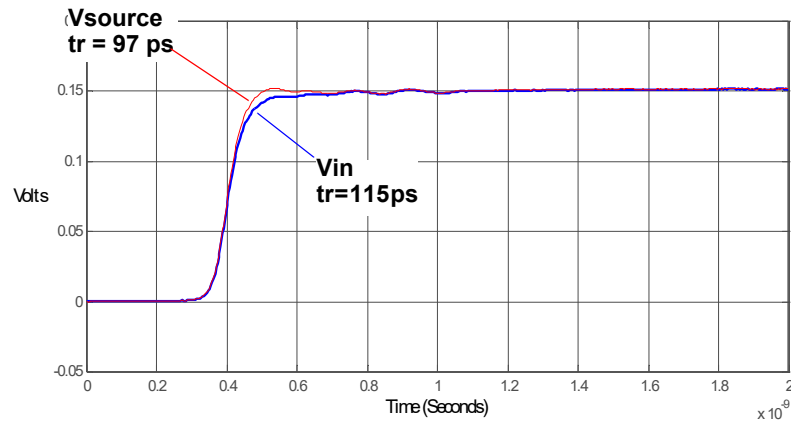

Figure 196 Graph of 25Ω 100 ps step generator with and without probe connected.

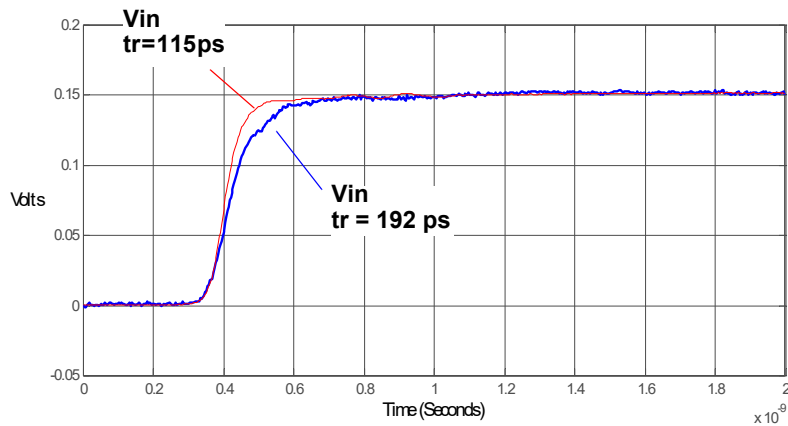

Figure 197 Graph of Vin and Vout of probe with a 25Ω 100 ps step generator.

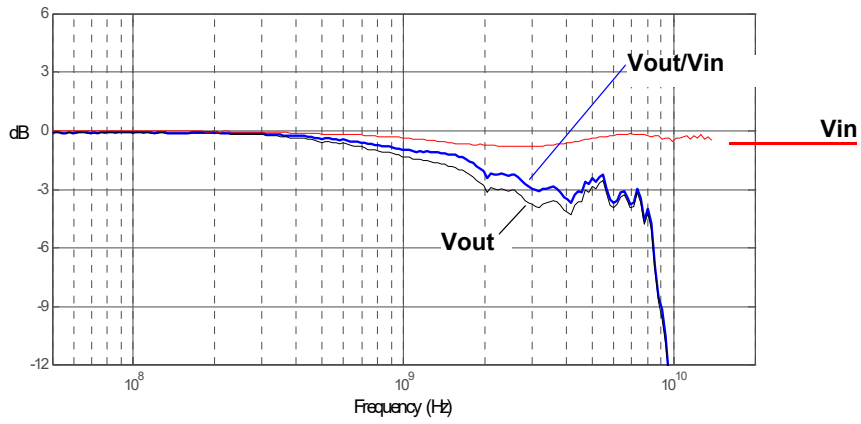

Figure 198 Graph of Vin and Vout of probe with a 25Ω source and Vout/Vin frequency response.

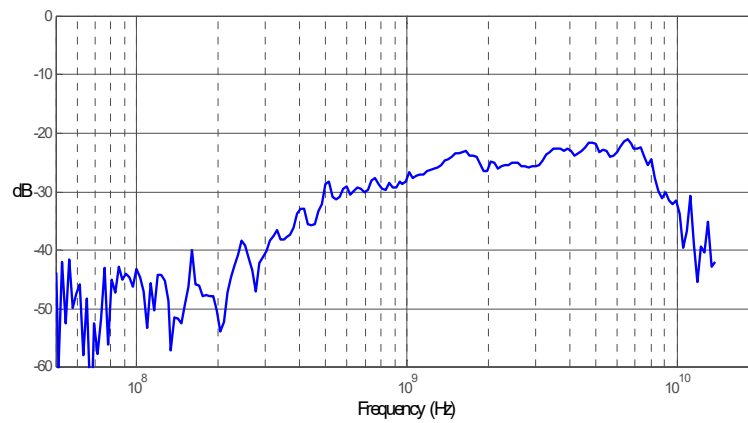

Figure 199 Graph of Vout/Vin frequency response when inputs driven in common (common mode rejection).

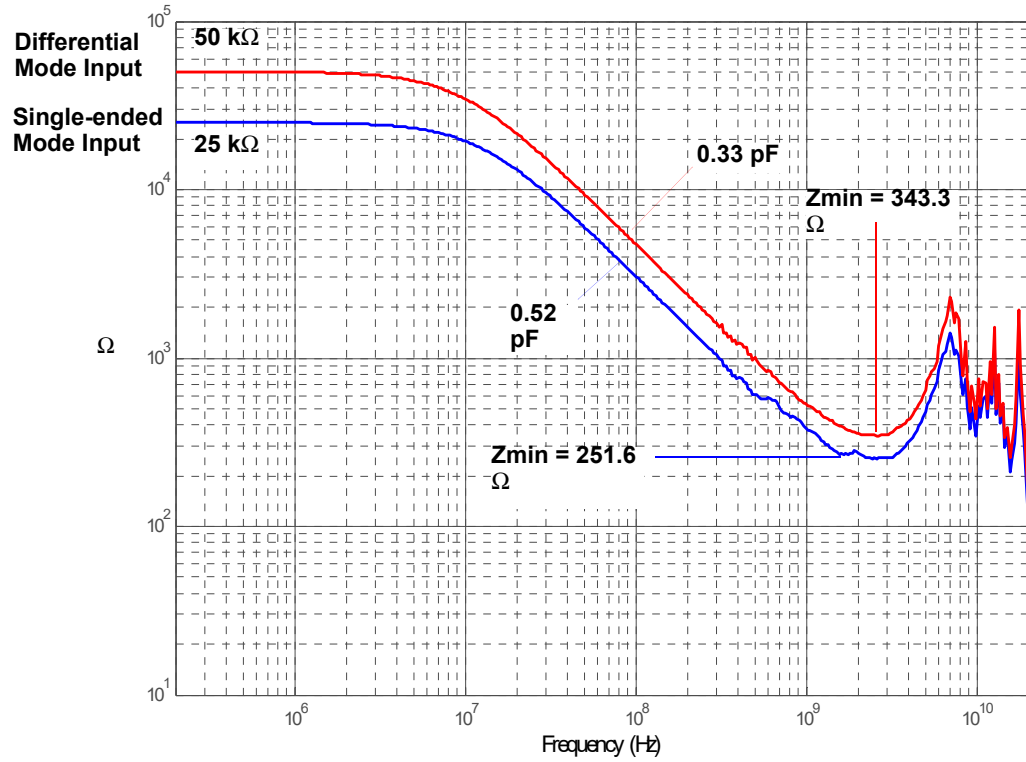

Figure 200 Magnitude plot of probe input impedance versus frequency.

E2678A/B Differential Socketed Probe Head (Full BW)

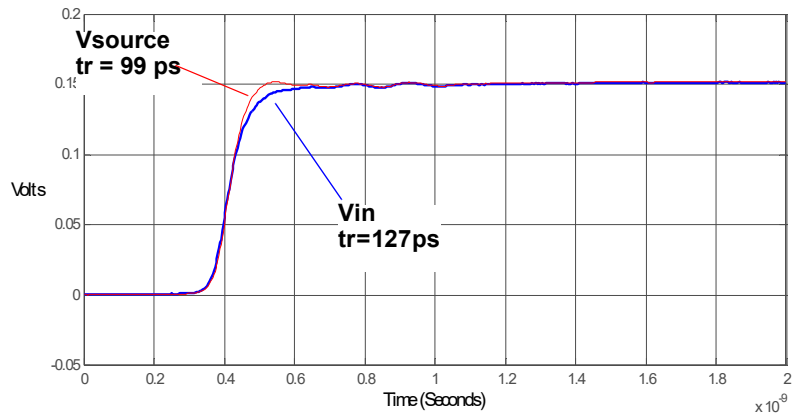

Figure 201 Graph of 25Ω 100 ps step generator with and without probe connected.

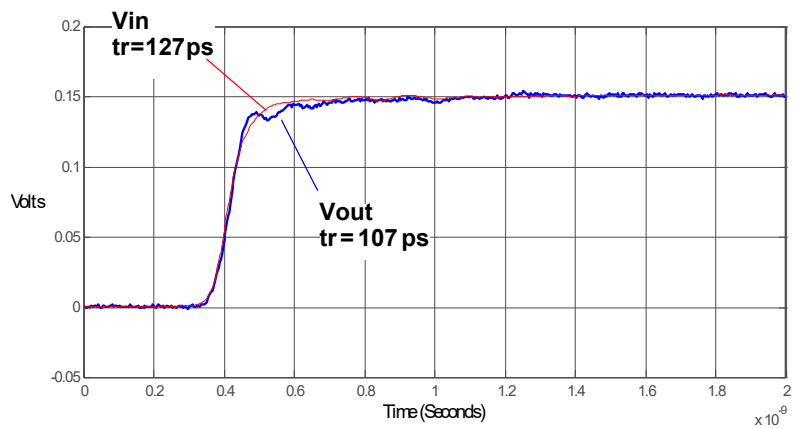

Figure 202 Graph of Vin and Vout of probe with a 25Ω 100 ps step generator.

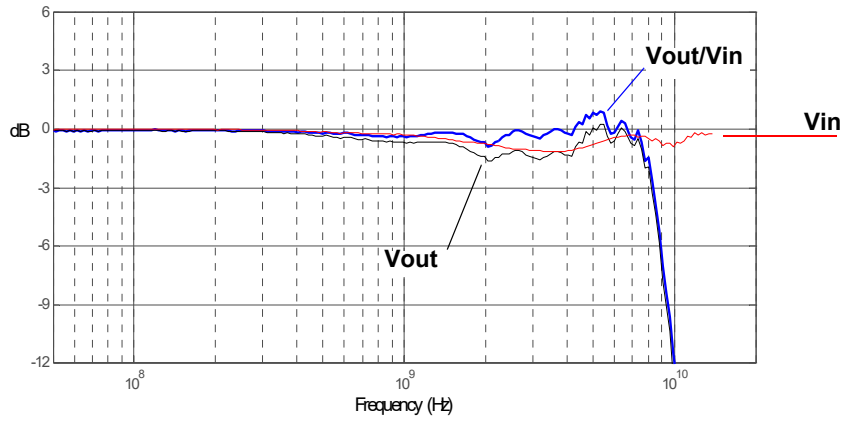

Figure 203 Graph of V_{in} and V_{out} of probe with a 25Ω source and V_{out}/V_{in} frequency response.

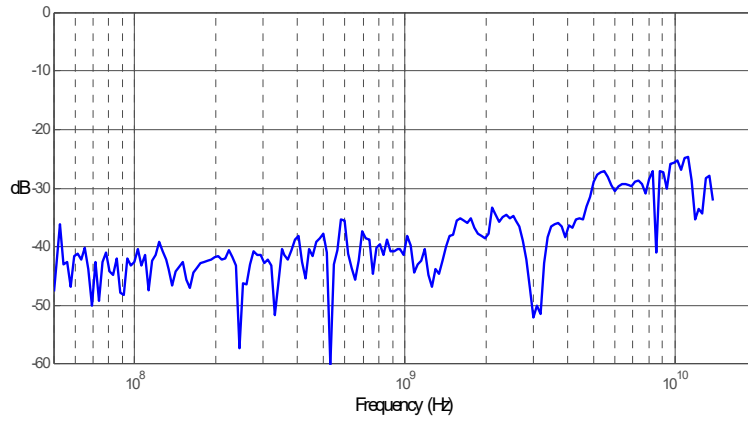

Figure 204 Graph of V_{out}/V_{in} frequency response when inputs driven in common (common mode rejection).

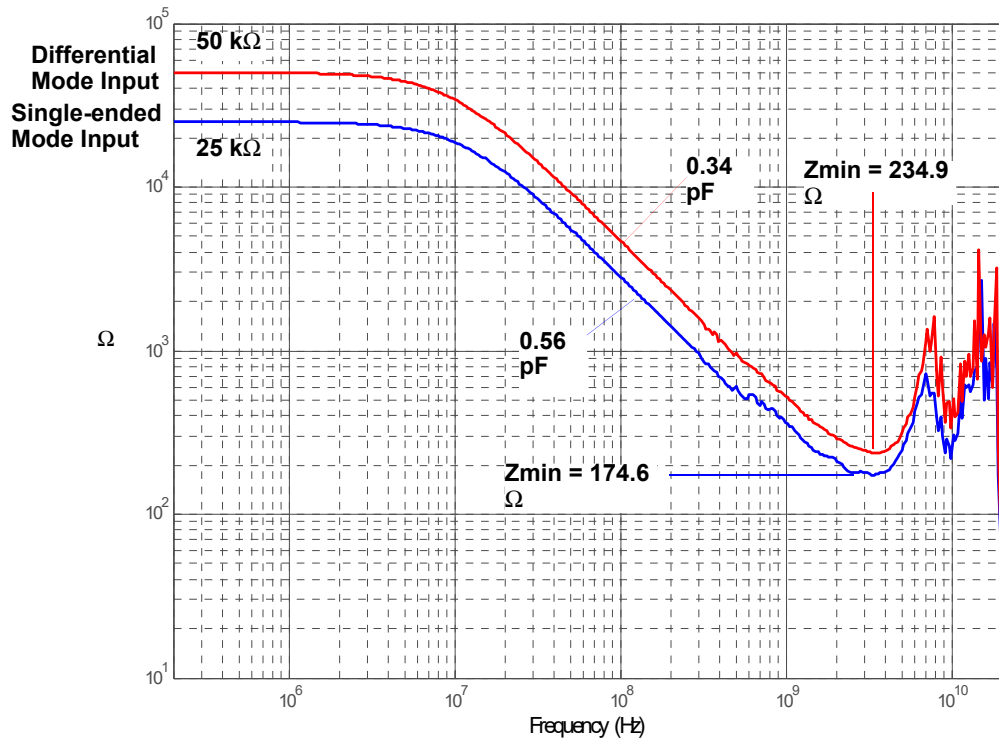

Figure 205 Magnitude plot of probe input impedance versus frequency.

E2678A/B Differential Socketed Probe Head with Damped Wire Accessory

NOTE

Due to reflections on the long wire accessories, signals being probed should be limited to approximately ≥ 240 ps rise time measured at the 10% and 90% amplitude levels. This is equivalent to approximately ≤ 1.5 GHz bandwidth.

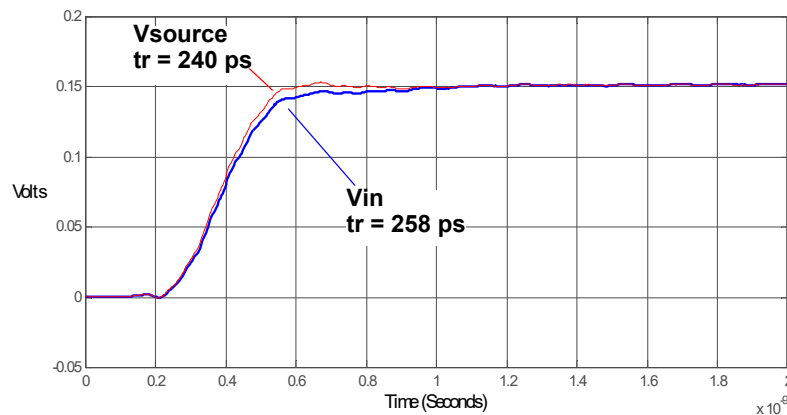

Figure 206 Graph of 25Ω 240 ps step generator with and without probe connected.

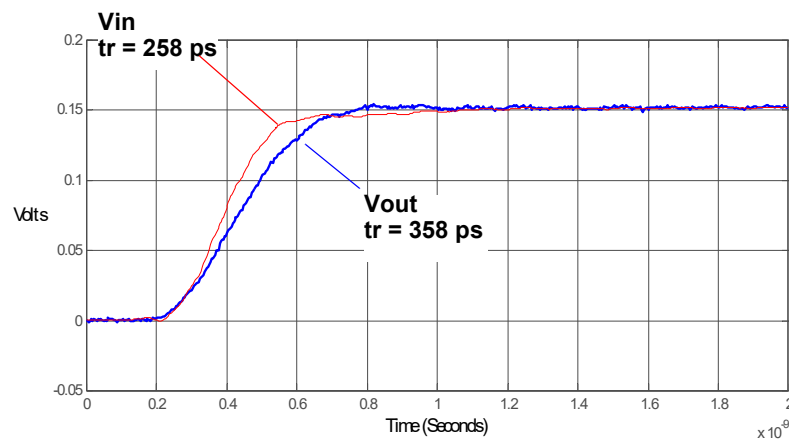

Figure 207 Graph of Vin and Vout of probe with a 25Ω 240 ps step generator.

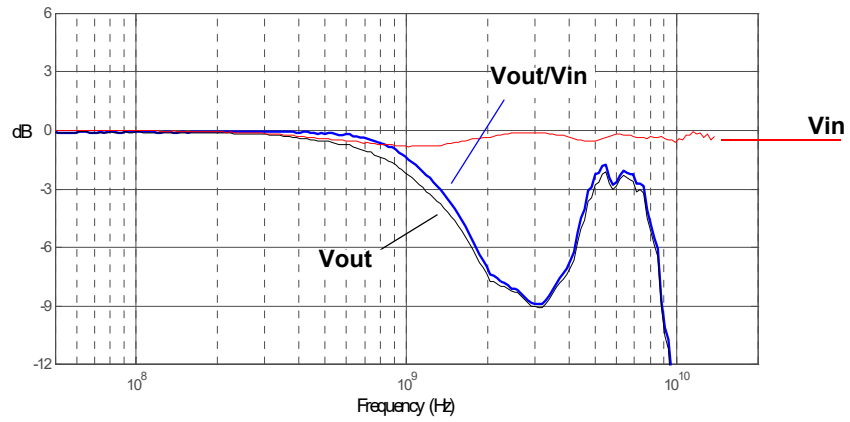

Figure 208 Graph of Vin and Vout of probe with a 25Ω source and Vout/Vin frequency response.

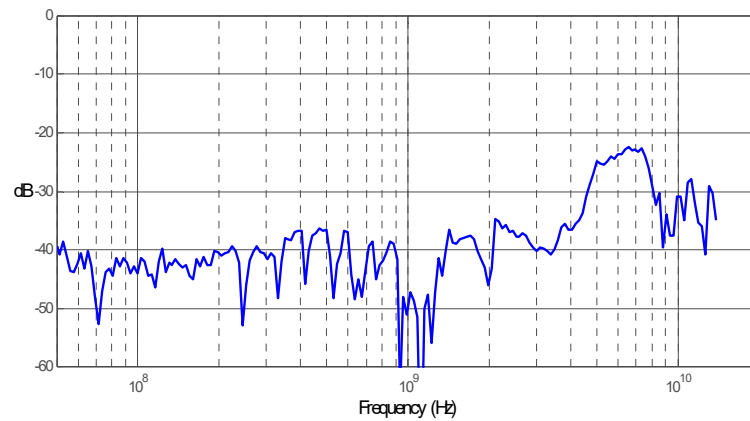

Figure 209 Graph of Vout/Vin frequency response when inputs driven in common (common mode rejection).

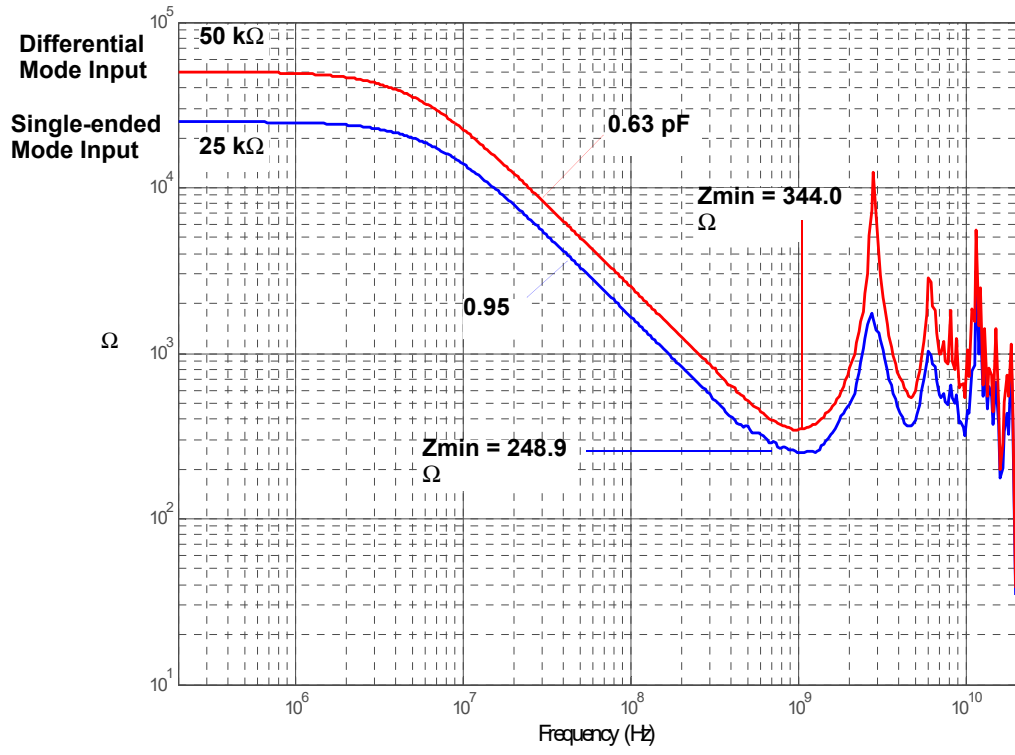

Figure 210 Magnitude plot of probe input impedance versus frequency.

E2679B Single-Ended Solder-in Probe Head (Full BW)

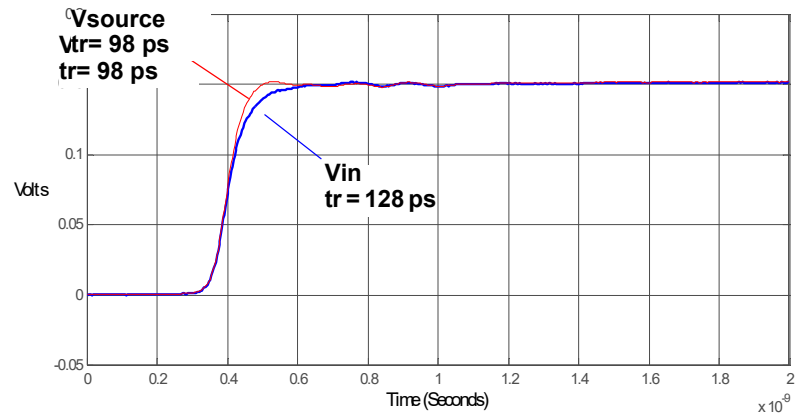

Figure 211 Graph of 25Ω 100 ps step generator with and without probe connected.

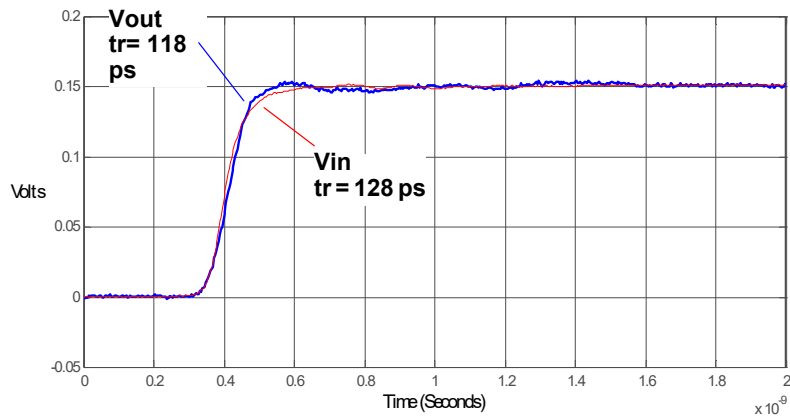

Figure 212 Graph of Vin and Vout of probe with a 25Ω 100 ps step generator.

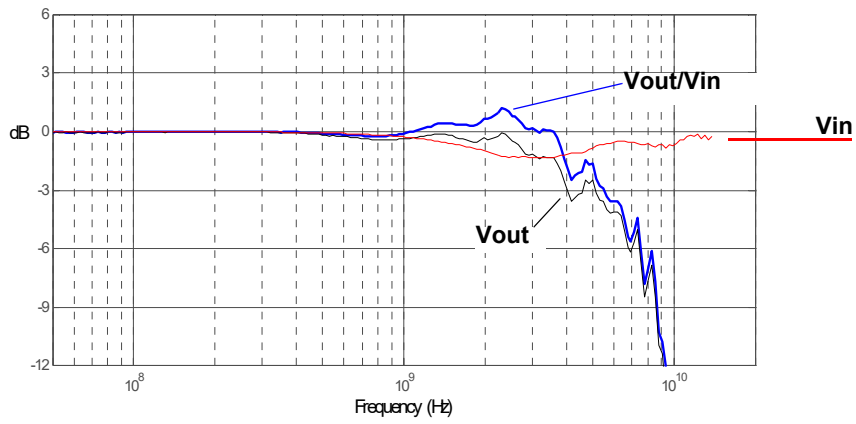

Figure 213 Graph of V_{in} and V_{out} of probe with a 25Ω source and V_{out}/V_{in} frequency response.

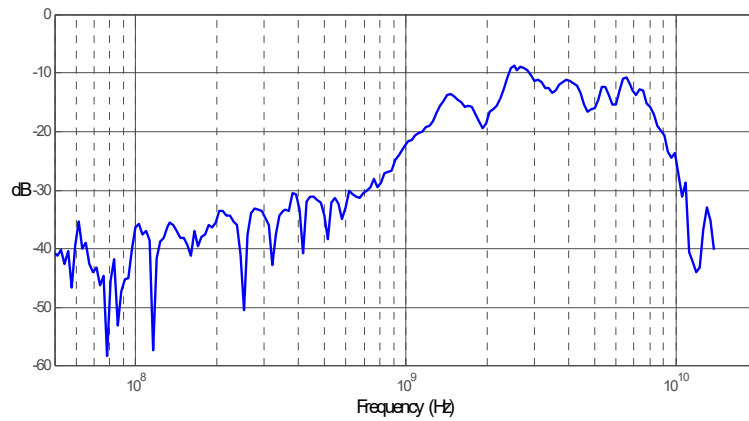

Figure 214 Graph of V_{out}/V_{in} frequency response when inputs driven in common (common mode rejection).

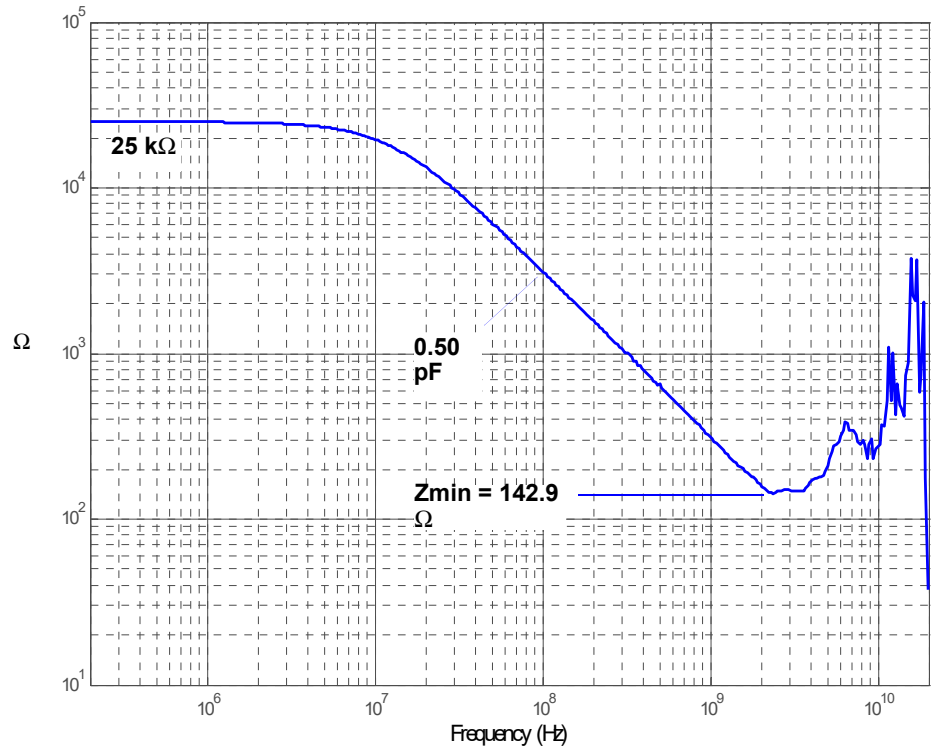

Figure 215 Magnitude plot of probe input impedance versus frequency.

E2679B Single-Ended Solder-in Probe Head (Medium BW)

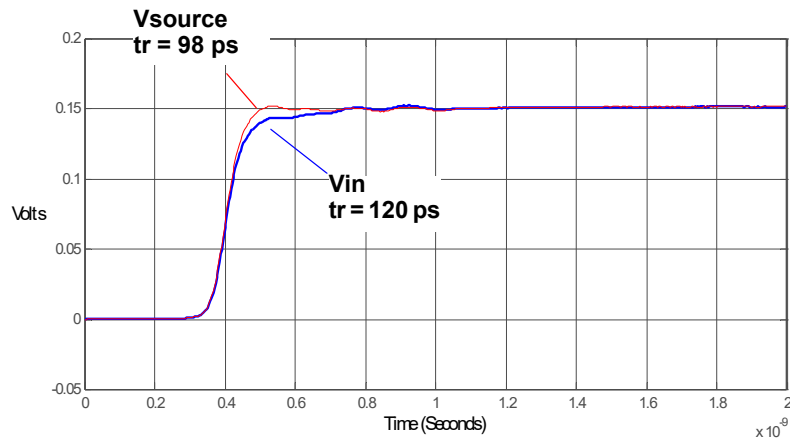

Figure 216 Graph of 25Ω 100 ps step generator with and without probe connected.

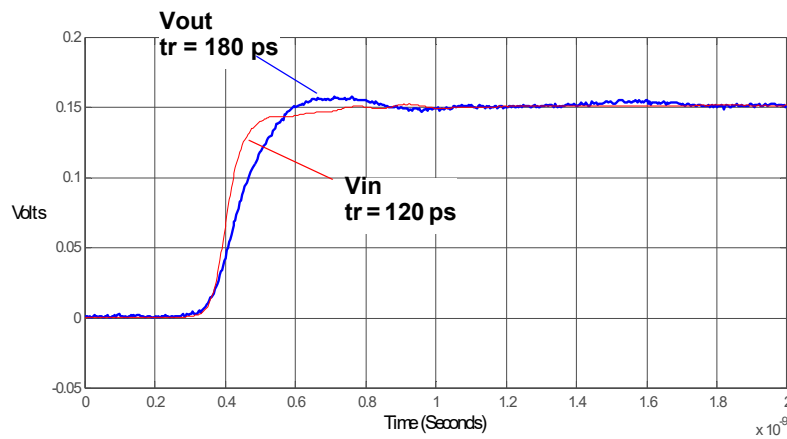

Figure 217 Graph of Vin and Vout of probe with a 25Ω 100 ps step generator.

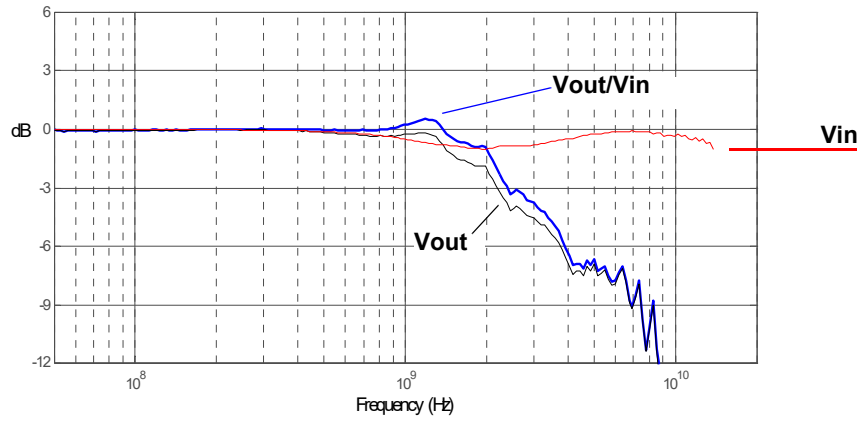

Figure 218 Graph of Vin and Vout of probe with a 25Ω source and Vout/Vin frequency response.

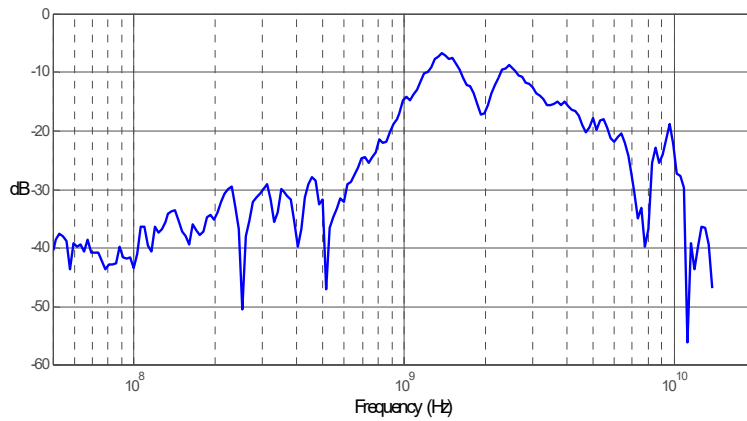

Figure 219 Graph of Vout/Vin frequency response when inputs driven in common (common mode rejection).

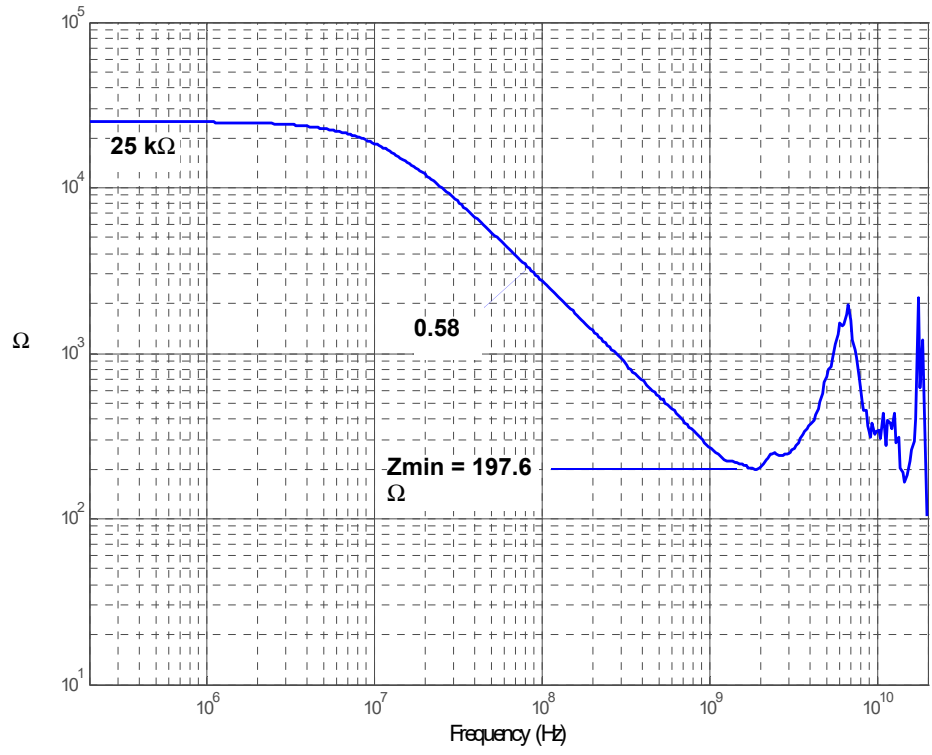

Figure 220 Magnitude plot of probe input impedance versus frequency.

N5380B SMA Probe Head

The following performance characteristic plots are for the 1134B probe using N5380B probe head. For a graph of the return loss, refer to the Performance Plots chapter in the 1168/9B User's Guide.

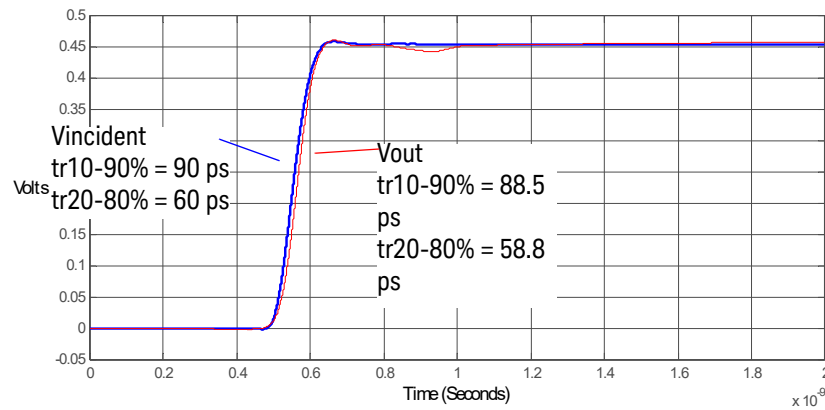

Figure 221 Vincident and Vout of probe with a 90 ps step

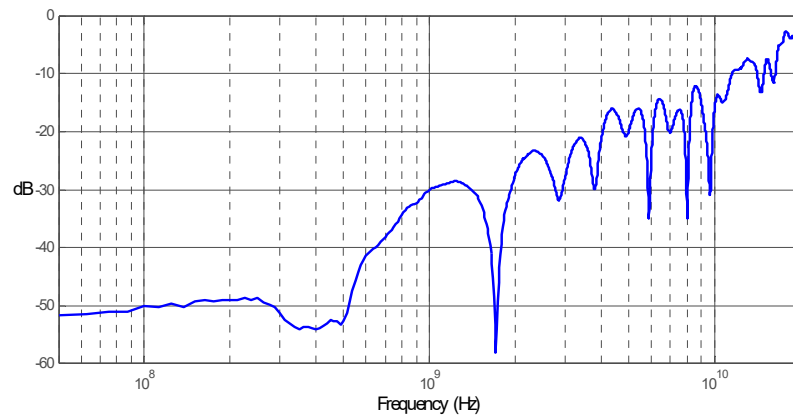

Figure 222 Magnitude plot of differential return loss

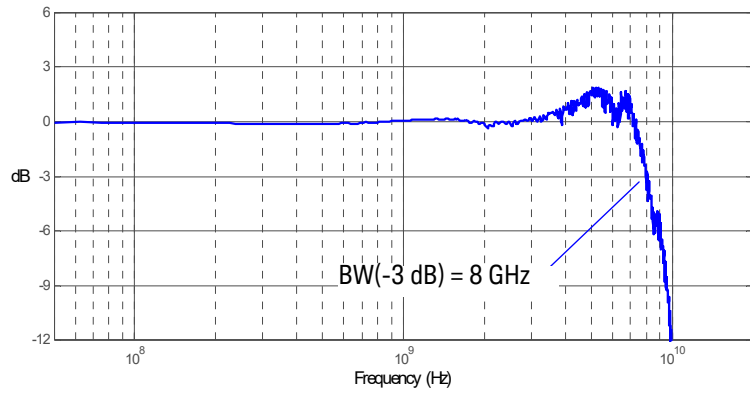

Figure 223 Magnitude response of differential insertion loss +16.03 dB

N2851A QuickTip Head with N2849A QuickTip

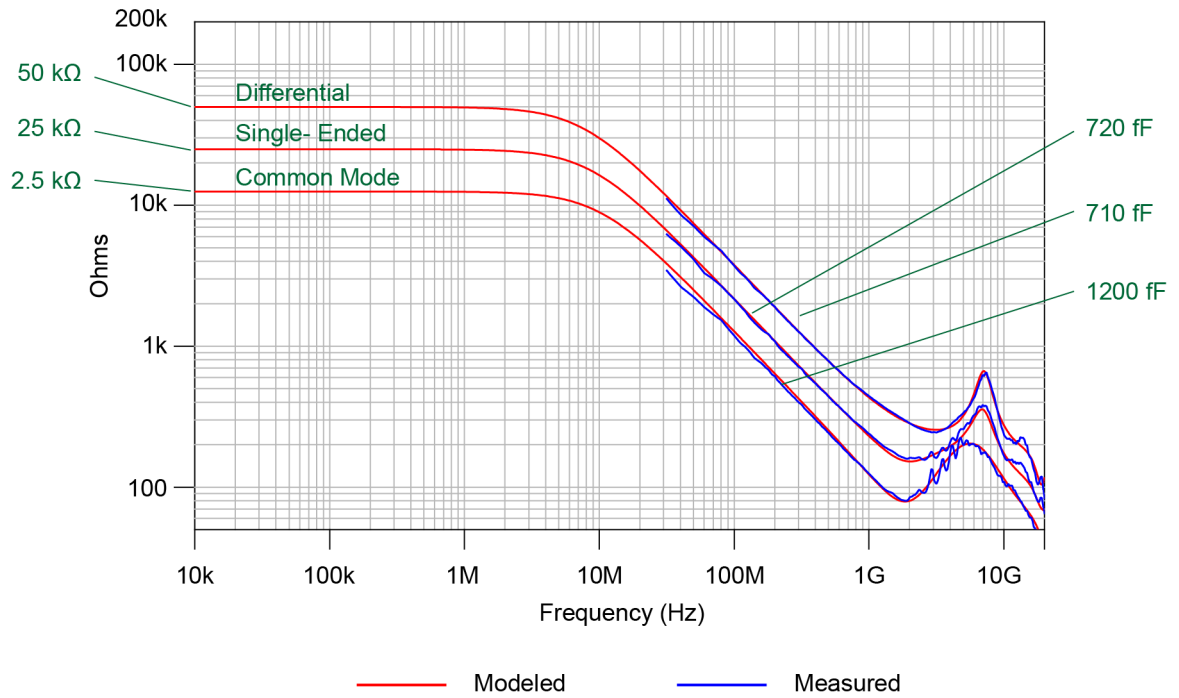

Figure 224 Input Impedances (Modeled and Measured)

9 Performance Verification

Using the 8720ES VNA successfully **208**

Procedure **209**

Performance Test Record **216**

This chapter describes how to verify the bandwidth performance of the probe.



CAUTION

Electrostatic discharge (ESD) can quickly and imperceptibly damage or destroy high performance probes, resulting in costly repairs. Always wear a wrist strap when handling probe components and ensure that cables are discharged before being connected.

NOTE

Allow the probe to warm up for at least 20 minutes.

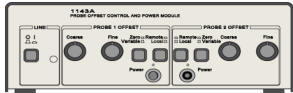
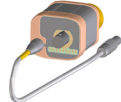
Table 30 Required Test Equipment

Test Equipment	Critical Specification	Model Number
Vector Network Analyzer (VNA)	7 GHz sweep range full 2 port cal Option 1D5	Keysight 8720ES
		
Calibration Standards	No Substitute	Keysight 85052D
External Power Supply	No Substitute	Keysight 1143A
		
AutoProbe Interface Adapter	No Substitute	Keysight N1022A/B
		
Outside thread 3.5 mm (male) to 3.5 mm (female) adapter	No Substitute	Keysight 5062-1247
Cable (2)	3.5 mil; SMA; High Quality	Keysight 8120-4948
Cable	1.5 mil Probe Power Extension No Substitute	Keysight 01143-61602
PV Fixture	E2655C, No Substitute	Keysight E2655C
		

Using the 8720ES VNA successfully

Remember these simple guidelines when working with the 8720ES VNA during this procedure.

- Sometimes it may take a few seconds for the waveforms to settle completely. Allow time for waveforms to settle before continuing.
- Make sure all connections are tight and secure. If needed, use a vise to hold the cables and test board stable while making measurements.
- Be careful not to cross thread or force any connectors. This could be a very costly error to correct.

Procedure

Initial Setup

- 1 Turn on the 8720ES VNA and let warm up for 20 minutes.
- 2 Press the green **[Preset]** key on the 8720ES VNA.
- 3 On the VNA, press the **[Power]** key and set the power to 0 dBm.
- 4 On the VNA, press the **[AVG]** key and then select the **Averaging Factor** screen key. Set averaging to 4.
- 5 On the VNA, press the **[Sweep Setup]** key and then press the **sweep type menu** screen key. Select the **log freq** screen key.
- 6 Connect the probe under test to the Auto Probe Adapter and power the probe using the 1143A power supply. Install the outside thread adapter to the Auto Probe Adapter.

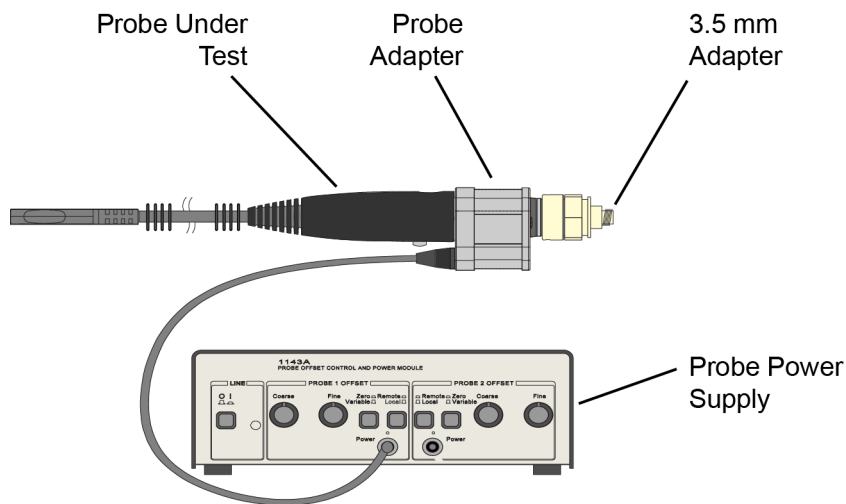

Figure 225 Probe Connected to Power Supply

Calibrating a Reference Plane

To get a reliable measurement from the VNA you must calibrate a reference plane so that the VNA knows where the probe under test is located along the transmission line.

- 7 On the VNA, press the **[Cal]** key.
- 8 Press the **cal menu** screen key.
- 9 Press the **full 2 port** screen key.
- 10 Connect one of the high quality SMA cables from the VNA's **Port 1** to the pincher side of PV Fixture as shown in **Figure 226**. The figure also identifies the calibration reference plane.

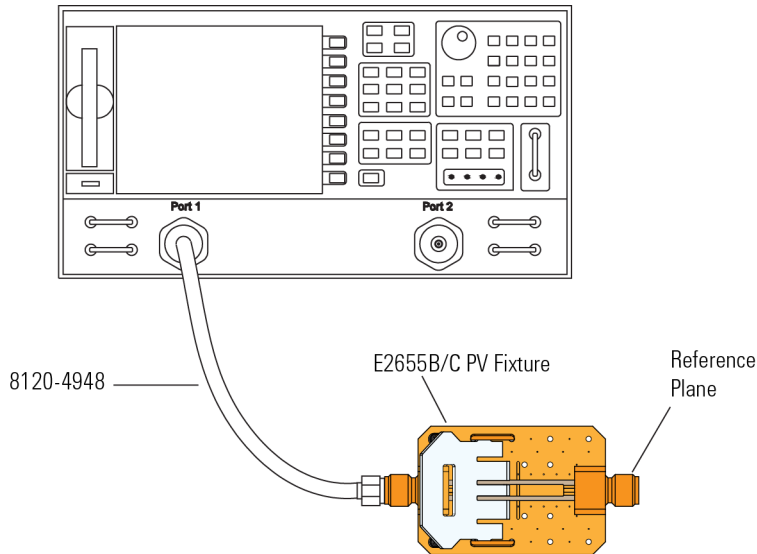

Figure 226 PV Fixture Connected to VNA

- 11 Perform a calibration at the reference plane:
 - a Press the **reflection** screen key.
 - b Connect the open end of 85052D Calibration Standard to the non-pincher side of the PV/DS test board.
 - c Select the **open** screen key under the **Forward** group.
 - d Wait until the VNA beeps indicating that it has completed the task.
 - e Connect short end of Calibration Standard to the non-pincher side of the PV/DS test board.
 - f Select **short** screen key under the **Forward** group.
 - g Wait until the VNA beeps indicating that it has completed the task.
 - h Connect load end of Calibration Standard to the non-pincher side of the PV/DS test board.
 - i Select the **loads** screen key under the **Forward** group.
 - j Press **broadband** screen key selection.
 - k Wait until the VNA beeps indicating that it has completed the task.
 - l Press the **done loads** screen key.
 - m You have just calibrated one side of the reference plane.
- 12 Connect the other high quality SMA cable to the VNA's **PORT 2** connector.

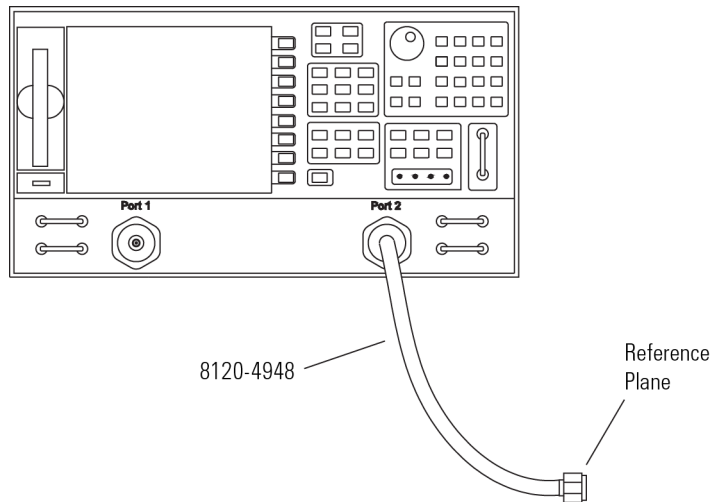

Figure 227 SMA Cable Connected to Port 2

- 13 Get the opposite sex of the Calibration Standards for the next step.
- 14 Perform Calibration for the **PORT 2** side of the Reference plane.
 - a Press the **reflection** screen key.
 - b Connect the open end of Calibration Standard to the available end of the **PORT 2** SMA cable.
 - c Select the **open** screen key under the **Reverse** group.
 - d Wait until the VNA beeps indicating that it has completed the task.
 - e Connect short end of Calibration Standard to the available end of the **PORT 2** SMA cable.
 - f Select **short** screen key the **Reverse** group.
 - g Wait until the VNA beeps indicating that it has completed the task.
 - h Connect load end of Calibration Standard to the available end of the **PORT 2** SMA cable.
 - i Select the **loads** screen key the **Reverse** group.
 - j Press **broadband** screen key selection.
 - k Wait until the VNA beeps indicating that it has completed the task.
 - l Press the **done loads** screen key.
 - m You have just calibrated the other side of the reference plane.
- 15 Press **standards done** key.
- 16 Connect **PORT 2** SMA cable to the non-pincher side of PV Fixture.

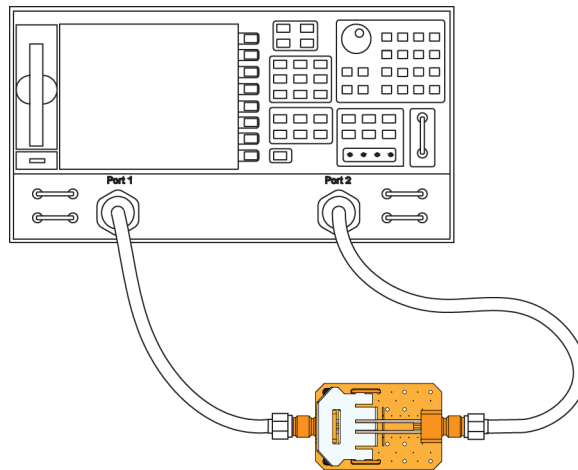

Figure 228 Forward and Reverse Setup

- 17 Press the **transmission** screen key.
- 18 Press the **do both fwd and reverse** screen key.
- 19 Wait until the VNA beeps four times indicating that it has completed the task.
- 20 Press the **isolation** screen key.
- 21 Press the **omit isolation** screen key.
- 22 Press **done 2 port cal** screen key.
- 23 Set the VNA's averaging to off.
- 24 Save the reference plane cal by pressing the **[save recall]** key then the **[save state]** key.
- 25 You may change name if you wish.
- 26 Press the **[scale reference]** key. Then set the scale to 1 dB per division and the reference position for 7 divisions.
- 27 Set reference value for 0 dB.
- 28 Press the **[measure]** key.
- 29 Press the **s21** screen key.
- 30 Ensure s21 response on screen is flat (about ± 0.1 dB) out to 10 GHz.

Measuring Vin Response

- 31 Position 1134B probe conveniently to make quality connections on the PV fixture.
- 32 Ensure resistors at the probe tip are reasonably straight and about 0.1 inches apart.

- 33 Connect probe tip under the PV fixture's pincher. Apply upward pressure to the clip to ensure a proper electrical connection. Place the probe's "+" side on center conductor and "-" side to ground as shown in the following figure.

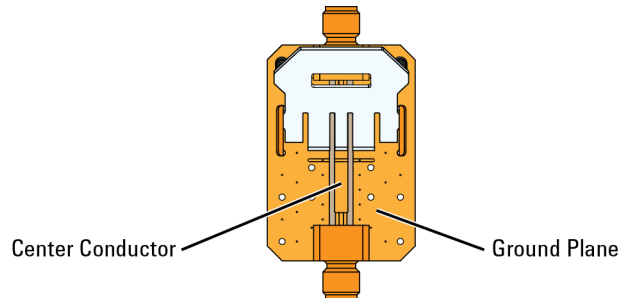

Figure 229 Probe Locations on PV Fixture

- 34 Press the **[Sweep Setup]** key on the VNA. Then press the **trigger menu** screen key. Select the **continuous** screen key.
- 35 The V_{in} waveform shown on screen should be similar to that shown in **Figure 230** on page 213.

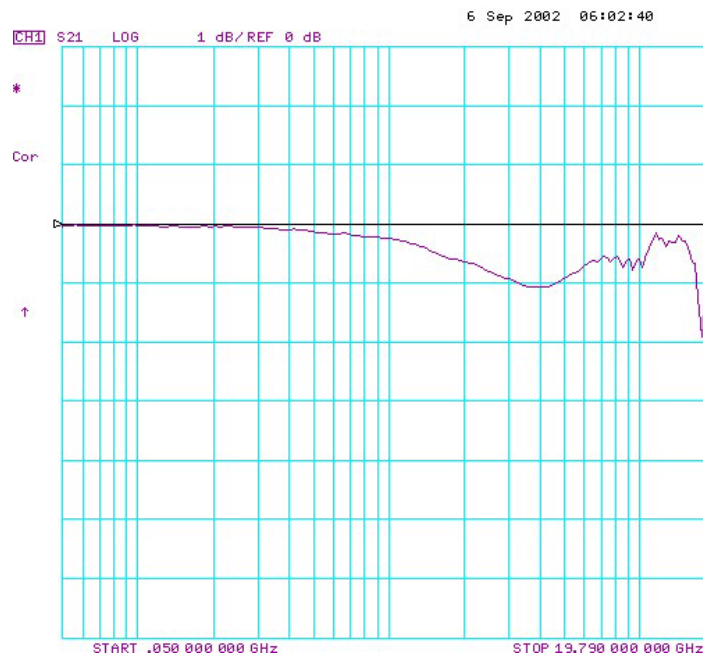

Figure 230 Typical V_{in} Waveform for an 1134B Probe

- 36 Select **[display]** key then **data->memory** screen key.
- 37 You have now saved V_{in} waveform into the VNA's memory for future use.

Measuring V_{out} Response

- 38 Disconnect the **PORT 2** cable from PV/DS test board and attach to probe output on the AutoProbe Adapter.
- 39 Connect the Calibration Standard load to PV/DS test board (non-pincher side).
- 40 Press [**scale reference**] key on the VNA.
- 41 Set reference value to -20 dB.
- 42 Hold probe in place as described previously.
- 43 The display on screen is V_{out} and it should be similar to that shown in **Figure 231** on page 214.

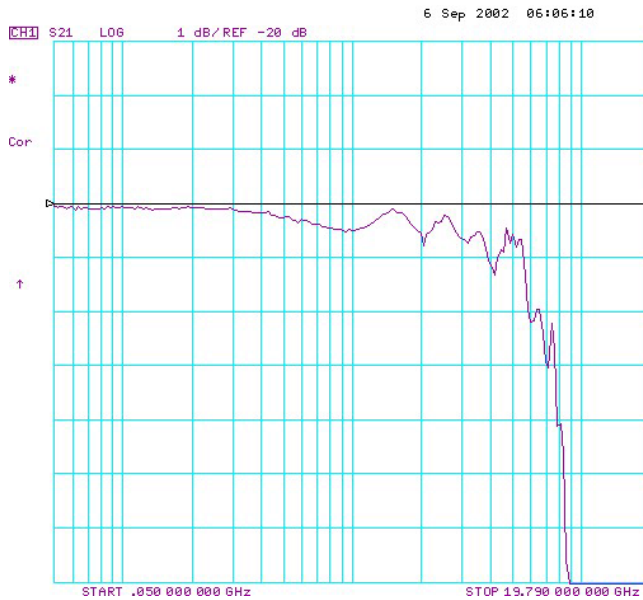

Figure 231 Typical V_{out} Waveform for an 1134B Probe

Displaying the V_{out}/V_{in} Response

- 44 Press the [**Display**] key.
- 45 Then select the **Data/Memory** screen key. You may need to adjust the **Reference Value**, located under the **Scale Ref** key, slightly to position the waveform at center screen. The waveform should be similar to that shown in **Figure 232** on page 215.

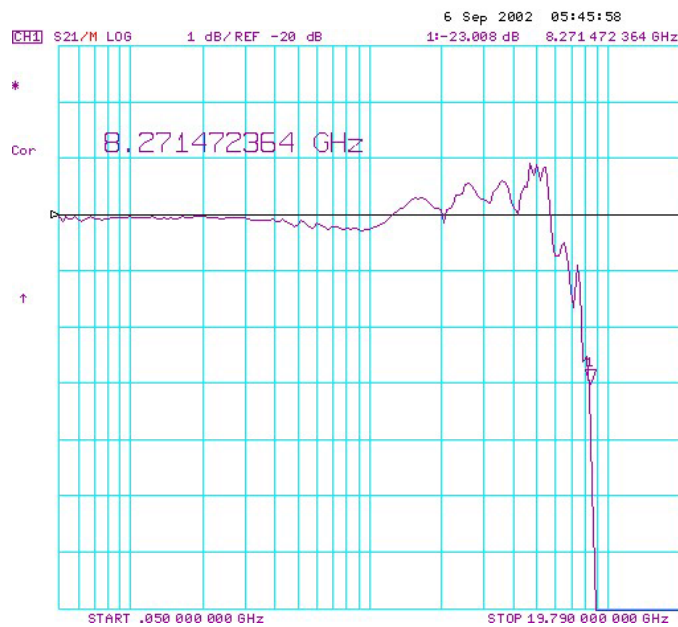

Figure 232 Typical Waveform for an 1134B Probe

- 46 Press marker key and position the marker to the first point that the signal is -3 dB below center screen.
- 47 Read marker frequency measurement and record it in the test record located later in this chapter.
- 48 The bandwidth test passes if the frequency measurement is greater than the probe's bandwidth limit.

Performance Test Record

Table 31 Performance Test Record

Model #:	Date:	Recommended next test date:	
Serial #:	Tested by:		
Probe Amplifier	Test Limits	Result	Pass/Fail
1130B	1.5 GHz		
1131B	3.5 GHz		
1132B	5 GHz		
1134B	7 GHz		

10 SPICE Models

SPICE Model for Differential Probe Heads	219
SPICE Model for Single-Ended Probe Heads	220
SPICE Deck and Measured/Modeled Data Matching	221
E2675B Differential Browser Probe Head	221
E2678A/B Differential Socket Tip Probe Head	222
E2677B Differential Solder-In Probe Head	224
E2676B Single-Ended Browser Probe Head	225
E2679B Single-Ended Solder-In Probe Head	227
N2851A QuickTip Head with N2849A QuickTip Tip	229

Input Impedance SPICE Models for InfiniiMax 1130 Series 3.5 GHz to 7 GHz Active Probes

This chapter contains SPICE models that can be used to predict the probe loading effects of the InfiniiMax active probes. Important points about these SPICE models are:

- SPICE models shown here are currently only for input impedance which allows modeling of the probe loading effects. Probe transfer function is generally flat to the specified BW. Transfer function SPICE models may be added later if demand is sufficient.
- These input impedance is a function of the probe head type only. The probe amp bandwidth (3.5 GHz 1131B, 5 GHz 1132B, or 7 GHz 1134B) does not have any effect on the input impedance of the probe heads.

The following five configurations are covered in this chapter:

- Differential Browser Probe Head (E2675B)
- Differential Socket Tip Probe Head (E2678A/B)
- Differential Solder-In Probe Head (E2677B) (Full BW 91 ohm resistors)
- Single-Ended Browser Probe Head (E2676B)
- Single-Ended Solder-In Probe Head (E2679B) (Full BW 91 ohm resistor)

If damped wire accessories or longer mid-BW resistors (for solder-in probe heads) are used, they can be modeled by adding an RLC model in front of the appropriate probe head model and zeroing out the damping resistor in the probe head model.

There is one SPICE schematic for the differential probe heads and one SPICE schematic for the single-ended probe heads. The schematics have parameterized R, L, and C values that are given in the SPICE deck for the specific probe head. Additionally, an input impedance plot is given that shows the matching of the measured data to the modeled data. Matching is generally very good up to the specified BW of the probe head with the 7 GHz probe amp.

SPICE Model for Differential Probe Heads

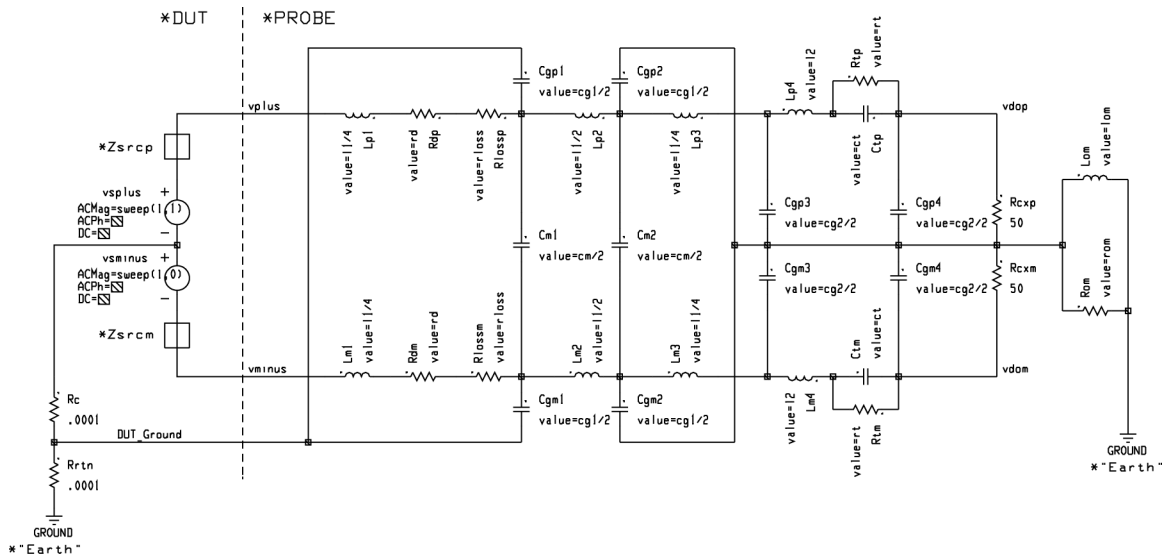

Figure 233 SPICE Model for Differential Probe Heads

Rrtn (Zrtn) is dependent on connection from DUT ground to “Earth” ground. Most likely modeled by a parallel RL similar to Rom || Lom. Will have slight effect on single-ended input Z and no effect on differential input Z.

Cgp1 and Cgm1 represent C from probe tips to DUT ground near probe tips.

If using diff probe to probe single-ended signals:

- vplus connected to DUT signal
- vminus connected to DUT ground with means that Rc = 0 and Zsrcm = 0.
- Input impedance is defined to be vplus/i (vspplus)

If using diff probe to probe differential signals:

- Rc (or Zc) will depend on the DUT circuit
- vplus connected to DUT plus signal
- vminus connected to DUT minus signal.
- Input impedance is defined to be (vplus/vminus) / i (vspplus)

SPICE Model for Single-Ended Probe Heads

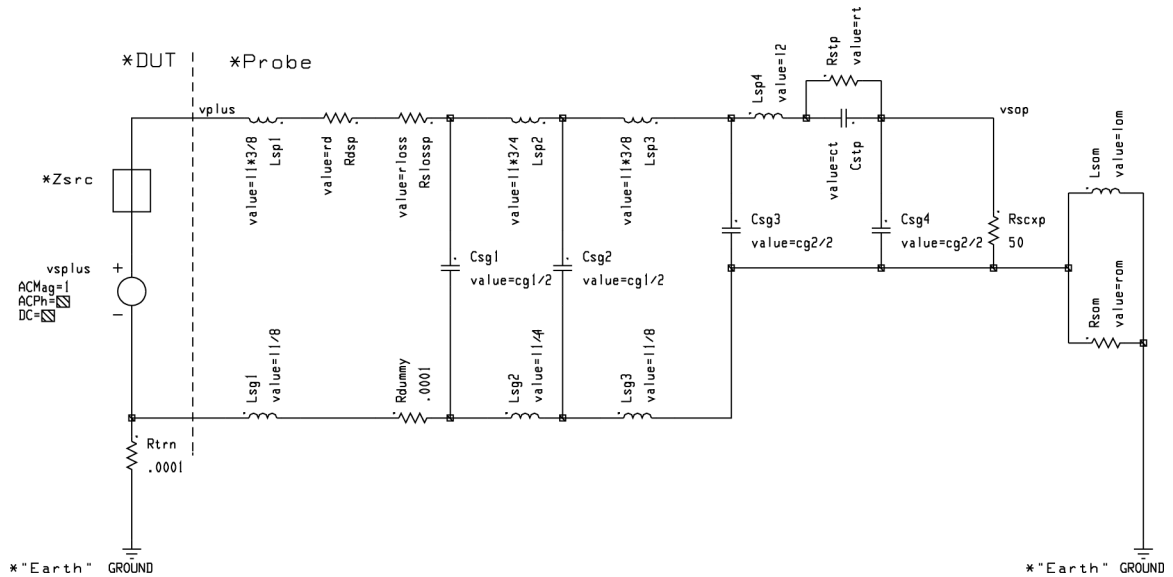

Figure 234 SPICE Model for Single-Ended Probe Heads

Rtn (Zrtn) is dependent on connection from DUT ground to “Earth” ground. Most likely modeled by a parallel RL similar to Rom || Lom. Will have slight effect on input Z.

Probe tip C to DUT ground lumped into Csg1 since there is no damping R in ground path.

Input impedance is defined as $vplus/i(vsplus)$.

SPICE Deck and Measured/Modeled Data Matching

E2675B Differential Browser Probe Head

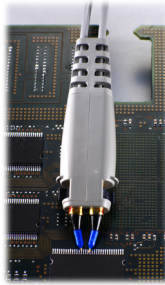

```
.param rd=91 rt=25k rloss=10 rom=100 l1=6.5n l2=2n lom=2u cm=80f cg1=120f
cg2=320f ct=200f
```

```
vsminus %164 %vminus ACMag=sweep(1,0)
vsplus %vplus %164 ACMag=sweep(1,1)
Cgp1 %DUT_Ground %99 value=cg1/2
Cgp2 %122 %85 value=cg1/2
Cgm2 %84 %122 value=cg1/2
Cgm1 %95 %DUT_Ground value=cg1/2
Cm1 %99 %95 value=cm/2
Cgp3 %86 %122 value=cg2/2
Cm2 %85 %84 value=cm/2
Cgm4 %122 %vdom value=cg2/2
Cgm3 %122 %87 value=cg2/2
Cgp4 %vdop %122 value=cg2/2
Ctp %vdop %88 value=ct
Ctm %89 %vdom value=ct
Lm3 %84 %87 value=l1/4
Lp3 %86 %85 value=l1/4
Lm4 %89 %87 value=l2
Lp4 %86 %88 value=l2
Lp1 %118 %vplus value=l1/4
Lp2 %85 %99 value=l1/2
Lm1 %vminus %117 value=l1/4
Lm2 %95 %84 value=l1/2
Lom %122 %0 value=lom
Rrtn %DUT_Ground %0 .0001
Rc %164 %DUT_Ground .0001
Rlossp %99 %159 value=rloss
Rlossm %160 %95 value=rloss
Rdp %159 %118 value=rd
Rdm %117 %160 value=rd
Rtm %vdom %89 value=rt
Rtp %88 %vdop value=rt
Rcxp %vdop %122 50
Rcxm %122 %vdom 50
Rom %122 %0 value=rom
```

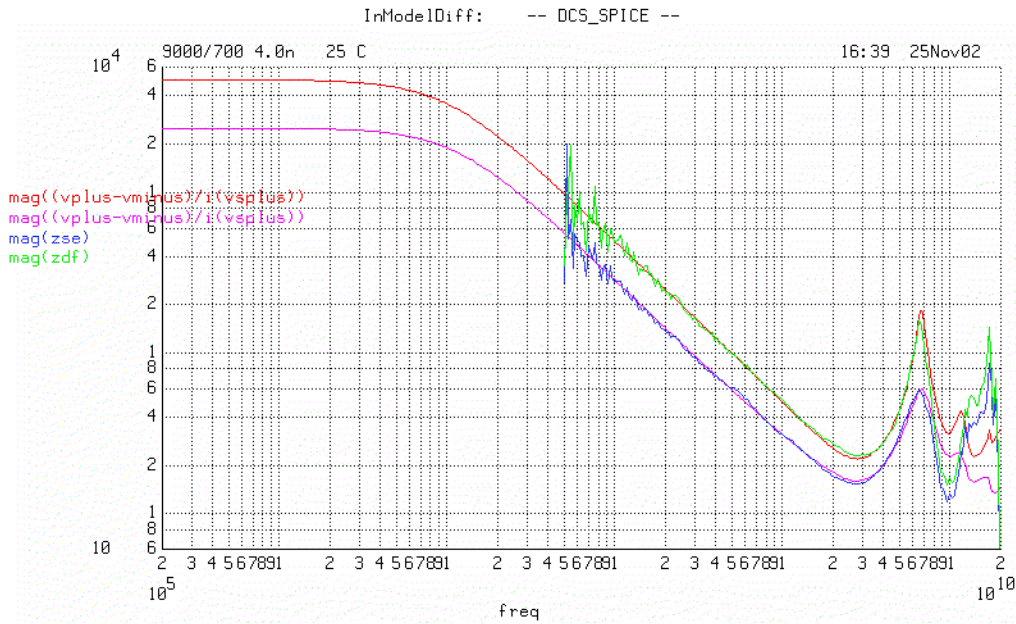

E2678A/B Differential Socket Tip Probe Head

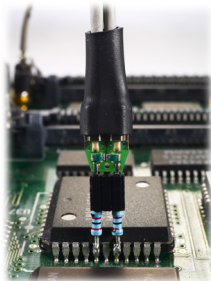

```
.param rd=82 rt=25k rloss=25 rom=200 l1=4n l2=2n lom=2u cm=117f cg1=120f
cg2=320f ct=200f
```

```
vsminus %164 %vminus ACMag=sweep(1,0)
vsplus %vplus %164 ACMag=sweep(1,1)
Cgp1 %DUT_Ground %99 value=cg1/2
Cgp2 %122 %85 value=cg1/2
Cgm2 %84 %122 value=cg1/2
Cgm1 %95 %DUT_Ground value=cg1/2
Cm1 %99 %95 value=cm/2
Cgp3 %86 %122 value=cg2/2
Cm2 %85 %84 value=cm/2
Cgm4 %122 %vdom value=cg2/2
Cgm3 %122 %87 value=cg2/2
Cgp4 %vdop %122 value=cg2/2
Ctp %vdop %88 value=ct
Ctm %89 %vdom value=ct
```

```

Lm3 %84 %87 value=l1/4
Lp3 %86 %85 value=l1/4
Lm4 %89 %87 value=l2
Lp4 %86 %88 value=l2
Lp1 %118 %vplus value=l1/4
Lp2 %85 %99 value=l1/2
Lm1 %vminus %117 value=l1/4
Lm2 %95 %84 value=l1/2
Lom %122 %0 value=lom
Rrtn %DUT_Ground %0 .0001
Rc %164 %DUT_Ground .0001
Rlossp %99 %159 value=rloss
Rlossm %160 %95 value=rloss
Rdp %159 %118 value=rd
Rdm %117 %160 value=rd
Rtm %vdom %89 value=rt
Rtp %88 %vdop value=rt
Rcxp %vdop %122 50
Rcxm %122 %vdom 50
Rom %122 %0 value=rom
    
```

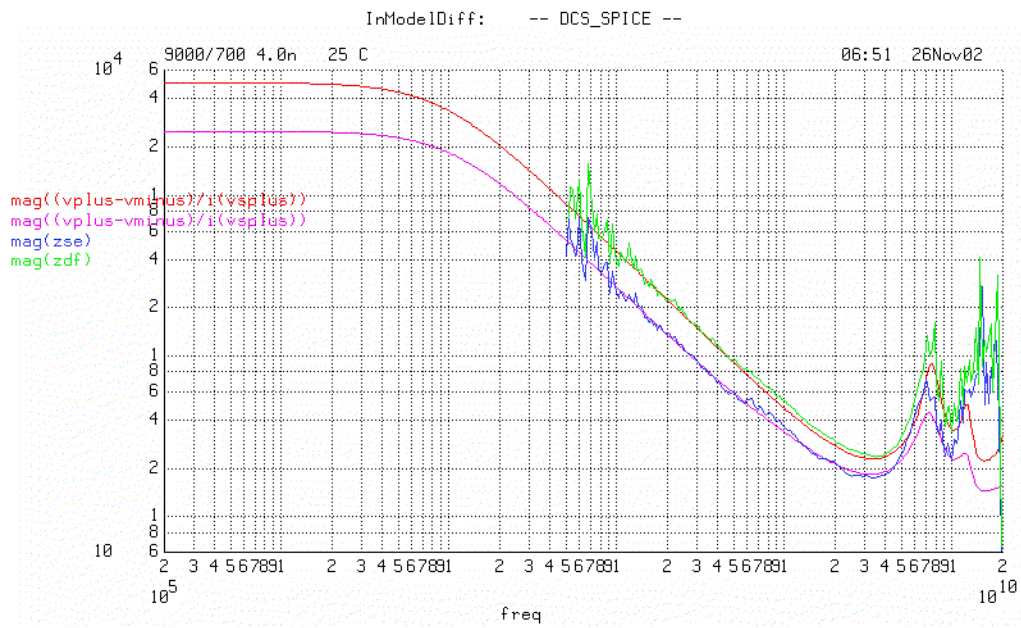

E2677B Differential Solder-In Probe Head

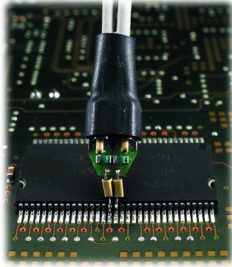

Data for full bandwidth with 91 Ω resistor.

```
.param rd=91 rloss=18 rt=25k rom=250 l1=4n l2=2n lom=2u cm=100f cg1=80f
cg2=180f ct=200f
```

```
vsminus %164 %vminus ACMag=sweep(1,0)
vsplus %vplus %164 ACMag=sweep(1,1)
Cgp1 %DUT_Ground %99 value=cg1/2
Cgp2 %122 %85 value=cg1/2
Cgm2 %84 %122 value=cg1/2
Cgm1 %95 %DUT_Ground value=cg1/2
Cm1 %99 %95 value=cm/2
Cgp3 %86 %122 value=cg2/2
Cm2 %85 %84 value=cm/2
Cgm4 %122 %vdom value=cg2/2
Cgm3 %122 %87 value=cg2/2
Cgp4 %vdop %122 value=cg2/2
Ctp %vdop %88 value=ct
Ctm %89 %vdom value=ct
Lm3 %84 %87 value=l1/4
Lp3 %86 %85 value=l1/4
Lm4 %89 %87 value=l2
Lp4 %86 %88 value=l2
Lp1 %118 %vplus value=l1/4
Lp2 %85 %99 value=l1/2
Lm1 %vminus %117 value=l1/4
Lm2 %95 %84 value=l1/2
Lom %122 %0 value=lom
Rrtn %DUT_Ground %0 .0001
Rc %164 %DUT_Ground .0001
Rlossp %99 %159 value=rloss
Rlossm %160 %95 value=rloss
Rdp %159 %118 value=rd
Rdm %117 %160 value=rd
Rtm %vdom %89 value=rt
Rtp %88 %vdop value=rt
Rcxp %vdop %122 50
Rcxm %122 %vdom 50
Rom %122 %0 value=rom
```

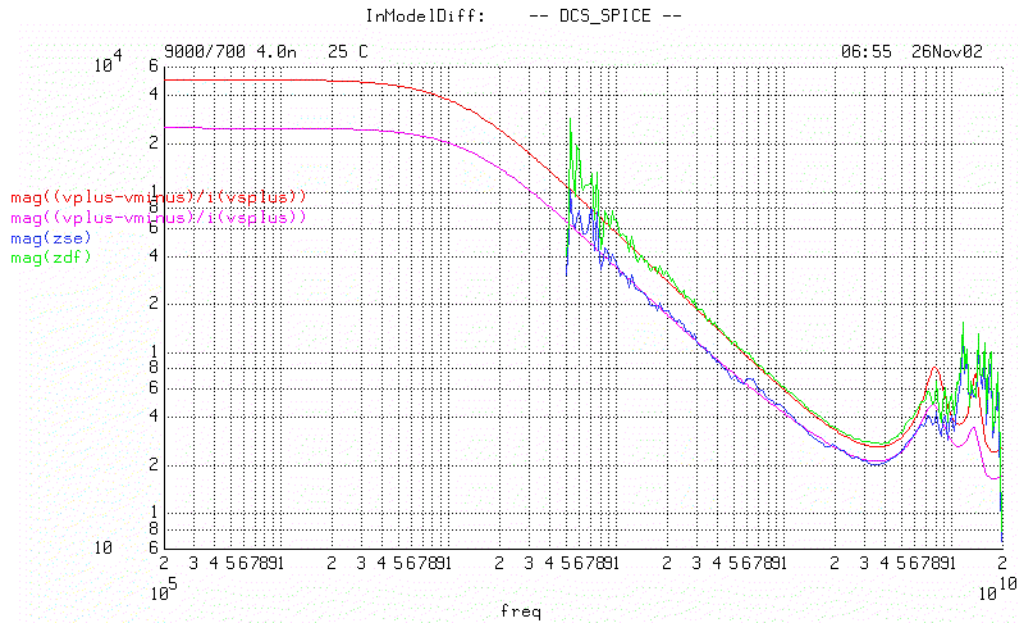
E2676B Single-Ended Browser Probe Head

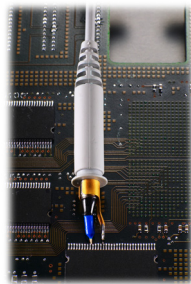

```
.param rd=82 rt=25k rom=100 rloss=25 l1=3.5n l2=.5n lom=2u cg1=270f cg2=370f
ct=200f
```

```
.ac dec 77 200k 19.7g
.options map
vsplus %130 %165 ACMag=1
Csg4 %vsop %134 value=cg2/2
Cstp %vsop %131 value=ct
Csg2 %138 %139 value=cg1/2
Csg3 %132 %134 value=cg2/2
Csg1 %137 %136 value=cg1/2
Lsp1 %141 %130 value=l1*3/8
Lsp2 %138 %137 value=l1*3/4
Lsg1 %165 %164 value=l1/8
Lsg2 %136 %139 value=l1/4
Lsom %134 %0 value=lom
Lsp4 %132 %131 value=l2
```

```

Lsp3 %132 %138 value=l1*3/8
Lsg3 %139 %134 value=l1/8
Rtrn %165 %0 .0001
Rdummy %164 %136 .0001
Rslossp %137 %161 value=rloss
Rdsp %161 %141 value=rd
Rstp %131 %vsop value=rt
Rscxp %vsop %134 50
Rsom %134 %0 value=rom
    
```

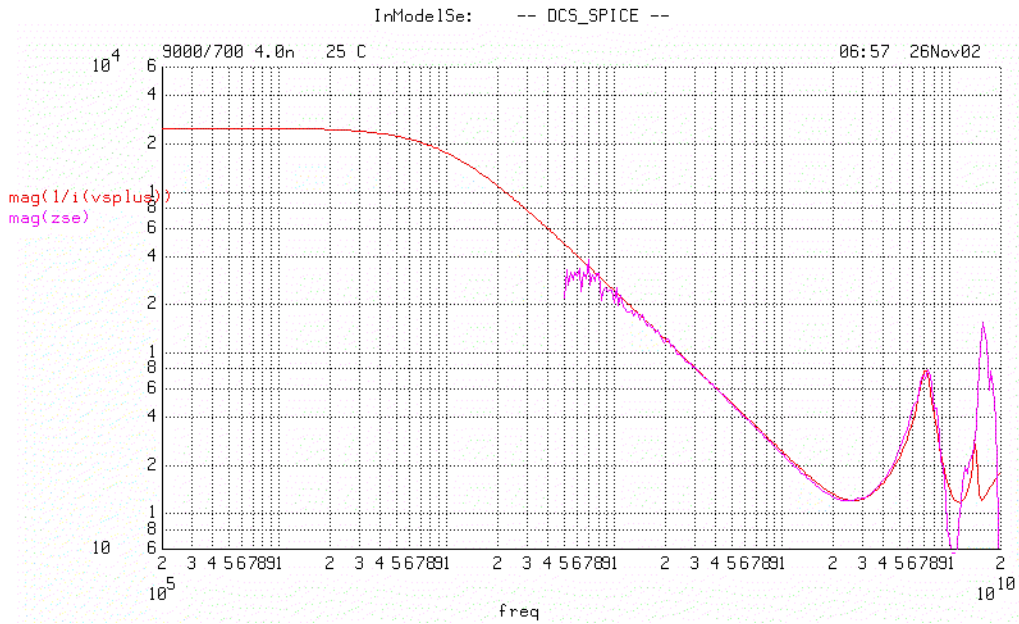

E2679B Single-Ended Solder-In Probe Head

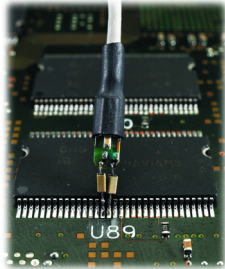

Data for full bandwidth with 91Ω resistor.

```
.param rd=91 rt=25k rom=250 rloss=25 l1=3n l2=.5n lom=2u cg1=150f cg2=300f
ct=200f
```

```
.ac dec 77 200k 19.7g
.options map
vsplus %130 %165 ACMag=1
Csg4 %vsop %134 value=cg2/2
Cstp %vsop %131 value=ct
Csg2 %138 %139 value=cg1/2
Csg3 %132 %134 value=cg2/2
Csg1 %137 %136 value=cg1/2
Lsp1 %141 %130 value=l1*3/8
Lsp2 %138 %137 value=l1*3/4
Lsg1 %165 %164 value=l1/8
Lsg2 %136 %139 value=l1/4
Lsom %134 %0 value=lom
Lsp4 %132 %131 value=l2
Lsp3 %132 %138 value=l1*3/8
Lsg3 %139 %134 value=l1/8
Rtrn %165 %0 .0001
Rdummy %164 %136 .0001
Rslossp %137 %161 value=rloss
Rdsp %161 %141 value=rd
Rstp %131 %vsop value=rt
Rscxp %vsop %134 50
Rsom %134 %0 value=rom
```

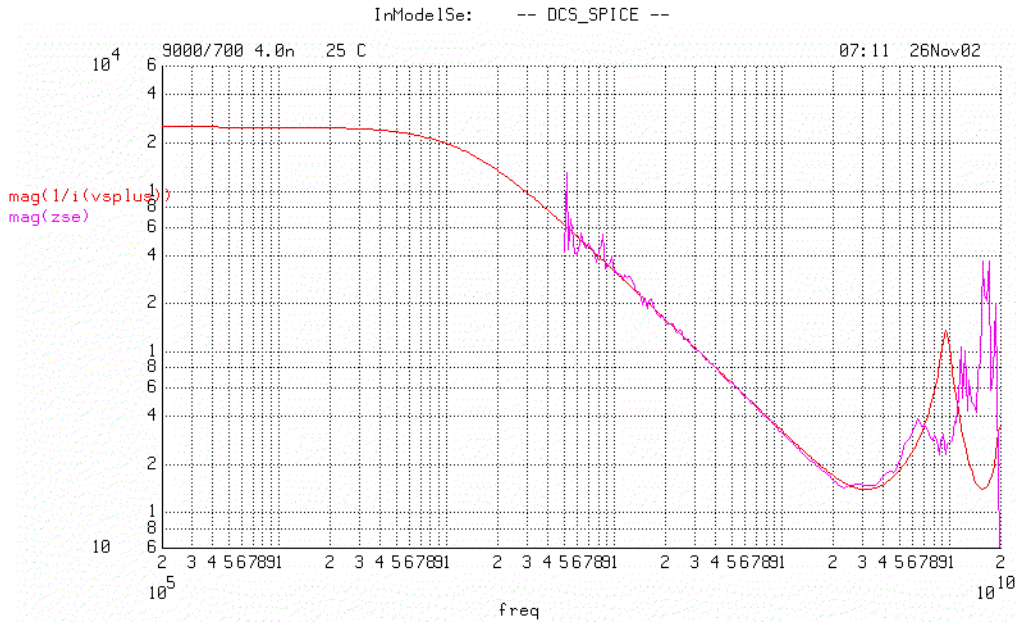

N2851A QuickTip Head with N2849A QuickTip Tip

The following input-impedance SPICE subcircuit data is for the N2851A QuickTip probe head with N2849A QuickTip tip. The data models all modes of input impedance: differential, common, and A or B. The probe is vertical orientated with both ground wires connected to the DUT ground.

SPICE subcircuit data

```
* Input impedance SPICE subckt for N2849A_N2851A QuickTip and QuickTip probe
head.
* Vertical orientation with both ground wires connected to DUT ground
* Models all modes of input impedance: Diff, Common, and A or B
.subckt N2849A_N2851A 1 2
r1 1 3 1e8
r2 2 3 1e8
r9 3 0 .5e8
r_src2 5 7 201.895
l_src2 7 8 4.24047n
c_src2 8 6 101.955f
r_src3 4 9 190.712
l_src3 9 10 8.8192n
c_src3 10 6 7.86088f
r_src1 4 11 325.561
l_src1 11 12 2.89997n
c_src1 12 6 315.986f
r3 4 13 260
c1 13 6 200f
r5 13 6 50k
r8 6 0 1e-6
r4 14 16 130
r_src4 14 18 175.375
l_src4 18 19 13.431n
c_src4 19 17 485.278f
r_src5 14 20 13.8395
l_src5 20 21 3.28155n
c_src5 21 17 15.7972f
r_src6 15 22 302.872
l_src6 22 23 3.28881n
c_src6 23 17 79.906f
r6 16 17 25k
c2 16 17 200f
r7 17 0 1e-6
e1 5 0 4 0 -1
e2 4 0 1 2 1
e3 14 0 3 0 2
e4 15 0 14 0 -1
g1 1 2 6 0 1e6
g2 1 0 17 0 1e6
g3 2 0 17 0 1e6
.ends
```

11 Replacement Parts

E2675B Differential Browser Probe Head	232
E2677B Differential Solder-In Probe Head	232
E2678A/B Differential Socketed Probe Head	233
E2679B Single-Ended Solder-in Probe Head	233
Other Accessories	234

E2675B Differential Browser Probe Head

Table 32 E2658B Kit

Description	Qty Supplied
Resistive tip (blue), 91 Ω	20
Ergonomic handle	1

E2677B Differential Solder-In Probe Head

Table 33 E2670B Kit

Description	Qty Supplied
91 Ω resistor for full bandwidth	20
150 Ω resistor for medium bandwidth	10
91 Ω resistor template	1
150 Ω resistor template	1

Table 34 Resistors

Description	Qty	Order From Vendor	Orderable Part Number
91 Ω resistor	1	BREL International	RMB16-910-JB
150 Ω resistor	1	BREL International	RMB16A-151-JB

E2678A/B Differential Socketed Probe Head

Table 35 E2671B Kit

Description	Qty Supplied
160 Ω damped wire accessory	6
82 Ω resistor for full bandwidth	48
Socket for 25 mil (25/1000 inch) square pins, female on both ends	4
25 mil female socket w/20 mil round male pin on other end	4
Heatshrink socket accessory	4
Header adapter, 91 Ω	2
82 Ω resistor template	1

Table 36 Resistors

Description	Qty	Order From Vendor	Orderable Part Number
82 Ω resistor	1	Vishay	MBA0204AC8209GC100

E2679B Single-Ended Solder-in Probe Head

Table 37 Resistors

Description	Qty	Order From Vendor	Orderable Part Number
0 Ω resistor	1	BREL International	RMB16-000-JB
91 Ω resistor	1	BREL International	RMB16-910-JB

Other Accessories

Table 38 Accessories

Description	Vendor	Part Number	Qty
Probe deskew and performance verification kit	Keysight	E2655C	1
160Ω damped wire accessory (01130-21303 34 each)	Keysight	E5381-82103	1
Header adapter kit for socketed differential probe head (01130-63201 10 each)	Keysight	01131-68703	1
Coupling tag for N5450B extreme temperature cable extension	Keysight	N5450-21201	1
SMA coaxial dc block	Inmet	#8037	1
SMA 6 dB coaxial attenuator	Inmet	#18AH-6	1
SMA 12 dB coaxial attenuator	Inmet	#18AH-12	1
SMA adjustable delay	ATM Microwave	#P1907	1
GPO-F to GPO-F adapter for N5380B	Corning Gilbert Rosenberger	#A1A1-0001-03 #19K 109-K00 E4	2

Index

- A**
- accessories, 11
 - damped wire, 73
 - supplied, 10
 - altitude, 96
 - available probe heads, 9
- B**
- browser, differential, 56
 - browser, single-ended, 67
- C**
- calibration
 - failure, 34
 - probe, 81
 - calibration, probe with
 - oscilloscope, 81
 - CAT definitions, 97
 - channel identification rings, 10
 - characteristics, 96
 - cleaning, 12
- D**
- damped wire accessory, 73
 - definitions, CAT, 97
 - differential probe head, 75
 - dimensions, 96
 - probe amp, 98, 99
- E**
- E2668B Single-Ended
 - Connectivity Kit, 21
 - E2669B Differential
 - Connectivity Kit, 22
 - E2675B Differential Browser
 - Probe Head, 56
 - E2676B Single-Ended Browser
 - Probe Head, 67
 - E2677B Differential Solder-In
 - Probe Head, 51, 69
 - E2678B Differential Socketed
 - Probe Head, 53, 73, 75
 - E2679B Single-Ended
 - Solder-In Probe Head, 66, 71
- F**
- environmental conditions, 96
 - ESD tolerance, 95
 - extreme temp, 24
- F**
- full bandwidth probe, 51, 53, 66
- G**
- general characteristics, 96
- H**
- header adapter, 75
 - humidity, 96
- I**
- Infiniium oscilloscope, 10
 - InfiniiVision oscilloscope, 10
 - inspecting, 10
- K**
- Keysight Technologies,
 - contacting, 35
- M**
- medium bandwidth, 69, 71
 - MX0100A dimensions, 99
 - MX0100A lead wires, 42
 - MX0100A strain relief, 46
 - MX0102A, 30
- N**
- N2849A QuickTip, 63
 - N2851A QuickTip, 62
 - N2880A attenuators, 25
 - N2880A InfiniiMax In-Line
 - Attenuator, 25
 - N2881A InfiniiMax DC Blocking
 - Caps, 29
 - N5380B, 59
 - N5450B cable, 24
- O**
- offset, 17
 - operating environment, 96
 - oscilloscope
 - compatible, 10
 - Infiniium, 10
 - InfiniiVision, 10
- P**
- performance verification, 207
 - pollution degree, 96
 - power requirements, 96
 - probe
 - dimensions, 98, 99
 - handling, 13
 - inspecting, 10
 - offset, 17
 - service, 35
 - probe amplifier, 15
 - probe cable, 14
 - probe calibration, 81
 - probe handling, 13
 - probe heads
 - disconnecting, 13
 - MX0100A, 38
- Q**
- QuickTip, 62
- R**
- returning for service, 35
- S**
- s parameter, 42
 - safety, 32
 - Safety Considerations, 32
 - safety warnings, 32
 - slew rate requirements, 19
 - slew rates, 19
 - socketed differential probe, 53, 73
 - solder-in differential, 51
 - solder-in differential probe, 69
 - solder-in single-ended
 - probe, 66, 71

Index

soldering toolkit, [30](#)
specifications, [93](#), [217](#)

T

temperature, [96](#)
temperature chamber, [24](#)
temperature ranges, [24](#)
trim gauge template, [43](#)

V

velcro dots, [16](#)

W

WEEE compliance, [97](#)
weight, [96](#)