PNA Series 2-Port and 4-Port Microwave Analyzer System - Operation & Installation Guide

N5290/1A 900 Hz - 110 GHz/ 900 Hz - 120 GHz

Use this manual in conjunction with the following documents:

- PNA Series Network Analyzer Embedded Help System

(Online at: <http://mktwww.srs.is.keysight.com/field/service/network/pna/>)

- PNA Series Network Analyzer Installation and Quick Start Guide Part Number E8356-90001

- N5290/1A Millimeter-Wave System Service Guide N5292-90026

Notices

© Keysight Technologies, Inc.
2009-2024

No part of this manual may be reproduced in any form or by any means (including electronic storage and retrieval or translation into a foreign language) without prior agreement and written consent from Keysight Technologies, Inc. as governed by United States and international copyright laws.

Trademark Acknowledgments

Manual Part Number

N5292-90002

Edition

Edition 1, May 2024

Printed in USA/Malaysia

Published by:

Keysight Technologies
1400 Fountaingrove Parkway
Santa Rosa, CA 95403

Warranty

THE MATERIAL CONTAINED IN THIS DOCUMENT IS PROVIDED "AS IS," AND IS SUBJECT TO BEING CHANGED, WITHOUT NOTICE, IN FUTURE EDITIONS. FURTHER, TO THE MAXIMUM EXTENT PERMITTED BY APPLICABLE LAW, KEYSIGHT DISCLAIMS ALL WARRANTIES, EITHER EXPRESS OR IMPLIED WITH REGARD TO THIS MANUAL AND ANY INFORMATION CONTAINED HEREIN, INCLUDING BUT NOT LIMITED TO THE IMPLIED WARRANTIES OF MERCHANTABILITY AND FITNESS FOR A PARTICULAR PURPOSE. KEYSIGHT SHALL NOT BE LIABLE FOR ERRORS OR FOR INCIDENTAL OR CONSEQUENTIAL DAMAGES IN CONNECTION WITH THE FURNISHING, USE, OR PERFORMANCE OF THIS DOCUMENT OR ANY INFORMATION CONTAINED HEREIN. SHOULD KEYSIGHT AND THE USER HAVE A SEPARATE WRITTEN AGREEMENT WITH WARRANTY TERMS COVERING THE MATERIAL IN THIS

DOCUMENT THAT CONFLICT WITH THESE TERMS, THE WARRANTY TERMS IN THE SEPARATE AGREEMENT WILL CONTROL.

Technology Licenses

The hardware and/or software described in this document are furnished under a license and may be used or copied only in accordance with the terms of such license.

U.S. Government Rights

The Software is "commercial computer software," as defined by Federal Acquisition Regulation ("FAR") 2.101. Pursuant to FAR 12.212 and 27.405-3 and Department of Defense FAR Supplement ("DFARS") 227.7202, the U.S. government acquires commercial computer software under the same terms by which the software is customarily provided to the public.

Accordingly, Keysight provides the Software to U.S. government customers under its standard commercial license, which is embodied in its End User License Agreement (EULA), a copy of which can be found at

<http://www.keysight.com/find/sweula>

The license set forth in the EULA represents the exclusive authority by which the U.S. government may use, modify, distribute, or disclose the Software. The EULA and the license set forth therein, does not require or permit, among other things, that Keysight: (1) Furnish technical information related to commercial computer software or commercial computer software documentation that is not customarily provided to the public; or (2) Relinquish to, or otherwise provide, the government rights in excess of these rights customarily provided to the public to use, modify, reproduce, release, perform, display, or disclose commercial computer software or commercial computer software documentation. No additional

government requirements beyond those set forth in the EULA shall apply, except to the extent that those terms, rights, or licenses are explicitly required from all providers of commercial computer software pursuant to the FAR and the DFARS and are set forth specifically in writing elsewhere in the EULA. Keysight shall be under no obligation to update, revise or otherwise modify the Software. With respect to any technical data as defined by FAR 2.101, pursuant to FAR 12.211 and 27.404.2 and DFARS 227.7102, the U.S. government acquires no greater than Limited Rights as defined in FAR 27.401 or DFARS 227.7103-5 (c), as applicable in any technical data.

Safety Notices

CAUTION

A **CAUTION** notice denotes a hazard. It calls attention to an operating procedure, practice, or the like that, if not correctly performed or adhered to, could result in damage to the product or loss of important data. Do not proceed beyond a CAUTION notice until the indicated conditions are fully understood and met.

WARNING

A **WARNING** notice denotes a hazard. It calls attention to an operating procedure, practice, or the like that, if not correctly performed or adhered to, could result in personal injury or death. Do not proceed beyond a WARNING notice until the indicated conditions are fully understood and met.

Contents

1. Safety and Regulatory Information

| | |
|---|------|
| Information in This Chapter | 1-1 |
| Chapter One at-a-Glance | 1-1 |
| Safety Symbols | 1-2 |
| General Safety Considerations | 1-3 |
| Safety Earth Ground | 1-3 |
| Before Applying Power | 1-3 |
| Servicing | 1-5 |
| Electrostatic Discharge Protection | 1-7 |
| ESD Equipment Required for the Installation | 1-8 |
| Regulatory Information | 1-9 |
| Instrument Markings | 1-9 |
| Lithium Battery Disposal | 1-11 |
| EMC and Safety Information | 1-11 |
| Acoustic Statement: (European Machinery Directive) | 1-12 |
| N5292A Test Set Equipment Ratings | 1-13 |
| Environmental Requirements | 1-14 |
| System Heating and Cooling | 1-14 |
| Required Conditions for Accuracy Enhanced Measurement | 1-15 |
| Space Requirements | 1-16 |
| N5290/1A System Weight and Dimensions | 1-16 |
| Component Weight and Dimensions | 1-16 |
| Site Preparation | 1-18 |
| Power Requirements | 1-18 |

2. System Description

| | |
|---|------|
| Information in This Chapter | 2-1 |
| Chapter Two at-a-Glance | 2-1 |
| N5290/1A Network Analyzer Millimeter-wave System | 2-2 |
| System Description | 2-5 |
| Introduction | 2-5 |
| Network Analyzer Requirements | 2-6 |
| System Configurations | 2-7 |
| System Contents | 2-7 |
| N5290A and N5291A Millimeter System Interconnect Kits | 2-10 |
| N5290A and N5291A Millimeter System Rackmount Kits | 2-17 |
| N5290A and N5291A Millimeter System Optional Parts | 2-17 |
| N5292A Test Controller Description | 2-18 |

| | |
|--|------|
| Front Panel Features | 2-18 |
| IF Ref Out. | 2-19 |
| IF Test Out | 2-19 |
| 1 / 2/ 3/ 4 (Integrated Connector) | 2-19 |
| Source In | 2-19 |
| Low Band. | 2-19 |
| On/Standby Power Switch | 2-19 |
| Active LED | 2-19 |
| Rear Panel Features | 2-20 |
| IF OUTPUTS – SMA (female). | 2-20 |
| LO IN | 2-20 |
| Test Set I/O | 2-20 |
| Line Module. | 2-20 |
| Power Cords | 2-20 |
| Compatible Millimeter-Wave Modules | 2-21 |
| N5293/5A Millimeter-Wave Test Head Modules | 2-22 |
| Active LED | 2-22 |
| Basic System Measurement Configurations | 2-25 |
| Coaxial Measurement | 2-25 |

3. System Installation

| | |
|--|------|
| Information in This Chapter | 3-1 |
| Chapter Three at-a-Glance | 3-1 |
| Getting Prepared | 3-2 |
| Tools Required for the Installation | 3-2 |
| About Installing the System | 3-2 |
| Getting Assistance from Keysight | 3-3 |
| Contacting Keysight | 3-3 |
| Receiving the System | 3-4 |
| Receiving the System | 3-4 |
| Keysight Technologies Customer Engineering | 3-4 |
| Review the Principles of Connector Care | 3-5 |
| PNA, Controller, and Test Head Module Interconnections | 3-6 |
| System Setup. | 3-6 |
| Mounting a Network Analyzer on the Test Set | 3-6 |
| N5290/1A Option 201 (Interconnect Kit N5292-60012) | 3-14 |
| N5290/1A Option 202 (Interconnect Kit N5292-60013) | 3-15 |
| N5290/1A Option 401 or N5290/1A Option 402–(Interconnect Kit N5292-60016). | 3-17 |
| N5290/1A Option 403–(Interconnect Kit N5292-60017) | 3-18 |
| Rear Panel Cabling | 3-20 |
| N5293/5A Modules Front Panel Cabling | 3-22 |
| Connections for Each Head | 3-22 |
| N5292A Option 200 2–Port Cable Connections. | 3-23 |

| | |
|---|------|
| N5292A Option 400 4-Port Cable Connections | 3-24 |
| | 3-24 |
| Initializing the N5290/1A Broadband System | 3-25 |
| Running the Installation Calibration | 3-27 |
| Troubleshooting the N5293/5A Millimeter Modules | 3-30 |
| | |
| 4. Performance Verification | |
| Information in This Chapter | 4-1 |
| Chapter Four at-a-Glance | 4-1 |
| Preliminary Checks | 4-2 |
| System Operator's Check | 4-3 |
| Accessories Used in the Operator's Check | 4-3 |
| Performing the Operator's Check | 4-3 |
| If the Operator's Check Fails | 4-6 |
| System Verification | 4-7 |
| What the System Verification Verifies | 4-7 |
| Measurement Uncertainty | 4-7 |
| Measurement Traceability | 4-8 |
| Performing System Verification | 4-10 |
| Equipment Used in the System Verification Procedure | 4-11 |
| Cable Substitution | 4-11 |
| Kit Substitution | 4-11 |
| System Verification Procedure | 4-11 |
| If the System Fails the Verification Test | 4-13 |
| Interpreting the Verification Results | 4-14 |
| If the System Verification Fails | 4-17 |
| | |
| 5. Maintenance and Support | |
| Information in This Chapter | 4-1 |
| Chapter Five at-a-Glance | 4-1 |
| Maintenance | 4-2 |
| Physical Maintenance | 4-2 |
| Electrical Maintenance | 4-2 |
| Caring for Waveguide (WG) Interfaces | 4-2 |
| Principles of Connector Care | 4-2 |
| Replacement Parts | 4-4 |
| Keysight Support, Services, and Assistance | 4-5 |
| Service and Support Options | 4-5 |
| Contacting Keysight | 4-5 |
| Shipping an Item to Keysight for Service or Repair | 4-6 |
| Downloading the Online PNA Millimeter-Wave Service Guides | 4-6 |

1 Safety and Regulatory Information

Information in This Chapter

This chapter provides safety information that will help protect you and your system's equipment. It also contains information that is required by various government regulatory agencies.

Chapter One at-a-Glance

| Section Title | Summary of Content |
|---|--|
| “Safety Symbols” on page 2 | Descriptions of CAUTION and WARNING symbols used throughout this manual. |
| “General Safety Considerations” on page 3 | A list of safety points to consider when servicing your network analyzer. |
| “Electrostatic Discharge Protection” on page 7 | A discussion of electrostatic discharge (ESD) and related recommendations and requirements for ESD protection. Also, includes a table of ESD equipment part numbers. |
| “Regulatory Information” on page 9 | Definitions of instrument markings. Instructions for disposing of the analyzer's lithium battery. |
| “N5292A Test Set Equipment Ratings” on page 13 | Describes the voltage, frequency, and power ratings of your N5292A test controller |
| “Environmental Requirements” on page 14 | Descriptions of the environmental requirements that are characteristic for a system based on the limitations of the PNA network analyzer |
| “Space Requirements” on page 16 | Describes the N5290/1A System weight and dimensions |
| “Site Preparation” on page 18 | Describes power requirement-related information for your N5290/1A System. |

Safety Symbols

The following safety symbols are used throughout this manual. Familiarize yourself with each of the symbols and its meaning before operating this instrument.

CAUTION

Caution denotes a hazard. It calls attention to a procedure that, if not correctly performed or adhered to, could result in damage to or destruction of the instrument. Do not proceed beyond a caution note until the indicated conditions are fully understood and met.

WARNING

Warning denotes a hazard. It calls attention to a procedure which, if not correctly performed or adhered to, could result in injury or loss of life. Do not proceed beyond a warning note until the indicated conditions are fully understood and met.

General Safety Considerations

Safety Earth Ground

WARNING

This is a Safety Class I product (provided with a protective earthing ground incorporated in the power cord). The mains plug shall only be inserted in a socket outlet provided with a protective earth contact. Any interruption of the protective conductor, inside or outside of the instrument, will make the instrument dangerous. Intentional interruption is prohibited.

WARNING

The Mains wiring and connectors shall be compatible with the connector used in the premise electrical system. Failure, to ensure adequate earth grounding by not using the correct components may cause product damage, and serious injury.

CAUTION

Always use the three-prong AC power cord supplied with this product. Failure to ensure adequate grounding by not using this cord may cause product damage.

Before Applying Power

WARNING

This product has been designed and tested in accordance with accepted industry standards, and has been supplied in a safe condition. The documentation contains information and warnings that must be followed by the user to ensure safe operation and to maintain the product in a safe condition.

WARNING

If this product is not used as specified, the protection provided by the equipment could be impaired. This product must be used in a normal condition (in which all means for protection are intact) only.

WARNING

If an instrument handle is damaged, you should replace it immediately. Damaged handles can break while you are moving or lifting the instrument and cause personal injury or damage to the instrument.

WARNING

Supply voltages which oscillate between the two normal input ranges of the autoranging line voltage input will damage the power supply. In rare cases, this damage has become a user safety concern. If unstable power levels are expected, the analyzer input power must be buffered by a line conditioner.

CAUTION

This product is designed for use in Installation Category II and Pollution Degree 2 per IEC standards.

CAUTION

Before switching on this instrument, make sure

- the correct rating service breaker.
 - the supply voltage is in the specified range
-

CAUTION

This instrument has auto-ranging line voltage input, be sure the supply voltage is within the specified range and voltage fluctuations do not to exceed 10 percent of the nominal supply voltage.

CAUTION

Do not operate the analyzer with the outer cover removed for more than 30 minutes, as this could cause the analyzer to overheat which could result in costly damage.

CAUTION

Ventilation Requirements: When installing the product in a cabinet, the convection into and out of the product must not be restricted. The ambient temperature (outside the cabinet) must be less than the maximum operating temperature of the instrument by 4 °C for every 100 watts dissipated in the cabinet. If the total power dissipated in the cabinet is greater than 800 watts, then forced convection must be used.

Servicing

WARNING

These servicing instructions are for use by qualified personnel only. To avoid electrical shock, do not perform any servicing unless you are qualified to do so.

WARNING

Danger of explosion if battery is incorrectly replaced. Replace only with the same or equivalent type recommended. Discard used batteries according to local ordinances and/or manufacturer's instructions.

WARNING

Procedures described in this document may be performed with power supplied to the product while protective covers are removed. Energy available at many points may, if contacted, result in personal injury.

WARNING

The power cord is connected to internal capacitors that may remain live for 10 seconds after disconnecting the plug from its power supply.

WARNING

Install the instrument so that the detachable power cord is readily identifiable and is easily reached by the operator. The detachable power cord is the instrument disconnecting device. It disconnects the mains circuits from the mains supply before other parts of the instrument. The front panel switch is only a standby switch and is not a LINE switch. Alternatively, an externally installed switch or circuit breaker (which is readily identifiable and is easily reached by the operator) may be used as a disconnecting device.

CAUTION

Do not operate the analyzer with the outer cover removed for more than 30 minutes, as this could cause the analyzer to overheat which could result in costly damage.

WARNING

The opening of covers or removal of parts may expose dangerous voltages. Disconnect the instrument from all voltage sources while it is being opened.

NOTE

There are no replaceable fuses in the mains input or within the power supply assembly.

NOTE

Keysight personnel: after calibration is completed, attach four "calibration void if seal broken" stickers to the PNA as shown in [Figure 1-1](#).

Figure 1-1 Example of a Calibration Sticker on a PNA

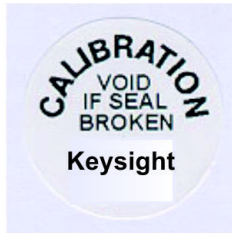

Install 4x calibration stickers where shown below

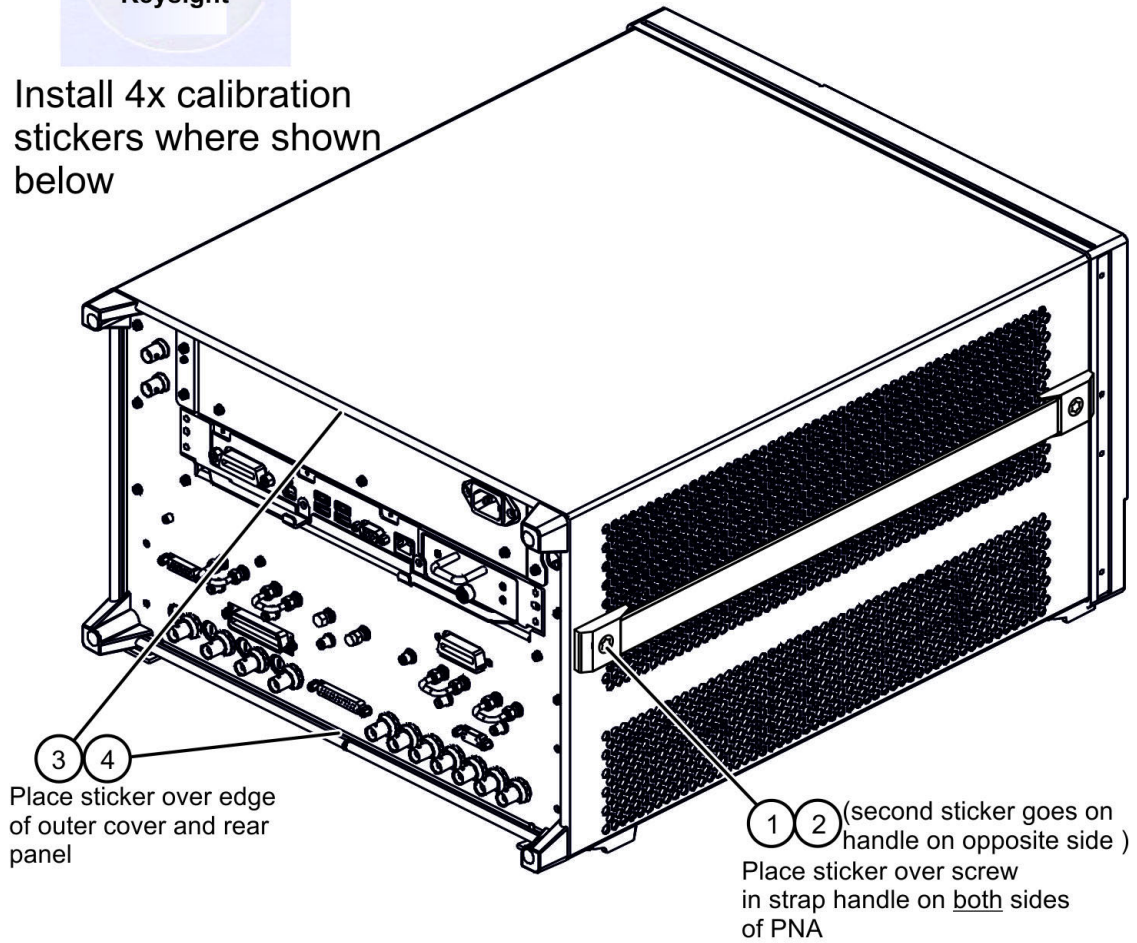

cal void sticker

Electrostatic Discharge Protection

This is important. If not properly protected against, electrostatic discharge can seriously damage your analyzer, resulting in costly repair.

Protection against electrostatic discharge (ESD) is essential while removing assemblies from or connecting cables to the network analyzer. Static electricity can build up on your body and can easily damage sensitive internal circuit elements when discharged. Static discharges too small to be felt can cause permanent damage. To prevent damage to the instrument:

- **always** have a grounded, conductive table mat in front of your test equipment.
- **always** wear a grounded wrist strap, connected to a grounded conductive table mat, having a 1 M Ω resistor in series with it, when handling components and assemblies or when making connections.
- **always** wear a heel strap when working in an area with a conductive floor. If you are uncertain about the conductivity of your floor, wear a heel strap.
- **always** ground yourself before you clean, inspect, or make a connection to a static-sensitive device or test port. You can, for example, grasp the grounded outer shell of the test port or cable connector briefly.
- **always** ground the center conductor of a test cable before making a connection to the analyzer test port or other static-sensitive device. This can be done as follows:
 1. Connect a short (from your calibration kit) to one end of the cable to short the center conductor to the outer conductor.
 2. While wearing a grounded wrist strap, grasp the outer shell of the cable connector.
 3. Connect the other end of the cable to the test port and remove the short from the cable.

Figure 1-2 shows a typical ESD protection setup using a grounded mat and wrist strap. Refer to **“Electrostatic Discharge Protection” on page 1-7** for part numbers.

Figure 1-2 ESD Protection Setup

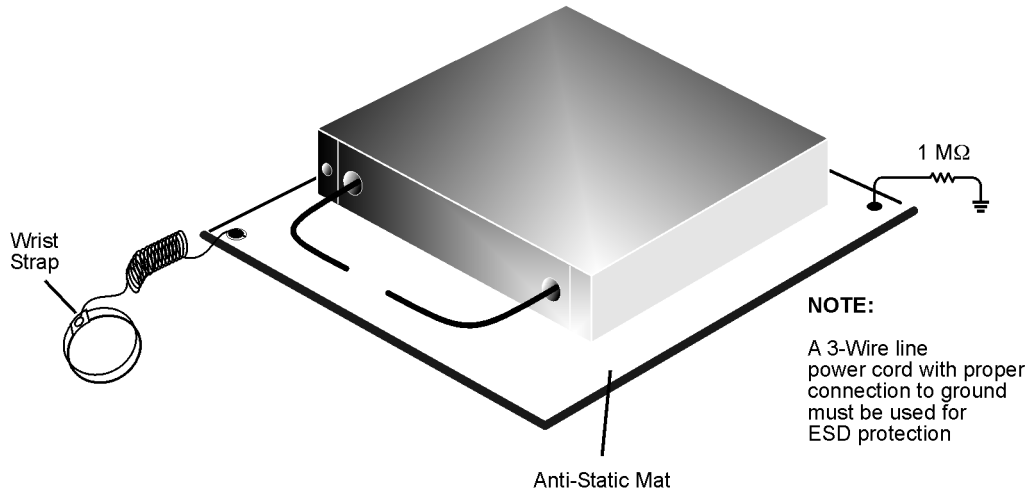

esd_setup

ESD Equipment Required for the Installation

| Description | Keysight Part Number |
|--|----------------------|
| ESD grounding wrist strap | 9300-1367 |
| 5-ft grounding cord for wrist strap | 9300-0980 |
| 2 x 4 ft conductive table mat and 15-ft grounding wire | 9300-0797 |
| ESD heel strap (for use with conductive floors) | 9300-1308 |

Regulatory Information











This section contains information that is required by various government regulatory agencies.

Instrument Markings











The table below lists the definitions of markings that may be on or with the product. Familiarize yourself with each marking and its meaning before operating the instrument.



NOTE

Some instrument markings may not appear on your analyzer.

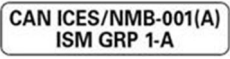
| | |
|---|--|
|  | This symbol marks the standby position of the power line switch. |
|  | This symbol marks the ON position of the power line switch. |
|  | This symbol marks the OFF position of the power line switch. |
|  | This symbol indicates the input power required is AC. |
|  | This symbol indicates DC voltage. |
|  | This symbol indicates a three-phase alternating current. |
|  | This symbol indicates frame or chassis terminal. |
|  | The instruction documentation symbol. The product is marked with this symbol when it is necessary for the user to refer to the instruction in the documentation. |
|  | This symbol indicates the presence of a laser device. |
|  | This symbol indicates that the surface can be hot. |

Safety and Regulatory Information
Regulatory Information

| | |
|---|--|
|  | This symbol indicated the product is sensitive to electrostatic discharge. |
|  | This symbol identifies the Protective Conductor Terminal. |
|  | This symbol indicates the equipment is protected throughout by double or reinforced insulation. |
|  | The CE marking is a registered trademark of the European Community (if accompanied by a year, it is the year when the design was proven). It indicates that the product complies with all relevant directives. |
|  | UK conformity mark is a UK government owned mark. Products showing this mark comply with all applicable UK regulations. |
|  | The Keysight email address is required by EU directives applicable to our product. |
|  | The CSA mark is a registered trademark of the CSA international. |
| CAN ICES/NMB-001(A) | Canada EMC label. Interference-Causing Equipment Standard for industrial, scientific and medical (ISM) equipment. Matériel industriel, scientifique et médical (ISM). |
|  | CE/ICES/ISM label. This is a space-saver label that combines three markings – CE with CAN ICES (see above) and ISM (see below). |
|  | The RCM mark is a registered trademark of the Australian Communications and Media Authority. |
|  | This is a combined marking to indicate product compliance with the Industry Canadian Interference-Causing Equipment Standard (ICES/NMB-001). This is also a symbol of an Industrial Scientific and Medical Group 1 Class A product (CISPR 11, Clause 5). |
| ISM 1-A | This is a symbol of an Industrial Scientific and Medical Group 1 Class A product (CISPR 11, Clause 5). |
|  | This symbol identifies the Protective Conductor Terminal. |
|  | South Korean Certification (KC) mark. It includes the marking's identifier code. |

| | |
|---|--|
|  | The crossed-out wheeled bin symbol indicates that separate collection for waste electric and electronic equipment (WEEE) is required, as obligated by the EU DIRECTIVE and other National legislation. Please refer to www.keysight.com/go/takeback to understand your trade-in options with Keysight, in addition to product takeback instructions. |
|  | China Restricted Substance Product Label. The EPUP (environmental protection use period) number in the center indicates the time period during which no hazardous or toxic substances or elements are expected to leak or deteriorate during normal use and generally reflects the expected useful life of the product. |
|  | Universal recycling symbol. This symbol indicates compliance with the China standard GB 18455-2001 as required by the China RoHS regulations for paper/fiberboard packaging. |
| IP x y | This mark indicates product has been designed to meet the requirements of “IP x y”, where “x” is the solid particle protection and “y” is the liquid ingress protection. |

Lithium Battery Disposal

If the battery on your network analyzer’s CPU board needs to be disposed of, dispose of it in accordance with your country’s requirements. If required, you may return the battery to Keysight Technologies for disposal. Refer to **“Contacting Keysight” on page 4-5** for assistance.



DO NOT THROW BATTERIES AWAY BUT COLLECT AS SMALL CHEMICAL WASTE.

EMC and Safety Information

EMC Information

Complies with European EMC Directive 2014/30/EU

- IEC/EN 61326-1
- CISPR Pub 11 Group 1, Class A
- AS/NZS CISPR 11
- ICES/NMB-001

This ISM device complies with Canadian ICES-001.

Cet appareil ISM est conforme a la norme NMB-001 du Canada.

South Korean Class A EMC declaration:

This equipment has been conformity assessed for use in business environments. In a residential environment this equipment may cause radio interference.

- This EMC statement applies to the equipment only for use in business environment.

| 사용자 안내문 |
|---|
| <p><u>이 기기는 업무용 환경에서 사용할 목적으로 적합성평가를 받은 기기로서 가정용 환경에서 사용하는 경우 전파간섭의 우려가 있습니다.</u></p> |

※ 사용자 안내문은 "업무용 방송통신기자재"에만 적용한다.

Safety:

Complies with the essential requirements of the European Low Voltage Directive as well as current editions of the following standards (dates and editions are cited in the Declaration of Conformity):

- IEC/EN 61010-1
- Canada: CSA C22.2 No. 61010-1
- USA: UL std no. 61010-1

Acoustic Statement: (European Machinery Directive)

Acoustic noise emission

LpA <70 dB

Operator position

Normal operation mode per ISO 7779

To find a current Declaration of Conformity for a specific Keysight product, go to:

<http://www.keysight.com/go/conformity>

N5292A Test Set Equipment Ratings

Table 1-1 **N5292A Equipment Ratings**

| | |
|--------------------------------|------------------------|
| Nominal voltage and or range | 100/120 or 220/240 VAC |
| Nominal frequency and or range | 50/60 Hz |
| Power in watts, VA or current | 210 W MAX |

Environmental Requirements

CAUTION

Ventilation Requirements: When installing the product in a cabinet, the convection into and out of the product must not be restricted. The ambient temperature (outside the cabinet) must be less than the maximum operating temperature of the instrument by 4 °C for every 100 watts dissipated in the cabinet. If the total power dissipated in the cabinet is greater than 800 watts, then forced convection must be used.

The environmental requirements shown below are characteristic for the system and are based on the limitations of the PNA network analyzer used.

Table 1-2

N5290/1A Environmental Conditions (Operating)

| Environment | Temperature |
|--------------------------|---|
| Operation | 0 °C to 40 °C (41 °F to 104 °F) |
| Storage | -40 °C to +65 °C (-40 °F to 158 °F) |
| Measurement Calibration | 20 °C to 26 °C (68 °F to 79 °F) |
| Performance Verification | Temperature must be within 1 °C (1.8 °F) of the temperature at which the measurement calibration was performed. |
| Relative Humidity | Type tested at 95%, +40 °C (non-condensing) |
| Pressure Altitude | Type tested 0 to 4600 meters (~15,000 feet) |

Table 1-3

N5292A Environmental Conditions (Operating)

| Environment | Temperature |
|---|--|
| for indoor use only (unless specified otherwise.) | |
| Altitude up to | 4,600 meters |
| Temperature | 0 to 40 °C |
| Relative humidity | Type tested, 0 to 95% relative humidity, non-condensing up to 40°C |

System Heating and Cooling

Install air conditioning and heating, if necessary, to maintain the ambient temperature within the appropriate range (as given in the table above). Air conditioning capacity must be consistent with the BTU ratings given in [Table 1-1 on page 13](#) and [Table 1-2 on page 14](#).

Required Conditions for Accuracy Enhanced Measurement

Accuracy-enhanced (error-corrected) measurements require the ambient temperature of the N5290/1A to be maintained within ± 1 °C of the ambient temperature at calibration.

Space Requirements

Standard installation of the N5290/1A system includes configuration and installation of the system on a customer provided lab bench or table top of adequate size and strength.

N5290/1A System Weight and Dimensions

Table 1-4 N5290/1A System Weight and Dimensions

| Model | Weight | Required Benchttop Dimensions for the System | | |
|--------|--------------------|--|----------------|----------------|
| | | Clearance | Width | Depth |
| 2-Port | 60.1 kg (132 lb) | 48 cm (19 in) | 178 cm (70 in) | 114 cm (45 in) |
| 4-Port | 83.5 kg (183.2 lb) | 48 cm (19 in) | 178 cm (70 in) | 140 cm (55 in) |

Component Weight and Dimensions

Table 1-4 shows the maximum weight and dimensions of the N5290/1A system components. Refer also to **Table 1-5 on page 17** for test head module dimensions.

Safety and Regulatory Information
Space Requirements

Table 1-5 N5290/1A System Components Weights and Dimensions

| Model | Weight | Height | Width | Depth |
|---|----------------------------|--------------------------|----------------------------|----------------------------|
| N5222B, 2-Port PNA, Option 205 | 27 kg (60 lb) nominal | 27.91 cm (11.0 in) | 48.29 cm (19.0 in) | 57.8 cm (22.7 in) |
| N5227B, 2-Port PNA, Option 205 | 42.2 kg (93 lb) nominal | 27.91 cm (11.0 in) | 48.29 cm (19.0 in) | 64.96 cm (25.6 in) |
| N5242B, 4-Port PNA-X, Option 425 | 37 kg (82 lb) nominal | 27.91 cm (11.0 in) | 48.29 cm (19.0 in) | 57.8 cm (22.7 in) |
| N5242B, 4-Port PNA-X, Option 425 with Option 029 | 38 kg (84 lb) nominal | 27.91 cm (11.0 in) | 48.29 cm (19.0 in) | 57.8 cm (22.7 in) |
| N5247B, 4-Port PNA-X, Option 425 | 49 kg (108 lb) nominal | 27.91 cm (11.0 in) | 48.29 cm (19.0 in) | 64.96 cm (25.6 in) |
| N5292A millimeter- head controller, Option 200 or Option 400 | 9 kg (20 lbs) | 8.83 cm (3.47 inches) | 42.56 cm (16.75 inches) | 60.34 cm (23.75 inches) |
| N5293/95A Millimeter-wave test head module (each) – (cables not included) | 1.69 kg (3.73 lbs) | 9.00 cm (3.54 inches) | 7.29 cm (2.87 inches) | 16.73 cm (6.59 inches) |

Site Preparation

Install the instrument so that the detachable power cord is readily identifiable and is easily reached by the operator. An externally installed switch or circuit breaker (which is readily identifiable and is easily reached by the operator) should be used as the disconnecting device. The detachable power cord can also be used to disconnect the mains circuits from the mains supply before other parts of the instrument. The front panel switch is only a standby switch and is not a LINE switch.

Power Requirements

Before installing the system, be sure that the required ac power is available at all necessary locations.

- Three-wire power cables (which provide a safety ground) must be used with all instruments.
- Air-conditioning equipment (or other motor-operated equipment) should not be placed on the same ac line that powers the system.
- The table below lists the maximum VA ratings and BTU/hour ratings for all instruments in the system. This table can be used to determine both the electrical requirements and the air conditioning requirements of the system

Table 1-6 Power Requirements of the System

| Standard Equipment | | |
|-----------------------------------|---------------------------|---------------------------|
| Instrument | Maximum VA Rating | Maximum BTU/hour |
| N5222/27/42/47B | 350 | 1195 |
| N5292A millimeter head controller | 210 | 717 |
| N5293A millimeter head (x2) | (powered from controller) | (powered from controller) |
| N5295A millimeter head (x2) | (powered from controller) | (powered from controller) |
| Total (N5222/27/42/47B) | 560 | 1912 |

NOTE

Values are based on 120 Vac supplied to each instrument at 60 Hz.
The N5292A millimeter head controller supplies power to the test head modules.

Safety and Regulatory Information
Site Preparation

2 System Description

Information in This Chapter

This chapter describes your 2-port or 4-port N5290/1A millimeter system and the system's installation procedure(s).

Chapter Two at-a-Glance

| Section Title | Summary of Content |
|--|--|
| “N5290/1A Network Analyzer Millimeter-wave System” on page 2 | Overview of the N5290/1A System. |
| “N5292A Test Controller Description” on page 18 | N5292A test set controller description of front and rear panel features. |
| “Compatible Millimeter-Wave Modules” on page 21 | N5293/5A millimeter heads description of the module's features. |
| “Basic System Measurement Configurations” on page 25 | N5290/1A Basic measurement configurations. |

N5290/1A Network Analyzer Millimeter-wave System

The N5290/1A is a 2-port or 4-port vector network analyzer system (N5290/1A) with an extremely wide frequency range of 900 Hz to 110 GHz or 900 Hz to 120 GHz (N5291A). The N5290/1A uses the same 1.0 mm test port connections throughout its entire range of test frequencies. It is never necessary to make and break connections to complete a test.

The illustration below shows the N5290A configured for coaxial measurement. The system can also be configured for on-wafer measurement using a wafer probe test station. (Optional individual N5290A302 Extender Desktop Positioners for each millimeter head are shown below the N5290A system image). Refer to **Figure 2-1 on page 3**. Contact Keysight for information. Refer to **“Contacting Keysight” on page 4-5.**)

Figure 2-1 N5290A 2-Port Test System – Coaxial Measurement Configuration (N5291A is similar.)

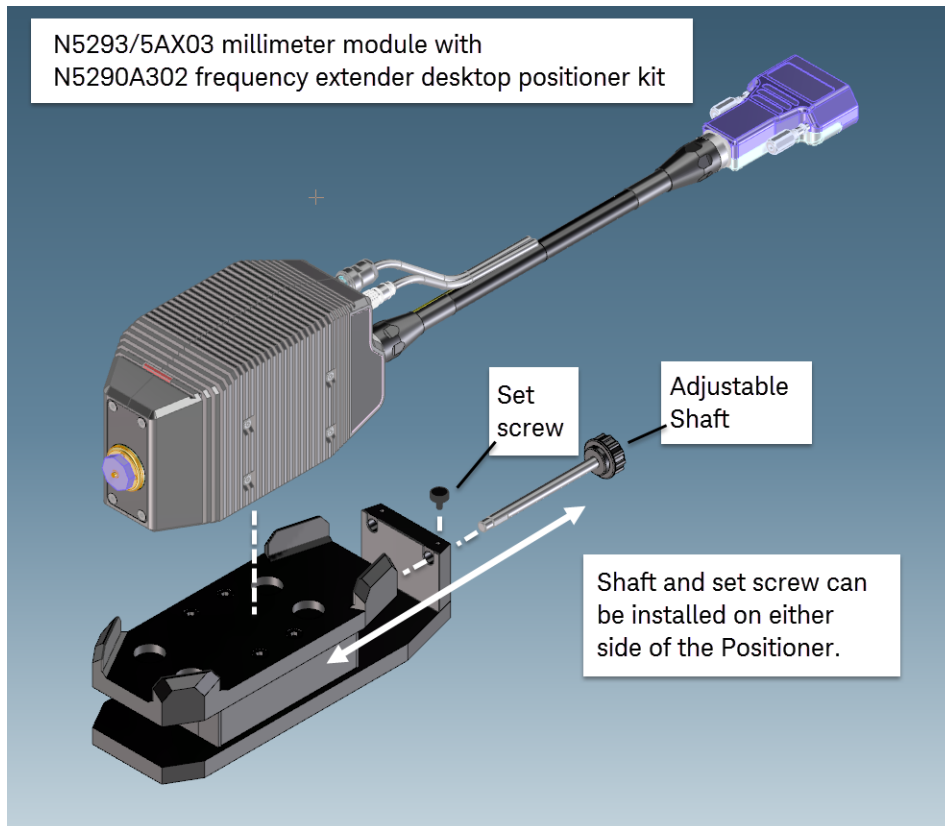
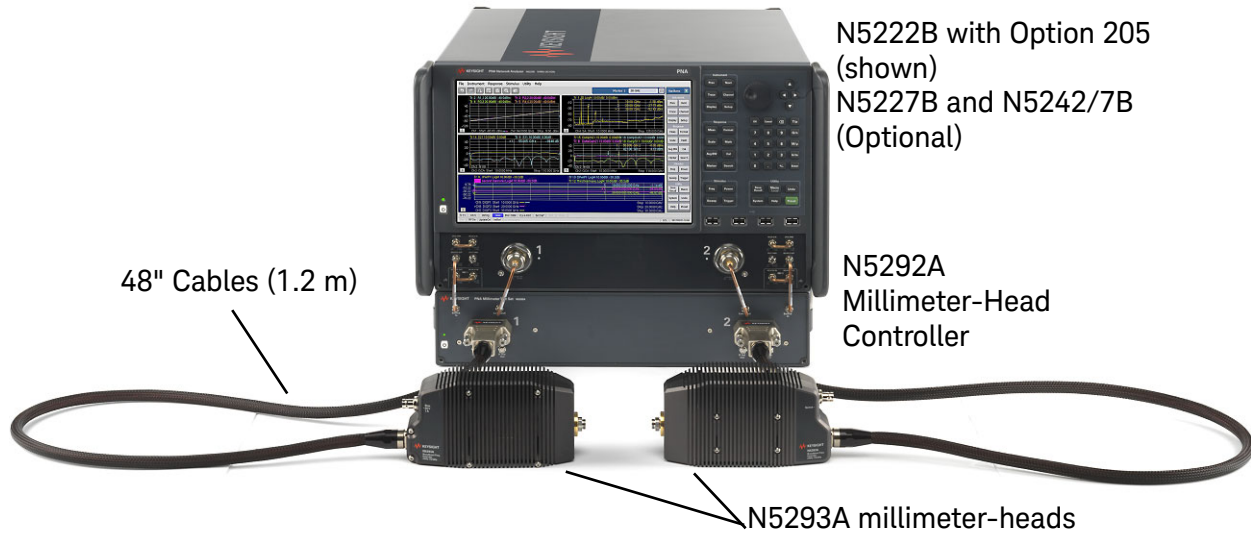
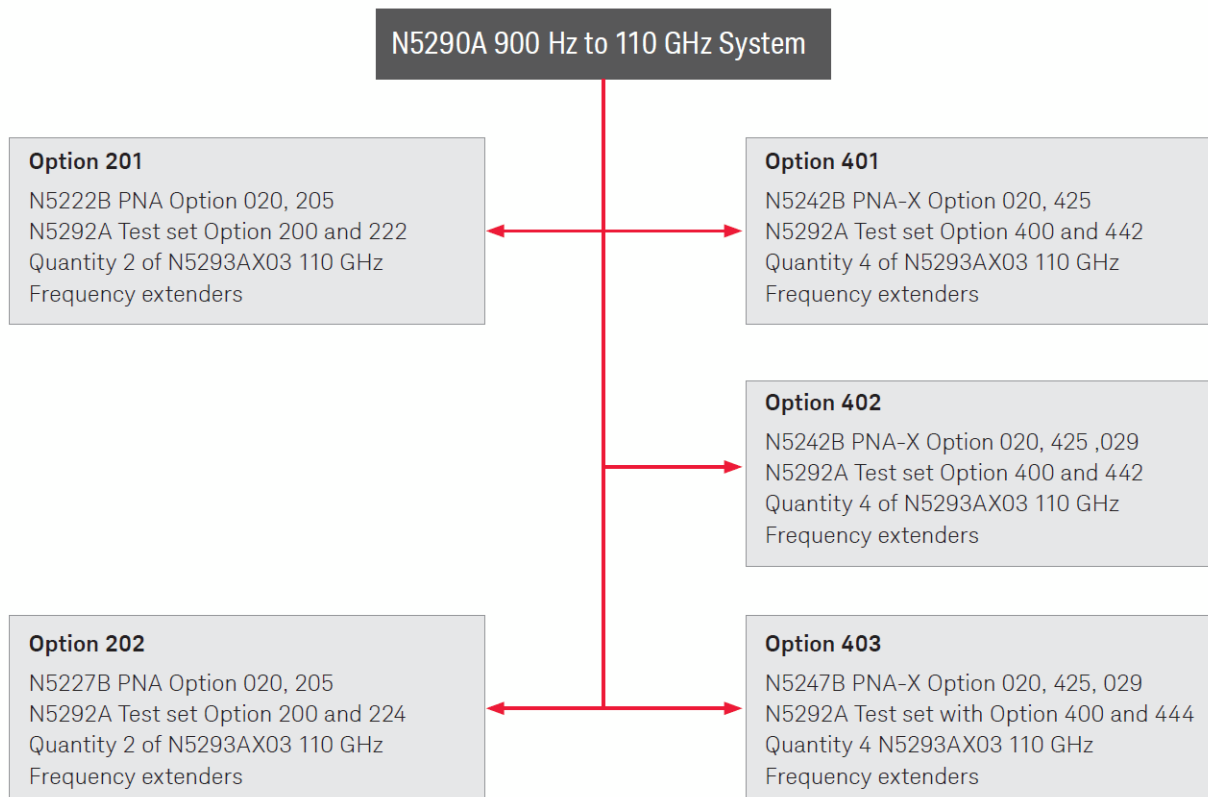
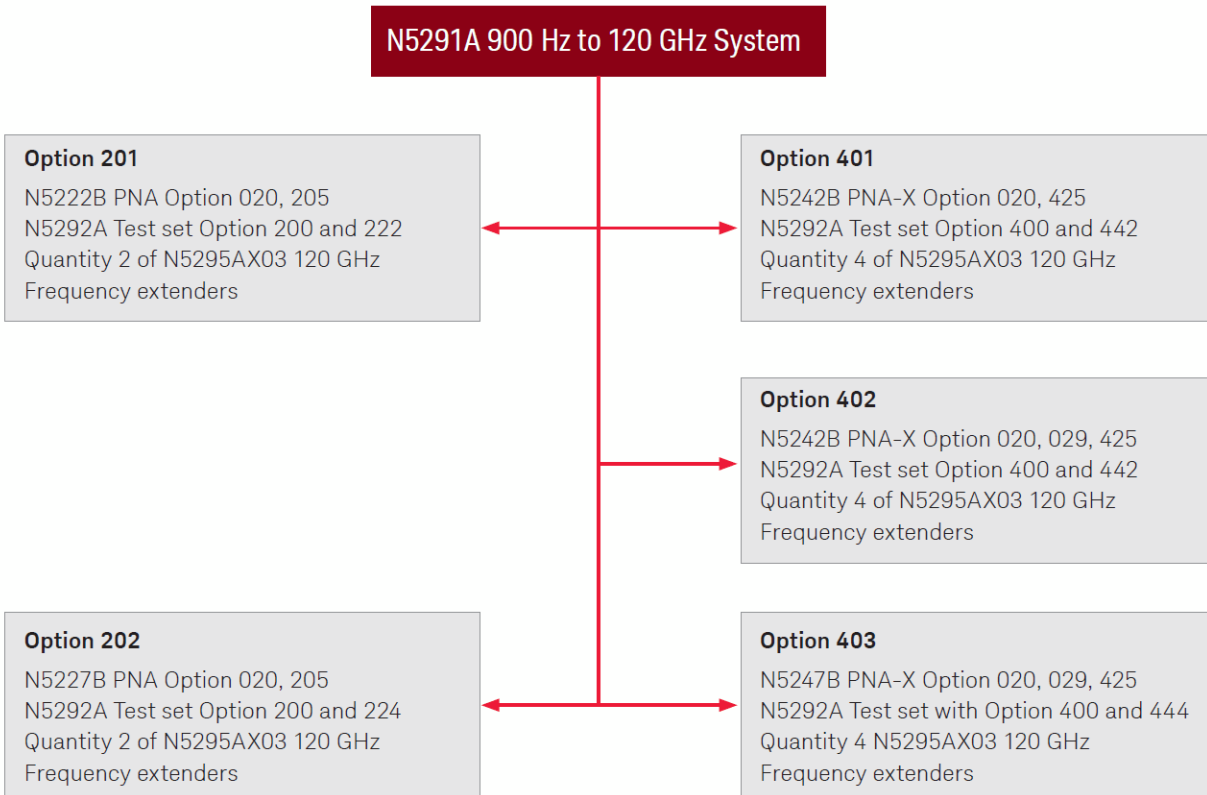

Figure 2-2 N5290A System Options



Note: For details or to add other PNA or PNA-X options to the above listed minimum configuration please refer to the PNA Family Configuration Guide (literature number 5992-1465EN).

Figure 2-3 N5291A System Options



Note: For details or to add other PNA or PNA-X options to the above listed minimum configuration please refer to the PNA Family Configuration Guide (literature number 5992-1465EN).

System Description

Introduction

This section of this document describes the broadband millimeter-wave system using an N5292A Millimeter Head Controller. Banded millimeter-wave systems are made up of three types of major components: a PNA or PNA-X, a controller test set, and millimeter-wave heads. These components are assembled into a system at the customer's site. This section of the document focuses on receiving the controller with accessories and then on system installation and operation.

Table 2-1 on page 2-7 and **Table 2-2 on page 2-7** list compatible PNA and PNA-X models with required options. **Table 2-3 on page 2-8** and **Table 2-4 on page 2-9** list available millimeter-wave modules. Typical system configurations are pictured in **Figure 2-4 on page 6** and **Figure 2-5 on page 6**.

The N5292A Millimeter Head Controller is also used as part of the N5290/1A broadband analyzer system. Refer to **"N5292A Test Controller Description" on page 2-18**

In this document the N5292A will be referred to as the test set.

Figure 2-4 2-Port Banded Millimeter-wave Configuration (N5290/1A Option 201/2)



Figure 2-5 4-Port Banded Millimeter-wave Configuration (N5290/1A Option 401/2/3)



Network Analyzer Requirements

The required options for PNA models are indicated in the “PNA Option(s)” column of [Table 2-1 on page 2-7](#). The required options for PNA-X models are indicated in the “PNA Option(s)” column of [Table 2-2 on page 2-7](#).

The minimum firmware revision for PNA and PNA-X models is A.12.80.

System Configurations

Table 2-1 and **Table 2-2** document all supported configurations for S-Parameter measurement capabilities for mm-wave systems using the N5292A Option 200 and N5292A Option 400 test set controllers.

Table 2-1 PNA Based Configurations

| PNA Model(s) | Required Options | Test Set Controller | Interconnect Kit |
|---------------|------------------|---------------------|------------------|
| N5222B 2-Port | 205 | N5292A-200 | N5292A-222 |
| N5227B 2-Port | 205 | N5292A-200 | N5292A-224 |

Table 2-2 PNA-X Based Configurations

| PNA-X Model(s) | Required Options | Test Set Controller | Interconnect Kit |
|----------------|------------------|---------------------|------------------|
| N5242B 4-Port | 425 | N5292A-400 | N5292A-442 |
| N5247 4-Port | 425 with 029 | N5292A-400 | N5292A-444 |

System Contents

Use the tables below to verify that the shipment is complete. These are items that are supplied with all complete N5290/1A systems. A complete system is shipped in multiple containers. Be sure to open all containers when verifying that every system component has been received.

To verify the contents shipped with your product, refer to the “Box Content List” included with the shipment. For a list of option components, refer to **Table 2-3 on page 2-8** through **Table 2-6 on page 2-12**.

Inspect the shipping container. If the container or packing material is damaged, it should be kept until the contents of the shipment have been checked mechanically and electrically. If there is physical damage refer to **“Contacting Keysight” on page 4-5**. Keep the damaged shipping materials (if any) for inspection by the carrier and an Keysight Technologies representative.

CAUTION

To reduce the chance of electrostatic discharge, follow all of the recommendations outlined in **“Electrostatic Discharge Protection” on page 1-7**.

Table 2-3 N5290A System Contents

| N5290A System | | | | | |
|---|---|------------|------------|------------|------------|
| Contents | Option 201 | Option 202 | Option 401 | Option 402 | Option 403 |
| N5222B 2-Port PNA, Option 205 | 1 | -- | -- | -- | -- |
| N5227B 2-Port PNA, Option 205 | -- | 1 | -- | -- | -- |
| N5242B 4-Port PNA-X, Option 425 | -- | -- | 1 | -- | -- |
| N5242B 4-Port PNA-X, Option 425 with Option 029 | -- | -- | -- | 1 | -- |
| N5247B 4-Port PNA-X, Option 425 with Option 029 | -- | -- | -- | -- | 1 |
| N5293AX03 mmW Modules | 2 | 2 | 4 | 4 | 4 |
| N5292A Option 200 | 1 | 1 | -- | -- | -- |
| N5292A Option 400 | -- | -- | 1 | 1 | 1 |
| Interconnect Kits | 1 – Depends on the N5290A System Option ordered with your N5290A System - Refer to Table 2-8 on page 2-17 . | | | | |

Table 2-4 N5291A System Contents

| N5291A System | | | | | |
|---|---|------------|------------|------------|------------|
| Contents | Option 201 | Option 202 | Option 401 | Option 402 | Option 403 |
| N5222B 2-Port PNA, Option 205 | 1 | -- | -- | -- | -- |
| N5227B 2-Port PNA, Option 205 | -- | 1 | -- | -- | -- |
| N5242B 4-Port PNA-X, Option 425 | -- | -- | 1 | -- | -- |
| N5242B 4-Port PNA-X, Option 425 with Option 029 | -- | -- | -- | 1 | -- |
| N5247B 4-Port PNA-X, Option 425 with Option 029 | -- | -- | -- | -- | 1 |
| N5295AX03 mmW Modules | 2 | 2 | 4 | 4 | 4 |
| N5292A Option 200 | 1 | 1 | -- | -- | -- |
| N5292A Option 400 | -- | -- | 1 | 1 | 1 |
| Interconnect Kits | 1 – Depends on the Interconnect kit Option ordered with your N5291A System – Refer to Table 2-5 on page 2-10 . | | | | |

N5290A and N5291A Millimeter System Interconnect Kits

CAUTION

IMPORTANT!

The N5227B and N5247B interconnect kits contain 2.4 mm to 3.5 mm cables. It is important to connect the 2.4 mm end to the PNA and to connect the 3.5 mm end to the N5292A test set controller. Improper connections will result in damage to your instruments.

It is important to use two wrenches when connecting the semirigid cables to the 1/2/3/4 port 1.85 mm outputs front ports of the PNA to avoid stressing the connectors and causing damage to your PNA (i.e., the 2.4 mm cable end is compatible with the 1.85 mm connector of the PNA).

Figure 2-6

PNA RF Port Connector to N5292A Test Set Lo Band Connector (2.4 mm)

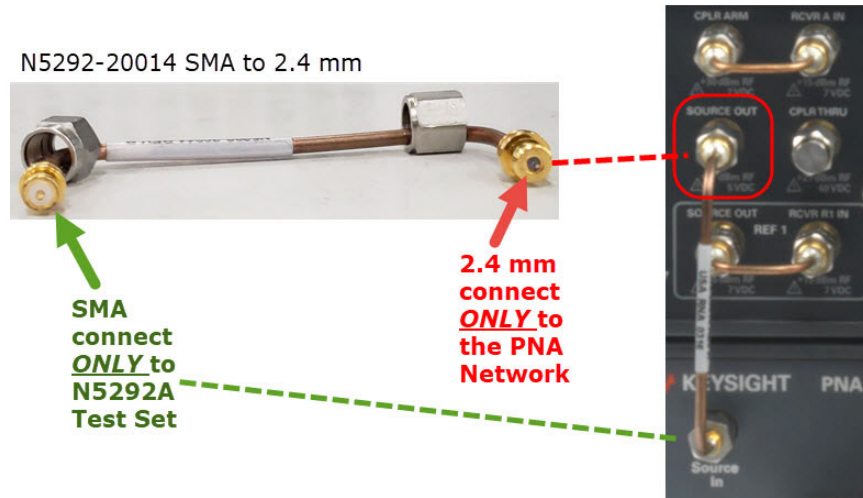

See also [Table 2-6](#) on page 2-12.

Table 2-5

N5290/1A PNA Millimeter-Wave System Options and Interconnect Kit Part Numbers

| N5290/1A System - Options and Interconnect Kit Part Numbers | | |
|---|--|-----------------------------------|
| N5290/1A Options | N5292A Test Set Interconnect Kit Options | Interconnect Kit Part Numbers |
| 201 | N5292A-222 | N5292-60012 (3.5 mm) |
| 202 | N5292A-224 | N5292-60013 (2.4 mm to 3.5 mm) |
| 401 | N5292A-442 | N5292-60016 (3.5 mm) |
| 402 | N5292A-442 | N5292-60016 (3.5 mm) |

Table 2-5

N5290/1A PNA Millimeter-Wave System Options and Interconnect Kit Part Numbers

| N5290/1A System - Options and Interconnect Kit Part Numbers | | |
|---|--|-----------------------------------|
| N5290/1A Options | N5292A Test Set Interconnect Kit Options | Interconnect Kit Part Numbers |
| 403 | N5292A-444 | N5292-60017 (2.4 mm to 3.5 mm) |

Table 2-6 N5290A/91A System Contents - Interconnect Kits: N5292-60012, N5292-60013, N5292-60014, N5292-60015, N5292-60016, and N5292-60017 (2 of 2)

| N5290A and N5291A Systems - Interconnect Kits | | | |
|---|---|-----|-------------|
| Ref Desig. | Description | Qty | Part Number |
| N5292-60012 - N5292A-222 (2-Port Test and 2-Port VNA with 3.5 mm Ports) and N5292-422 (4-Port Test Set and 2-Port VNA with 3.5 mm Ports) | | | |
| -- | Quick Start Poster (with links to Installation Guides & to the Critical Connector Care document) | 1 | N5292-90003 |
| -- | Chinese RoHS addendum for hardware | 1 | 9320-6724 |
| -- | Machine screw, M4 x 25 mm, pan head (to attach locking feet) | 4 | 0515-1619 |
| -- | Microwave Plug SMA Male Straight 50-Ohm, attached to network analyzer CPLR THRU | 2 | 1250-4261 |
| -- | Cable assy, coaxial 50 ohm SMA (m) to 50 ohm SMA (m) - 1S2 in long | 5 | 8121-2970 |
| -- | External cable assy 25-way D-sub | 1 | N4011-21002 |
| -- | Upper lock foot, right, long | 1 | N5240-20093 |
| -- | Upper lock foot, left, long | 1 | N5240-20094 |
| -- | Cable assy-RF, SMA to SMA 16 in long - 26.5 GHz | 1 | N5240-60092 |
| -- | Cable assy-RF, RF Source to Test Set | 2 | N5292-20006 |
| -- | Cable assy-RF, 2-Port, LFE Source to Test Set | 2 | N5292-20009 |
| -- | Lower lock foot, right | 1 | N5292-20012 |
| -- | Lower lock foot, left | 1 | N5292-20013 |
| N5292-60013 - N5292A-224 (2-Port Test Set with 2-Port VNA with 2.4 mm Ports) and N5292-424 (4 Port Test Set with 2-Port VNA with 2.4 mm Ports) | | | |
| -- | Quick Start Poster (with links to Installation Guides & to the Critical Connector Care document) | 1 | N5292-90003 |
| -- | Chinese RoHS addendum for hardware | 1 | 9320-6724 |
| -- | Machine screw, M4 x 25 mm, pan head (to attach locking feet) | 4 | 0515-1619 |
| -- | Connector-RF Termination 2.4mm Plug Straight 50-Ohm 50GHz-MAX, attached to network analyzer CPLR THRU | 2 | 0955-2394 |
| -- | Cable assy, coaxial 50 ohm SMA (m) to 50 ohm SMA (m) - 12 in long | 5 | 8121-2970 |

System Description
N5290/1A Network Analyzer Millimeter-wave System

Table 2-6 N5290A/91A System Contents - Interconnect Kits: N5292-60012, N5292-60013, N5292-60014, N5292-60015, N5292-60016, and N5292-60017 (2 of 2)

| N5290A and N5291A Systems - Interconnect Kits | | | |
|--|--|------------|--------------------|
| Ref Desig. | Description | Qty | Part Number |
| -- | External cable assy 25-way D-sub | 1 | N4011-21002 |
| -- | Upper lock foot, right, short | 1 | N5240-20092 |
| -- | Upper lock foot, left, short | 1 | N5240-20095 |
| -- | Cable assy-RF, SMA to SMA 16 in long – 26.5 GHz | 1 | N5240-60092 |
| -- | Lower lock foot, right | 1 | N5292-20012 |
| -- | Lower lock foot, left | 1 | N5292-20013 |
| -- | Cable assy-RF, RF Source to Test Set, SMA 2.4 mm | 2 | N5292-20014 |
| -- | Cable assy-RF, 2-Port, LFE Source to Test Set, SMA 2.4 mm | 2 | N5292-20017 |
| N5292-60014 - N5292A-242 (2-Port Test Set and 4-Port VNA with 3.5 mm Ports) | | | |
| -- | Quick Start Poster (with links to Installation Guides & to the Critical Connector Care document) | 1 | N5292-90003 |
| -- | Chinese RoHS addendum for hardware | 1 | 9320-6724 |
| -- | Machine screw, M4 x 25 mm, pan head (to attach locking feet) | 4 | 0515-1619 |
| -- | Microwave Plug SMA Male Straight 50-Ohm, attached to network analyzer CPLR THRU | 4 | 1250-4261 |
| -- | Cable assy, coaxial 50 ohm SMA (m) to 50 ohm SMA (m) - 12 in long | 5 | 8121-2970 |
| -- | External cable assy 25-way D-sub | 1 | N4011-21002 |
| -- | Upper lock foot, right, long | 1 | N5240-20093 |
| -- | Upper lock foot, left, long | 1 | N5240-20094 |
| -- | Cable assy-RF, SMA to SMA 16 in long – 26.5 GHz | 1 | N5240-60092 |
| -- | Cable assy-RF, RF Source to Test Set | 2 | N5292-20006 |
| -- | Cable assy-RF, 4-port, LFE Source to Test Set – A | 2 | N5292-20007 |
| -- | Lower lock foot, right | 1 | N5292-20012 |
| -- | Lower lock foot, left | 1 | N5292-20013 |
| N5292-60015 - N5292A-244 (2-Port Test Set and 4-Port VNA with 2.4 mm Ports) | | | |
| -- | Quick Start Poster (with links to Installation Guides & to the Critical Connector Care document) | 1 | N5292-90003 |

Table 2-6 N5290A/91A System Contents - Interconnect Kits: N5292-60012, N5292-60013, N5292-60014, N5292-60015, N5292-60016, and N5292-60017 (2 of 2)

| N5290A and N5291A Systems - Interconnect Kits | | | |
|--|---|------------|--------------------|
| Ref Desig. | Description | Qty | Part Number |
| -- | Chinese RoHS addendum for hardware | 1 | 9320-6724 |
| -- | Machine screw, M4 x 25 mm, pan head (to attach locking feet) | 4 | 0515-1619 |
| -- | Connector-RF Termination 2.4mm Plug Straight 50-Ohm 50GHz-MAX, attached to network analyzer CPLR THRU | 4 | 0955-2394 |
| -- | Cable assy, coaxial 50 ohm SMA (m) to 50 ohm SMA (m) - 12 in long | 5 | 8121-2970 |
| -- | External cable assy 25-way D-sub | 1 | N4011-21002 |
| -- | Upper lock foot, right, short | 1 | N5240-20092 |
| -- | Upper lock foot, left, short | 1 | N5240-20095 |
| -- | Cable assy-RF, SMA to SMA 16 in long - 26.5 GHz | 1 | N5240-60092 |
| -- | Lower lock foot, right | 1 | N5292-20012 |
| -- | Lower lock foot, left | 1 | N5292-20013 |
| -- | Cable assy-RF, RF Source to Test Set, SMA 2.4 mm | 2 | N5292-20014 |
| -- | Cable assy-RF, 4-Port, LFE to Test Set - A, SMA 2.4 mm | 2 | N5292-20015 |
| N5292-60016 - N5292A-442 (4-Port Test Set and 4-Port VNA with 3.5 mm Ports) | | | |
| -- | Quick Start Poster (with links to Installation Guides & to the Critical Connector Care document) | 1 | N5292-90003 |
| -- | Chinese RoHS addendum for hardware | 1 | 9320-6724 |
| -- | Machine screw, M4 x 25 mm, pan head (to attach locking feet) | 4 | 0515-1619 |
| -- | Microwave Plug SMA Male Straight 50-Ohm, attached to network analyzer CPLR THRU | 4 | 1250-4261 |
| -- | Cable assy, coaxial 50 ohm SMA (m) to 50 ohm SMA (m) - 12 in long | 5 | 8121-2970 |
| -- | External cable assy 25-way D-sub | 1 | N4011-21002 |
| -- | Upper lock foot, right, long | 1 | N5240-20093 |
| -- | Upper lock foot, left, long | 1 | N5240-20094 |
| -- | Cable assy-RF, SMA to SMA 16 in long - 26.5 GHz | 1 | N5240-60092 |
| -- | Cable assy-RF, RF Source to Test Set | 4 | N5292-20006 |

Table 2-6 N5290A/91A System Contents - Interconnect Kits: N5292-60012, N5292-60013, N5292-60014, N5292-60015, N5292-60016, and N5292-60017 (2 of 2)

| N5290A and N5291A Systems - Interconnect Kits | | | |
|---|---|-----|-------------|
| Ref Desig. | Description | Qty | Part Number |
| -- | Cable assy-RF, 4-port, LFE Source to Test Set - A | 2 | N5292-20007 |
| -- | Cable assy-RF, 4-port, LFE Source to Test Set - B | 2 | N5292-20008 |
| -- | Lower lock foot, right | 1 | N5292-20012 |
| -- | Lower lock foot, left | 1 | N5292-20013 |
| N5292-60017 - N5292A-444 (4-Port Test Set and 4-Port VNA with 2.4 mm Ports) | | | |
| -- | Quick Start Poster (with links to Installation Guides & to the Critical Connector Care document) | 1 | N5292-90003 |
| -- | Chinese RoHS addendum for hardware | 1 | 9320-6724 |
| -- | Machine screw, M4 x 25 mm, pan head (to attach locking feet) | 4 | 0515-1619 |
| -- | Connector-RF Termination 2.4mm Plug Straight 50-Ohm 50GHz-MAX, attached to network analyzer CPLR THRU | 4 | 0955-2394 |
| -- | Cable assy, coaxial 50 ohm SMA (m) to 50 ohm SMA (m) - 12 in long | 5 | 8121-2970 |
| -- | External cable assy 25-way D-sub | 1 | N4011-21002 |
| -- | Upper lock foot, right, short | 1 | N5240-20092 |
| -- | Upper lock foot, left, short | 1 | N5240-20095 |
| -- | Cable assy-RF, SMA to SMA 16 in long - 26.5 GHz | 1 | N5240-60092 |
| -- | Lower lock foot, right | 1 | N5292-20012 |
| -- | Lower lock foot, left | 1 | N5292-20013 |
| -- | Cable assy-RF, RF Source to Test Set, SMA 2.4 mm | 4 | N5292-20014 |
| -- | Cable assy-RF, 4-Port, LFE to Test Set - A, SMA 2.4 mm | 2 | N5292-20015 |
| -- | Cable assy-RF, 4-Port, LFE to Test Set - B, SMA 2.4 mm | 2 | N5292-20016 |

See also [Table 2-5 on page 2-10](#).

Table 2-7 Miscellaneous Parts

| Miscellaneous Parts | Part Number |
|-------------------------------|-------------|
| Performance Test Parts | |

Table 2-7 **Miscellaneous Parts**

| Miscellaneous Parts | Part Number |
|---|-------------|
| Connector-RF Termination 2.4mm Plug Straight 50-Ohm 50GHz-MAX ¹ (compatible with 1.85 mm connectors) | 0955-2394 |
| 3.5 mm 50 ohm terminations ¹ | 1250-4087 |

1. IMPORTANT! Performance tests will fail, if 50 ohm terminations are not installed on the test ports.

N5290A and N5291A Millimeter System Rackmount Kits

NOTE

N5290/1A system rackmount kits are going to be available soon. Refer to **“Contacting Keysight” on page 4-5.**

Use the table below to order rackmount kits.

Table 2-8 Rackmount Front Handle Kits

| √ | Keysight Part Number | Description | Qty |
|---|----------------------|--|-----|
| | 5063-1543 | Rackmount Kits for installation without handles - PNA | 1 |
| | 5063-1555 | Rackmount Kits for installation with handles - PNA | 1 |
| | ICM110A | Rackmount Kits for installation without handles - N5292A | 1 |
| | 1CP104A | Rackmount Kits for installation with handles - N5292A | 1 |

N5290A and N5291A Millimeter System Optional Parts

NOTE

N5290/1A system rackmount kits are going to be available soon. Refer to **“Contacting Keysight” on page 4-5.**

Use the table below to order optional accessories for your N5290/1A System.

Table 2-9 N5290A and N5291A Millimeter System Optional Parts

| √ | Keysight Part Number | Description | Qty |
|---|----------------------|--|-----|
| | N5290A301 | Frequency extender bias tee adapter kit | 1 |
| | N5290A302 | Frequency extender desktop positioner ¹ | 1 |

1. Refer to **Figure 2-1 on page 3.**

N5292A Test Controller Description

The N5292A-200 and N5292A-400 millimeter head controllers provide the test interface between the millimeter-wave test head modules and the PNA/PNA-X (PNA) series network analyzers.

The millimeter-head controller, when used in conjunction with the millimeter-wave test head modules and the PNA, provides all of the functions of a full S-Parameter test set.

The millimeter head controller supplies RF and LO signals to the millimeter-wave test head modules and returns the down converted reference and test IF signals to the PNA for processing and display. The N5292A-200 and N5292A-400 millimeter head controllers also supply the +12 volt bias to each millimeter-wave head module.

The front panels of the N5292A Option 200 and N5292A Option 400 millimeter head controllers are illustrated below.

See also **“Compatible Millimeter-Wave Modules”** on page 2-21.

Front Panel Features

Figure 2-7 N5292A Option 200 (2-Port) Front Panel Features



Figure 2-8 N5292A Option 400 (4-Port) Front Panel Features



IF Ref Out

IF reference output connection provides direct access to the IF signal from the module and is accessed by changing a switch setting in the millimeter wave dialog. This enables you to connect and to measure higher frequency IF output signals.

IF Test Out

IF test output connection provides direct access to the IF signal from the module and is accessed by changing a switch setting in the millimeter wave dialog. This enables you to connect and to measure higher frequency IF output signals.

1 / 2/ 3/ 4 (Integrated Connector)

Provides an integrated interface for the RF, LO, and IF signals to and from the millimeter wave modules.

NOTE

Ports 3 and 4 features are not present on the N5292A with Option 200. Refer to [Figure 2-5 on page 6](#).

Source In

Receives amplified RF signal to the millimeter-wave module's RF Input. Connects from the PNA's – SOURCE OUT to the corresponding N5292A Source In. This enables each port to have independent RF port power levels on all to 4-ports (if available).

Low Band

Receives an amplified LFE signal (900 Hz to 100 MHz) from the PNA's 1/2/3/4 ports that is combined with the main source signal in the test set and sent to the integrated connector. Requires PNA/PNA-X with Option 225 or 425.

On/Standby Power Switch

LED is green when the power is on and amber when in standby mode.

Active LED

When the test set is connected and addressed by an analyzer, the LED is On (illuminated). The LED is Off (not illuminated) when the test set is in Standby, or not addressed by the analyzer.

Rear Panel Features

Figure 2-9 N5292A Option 200 (2-Port) and 400 (4-Port) – Rear Panel Features



IF OUTPUTS – SMA (female)

- D (from the test set to the analyzer's IF D Input)
- C (from the test set to the analyzer's IF C Input)
- R (from the test set to the analyzer's IF R Input)
- A (from the test set to the analyzer's IF A Input)
- B (from the test set to the analyzer's IF B Input)

LO IN

This input is from the LO drive of the analyzer. The signal is split and amplified and then output to the front panel of the N5292A Option 200/400.

Test Set I/O

The test set interface connector is used digitally control to the test set from the analyzer.

Line Module

This assembly houses the line cord connection. Line voltage selection is automatic and no setting is required.

Power Cords

A line power cord is supplied in one of several configurations, depending on the destination of the original shipment. Keysight can supply additional certified power cords to meet region electrical supply and receptacle configurations. Please refer to our website at: www.keysight.com for assistance in power cord selection.

CAUTION

Verify that the premise electrical voltage supply is within the range specified on the instrument.

Compatible Millimeter-Wave Modules

Only Keysight N5293A and N5295A millimeter modules are compatible with the N5290A/1A Systems. If you have third party millimeter heads, and banded applications, refer to the N5292-90001 Self-configuration Installation Guide. Refer to **“N5293/5A Millimeter-Wave Test Head Modules” on page 2-22.**

Transmission/Reflection millimeter-wave modules contain an RF source multiplier, dual directional coupler, reference downconverter and a test downconverter. The Transmission/Reflection millimeter-wave module is usually the primary module of a millimeter-wave VNA system. A single Transmission/Reflection module allows the measurement of S11 reflection coefficient only. Refer to **Figure 2-10 on page 21.**

The use of two Transmission/Reflection modules in the millimeter-wave VNA system allows for all four S-parameters to be measured. The test downconverters of Transmission/Reflection modules are the receivers for the signal from the modules sources. When the two modules waveguide are connected, S11 and S21 are measured in the forward direction, S22 and S12 are measured when the signal path is reversed. If a 4-Port system is configured with Transmission/Reflection modules, all 16 S-parameter measurements can be made on a 4-Port device. Refer to **Figure 2-10 on page 21.**

Figure 2-10

Module Configurations

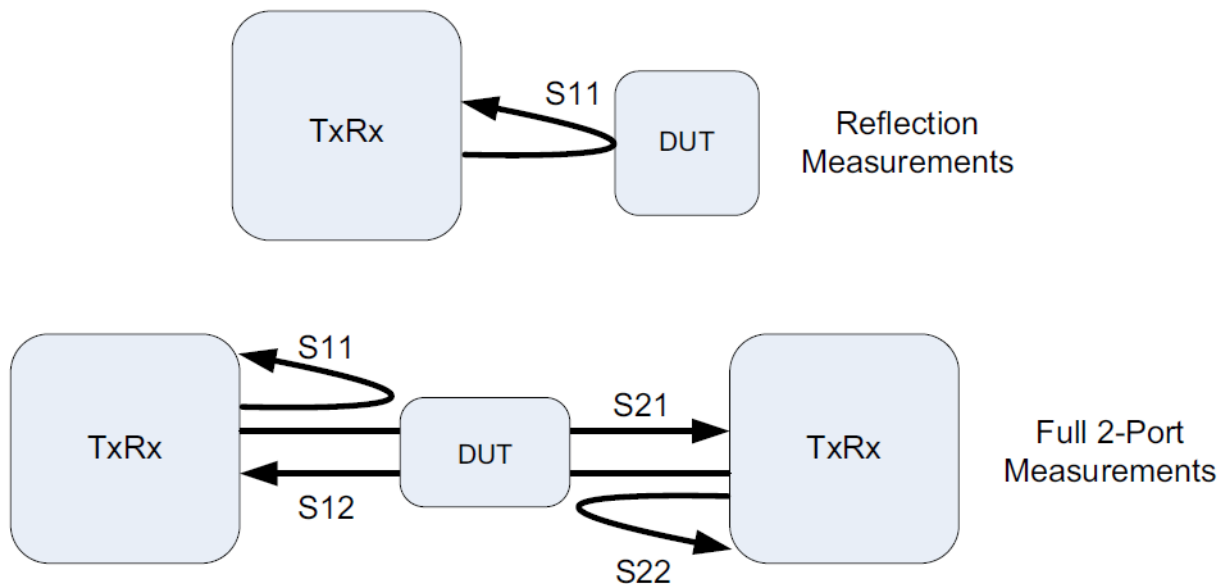

Table 2-10 Available N529xA Millimeter-Wave Head Modules

| Model # | Frequency Range |
|---------|-------------------|
| N5293A | 900 Hz to 110 GHz |
| N5295A | 900 Hz to 120 GHz |

Figure 2-11

N5293/N5295A Module Configurations

| N5293/5Xyz | |
|--------------------------------------|------------------------------------|
| y | z |
| Indicates the cable diameter: | Indicates the type of bias: |
| 0 - 1.0 mm | 1 - no bias combiner |
| 5 - 1.8 mm | 2 - pulsed bias¹ |
| | 3 - DC bias |

1. Pulsed bias modules have a 10 MHz start frequency.

N5293/5A Millimeter-Wave Test Head Modules

1, 2, 3, or 4 900 Hz -110 GHz or 900 Hz – 120 GHz millimeter-wave test head modules, in conjunction with the N5292A Option 200 or N5292A Option 400 millimeter head controller, is used to make reflection, transmission, or S-parameter measurements at millimeter-wave frequencies with the PNA. These test head modules are manufactured by Keysight.

NOTE

Ports 3 and 4 features are not present on the N5292A with Option 200. Refer to [Figure 2-5 on page 6](#).

The N5293/5A test head modules are illustrated in [Figure 2-12](#) and [Figure 2-13 on page 23](#). Each test head consists of a combiner assembly and a waveguide module. The combiner assembly contains a coupler and combiner, and a bias-tee. The N5292A Test Set Controller’s multiple-connector panels provide connections between the N5293/5A test head modules, the N5292A Option 200 or N5292A Option 400 millimeter head controller, and the N5222/7B PNA or N5242/7B PNA-X.

This section describes some of the features of the N5293/5A millimeter-Wave modules.

Active LED

When the millimeter-wave (mmW) module is connected and addressed by a N5292A Test Set Controller, the LED is On (blue). The LED is green when the mmW module is in Standby (not addressed by the N5292A). The LED is amber when the module is biased, but not active. The LED is red when the when the

System Description
Compatible Millimeter-Wave Modules

mmW module's optical sensor is not seated correctly, or the optical sensors are not clean, or the mmW module has another issue. The LED is Off (not illuminated) when the millimeter wave module is Off. Refer to [Figure 2-12](#).

Figure 2-12 N5293/5A Left and Right Frequency Extender Test Head Modules, Front View

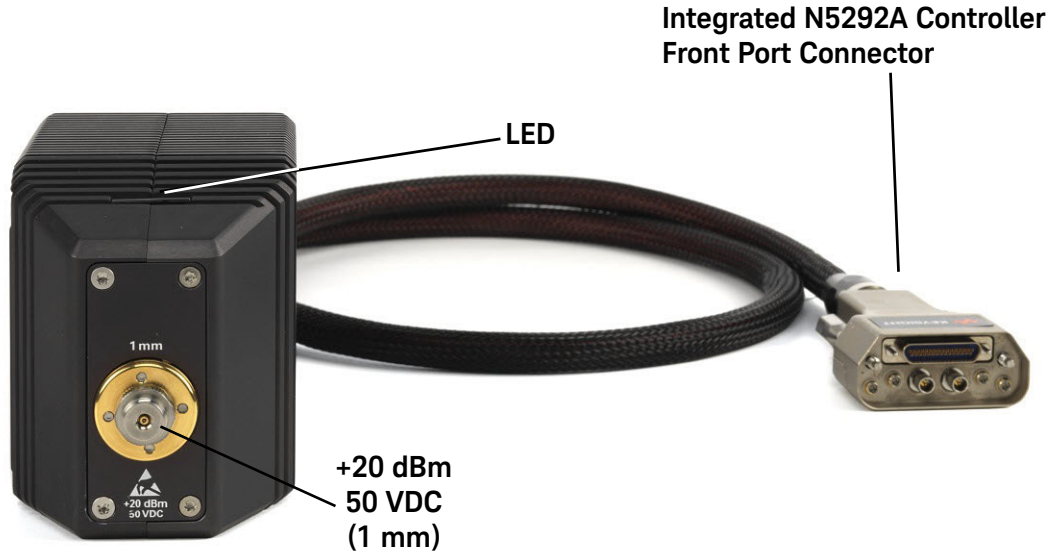
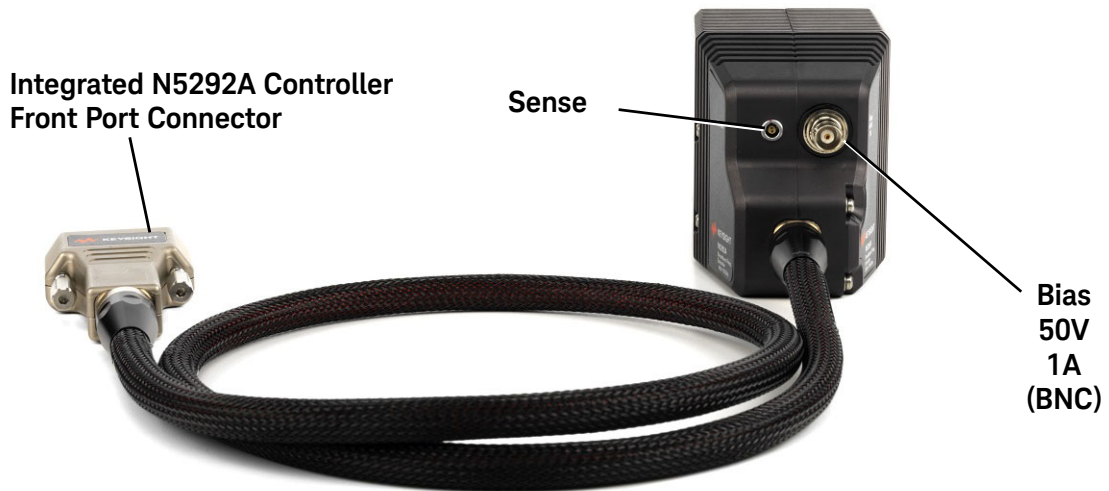
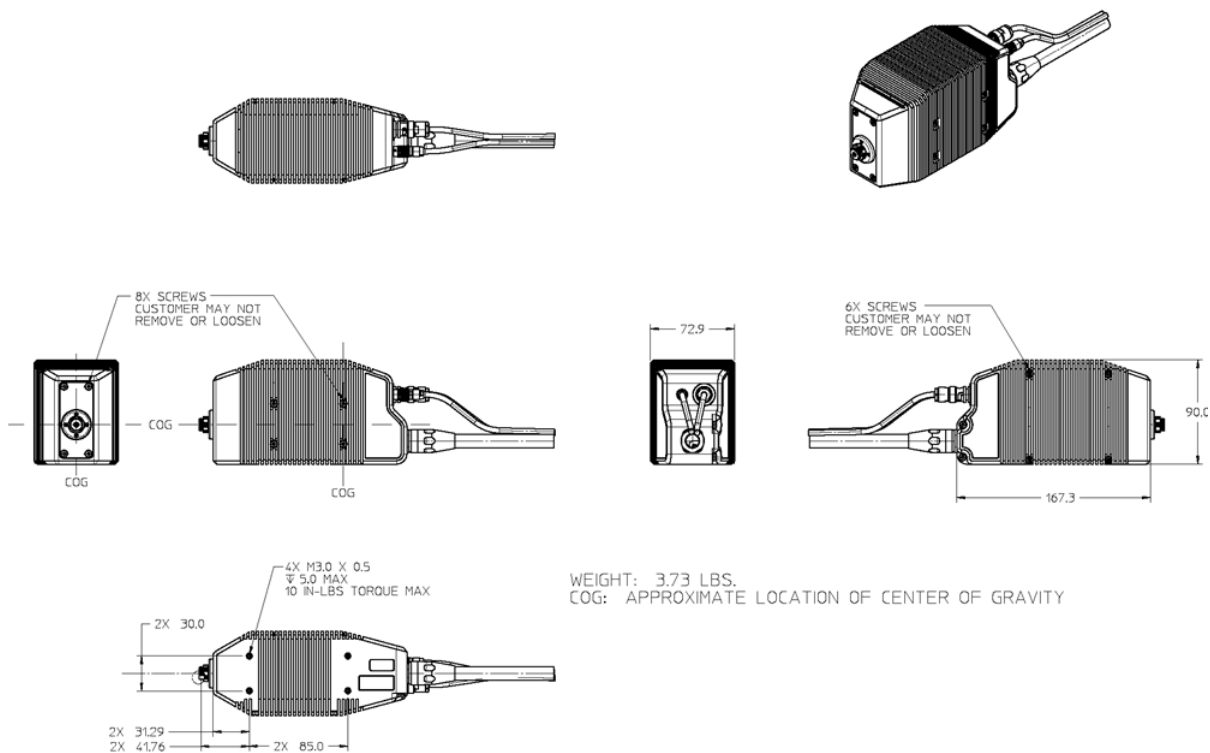

Figure 2-13 N5293/5A Left and Right Frequency Extender Test Head Modules, Back View



System Description
 Compatible Millimeter-Wave Modules

Figure 2-14 N5293/5AX03 Millimeter-wave module Mechanical Specifications



Basic System Measurement Configurations

The N5290/1A can be used in either of two basic configurations, depending on how the test ports are connected to the device under test (DUT): coaxial measurement configuration or wafer probe measurement configuration.

CAUTION

Input power to the test ports must not exceed +20 dBm. Input power in excess of this level will damage expensive components. Observe proper precautions, especially when measuring amplifiers with gains of 20 dB or greater.

Coaxial Measurement

This configuration is used when the DUT has coaxial connectors. The N5290/1A test ports have 1.0 mm male coaxial connectors, and are designed to cover a frequency range of 900 Hz to 110 GHz (N5290A) or 900 Hz to 120 GHz (N5291A).

In this configuration, the test head modules are placed on a work bench in front of the millimeter head controller.

The DUT is normally connected to the test ports by way of a 1.0 mm coaxial cable (test port cable). Connect a DUT (with female connectors) to Port 1 (left test head module) directly, and to Port 2 (right test head module) by way of a female to female test cable. It is also possible to connect the DUT using a test port cable on each test port, although this configuration will result in greater signal loss. (i.e., Devices with female connectors can connect directly to the test ports. Devices with male connectors require a female to female cable.)

CAUTION

Do not attempt to connect a test device directly between the two 1.0 mm test ports, without at least one test port cable. The test head modules will not move freely enough to allow such a connection to be made safely.

Figure 2-15 on page 26 shows how the instruments are configured on a work bench for the coaxial measurement configuration. The test head modules are placed on the bench top in front of the PNA and controller.

Figure 2-15 N5290/1A 4-Port Test System – Coaxial Measurement Configuration (N5291A is similar)



3 System Installation

CAUTION

IMPORTANT!

A 85059B 1.0 mm Precision Calibration Kit and a 85059V 1.0 mm Precision Verification Kit are required to complete the installation of the N5290/1A Millimeter-wave Systems.

In order to maintain compliance to the certificate of calibration it is recommended that the frequency extenders be connected to the corresponding test set ports per the Certificate of Calibration provided.

Information in This Chapter

This chapter describes preparing to receiving your 2-port or 4-port N5290/1A millimeter system and the system's installation procedure(s).

Chapter Three at-a-Glance

| Section Title | Summary of Content |
|--|--|
| “Getting Prepared” on page 2 | Discusses how to download the service guide, tools required for installation, and the time required to install the system. |
| “Getting Assistance from Keysight” on page 3 | How to contact Keysight for support with your system. |
| “Receiving the System” on page 4 | What to do when you receive your system, verifying the parts received, and customer engineering support. |
| “PNA, Controller, and Test Head Module Interconnections” on page 6 | A discussion and procedures for assembling your N5290/1A system. |
| “Initializing the N5290/1A Broadband System” on page 25 | Discusses how to initialize the N5290/1A system. |
| “Running the Installation Calibration” on page 27 | Describes the N5290/1A millimeter wave installation calibration. |
| “Troubleshooting the N5293/5A Millimeter Modules” on page 30 | Describes the types of error messages that might be seen, if a millimeter wave module is incorrectly installed. |

Getting Prepared

CAUTION

The N5290/1A contains extremely sensitive components that can be ruined if mishandled. Follow instructions carefully when making cable connections, especially wire harness connections.

The person performing the work accepts responsibility for the full cost of the repair or replacement of damaged components.

To successfully install this N5290/1A system, you will need the following:

An ESD-safe work area - refer to **“Electrostatic Discharge Protection”** on page 1-7.

- Sufficient AC power - refer to **“Site Preparation”** on page 1-18
- Correct tools for system validation - refer to **“Tools Required for the Installation”** on page 3-2.
- Enough time - refer to **“About Installing the System”** on page 3-2.

Tools Required for the Installation

| Description | Qty | Part Number |
|--|-----|-------------|
| T-10 TORX driver (set to 9 in-lbs) | 1 | N/A |
| T-20 TORX driver (set to 21 in-lbs) | 1 | N/A |
| 5/16-in torque wrench (set to 8 in-lbs) | 1 | N/A |
| 5/16-in torque wrench (set to 10 in-lbs) | 1 | N/A |
| 5/16-in torque wrench (set to 21 in-lbs) | 1 | N/A |
| 14 mm open-end wrench (set to 4 in-lbs) | 1 | N/A |
| 20 mm open-end wrench (set to 8 in-lbs) | 1 | N/A |

CAUTION

Use a 5/16-in torque wrench set to 8 in-lbs on all semirigid front and rear panel cable connections.

About Installing the System

| | |
|---|---|
| Products affected | N5290A, N5291A, N5292A, N5293A, and N5295A. |
| Installation to be performed by | Keysight customer engineer or personnel qualified by Keysight |
| Estimated installation time | 4 hours |
| Estimated full instrument verification time | 4.0 hours |

Getting Assistance from Keysight

Installing this upgrade kit requires special skills and experience. Keysight will provide a customer engineer to assist you with the system's installation. Refer to **"Keysight Technologies Customer Engineering" on page 3-4.**

Contacting Keysight

Refer to **"Keysight Support, Services, and Assistance" on page 4-5.**

Receiving the System

CAUTION

The N5292A millimeter head controller and the test head modules are sensitive to electrostatic discharge (ESD). Ground your work station before unpacking and installing the test head modules. See **“Electrostatic Discharge Protection” on page 1-7.**

Receiving the System

The N5290/1A system components will arrive packaged separately. For a complete list of components shipped with your system, refer to **Table 2-3 on page 2-8** through **Table 2-4 on page 2-9.**

When the entire shipment has arrived, contact Keysight Technologies to arrange for system installation. See **“Keysight Support, Services, and Assistance” on page 4-5.**

Keep the shipping containers until the system checklist has been completed, and the system has been checked for physical damage.

If the shipping container is damaged or the packaging material shows signs of stress, notify the carrier as well as Keysight Technologies. Keep the shipping materials for the carrier’s inspection. Keysight Technologies will arrange for repair or replacement of damaged equipment without waiting for a claim settlement from the carrier. Refer to **“Keysight Support, Services, and Assistance” on page 4-5.**

Keysight Technologies Customer Engineering

A Keysight Technologies Customer Engineer will be assigned to help you install the system. During installation, the Customer Engineer will do the following:

- Unpack the system components.
- Verify the system parts list, see **Table 2-3 on page 2-8** or **Table 2-4 on page 2-9.**
- Initialize the PNA as described in E8356-90001 Quick Start Guide that comes with every PNA.
- Run the Operator’s Check of the PNA as described in the E8356-90001 Quick Start Guide that comes with every PNA.
- Connect the N5292A millimeter head controller to the PNA. Install the N5293A or N5295A millimeter-wave frequency extender test head modules.
- Run the Operator’s Check of the system using the procedure in **Chapter 4, “Performance Verification.”**
- Run the System Verification as described in **Chapter 4, “Performance Verification.”**
- Provide training for one user.

Review the Principles of Connector Care

Proper connector care and connection techniques are critical for accurate and repeatable measurements. Refer to **Table 5-1 on page 5-3** for tips on connector care.

Prior to making connections to your analyzer, carefully review the information about inspecting, cleaning, and gaging connectors. Refer to the calibration kit documentation for detailed connector care information.

PNA, Controller, and Test Head Module Interconnections

CAUTION

IMPORTANT!

The N52xxB interconnect kits contain 2.4 mm to 3.5 mm cables. It is important to connect the 2.4 mm end to the PNA and to connect the 3.5 mm end to the N5292A test set controller. Improper connections will result in damage to your instruments. Refer to [Figure 3-1](#).

It is important to use two wrenches when connecting the semirigid cables to the 1/2/3/4 port 1.85 mm outputs front ports of the PNA to avoid stressing the connectors and causing damage to your PNA (i.e., the 2.4 mm cable end is compatible with the 1.85 mm connector of the PNA).

Figure 3-1 PNA RF Port Connector to N5292A Test Set Lo Band Connector (2.4 mm)

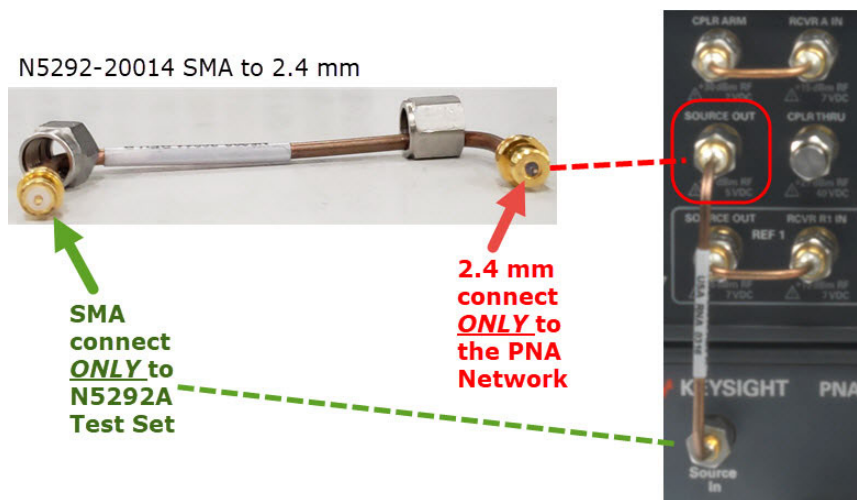

System Setup

Mount the analyzer on top of the test set before connecting any cables to the PNA or to the test set. The cables can then be connected after the analyzer and test set are securely attached.

WARNING

The network analyzer is heavy. It is recommended that two individuals, or a mechanical lift be used to lift or transport the instrument.

If not already done, open the interconnect kit and validate its contents against [Table 2-6 on page 2-12](#).

Mounting a Network Analyzer on the Test Set

Refer to the following kits for your specific analyzer. In this procedure a various PNAs are used with a N5292A Test Set Controller. But, other PNAs are similar.

System Installation
PNA, Controller, and Test Head Module Interconnections

- Interconnect kits includes the SMA 50 ohm loads, cables, upper and lower locking feet, and screws. Refer to [Table 2-6 on page 2-12](#).

1. **On the PNA:** Remove the feet from the bottom of the analyzer.
2. Remove the 2 lower standoffs from the rear panel on the analyzer.
3. Remove the top two standoffs from the rear panel on the test set.

Figure 3-1 Rear Bottom Feet

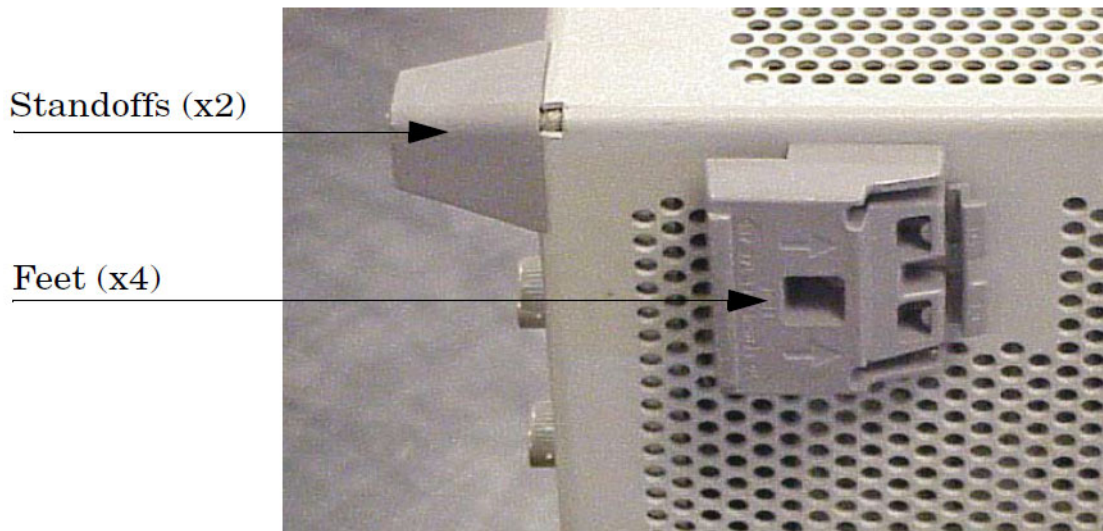

4. Install the two rear locking feet (N5240-20092 and N5240-20095) or (N5240-20093 and N5240-20094) onto the analyzer, where the standoffs were removed using 0515-1619 screws. Do **NOT** torque these screws yet. Refer to [Figure 3-2 on page 9](#).

WARNING

The network analyzer is heavy. It is recommended that two individuals, or a mechanical lift be used to lift or transport the instrument.

Figure 3-2

Install upper locking feet N5240-20092 and N5240-20095 (shorter feet used on N5227B/47B) or N5240-20093 and N5240-20094 (longer feet used on N5222B/42B) using 0515-1619 screws. Do **NOT** torque these screws yet.

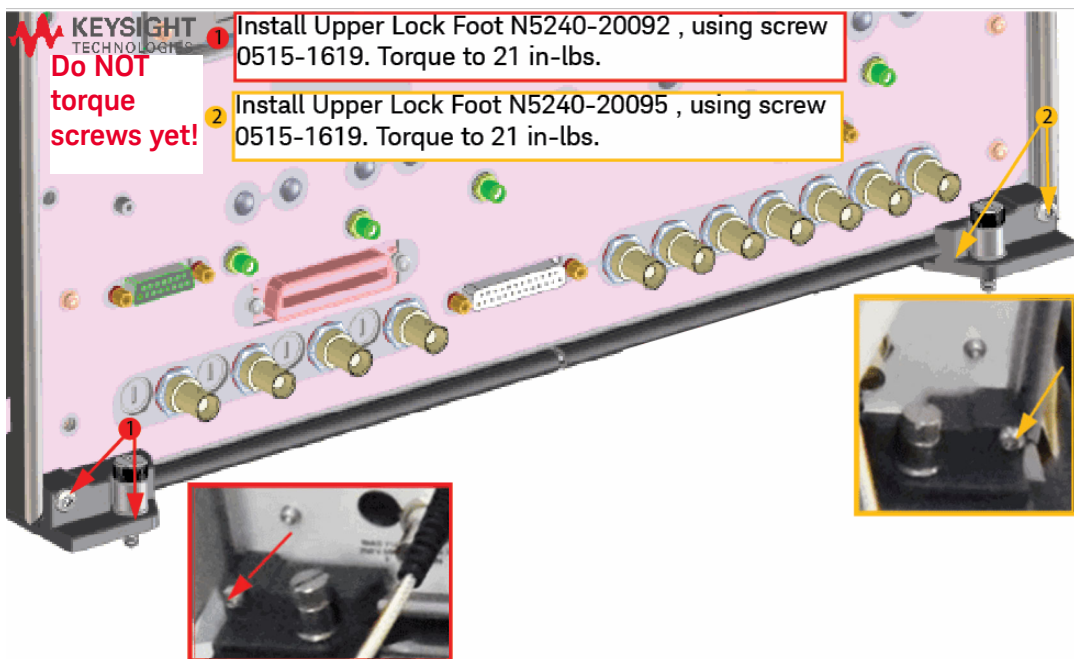

PART SEQUENCE:

1 2



N5227B/47B – Locking foot, short
N5240-20092 and N5240-20095

N5222B/42B – Locking foot, long
N5240-20093 and N5240-20094



5. On the N5292A: Install lower lock feet N5292-20012 and N5292-20013, using screw 0515-1619. Do **NOT** torque these screws yet. Refer to [Figure 3-3 on page 10](#).

Figure 3-3

Install lower lock feet N5292-20012 and N5292-20013 using screws 0515-1619. Do **NOT** torque these screws yet.

- 1 Install Lower Lock Foot N5292-20012, using screw 0515-1619. Torque to 21 in-lbs.
- 2 Install Lower Lock Foot N5292-20013, using screw 0515-1619. Torque to 21 in-lbs.

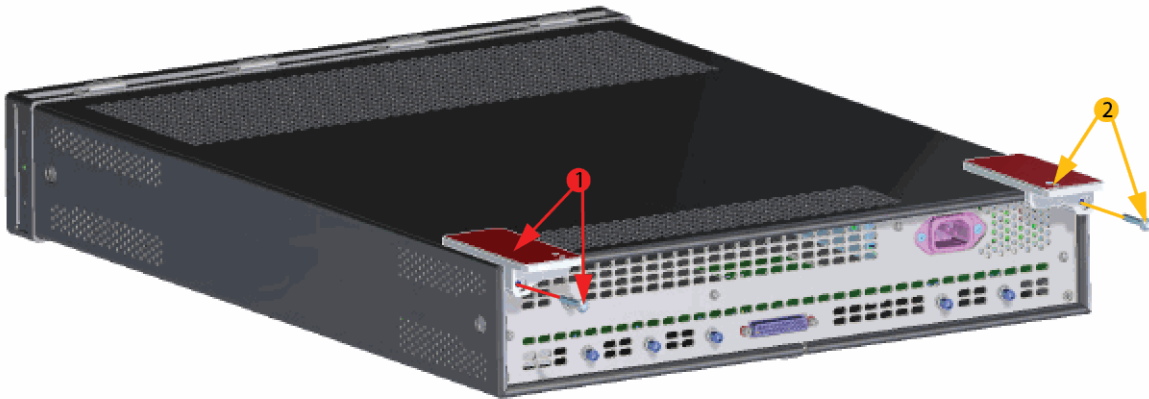

PART SEQUENCE:

1 2

6. Mount the analyzer on top of the test set and ensure that the front frame of the analyzer is positioned slightly forward of the locks that are attached to the test set. Slide the analyzer back so the locks engage the front frame of the analyzer. Refer to [Figure 3-4](#) and to [Figure 3-5 on page 11](#).

Figure 3-4

Locking the Analyzer using the vertical links

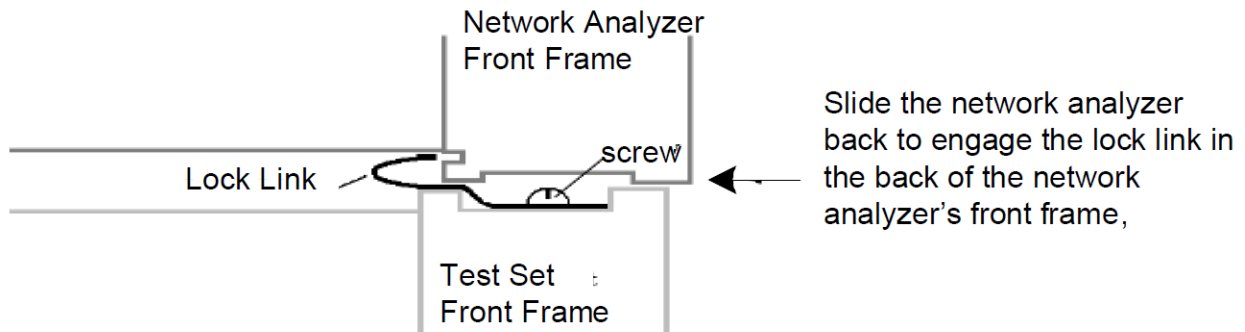

7. Secure the analyzer's lower locking feet (N5240-20092 and N5240-20095) to the test set's upper locking feet (N5292-20012 and N5292-20013) using the spring-loaded screws on the locking feet. Refer to **Figure 3-5**. If the locking feet are not aligned with the screw holes in the test set's upper locking feet, loosen the screws securing the feet to the instrument slightly to align and tighten.

Figure 3-5

Install N5292A test set controller to the bottom of the PNA using vertical links and upper foot locks (N5292-20012 and N5292-20013). Long foot lock screws shown, but short lock screws are similar. Do **NOT** torque these screws yet.

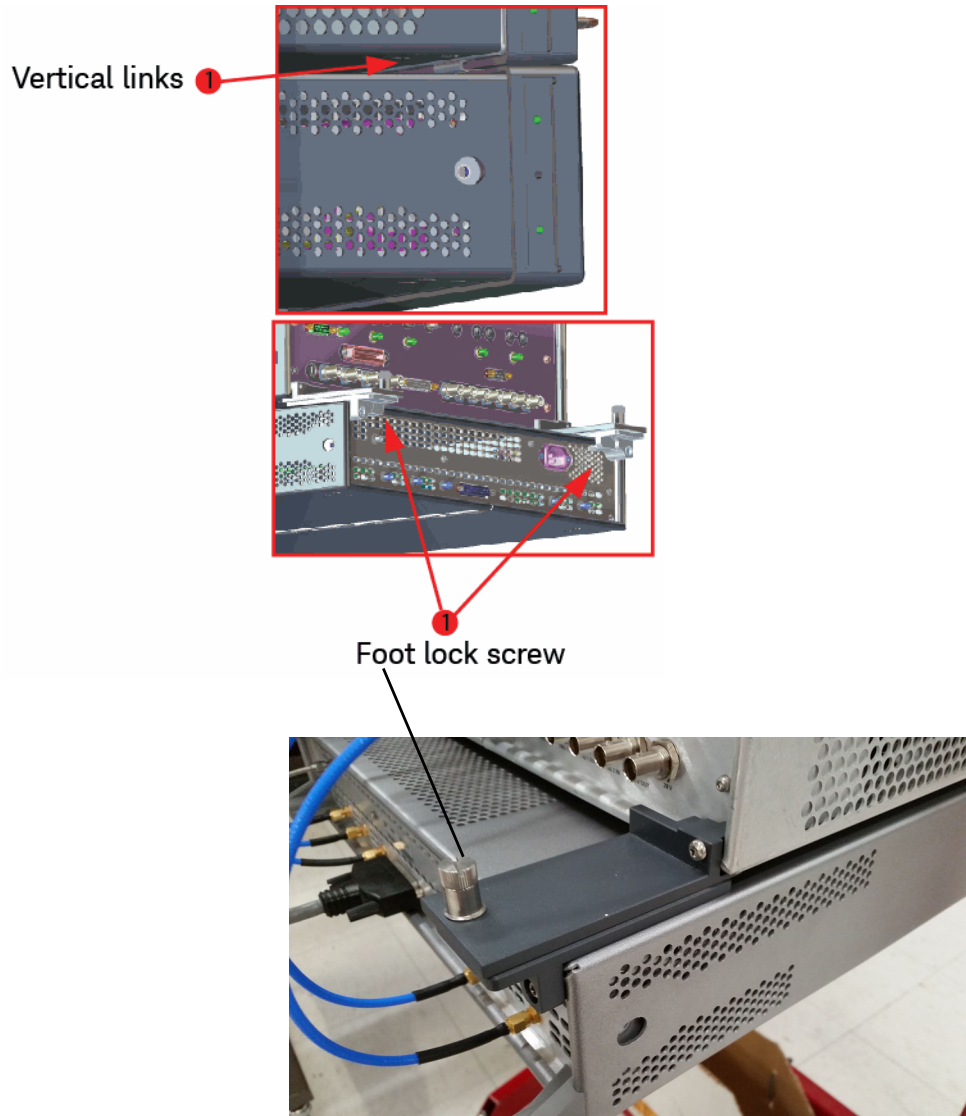

8. Torque the 0515-1619 screws that were installed in step 4 and 5. Use a T-21 to torque to 21 in-lbs. Optional: Rotate the PNA 180 degrees to install locking feet. Refer to [Figure 3-2 on page 9](#), [Figure 3-3 on page 10](#), and [Figure 3-5 on page 11](#).
9. Remove semirigid cables from SOURCE OUT to CPLR THRU. Refer to [Figure 3-6](#).
10. Connect 50 ohm terminations to CPLR THRU ports. Refer to [Figure 3-6](#).
 - Part number 1250-4261 for N5222B/42B (3.5mm).
 - Part number 0955-2394 for N5224B/25B/27B/44B/45B/47B (2.4mm).

Figure 3-6 Remove Semirigid Cables and Connect 50 termination (1250-4261 (3.5 mm) or 0955-2394 (2.4 mm)) to the CPLR THRU Ports

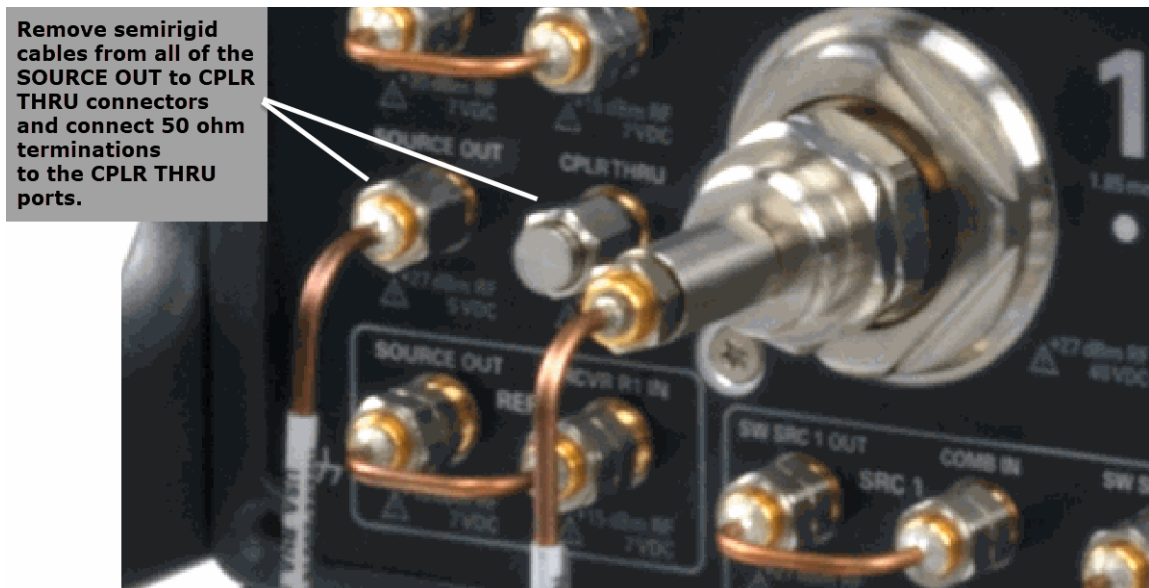

11. Install Interconnect Kit Semirigid Cables:

CAUTION

IMPORTANT!

The N52xxB interconnect kits contain 2.4 mm to 3.5 mm cables. It is important to connect the 2.4 mm end to the PNA and to connect the 3.5 mm end to the N5292A test set controller. Improper connections will result in damage to your instruments.

It is important to use two wrenches when connecting the semirigid cables to the 1/2/3/4 port 1.85 mm outputs front ports of the PNA to avoid stressing the connectors and causing damage to your PNA (i.e., the 2.4 mm cable end is compatible with the 1.85 mm connector of the PNA). Refer to [Figure 3-7](#).

Figure 3-7 To avoid damaging your RF ports 1/2/3/4, always use two wrenches

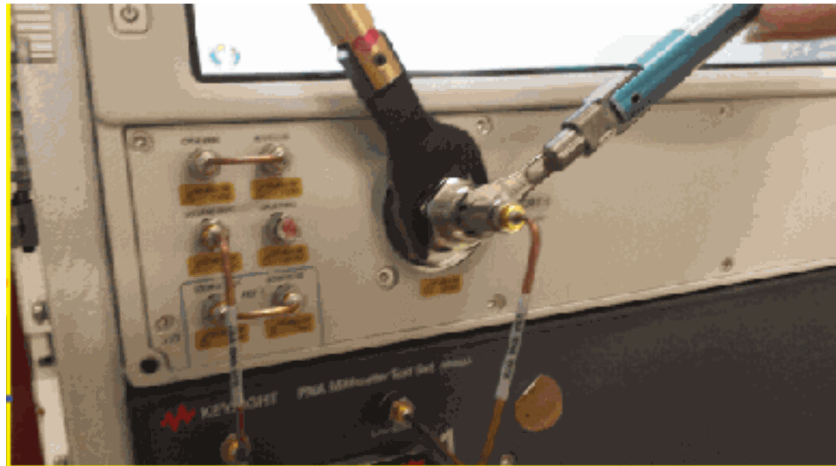

IMPORTANT! 2 wrenches must be used to avoid stress on the semi rigid cable.

N5290/1A Option 201 (Interconnect Kit N5292-60012)

Refer to **Figure 3-8**.

Figure 3-8

N5290/1A-201 –(Interconnect Kit N5292-60012): Install semirigid cables (N5292-20006 and N5292-20009) and if not done, connect 50 ohm loads (1250-4261) to the front panel of the PNA and N5292A

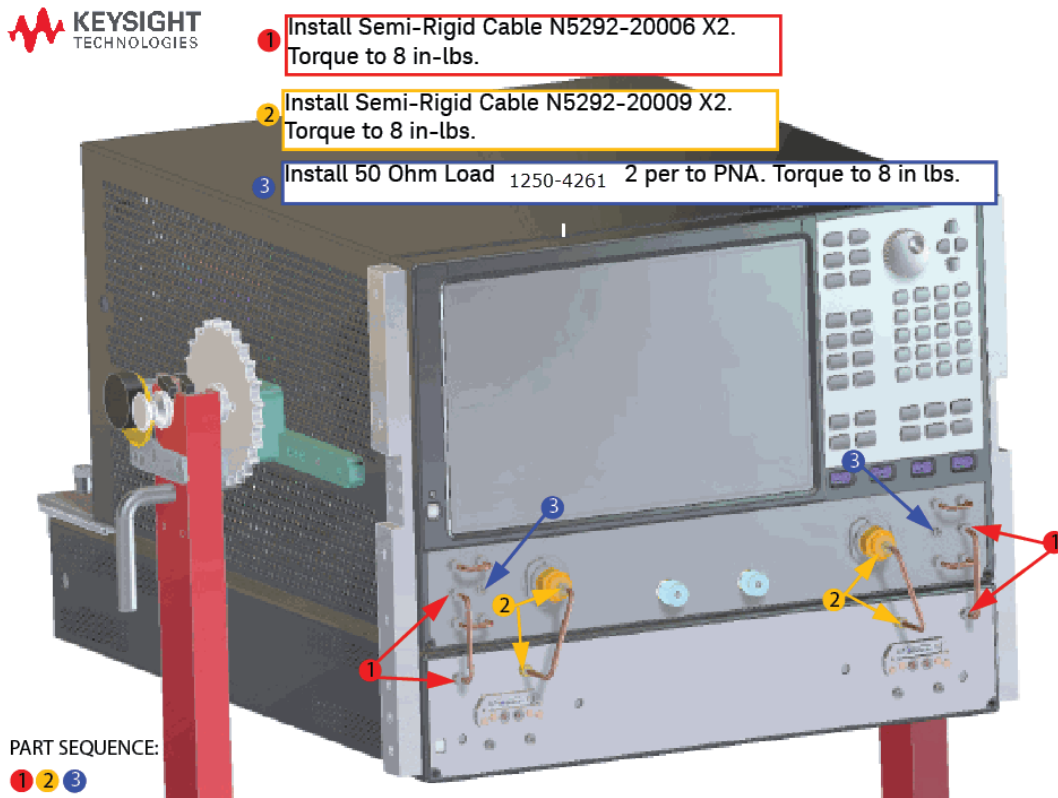

N5290/1A Option 202 (Interconnect Kit N5292-60013)

CAUTION

IMPORTANT!

The N52xxB interconnect kits contain 2.4 mm to 3.5 mm cables. It is important to connect the 2.4 mm end to the PNA and to connect the 3.5 mm end to the N5292A test set controller. Improper connections will result in damage to your instruments.

It is important to use two wrenches when connecting the semirigid cables to the 1/2/3/4 port 1.85 mm outputs front ports of the PNA to avoid stressing the connectors and causing damage to your PNA (i.e., the 2.4 mm cable end is compatible with the 1.85 mm connector of the PNA).

Figure 3-9 PNA RF Port Connector to N5292A Test Set Lo Band Connector (2.4 mm)

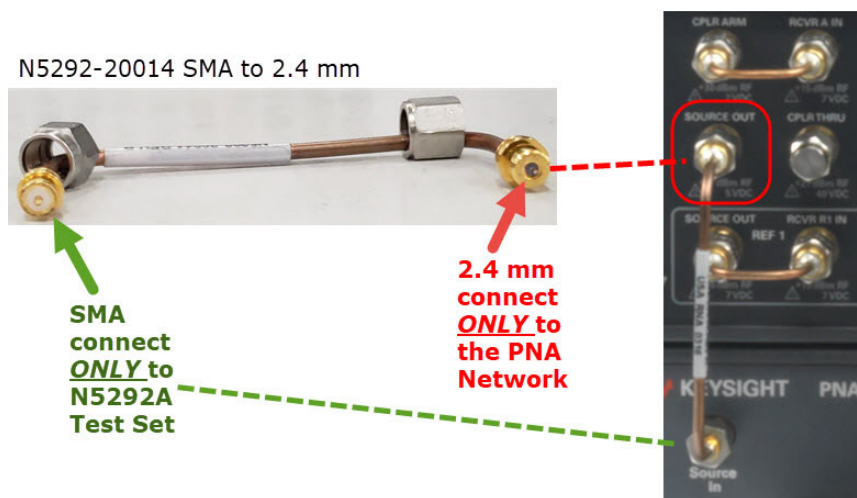

Refer to [Figure 3-8 on page 14](#).

Figure 3-10 N5290/1A-202–(Interconnect Kit N5292-60013): Install semirigid cables (N5292-20014 and N5292-20017) and if not done, connect 50 ohm loads (0955-2394) to the front panel of the PNA and N5292A



1 Install Semi-Rigid Cable N5292-20014 X2.
Torque to 8 in-lbs.

2 Install Semi-Rigid Cable N5292-20017 X2.
Torque to 8 in-lbs.

3 Install 50 Ohm Load 0955-2394 2 per
to PNA. Torque to 8 in lbs.



Note: 2 wrenches must be used to avoid stress on the semi rigid cable

PART SEQUENCE:
1 2 3

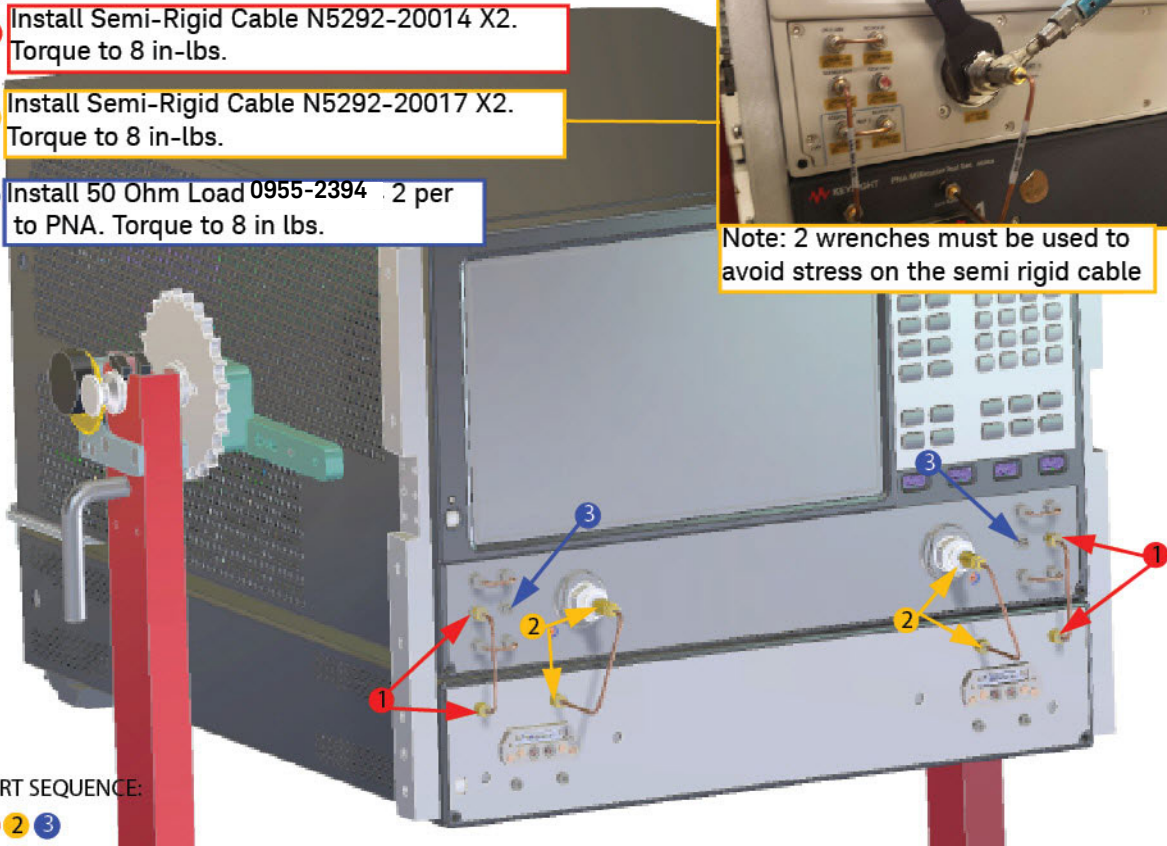

N5290/1A Option 401 or N5290/1A Option 402—(Interconnect Kit N5292-60016)

Figure 3-11 is used for a N5292-60016 interconnect kit.

Figure 3-11

N5290/1A-401 or N5290/1A-402: Install semirigid cables (N5292-20006, N5292-20007, and N5292-20008) to the front panel of the PNA and N5292A. Option 442 is shown.



- 1 Install Semi-Rigid Cable N5292-20006 X4.
Torque to 8 in-lbs.
- 2 Install Semi-Rigid Cable N5292-20007 X2.
Torque to 8 in-lbs.
- 3 Install Semi-Rigid Cable N5292-20008 X2.
Torque to 8 in-lbs.

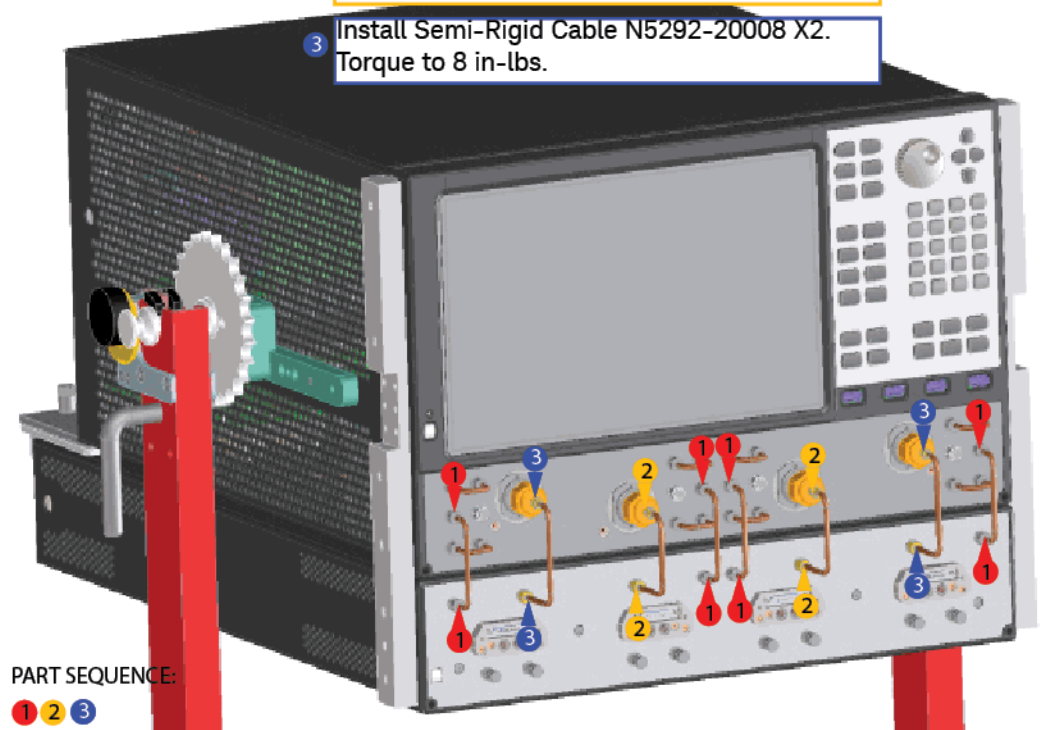

PART SEQUENCE:
1 2 3

N5290/1A Option 403—(Interconnect Kit N5292-60017)

CAUTION

IMPORTANT!

The N5227B and N5247B interconnect kits contain 2.4 mm to 3.5 mm cables. It is important to connect the 2.4 mm end to the PNA and to connect the 3.5 mm end to the N5292A test set controller. Improper connections will result in damage to your instruments.

It is important to use two wrenches when connecting the semirigid cables to the 1/2/3/4 port 1.85 mm outputs front ports of the PNA to avoid stressing the connectors and causing damage to your PNA (i.e., the 2.4 mm cable end is compatible with the 1.85 mm connector of the PNA).

Figure 3-12

PNA RF Port Connector to N5292A Test Set Lo Band Connector (2.4 mm)

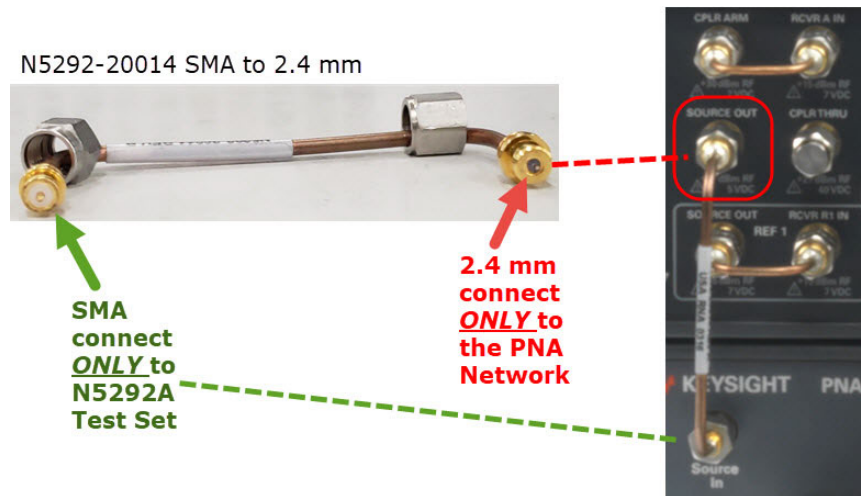
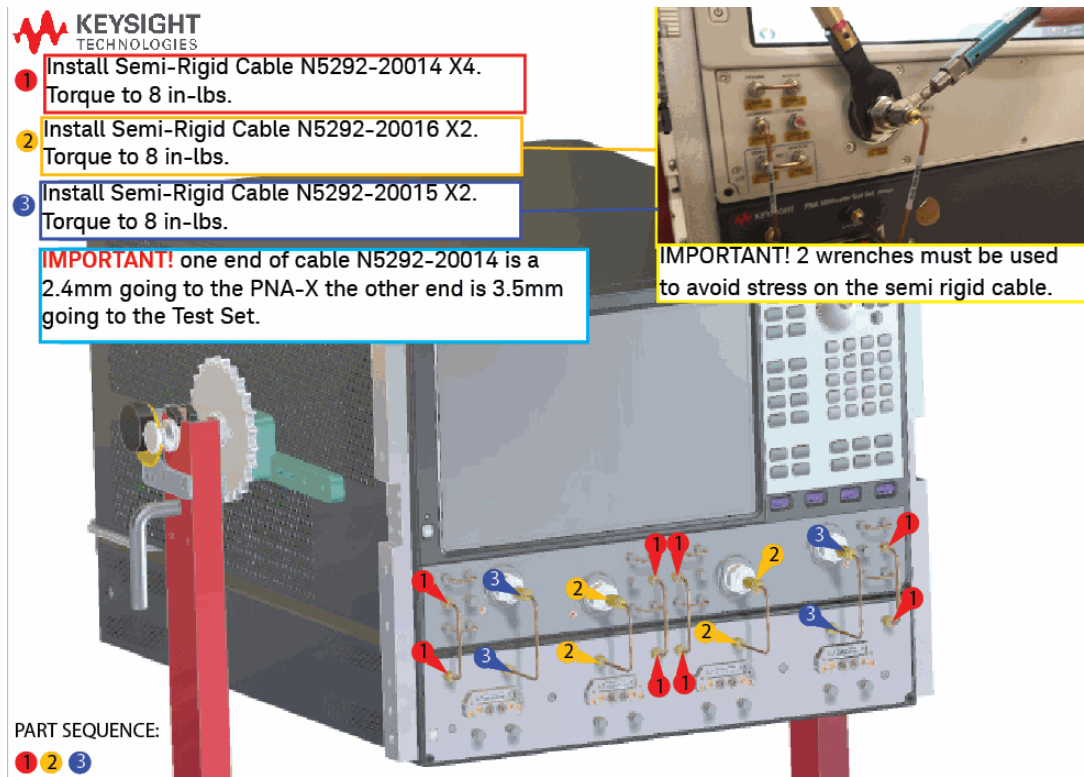

Figure 3-13 on page 19 is used for the N5292-60017 interconnect kit.

Figure 3-13 N5290/1A-403: Install semirigid cables (N5292-20014, N5292-20015, and N5292-20016) to the front panel of the PNA and N5292A



Rear Panel Cabling

Figure 3-14 on page 20 and Figure 3-15 on page 21 shows how to install the cables for 2-port and 4-port systems. Torque all RF connections to 8 in-lbs (0.90 N.m) to insure proper connection.

Figure 3-14 Connect the system cables to the rear panel (8120-2970, x5, N5240-60092, and N4011-21002)

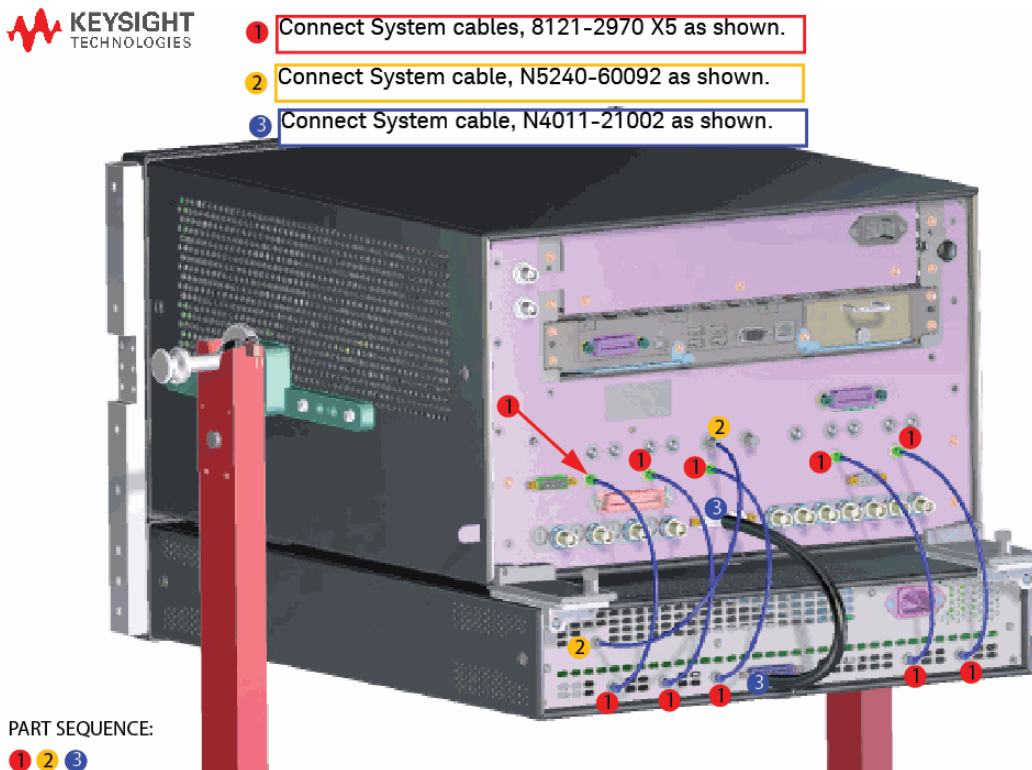

Figure 3-15 N5290A 2- and 4-Port Model Rear Panel Cabling

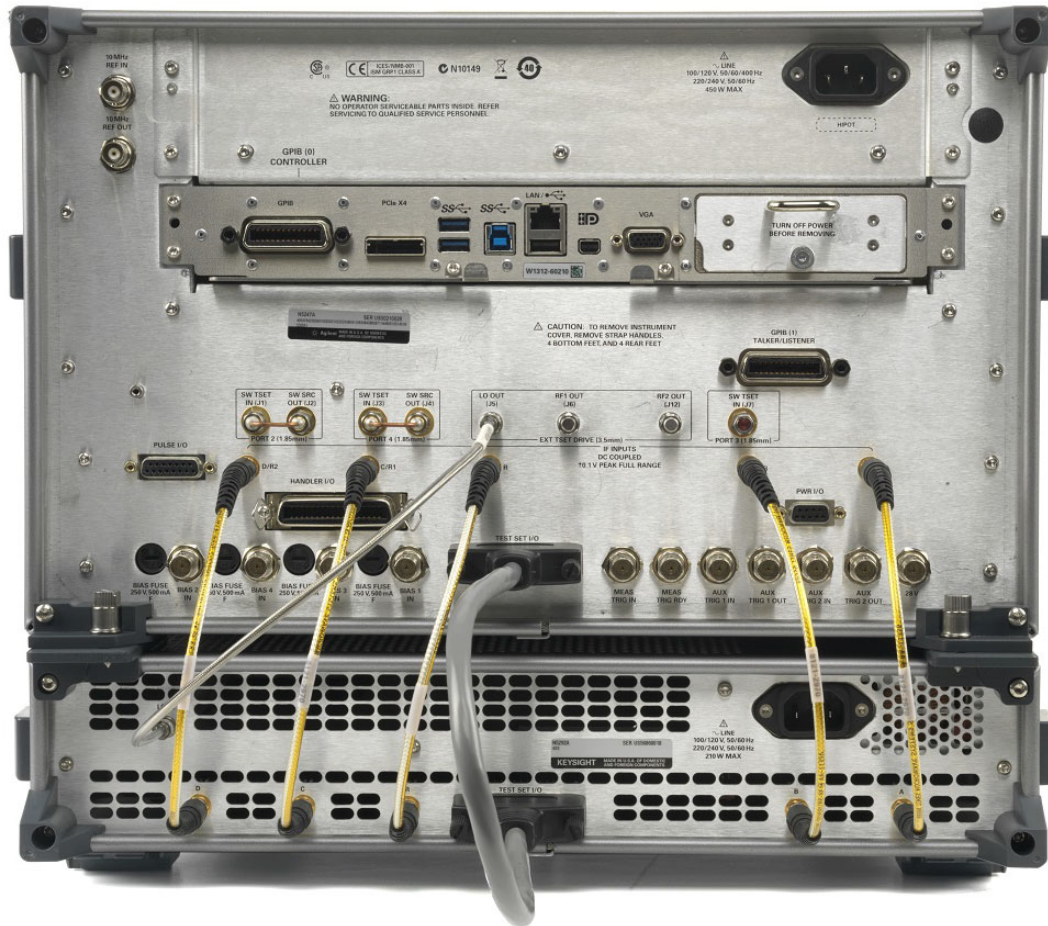

Table 3-16 N5290A 2- and 4-Port Rear Panel Cabling

| | | | | | | | |
|-------------------|--------|------|------|---|--------------|---|---|
| From: PNA | LO OUT | D/R2 | C/R1 | R | TEST SET I/O | B | A |
| To: N5292A | LO IN | D | C | R | TEST SET I/O | B | A |

N5293/5A Modules Front Panel Cabling

CAUTION

IMPORTANT!

In order to maintain compliance to the certificate of calibration it is recommended that the frequency extenders be connected to the corresponding test set ports per the Certificate of Calibration provided.

CAUTION

IMPORTANT!

Before connecting the millimeter-wave modules, verify that the test set and the power supplies (if used) are powered down.

The N5292A test set controller's integrated front panel connectors contain optical sensors to ramp power up or down gradually when the N5293/5A millimeter modules are connected to prevent damage. Refer to ["Troubleshooting the N5293/5A Millimeter Modules" on page 3-30](#).

CAUTION

IMPORTANT! When connecting the N5293/5A modules, it is very important to verify that the module connectors are seated flush and that the screws are screwed all the way into the N5292A front test ports. But, be careful to **not** overtighten.

The front-panel connections between the millimeter head controller and a test head module are shown in [Figure 3-17 on page 23](#) through [Figure 3-20 on page 24](#). This cabling is duplicated for each test head module in the system.

- ["N5292A Option 200 2-Port Cable Connections" on page 3-23](#)
- ["N5292A Option 400 4-Port Cable Connections" on page 3-24](#)

Connections for Each Head

1. Connect a set of x4 feet to the bottom of each millimeter module.
Choose either:
 - N5293-40003 feet, bottom, grip or
 - N5293-40004 feet, bottom, slip
2. **PNA/PNA-X:** Verify you have connected all of the semirigid cables and torque to 8 in-lbs. Refer to [Figure 3-8 on page 14](#).
3. **N5292A:** Connect the integrated cables from the N9293A or N5295A millimeter heads.

N5292A Option 400 4-Port Cable Connections

Figure 3-19 Cable Connections for Four Test Heads Module



Figure 3-20 Cable Four Test Heads N5293/5AX03 to the N5292A



Torque cable screws to 8 in-lbs

Initializing the N5290/1A Broadband System

After the N5290/1A Broadband System has been calibrated and verified at the factory, the PNA is reset back to “Standard PNA” mode to remove any artifact files from the test process. To change your PNA over to “N529xA Broadband” mode:

1. On the N5292A test set controller: verify the test set is powered down.
2. Power up the N5292A.
3. Power up the PNA.
4. On the PNA: press **Setup > External Hardware > Millimeter Config**
5. In the dialog Millimeter Configuration box that is displayed, click **N5290A Broadband** or **N5291A Broadband**, whichever is available for your system.
6. Verify your Millimeter Heads are enabled. Refer to [Figure 3-21 on page 26](#).

CAUTION

IMPORTANT!

The PNA and millimeter heads should be allowed to warm up for a minimum of 45 minutes, and specified performance only applies after the system has warmed up for 90 minutes.

CAUTION

IMPORTANT!

The millimeter heads typically warm up to 25–30 degrees C above ambient. The microcircuits in the heads perform their best at an internal temperature of 47 degrees C. The outside case temperature can be uncomfortably warm for some people. Exercise caution when handling the heads.

Figure 3-21 Millimeter Configuration Window – N5291A Broadband selected, Enable Modules: Port 1 and Port 2

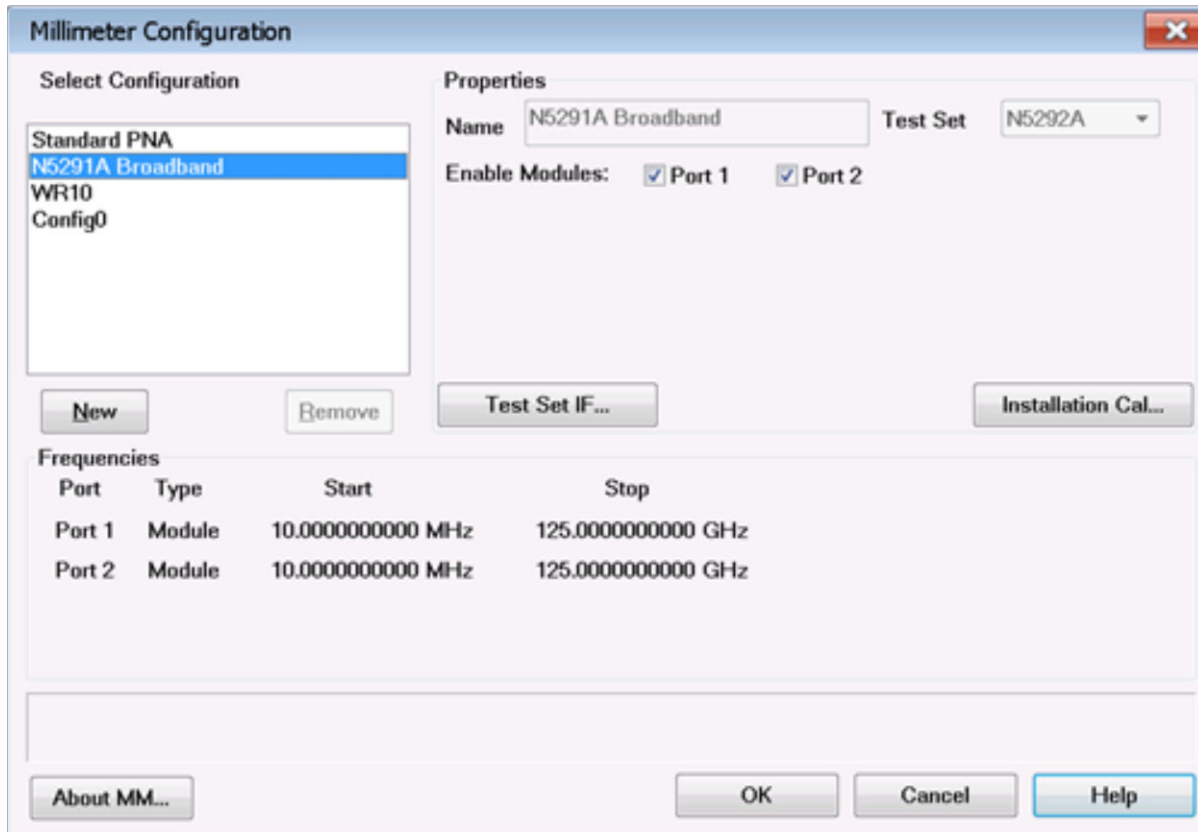

The N5290/1A system should now initialize and recognize the mmW modules. The port 1 module LED should be blue (addressed by the PNA and active) and the other test port(s) should be green (no bias and on standby). See also, [“Troubleshooting the N5293/5A Millimeter Modules” on page 3-30.](#)

Running the Installation Calibration

NOTE

This installation calibration should be ran when you first install your system and whenever you make any changes to your system's configuration. See also [“Troubleshooting the N5293/5A Millimeter Modules” on page 3-30](#).

1. On the PNA, verify your N5290/1A system is in the correct configuration: Press **Setup** > **External Hardware** > **Millimeter Config**.
2. The Millimeter Configuration window that opens should have N5290A Broadband or N5291A Broadband highlighted.
Else, press N5290A Broadband or N5291A Broadband. Refer to [Figure 3-22](#).

Figure 3-22 Millimeter Configuration Window

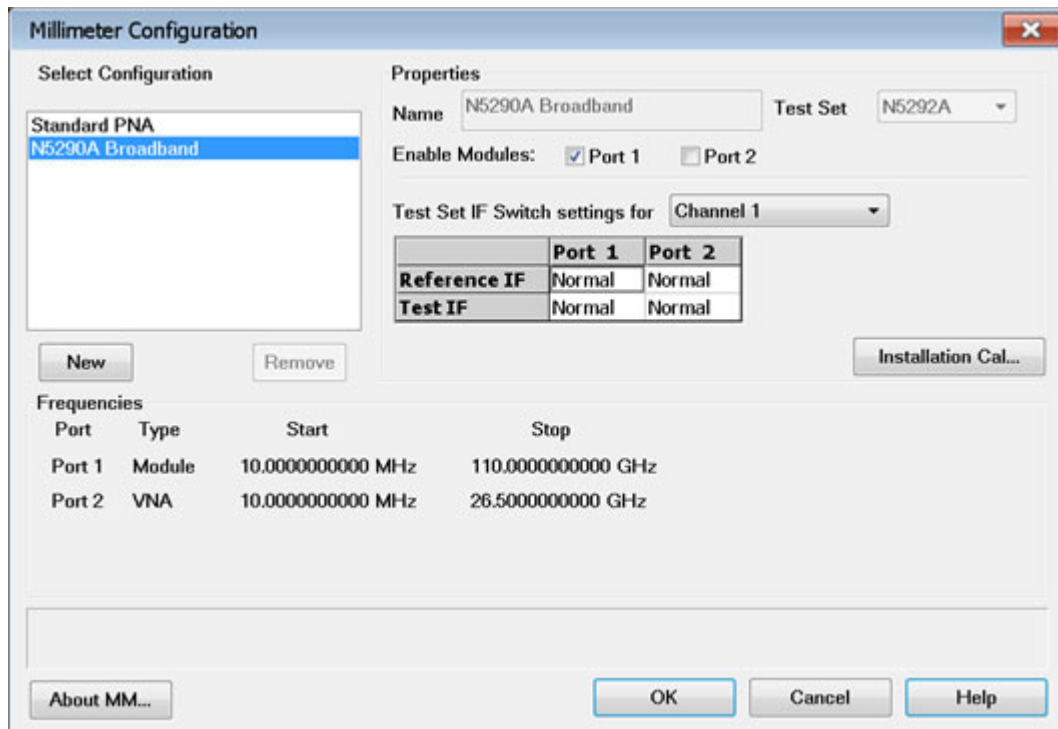

3. Press **Installation Cal**. In the dialog box opens, connect a load and press **Measure**. Refer to [Figure 3-23](#).

CAUTION

For best performance a 125 GHz broadband load is required.

- The U8489A Power sensor can be used to terminate the ports.
- Alternatively, you can connect a through connection between the frequency extenders.

Figure 3-23 Millimeter Installation Cal – Dialog Box

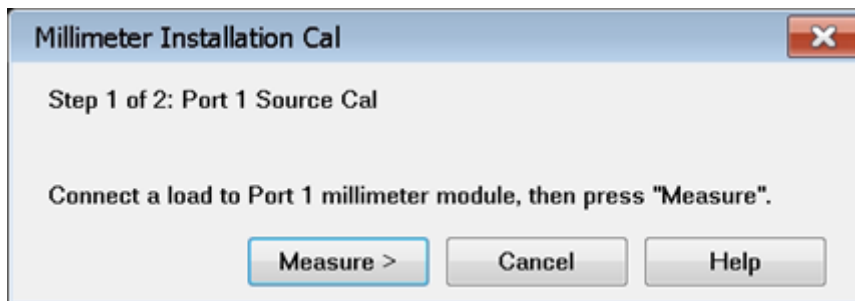

4. When finished, the following dialog box is displayed. Remove the load and press **Finish**. Refer to [Figure 3-24](#).

Figure 3-24 Millimeter Installation Cal – Dialog Box Load Calibration “Finish”

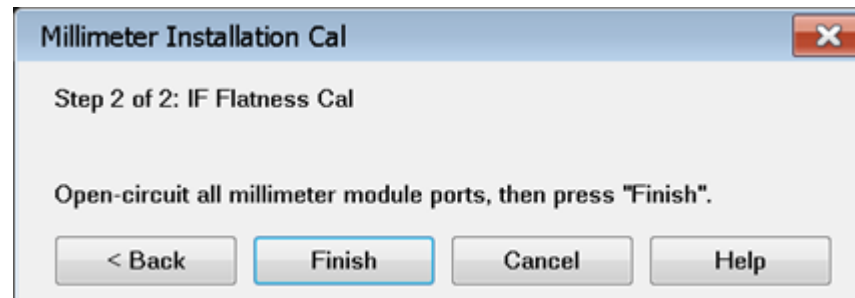

5. The following dialog box is displayed until the calibration is finished (i.e., Is is not necessary to connect a calibration kit open for this step). Refer to [Figure 3-25](#).

Figure 3-25 Millimeter Installation Cal – Dialog Box Open-circuit Calibration Ongoing / “Finish”

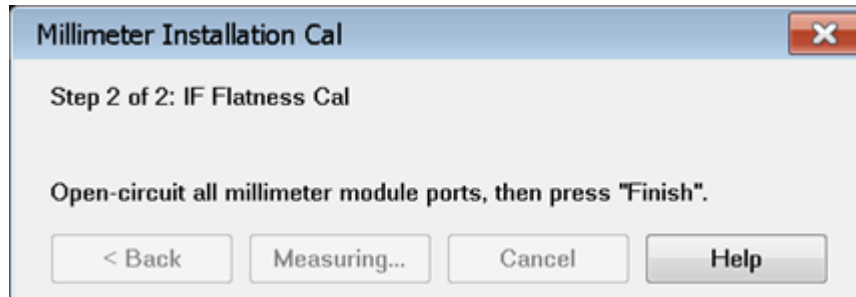

6. If prompted, repeat steps 3 through 5 for all of the other ports requiring calibration.

Troubleshooting the N5293/5A Millimeter Modules

The N5292A test set controller's integrated front panel connectors contain optical sensors to ramp power up or down gradually when the N5293/5A millimeter modules are connected and disconnected to prevent damage. Refer to [Figure 3-26](#) and [Figure 3-27](#).

Figure 3-26 Millimeter configuration warning when a module is disconnected or not connected properly (port 1 is shown)

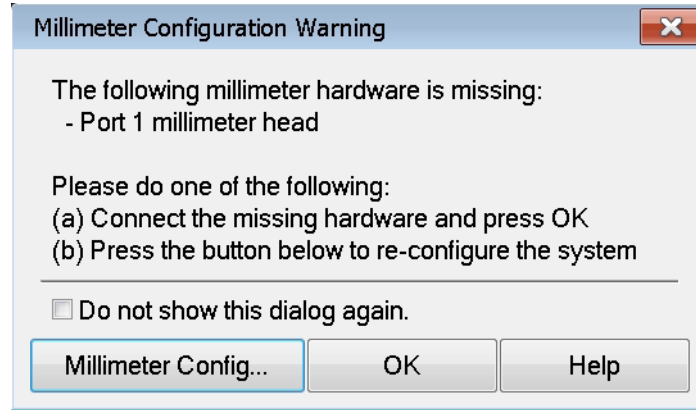
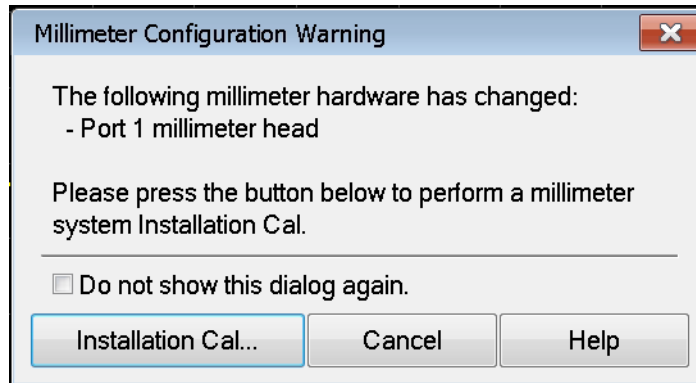

Figure 3-27 Millimeter configuration warning when a port's modules do not match the factory's calibration data (port 1 is shown)



4 Performance Verification

Information in This Chapter

This chapter contains procedures to help you check, verify, and adjust your N5290/1A Millimeter-waveguide System.

- The checks verify the operation of the instruments in your system.
- The verification compares the operation of your analyzer to a gold standard.
- The adjustments allow you to tune your system for maximum response.

Chapter Four at-a-Glance

| Section Title | Summary of Content |
|---|--|
| “Preliminary Checks” on page 4-2 | Overview |
| “System Operator’s Check” on page 4-3 | Describes the System Operator’s Check and what to do, if Operation Check fails. |
| “If the Operator’s Check Fails” on page 4-6 | Description of what to do if Operator’s Check fails. |
| “System Verification” on page 4-7 | Describes the System Verification for validating your N5290/1A Systems. Includes descriptions of printed and graphical N5290/1A system verification output displays. Also, what to do if System Verification Fails. <ul style="list-style-type: none">– When to verify.– What materials are needed to verify.– What are verification results files.– How to interpret and improve the system verification results.– Saving verification results. |
| “If the System Verification Fails” on page 4-17 | Description of what to do if the System Verification Check fails. |

Preliminary Checks

Preliminary checks include the following:

- “**System Operator’s Check**” on page 4-3
- “**System Verification**” on page 4-7

System Operator's Check

NOTE

To achieve the maximum system stability, allow the analyzer to warm up for at least 15 minutes before performing the Operator's Check.

The operator's check is a software driven test that checks the basic operation of the assemblies in all of the measurement port signal paths. By performing the operator's check, the following are tested:

- attenuation ranges of all installed attenuators
- calibration of the receivers
- frequency response of the receivers
- phase lock and leveling
- basic functional test of noise floor and trace noise

Accessories Used in the Operator's Check

| Equipment Type | Part Number |
|----------------------|--|
| Female short, 1.0 mm | (any short from the 85059B calibration kits) |
| Female open, 1.0 mm | (any open from the 85059B calibration kits) |

Performing the Operator's Check

1. Press **UTILITY > System > Service > Verification > Operator's Check**.
2. In the PNA Operator's Check dialog box (refer to [Figure 4-1](#)), under Configure, select either:
 - **Prompt for attachment of Short/Open**, to pause at each step in the process to allow moving the short/open to the appropriate port
 - **Shorts/Opens are attached to ALL ports**, to run through the test without stopping. Shorts and opens can be mixed on the test ports
 - Additionally, you can choose:
 - Pause on Failure
 - Use unique log, to create a log file for this Operator's Check
3. Click **Begin**.
4. If shorts and opens are not connected to all ports, you will be prompted to connect them as needed.

5. The result of the operator's check will be shown as a PASS or FAIL next to each test (refer to [Figure 4-1](#)). The PNA Operator's Check dialog box will look different for different PNA model numbers and installed options. Some of the tests are performed only if the appropriate options are installed in the PNA.

Figure 4-1 Operator's Check Dialog Boxes

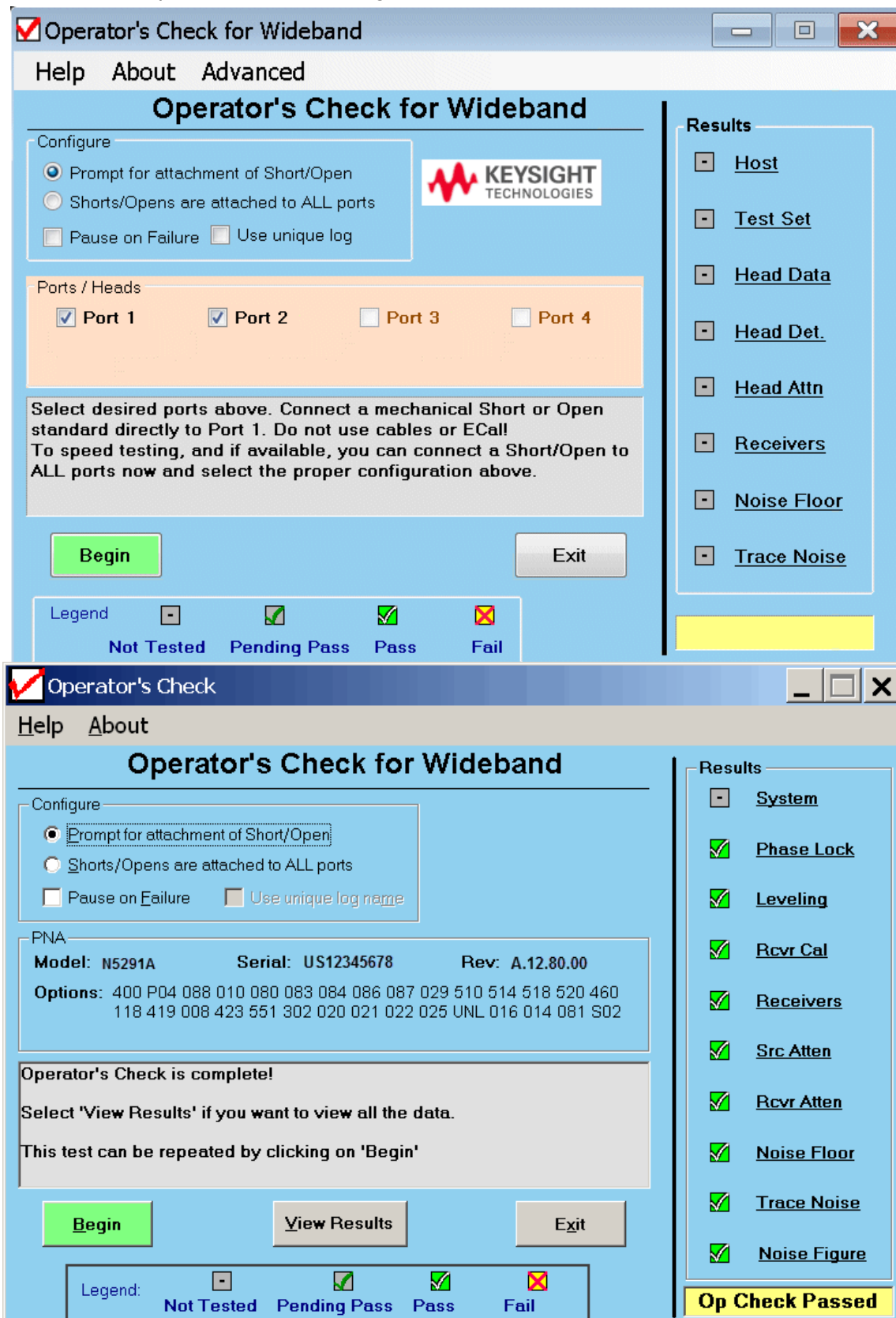

If the Operator's Check Fails

1. Clean the test ports, shorts, and adapters. Torque to specification. Repeat the check.
2. If the check still fails, suspect a faulty component. Refer to **“Contacting Keysight” on page 4-5.**

System Verification

System verification is used to verify system-level, error-corrected uncertainty limits for network analyzer system measurements. The verification procedure is automated and is contained in the firmware of the analyzer.

The device data provided with the verification kit has a traceable path to a national standard. The difference between the supplied traceable data and the measured data must fall within the total uncertainty limits at all frequencies for the system verification to pass.

The total measurement uncertainty limits for the system verification are the sum of the factory measurement uncertainties for the verification devices and the uncertainties associated with the system being verified. You can determine your system measurement uncertainty limits by referring to the analyzer embedded on-line help.

NOTE

Passing this system verification does not guarantee that the analyzer meets all of its performance specifications. However, it does show that the network analyzer being verified measures the same devices with the same results as a factory system which has had all of its specifications verified and its total measurement uncertainty minimized.

What the System Verification Verifies

The system verification procedure verifies proper operation of the:

- network analyzer
- test set controller
- millimeter head modules
- calibration kit
- test port cables

together as a “system”. It DOES NOT verify that any of these components pass their specifications independently. The user is responsible for independently calibrating and verifying the proper operation of the calibration kit and test port cables prior to performing the system verification.

NOTE

Additional equipment or accessories used with the above system are not verified by system verification.

Measurement Uncertainty

Measurement uncertainty is defined as the sum of:

- the residual systematic (repeatable) errors, and
- the random (non-repeatable) errors

in the measurement system after calibration.

The systematic errors are:

- directivity,
- source match,
- load match,
- reflection and transmission frequency tracking, and
- isolation (crosstalk).

The random errors include:

- noise,
- drift,
- connector repeatability, and
- test cable stability.

A complete description of system errors and how they affect measurements is provided in the analyzer's on-line embedded help.

Any measurement result is the vector sum of the actual test device response plus all error terms. The precise effect of each error term depends on its magnitude and phase relationship to the actual test device response. When the phase of an error response is not known, phase is assumed to be worst-case (-180° to $+180^\circ$). Random errors such as noise and connector repeatability are generally combined in a root-sum-of-the-squares (RSS) manner.

Measurement Traceability

To establish a measurement traceability path to a national standard for a network analyzer system, the overall system performance is verified through the measurement of devices that have a traceable path. This is accomplished by measuring the devices in a Keysight verification kit.

The measurement of the devices in the verification kit has a traceable path because the factory system that measured the devices is calibrated and verified by measuring standards that have a traceable path to the National Institute of Standards and Technology (NIST) (see [Figure 4-2](#)). This chain of measurements defines how the verification process brings traceability to the network analyzer system.

Figure 4-2

Traceability Path for Calibration and Verification Standard

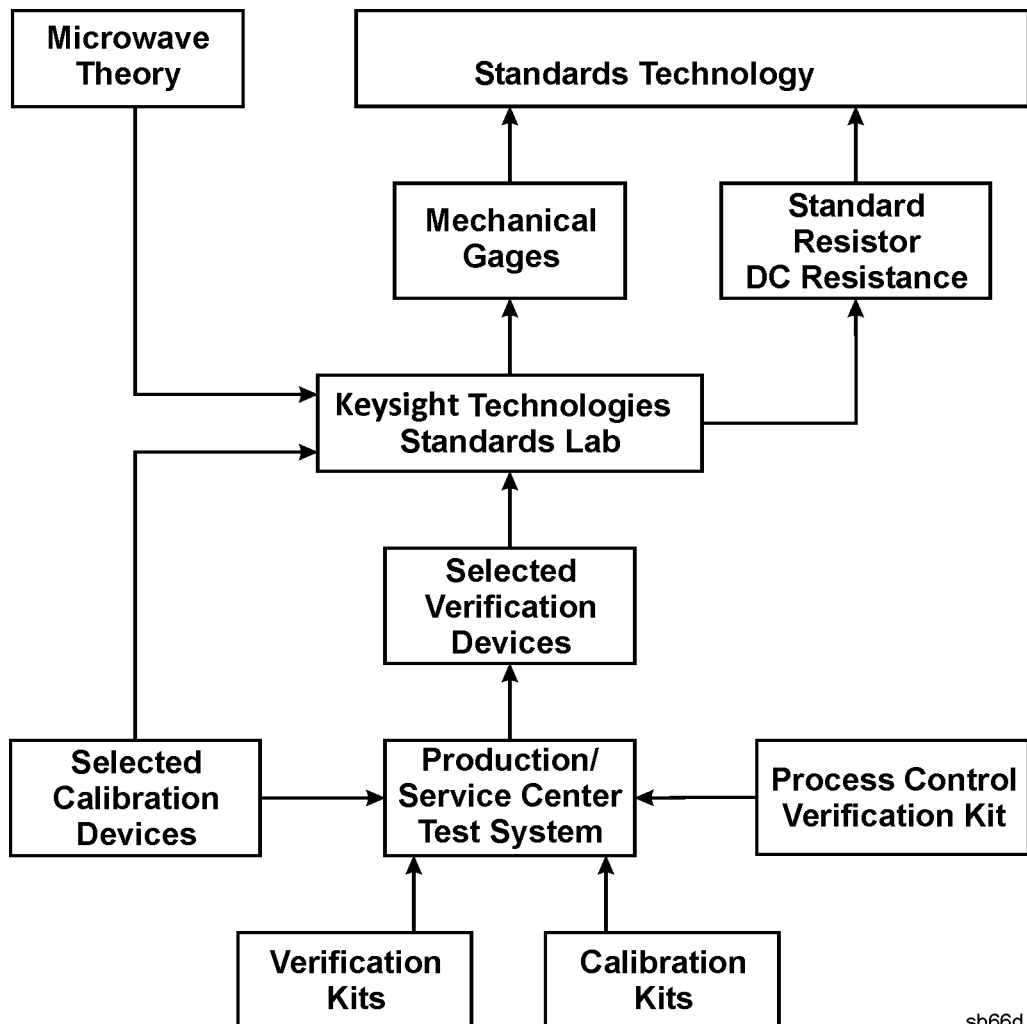

sb66d

Performing System Verification

The following verification procedure is automated by the analyzer firmware. The process for the verification is:

- connect cables to the analyzer test ports
- perform a calibration or recall a recent calibration
- run the system verification program for the verification devices

Each time through the verification process, you are prompted to make necessary connections and perform or recall a calibration as part of performing the verification. If you select to perform a calibration, you are guided through the calibration procedure. This part of the process can be eliminated if you choose to load an existing recent calibration that was created by the verification process. If necessary, refer to the analyzer's on-line embedded help for information on storing and recalling calibrations.

For each verification device, the analyzer reads a file from the verification media and sequentially measures the magnitude and phase for all four S-parameters.

CAUTION

IMPORTANT!

If a 2.4 mm or 3.5 mm termination is not connected to the test ports during the performance tests the tests will fail. Refer to "Miscellaneous/Spare Parts" in [Table 2-7 on page 15](#).

NOTE

For system verification to perform correctly, it is NECESSARY that the verification devices be measured with their female connectors connected to port 1 or 3 and their male connectors connected to port 2 or 4.

NOTE

Although the performance for all S-parameters are measured, the S_{11} and S_{22} phase uncertainties for the attenuators and airlines are less important for verifying system performance. Therefore, the limit lines will not appear on the printout.

Equipment Used in the System Verification Procedure

| Equipment Type | 1.0 mm |
|------------------|----------------------------|
| Calibration kit | 85059B |
| Verification kit | 85059V |
| Cables | Included in the 85059B Kit |
| Adapters | None required |

Cable Substitution

The test port cables specified for the network analyzer system have been characterized for connector repeatability, magnitude and phase stability with flexing, return loss, insertion loss, and aging rate. Since test port cable performance is a significant contributor to the system performance, cables of lower performance will increase the uncertainty of your measurement. It is highly recommended that the test port cables be regularly tested.

If the system verification is performed with a non-Keysight cable, ensure that the cable meets or exceeds the specifications for the test cable specified in the previous table, **“Equipment Used in the System Verification Procedure.”** Refer to the cable’s user’s guide for specifications.

Kit Substitution

Non-Keysight calibration kits and verification kits are not recommended nor supported.

System Verification Procedure

1. If you desire printed test outputs, connect a printer to the analyzer. For the printer, ensure that the correct driver is loaded and the printer is defined as the default printer. Refer to the embedded help in the analyzer for printer setup. Let the analyzer warm up for at least 90 minutes.
2. Insert the verification kit memory stick into the analyzer USB port.
3. Press **UTILITY > System > Service > System Verification**. The VNA System Verification dialog box is displayed; refer to **Figure 4-3**.

Figure 4-3 System Verification Dialog Box

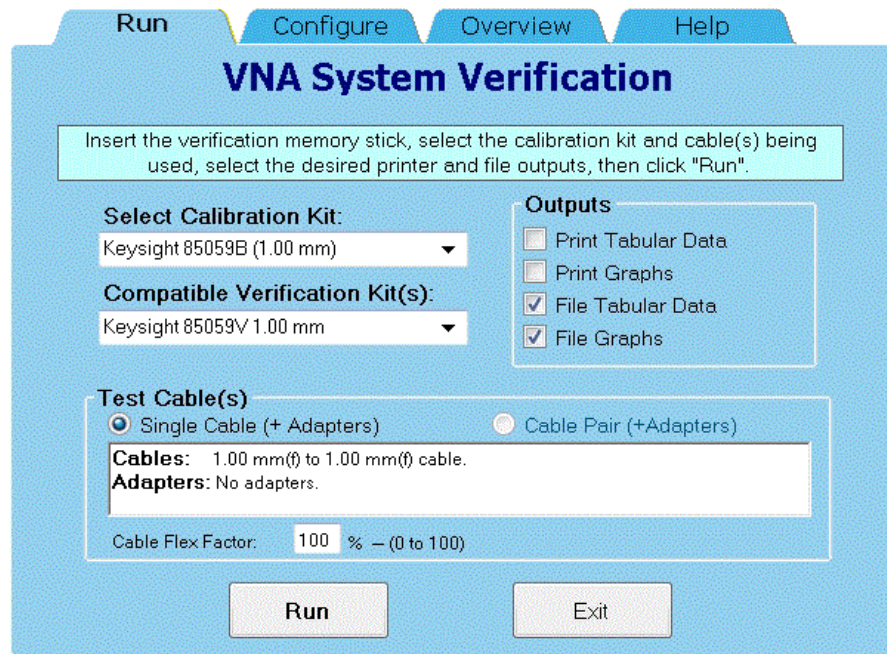

4. In the Calibration Kit box, select the calibration kit or electronic calibration module (ECal) that is being used by clicking on it. The corresponding verification kit to use is selected for you and displayed in the Verification Kit box. Refer to [Figure 4-3](#).
5. Under Outputs, select the desired output(s). Refer to [Figure 4-3](#).
 - Print Tabular Data: Prints the verification data in tabular form which includes measured data and uncertainty limits. For an example, refer to [Figure 4-5 on page 4-15](#).
 - Print Graphs: Prints the verification data in graphical form. The graphical form includes the measured data trace, factory supplied data trace, and uncertainty limits. For an example, refer to [Figure 4-6 on page 4-16](#).
 - File Tabular Data: Writes the tabular data to a text file in the Windows 7 directory
D: \SysVer.
 - File Graphs: Saves a screen image in PNG format in the Windows 7 directory
D: \SysVer.

NOTE

For printed output, it is assumed that the printer has been tested and the Windows driver is installed for the printer that is being used. The system verification test prints to the printer that has been designated as the default printer. (On the Windows Desktop display, click on My Computer, Control Panel, and then Printers to verify the printer setup.)

To modify the number of ports to be verified or to change the number of devices to measure, click on the Configure tab and make the desired selections.

6. Click **Run**.
7. Follow the instructions on the analyzer for performing a full calibration or recalling an existing recent calibration.

NOTE

When performing a full calibration, it is recommended that the calibration be saved when prompted. If the verification needs to be repeated, this calibration can be recalled, saving time.

8. Follow the instructions on the analyzer for performing the system verification; inserting the verification devices as prompted.

If the System Fails the Verification Test

NOTE

Inspect all connections. **Do not** remove the cable from the analyzer test port. This will **invalidate** the calibration that you performed earlier.

1. Disconnect and clean the device that failed the verification test.
2. Reconnect the device making sure that all connections are torqued to the proper specifications.
3. Measure the device again.
4. If the analyzer still fails the test, contact Keysight. Refer to **“Contacting Keysight” on page 4-5**.
5. Refer to **Figure 4-4** for additional troubleshooting steps.

Figure 4-4 System Verification Failure Flowchart

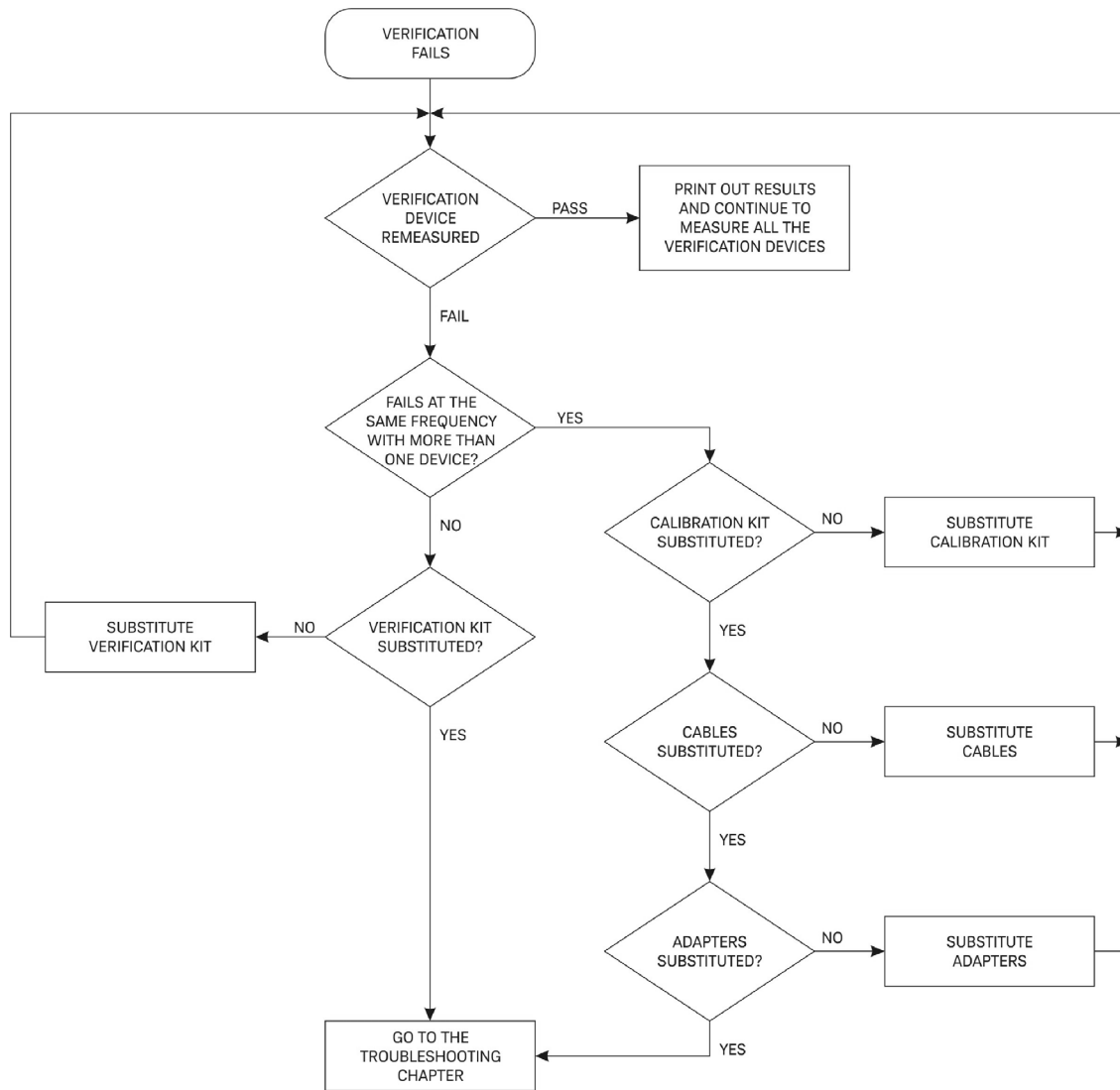

sb69d

Interpreting the Verification Results

Figure 4-5 shows an example of typical verification results with Print Tabular Data selected in the Printer Output area of the System Verification dialog box.

At the top of the printed output is the name of the device, the serial number of the device, and the date tested.

Each S-parameter measurement result is printed with frequency tested, lower and upper limit lines, the measured data, and the result of the test.

Figure 4-5 Example of Printed Tabular Verification Results

| VNA System Verification - ver. A.06.37 Test Time: 6/20/2017 4:19:33 PM | | | | | | | | |
|--|------------------------|------------------------|------------------------|------------------------|-------------------------|-------------------------|-------------------------|------------------------|
| N5291A 201; US51010043 with 85059B; | | | | | | | | |
| Match Thru; s/n 00001 S21 Results | | | | | | | | |
| Freq [GHz] | S21 MAGNITUDE (dB) | | | | S21 PHASE (deg) | | | |
| | Lower Limit (dB) | Meas'd Data (dB) | Upper Limit (dB) | Total Uncert +/- | Lower Limit (deg) | Meas'd Data (deg) | Upper Limit (deg) | Total Uncert +/- |
| 0.010 | -0.615 | -0.004 | 0.394 | 0.5044 | -4.13 | -0.03 | 2.73 | 3.4280 |
| 2.75 | -0.338 | -0.031 | 0.292 | 0.3151 | -44.43 | -42.31 | -40.19 | 2.1193 |
| 5.50 | -0.424 | -0.035 | 0.342 | 0.3831 | -87.09 | -84.36 | -81.89 | 2.5966 |
| 8.25 | -0.436 | -0.069 | 0.321 | 0.3785 | -129.25 | -126.67 | -124.10 | 2.5734 |
| 11.00 | -0.360 | -0.078 | 0.219 | 0.2894 | -170.81 | -168.84 | -166.82 | 1.9922 |
| 13.75 | -0.377 | -0.064 | 0.208 | 0.2924 | 147.03 | 149.07 | 151.08 | 2.0252 |
| 16.50 | -0.322 | -0.050 | 0.130 | 0.2258 | 105.37 | 107.08 | 108.58 | 1.6078 |
| 19.25 | -0.332 | -0.088 | 0.117 | 0.2244 | 63.23 | 65.03 | 66.48 | 1.6221 |
| 22.00 | -0.311 | -0.139 | 0.070 | 0.1905 | 21.31 | 22.97 | 24.14 | 1.4163 |
| 22.25 | -0.312 | -0.130 | 0.069 | 0.1907 | 17.47 | 19.02 | 20.29 | 1.4084 |
| 24.75 | -0.336 | -0.135 | 0.070 | 0.2031 | -20.85 | -19.24 | -17.83 | 1.5089 |
| 27.50 | -0.422 | -0.189 | 0.133 | 0.2777 | -63.48 | -61.59 | -59.39 | 2.0469 |
| 30.25 | -0.445 | -0.182 | 0.136 | 0.2904 | -105.62 | -103.96 | -101.35 | 2.1352 |
| 33.00 | -0.457 | -0.217 | 0.123 | 0.2897 | -147.69 | -145.43 | -143.35 | 2.1685 |
| 35.75 | -0.470 | -0.199 | 0.113 | 0.2918 | 170.27 | 172.39 | 174.64 | 2.1814 |
| 38.50 | -0.485 | -0.203 | 0.107 | 0.2960 | 128.26 | 130.28 | 132.73 | 2.2332 |
| 41.25 | -0.620 | -0.201 | 0.221 | 0.4203 | 85.43 | 87.84 | 91.53 | 3.0479 |
| 44.00 | -0.672 | -0.221 | 0.263 | 0.4673 | 43.15 | 46.07 | 49.97 | 3.4104 |
| 44.50 | -0.676 | -0.256 | 0.259 | 0.4675 | 35.45 | 38.45 | 42.29 | 3.4177 |
| 46.75 | -0.683 | -0.251 | 0.254 | 0.4683 | 1.05 | 4.03 | 7.88 | 3.4159 |
| 49.50 | -0.691 | -0.236 | 0.248 | 0.4693 | -41.05 | -37.99 | -34.10 | 3.4782 |

Figure 4-6 shows an example of typical verification results with Print Graphs selected in the Printer Output area of the System Verification dialog box. The printed graphical results show the following:

- the name of the device measured
- the serial number of the device
- the parameters measured
- Results of the measurements.
- Data measured at the factory from the verification kit.
- Upper and lower limit points as defined by the total system uncertainty system.

Figure 4-6 Example of Printed Graphical Verification Results (4-port is Shown)

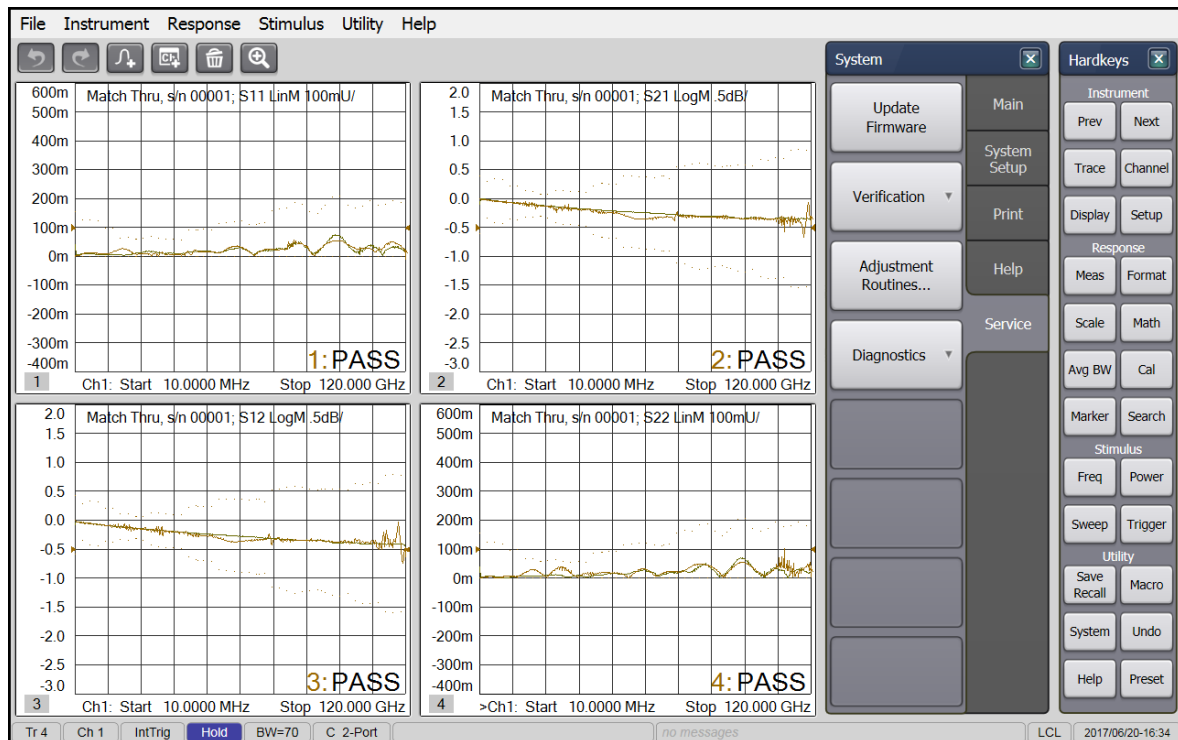

If the System Verification Fails

NOTE

If the System Verification fails, refer to **“Contacting Keysight”** on page 4-5.

Performance Verification
If the System Verification Fails

5 Maintenance and Support

Information in This Chapter

Chapter Five at-a-Glance

| Section Title | Summary of Content |
|---|--|
| “Maintenance” on page 4-2 | How to take care of your system electrically and your system’s connector care. |
| “Keysight Support, Services, and Assistance” on page 4-5 | Discusses your system’s warranty, how to contact Keysight and ship an item to Keysight for repair. |

Maintenance

WARNING

To prevent electrical shock, disconnect the analyzer from the mains source before cleaning. Use a dry cloth or one slightly dampened with water to clean the external case parts. Do not attempt to clean internally.

Physical Maintenance

Clean the cabinet, including the front panel, using a dry or slightly damp cloth only.

Electrical Maintenance

Refer to **“Keysight Support, Services, and Assistance” on page 4-5.**

Caring for Waveguide (WG) Interfaces

A clean surface at millimeter-wave frequencies is much more important than at lower frequencies because any debris on the waveguide surface can potentially distort the measurement results.

Caring for WG interfaces is not difficult. Dirt and dust can be removed using the following:

- Isopropyl alcohol 99.5%¹
- Lint-free cloth
- Pressurized air (for dust removal)

To remove dirt on the waveguide surface, simply put a few drops of isopropyl alcohol on a lint-free cloth and gently wipe the surface.

To remove dust, simply spray the pressurized air on the waveguide surface.

Principles of Connector Care

Proper connector care and connection techniques are critical for accurate and repeatable measurements. Refer to Table 5-1 for tips on connector care.

Prior to making connections to your analyzer, carefully review the information about inspecting, cleaning, and gaging connectors. Refer to the calibration kit documentation for detailed connector care information.

For course numbers about additional connector care instruction, contact Keysight Technologies. Refer to **“Contacting Keysight” on page 4-5.**

1. Use isopropyl alcohol only in a well-ventilated area. Allow all residual alcohol moisture to evaporate, and the fumes to dissipate, prior to assembling waveguide interfaces.

Table 5-1 Connector Care Quick Reference Guide

| Handling and Storage | | | |
|-----------------------------|--|--------|--|
| Do | – Keep connectors clean | Do Not | – Touch mating-plane surfaces |
| | – Extend sleeve or connector nut | | – Set connectors contact-end down |
| | – Use plastic end-caps during storage | | – Store connectors or adapters loose |
| Visual Inspection | | | |
| Do | – Inspect all connectors carefully | Do Not | – Use a damaged connector - ever |
| | – Look for metal particles, scratches, and dents | | |
| Connector Cleaning | | | |
| Do | – Try compressed air first | Do Not | – Use any abrasives |
| | – Use isopropyl alcohol ^a | | – Get liquid into plastic support beads |
| | – Clean connector threads | | |
| Gaging Connectors | | | |
| Do | – Clean and zero the gage before use | Do Not | – Use an out-of-specification connector |
| | – Use the correct gage type | | |
| | – Use correct end of calibration block | | |
| | – Gage all connectors before first use | | |
| Making Connections | | | |
| Do | – Align connectors carefully | Do Not | – Apply bending force to connection |
| | – Make preliminary connection contact lightly | | – Over tighten preliminary connection |
| | – Turn only the connector nut | | – Twist or screw any connection |
| | – Use a torque wrench for final connection | | – Tighten past torque wrench “break” point |

a. Cleaning connectors with alcohol shall only be done with the instrument’s power cord removed, and in a well-ventilated area. Allow all residual alcohol moisture to evaporate, and the fumes to dissipate prior to energizing the instrument.

Replacement Parts

Figure 5-1 PNA RF Port Connector to N5292A Test Set Lo Band Connector (2.4 mm)

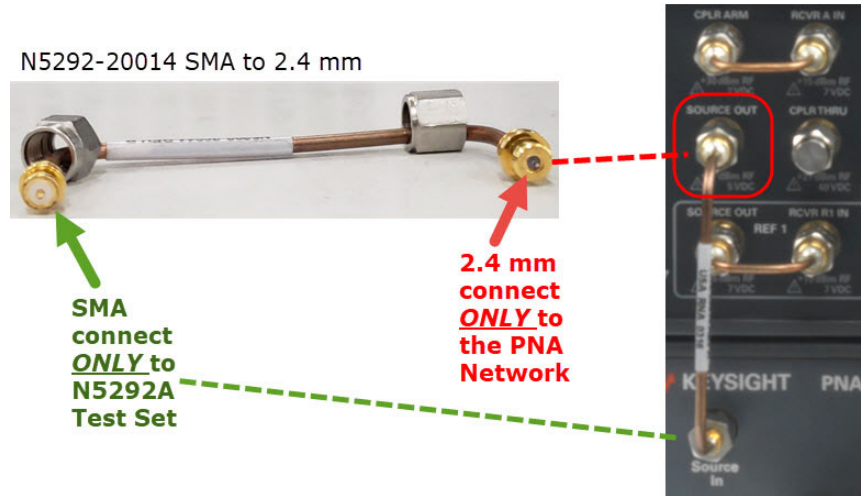

| Part Number | Description |
|-------------|--|
| N5292-20006 | Cable Assy-RF, Source Out to Test Set, SMA-SMA |
| N5292-20007 | Cable Assy-RF, 4P Test Port 3/4 to Test Set, SMA-SMA |
| N5292-20008 | Cable Assy-RF, 4P Test Port 1/2 to Test Set, SMA-SMA |
| N5292-20009 | Cable Assy-RF, 2P Test Port 1/2 to Test Set, SMA-SMA |
| N5292-20014 | Cable Assy-RF, Source Out to Test Set, SMA-2.4mm |
| N5292-20015 | Cable Assy-RF, 4P Test Port 1/2 to Test Set, SMA-2.4mm |
| N5292-20016 | Cable Assy-RF, 4P Test Port 3/4 to Test Set, SMA-2.4mm |
| N5292-20017 | Cable Assy-RF, 2P Test Port 1/2 to Test Set, SMA-2.4mm |

Keysight Support, Services, and Assistance

Information on the following topics is included in this section.

- “Service and Support Options”
- “Contacting Keysight”
- “Shipping an Item to Keysight for Service or Repair”

Service and Support Options

The N5290/1A system has a one-year on-site service warranty which covers troubleshooting the system to an individual instrument, device, or cable. The service warranty includes repair or replacement of defective components. Most repairs require that the defective component be returned to Keysight.

NOTE

Extended warranties are available in many geographical areas. Contact Keysight for additional information on available service agreements for this product. Refer to **“Contacting Keysight”**.

Contacting Keysight

Assistance with test and measurements needs and information or finding a local Keysight office are available on the Web at:

<http://www.keysight.com/find/assist>

If you do not have access to the Internet, please contact your Keysight field engineer.

NOTE

In any correspondence or telephone conversation, refer to the Keysight product by its model number and full serial number. With this information, the Keysight representative can determine whether your product is still within its warranty period.

Shipping an Item to Keysight for Service or Repair

NOTE

Keysight Technologies reserves the right to reformat or replace the internal SSD in the network analyzer, contained in this system, as part of its repair. This will erase all user information stored on the hard disk. It is imperative, therefore, that you make a backup copy of your critical test data located on the analyzer's hard disk before shipping it to Keysight for repair.

If you wish to send an item from your system to Keysight Technologies for service or repair:

- Contact Keysight to open a service order. Refer to **“Contacting Keysight”**.
- Include a complete description of the service requested or of the failure and
- a description of any failed test and any error message.
- Ship the item using the original or comparable antistatic packaging materials.

Downloading the Online PNA Millimeter-Wave Service Guides

NOTE

There are two different service guides that support a N5290/1A system:

- PNA service guide and
 - N5290/1A service guide
-

To view the online Service Guide for your PNA or N5290/1A system model number, use the following steps: To view the online Service Guide for your PNA model number, use the following steps:

1. Go to www.keysight.com.
2. In the Search box, enter the model number of the analyzer (Ex: N5290A or N5291A) and click Search.
3. Click Technical Support > Manuals.
4. Click Service Manual.
5. Click the service guide title to download the PDF file.
6. When the PDF of the Service Guide is displayed, scroll through the Contents section bookmarks to locate the information needed.



This information is subject to change without notice.

© Keysight Technologies 2011-2024

Edition 1, May 2024



N5292-90002

www.keysight.com