

Keysight M9485A PXIe Multiport Vector Network Analyzer

M9300A, Frequency Reference
M9389A, PXIe Vector Network Analyzer Source
M9309A, PXIe Vector Network Analyzer Synthesizer
M9340A, PXIe Vector Network Analyzer RF Distributor
M9376A, PXIe Vector Network Analyzer Receiver
M9377A, PXIe Vector Network Analyzer Direct Access Receiver
M9378A/B, PXIe Vector Network Analyzer Directional Coupler

Notices

© Keysight Technologies, Inc.
2015-2017

No part of this manual may be reproduced in any form or by any means (including electronic storage and retrieval or translation into a foreign language) without prior agreement and written consent from Keysight Technologies, Inc. as governed by United States and international copyright laws.

Trademark Acknowledgments

Manual Part Number

M9485-90030

Print Date

April, 2017

Published in Malaysia

Published by

Keysight Technologies
International Japan G.K,
1-3-3 Higashikawasaki-cho
Chuo-ku
Kobe-shi, Hyogo, Japan

Warranty

THE MATERIAL CONTAINED IN THIS DOCUMENT IS PROVIDED "AS IS," AND IS SUBJECT TO BEING CHANGED, WITHOUT NOTICE, IN FUTURE EDITIONS. FURTHER, TO THE MAXIMUM EXTENT PERMITTED BY APPLICABLE LAW, KEYSIGHT DISCLAIMS ALL WARRANTIES, EITHER EXPRESS OR IMPLIED WITH REGARD TO THIS MANUAL AND ANY INFORMATION CONTAINED HEREIN, INCLUDING BUT NOT LIMITED TO THE IMPLIED WARRANTIES OF MERCHANTABILITY AND FITNESS FOR A PARTICULAR PURPOSE. KEYSIGHT SHALL NOT BE LIABLE FOR ERRORS OR FOR INCIDENTAL OR CONSEQUENTIAL DAMAGES IN CONNECTION WITH THE FURNISHING, USE, OR PERFORMANCE OF THIS DOCUMENT OR ANY INFORMATION CONTAINED HEREIN. SHOULD KEYSIGHT AND THE USER HAVE A SEPARATE WRITTEN AGREEMENT WITH WARRANTY TERMS COVERING THE MATERIAL IN THIS DOCUMENT THAT CONFLICT WITH THESE TERMS, THE WARRANTY TERMS IN THE SEPARATE AGREEMENT WILL CONTROL.

Technology Licenses

The hardware and/or software described in this document are furnished under a license and may be used or copied only in accordance with the terms of such license.

Restricted Rights Legend

If software is for use in the performance of a U.S. Government prime contract or subcontract, Software is delivered and licensed as "Commercial computer software" as defined in DFAR 252.227-7014 (June 1995), or as a "commercial item" as defined in FAR 2.101(a) or as "Restricted computer software" as defined in FAR 52.227-19 (June 1987) or any equivalent agency regulation or contract clause. Use, duplication or disclosure of Software is subject to Keysight Technologies' standard commercial license terms, and non-DOD Departments and Agencies of the U.S. Government will receive no greater than Restricted Rights as defined in FAR 52.227-19(c)(1-2) (June 1987). U.S. Government users will receive no greater than Limited Rights as defined in FAR 52.227-14 (June 1987) or DFAR 252.227-7015 (b)(2) (November 1995), as applicable in any technical data.

Safety Notices

CAUTION

A CAUTION notice denotes a hazard. It calls attention to an operating procedure, practice, or the like that, if not correctly performed or adhered to, could result in damage to the product or loss of important data. Do not proceed beyond a CAUTION notice until the indicated conditions are fully understood and met.

WARNING

A WARNING notice denotes a hazard. It calls attention to an operating procedure, practice, or the like that, if not correctly performed or adhered to, could result in personal injury or death. Do not proceed beyond a WARNING notice until the indicated conditions are fully understood and met.

1 **Getting Started**

Introduction	5
Related Documentation	5
STEP 1. Unpack and Inspect the Network Analyzer Modules	6
Inspect for Damage	7
How to Return an Instrument for Service	7
STEP 2. Check the Shipment	8
STEP 3. Install the Network Analyzer Modules	9
Recommended Best Practices to Ensure Proper and Safe Module Operating Conditions	9
Tools Required for the Installation Procedure	9
Installation Procedure	10
STEP 4. Install the Software	38
System Requirements	38
Hardware Requirements	38
Power Up the Controller	39
Software Installation Overview	39
STEP 5. Verify Operation of the Network Analyzer Modules	41
Execute the M9385A Soft Front Panel Application	41
The Operator's Check	41
Port Configuration/System Power Calibration	41

2 **Getting Help with Your Network Analyzer Module**

Help System	43
Contacting Keysight	44

1 Getting Started

Introduction

The M9485A PXIe vector Network Analyzer consists of M9300A (Frequency Reference), M9309A (Synthesizer), M9389A (Source Output), M9340A (Distributors), M9376A (VNA Receiver), M9377A (Direct Access Receiver) and M9378A/B (Directional Coupler). M9389A includes M9309A and M9310A.

You may add as many receivers as you require and have n-port Network Analyzers up to 24-ports, according to the number of receiver modules. Each module can be controlled with the M9485A Soft Front Panel and remote commands (IVI, SCPI). This allows you to make the network analyzer measurement just as the n-port Network Analyzer.

The scope of this Startup Guide is to detail the processes of receiving and installing the network analyzer module and cables that compose the Keysight M9485A PXIe Vector Network Analyzer modules. Additionally, installing the required software and verifying network analyzer module operation is documented. If you have any questions after reviewing this information, please contact your local Keysight Technologies Inc. representative or contact us through our support Website at <http://www.keysight.com/support>.

Related Documentation

You can find all M9485A PXIe network analyzer module documentation and other resources at: <http://www.keysight.com/find/m9485A> or at the respective product pages on www.keysight.com (go to **Document Library > Manuals**).

STEP 1. Unpack and Inspect the Network Analyzer Modules

CAUTION

The network analyzer modules are shipped in materials which prevent damage from static. The modules should only be removed from the packaging in an anti-static area ensuring that correct anti-static precautions are taken. Store all modules in anti-static envelopes when not in use.

Electrostatic discharge (ESD) can damage or destroy electronic components. Use a static-safe work station to perform all work on electronic assemblies. **Figure 1-1** shows a static-safe work station using two types of ESD protection: conductive table-mat and wrist-strap combination, and conductive floor-mat and heel-strap combination. Both types, when used together, provide a significant level of ESD protection. Of the two, only the table-mat and wrist-strap combination provides adequate ESD protection when used alone. To ensure user safety, the static-safe accessories must provide at least 1 meg-ohm of isolation from ground.

WARNING

Do NOT use these techniques for a static-safe work station when working on circuitry with a voltage potential greater than 500 volts.

Figure 1-1

ESD protection setup

ESD

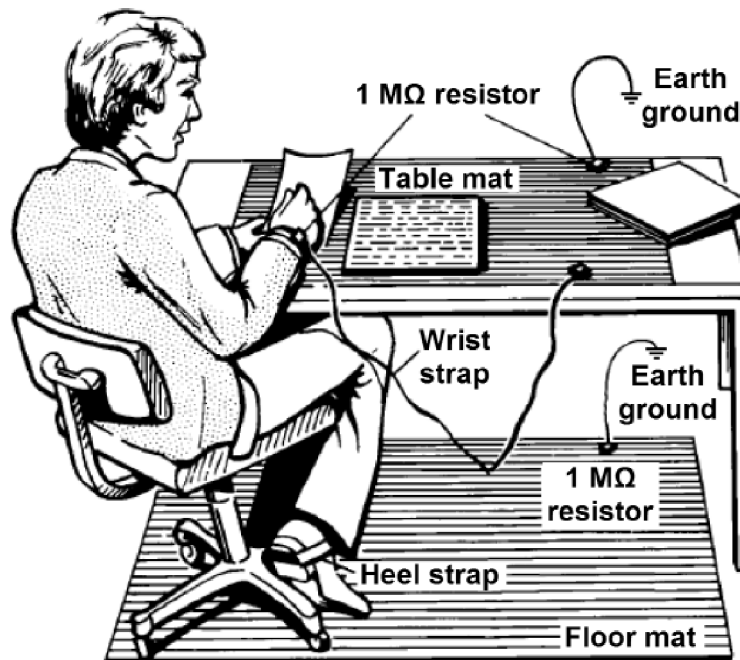

M9370_001_101

Unpack the network analyzer modules from the shipping containers. Keep the black plastic port protector and the shipping containers for possible reuse.

Inspect for Damage

After unpacking a network analyzer module, inspect it for any shipping damage. Report any damage to the shipping agent immediately, as such damage is not covered by the warranty.

CAUTION

To avoid damage when handling the network analyzer modules, do not touch exposed connector pins

How to Return an Instrument for Service

Should it become necessary to return a network analyzer module for repair or service, follow the steps below:

1. Review the warranty information shipped with your product.
2. Contact Keysight to obtain a Return Material Authorization (RMA) and return address. For assistance finding Keysight contact information, go to www.keysight.com/find/assist (worldwide contact information for repair and service).
3. Write the following information on a tag and attach it to the network analyzer module:
 - Name and address of owner. A P.O. box is not acceptable as a return address.
 - Network analyzer module serial numbers. The serial number label is located on the side panel of the module. The serial number can also be read from the Soft Front Panel (SFP) interface, after the hardware is installed.
 - Description of the service required or the failure.
4. On the shipping label, write ATTENTION REPAIR DEPARTMENT and the RMA number.
5. Ship the analyzer module using the original packaging materials. Shipping the analyzer module in anything other than the original packaging may result in non-warranted damage.

NOTE

In your correspondence, refer to the network analyzer module by serial number and by model number.

STEP 2. Check the Shipment

The M9485A consists of several modules, cables and dividers. Use the Contents List in the shipping container to verify the completeness of your shipment. If not complete, refer to **“Contacting Keysight” on page 44**.

STEP 3. Install the Network Analyzer Modules

NOTE

These modules can be used in a chassis with a PXIe, or PXI-H chassis slots.

Recommended Best Practices to Ensure Proper and Safe Module Operating Conditions

- Ensure proper chassis air flow is maintained.
- The use of a Keysight M9018A chassis is recommended for optimum temperature control. If a different chassis is used, make sure it provides thermal protection if fans become inoperable or forced air cooling is obstructed.
 - If using the Keysight M9018A PCIe Cable Interface, download the *Keysight Multiple PXIe and AXIe Chassis System Configuration Tool*. Save the file to your local hard drive; do not try to open the file from the Internet location.
- Use slot blockers and EMC filler panels in empty module slots to ensure proper operating temperatures. Keysight chassis and slot blockers optimize module temperature performance and reliability of test.
- Set chassis fans to high or auto. Do not disable fans.
- Position chassis to allow plenty of space around chassis air intake and fan exhaust.
- At ambient temperatures above 45° C (113° F) set the chassis fan to high.

Figure 1-2 M9485A chassis air flow

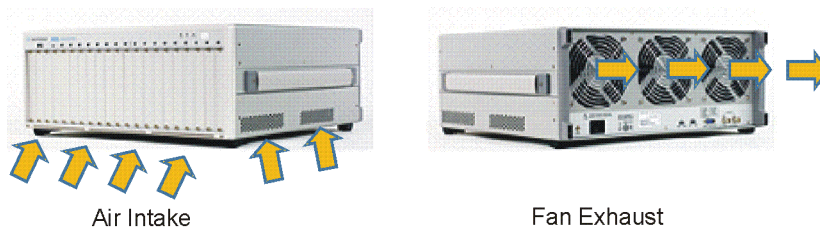

The M9018A has multiple air intakes located on the lower sides, lower front and bottom front of chassis.
Fan exhausts through the rear of the chassis

M9370_001_109

Tools Required for the Installation Procedure

- Phillips #1 torque driver, set to 4 in-lb (0.45 N.m) - not supplied.
- Socket adapter (part number M9485-23001) - supplied.

Getting Started

STEP 3. Install the Network Analyzer Modules

- Torque driver (for use with socket adapter), set to 8 in-lb (0.91 N.m) - not supplied.
- 8710-2804 Driver-HEX Power bit - supplied.
- Cable removal tool (part number 5002-3361) - supplied.
- Torque Wrench for SMA, set to 8 in-lb (0.91 N.m) - not supplied.
- 5.5 mm open end wrench - not supplied.

Installation Procedure

CAUTION

PXI hardware does not support “hot-swap” (changing network analyzer modules while power is applied to the chassis) capabilities. Before installing or removing a module to/from the chassis, power-off the chassis to prevent damage to the module.



The network analyzer module can be installed in any PXIe or hybrid PXI slot marked with a peripheral slot compatibility image (solid black circle for PXIe, or solid black circle with the letter “H” for hybrid).

1. Make sure that the line cord is plugged in to establish earth ground and that the chassis power switch is Off (see callouts 1 and 3 in [Figure 1-3 on page 11](#)).
2. Wear a grounded wrist strap for this procedure (see callout 2 in [Figure 1-3 on page 11](#)).
3. If the chassis has multiple fan speed settings, ensure that the fan switch is set to high or auto.
4. Position the chassis to provide ample space between the chassis fan intake and exhaust vents. Blockage by walls or obstructions affects the air flow needed for cooling. (Refer to the chassis documentation for more information about cooling.)
5. Before inserting the network analyzer module into the chassis, back-out the top mounting screw (see callout 7 in [Figure 1-3 on page 11](#)) on the module to ensure that there is no interference between the screws and the mounting rails.
6. Holding the module by the injector/ejector handle, slide it into a slot, as shown in callouts 4 – 6 in [Figure 1-3 on page 11](#).
 - a. Install the module into the slot of the chassis by placing the module card edges into the front module guides (top and bottom).

Getting Started

STEP 3. Install the Network Analyzer Modules

- b. Hold down the silver locking tab while pushing down the injector/ejector handle to the unlatched (downward) position, and slide the module to the rear of the chassis.
- c. Slide the module completely into the chassis. When you begin to feel resistance, pull up on the injector/ejector handle to fully inject the module into the chassis. The injector/ejector handle should lock into place. (To remove the module from the chassis, you must first press the injector/ejector handle to unlock it.)

Figure 1-3 Installing the Network Analyzer Module

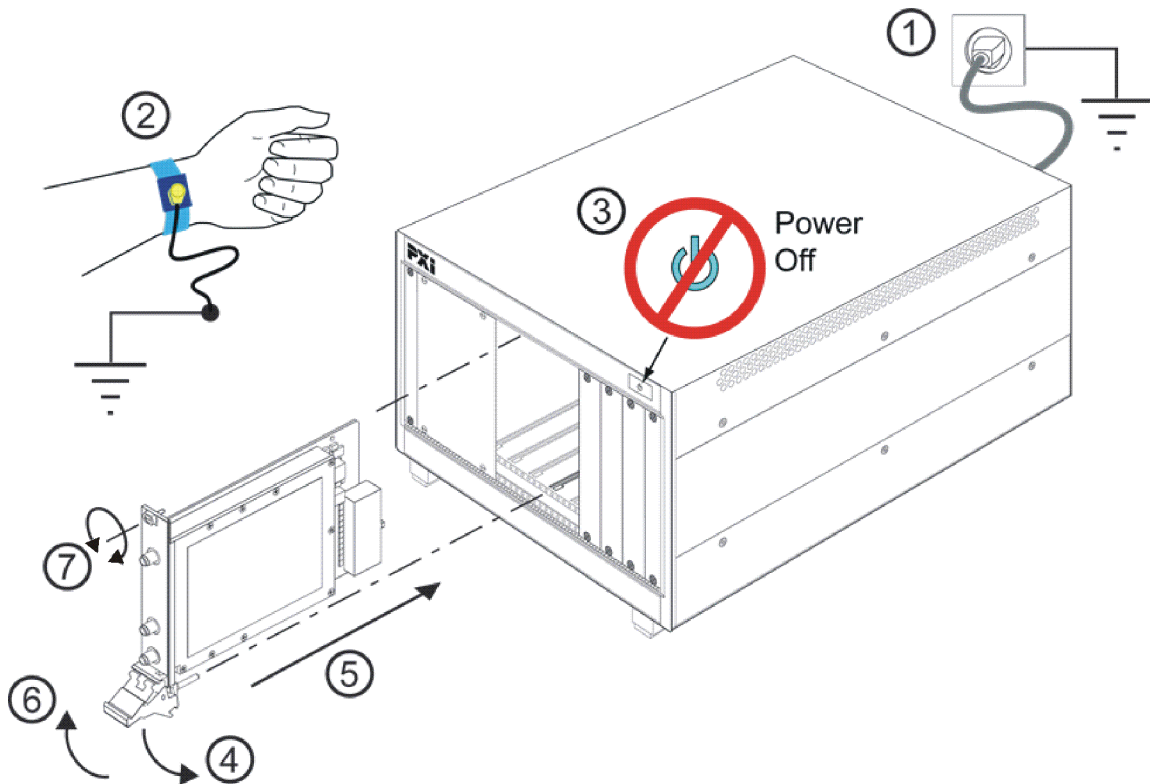

M9370_001_201

7. Repeat for other modules, if present.
8. Modules should be installed from left to right and not otherwise.
9. If the number of receiver is equal or less than 6, up to 6-port module on a single chassis configuration can be applied. Hence, for up to 6-port module, Case 1 [Figure 1-4](#) or Case 2 [Figure 1-5](#) can be applied.

Getting Started
 STEP 3. Install the Network Analyzer Modules

10. When placing all the modules by the sequence, place the screws at the top and bottom of each module but keep all the screws loose until all module are properly placed.

NOTE

There are two M9309As in each configuration. They are not identical. M9309A of M9389A should be installed next to M9310A. M9389A consists of M9309A and M9010A.

There are 3 options of receiver installation, standard receiver (M9376A) installation, direct access receiver (M9377A) installation and configurable test set (M9377A and M9378A/B) installation. All 3 installations are explained in the following sections.

Standard Receiver (M9376A) Installation

Module location for single chassis can be either one from the following two configuration for single chassis. If each module is not placed in the right slot, the M9485A software will not be able to control them.

- **Figure 1-4 on page 12** shows up to 12-port module on a single chassis configuration when only standard receiver modules are installed.
- **Figure 1-5 on page 13** shows the configuration of 6 or lesser standard receiver modules on a single chassis.

Figure 1-4 Case 1: Up to 12-port Module in One Chassis Configuration

Chassis A	
Slot 18	M9376A Receiver (Optional)
Slot 17	M9376A Receiver (Optional)
Slot 16	M9376A Receiver (Optional)
Slot 15	M9376A Receiver (Optional)
Slot 14	M9376A Receiver (Optional)
Slot 13	M9376A Receiver (Optional)
Slot 12	M9376A Receiver (Optional)
Slot 11	M9376A Receiver (Optional)
Slot 10	M9376A Receiver (Optional)
Slot 9	M9376A Receiver (Optional)
Slot 8	M9376A Receiver
Slot 7	M9376A Receiver
Slot 6	M9340A Distributor
Slot 5	M9309A Synthesizer
Slot 4	M9300A Reference
Slot 3	M9309A Synthesizer (M9389A)
Slot 2	M9310A Source Output (M9389A)
Slot 1	

Getting Started
 STEP 3. Install the Network Analyzer Modules

Figure 1-5 Case 2: Up to 6-port Module in One Chassis Configuration

Chassis A		
Slot 18	M9376A	Receiver (Optional)
Slot 17	M9376A	Receiver (Optional)
Slot 16	M9376A	Receiver (Optional)
Slot 15	M9376A	Receiver (Optional)
Slot 14	M9376A	Receiver
Slot 13	M9376A	Receiver
Slot 12	M9340A	Distributor
Slot 11	M9309A	Synthesizer
Slot 10	M9300A	Reference
Slot 9	M9309A	Synthesizer (M9389A)
Slot 8	M9310A	Source Output (M9389A)
Slot 7		
Slot 6		
Slot 5		
Slot 4		
Slot 3		
Slot 2		
Slot 1		

Module location for two chassis can be either one from the following two configuration for two chassis.

- **Figure 1-6 on page 13** shows up to 24-port module on two chassis configuration with standard receiver modules, M9376A.
- **Figure 1-7 on page 14**, shows up to 12-port module, also on two chassis configuration with standard receiver modules, M9376A.

Figure 1-6 Case 1: Up to 24-port Module in Two Chassis Configuration

Chassis B		
Slot 18	M9376A	Receiver (Optional)
Slot 17	M9376A	Receiver (Optional)
Slot 16	M9376A	Receiver (Optional)
Slot 15	M9376A	Receiver (Optional)
Slot 14	M9376A	Receiver (Optional)
Slot 13	M9376A	Receiver (Optional)
Slot 12	M9376A	Receiver (Optional)
Slot 11	M9376A	Receiver (Optional)
Slot 10	M9376A	Receiver (Optional)
Slot 9	M9376A	Receiver (Optional)
Slot 8	M9376A	Receiver
Slot 7	M9376A	Receiver
Slot 6	M9340A	Distributor
Slot 5	M9340A	Distributor
Slot 4	M9300A	Reference
Slot 3		
Slot 2		
Slot 1		

Chassis A		
Slot 18	M9376A	Receiver (Optional)
Slot 17	M9376A	Receiver (Optional)
Slot 16	M9376A	Receiver (Optional)
Slot 15	M9376A	Receiver (Optional)
Slot 14	M9376A	Receiver (Optional)
Slot 13	M9376A	Receiver (Optional)
Slot 12	M9376A	Receiver (Optional)
Slot 11	M9376A	Receiver (Optional)
Slot 10	M9376A	Receiver (Optional)
Slot 9	M9376A	Receiver (Optional)
Slot 8	M9376A	Receiver
Slot 7	M9376A	Receiver
Slot 6	M9340A	Distributor
Slot 5	M9340A	Distributor
Slot 4	M9309A	Synthesizer
Slot 3	M9309A	Synthesizer (M9389A)
Slot 2	M9310A	Source Output (M9389A)
Slot 1	M9021A	PCIe I/F

Getting Started
STEP 3. Install the Network Analyzer Modules

Figure 1-7 Case 2: Up to 12-port Module in Two Chassis Configuration

Chassis #B																	
Slot 18	M9376A	Receiver (Optional)															
Slot 17	M9376A	Receiver (Optional)															
Slot 16	M9376A	Receiver (Optional)															
Slot 15	M9376A	Receiver (Optional)															
Slot 14	M9376A	Receiver															
Slot 13	M9376A	Receiver															
Slot 12	M9340A	Distributor															
Slot 11	M9340A	Distributor															
Slot 10	M9300A	Reference															
Slot 9																	
Slot 8																	
Slot 7																	
Slot 6																	
Slot 5																	
Slot 4																	
Slot 3																	
Slot 2																	
Slot 1																	

Chassis #A																	
Slot 18	M9376A	Receiver (Optional)															
Slot 17	M9376A	Receiver (Optional)															
Slot 16	M9376A	Receiver (Optional)															
Slot 15	M9376A	Receiver (Optional)															
Slot 14	M9376A	Receiver															
Slot 13	M9376A	Receiver															
Slot 12	M9340A	Distributor															
Slot 11	M9340A	Distributor															
Slot 10	M9309A	Synthesizer															
Slot 9	M9309A	Synthesizer (M9389A)															
Slot 8	M9310A	Source Output (M9389A)															
Slot 7																	
Slot 6																	
Slot 5																	
Slot 4																	
Slot 3																	
Slot 2																	
Slot 1																	

NOTE

In these instructions, four network analyzer modules are configured. Use these instructions as a general guide when installing a different number of modules.

Direct Access Receiver (M9377A) Installation

If you are installing the direct access receiver, M9377A only (without the directional coupler, M9378A), the installation procedure is the same as standard receiver M9376A installation **“Standard Receiver (M9376A) Installation” on page 12.**

Configurable Test Set (M9377A and M9378A/B) Installation

- a. The installation of the Configurable Test Set differs from installation of the Standard Receiver. Due to the semi rigid cables usage, there is limitation of how 2-way and 4-way divider can be positioned. It is not possible to use 4-way divider only for the Configurable Test Set configuration. Refer to **“2-Way Divider and 4-Way Divider Installation” on page 19** to learn more on how to install the dividers on the modules.

Getting Started
 STEP 3. Install the Network Analyzer Modules

- b. **Table 1-1, Table 1-2, Table 1-3, Table 1-4, Table 1-5 and Table 1-6** show the complete possible configuration for combination of Standard Receiver or Direct Access Receiver and Configurable Test Set. In the tables, 76A (M9376A) can be replaced with the M9377A if it is used as direct access receiver usage.

NOTE

3 way divider is available separately from M9485A as Y9485A-003. Many other combination may be possible if you use 3 way divider. If cables can be connected correctly without any stress and software can detect all modules properly, the configuration will work. Contact with Keysight if you need an assistance.

Table 1-1

Possible Configuration for Combination of Configurable Test Set (1 Set) and Standard Receiver or Direct Access Receiver

# of	Slot #												
77A & 78A pair	76A	7	8	9	10	11	12	13	14	15	16	17	18
1	1	78	77A	76A									
1	3	78	77A	76A	76A	76A							
1	5	78	77A	76A	76A	76A	76A	76A					
1	7	78	77A	76A	76A	76A	76A	76A	76A	76A			
1	9	77A	78A	76A	76A	76A	76A	76A	76A	76A	76A	76A	
1	1	76A	77A	78									
1	5	76A	76A	76A	77A	78	76A	76A					
1	7	76A	76A	76A	77A	78	76A	76A	76A	76A			
1	9	76A	76A	76A	77A	78	76A	76A	76A	76A	76A	76A	76A
1	5	76A	76A	76A	76A	77A	78	76A					
1	7	76A	76A	76A	76A	77A	78	76A	76A	76A			
1	9	76A	76A	76A	76A	77A	78	76A	76A	76A	76A	76A	76A
1	5	76A	76A	76A	76A	76A	76A	76A	77A	78			
1	7	76A	76A	76A	76A	76A	76A	76A	77A	78	76A	76A	
1	9	76A	76A	76A	76A	76A	76A	76A	76A	76A	77A	78	

Table 1-2

Possible Configuration for Combination of Configurable Test Set (2 Sets) and Standard Receiver or Direct Access Receiver

# of	Slot #												
77A & 78A pair	76A	7	8	9	10	11	12	13	14	15	16	17	18
2	0	78	77A	77A	78								

Getting Started
 STEP 3. Install the Network Analyzer Modules

# of	Slot #													
	77A & 78A pair	76A	7	8	9	10	11	12	13	14	15	16	17	18
2	2	78	77A	77A	78	76A	76A							
2	4	78	77A	77A	78	76A	76A	76A	76A					
2	6	78	77A	77A	78	76A	76A	76A	76A	76A	76A			
2	8	78	77A	77A	78	76A	76A	76A	76A	76A	76A	76A	76A	76A
2	2	78	77A	76A	78	77A	76A							
2	4	78	77A	76A	78	77A	76A	76A	76A					
2	6	78	77A	76A	78	77A	76A	76A	76A	76A	76A			
2	8	78	77A	76A	78	77A	76A	76A	76A	76A	76A	76A	76A	76A
2	2	78	77A	76A	76A	77A	78							
2	4	78	77A	76A	76A	76A	76A	76A	77A	78				
2	6	78	77A	76A	76A	76A	76A	76A	77A	78	76A	76A		
2	8	78	77A	76A	76A	76A	76A	76A	77A	78	76A	76A	76A	76A
2	6	78	77A	76A	76A	76A	76A	76A	76A	78	77A	76A		
2	8	78	77A	76A	76A	76A	76A	76A	76A	78	77A	76A	76A	76A
2	6	78	77A	76A	76A	76A	76A	76A	76A	76A	77A	78		
2	8	78	77A	76A	76A	76A	76A	76A	76A	76A	76A	76A	77A	78
2	2	76A	77A	78	78	77A	76A							
2	4	76A	77A	78	78	77A	76A	76A	76A					
2	6	76A	77A	78	78	77A	76A	76A	76A	76A	76A			
2	8	76A	77A	78	77A	78	76A	76A	76A	76A	76A	76A	76A	76A
2	4	76A	76A	76A	77A	78	76A	77A	78					
2	6	76A	76A	76A	77A	78	76A	77A	78	76A	76A			
2	8	76A	76A	76A	77A	78	76A	77A	78	76A	76A	76A	76A	76A
2	6	76A	76A	76A	77A	78	76A	76A	78	77A	76A			
2	8	76A	76A	76A	77A	78	76A	76A	78	77A	76A	76A	76A	76A
2	6	76A	76A	76A	77A	78	76A	76A	76A	77A	78			
2	8	76A	76A	76A	76A	78	77A	76A	78	77A	76A	76A	76A	76A
2	6	76A	76A	76A	76A	78	77A	76A	78	77A	76A			
2	8	76A	76A	76A	76A	78	77A	76A	78	77A	76A	76A	76A	76A
2	6	76A	76A	76A	76A	78	77A	76A	78	77A	76A			
2	8	76A	76A	76A	76A	78	77A	76A	78	77A	76A	76A	76A	76A
2	8	76A	76A	76A	76A	76A	76A	76A	76A	78	77A	77A	78	
2	8	76A	76A	76A	76A	76A	76A	76A	76A	78	77A	77A	78	

Getting Started
 STEP 3. Install the Network Analyzer Modules

Table 1-3 Possible Configuration for Combination of Configurable Test Set (3 Sets) and Standard Receiver or Direct Access Receiver

# of	Slot #												
77A & 78A pair	76A	7	8	9	10	11	12	13	14	15	16	17	18
3	1	78	77A	77A	78	78	77A	76A					
3	3	78	77A	77A	78	78	77A	76A	76A	76A			
3	5	78	77A	77A	78	78	77A	76A	76A	76A	76A	76A	
3	1	78	77A	77A	78	76A	77A	78					
3	3	78	77A	77A	78	76A	76A	76A	77A	78			
3	5	78	77A	77A	78	76A	76A	76A	77A	78	76A	76A	
3	5	78	77A	77A	78	76A	76A	76A	76A	78	77A	76A	
3	5	78	77A	77A	78	76A	76A	76A	76A	76A	77A	78	
3	1	78	77A	76A	78	77A	77A	78					
3	3	78	77A	76A	78	77A	76A	76A	77A	78			
3	5	78	77A	76A	78	77A	76A	76A	77A	78	76A	76A	
3	5	78	77A	76A	78	77A	76A	76A	76A	78	77A	76A	
3	5	78	77A	76A	76A	76A	76A	77A	78	78	77A	76A	
3	5	76A	76A	76A	76A	78	77A	77A	78	78	77A	76A	
3	5	76A	76A	76A	76A	78	77A	77A	78	76A	77A	78	
3	5	76A	76A	76A	76A	78	77A	76A	78	77A	77A	78	

Table 1-4 Possible Configuration for Combination of Configurable Test Set (4 Sets) and Standard Receiver or Direct Access Receiver

# of	Slot #												
77A & 78A pair	76A	7	8	9	10	11	12	13	14	15	16	17	18
4	0	78	77A	77A	78	78	77A	77A	78				
4	2	78	77A	77A	78	78	77A	77A	78	76A	76A		
4	2	78	77A	77A	78	78	77A	76A	76A	77A	78		
4	4	78	77A	77A	78	78	77A	77A	78	76A	76A	76A	76A
4	2	78	77A	77A	78	76A	77A	78	78	77A	76A		
4	4	78	77A	77A	78	76A	77A	78	78	77A	76A	76A	76A
4	4	78	77A	77A	78	76A	76A	76A	76A	78	77A	77A	78
4	2	78	77A	76A	78	77A	77A	78	78	77A	76A		

Getting Started
STEP 3. Install the Network Analyzer Modules

# of	Slot #												
77A & 78A pair	76A	7	8	9	10	11	12	13	14	15	16	17	18
4	4	78	77A	76A	78	77A	77A	78	78	77A	76A	76A	76A
4	4	78	77A	76A	76A	76A	76A	77A	78	78	77A	77A	78
4	4	76A	76A	76A	76A	78	77A	77A	78	78	77A	77A	78

Table 1-5 Possible Configuration for Combination of Configurable Test Set (5 Sets) and Standard Receiver or Direct Access Receiver

# of	Slot #												
77A & 78A pair	76A	7	8	9	10	11	12	13	14	15	16	17	18
5	1	78	77A	77A	78	78	77A	77A	78	78	77A	76A	
5	1	78	77A	77A	78	78	77A	77A	78	76A	77A	78	
5	1	78	77A	77A	78	76A	77A	78	78	77A	77A	78	
5	1	78	77A	76A	78	77A	77A	78	78	77A	77A	78	

Table 1-6 Possible Configuration for Combination of Configurable Test Set (6 Sets) and Standard Receiver or Direct Access Receiver

# of	Slot #												
77A & 78A pair	76A	7	8	9	10	11	12	13	14	15	16	17	18
6	0	78	77A	77A	78	78	77A	77A	78	78	77A	77A	78

NOTE

If you are using other chassis than Keysight's, you may need a routing for trigger path of the chassis. Refer to the M9485A FAQ page on the Keysight.com for more information (<http://www.keysight.com/find/m9485a>)

M9341A (Digital I/O), M9341B (Digital/Analog I/O) and M9379A (RF Amplifier) Installation

M9485A can work with M9341A/B and M9379A. Here is the limitation of module

M9379A Installation:

- Empty slot is not allowed between source module and last receiver modules.

Getting Started

STEP 3. Install the Network Analyzer Modules

- When M9379A is installed between receivers, the sync signal connection at the front panel between M9379A and M9376A/77A is necessary.
- Refer to Online Help > Programming > I/O Connector (M9845A) > Example 5 and 6.

WARNING

When connecting or disconnecting a cable to the M9379A module, do not touch the open end of the cable. Doing so may damage the module by electrostatic discharge (ESD).

M9341A/B Installation:

- Only one M9341A/B can be installed in a chassis.

2-Way Divider and 4-Way Divider Installation

- a. Upon placing all the modules into the chassis, if you are using dividers, fasten the modules only after alignment plate is installed. **Figure 1-8 on page 20** shows the installation of the M9376-60016 4-Way alignment plate on the modules.
- b. Only after the alignment plate is installed, the black plate cover should be removed. 2-port module have the option of using M9376-60014 2-Way alignment plate.
- c. Next, fasten the M9376-62006 4-way divider by ensuring that the SMP-SMP adapter are fit well through the alignment plate, as shown in **Figure 1-9 on page 21**. Use the 8710-2804 Driver HEX Power bit to fix the screw on divider. 2-port modules have the option of using 3 of the M9376-62004 2-way divider. Confirm that the screws on 2/4 way divider are fasten firmly.
- d. In the case of Standard Receivers M9376A only, 4-port modules requires 3 of the 4-way divider to be connected. Similarly, 8-port modules require 6 of the 4-way divider and 12-port modules require 9 of the 4-way divider.
- e. In the case of Configurable Test Set, there are several options of divider combinations. Refer to **“Configurable Test Set (M9377A and M9378A/B) Installation” on page 14** for the full combinations.
- f. Tighten the top mounting screw (see callout 7 in **Figure 1-3**) and the bottom mounting screw (located below the injector/ejector handle) on the module(s) using a Phillips #1 torque drive set to 4 in-lbs (0.45 N.m).

Getting Started
STEP 3. Install the Network Analyzer Modules

Figure 1-8 Alignment Plate Installation

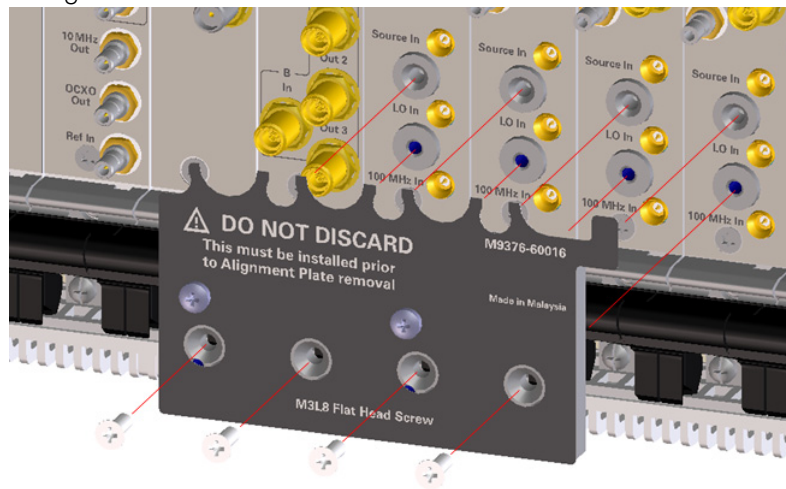

Getting Started
STEP 3. Install the Network Analyzer Modules

Figure 1-9 Installing 4-Way Divider

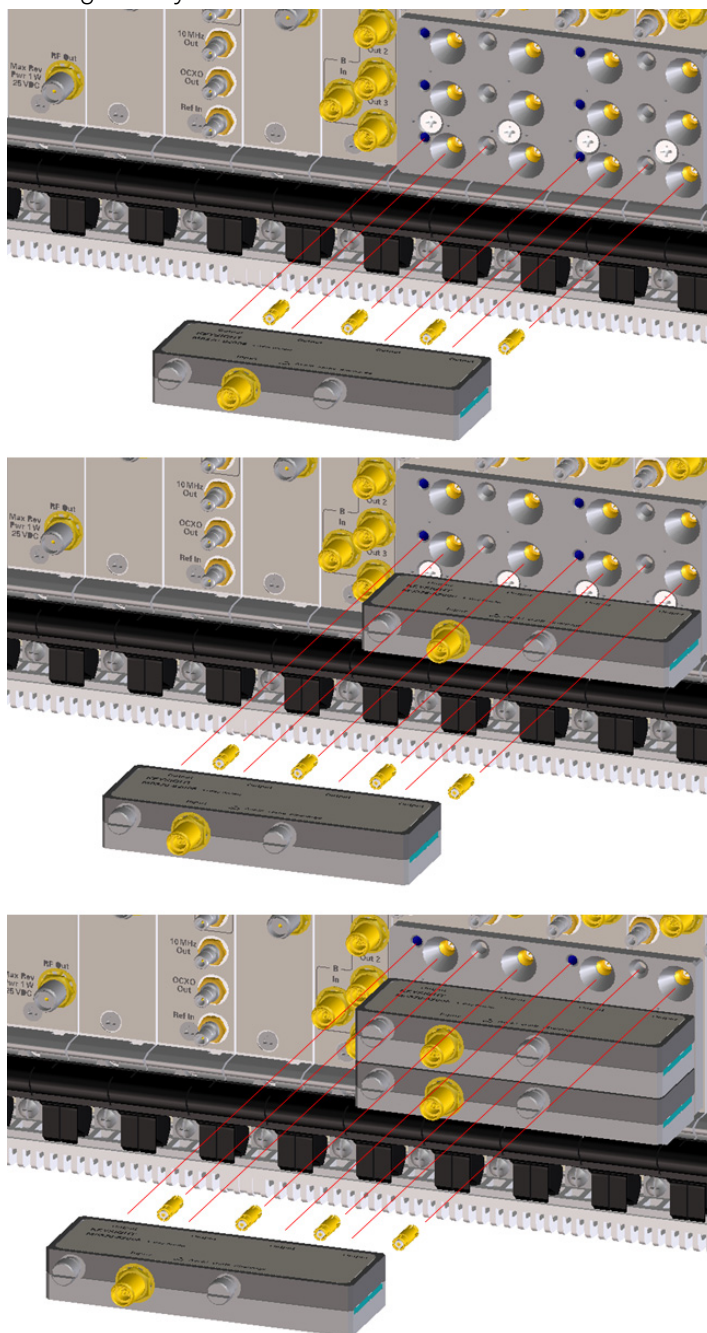

NOTE

SMP-SMP adapters are furnished with the divider at factory shipment. Do not remove the SMP-SMP adapters from dividers except in case of replacement.

CAUTION

Insert the SMP-SMP adapters into the receiver's input carefully as they are very sensitive and the inner conductors tend to bend.

Getting Started

STEP 3. Install the Network Analyzer Modules

- g. Place the labels on the divider as shown in **Figure 1-10 on page 22** below, on the dividers. The color in circle shows the color of the cable.

Figure 1-10 Label for Divider

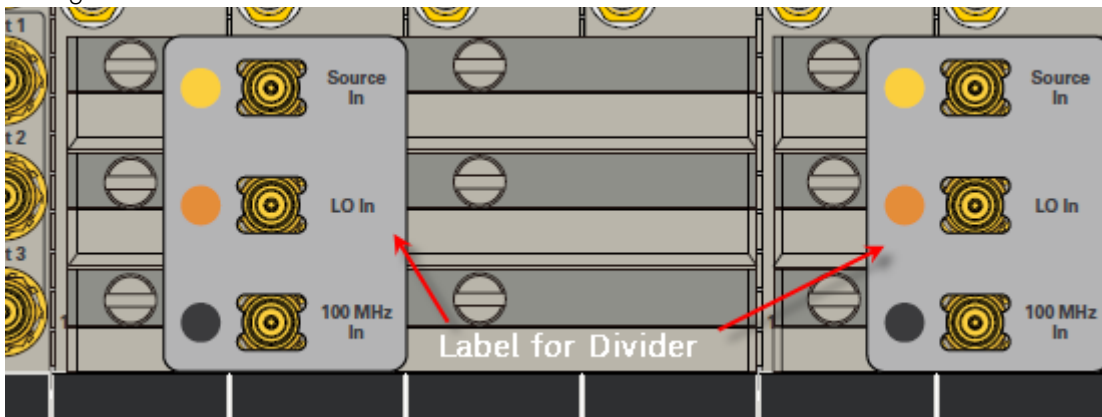
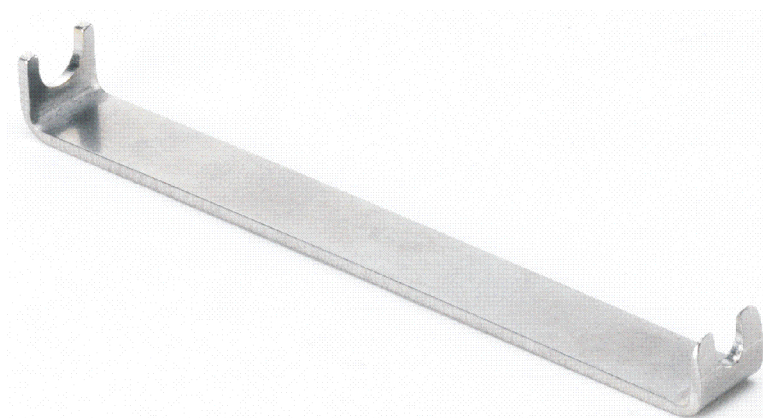

Figure 1-11 Cable Removal Tool (part number 5002-3361)



M9370_001_108

NOTE

Remove the 50 ohm load from output ports used on M9340A. Other unused ports should be terminated.

NOTE

The IF Out port of the VNA receiver is terminated with 50 ohm load. This 50 ohm load can be used at the system power calibration.

How to Tighten the Screw Should Be Inserted Here

Each Keysight PXIe Vector Network Analyzer Receiver module is shipped with straight, coaxial adapter (1250-2316, SMA female to SMA male) attached to the test port. This straight, coaxial adapter is used as connector saver to extend the life of the test port connector.

Getting Started

STEP 3. Install the Network Analyzer Modules

When connecting or disconnecting a cable for Device Under Test (DUT) to/from test port, first, hold the connector saver body steady with 5.5 mm open-end wrench to prevent the connector saver body rotation, as shown in **Figure 1-12**. Position both wrenches within 90 degrees from each other before applying force. Then, connect or disconnect the cable for DUT with Torque Wrench for SMA as shown in **Figure 1-13**.

Figure 1-12 Hold the connector saver body steady with 5.5 mm open-end wrench

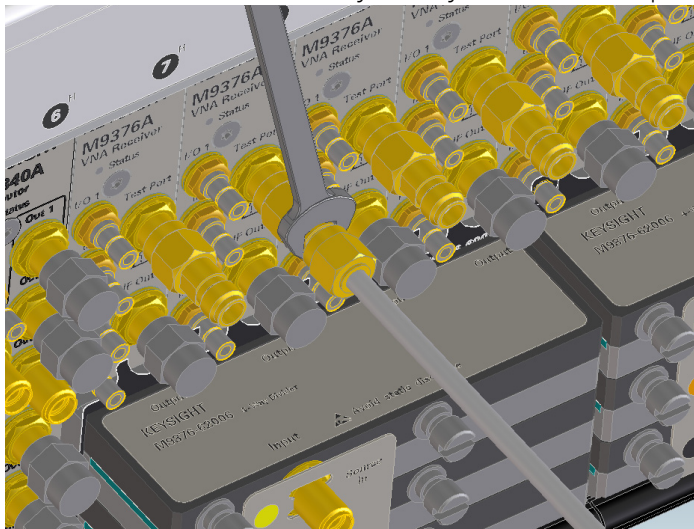

Figure 1-13 Connect or disconnect the cable of the DUT



Getting Started
 STEP 3. Install the Network Analyzer Modules

Cable Connection for Standard Receiver M9376A

- a. Cable connection among receiver modules and between distributor and receiver modules defers depending on the settings:
 - 12-port or 24-port configuration
 - Standard Receiver (M9376A) or Configurable Test Set (M9377A and M9378A/B)
- b. However, cable connection between source, synthesizers, reference and distributor remain the same for all the 12-port configuration as shown in **Figure 1-14 on page 24** and for all 24-port configuration, as shown in **Figure 1-15 on page 25**, regardless of the receiver modules settings.
- c. **Figure 1-16 on page 25** shows the complete cable connections between standard modules for 12-port configuration in 1 chassis.
- d. **Figure 1-17 on page 26** shows the complete cable connections between standard modules for 24-port configuration in 2 chassis. **Table 1-7 on page 26** shows the required cables to make the connections in standard module configuration.

Figure 1-14 Cable Connections Between Source, Synthesizers, Reference and Distributor for 12-port Configuration

**12 Port
 Config.**

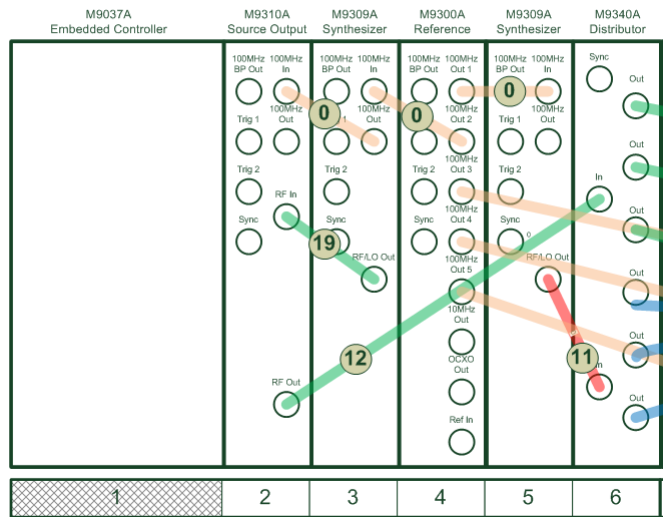

Getting Started
 STEP 3. Install the Network Analyzer Modules

Figure 1-15 Cable Connections Between Source, Synthesizers, Reference and Distributor for 24-port Configuration

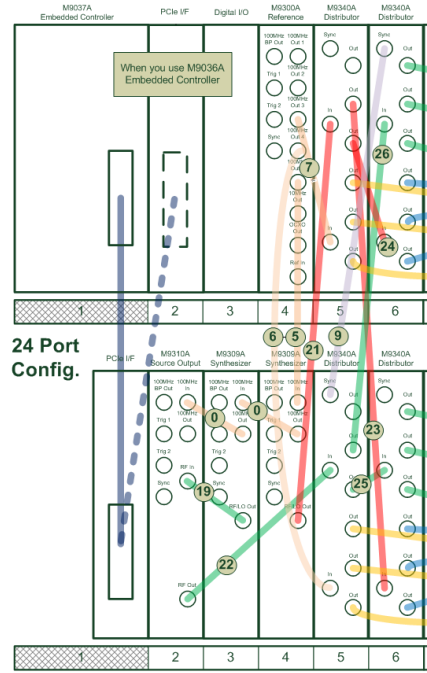
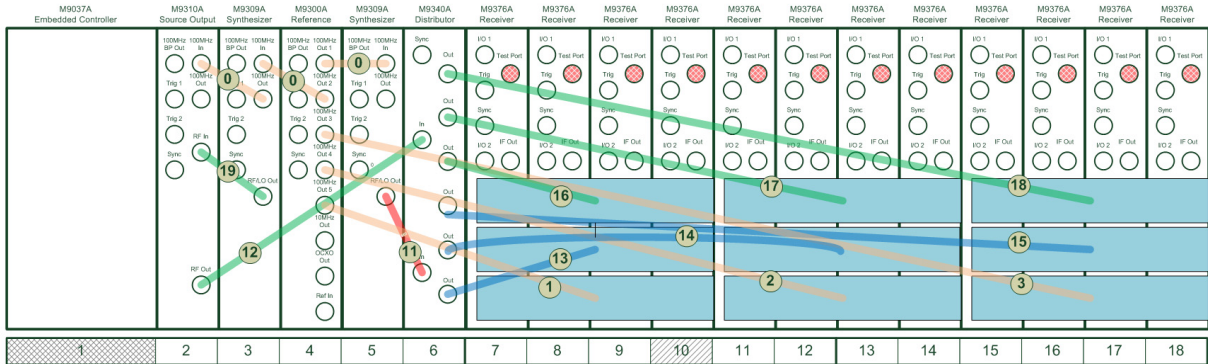

Figure 1-16 Cable Connections Between Standard Modules for 12-port Configuration

12 Port Config.



Getting Started
STEP 3. Install the Network Analyzer Modules

Figure 1-17 Cable Connections Between Standard Modules for 24-port Configuration

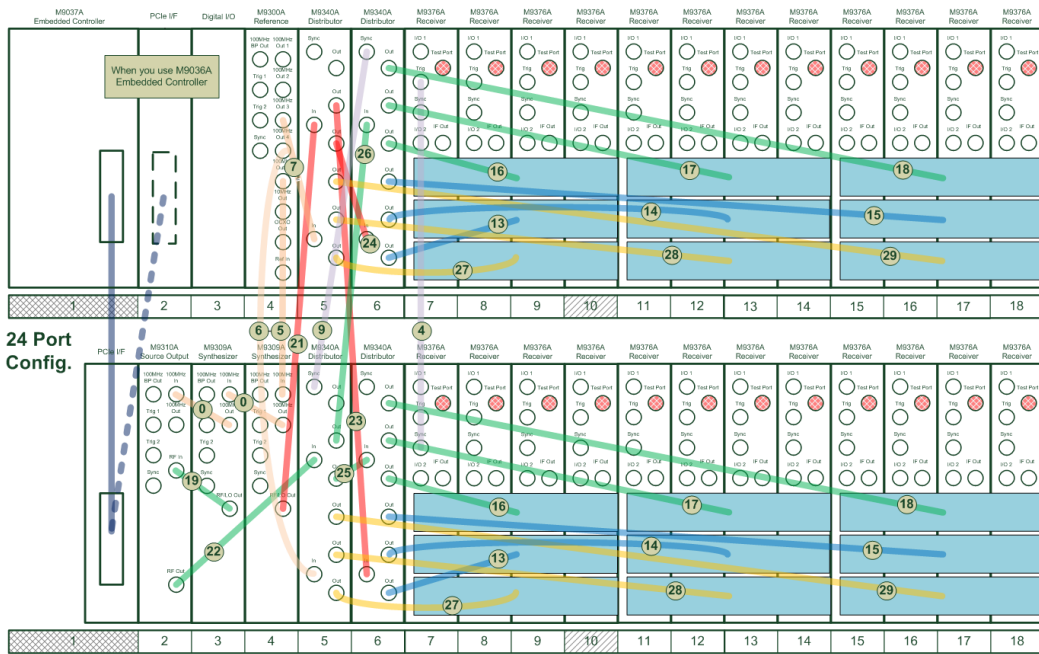

- e. Install EMC filler panels and slot blockers into empty module slots to assure proper air circulation and operating temperatures.

Table 1-7

Part Numbers of Required Cables for Connection

No	Cable Part Numbers	Cable Type	Required Tool to Place the Cable
0	8120-5091	Flexible	-
1	M9485-61601	Flexible	8 in-lbs Torque Wrench for SMA (not supplied)
2	M9485-61602	Flexible	
3	M9485-61603	Flexible	
4	M9485-61604	Flexible	Cable Removal Tool, 5002-3361 is required for removing. No tools required for placing
5	M9485-61605	Flexible	
6*	M9485-61606	Flexible	
7*	M9485-61607	Flexible	
9	M9485-61609	Flexible	

Getting Started
STEP 3. Install the Network Analyzer Modules

No	Cable Part Numbers	Cable Type	Required Tool to Place the Cable
11	M9485-61611	Semi rigid	Socket and torque driver (to be used with socket adapter), set to 8 in-lb (not supplied)
12	M9485-61612	Semi rigid	
13	M9485-61613	Semi rigid	
14	M9485-61614	Semi rigid	
15	M9485-61615	Semi rigid	
16	M9485-61616	Semi rigid	
17	M9485-61617	Semi rigid	
18	M9485-61618	Semi rigid	
19	M9485-61619	Semi rigid	
21	M9485-61633	Semi rigid	
22	M9485-61622	Semi rigid	
23	M9485-61634	Semi rigid	
24	M9485-61624	Semi rigid	
25	M9485-61625	Semi rigid	
26	M9485-61635	Semi rigid	
27	M9485-61627	Semi rigid	
28	M9485-61628	Semi rigid	
29	M9485-61629	Semi rigid	

* A SMB-SMA adapter is required to connect this cables with M9340A. Attach the SMB-SMA adapter to the M9340A before installing into the chassis.

System Rack Installation

For the system rack, 1U space should be placed between Chassis 1 and 2.

2 Tier Chassis Installation

- For 2 tier chassis, 1U spacers are required. Refer table below for the parts needed.

Table 1-8 Part Numbers for 2 Tier Chassis

Item Number	Qty	Description
0515-0380	20	Screw-Machine W/Crest-Cup-Washer Pan-HD Torx-T20 M4X0.7 10mm-LG SST-300 Passivated
M9485-01206	4	Bracket

Getting Started
 STEP 3. Install the Network Analyzer Modules

Item Number	Qty	Description
M9485-25001	4	1U Spacer

- Place the 1U spacers and brackets at the 4 corners of the chassis and tighten the screws. Refer **Figure 1-18**.
- Next, place the second chassis on top of the first chassis and tighten the screw. Refer **Figure 1-19**

Figure 1-18 Assembly for 2 tier chassis-1

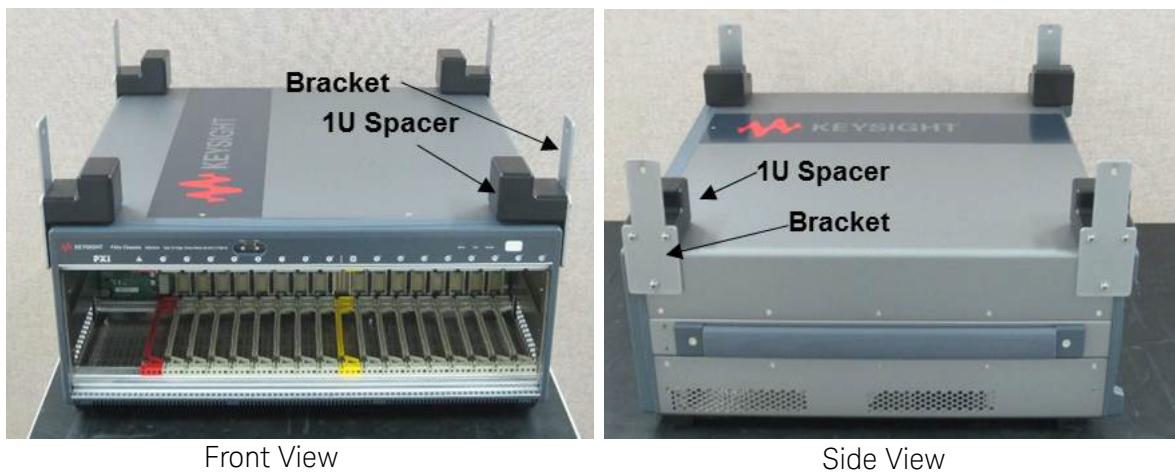

Figure 1-19 Assembly for 2 tier chassis -2



Getting Started

STEP 3. Install the Network Analyzer Modules

Cable Connection for Configurable Test Set, M9377A & M9378A/B

- a. With the Configurable Test Set, the cable connection within the Direct Access Receiver and Directional Coupler modules defers depending on the test purpose:
 - Standard
 - High Power measurement
 - High Sensitivity measurement
 - High Gain measurement
- b. **Figure 1-20 on page 29** and **Figure 1-21 on page 29** below shows the cable connection for standard Configurable Test Set measurement configuration with M9378A and M9378B. This is the connection in both situations, where coupler M9378A/B is to the left side of the M9377A and where M9378A/B is on the right side of the M9377A.

Figure 1-20 Cable Connections For Standard Measurement Configuration with M9378A

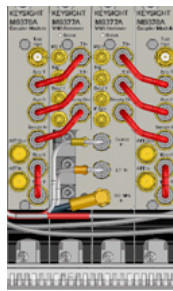
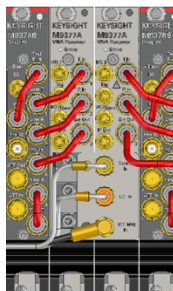

Figure 1-21 Cable Connections For Standard Measurement Configuration with M9378B



- c. **Figure 1-23 on page 30** and **Figure 1-23 on page 30** below shows the cable connection for high power measurement with M9378A and M9378B. Its important to ensure that test port labeled 6 (ATT Out) is connected to test port 4 (Thru R). Similarly, connect test port 7 (ATT In) to test port 5 (Thru T). This connection ensures that the current flows through high power 20 dB attenuator.

Getting Started
STEP 3. Install the Network Analyzer Modules

Figure 1-22 Cable Connections For High Power Measurement Configuration with M9378A

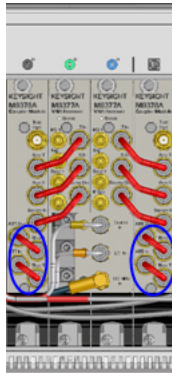
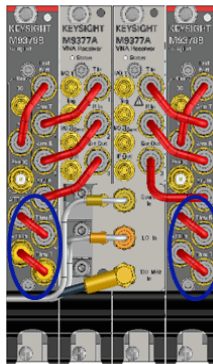
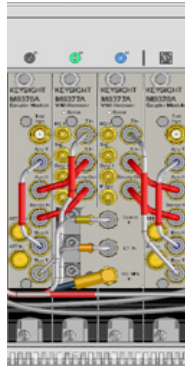

Figure 1-23 Cable Connections For High Power Measurement Configuration with M9378B



- d. [Figure 1-24 on page 30](#) and [Figure 1-25 on page 31](#) below shows the cable connection for Wide Dynamic Range measurement with M9378A and M9378B.

Figure 1-24 Cable Connections For Wide Dynamic Range Configuration with M9378A



Getting Started
STEP 3. Install the Network Analyzer Modules

Figure 1-25 Cable Connections For Wide Dynamic Range Configuration with M9378B

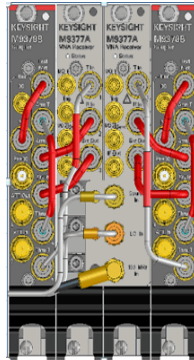

- e. [Figure 1-26 on page 31](#) and [Figure 1-27 on page 31](#) below shows the cable connection for high gain measurement with M9378A and M9378B.

Figure 1-26 Cable Connections For High Gain Measurement Configuration with M9378A

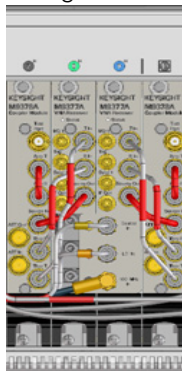
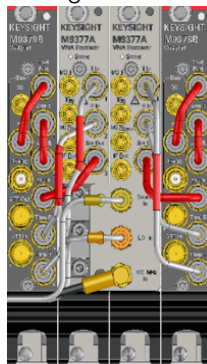

Figure 1-27 Cable Connections For High Gain Measurement Configuration with M9378B



- f. For Configurable Test Set measurement, correct jumper cable has to be selected and connected between test ports. Jumper cables for the Configurable Test Set comes with color coding to ease cable selection. [Figure 1-28 on page 32](#) below shows the jumper cable used for Configurable Test Set.

Getting Started
 STEP 3. Install the Network Analyzer Modules

Figure 1-28 Jumper Cable For DRA Measurement

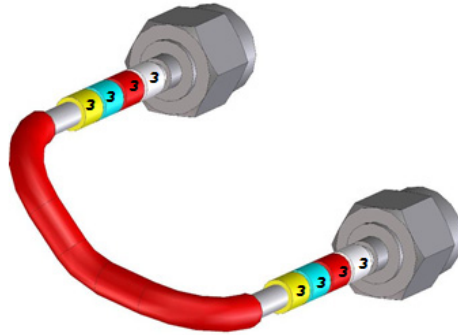

- g. As shown in the figure above, the color coding and the connector number on the jumper cable indicates the measurement it should be used for and the connection between ports.
- h. For example, white for standard measurement, red for high power, blue for wide dynamic range and yellow for high gain measurement. **Figure 1-28 on page 32.**
- i. Connect the cables according to connector number as shown in **Figure 1-29 on page 32** and **Figure 1-30 on page 33** for M9378A and M9378B. These are connections for both situations, where coupler M9378A/B is to the left side of the M9377A (side A) and where M9378A/B is on the right side of the M9377A (side B).

Figure 1-29 Jumper Cable Connection Direct Receiver Access Measurement with M9378A

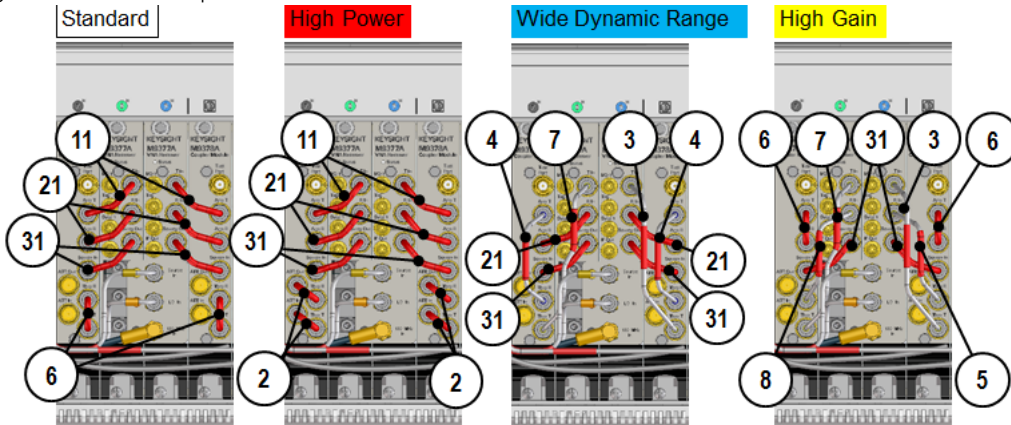

	Part Number	qty/per	Marker			
			side A		side B	
11	M9378-61611	1	1	1	1	1
21	M9378-61621	1	2	2	2	2
31	M9378-61631	1	3	3	3	3
3	M9378-61602	2	6	7	4	5
3	M9378-61603	1	1	1	5	5
4	M9378-61604	1	1		4	
5	M9378-61605	1	2		4	
6	M9378-61606	1	4	1	5	2
7	M9378-61607	1	1	1	5	5
8	M9378-61608	1	2		4	

Getting Started
 STEP 3. Install the Network Analyzer Modules

Figure 1-30 Jumper Cable Connection Direct Receiver Access Measurement M9378B

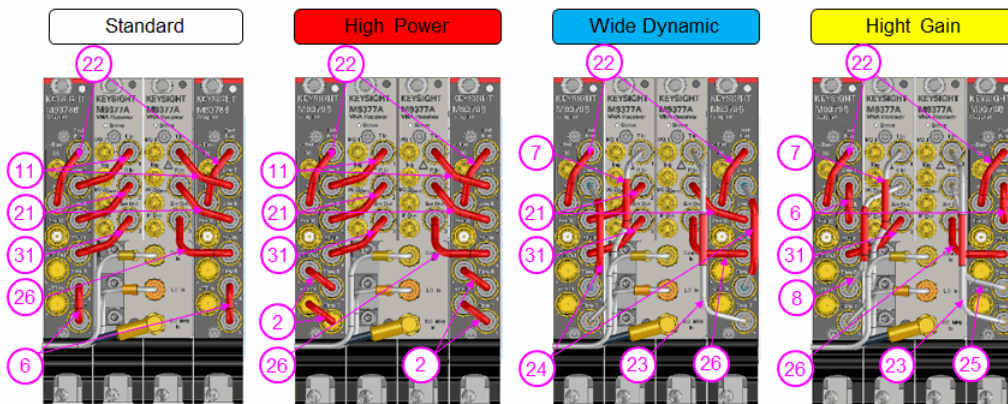

	Part Number	qty/per	Marker							
			Side A				Side B			
2	M9378-61602	2	4	5			6	7		
6	M9378-61606	1	4			1	5			2
7	M9378-61607	1			1	1			5	5
8	M9378-61608	1				2				4
11	M9378-61611	1	1	1			1	1		
21	M9378-61621	1	2	2	2		2	2	2	
22	M9378-61622	1	N	N	N	N	N	N	N	N
23	M9378-61623	1			1	1			5	5
24	M9378-61624	1			1				4	
25	M9378-61625	1				2				4
26	M9378-61626	1	3	3	3	3	3	3	3	3
31	M9378-61631	1	3	3	3	3	3	3	3	3

(N): No marker

Getting Started
 STEP 3. Install the Network Analyzer Modules

Example of 1 Chassis Setup with Configurable Test Set and Standard Receiver or Direct Access Receiver

Figure 1-31 Cable Connection of 1 Chassis with Configurable Test Set and Standard Receiver or Direct Access Receiver

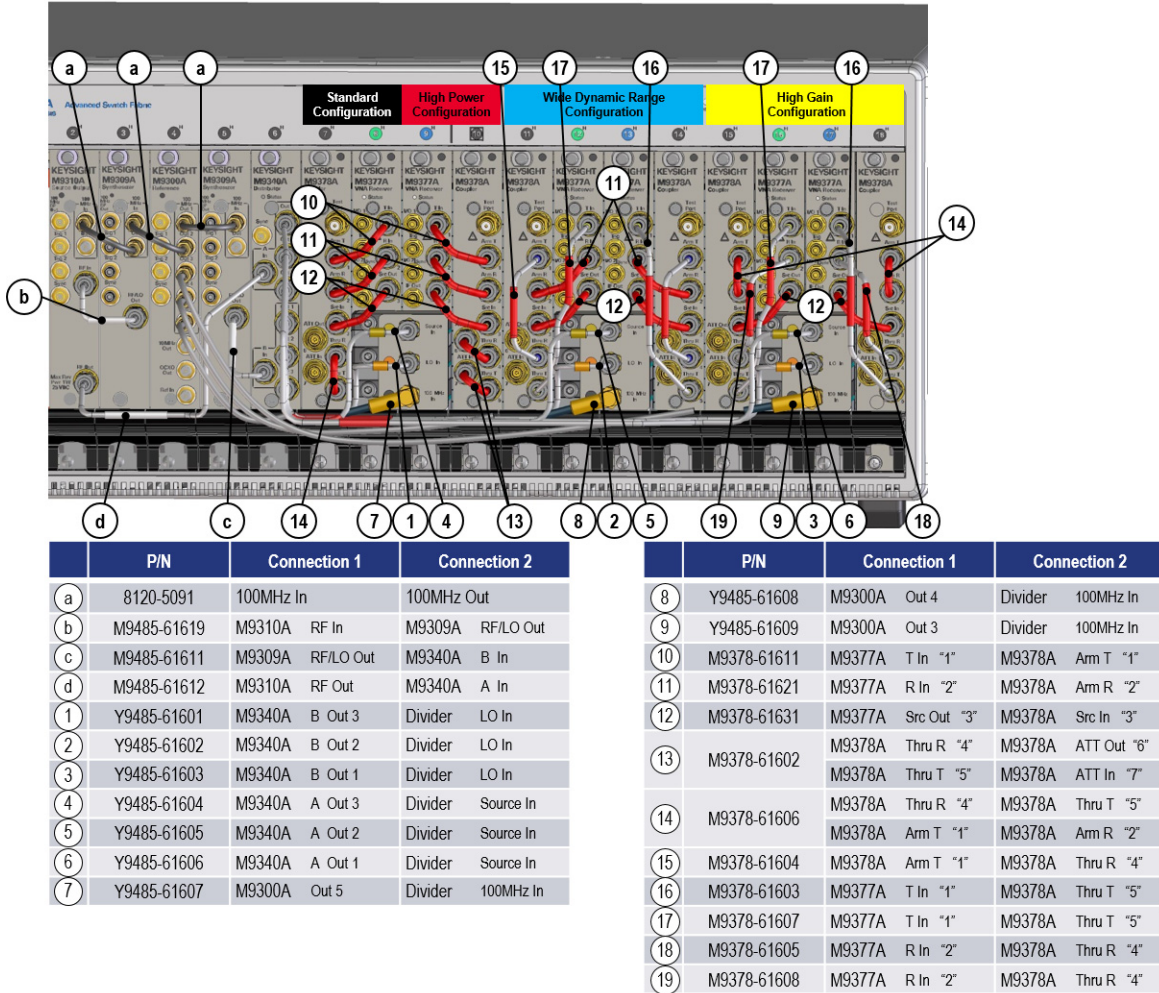

Getting Started
STEP 3. Install the Network Analyzer Modules

Example of 2 Chassis Setup with Configurable Test Set and Standard Receiver or Direct Access Receiver (with 2-Way Divider)

Figure 1-32 Cable Connection of 2 Chassis with Configurable Test Set and Standard Receiver or Direct Access Receiver (with 2-Way Divider) - 1

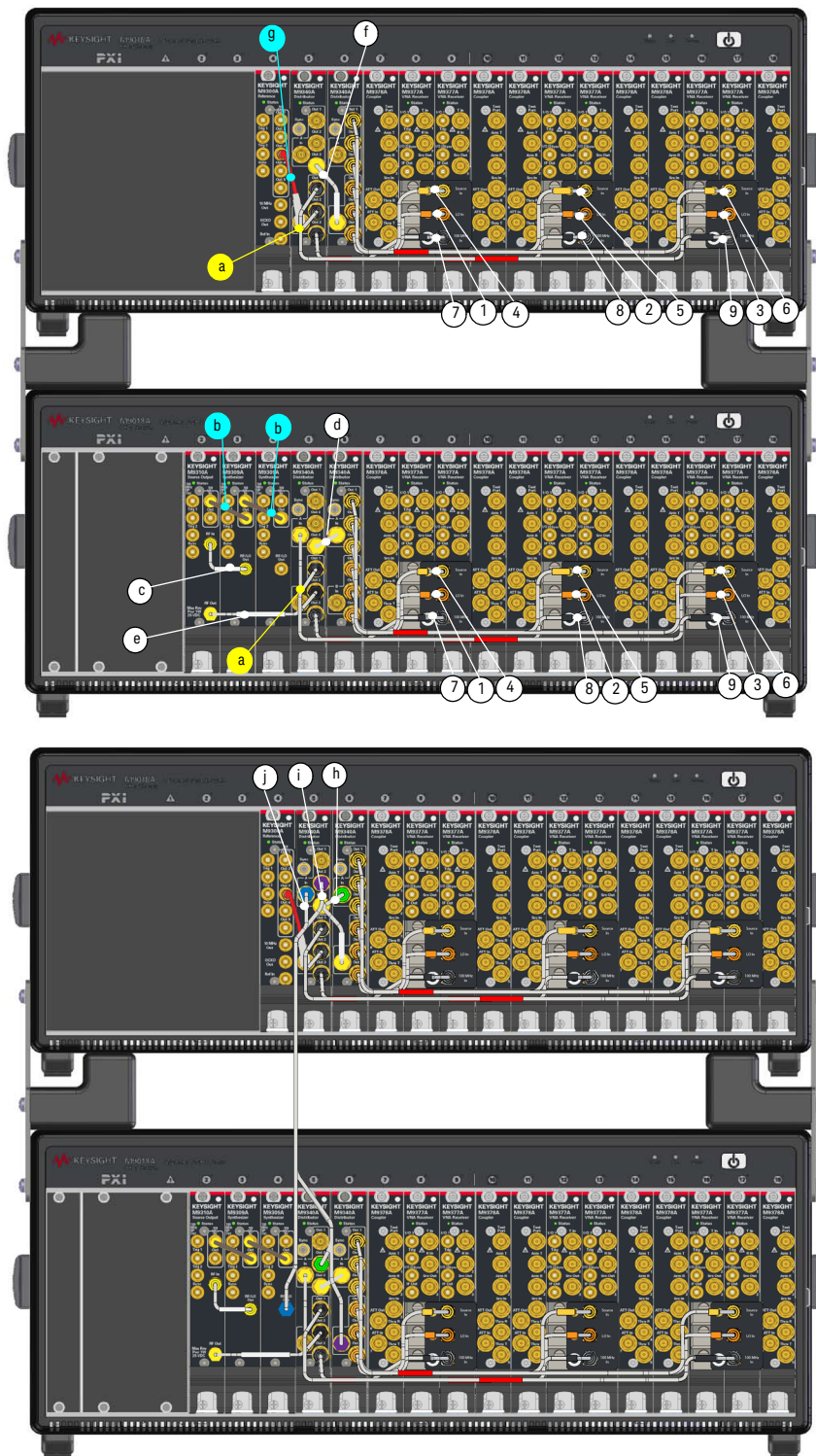

Getting Started
 STEP 3. Install the Network Analyzer Modules

Figure 1-33 Cable Connection of 2 Chassis with Configurable Test Set and Standard Receiver or Direct Access Receiver (with 2-Way Divider) - 2

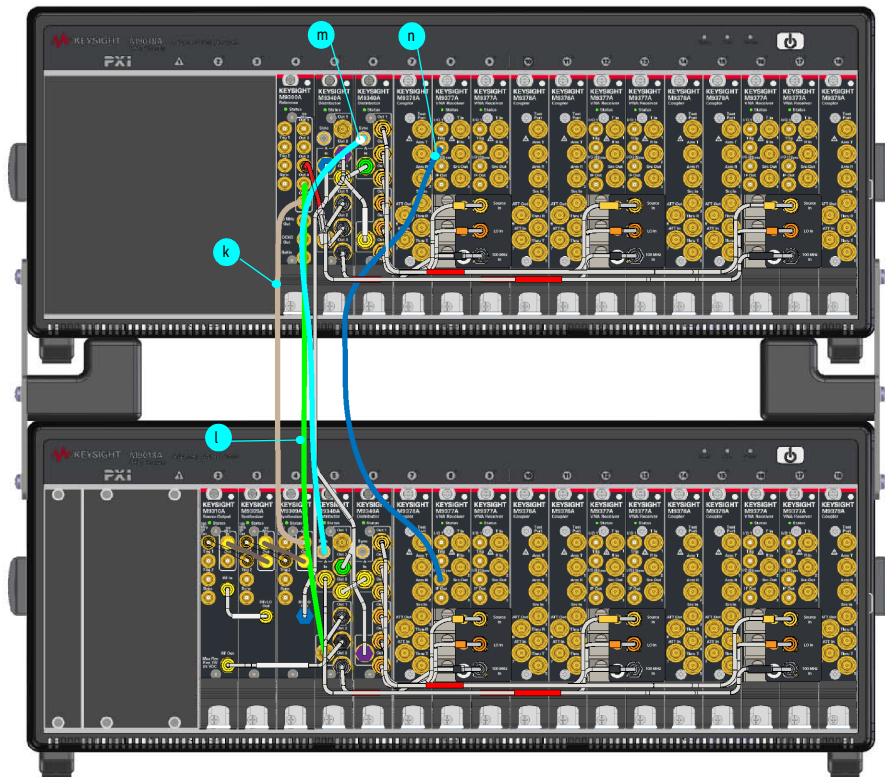

11. [Figure 1-32 on page 35](#) and [Figure 1-33 on page 36](#) shows cable connection of 2 chassis with configurable test set and either standard or direct access receivers, with 2-way dividers. There are many options of configuration and this is one of them. For connection as this, a set of cables as shown in [Table 1-9 on page 36](#), are required.

Table 1-9 Part Numbers of Required Cables for Connection

No	Cable Part Numbers	Connection 1	Connection 2	Note
a	1250-4189		M9340A B In M9340A B In	is SMB-SMA Adapter. Fix this adapter before connecting the cable.
b	8120-5091	M9310A 100MHz In M9309A 100MHz In	M9309A 100MHz Out M9309A 100MHz Out	Flexible cable
c	M9485-61619	M9310A RF In	M9309A RF/LO Out	
d	M9485-61625	M9340A A Out 3	M9340A A In	
e	M9485-61622	M9310A RF Out	M9340A A In	
f	M9485-61624	M9340A A Out 3	M9340A B In	
g	M9485-61607	M9300A Out 3	M9340A B In	Flexible cable

Getting Started
STEP 3. Install the Network Analyzer Modules

No	Cable Part Numbers	Connection 1	Connection 2	Note
1	Y9485-61601	M9340A B Out 3	Divider LO In	
2	Y9485-61602	M9340A B Out 2	Divider LO In	
3	Y9485-61603	M9340A B Out 1	Divider LO In	
4	Y9485-61604	M9340A A Out 3	Divider Source In	
5	Y9485-61605	M9340A A Out 2	Divider Source In	
6	Y9485-61606	M9340A A Out 1	Divider Source In	
7	Y9485-61617	M9340A B Out 3	Divider 100MHz In	
8	Y9485-61618	M9340A B Out 2	Divider 100MHz In	
9	Y9485-61619	M9340A B Out 1	Divider 100MHz In	
h	M9485-61635	M9340A A In	M9340A A Out 2	
i	M9485-61634	M9340A A Out 2	M9340A B In	
j	M9485-61633	M9340A A In	M9309A RF/LO Out	
k	M9485-61605	M9300A Out 5	M9309A 100MHz In	
l	M9485-61606	M9300A Out 4	M9340A B In	
m	M9485-61609	M9340A Sync	M9340A A Sync	
n	M9485-61604	M9377A Trig	M9377A I/O2 Sync	

12. You have now completed the hardware installation procedure.

NOTE

Connect or disconnect the cable of the DUT to the test port

STEP 4. Install the Software

System Requirements

Topic	Windows 7 and Vista Requirements
Operating system	Windows 7 (32 bit and 64 bit) or Windows 8.1 (32-bit and 64-bit) or Windows 10 (32 bit and 64 bit)
Processor speed	1.5 GHz dual core (x86 or x64) minimum (2.4 GHz recommended)
Available memory	4 GB minimum (8 GB recommended)
Available disk space	1.5 GB available hard disk space minimum

Hardware Requirements

Topic	Requirements
Chassis	PXIe or PXI-H chassis slot
Controllers	PXIe embedded controller or remote controller (external PC connected to the chassis by a PCI-to-PXI interface) is required.
Embedded controller	Keysight M903xA or an equivalent embedded controller that meets the following requirements: <ul style="list-style-type: none">· A PXIe system controller (PXI-1 embedded controllers are not compatible).· Utilizes a 2x8, 4x4, or 1x8 PXIe system slot link configuration.· Runs one of the operating systems listed in System Requirements (above).
Remote controller	(For Keysight M9018B/M9019A chassis use only) A PC running one of the operating systems listed in System Requirements and a Keysight M9021A Cable Interface x8 with one of the following PC interface options: <ul style="list-style-type: none">· Keysight M9045B PCIe ExpressCard Adaptor x1, with cable (for a laptop PC)· Keysight M9048B PCIe Desktop Adaptor x8, with cable (for a desktop PC)

Power Up the Controller

If you are using a remote controller, complete the following steps:

1. Install the cable interface between the remote controller and the chassis. If you are using an Keysight M9021A cable interface, refer to the Keysight M9021A documentation for further details.
2. Power up the chassis.
3. Power up the PC.

CAUTION

If you are using a remote controller and you have installed the interface cable, you must power up the chassis BEFORE you power up the PC.

When you power down your system, shut down the PC BEFORE you power down the chassis.

If you are using an embedded controller, complete the following steps:

1. Install the embedded controller module into a compatible chassis. The Keysight M9018B/M9019A PXIe chassis is recommended. Refer to the Keysight M9018B/M9019A documentation for further details.
2. Connect peripherals (mouse, keyboard, monitor).
3. Power up the chassis.

Software Installation Overview

The software installation includes the following items:

- Keysight IO Libraries Suite (IOLS), which includes the Keysight Connection Expert. This software is included with your shipment and the latest version is available at www.keysight.com/find/iosuite. This software must be installed first.

NOTE

Version 17.1 (or newer) of the Keysight IO Libraries Suite is required.

- Network analyzer module software, which includes the soft front panel (SFP) software, device drivers (IVI-C and IVI-COM, and LabVIEW G), and documentation for the M9485A PXIe Vector Network Analyzer modules. This software is included with your shipment and is also available at <http://www.keysight.com/find/m9485A>.
- PXIe Chassis Drivers, which includes IVI-C (32-bit/64-bit), IVI-COM (32-bit/64-bit), MATLAB (32-bit only), LabVIEW (32-bit/64-bit) for M9018B/M9019A. This software is pre-installed on the

M9037A Embedded Controller and also available at:

<http://www.keysight.com/find/m9018b>.

<http://www.keysight.com/find/m9019a>.

Software Installation Procedure

1. Install the Keysight IO Libraries Suite, using either the Keysight IO Libraries Suite CD included with your shipment, or the downloadable file at www.keysight.com/find/iosuite. Follow the installer prompts to install the IO libraries.
2. Install the network analyzer module software:
 - a. Using either the CD included with your shipment or the downloadable file at <http://www.keysight.com/find/m9485A>, launch the installer.
 - b. Follow the installer prompts.
3. If using a remote controller, install the PXIe Chassis Drivers
 - a. Using the downloadable file at <http://www.keysight.com/find/m9018b>, launch the installer.
 - b. Follow the installer prompts.
4. Complete the installation:
 - If Using an Embedded Controller:
 - a. After the InstallShield Wizard has completed, click Finish.
 - b. Restart the embedded controller PC, using Start > Restart, and wait for the system to restart.
 - If Using a Remote Controller:
 - a. After the InstallShield Wizard has completed, click Finish.
 - b. Shut down the remote controller PC, using Start > Shut down.
 - c. Power down the chassis.
 - d. Power up the chassis.
 - e. Power up the remote controller PC.

NOTE

Check for software updates at: <http://www.keysight.com/find/m9485A>.

NOTE

When you use non-keysight chassis, the setup for trigger routing is required. See the FAQ at: <http://www.keysight.com/find/m9485A>.

NOTE

When using two chassis, power on the chassis first which does not have embedded controller or is not connected with remote controller, the power on the chassis which has embedded controller or is connected with remote controller.

STEP 5. Verify Operation of the Network Analyzer Modules

Execute the M9385A Soft Front Panel Application

Click the Network Analyzer icon on the desktop on execute the application.

The Operator's Check

NOTE

Allow the network analyzer modules to warm up for at least 15 minutes before performing the Operator's Check.

The operator check is a self test that checks the basic operation of the assemblies in all of the measurement port signal paths. This allows you to confirm the cable connection and modules' basic operations. No tools are required to execute this test.

Removing the DUT from the test port is recommended.

All the test ports will be short circuited during the test. If the test fails, an error dialog box is displayed. Click on Help to show the troubleshooting hint in the help file.

The operator's check is not complete solution to find all malfunctions. Hence, perform the verification and performance tests to check the complete performance of M9485A.

Operator's check is executed at the Soft Front Panel boot up default as a start up test. You can turn off the start up test by the preference setting (**System > System Setting > Preference...**).

Optionally, you can execute the test manually by selecting **System > Service > Operator's Check**.

Port Configuration/System Power Calibration

If your system has at least one M9377A Direct Access Receiver Module, the Port Configuration Wizard is automatically displayed just after the M9485A SFP is executed for the first time. Follow the instruction to complete the port configuration setup.

The system power calibration is also required by selecting **System > Service > System Power Cal....** After you installed all the modules, the system power calibration should be executed once. The calibration data is stored in your PC with your configuration. It is valid unless the configuration is changed.

Getting Started
STEP 5. Verify Operation of the Network Analyzer Modules

2 Getting Help with Your Network Analyzer Module

Help System

Use the Help System to quickly reference programming and user documentation

To access Help:

- From the analyzer module software
 - On your PC screen, click the Network Analyzer icon.
 - After making your analyzer module configuration settings, click **Help**.
- Online, go to
<http://ena.support.keysight.com/m9485a/manuals/webhelp/eng/>.

Contacting Keysight

Assistance with test and measurements needs and information on finding a local Keysight office are available on the Web at:

www.keysight.com/find/assist.

If you do not have access to the Internet, please contact your Keysight field engineer.

NOTE

In any correspondence or telephone conversation, refer to the Keysight product by its model number and full serial number. With this information, the Keysight representative can determine whether your product is still within its warranty period.

This information is subject to change
without notice

© Keysight Technologies 2015-2017



www.keysight.com

