

BroadR-Reach Link Segment

Keysight Technologies Method of Implementation (MOI)
for BroadR-Reach Link Segment Tests
Using E5071C ENA Option TDR

Keysight Technologies MOI for BroadR-Reach Link Segment Tests

Table of Contents

1.	Revision History	3
2.	Purpose	3
3.	Reference	3
4.	Required Equipment.....	3
5.	Test Procedure.....	4
5.1.	Overview of Test Procedure	4
5.2.	Instrument Setup	6
5.2.1.	Recalling a State File	6
5.2.2.	Saving a State File	7
5.3.	Calibration	8
5.3.1.	Channel 1 Calibration.....	8
5.3.2.	Channel 2 Calibration.....	10
5.4.	Measurement	11
5.4.1.	Differential Characteristic Impedance	11
5.4.2.	Mode Conversion.....	13
5.4.3.	Insertion Loss	13
5.4.4.	Return Loss	14
5.4.5.	Power Sum Alien Near End Crosstalk (PSANEXT)	14
5.4.6.	Power Sum Alien Attenuation to Crosstalk Ratio Far End (PSAACRF)	16
5.4.7.	Measurements of Other Cable Pairs	19
6.	[Appendix] Manual Setup Procedure	25
6.1.	Channel & Trace Setup	25
6.2.	Characteristic Impedance	25
6.3.	Common Parameters Setup for Frequency-domain Measurements.....	27
6.4.	Insertion Loss	27
6.5.	Return Loss	27
6.6.	Power Sum Alien Near End Crosstalk (PSANEXT)	28
6.7.	Power Sum Alien Attenuation to Crosstalk Ratio Far End (PSAACRF)	28
6.8.	Defining Limit Line Tables	29

1. Revision History

Revision	Comments	Issue Date
2.00	Modifications for Specification V3.2	August 28, 2014
1.10	Added required software revision info	December 13, 2013
1.00	Original	August 16, 2013

2. Purpose

This test procedure provides a step-by-step guide on how to use the Keysight Technologies ENA Option TDR to make the BroadR-Reach link segment measurements.

3. Reference

Open Alliance BroadR-Reach (OABR) Physical Layer Transceiver Specification for Automotive Applications, V3.2, June 24, 2014, Broadcom Corporation

4. Required Equipment

1. E5071C ENA Series Network Analyzer
 - ✓ Option 440 or 445 (4.5 GHz) / 460 or 465 (6.5 GHz) / 480 or 485 (8.5 GHz) / 4D5 (14 GHz) / 4K5 (20 GHz)
 - ✓ Option TDR (Enhanced time domain analysis)
 - ✓ ENA Firmware Revision A.11.31 or later, Option TDR Revision A.01.57 or later
2. Test Fixtures
 - ✓ When using standard RJ45 connectors, the Keysight Technologies N5395C Standard Ethernet Test Fixture is available (2/ea). For custom connectors, the user needs to provide own fixtures.
3. 4-port ECal Module
 - ✓ N4431B (for E5071C-440/445/460/465/480/485)
 - ✓ N4433A (for E5071C-4D5/4K5)
4. Coaxial RF cables (4/ea)
5. 50 Ohm terminators (20/ea)

5. Test Procedure

5.1. Overview of Test Procedure

1. Instrument Setup

- ✓ Either automatic setup by recalling a state file, or manual setup.

2. Calibration

- ✓ ECal Calibration and Fixture Compensation (Channel 1 measurements)
- ✓ ECal Calibration and Port Extension (Channel 2 measurements)

3. Measurements

4-1. Time-domain Measurements

- ✓ Characteristic Impedance

4-2. Frequency-domain Measurements

- ✓ Insertion Loss
- ✓ Return Loss
- ✓ Mode Conversion
- ✓ Power Sum Alien Near End Crosstalk (PSANEXT)
- ✓ Power Sum Alien Attenuation to Crosstalk Ratio Far End (PSAACRF)

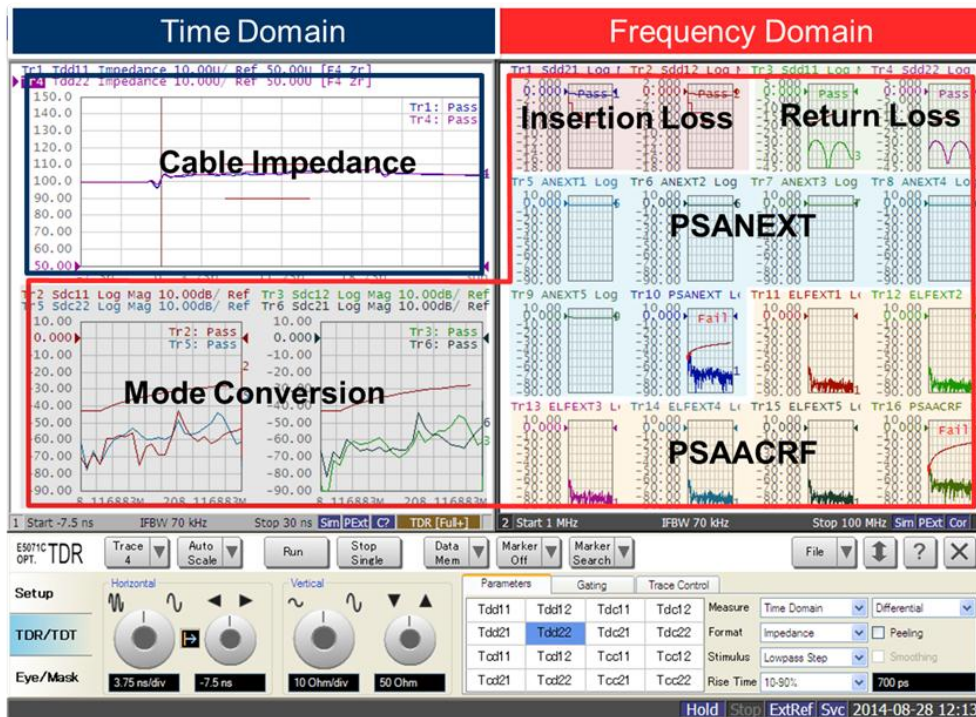

Note:

- ✓ Hard keys (keys on the ENA front panel) are displayed in **blue color** and **bold** (example: **Av**g).
- ✓ Soft keys (keys on the ENA screen) are displayed in **bold** (example: **S11**).
- ✓ Buttons of the TDR software are displayed in **green color** and **bold** (example: **Trace**).

Keysight Technologies MOI for BroadR-Reach Link Segment Tests

- ✓ Tabs of the TDR software are displayed in **brown color** and **bold** (example: **Setup**).

Keysight Technologies MOI for BroadR-Reach Link Segment Tests

5.2. Instrument Setup

5.2.1. Recalling a State File

This section describes how to recall an instrument setup file on the ENA. The file includes all the measurement settings for BroadR-Reach link segment tests. Copy the state file to the ENA directory via an USB mass storage device and recall the state file using the TDR software. Necessary parameters for testing are automatically set up on the ENA. Refer to the Appendix for the details on manually setting up the instrument.

If the TDR Setup Wizard is shown, click the **Close** button in the TDR Setup Wizard main window.

1. Open **Setup** tab.
2. Click **Advanced Mode**.

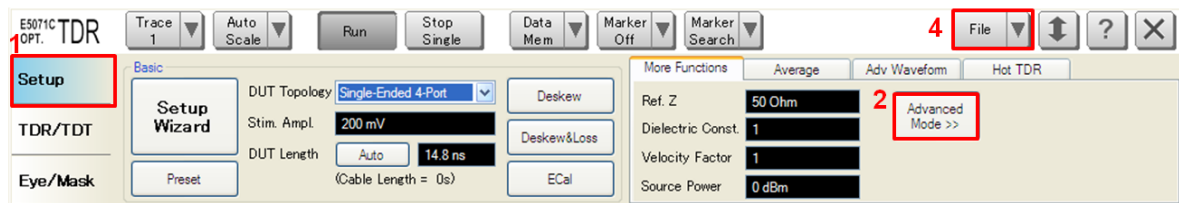

3. Click **Yes**. (Uncheck “Use Advanced Calibration Methods”)

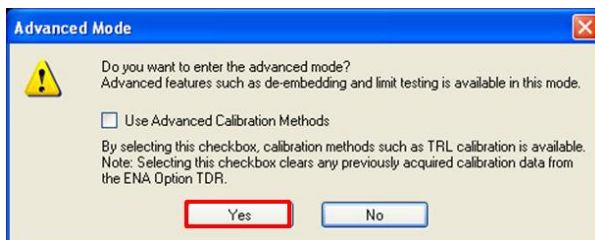

4. Click **File** and select **Recall State** to open the Recall State dialog box.
5. Specify a folder and a file name, and click **Open**.

The ENA channel 1 is controlled by the TDR software and Channel 2 is controlled using the soft keys on the right side of the screen, or hard keys on the front panel.

Keysight Technologies MOI for BroadR-Reach Link Segment Tests

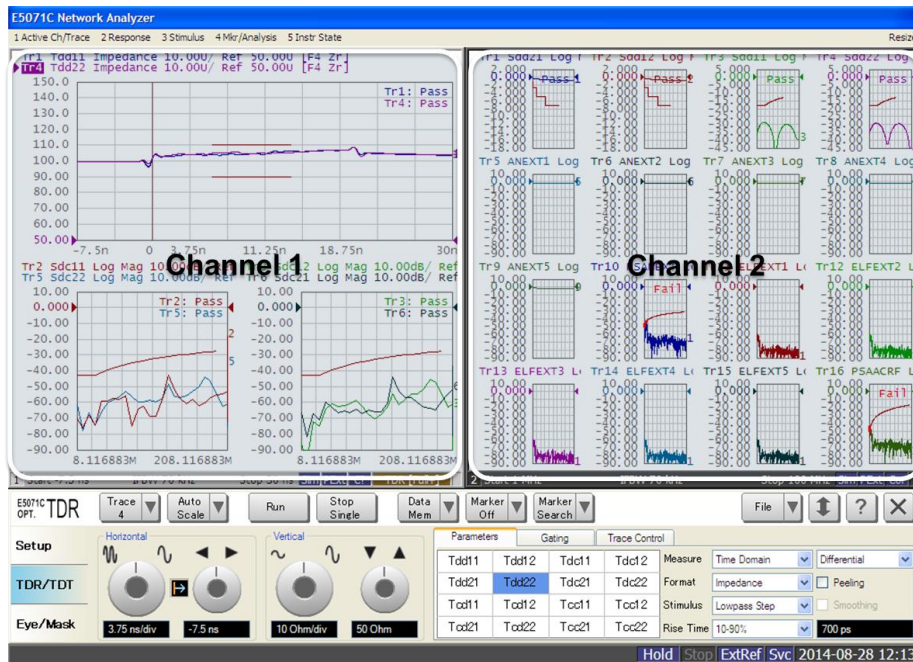

5.2.2. Saving a State File

All the measurement settings, including calibration information, can be saved to a state file (*.tdr). When saving a state file after performing calibration, all necessary calibration coefficients can be saved in the state file and can be recalled for subsequent measurements.

1. Press **Save/Recall** > **Save Type** and select **State & Cal** as a state file type.
2. Click **File** of the TDR software.

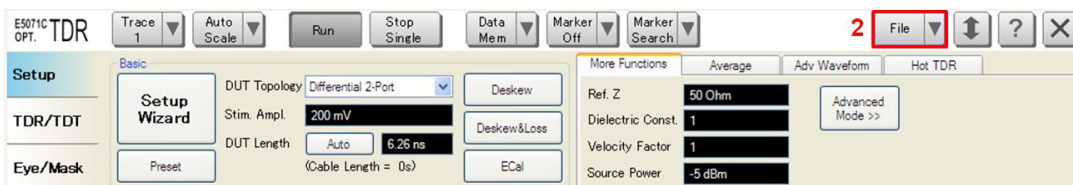

3. Select "Save State".
4. Enter file name and save the state file with calibration information.

5.3. Calibration

5.3.1. Channel 1 Calibration

The purpose of this step is to calibrate out the delay, loss, and mismatch of the test cables for measurements in channel 1. Full calibration is performed by using the 4-port ECal module at the end of test cables connected to the ENA test ports. After connecting the test fixtures to the cables, the delay of the fixtures is removed by the fixture compensation function.

5.3.1.1. ECal Calibration & Fixture Compensation

Calibration for Channel 1 is performed from the TDR software. The 4-port ECal module (i.e. N4431B) is necessary for the calibration procedure.

1. Press **Channel Next** to select Channel 1.
2. Click **Setup** tab of the TDR software.
3. Click **ECal** to launch calibration wizard.



4. Connect all test cables to the ECal Module and click **Calibrate**. Once the green check mark appears, click **Next>**.

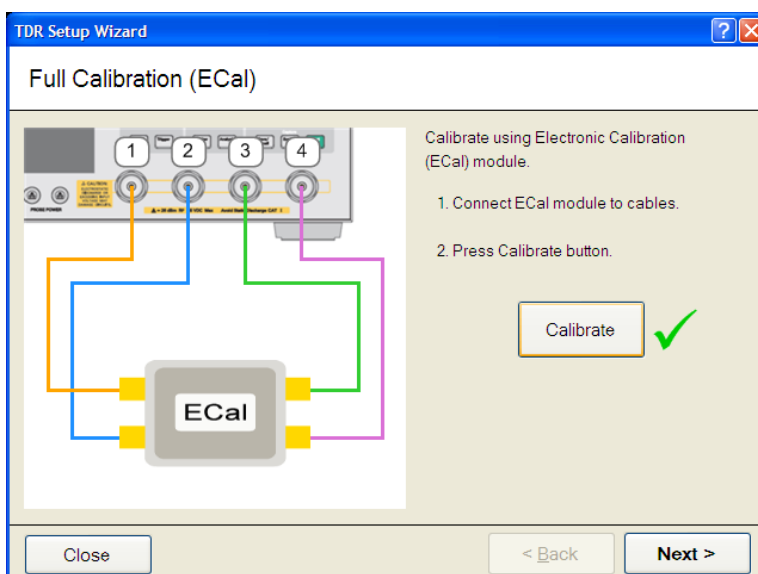

5. Disconnect the ECal Module and connect the test fixtures to the test cables. Click

Keysight Technologies MOI for BroadR-Reach Link Segment Tests

Fixture Comp to perform fixture compensation. Once the green check mark appears, click **Finish** to complete the compensation.

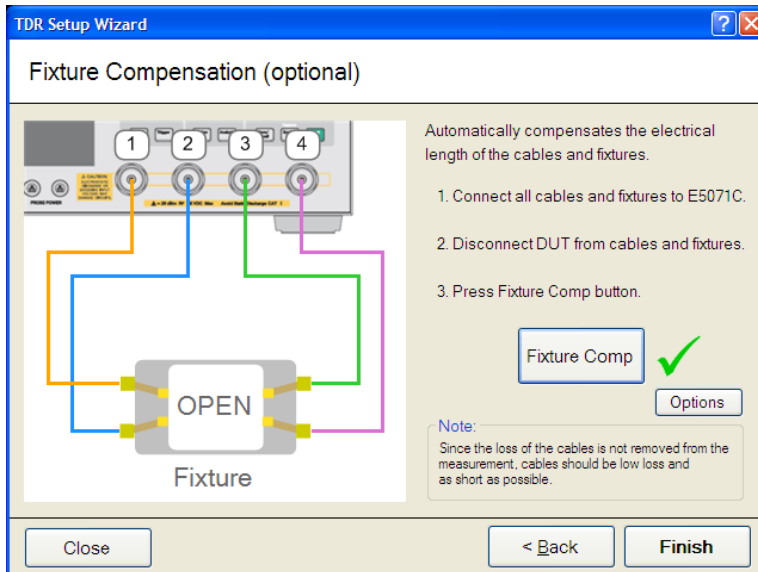

6. Connect DUT to the test fixtures.
7. Click **Setup** tab.
8. Click **Auto** to launch the DUT Length dialog box.

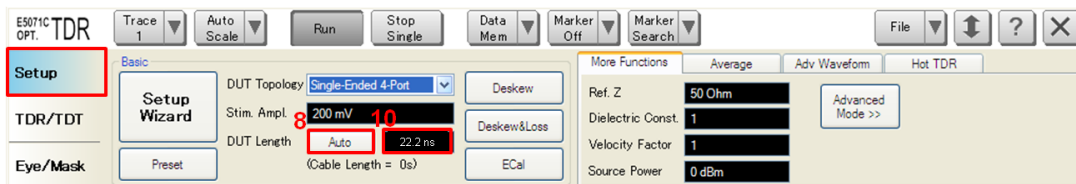

9. Click **Measure** to measure the DUT length. Once the green check mark appears, click **Finish**.

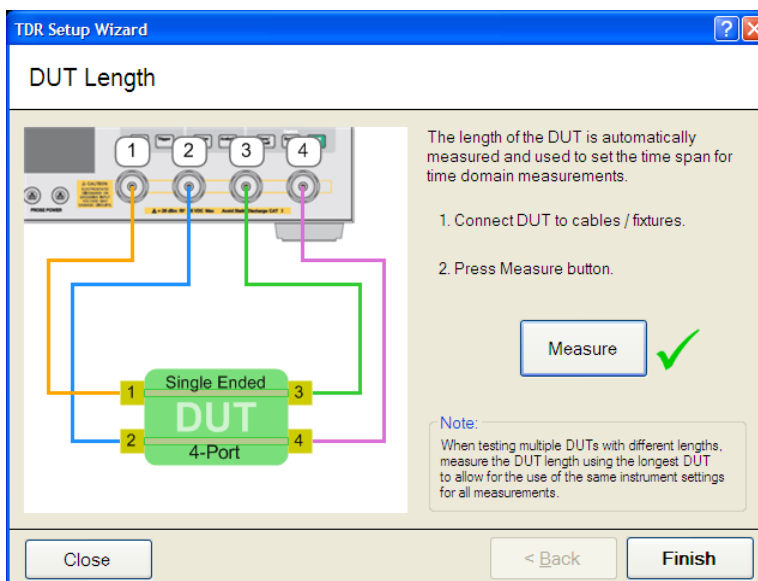

Keysight Technologies MOI for BroadR-Reach Link Segment Tests

10. If the DUT Length value is less than 15 nsec, manually enter 15 nsec.

5.3.2. Channel 2 Calibration

The purpose of this step is to calibrate out the delay, loss, and mismatch of the test cables for measurements in channel 2. Full calibration is performed by using the 4-port ECal module at the end of test cables connected to the ENA test ports. After connecting the test fixtures to the cables, the delay of the fixtures is removed by the auto port extension function.

5.3.2.1. ECal Calibration

Calibration for the frequency domain measurement is performed from the ENA soft keys. The 4-port ECal Module (i.e. N4431B) is necessary for the calibration procedure.

1. Press **Channel Next** key to select Channel 2.
2. Connect all test cables to the ECal Module.
3. Press **Cal > ECal > 4-Port Cal.**

5.3.2.2. Auto Port Extension

1. Connect the test fixtures to the test cables. Do not connect the DUT to the test fixture (the fixture end is left open).
2. Press **Cal > Port Extension > Auto Port Extension > Select Ports** and check all ports (Port 1 to Port 4).
3. Press **Cal > Port Extension > Auto Port Extension > Measure Open** and select **All** to perform auto port extension.

Keysight Technologies MOI for BroadR-Reach Link Segment Tests

5.4. Measurement

The time-domain and frequency-domain measurement procedure is detailed in this section.

There is no FEXT or NEXT as BroadR-Reach is a one-pair solution. When multiple cable pairs are bundled, the alien crosstalk (ANEXT/AFEXT) is an interference source. In order to limit the noise for a 6-pair bundle UTP cable, the Power Sum Alien NEXT (PSANEXT) and Power Sum Alien Attenuation to Crosstalk Ratio Far End (PSAACRF) is specified. For alien crosstalk measurements, the DUT is the victim cable and the other 5-pairs of cables are the aggressor cables. The 6-pair bundle should be connected to the A+/A-, B+/B-, C+/C-, D+/D-, E+/E-, and F+/F- differential pairs of the test fixtures respectively.

5.4.1. Differential Characteristic Impedance

1. Connect the DUT to the ENA (Figure 5-1).

ENA	Port 1	Port 2	Port 3	Port 4
Test Fixture	TF1 A+	TF1 A-	TF2 A+	TF2 A-

Note: Unused fixture ports should be terminated with 50 ohm terminators.

Keysight Technologies MOI for BroadR-Reach Link Segment Tests

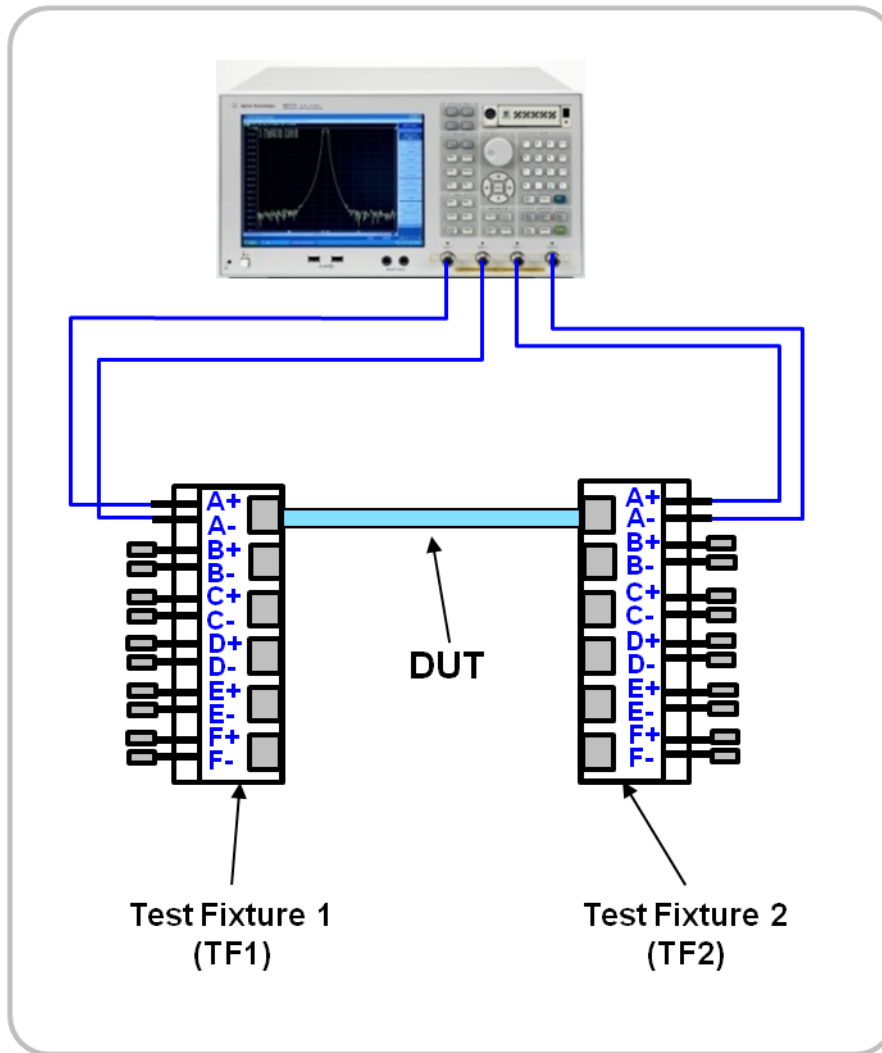

Figure 5-1 Characteristic Impedance Test Setup

2. Press **Channel Next** to select Channel 1.
3. Select **Trace 1** (Tdd11).
4. Set rise time to 700 psec
5. Press **Stop Single**.
6. Confirm that the measurement passes the defined limits.

Specification

$Z = 100\Omega \pm 10\% @ tr < 700ps$

7. Select **Trace 4** (Tdd22).
8. Set rise time to 700 psec
9. Confirm that the measurement passes the defined limits of Step 5.

5.4.2. Mode Conversion

1. Connect DUT to the ENA (Figure 5-1).
2. Press **Channel Next** to select Channel 1.
3. Select **Trace 2** (Sdc11).
4. Press **Stop Single**.
5. Confirm that the measurement passes the defined limits.

Freq	7.1.4 Mode Conversion
1-33 MHz	< -43 dB
33-200 MHz	< $-43+20\log_{10}(f/33)$ [dB]

6. Select **Trace 3** (Sdc12).
7. Confirm that the measurement passes the defined limits of Step 5.
8. Select **Trace 5** (Sdc22).
9. Confirm that the measurement passes the defined limits of Step 5.
10. Select **Trace 6** (Sdc21).
11. Confirm that the measurement passes the defined limits of Step 5.

5.4.3. Insertion Loss

12. Connect DUT to the ENA (Figure 5-1).
13. Press **Channel Next** to select Channel 2.
14. Press **Trigger > Single**.
15. Press **Trace Next** to select Trace 1 (Sdd21).
16. Confirm that the measurement passes the defined limits.

Freq	Loss
1 MHz	> -1.0 dB
10 MHz	> -2.6 dB
33 MHz	> -4.9 dB
66 MHz	> -7.2 dB

17. Press **Display > Data -> Mem** to copy the trace data to memory. The measured differential insertion loss is used for calculation of Power Sum Alien Attenuation to Crosstalk Ratio Far End (PSAACRF).
18. Press **Trace Next** to select Trace 2 (Sdd12).
19. Confirm that the measurement passes the defined limits of Step 5.

Keysight Technologies MOI for BroadR-Reach Link Segment Tests

20. Press **Display > Data -> Mem** to copy the trace data to memory.

5.4.4. Return Loss

1. Connect the DUT to the ENA (Figure 5-1).
2. Press **Trigger > Single**.
3. Press **Trace Next** to select Trace 3 (Sdd11).
4. Confirm that the measurement passes the defined limits.

Freq	7.1.3 Return Loss
1-20 MHz	< -18 dB
20-66 MHz	< -18+10log10(f/20) [dB]

5. Press **Trace Next** to select Trace 4 (Sdd22).
6. Confirm that the measurement passes the defined limits of Step 4.

5.4.5. Power Sum Alien Near End Crosstalk (PSANEXT)

In order to limit the near end crosstalk noise for a 6-pair bundle pair, the power sum alien near end crosstalk (PSANEXT) is specified. The PSANEXT measurement procedure is detailed in this section. The DUT (TF1 A+/A-) is the victim cable and the other 5 cables are the aggressors (TF1 B+/B-, C+/C-, D+/D-, E+/E-, F+/F-).

1. Connect the DUT and aggressor cables to the ENA (Figure 5-2).

ENA	Port 1	Port 2	Port 3	Port 4
Test Fixture	TF1 A+	TF1 A-	TF1 B+	TF1 B-

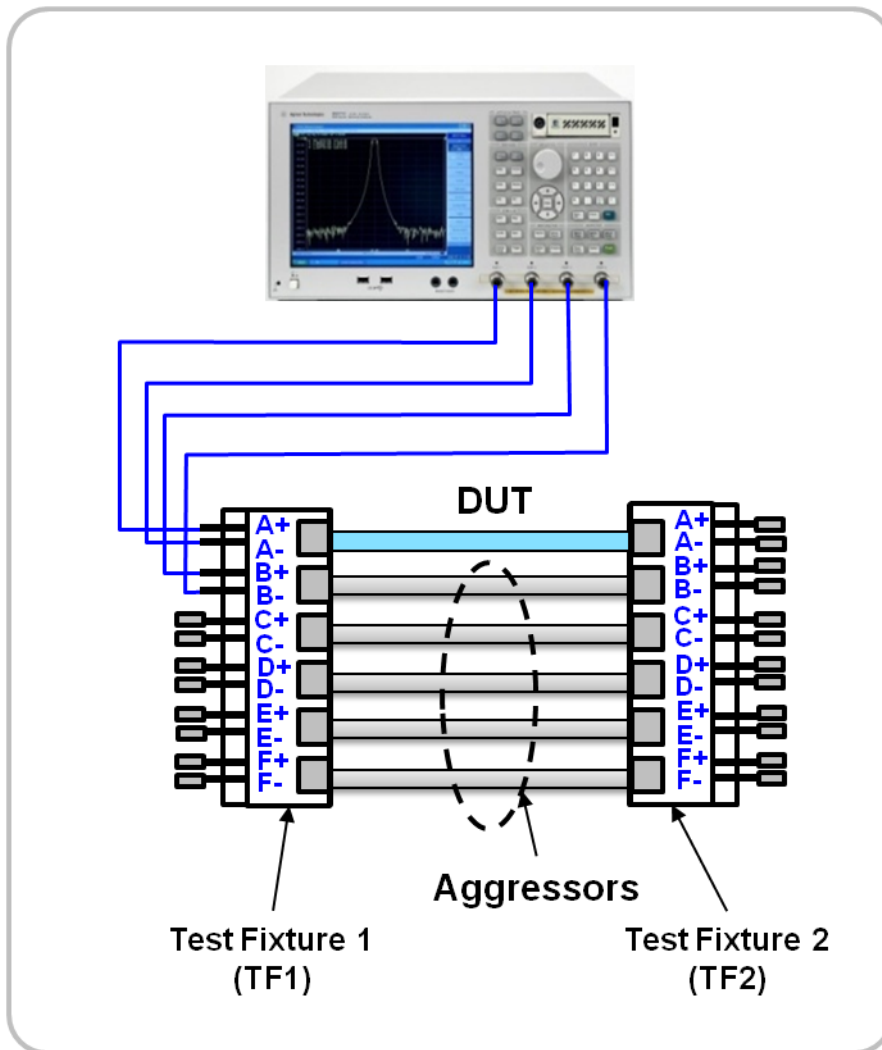

Figure 5-2 Power Sum Alien Near End Crosstalk (PSANEXT) Test Setup

2. Press **Trace Next** to select Trace 5 (ANEXT1).
3. Press **Trigger > Single**.
4. Press **Display > Data -> Mem** to copy the trace data to memory.
5. Connect the DUT and aggressor cables to the ENA.

ENA	Port 1	Port 2	Port 3	Port 4
Test Fixture	TF1 A+	TF1 A-	TF1 C+	TF1 C-

6. Press **Trace Next** to select Trace 6 (ANEXT2).
7. Repeat Steps 3 and 4.
8. Connect the DUT and aggressor cables to the ENA.

ENA	Port 1	Port 2	Port 3	Port 4
Test Fixture	TF1 A+	TF1 A-	TF1 D+	TF1 D-

Keysight Technologies MOI for BroadR-Reach Link Segment Tests

9. Press **Trace Next** to select Trace 7 (ANEXT3).

10. Repeat Steps 3 and 4.

11. Connect the DUT and aggressor cables to the ENA.

ENA	Port 1	Port 2	Port 3	Port 4
Test Fixture	TF1 A+	TF1 A-	TF1 E+	TF1 E-

12. Press **Trace Next** to select Trace 8 (ANEXT4).

13. Repeat Steps 3 and 4.

14. Connect the DUT and aggressor cables to the ENA.

ENA	Port 1	Port 2	Port 3	Port 4
Test Fixture	TF1 A+	TF1 A-	TF1 F+	TF1 F-

15. Press **Trace Next** to select Trace 9 (ANEXT5).

16. Repeat Steps 3 and 4.

17. Press **Trace Next** to select Trace 10 (PSANEXT).

18. Press **Display > Equation** to turn the equation editor on.

19. Confirm the calculated PSANEXT passes the defined limits.

Specification

$PSANEXT > 31.5 - 10\log_{10}(f/100)$ [dB], where $f = 1-100\text{MHz}$

20. Repeat steps 1 through 19 for the following combinations of connections. The PSANEXT at the far end (test fixture 2) between all the other cables is measured.

Trace	Port 1	Port 2	Port 3	Port 4
Tr 5 (ANEXT1)	TF2 A+	TF2 A-	TF2 B+	TF2 B-
Tr 6 (ANEXT2)	TF2 A+	TF2 A-	TF2 C+	TF2 C-
Tr 7 (ANEXT3)	TF2 A+	TF2 A-	TF2 D+	TF2 D-
Tr 8 (ANEXT4)	TF2 A+	TF2 A-	TF2 E+	TF2 E-
Tr 9 (ANEXT5)	TF2 A+	TF2 A-	TF2 F+	TF2 F-

5.4.6. Power Sum Alien Attenuation to Crosstalk Ratio Far End (PSAACRF)

Power Sum Alien Attenuation to Crosstalk Ratio Far End (PSAACRF) is specified to limit the crosstalk at the far end of the 6-pair bundled cable. Far-end crosstalk (FEXT) is noise that appears at the far end of the victim cable (DUT) which is coupled from other aggressor cables. The ELFEXT is equal to FEXT minus the insertion loss of the victim cable (DUT). To limit the total FEXT coupled into the cable, the PSAACRF is specified as the power sum of the individual ELFEXT aggressors. The measurement result of ELFEXT of each aggressor cable is used to calculate PSAACRF.

Keysight Technologies MOI for BroadR-Reach Link Segment Tests

The PSAACRF measurement procedure is detailed in this section. The DUT (connected to A+/A- pair of test fixtures) is the victim cable and the other 5 cables are the aggressors (connected to B+/B-, C+/C-, D+/D-, E+/E-, and F+/F- pairs of the test fixtures). Because the insertion loss result is required for calculating EFLEXT, the insertion loss measurement (5.4.2) should be performed before the PSAACRF measurement.

1. Connect the DUT and aggressor cables to the ENA (Figure 5-3).

ENA	Port 1	Port 2	Port 3	Port 4
Test Fixture	TF1 A+	TF1 A-	TF2 B+	TF2 B-

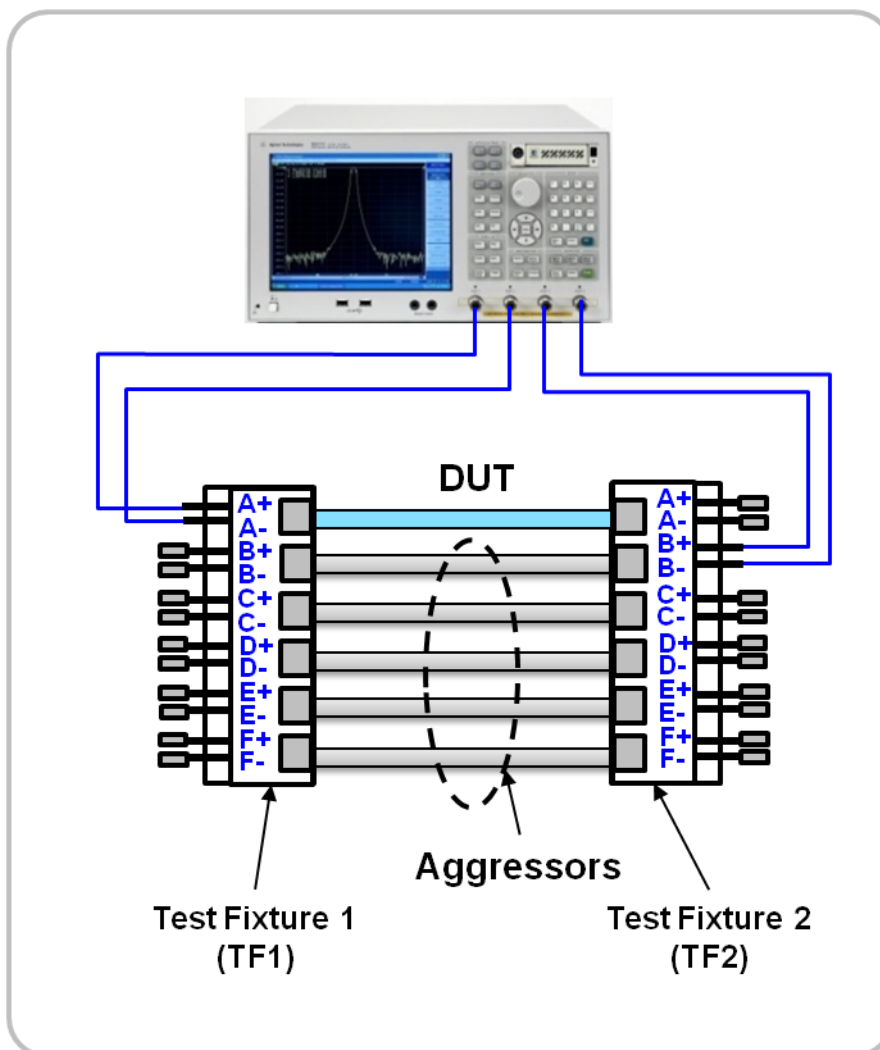

Figure 5.3 Power Sum Alien Attenuation to Crosstalk Ratio Far End (PSAACRF) Test Setup

2. Press **Trace Next** to select Trace 11 (ELFEXT1).
3. Press **Trigger > Single**.
4. Press **Display > Data -> Mem** to copy the trace data to memory.

Keysight Technologies MOI for BroadR-Reach Link Segment Tests

5. Connect the DUT and aggressor cables to the ENA.

ENA	Port 1	Port 2	Port 3	Port 4
Test Fixture	TF1 A+	TF1 A-	TF2 C+	TF2 C-

6. Press **Trace Next** to select Trace 12 (ELFEXT2).

7. Repeat Steps 3 and 4.

8. Connect the DUT and aggressor cables to the ENA.

ENA	Port 1	Port 2	Port 3	Port 4
Test Fixture	TF1 A+	TF1 A-	TF2 D+	TF2 D-

9. Press **Trace Next** to select Trace 13 (ELFEXT3).

10. Repeat Steps 3 and 4.

11. Connect the DUT and aggressor cables to the ENA.

ENA	Port 1	Port 2	Port 3	Port 4
Test Fixture	TF1 A+	TF1 A-	TF2 E+	TF2 E-

12. Press **Trace Next** to select Trace 14 (ELFEXT4).

13. Repeat Steps 3 and 4.

14. Connect the DUT and aggressor cables to the ENA.

ENA	Port 1	Port 2	Port 3	Port 4
Test Fixture	TF1 A+	TF1 A-	TF2 F+	TF2 F-

15. Press **Trace Next** to select Trace 15 (ELFEXT5).

16. Repeat Steps 3 and 4.

17. Press **Trace Next** to select Trace 16 (PSAACRF).

18. Press **Display > Equation** to turn the equation editor on.

19. Confirm the calculated PSAACRF at the far end (test fixture 2) passes the defined limits.

Specification

$PSAACRF > 16.5 - 20\log_{10}(f/100)$ [dB], where $f = 1-100\text{MHz}$

The following steps guide how to make all the PSAACRF measurements of victim cable (DUT) at the far end (test fixture 2).

20. Press **Trace Next** to select Trace 11 (ELFEXT1).

21. Press **Display > Equation Editor... >** Enter the equation "**ELFEXT1 = mem(11)/mem(1)**".

22. Press **Trace Next** to select Trace 12 (ELFEXT2).

23. Press **Display > Equation Editor... >** Enter the equation "**ELFEXT2 = mem(12)/mem(1)**".

24. Press **Trace Next** to select Trace 13 (ELFEXT3).

Keysight Technologies MOI for BroadR-Reach Link Segment Tests

25. Press **Display** > **Equation Editor...** > Enter the equation "**ELFEXT3 = mem(13)/mem(1)**".
26. Press **Trace Next** to select Trace 14 (ELFEXT4).
27. Press **Display** > **Equation Editor...** > Enter the equation "**ELFEXT3 = mem(14)/mem(1)**".
28. Press **Trace Next** to select Trace 15 (ELFEXT5).
29. Press **Display** > **Equation Editor...** > Enter the equation "**ELFEXT3 = mem(15)/mem(1)**".
30. Repeat steps 1 through 18 for the following combinations of connections. The PSAACRF of a victim cable (DUT) at the far end (test fixture 2) between all the other 5 cables is measured.

Trace	Port 1	Port 2	Port 3	Port 4
Trace 11 (ELFEXT1)	TF2 A+	TF2 A-	TF1 B+	TF1 B-
Trace 12 (ELFEXT2)	TF2 A+	TF2 A-	TF1 C+	TF1 C-
Trace 13 (ELFEXT3)	TF2 A+	TF2 A-	TF1 D+	TF1 D-
Trace 14 (ELFEXT4)	TF2 A+	TF2 A-	TF1 E+	TF1 E-
Trace 15 (ELFEXT5)	TF2 A+	TF2 A-	TF1 F+	TF1 F-

31. Press **Trace Next** to select Trace 16 (PSAACRF).
32. Press **Display** > **Equation Editor...** > Enter the equation "**PSAACRF = mag(mem(11)/mem(1))+mag(mem(12)/mem(1))+mag(mem(13)/mem(1))+mag(mem(14)/mem(1))+mag(mem(15)/mem(1))**".
33. Confirm the calculated PSAACRF at the far end (test fixture 2) passes the defined limits of step 18.

5.4.7. Measurements of Other Cable Pairs

The measurements for cable pair 1 (A+/A-) are now complete. The same measurements should be performed for all cable pairs as well (B+/B-, C/C-, D+/D-, E+/E-, F+/F-). Repeat measurements 5.4.1 to 5.4.6 for the following connections between the DUT and ENA.

1. Connections for measurements on cable pair 2 (B+/B-)

	Port 1	Port 2	Port 3	Port 4
✓ Characteristic Impedance	TF1 B+	TF1 B-	TF2 B+	TF2 B-
✓ Insertion Loss				
✓ Return Loss				
✓ PSANEXT (at near end, TF1)	TF1 B+	TF1 B-	TF1 A+	TF1 A-

Keysight Technologies MOI for BroadR-Reach Link Segment Tests

	TF1 B+	TF1 B-	TF1 C+	TF1 C-
	TF1 B+	TF1 B-	TF1 D+	TF1 D-
	TF1 B+	TF1 B-	TF1 E+	TF1 E-
	TF1 B+	TF1 B-	TF1 F+	TF1 F-
✓ PSANEXT (at far end, TF2)	TF2 B+	TF2 B-	TF2 A+	TF2 A-
	TF2 B+	TF2 B-	TF2 C+	TF2 C-
	TF2 B+	TF2 B-	TF2 D+	TF2 D-
	TF2 B+	TF2 B-	TF2 E+	TF2 E-
	TF2 B+	TF2 B-	TF2 F+	TF2 F-
✓ PSAACRF (at near end, TF1)	TF1 B+	TF1 B-	TF2 A+	TF2 A-
	TF1 B+	TF1 B-	TF2 C+	TF2 C-
	TF1 B+	TF1 B-	TF2 D+	TF2 D-
	TF1 B+	TF1 B-	TF2 E+	TF2 E-
	TF1 B+	TF1 B-	TF2 F+	TF2 F-
✓ PSAACRF (at far end, in TF2)	TF2 B+	TF2 B-	TF1 A+	TF1 A-
	TF2 B+	TF2 B-	TF1 C+	TF1 C-
	TF2 B+	TF2 B-	TF1 D+	TF1 D-
	TF2 B+	TF2 B-	TF1 E+	TF1 E-
	TF2 B+	TF2 B-	TF1 F+	TF1 F-

Keysight Technologies MOI for BroadR-Reach Link Segment Tests

2. Connections for measurements on cable pair 3 (C+/C-)

	Port 1	Port 2	Port 3	Port 4
<ul style="list-style-type: none"> ✓ Characteristic Impedance ✓ Insertion Loss ✓ Return Loss 	TF1 C+	TF1 C-	TF2 C+	TF2 C-
<ul style="list-style-type: none"> ✓ PSANEXT (at near end, TF1) 	TF1 C+ TF1 C+ TF1 C+ TF1 C+ TF1 C+	TF1 C- TF1 C- TF1 C- TF1 C- TF1 C-	TF1 A+ TF1 B+ TF1 D+ TF1 E+ TF1 F+	TF1 A- TF1 B- TF1 D- TF1 E- TF1 F-
<ul style="list-style-type: none"> ✓ PSANEXT (at far end, TF2) 	TF2 C+ TF2 C+ TF2 C+ TF2 C+ TF2 C+	TF2 C- TF2 C- TF2 C- TF2 C- TF2 C-	TF2 A+ TF2 B+ TF2 D+ TF2 E+ TF2 F+	TF2 A- TF2 B- TF2 D- TF2 E- TF2 F-
<ul style="list-style-type: none"> ✓ PSAACRF (at near end, TF1) 	TF1 C+ TF1 C+ TF1 C+ TF1 C+ TF1 C+	TF1 C- TF1 C- TF1 C- TF1 C- TF1 C-	TF2 A+ TF2 B+ TF2 D+ TF2 E+ TF2 F+	TF2 A- TF2 B- TF2 D- TF2 E- TF2 F-
<ul style="list-style-type: none"> ✓ PSAACRF (at far end, in TF2) 	TF2 C+ TF2 C+ TF2 C+ TF2 C+ TF2 C+	TF2 C- TF2 C- TF2 C- TF2 C- TF2 C-	TF1 A+ TF1 B+ TF1 D+ TF1 E+ TF1 F+	TF1 A- TF1 B- TF1 D- TF1 E- TF1 F-

Keysight Technologies MOI for BroadR-Reach Link Segment Tests

3. Connections for measurements on cable pair 4 (D+/D-)

	Port 1	Port 2	Port 3	Port 4
<ul style="list-style-type: none"> ✓ Characteristic Impedance ✓ Insertion Loss ✓ Return Loss 	TF1 D+	TF1 D-	TF2 D+	TF2 D-
<ul style="list-style-type: none"> ✓ PSANEXT (at near end, TF1) 	TF1 D+ TF1 D+ TF1 D+ TF1 D+ TF1 D+	TF1 D- TF1 D- TF1 D- TF1 D- TF1 D-	TF1 A+ TF1 B+ TF1 C+ TF1 E+ TF1 F+	TF1 A- TF1 B- TF1 C- TF1 E- TF1 F-
<ul style="list-style-type: none"> ✓ PSANEXT (at far end, TF2) 	TF2 D+ TF2 D+ TF2 D+ TF2 D+ TF2 D+	TF2 D- TF2 D- TF2 D- TF2 D- TF2 D-	TF2 A+ TF2 B+ TF2 C+ TF2 E+ TF2 F+	TF2 A- TF2 B- TF2 C- TF2 E- TF2 F-
<ul style="list-style-type: none"> ✓ PSAACRF (at near end, TF1) 	TF1 D+ TF1 D+ TF1 D+ TF1 D+ TF1 D+	TF1 D- TF1 D- TF1 D- TF1 D- TF1 D-	TF2 A+ TF2 B+ TF2 C+ TF2 E+ TF2 F+	TF2 A- TF2 B- TF2 C- TF2 E- TF2 F-
<ul style="list-style-type: none"> ✓ PSAACRF (at far end, in TF2) 	TF2 D+ TF2 D+ TF2 D+ TF2 D+ TF2 D+	TF2 D- TF2 D- TF2 D- TF2 D- TF2 D-	TF1 A+ TF1 B+ TF1 C+ TF1 E+ TF1 F+	TF1 A- TF1 B- TF1 C- TF1 E- TF1 F-

Keysight Technologies MOI for BroadR-Reach Link Segment Tests

4. Connections for measurements on cable pair 5 (E+/E-)

	Port 1	Port 2	Port 3	Port 4
✓ Characteristic Impedance	TF1 E+	TF1 E-	TF2 E+	TF2 E-
✓ Insertion Loss				
✓ Return Loss				
✓ PSANEXT (at near end, TF1)	TF1 E+ TF1 E+ TF1 E+ TF1 E+ TF1 E+	TF1 E- TF1 E- TF1 E- TF1 E- TF1 E-	TF1 A+ TF1 B+ TF1 C+ TF1 D+ TF1 F+	TF1 A- TF1 B- TF1 C- TF1 D- TF1 F-
✓ PSANEXT (at far end, TF2)	TF2 E+ TF2 E+ TF2 E+ TF2 E+ TF2 E+	TF2 E- TF2 E- TF2 E- TF2 E- TF2 E-	TF2 A+ TF2 B+ TF2 C+ TF2 D+ TF2 F+	TF2 A- TF2 B- TF2 C- TF2 D- TF2 F-
✓ PSAACRF (at near end, TF1)	TF1 E+ TF1 E+ TF1 E+ TF1 E+ TF1 E+	TF1 E- TF1 E- TF1 E- TF1 E- TF1 E-	TF2 A+ TF2 B+ TF2 C+ TF2 D+ TF2 F+	TF2 A- TF2 B- TF2 C- TF2 D- TF2 F-
✓ PSAACRF (at far end, in TF2)	TF2 E+ TF2 E+ TF2 E+ TF2 E+ TF2 E+	TF2 E- TF2 E- TF2 E- TF2 E- TF2 E-	TF1 A+ TF1 B+ TF1 C+ TF1 D+ TF1 F+	TF1 A- TF1 B- TF1 C- TF1 D- TF1 F-

Keysight Technologies MOI for BroadR-Reach Link Segment Tests

5. Connections for measurements on cable pair 6 (F+/F-)

	Port 1	Port 2	Port 3	Port 4
<ul style="list-style-type: none"> ✓ Characteristic Impedance ✓ Insertion Loss ✓ Return Loss 	TF1 F+	TF1 F-	TF2 F+	TF2 F-
<ul style="list-style-type: none"> ✓ PSANEXT (at near end, TF1) 	TF1 F+ TF1 F+ TF1 F+ TF1 F+ TF1 F+	TF1 F- TF1 F- TF1 F- TF1 F- TF1 F-	TF1 A+ TF1 B+ TF1 C+ TF1 D+ TF1 E+	TF1 A- TF1 B- TF1 C- TF1 D- TF1 E-
<ul style="list-style-type: none"> ✓ PSANEXT (at far end, TF2) 	TF2 F+ TF2 F+ TF2 F+ TF2 F+ TF2 F+	TF2 F- TF2 F- TF2 F- TF2 F- TF2 F-	TF2 A+ TF2 B+ TF2 C+ TF2 D+ TF2 E+	TF2 A- TF2 B- TF2 C- TF2 D- TF2 E-
<ul style="list-style-type: none"> ✓ PSAACRF (at near end, TF1) 	TF1 F+ TF1 F+ TF1 F+ TF1 F+ TF1 F+	TF1 F- TF1 F- TF1 F- TF1 F- TF1 F-	TF2 A+ TF2 B+ TF2 C+ TF2 D+ TF2 E+	TF2 A- TF2 B- TF2 C- TF2 D- TF2 E-
<ul style="list-style-type: none"> ✓ PSAACRF (at far end, in TF2) 	TF2 F+ TF2 F+ TF2 F+ TF2 F+ TF2 F+	TF2 F- TF2 F- TF2 F- TF2 F- TF2 F-	TF1 A+ TF1 B+ TF1 C+ TF1 D+ TF1 E+	TF1 A- TF1 B- TF1 C- TF1 D- TF1 E-

6. [Appendix] Manual Setup Procedure

The manual setup procedure for time and frequency domain measurements is detailed in the section.

6.1. Channel & Trace Setup

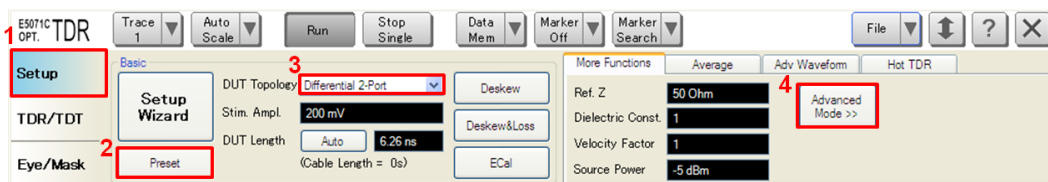

If the Setup Wizard is shown after launching the TDR software, click the **Close** button.

1. Open **Setup** tab in the TDR software.
2. Click **Preset** and **OK** to preset the instrument.
3. Set **DUT Topology** to “Differential 2-Port” and click **OK**.
4. Click **Advanced Mode>>**.

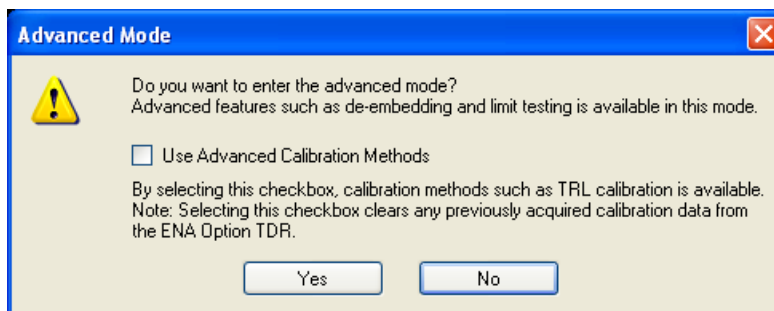

5. A confirmation dialog box appears. Click **Yes** (Clear the check box for “Use Advanced Calibration Methods”).



6. Click **Stop Single**.
7. Press **Display** > **Allocate Channels** > .
8. Press **Display** > **Num of Traces** > 6
9. Press **Display** > **Allocate Traces** > .
10. Press **Channel Max** to maximize the Channel 1 display.

6.2. Characteristic Impedance

1. Select **Trace 1**.
2. Open **TDR/TDT** tab.
3. Open **Parameters** tab.

Keysight Technologies MOI for BroadR-Reach Link Segment Tests

4. Select "Time Domain" and "Differential" for Measure.
5. Select Format to "Impedance"
6. Click **Tdd11**.
7. Click the box below the left knob under Vertical. Set the vertical scale to "10 Ohm/div".
8. Click the box below the right knob under Vertical. Set the vertical center to "50 Ohm".

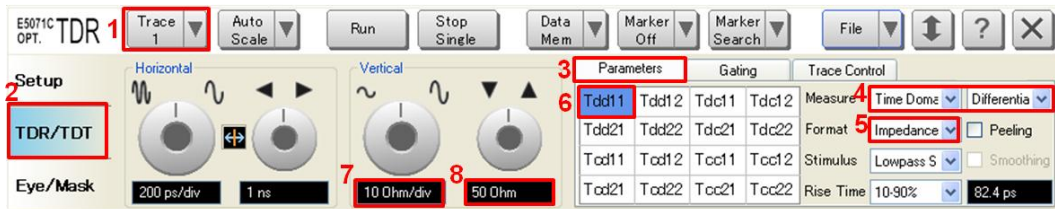

9. Open **Trace Control** tab.
10. Click **Trace Settings Copy** to launch trace copy dialog box.
11. Select the Trace 1 in the From list.
12. Select the Trace 4 in the To list.
13. Click **Copy**.
14. Click **Close**.

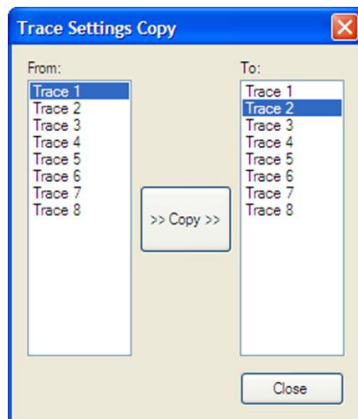

15. Select **Trace 4**.
16. Open **Parameter** tab
17. Click **Tdd22**
18. Select **Trace 2**
19. Open **TDR/TDT** tab
20. Open **Parameters** tab
21. Select "S-parameter" and "Differential" for Measure
22. Select Format to "Log Mag"
23. Click **Sdc11**
24. Open **Trace Control** tab
25. Click **Trace Settings Copy** to launch trace copy dialog box
26. Select the Trace 2 in the From list
27. Select the Trace 3, Trace 5, and Trace 6 in the To list

Keysight Technologies MOI for BroadR-Reach Link Segment Tests

28. Click **Copy**
29. Click **Close**
30. Select **Trace 3**
31. Open **Parameter** tab
32. Click **Sdc12**
33. Select **Trace 5**
34. Open **Parameter** tab
35. Click **Sdc22**
36. Select **Trace 6**
37. Open **Parameter** tab
38. Click **Sdc21**

6.3. Common Parameters Setup for Frequency-domain Measurements

1. Press **Channel Next** to select Channel 2.
2. Press **Start** > Set value to "1 MHz"
3. Press **Stop** > Set value to "100 MHz"
4. Press **Avg** > **IF Bandwidth** > Set value to "10 kHz"
5. Press **Display** > **Num of Traces** > 16
6. Press **Display** > **Allocate Traces** > x16 (4 columns by 4 rows).
7. Press **Analysis** > **Fixture Simulator** and turn it **ON**.
6. Press **Analysis** > **Fixture Simulator** > **Topology** > **Device** > **Bal-Bal**
7. Press **Analysis** > **Fixture Simulator** > **Topology** > **Port1 (bal)** > 1-2
8. Press **Analysis** > **Fixture Simulator** > **Topology** > **Port2 (bal)** > 3-4
9. Press **Analysis** > **Fixture Simulator** > **BalUn ON All Traces** to enable mixed-mode S-parameter (i.e. Sdd11) measurements on all traces.

6.4. Insertion Loss

1. Press **Trace Next** to select Trace 1
2. Press **Meas** > **Sdd21**
3. Press **Trace Next** to select Trace 2
4. Press **Meas** > **Sdd12**

6.5. Return Loss

1. Press **Trace Next** to select Trace 3
2. Press **Meas** > **Sdd11**
3. Press **Trace Next** to select Trace 4

Keysight Technologies MOI for BroadR-Reach Link Segment Tests

4. Press **Meas** > **Sdd22**

6.6. Power Sum Alien Near End Crosstalk (PSANEXT)

1. Press **Trace Next** to select Trace 5
2. Press **Meas** > **Sdd12**
3. Press **Trace Next** to select Trace 6
4. Repeat Step 2
5. Press **Trace Next** to select Trace 7
6. Repeat Step 2
7. Press **Trace Next** to select Trace 8
8. Repeat Step 2
9. Press **Trace Next** to select Trace 9
10. Repeat Step 2
11. Press **Trace Next** to select Trace 10
12. Press **Meas** > **Sdd12**
13. Press **Display** > **Equation Editor...** > and enter the equation **"PSANEXT = mag(mem(5)) + mag(mem(6)) + mag(mem(7)) + mag(mem(8)) + mag(mem(9)) + mag(mem(10))"**
14. Check **Enabled** to enable the equation
15. Click **Apply**.
16. Click **Close**

6.7. Power Sum Alien Attenuation to Crosstalk Ratio Far End (PSAACRF)

1. Press **Trace Next** to select Trace 11
2. Press **Display** > **Equation Editor...** > Enter an equation **"ELFEXT1 = mem(11)/mem(2)"**
3. Press **Meas** > **Sdd12**
4. Press **Trace Next** to select Trace 12
5. Press **Display** > **Equation Editor...** > Enter an equation **"ELFEXT2 = mem(12)/mem(2)"**
6. Repeat Step 3
7. Press **Trace Next** to select Trace 13
8. Press **Display** > **Equation Editor...** > Enter an equation **"ELFEXT3 = mem(13)/mem(2)"**.
9. Repeat Step 3
10. Press **Trace Next** to select Trace 14
11. Press **Display** > **Equation Editor...** > Enter an equation **"ELFEXT3 = mem(14)/mem(2)"**.

Keysight Technologies MOI for BroadR-Reach Link Segment Tests

12. Repeat Step 3
13. Press **Trace Next** to select Trace 15
14. Press **Display** > **Equation Editor...** > Enter an equation "**ELFEXT3 = mem(15)/mem(2)**".
15. Repeat Step 3
16. Press **Trace Next** to select Trace 16
17. Press **Meas** > **Sdd12**
18. Press **Display** > **Equation Editor...** > Enter the equation "**PSAACRF = mag(mem(11)/mem(2)) + mag(mem(12)/mem(2)) + mag(mem(13)/mem(2)) + mag(mem(14)/mem(2)) + mag(mem(15)/mem(2))**".
19. Check **Enabled** to enable the equation on trace.
20. Click **Apply**.
21. Click **Close**.

6.8. Defining Limit Line Tables

1. Press **Trace Next** to select desired trace
2. Press **Analysis** > **Limit Line** and turn it **ON** to display limit lines.
3. Press **Analysis** > **Edit Limit Line** to edit the limit line table.

	Type	Begin Stimulus	End Stimulus	Begin Response	End Response
1	MAX	0 s	600 ps	105 u	105 u
2	MIN	0 s	600 ps	75 u	75 u
3					

4. Press **Analysis** > **Limit Test** and turn it **ON**.
5. Press **Analysis** > **Limit Test** > **Fail Sign** to toggle the fail sign display. When turned on, the Fail sign is displayed on the ENA screen when there is one or more limit tests which have failed within the channel.
6. Press **System** > **Misc Setup** > **Beeper** > **Beep Warning** to toggle the warning beeper.

End of document/