D9010SFPC SFP+ **Compliance Test Application** **- Methods of Implementation**

Notices

© Keysight Technologies 2024

No part of this manual may be reproduced in any form or by any means (including electronic storage and retrieval or translation into a foreign language) without prior agreement and written consent from Keysight Technologies as governed by United States and international copyright laws.

Software Version

1.31.1.0

Edition

February 2024

Keysight Technologies, Inc.
1900 Garden of the Gods Road
Colorado Springs, CO 80907 USA

Warranty

THE MATERIAL CONTAINED IN THIS DOCUMENT IS PROVIDED "AS IS," AND IS SUBJECT TO BEING CHANGED, WITHOUT NOTICE, IN FUTURE EDITIONS. FURTHER, TO THE MAXIMUM EXTENT PERMITTED BY APPLICABLE LAW, KEYSIGHT DISCLAIMS ALL WARRANTIES, EITHER EXPRESS OR IMPLIED WITH REGARD TO THIS MANUAL AND ANY INFORMATION CONTAINED HEREIN, INCLUDING BUT NOT LIMITED TO THE IMPLIED WARRANTIES OF MERCHANTABILITY AND FITNESS FOR A PARTICULAR PURPOSE. KEYSIGHT SHALL NOT BE LIABLE FOR ERRORS OR FOR INCIDENTAL OR CONSEQUENTIAL DAMAGES IN CONNECTION WITH THE FURNISHING, USE, OR PERFORMANCE OF THIS DOCUMENT OR ANY INFORMATION CONTAINED HEREIN. SHOULD KEYSIGHT AND THE USER HAVE A SEPARATE WRITTEN AGREEMENT WITH WARRANTY TERMS COVERING THE MATERIAL IN THIS DOCUMENT THAT CONFLICT WITH THESE

TERMS, THE WARRANTY TERMS IN THE SEPARATE AGREEMENT WILL CONTROL.

Technology Licenses

The hardware and/or software described in this document are furnished under a license and may be used or copied only in accordance with the terms of such license.

U.S. Government Rights

The Software is "commercial computer software," as defined by Federal Acquisition Regulation ("FAR") 2.101. Pursuant to FAR 12.212 and 27.405-3 and Department of Defense FAR Supplement ("DFARS") 227.7202, the U.S. government acquires commercial computer software under the same terms by which the software is customarily provided to the public. Accordingly, Keysight provides the Software to U.S. government customers under its standard commercial license, which is embodied in its End User License Agreement (EULA), a copy of which can be found at <http://www.keysight.com/find/sweula>. The license set forth in the EULA represents the exclusive authority by which the U.S. government may use, modify, distribute, or disclose the Software. The EULA and the license set forth therein, does not require or permit, among other things, that Keysight: (1) Furnish technical information related to commercial computer software or commercial computer software documentation that is not customarily provided to the public; or (2) Relinquish to, or otherwise provide, the government rights in excess of these rights customarily provided to the public to use, modify, reproduce, release, perform, display, or disclose commercial computer software or commercial computer software documentation. No additional government requirements beyond those set forth in the EULA shall apply, except to the extent that those terms, rights, or licenses are explicitly required from all providers of commercial computer software pursuant to the FAR and the DFARS and are set forth specifically in writing elsewhere in the EULA. Keysight shall be under no obligation to update, revise or otherwise modify the Software. With respect to any technical data as defined by FAR 2.101, pursuant to FAR 12.211 and 27.404.2 and DFARS 227.7102, the U.S. government acquires no greater

than Limited Rights as defined in FAR 27.401 or DFAR 227.7103-5 (c), as applicable in any technical data.

Safety Notices

CAUTION

A CAUTION notice denotes a hazard. It calls attention to an operating procedure, practice, or the like that, if not correctly performed or adhered to, could result in damage to the product or loss of important data. Do not proceed beyond a CAUTION notice until the indicated conditions are fully understood and met.

WARNING

A WARNING notice denotes a hazard. It calls attention to an operating procedure, practice, or the like that, if not correctly performed or adhered to, could result in personal injury or death. Do not proceed beyond a WARNING notice until the indicated conditions are fully understood and met.

SFP+ Automated Testing – At a Glance

The Keysight D9010SFPC SFP+ Compliance Test Application helps you verify host transmitter device under test (DUT) compliance to specifications with the Keysight Infiniium digital storage oscilloscopes.

The SFP+ Compliance Test Application:

- Lets you select individual or multiple tests to run.
- Lets you identify the device being tested and its configuration.
- Shows you how to make oscilloscope connections to the device under test.
- Automatically checks for proper oscilloscope configuration.
- Automatically sets up the oscilloscope for each test.
- Allows you to determine the number of trials for each test with the multi-trial run capability.
- Provides detailed information for each test that has been run, and lets you specify the thresholds at which marginal or critical warnings appear.
- Creates a printable HTML report of the tests that have been run.

NOTE

The tests performed by the SFP+ Compliance Test Application are intended to provide a quick check of the electrical health of the DUT. These testing are not a replacement for an exhaustive test validation plan.

Compliance test measurements are described in the *SFF-8431* and *IEEE 802.3 Standards*. For more information, see the SFF-8432 Standards Web site at www.sff-sig.org and IEEE 802 Standards Web site at www.ieee802.org.

Required Equipment and Software

In order to run the SFP+ Compliance Test Application, you need the following equipment and software:

- D9010SFPC SFP+ Compliance Test Application software.
- The minimum version of Infiniium oscilloscope software (see the D9010SFPC test application release notes).
- Wilder Technologies SFP+-TPA-HCB-P electrical compliance test fixtures.
- InfiniiMax probe amplifiers.
- Blocking capacitors.
- BNC to SMA converter or SMA to SMA adapter.
- Keyboard, quantity = 1 (provided with the Keysight Infiniium oscilloscope).
- Mouse, quantity = 1 (provided with the Keysight Infiniium oscilloscope).
- Keysight also recommends using a second monitor to view the automated test application.

For more details on the required and recommended equipment, please refer to "**Required and Recommended Equipment**" on page 16.

For the list of licenses required to run this application, refer to the Data Sheet for this application.

In This Book

This manual describes the tests that are performed by the SFP+ Compliance Test Application in more detail; it contains information from (and refers to) the *SFF-8431* and *IEEE 802.3 Standards* and it describes how the tests are performed.

- **Chapter 1**, “Overview describes the tests supported by the SFP+ Compliance Test Application and the standard references.
- **Chapter 2**, “Installing the SFP+ Compliance Test application shows how to install and license the automated test application software (if it was purchased separately).
- **Chapter 3**, “Preparing to Take Measurements shows how to start the SFP+ Compliance Test Application and gives a brief overview of how it is used.
- **Chapter 4**, “Host Transmitter Output Electrical Specifications Tests contains more information on the host transmitter output tests.
- **Chapter 5**, “Calibrating the Infiniium Oscilloscope and Probe describes how to calibrate the oscilloscope in preparation for running the SFP+ automated tests.

Contents

SFP+ Automated Testing – At a Glance	3
In This Book	4
1 Overview	
2 Installing the SFP+ Compliance Test application	
Installing the Software	10
Installing the License Key	11
Using Keysight License Manager 5	11
Using Keysight License Manager 6	12
3 Preparing to Take Measurements	
Required and Recommended Equipment	16
Required Oscilloscope	16
Required Fixtures and Accessories	16
Calibrating the Oscilloscope	19
Setting Up DUT Connections	20
Connecting the Host Transmitter Board	20
Starting the SFP+ Compliance Test application	21
Online Help Topics	22
4 Host Transmitter Output Electrical Specifications Tests	
SFP+ Host Transmitter Output Electrical Specifications at B	26
Test Pattern 8180	26
Test Pattern PRBS9	32
Test Pattern PRBS31	41

XLPPH Host Electrical Output Specification at TP1a 47

Crosstalk Source Calibration 47

Test Pattern 8180 51

Test Pattern PRBS9 55

Test Pattern PRBS31 57

5 Calibrating the Infiniium Oscilloscope and Probe

Required Equipment for Calibration 66

Internal or Self Calibration 67

Probe Calibration and De-skew 72

Differential SMA Probe Head Attenuation/Offset Calibration 72

Differential SMA Probe Head Skew Calibration 76

Differential Socketed Probe Head Atten/Offset Calibration 76

Differential Socketed Probe Head Skew Calibration 80

Index

1 Overview

The **SFP+ Compliance Test** application allows you to check the compliance of a host device. It also allows you to:

- Select individual or multiple tests to run.
- Identify the device being tested and its configuration.
- Make oscilloscope connections to the device under test (DUT).
- Automatically set up the oscilloscope for each test.
- Determine the number of trials for each test.
- Evaluate detailed information of each test that has been run. The result of maximum 64 worst trials can be displayed at any one time.
- Create a printable HTML report of the tests that have been run. This report includes pass/fail limits, margin analysis, and screen shots.

It performs the following tests as per the SFF 8431 and IEEE 802.3 standards.

Table 1 Host Transmitter Output Electrical Specifications Tests by Standard Reference

Test Name	Reference form the Specification	See
Signal Rise Time (20%-80%)/Signal Fall Time (80%-20%) Test	SFF-8431, Appendix D.7 SFF-8431, Appendix D.6 SFF-8431, Section 3.5.1, Table 12	page 27
Transmitter Qsq/Transmitter Qsq for Cu Test	SFF-8431, Appendix D.7 SFF-8431, Appendix D.8 SFF-8431, Section 3.5.1, Table 12 SFF-8431, Appendix E.2, Table 33	page 29
Voltage Modulation Amplitude for Cu (VMA) (p-p) Test	SFF-8431, Appendix E.2, Table 33 SFF-8431, Appendix D.7	page 31
Data Dependent Jitter (DDJ) (p-p) Test	SFF-8431, Appendix D.3 SFF-8431, Section 3.5.1, Table 12	page 33
Data Dependent Pulse Width Shrinkage (DDPWS) (p-p) Test	SFF-8431, Appendix D.3 SFF-8431, Section 3.5.1, Table 12	page 34
Uncorrelated Jitter (UJ) (RMS) Test	SFF-8431, Section 3.5.1, Table 12 IEEE 802.3, Section 68.6.8	page 35
Transmitter Waveform Dispersion Penalty for Cu (TWDPC) Test	SFF-8431, Appendix E.2, Table 33 SFF-8431, Appendix G SFF-8431, Appendix D.9 IEEE 802.3, Section 68.6.6.1	page 37
Output AC Common Mode Voltage (rms) Test/Output AC Common Mode Voltage for Cu (rms) Test	SFF-8431, Appendix 3.5.1, Table 1 SFF-8431, Appendix D.15	page 41
Single Ended Voltage Range (Positive) Test/Single Ended Voltage Range (Negative) Test	SFF-8431, Section 3.5.1, Table 11	page 43
Total Jitter (TJ) (p-p) Test	SFF-8431, Section 3.5.1, Table 12 SFF-8431, Section 3.5.2, Appendix D.2	page 44

Test Name	Reference form the Specification	See
Eye Mask Hit Ratio Test	SFF-8431, Section 3.5.1, Table 12 SFF-8431, Section 3.5.1, Appendix D.2	page 45
Crosstalk Source VMA (p-p) Calibration	IEEE802.3ba-2010, Annex 86A, Table 86A-1	page 47
Crosstalk Source Rise Time (20% - 80%) Calibration	IEEE802.3ba-2010, Annex 86A, Table 86A-1 IEEE802.3ba-2010, Section 86A.5.3.3 IEEE802.3, Section 68.6.2	page 49
Crosstalk Source Fall Time (80% - 20%) Calibration	IEEE802.3ba-2010, Annex 86A, Table 86A-1 IEEE802.3ba-2010, Section 86A.5.3.3 IEEE802.3, Section 68.6.2	page 50
Output Rise Time (20%-80%) Test/Output Fall Time (80%-20%) Test	IEEE802.3ba-2010, Annex 86A, Table 86A-1 IEEE802.3ba-2010, Section 86A.5.3.3 IEEE802.3, Section 68.6.2	page 52
Qsq (V/V) Test	IEEE802.3ba-2010, Annex 86A, Table 86A-1 IEEE802.3ba-2010, Section 86A.5.3.5	page 54
Data Dependent Pulse Width Shrinkage (DDPWS) (p-p) Test	IEEE802.3ba-2010, Annex 86A, Table 86A-1 IEEE802.3ba-2010, Section 86A.5.3.5	page 56
AC Common Mode Output Voltage (rms) Test	IEEE802.3ba-2010, Annex 86A, Table 86A-1 IEEE802.3ba-2010, Section 86A.5.3.1	page 57
Single Ended Output Voltage (Positive) Test/Single Ended Output Voltage (Negative) Test	IEEE802.3ba-2010, Annex 86A, Table 86A-1	page 58
J2 Jitter (p-p) Test	IEEE802.3ba-2010, Annex 86A, Table 86A-1	page 60
J9 Jitter (p-p) Test	IEEE802.3ba-2010, Annex 86A, Table 86A-1	page 61
Eye Mask Hit Ratio Test	IEEE802.3ba-2010, Annex 86A, Table 86A-1	page 62

2 Installing the SFP+ Compliance Test application

Installing the Software / 10
Installing the License Key / 11

If you purchased the D9010SFPC SFP+ Compliance Test application separately, you need to install the software and license key.

Installing the Software

- 1 Make sure you have the minimum version of Infiniium Oscilloscope software (see the Keysight D9010SFPC test application release notes) by choosing **Help>About Infiniium...** from the main menu.
- 2 To obtain the SFP+ Compliance Test application, go to Keysight Web site: <http://www.keysight.com/en/pc-1152185/oscilloscope-software>.
- 3 Navigate to the SFP+ Compliance Test application software download.
- 4 Follow the instructions to download and install the application software.

NOTE

Ensure that the operating system is compliant for the D9010SFPC SFP+ Compliance Test application.

Installing the License Key

For information related to the licenses required for this application, refer to the Data Sheet.

To procure a license, you require the Host ID information that is displayed in the Keysight License Manager application installed on the same machine where you wish to install the license.

Using Keysight License Manager 5

To view and copy the Host ID from Keysight License Manager 5:

- 1 Launch Keysight License Manager on your machine, where you wish to run the Test Application and its features.
- 2 Copy the Host ID that appears on the top pane of the application. Note that x indicates numeric values.

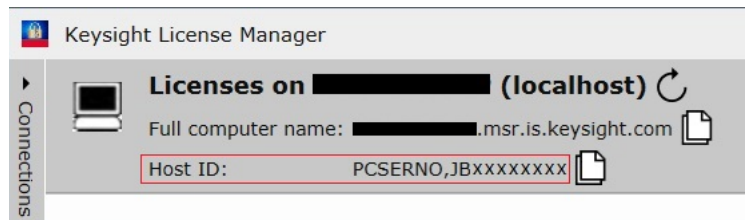

Figure 1 Viewing the Host ID information in Keysight License Manager 5

To install one of the procured licenses using Keysight License Manager 5 application,

- 1 Save the license files on the machine, where you wish to run the Test Application and its features.
- 2 Launch Keysight License Manager.
- 3 From the configuration menu, use one of the options to install each license file.

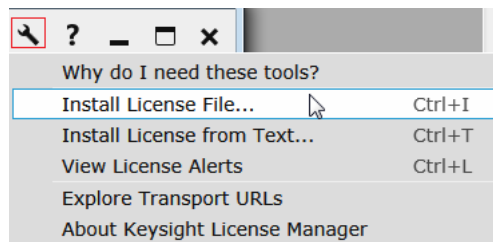

Figure 2 Configuration menu options to install licenses on Keysight License Manager 5

For more information regarding installation of procured licenses on Keysight License Manager 5, refer to [Keysight License Manager 5 Supporting Documentation](#).

Using Keysight License Manager 6

To view and copy the Host ID from Keysight License Manager 6:

- 1 Launch Keysight License Manager 6 on your machine, where you wish to run the Test Application and its features.
- 2 Copy the Host ID, which is the first set of alphanumeric value (as highlighted in Figure 3) that appears in the Environment tab of the application. Note that x indicates numeric values.

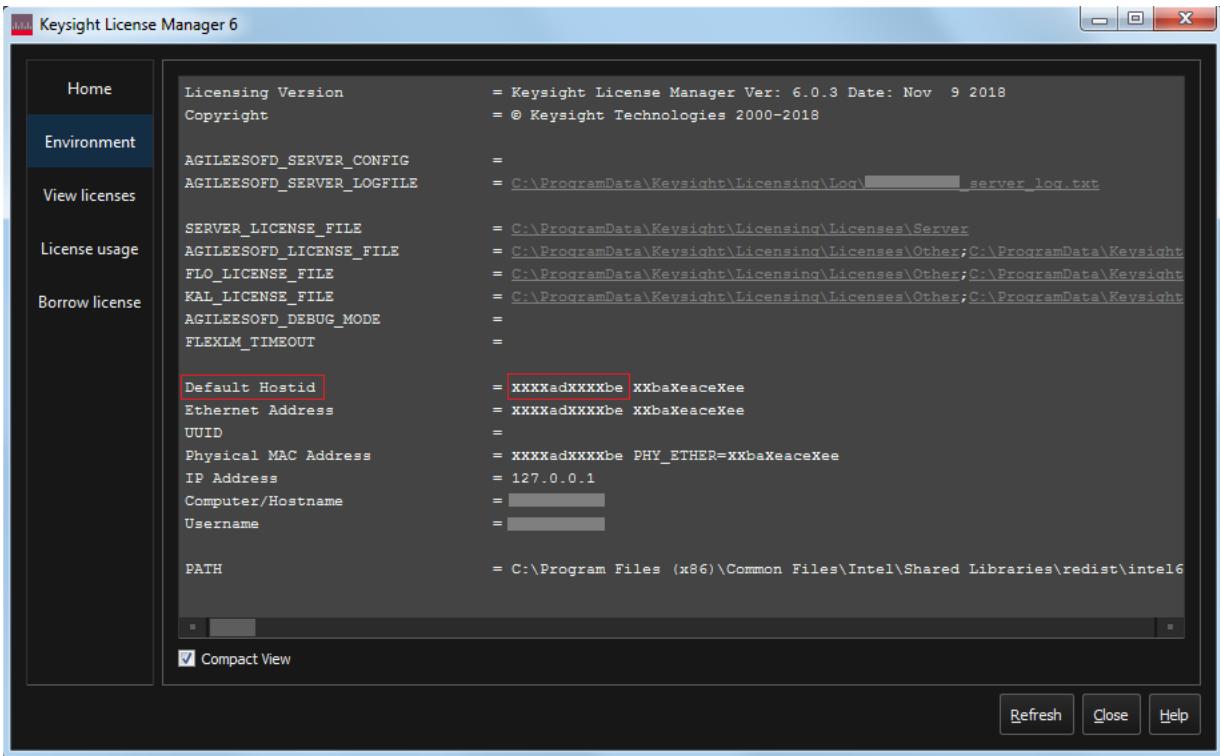

Figure 3 Viewing the Host ID information in Keysight License Manager 6

To install one of the procured licenses using Keysight License Manager 6 application,

- 1 Save the license files on the machine, where you wish to run the Test Application and its features.
- 2 Launch Keysight License Manager 6.
- 3 From the Home tab, use one of the options to install each license file.

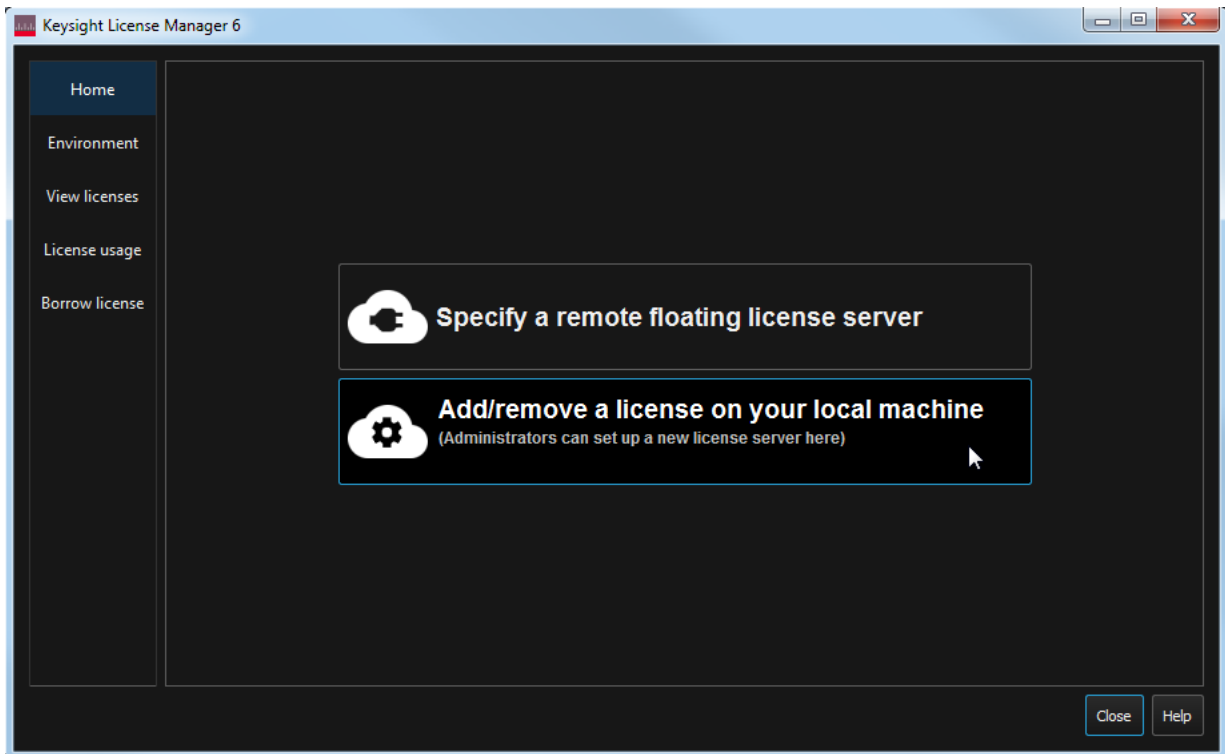

Figure 4 Home menu options to install licenses on Keysight License Manager 6

For more information regarding installation of procured licenses on Keysight License Manager 6, refer to [Keysight License Manager 6 Supporting Documentation](#).

2 Installing the SFP+ Compliance Test application

3 Preparing to Take Measurements

Required and Recommended Equipment / 16
Calibrating the Oscilloscope / 19
Setting Up DUT Connections / 20
Starting the SFP+ Compliance Test application / 21

Before running the D9010SFPC SFP+ compliance automated tests, you need to acquire the appropriate test fixtures, and you should calibrate the oscilloscope. After the oscilloscope has been calibrated, you are ready to start the D9010SFPC SFP+ Compliance Test application and perform the measurements.

Required and Recommended Equipment

Required Oscilloscope

The SFF-8431 specification specifies a measurement bandwidth of 25GHz for all electrical tests. Therefore, all 90000A/90000X/90000Q/UXR-Series Infiniium scopes with a bandwidth of 25GHz and above are supported. Currently, UXR-series oscilloscopes upto 33GHz are supported.

Required Fixtures and Accessories

Following fixtures and accessories are required to run the D9010SFPC SFP+ Compliance application:

Table 2 Required oscilloscope, fixtures and accessories

Required Fixtures/Accessories	Quantity	Recommended Oscilloscope
D9010SFPC Host Compliance Board Test Fixture Kit (Recommended: Wilder SFP+-TPA-HCB-P)	1	Infiniium series
Blocking Capacitors	2	Infiniium series
BNC to SMA Converter	2	For Infiniium 90000A Series
SMA (female) to SMA (female) Adapter	2	For Infiniium 90000X, 90000Q, and UXR-Series

D9010SFPC Host Compliance Board Test Fixture Kit

To use the D9010SFPC SFP+ electrical performance validation and compliance software, you need D9010SFPC SFP+ Host Compliance Board Test Fixture Kit. A test fixture is used to probe the signals to run the tests. You can purchase this fixture kit online from

http://shop.wilder-tech.com/category_s/35.htm. Keysight recommends the use of Wilder SFP+-TPA-HCB-P.

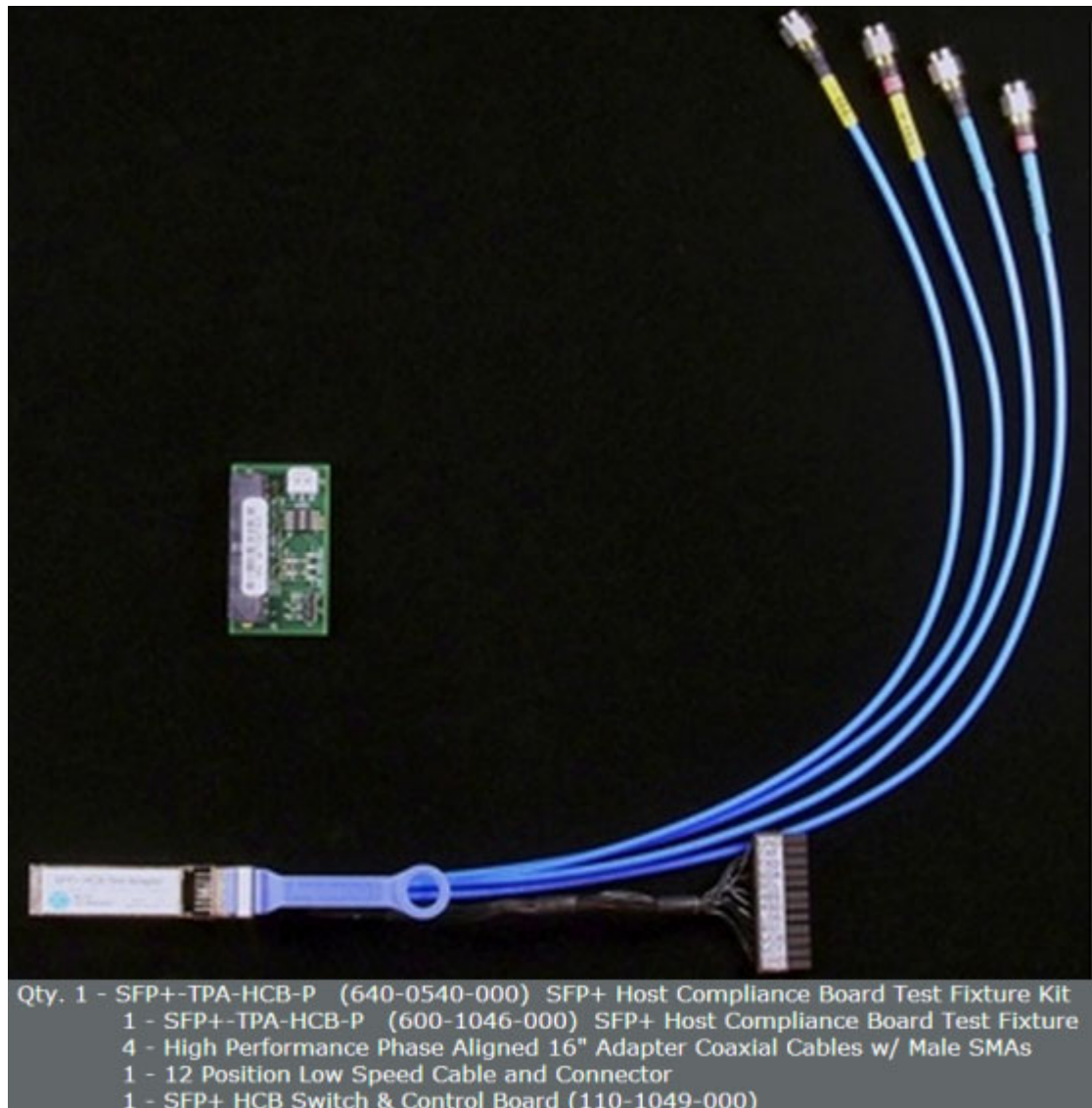

Figure 5 D9010SFPC SFP+ Host Compliance Board Test Fixture Kit

Probing points on the main test fixture board allow most oscilloscope measurements to be made using a Keysight Infiniium GUI for the underlying scope. Some measurements are made using a BNC cable.

Blocking Capacitors

The host tests require the SFP+ host transmitter to be AC coupled to the oscilloscope. A blocking capacitor is used to achieve this. Blocking capacitors are coaxial components used to prevent the flow of DC frequencies between the oscilloscope and DUT. An AC coupling with a 3 dB corner frequency of 20 kHz eliminates the baseline wander effects.





Figure 6 Blocking Capacitor

Converter/Adapter

Converters/adapters are required for Infiniium oscilloscopes to connect the output of the transmitter to the oscilloscope.

Table 3 Converter/Adapter

Oscilloscope	Converter/Adapter	Image
90000A	BNC to SMA Converter	
90000X/90000Q/UXR-Series	SMA (female) to SMA (female) Adapter	

Calibrating the Oscilloscope

If you haven't already calibrated the oscilloscope, see [Appendix 5](#), "Calibrating the Infiniium Oscilloscope and Probe."

NOTE

If the ambient temperature changes more than 5 degrees Celsius from the calibration temperature, internal calibration should be performed again. The delta between the calibration temperature and the present operating temperature is shown in the Utilities>Calibration menu.

NOTE

If you switch cables or probes between channels or other oscilloscopes, it is necessary to perform cable and probe calibration again. Keysight recommends that, once calibration is performed, you label the cables with the channel for which they were calibrated.

Setting Up DUT Connections

The SFP+ host transmitter is connected to the oscilloscope with two SMA cables. The SFP+ host transmitter is to be AC coupled to the oscilloscope for all measurements except the Single Ended Voltage Range tests that require the removal of DC blocks, if already available in the setup.

NOTE

The following subsection lists the instructions for making the hardware connections for all the tests other than the Single Ended Voltage Range tests. For the Single Ended Voltage Range tests, the hardware connection instructions are available in the test description. See ["Single Ended Voltage Range \(Positive\) Test/Single Ended Voltage Range \(Negative\) Test"](#) on page 42.

Connecting the Host Transmitter Board

You need to perform the following steps to connect the host compliance board (HCB) to an oscilloscope:

- 1 Plug the SFP+ Host Compliance Board (HCB) into the SFP+ DUT.
- 2 Connect DC blocks to the Lane 1 TX+ and TX- output of the HCB.
- 3 Connect the Lane 1 TX+ output of the HCB to Channel 1 using an SMA cable.
- 4 Configure the SFP+ host to transmit the required test pattern.

The following figure shows the connection diagram between the HCB and an oscilloscope:

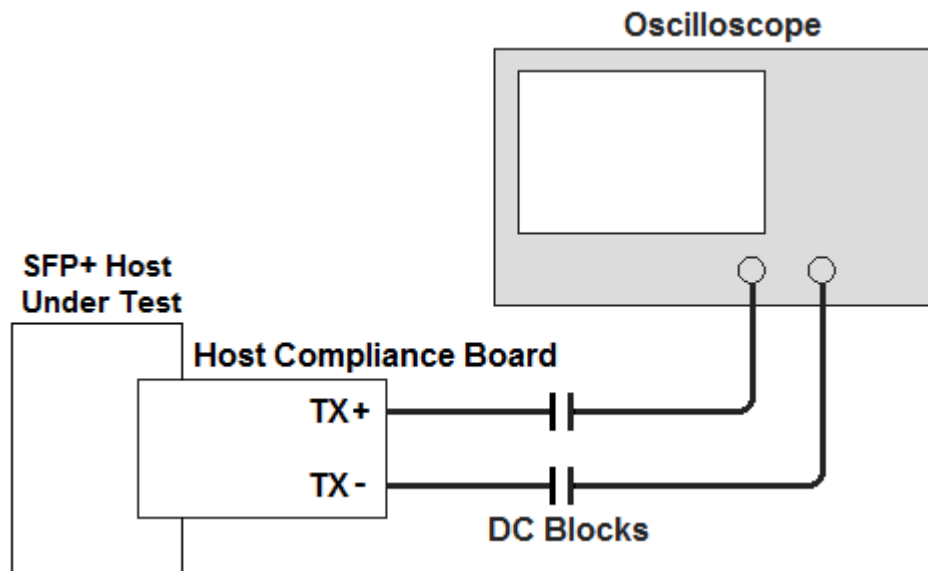

Figure 7 Host Transmitter Output Connection Diagram

Starting the SFP+ Compliance Test application

- 1 From the Infiniium oscilloscope's main menu, choose **Analyze > Automated Test Apps > D9010SFPC SFP+ Test App**.

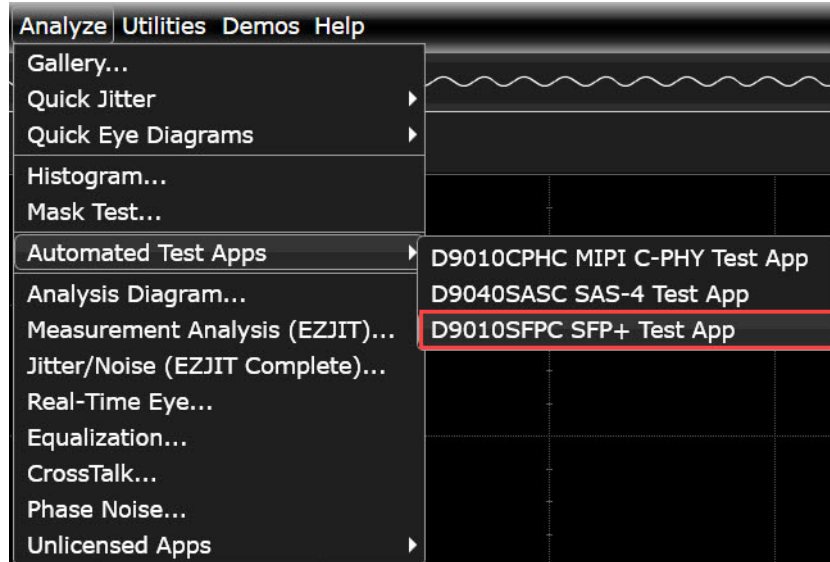

Figure 8 Starting the D9010SFPC SFP+ Test Application

NOTE

If **D9010SFPC SFP+Test App** does not appear in the **Automated Test Apps** menu, the SFP+ Compliance Test application has not been installed. For information on the procedure to install SFP+ Compliance Test application see [Chapter 2](#), “Installing the SFP+ Compliance Test application. Or, one or more licenses required to run the Test Application are not installed on the Oscilloscope. You may also discover missing license information by launching the application under the **Analyze > Unlicensed Apps** menu. During startup, the application will display a detailed license message.

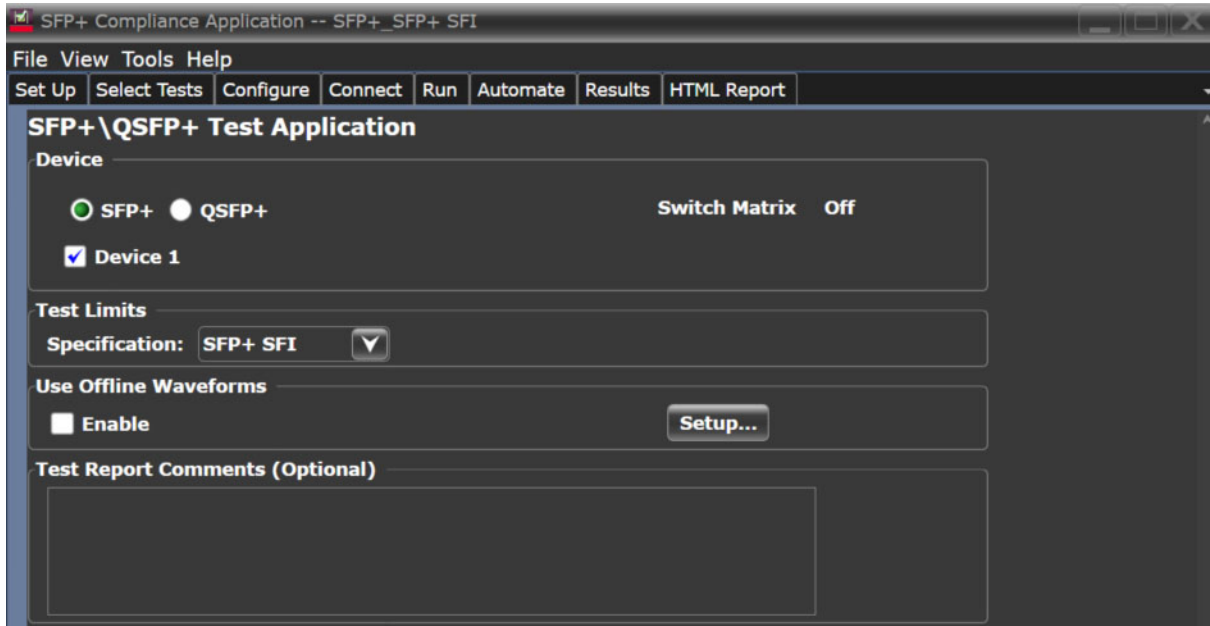

Figure 9 Default window of the SFP+ Compliance Test Application

The above figure shows the SFP+ Compliance Test application main window. The tabs in the main pane show the steps required to configure and execute the automated tests:

Tabs	Description
Set Up	Lets you select the Device as SFP+ or QSFP+ to execute the tests. Lets you select the test category for the desired host transmitter output test. Allows you to select the setting for direct copper cable attachment to check the compliance. Allows you to document test report comments.
Select Tests	Lets you select the tests you want to run. The tests are organized hierarchically so you can select all tests in a group. After tests are run, status indicators show which tests have passed, failed, or not been run, and there are indicators for the test groups.
Configure	Lets you configure test parameters. The information appears in the HTML report.
Connect	Shows you how to connect the oscilloscope to the device under test for the tests to be run.
Run Tests	Starts the automated tests. If the connections to the device under test need to be changed while multiple tests are running, the tests pause, show you how to change the connection, and wait for you to confirm that the connections have been changed before continuing.
Automation	Lets you construct scripts of commands that drive execution of the application.
Results	Contains more detailed information about the tests that have been run. You can change the thresholds at which marginal or critical warnings appear.
HTML Report	Shows a compliance test report that can be printed.

Online Help Topics

For information on using the SFP+ Compliance Test application, see its online help (which you can access by choosing **Help>Contents...** from the application's main menu).

The SFP+ Compliance Test application's online help describes the following:

- SFP+ Compliance Test Application—At a Glance

- Starting the SFP+ Compliance Test Application
- Creating or Opening a Test Project
- Setting Up the Test Environment
- Enabling Switch Matrix
- Setting Up InfiniiSim
- Setting Up the Precision Probe/Cable
- Selecting Tests
- Configuring Tests
- Connecting the Oscilloscope to the DUT
- Running Tests
- Automating the Application
- Viewing Results
- Viewing/Exporting/Printing the Report
- Understanding the Report
- Saving Test Projects
- User-Defined Add-Ins
- Controlling the Application via a Remote PC
- Using a Second Monitor

4 Host Transmitter Output Electrical Specifications Tests

SFP+ Host Transmitter Output Electrical Specifications at B / 26
XLPII Host Electrical Output Specification at TP1a / 47

This chapter provides the Methods of Implementation (MOIs) for host transmitter output electrical specifications tests using the SFP+ Compliance Test application. In this chapter, the host transmitter output electrical specifications tests are categorized as:

- SFP+ Host Transmitter Output Electrical Specifications at B
- XLPII Host Electrical Output Specification at TP1a

SFP+ Host Transmitter Output Electrical Specifications at B

This section describes the Enhanced Small Form Factor Pluggable (SFP+) electrical interface specifications tests for host transmitter output at B. The SFP+ electrical interface specifications includes management, mechanical, low speed signaling, high speed signaling, and appendices providing parameter and test board definitions, and implementation and measurement descriptions. The SFP+ electrical interface specifications are compiled in SFF-8431.

The SFP+ electrical interface specifications for host transmitter output at B are categorized as:

- SFP+ SFI: The high speed serial electrical interface between the host and the SFP+ module is called SFI. The SFP+ SFI electrical interface specification determines the host compliance test points definition and measurements and SFP+ host system specifications.
- 10GSFP+ Cu: The electrical interface used to implement the passive direct attach SFP+ cable assemblies is called 10GSP+ Cu. This electrical specification determines additional requirements or exceptions to implement the SFP+ host system specifications.

The SFP+ electrical interface specifications for host transmitter output at B define the measurement standards to execute various tests based on the following tests pattern:

- Test pattern 8180
- Test pattern PRBS9
- Test pattern PRBS31

Test Pattern 8180

Test pattern 8180 represents a repeating square wave which consists of eight continuous 1s followed by eight continuous 0s. This test pattern is used to check the SFP+ compliance against SFF-8431 specification for the following tests:

- Signal Rise Time (20%-80%)/Signal Fall Time (80%-20%) Test
- Transmitter Qsq/Transmitter Qsq for Cu Test
- Voltage Modulation Amplitude VMA for Cu (VMA) (p-p) Test

Signal Rise Time (20%-80%)/Signal Fall Time (80%-20%) Test

The **Signal Rise Time (20%-80%)/Signal Fall Time (80%-20%)** test measures the signal rise time and signal fall time of a SFP+ host transmitter respectively. The purpose of this test is to verify that the signal rise time or signal fall time of the SFP+ host transmitter is within the conformance limits of 34 ps as per the specification.

NOTE

For information about the connection diagram, refer to **“Connecting the Host Transmitter Board”** on page 20.

Configuring Test Parameter

To execute the **Signal Rise Time (20%-80%)/Signal Fall Time (80%-20%)** test, you need to configure the **#Averages(16)** parameter. The **#Averages(16)** parameter is used to reduce the effect of noise on the measurement. The value of one average is calculated by averaging multiple acquisitions of the waveform. Sixteen (16) is used as the default value but you can increase or decrease this number to reduce or upsurge the effects of noise and random signal variations.

NOTE

Averaging can be used to reduce measurement noise and increase measurement resolution; however, the specification does not provide any constraints on how much averaging may be used but increase in the value of the **#Averages(16)** parameter leads to diminishing results.

Understanding the Test Flow

The following references from the SFF-8431 specification are considered to check the compliance of the DUT:

[1] SFF-8431, Appendix D.7

[2] SFF-8431, Appendix D.6

[3] SFF-8431, Section 3.5.1, Table 12

The SFP+ test application performs the following automated steps for measuring the **Signal Rise Time (20%-80%)/Signal Fall Time (80%-20%)** test based on the above mentioned references:

- 1 Triggers one cycle of the 8180 waveform on the rising edge.
- 2 Analyzes the signal rise/fall time of the signal at logic 0 and logic 1 voltage levels. The measurement procedure of the logic 0 and logic 1 state is defined as per reference [1]. The average voltage level in the central 20% of each time interval is measured.
- 3 Measures the 20% to 80% signal rise time using the logic 0 voltage level as base level and logic 1 voltage level as top level of the isolated edges in case of the **Signal Rise Time (20%-80%)** test. Measures the 80% to 20% fall time using the logic 1 voltage level as base level and logic 0 voltage level as top level of the isolated edges in case of the **Signal Fall Time (80%-20%)** test. From reference [2], the optical modulation amplitude (OMA) test pattern (eight ones, eight zeros) is being used as the normative test pattern. The 0% level and 100% level are the voltage levels of the logic 0 state and logic 1 state respectively as defined by the xMA measurement procedure in the specification.
- 4 Analyzes the signal and verifies that this is as per the conformance limits as specified in reference [3].

Viewing Test Results

For each test trial, its result is displayed on the **Results** tab. Click the desired test to view its result. Details of the test results are described in the lower pane. A sample reference image based on the measured values is captured by the oscilloscope. You can click the sample reference image to view the details. For information about the test results, refer to **Viewing Results** in the Online help.

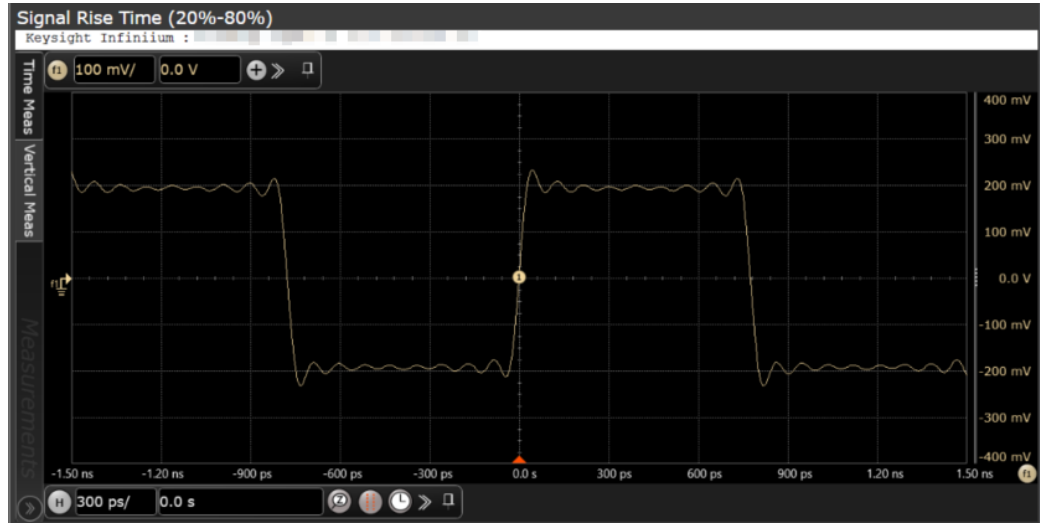

Figure 10 Reference Image for Signal Rise Time (20%-80%) Test

Transmitter Qsq/Transmitter Qsq for Cu Test

The **Transmitter Qsq/Transmitter Qsq for Cu** test is a measure of reciprocal of signal to noise ratio (SNR) of the SFP+ host transmitter.

$$Q_{sq} = \frac{1}{SNR}$$

As per SFF-8431, Appendix D.8, Q_{sq} is given by $1/RN$ when the logicONnoise (RMS) equals logicZEROnoise (RMS), whereby, RN refers to relative noise and is calculated using the following formula:

$$Q_{sq} = \frac{1}{RN} = \frac{(VMA)}{(2 \times noise(RMS))}$$

To calculate RN,

- The value for voltage modulation amplitude (VMA) measurement is as defined in SFF-8431, Appendix D.7. For information on the measurement of VMA, refer to ["Voltage Modulation Amplitude for Cu \(VMA\) \(p-p\) Test"](#) on page 30.
- Noises at both logic levels are measured and the rms technique is applied according to the following equation:

$$noise(RMS) = \sqrt{\frac{(\text{LogicONnoise}(RMS))^2 + \text{logicZEROnoise}(RMS)^2}{2}}$$

The purpose of this test is to verify that the signal to noise ratio of the SFP+ host transmitter is within the conformance limits of 50.

NOTE

For information about the connection diagram, refer to [“Connecting the Host Transmitter Board”](#) on page 20.

Configuring Test Parameter

To execute the **Transmitter Qsq/Transmitter Qsq for Cu** test, you need to configure the **#Waveforms(60)** parameter. The **#Waveforms(60)** parameter is used to reduce the effect of noise on the measurement. Sixty (60) is used as the default value but you can increase or decrease this number to reduce or upsurge the effects of noise and random signal variations.

Understanding the Test Flow

The following references from the SFF-8431 specification are considered to check the compliance of the DUT:

- [1] SFF-8431, Appendix D.7
- [2] SFF-8431, Appendix D.8
- [3] SFF-8431, Section 3.5.1, Table 12 (For **Transmitter Qsq** Test)
- [4] SFF-8431, Appendix E.2, Table 33 (For **Transmitter Qsq for Cu** Test)

The SFP+ test application performs the following automated steps for executing the **Transmitter Qsq/Transmitter Qsq for Cu** test based on the above mentioned references:

- 1 Triggers one cycle of the 8180 waveform on the rising edge.
- 2 Analyzes the rise/fall time of the signal at logic 0 and logic 1 voltage levels. Reference [1] defines the measurement procedure of the logic 0 and logic 1 states. The average voltage level in the central 20% of each time interval is measured.
- 3 Measures the value for VMA using the logic 0 voltage level as base level and logic 1 voltage level. For information on the measurement of VMA, refer to [“Voltage Modulation Amplitude for Cu \(VMA\) \(p-p\) Test”](#) on page 30.
- 4 Measures the root mean square (RMS) noise for the logic 0 and logic 1 levels. From reference [2], the optical modulation amplitude (OMA) test pattern (eight ones, eight zeros) is being used as the normative test pattern. The 0% level and 100% level are the voltage levels of the logic 0 state and logic 1 state respectively as defined by the xMA measurement procedure in the specification.
- 5 Calculates the value of Q_{sq} using the formula mentioned above.
- 6 Analyzes the signal and verify that this is as per the conformance limits of 50 as specified in reference [3] for **Transmitter Qsq** test. Analyzes the signal and verify that this is as per the conformance limits of 63.1 as specified in reference [4] for **Transmitter Qsq for Cu** test.

Viewing Test Results

For each test trial, its result is displayed on the **Results** tab. Click the desired test to view its result. Details of the test results are described in the lower pane. A sample reference image based on the measured values is captured by the oscilloscope. You can click the sample reference image to view the details. For information about the test results, refer to **Viewing Results** in the Online help.

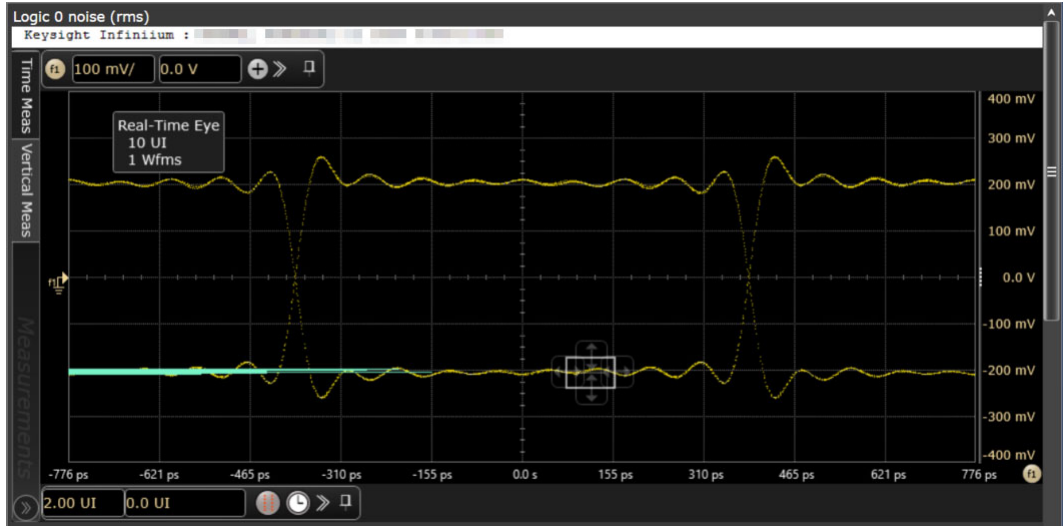

Figure 11 Reference Image for Transmitter Q_{sq} Test for Logic 0

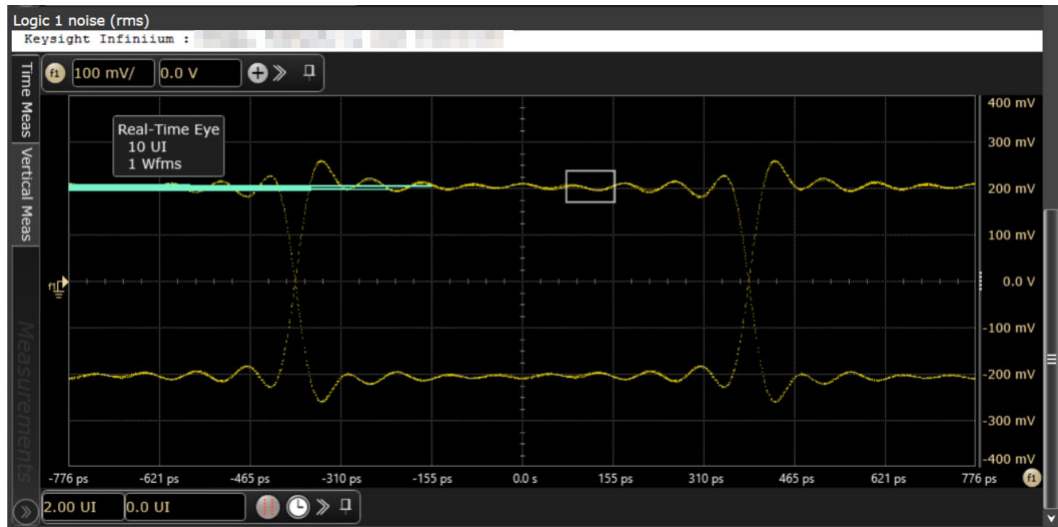

Figure 12 Reference Image for Transmitter Q_{sq} Test for Logic 1

Voltage Modulation Amplitude for Cu (VMA) (p-p) Test

The **Voltage Modulation Amplitude for Cu (VMA) (p-p)** test measures the voltage modulation amplitude (VMA) value from peak-to-peak (p-p) for a SFP+ host transmitter supporting passive direct attach cables.

NOTE

For information about the connection diagram, refer to [“Connecting the Host Transmitter Board”](#) on page 20.

Understanding the Test Flow

The following references from the SFF-8431 specification are considered to check the compliance of the DUT:

[1] SFF-8431, Appendix E.2, Table 33

[2] SFF-8431, Appendix D.7

The SFP+ test application performs the following automated steps for executing the **Voltage Modulation Amplitude for Cu (VMA) (p-p)** test based on the above mentioned references:

- 1 Triggers one cycle of the 8180 waveform on the rising edge. One cycle of the 8180 waveform is divided into two equally spaced time intervals of 8 units interval long.
- 2 Measures the logic 0 voltage level as the average voltage level in the central 20% of the negative pulse.
- 3 Measures the logic 1 voltage level as the average voltage level in the central 20% of the positive pulse.
- 4 Measures the value for VMA as the difference between the logic 0 voltage level as base level and logic 1 voltage level as defined in Reference [2]. Reference [1] specifies minimum value of VMA as 300 mV.

Viewing Test Results

For each test trial, its result is displayed on the **Results** tab. Click the desired test to view its result. Details of the test results are described in the lower pane. A sample reference image based on the measured values is captured by the oscilloscope. You can click the sample reference image to view the details. For information about the test results, refer to **Viewing Results** in the Online help.



Figure 13 Reference Image for VMA for Cu (p-p) Test for Logic 0



Figure 14 Reference Image for VMA for Cu (p-p) Test for Logic 1

Test Pattern PRBS9

PRBS9 test pattern represents a pseudorandom binary sequence with a repetition period of 2^9-1 . This test pattern is used to measure jitter for the following tests:

- Data Dependent Jitter (DDJ) (p-p) Test
- Data Dependent Pulse Width Shrinkage (DDPWS) (p-p) Test
- Uncorrelated Jitter (UJ) (RMS) Test
- Transmitter Waveform Distortion Penalty for Cu (TWDPc) Test

Data Dependent Jitter (DDJ) (p-p) Test

The **Data Dependent Jitter (DDJ) (p-p)** test measures the undesired deviation of data at threshold-crossing time from true periodicity of an assumed periodic signal in reference to a clock source. The purpose of this test is to measure the deviation of data threshold-crossing time from peak-to-peak (p-p) using the SFP+ host compliance application.

NOTE

For information about the connection diagram, refer to [“Connecting the Host Transmitter Board”](#) on page 20.

Understanding the Test Flow

The following references from the SFF-8431 specification are considered to check the compliance of the DUT:

[1] SFF-8431, Appendix D.3

[2] SFF-8431, Section 3.5.1, Table 12

The SFP+ test application performs the following automated steps for executing the **Data Dependent Jitter (DDJ) (p-p)** test based on the above mentioned references:

- 1 Triggers 1024 cycles of the PRBS9 waveform.
- 2 Turns on EZJIT complete and sets the pattern analysis mode to periodic. As the PRBS9 pattern is relatively short, the DDJ pattern completes in periodic pattern analysis mode.
- 3 Analyzes the signal and verifies that this is as per the conformance limits of 100.0mUI as specified in reference [2]. DDJ is the jitter that is correlated to its data pattern and is described by the formula:

$$DDJ = \max(\Delta t_1, \Delta t_2 \dots \Delta t_n) - \min(\Delta t_1, \Delta t_2 \dots \Delta t_n)$$

whereby, Δt_n is the difference between the expected time and actual time of edge n.

Viewing Test Results

For each test trial, its result is displayed on the **Results** tab. Click the desired test to view its result. Details of the test results are described in the lower pane. A sample reference image based on the measured values is captured by the oscilloscope. You can click the sample reference image to view the details. For information about the test results, refer to **Viewing Results** in the Online help.

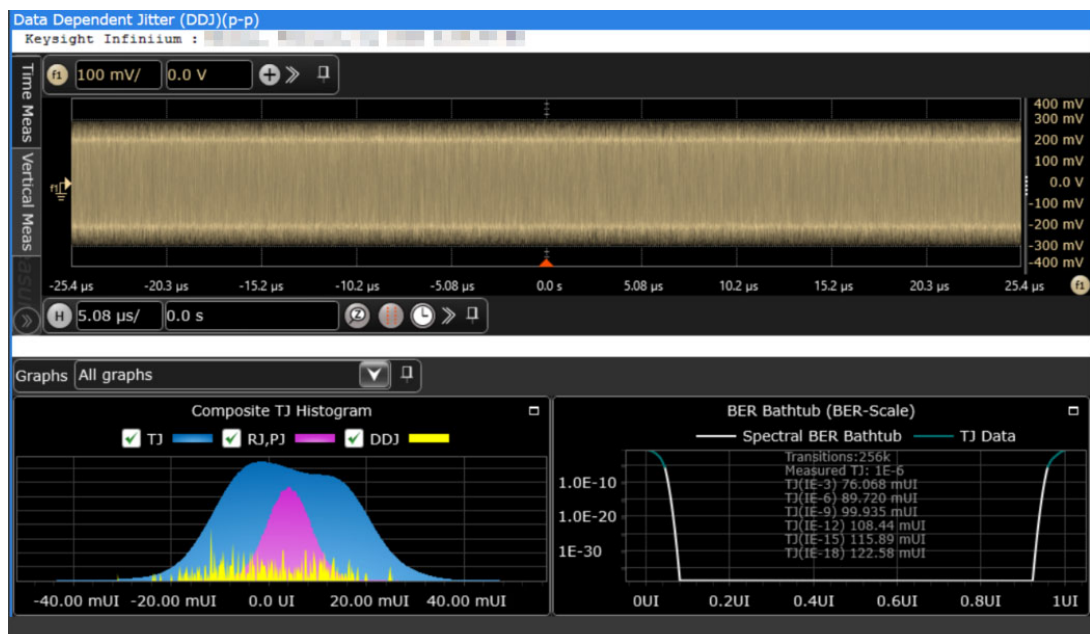

Figure 15 Reference Image for Data Dependent Jitter (DDJ) (p-p) Test

Data Dependent Pulse Width Shrinkage (DDPWS) (p-p) Test

The **Data Dependent Pulse Width Shrinkage (DDPWS) (p-p)** test measures the value of data dependent pulse width shrinkage (DDPWS) from peak-to-peak (p-p) of a SFP+ host transmitter.

NOTE

For information about the connection diagram, refer to [“Connecting the Host Transmitter Board”](#) on page 20.

Understanding the Test Flow

The following references from the SFF-8431 specification are considered to check the compliance of the DUT:

[1] SFF-8431, Appendix D.3

[2] SFF-8431, Section 3.5.1, Table 12

The SFP+ test application performs the following automated steps for executing the **Data Dependent Pulse Width Shrinkage (DDPWS) (p-p)** test based on the above mentioned references:

- 1 Triggers 1024 cycles of the PRBS9 waveform.
- 2 Turns on EZJIT complete and sets the pattern analysis mode to periodic. As the PRBS9 pattern is relatively short, the DDPWS pattern completes in periodic pattern analysis mode.
- 3 Analyzes the signal and verifies that this is as per the conformance limits of 100.0mUI as specified in reference [2]. For a capture with n edges, DDPWS is measured as the difference between one symbol period and the minimum pulse width of the entire capture. It is given by the algorithm:

$$DDPWS = T - \min(t_2 - t_1, t_3 - t_2, \dots, t_{n+1} - t_n)$$

whereby, T is the symbol period of the data stream and t_n is the time of occurrence of edge n.

Viewing Test Results

For each test trial, its result is displayed on the **Results** tab. Click the desired test to view its result. Details of the test results are described in the lower pane. A sample reference image based on the measured values is captured by the oscilloscope. You can click the sample reference image to view the details. For information about the test results, refer to **Viewing Results** in the Online help.

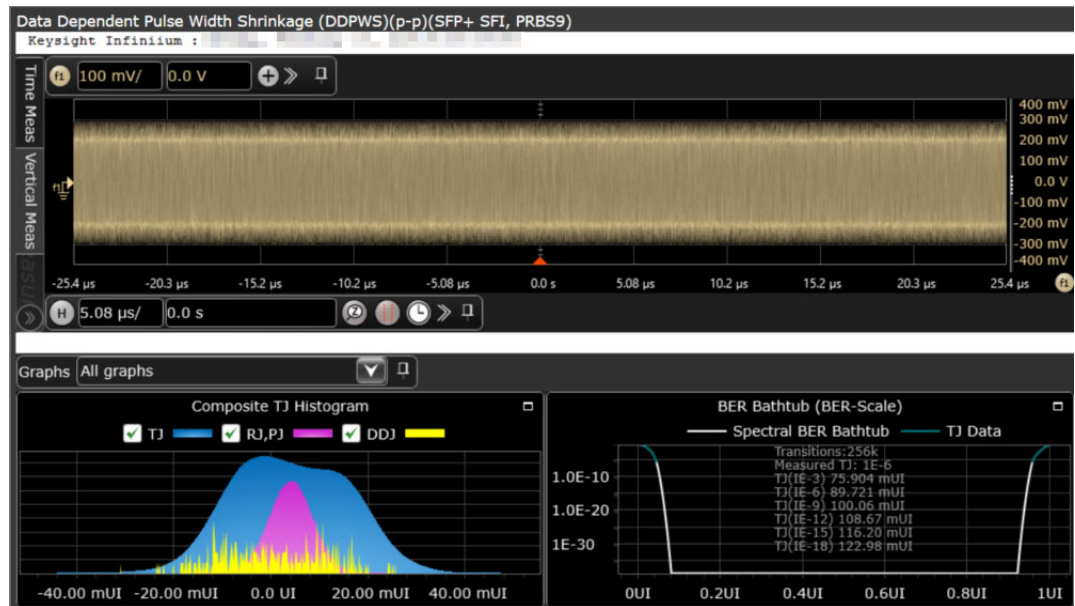

Figure 16 Reference Image for Data Dependent Pulse Width Shrinkage (p-p) Test

Uncorrelated Jitter (UJ) (RMS) Test

The **Uncorrelated Jitter (UJ) (RMS)** test measures any jitter that is un-correlated to the 64B/66B bit stream of a SFP+ host transmitter. The measured jitter value is not related to the data pattern. For information about the definition and considerations for UJ, refer to IEEE 802.3 CL68.6.8 and SFF-8431, Appendix D.7.

NOTE

For information about the connection diagram, refer to ["Connecting the Host Transmitter Board"](#) on page 20.

Configuring Test Parameter

To execute the UJ test, you need to configure the **#Hits(100)** parameter. The **#Hits(100)** parameter is used as the default value but you can increase or decrease this number to specify the minimum number of hits on the histogram acquired for the **Uncorrelated Jitter (UJ) (RMS)** test.

Understanding the Test Flow

The following references from the SFF-8431 and IEEE 802.3 specifications are considered to check the compliance of the DUT:

[1] SFF-8431, Section 3.5.1, Table 12

[2] IEEE 802.3, Section 68.6.8

The SFP+ test application performs the following automated steps for executing the **Uncorrelated Jitter (UJ) (RMS)** test based on the above mentioned references:

- 1 Triggers and persists multiple cycles of the PRBS9 waveform on the scope.
- 2 Places a histogram on the average power level of the rising edge and falling edge.

- 3 Measures the standard deviation, σ , of the rising and falling edge.
- 4 Calculates the RMS value of the UJ using the formula as specified in reference [2] and is given by:

$$\text{Uncorrelated Jitter (rms)} = \sqrt{(\sigma_r^2 + \sigma_f^2)/2}$$

Where, σ_r is the standard deviation of the rising edge

σ_f is the standard deviation of the falling edge

The standard deviation of the rising and falling edge is measured using a histogram window that is positioned at the average power level of the signal.

Viewing Test Results

For each test trial, its result is displayed on the **Results** tab. Click the desired test to view its result. Details of the test results are described in the lower pane. A sample reference image based on the measured values is captured by the oscilloscope. You can click the sample reference image to view the details. For information about the test results, refer to **Viewing Results** in the Online help.



Figure 17 Reference Image for Uncorrelated Jitter (RMS) Test for Rising Edge



Figure 18 Reference Image for Uncorrelated Jitter (RMS) Test for Falling Edge

Transmitter Waveform Dispersion Penalty for Cu (TWDPc) Test

The **transmitter waveform dispersion penalty for Cu (TWDPc)** test measures the transmitter waveform dispersion penalty of a SFP+ host transmitter supporting passive direct attach cables. Waveform distortion penalty (WDP) is a measure of dispersion penalty due to a particular transmitter with reference to emulated transmission lines and receiver.

The WDP algorithm expects 16 samples per UI. For a 10GBase-T signal, this would require a sampling rate of around 160GSa/s. This sampling rate is not possible for most of the scopes, so interpolation is enabled during acquisition to achieve the required number of samples. $\text{Sin}(x)/x$ is one of the methods recommended in SFF-8431, Appendix D.9 and this is also the same interpolation method used by Infiniium.

The interpolated data pattern will need to be further processed as the algorithm required does not have exactly 16 samples per unit interval. Re-sampling is done by performing a simple interpolation, followed by decimation to achieve the exact number of samples.

NOTE

For information about the connection diagram, refer to ["Connecting the Host Transmitter Board"](#) on page 20.

Understanding the Test Flow

The following references from the SFF-8431 and IEEE 802.3 specifications are considered to check the compliance of the DUT:

- [1] SFF-8431, Appendix E.2, Table 33
- [2] SFF-8431, Appendix G
- [3] SFF-8431, Appendix D.9
- [4] IEEE 802.3, Section 68.6.6.1

The SFP+ test application performs the following automated steps for executing the **Transmitter waveform dispersion penalty for Cu (TWDPc)** test:

- 1 Triggers one cycle of the PRBS9 waveform with averaging and sin (x)/x interpolation enabled.
- 2 Saves the waveform.
- 3 Processes the saved waveform as specified in ["Compiling the MATLAB Deployment Project"](#) on page 38. For a compliant SFP+ host transmitter, reference [1] specifies a maximum TWDPc of 10.7dBe.

NOTE

Averaging is applied in order to reduce uncorrelated jitter and noise effects as recommended in reference [3].

Compiling the MATLAB Deployment Project

You need to perform the following steps to compile the MATLAB script:

- 1 Launch MATLAB.
- 2 From the **File** menu, select **New** and click **Script** to create a MATLAB ".m" file using the script provided in Appendix G of the SFF-8431 specification.

NOTE

MATLAB 2011a(32-bit) is required to compile the script.

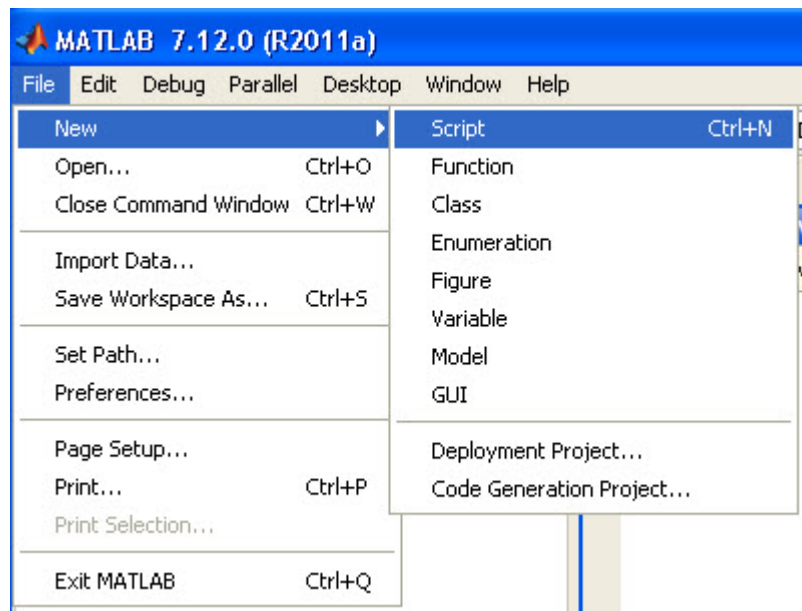

- 3 From the **File** menu, select **New** and click **Script** to create another matlab ".m" file using the following code:

```

function
SFF8431xWDPWrapper (WaveformFile, TxDataFile, EqNf, EqNb, SymbolRate,
Usage)

% wrapper for the SFF-8431 code

% convert input
EqNf = str2double (EqNf);
EqNb = str2double (EqNb);
SymbolRate = str2double (SymbolRate);

% copy the PRBS9 file into the working folder
XmitData = load (TxDataFile); %#ok<NASGU>
save ('prbs9_950.txt', '-ascii', 'XmitData');

[xWDP, MeasuredxMA] = SFF8431xWDP (WaveformFile, EqNf, EqNb, SymbolRate
, Usage);

% display the results. this will be captured on stdout. app will
parse

% stdout for the results. Do not change this order!
disp (xWDP);
disp (' ');
disp (MeasuredxMA);
end

```

- 4 From the **File** menu, select **New** and click **Deployment Project** to create a new Matlab deployment project.

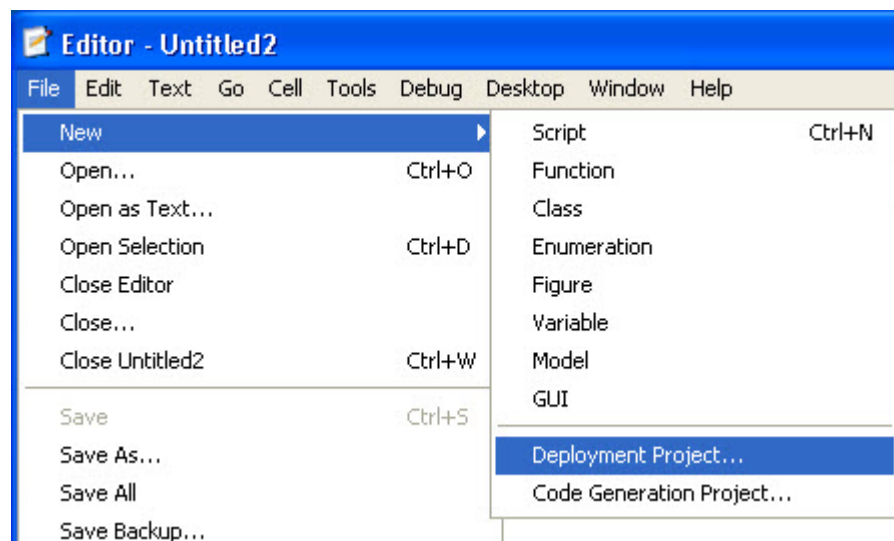

Figure 19 New Deployment Project

The Deployment Project dialog box appears.

- 5 Enter a name of the deployment project.
- 6 Specify a location to save the project.
- 7 Select **Console Application** in the Type drop-down list, and click **OK**.

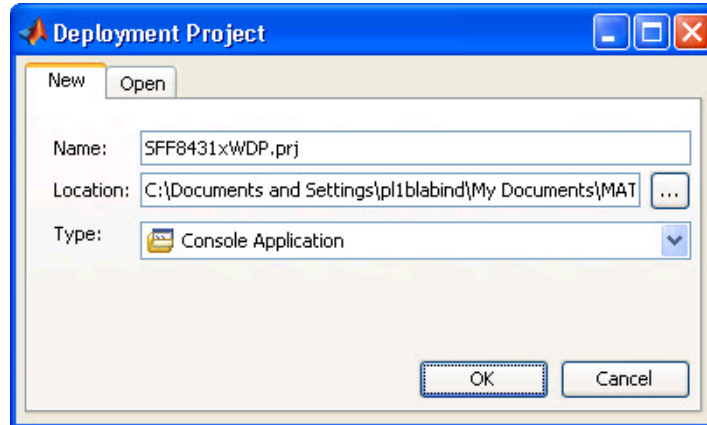

Figure 20 The Deployment Project Dialog Box

The Console Application dialog box appears.

- 8 Add the file created in step 2 into the **Main File** section.
- 9 Add the file created in step 1 into the **Shared Resources and Helper Files** section.

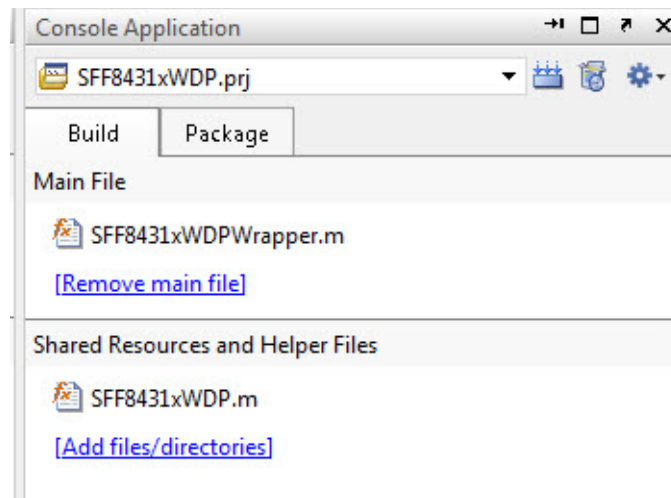



Figure 21 The Console Application Dialog Box

- 10 Click  to build the project and save the output file at the following location:
 "C:\Program Files (x86)\Keysight\Infinium\Apps\SFP+Test\app\matlab"

Viewing Test Results

For each test trial, its result is displayed on the **Results** tab. Click the desired test to view its result. Details of the test results are described in the lower pane. For information about the test results, refer to **Viewing Results** in the Online help.

Test Pattern PRBS31

PRBS31 test pattern represents a pseudorandom binary sequence with a repetition period of $2^{31}-1$. The sequence is defined in IEEE Std 802.3, 49.2.8. This test pattern is used to check the compliance of the SFP+ host transmitter output using the following tests:

- Output AC Common Mode Voltage (rms) Test/Output AC Common Mode Voltage for Cu (rms) Test
- Single Ended Voltage Range (Positive) Test/Single Ended Voltage Range (Negative) Test
- Total Jitter (TJ) (p-p) Test
- Eye Mask Hit Ratio Test

Output AC Common Mode Voltage (rms) Test/Output AC Common Mode Voltage for Cu (rms) Test

The **Output AC Common Mode Voltage (rms)/Output AC Common Mode Voltage for Cu (rms)** test measures the output AC common mode voltage of a SFP+ host transmitter without/with passive direct attach cables attached respectively.

NOTE

For information about the connection diagram, refer to ["Connecting the Host Transmitter Board"](#) on page 20.

Understanding the Test Flow

The following references from the SFF-8431 specification are considered to check the compliance of the DUT:

- [1] SFF-8431, Appendix 3.5.1, Table 1 for **Output AC Common Mode Voltage (rms)** test
- [2] SFF-8431, Appendix E.2, Table 33 for **Output AC Common Mode Voltage (rms) for Cu** test
- [3] SFF-8431, Appendix D.15

The SFP+ test application performs the following automated steps for executing the **Output AC Common Mode Voltage (rms)/Output AC Common Mode Voltage for Cu (rms)** test:

- 1 Triggers the PRBS31 waveform.
- 2 Folds the PRBS31 waveform.
- 3 Places a histogram with a width of 1 unit interval across the folded waveform. According to the procedure specified in reference [2], the output AC common mode voltage (rms) is measured by applying a histogram over one UI of the common mode signal. Multiple unit intervals are overlapped to get an averaged measurement. The scope is set to free run triggering as the oscilloscopes do not have the memory depth for 1 cycle of the PRBS31 waveform. For a compliant SFP+ host transmitter, reference [1] specifies a maximum AC common mode voltage of 15mV, rms for **Output AC Common Mode Voltage (rms)** test. For a compliant SFP+ host transmitter, reference [2] specifies a maximum AC common mode voltage of 12mV, rms for **Output AC Common Mode Voltage (rms) for Cu** test.

Viewing Test Results

For each test trial, its result is displayed on the **Results** tab. Click the desired test to view its result. Details of the test results are described in the lower pane. A sample reference image based on the measured values is captured by the oscilloscope. You can click the sample reference image to view the details. For information about the test results, refer to **Viewing Results** in the Online help.

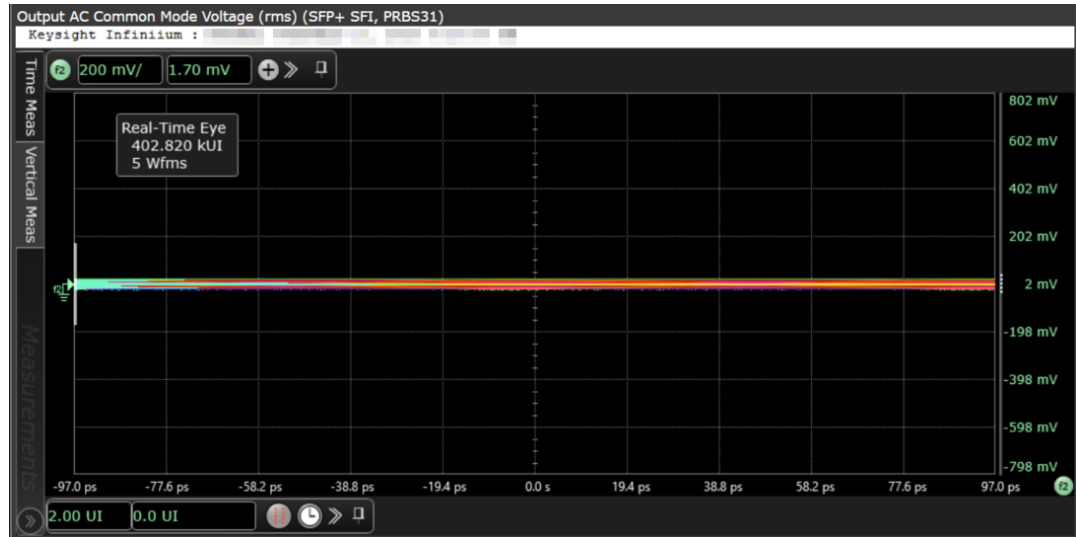

Figure 22 Reference Image for Output AC Common Mode Voltage (RMS) Test

Single Ended Voltage Range (Positive) Test/Single Ended Voltage Range (Negative) Test

The **Single Ended Voltage Range (Positive) test/Single Ended Voltage Range (Negative) test** measures the voltage range of the positive (TX+) and negative (TX-) signals respectively of a SFP+ host transmitter.

Making Hardware Connections

You need to perform the following steps to connect the host compliance board (HCB) to an oscilloscope:

- 1 Plug the SFP+ Host Compliance Board (HCB) into the SFP+ DUT.
- 2 Remove DC blocks from the TX+ and TX- output if previously connected.
- 3 Connect the TX+ output of the HCB to Channel 1 using an SMA cable.
- 4 Connect the TX- output of the HCB to Channel 3 using an SMA cable.
- 5 Configure the SFP+ host to transmit the PRBS31 test pattern.

NOTE

For UXR oscilloscopes, please apply 6dB attenuator to the TX+ and TX-.

The following figure shows the connection diagram between the HCB and an oscilloscope:

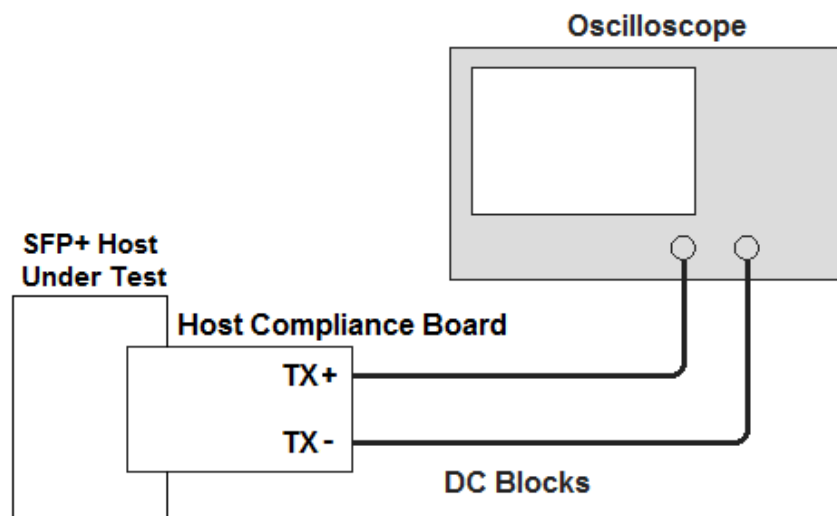

Figure 23 Host Transmitter Output Connection Diagram for Single Ended Voltage Range Tests

Understanding the Test Flow

The following reference from the SFF-8431 specification is considered to check the compliance of the DUT:

[1] SFF-8431, Section 3.5.1, Table 11

The SFP+ test application performs the following automated steps for executing the **Single Ended Voltage Range (Positive) test/Single Ended Voltage Range (Negative) test** based on the above mentioned references:

- 1 Triggers the PRBS31 waveform.
- 2 Measures the peak-to-peak (p-p) voltage. For a compliant SFP+ host transmitter, reference [1] specifies the single ended voltage range to be between -0.3V and 4.0V.

Viewing Test Results

For each test trial, its result is displayed on the **Results** tab. Click the desired test to view its result. Details of the test results are described in the lower pane. A sample reference image based on the measured values is captured by the oscilloscope. You can click the sample reference image to view the details. For information about the test results, refer to **Viewing Results** in the Online help.

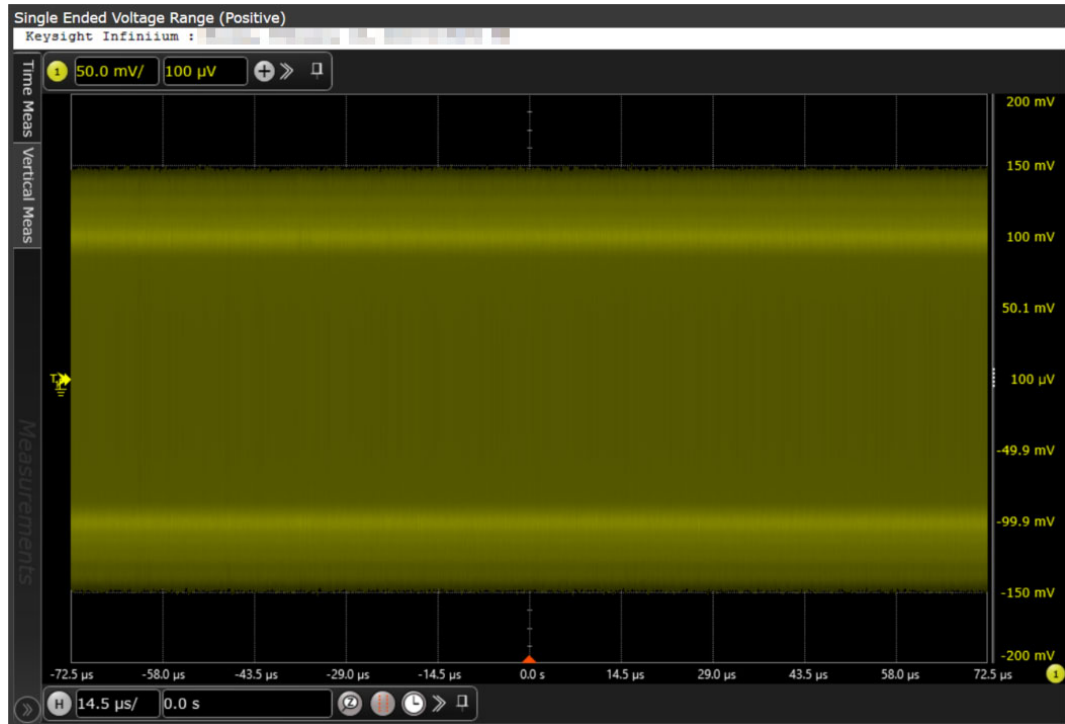

Figure 24 Reference Image for Single Ended Voltage Range (Positive) Test

Total Jitter (TJ) (p-p) Test

The **Total Jitter (TJ) (p-p)** test measures the total jitter of a SFP+ host transmitter.

NOTE

For information about the connection diagram, refer to [“Connecting the Host Transmitter Board”](#) on page 20.

Understanding the Test Flow

The following references from the SFF-8431 specification are considered to check the compliance of the DUT:

- [1] SFF-8431, Section 3.5.1, Table 12
- [2] SFF-8431, Section 3.5.2, Appendix D.2

The SFP+ test application performs the following automated steps for executing the **Total Jitter (TJ) (p-p)** test based on the above mentioned references:

- 1 Triggers the PRBS31 waveform.
- 2 Turns on EZJIT Complete, and set the pattern analysis mode to **Arbitrary** as the signal is relatively long.
- 3 Obtains the results for TJ for a compliant SFP+ host transmitter. Reference [1] specifies a maximum TJ of 0.28UI, peak-to-peak.

NOTE

The clock recovery method used is the one recommended in reference [2], which is a second order PLL with a loop bandwidth of 4MHz and a slope of -20dB/decade with a peaking of 0.1dB.

Viewing Test Results

For each test trial, its result is displayed on the **Results** tab. Click the desired test to view its result. Details of the test results are described in the lower pane. A sample reference image based on the measured values is captured by the oscilloscope. You can click the sample reference image to view the details. For information about the test results, refer to **Viewing Results** in the Online help.

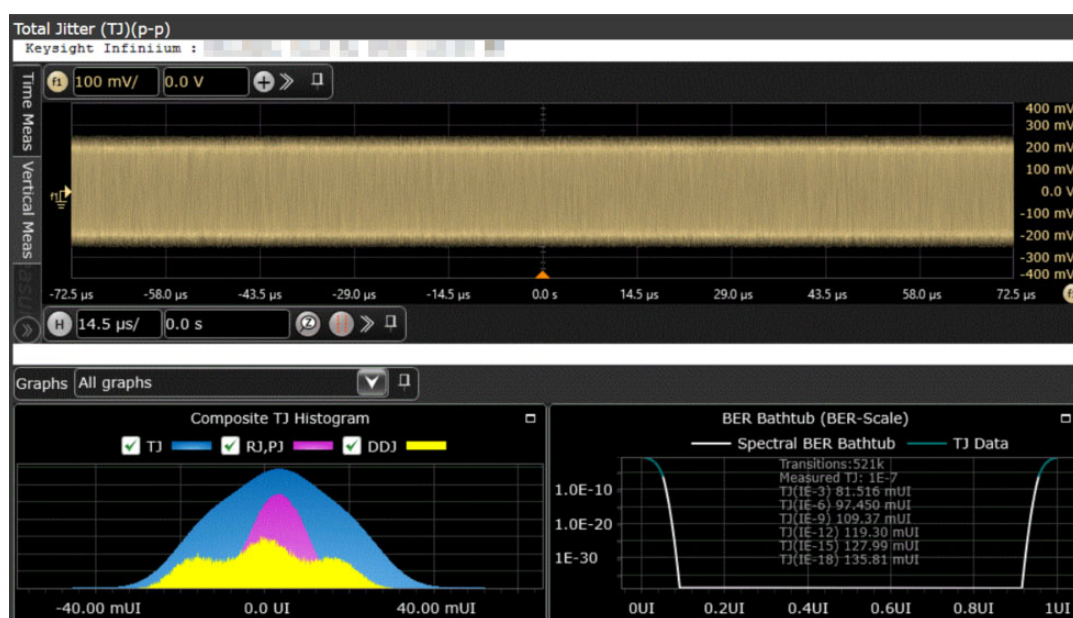

Figure 25 Reference Image for Total Jitter (TJ) (p-p) Test

Eye Mask Hit Ratio Test

The **Eye Mask Hit Ratio** test measures the eye mask hit ratio of SFP+ host transmitter. The eye mask is defined by the parameters X1, X2, Y1, and Y2. The eye is defined as measured using a receiver with an electrical -3dB bandwidth of 12GHz such as Bessel-Thomson response. As per the relevant standard, the mask hit ratio is set to 5×10^{-5} .

NOTE

For information about the connection diagram, refer to ["Connecting the Host Transmitter Board"](#) on page 20.

Understanding the Test Flow

The following references from the SFF-8431 specification are considered to check the compliance of the DUT:

[1] SFF-8431, Section 3.5.1, Table 12

[2] SFF-8431, Section 3.5.1, Appendix D.2

The SFP+ test application performs the following automated steps for executing the **Eye Mask Hit Ratio** test:

Enables the **Mask Test** and loads the test. Enabling the **Mask Test** allows you to conform the waveform as per the industry standards.

- 4 Triggers the PRBS31 waveform for the **Mask Test**.
- 5 Calculates the eye mask hit ratio. For a compliant SFP+ host transmitter, reference [1] specifies an eye mask hit ratio that is less than 5×10^{-15} .

The eye mask hit ratio is calculated using the formula:

$$\text{Hit Ratio} = \frac{\text{Total Mask Violations}}{\text{Total Number of Samples in 1UI}}$$

And the total number of samples in 1UI is given by:

$$\text{Total Number of Samples in 1 UI} = \text{Sampling Rate} \times 1 \text{ UI}$$

NOTE

The clock recovery method used is the one recommended in reference [2], which is a second order PLL with a loop bandwidth of 4MHz and a slope of -20dB/decade with a peaking of 0.1dB.

Viewing Test Results

For each test trial, its result is displayed on the **Results** tab. Click the desired test to view its result. Details of the test results are described in the lower pane. A sample reference image based on the measured values is captured by the oscilloscope. You can click the sample reference image to view the details. For information about the test results, refer to **Viewing Results** in the Online help.

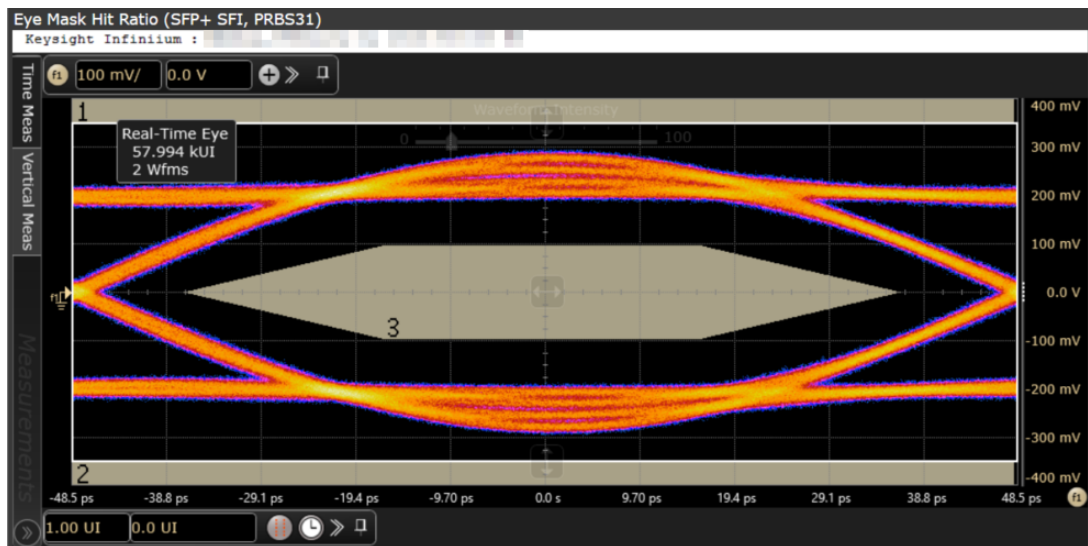

Figure 26 Reference Image for Eye Mask Hit Ratio Test

XLPPPI Host Electrical Output Specification at TP1a

XLPPPI host electrical output specification at TP1a describes the 40Gb/s parallel physical interface (XLPPPI, four lanes) used with 40GBASE-SR4 or 40GBASE-LR4 as an optional instantiation of the physical medium dependent (PMD) service interface. The PMD service interface supports the exchange of encoded data between the physical medium attachment (PMA) entity and PMD entity. The PMD translates the encoded data to and from signals suitable for the specified medium. The XLPPPI electrical interface specifications are compiled in IEEE 802.3.

The XLPPPI electrical interface specifications for host transmitter output at TP1a defines the measurement standards to execute various tests based on the following tests pattern:

- Test pattern 8180
- Test pattern PRBS9
- Test pattern PRBS31

Before executing the tests based on the above mentioned test patterns, you may need to calibrate the input signals to control the crosstalk effects at the source.

Crosstalk Source Calibration

Crosstalk source calibration when applied to all the input lanes of the XLPPPI host allows the SFP+ test application to verify that the test results at the output lane and signals are as per the conformance limits in the specification. You may need to do the crosstalk source calibration for the input signals based on the following crosstalk source signals:

- Crosstalk Source VMA (p-p) Calibration
- Crosstalk Source Rise Time (20%-80%) Calibration
- Crosstalk Source Fall Time (80%-20%) Calibration

The following section describes the execution of the above mentioned crosstalk source signals by the SFP+ application.

Crosstalk Source VMA (p-p) Calibration

The **Crosstalk Source VMA (p-p)** calibration measures the voltage modulation amplitude (VMA) for the crosstalk source calibration process.

NOTE

For information about the connection diagram, refer to [“Connecting the Host Transmitter Board”](#) on page 20.

Understanding the Calibration Flow

The following reference from the IEEE802.3 specification is considered for the crosstalk source VMA (p-p) calibration process:

[1] IEEE802.3ba-2010, Annex 86A, Table 86A-1

The SFP+ test application performs the following automated steps for executing the **Crosstalk Source VMA (p-p)** calibration:

- 1 Triggers one cycle of the 8180 waveform on the rising edge. One cycle of the 8180 waveform is divided into two equally spaced time intervals of 8 units interval long.
- 2 Measures the logic 0 voltage level as the average voltage level in the central 20% of the negative pulse.
- 3 Measures the logic 1 voltage level as the average voltage level in the central 20% of the positive pulse.

- 4 Measures the value for VMA as the difference between the logic 0 voltage level as base level and logic 1 voltage level as defined in Reference [2]. Reference [1] specifies minimum value of VMA as 300 mV.

Viewing Crosstalk Source Calibration Result

For each test trial, its result is displayed on the **Results** tab. Click the desired test to view its result. Details of the test results are described in the lower pane. A sample reference image based on the measured values is captured by the oscilloscope. You can click the sample reference image to view the details. For information about the test results, refer to **Viewing Results** in the Online help.

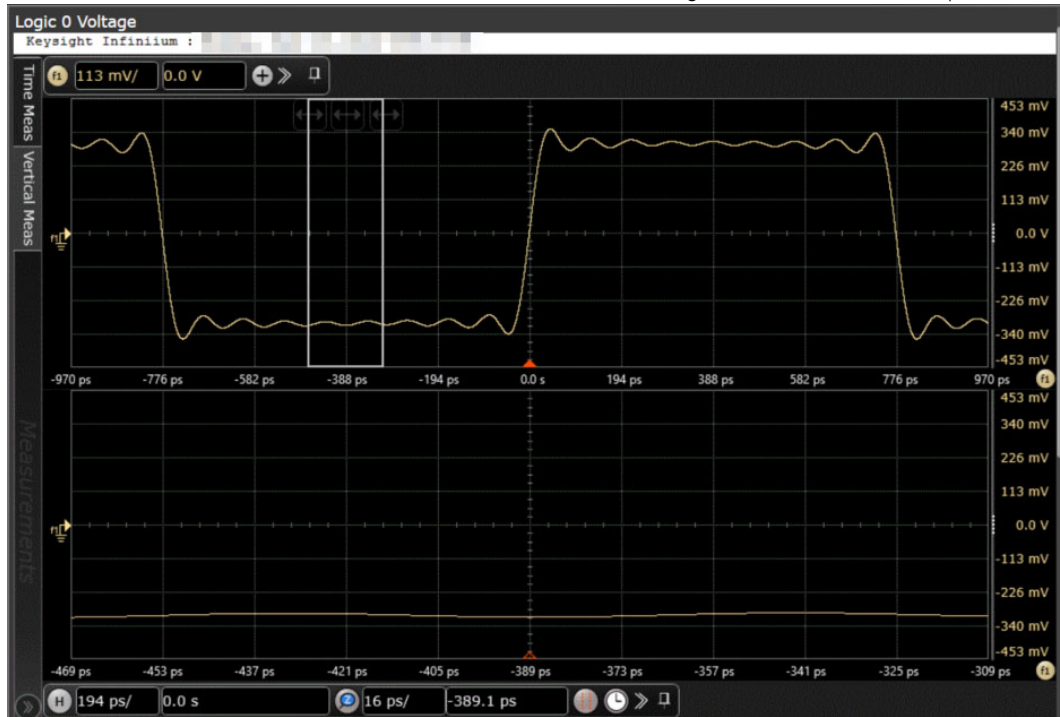

Figure 27 Reference Image for Crosstalk Source VMA (p-p) for Logic 0



Figure 28 Reference Image for Crosstalk Source VMA (p-p) for Logic 1

Crosstalk Source Rise Time (20% - 80%) Calibration

The **Crosstalk Source Rise Time** calibration measures the 20%-80% rise time for the crosstalk source calibration process.

NOTE

For information about the connection diagram, refer to [“Connecting the Host Transmitter Board”](#) on page 20.

Understanding the Calibration Flow

The following references from the IEEE802.3 specification are considered for the crosstalk source calibration process:

- [1] IEEE802.3ba-2010, Annex 86A, Table 86A-1
- [2] IEEE802.3ba-2010, Section 86A.5.3.3
- [3] IEEE802.3, Section 68.6.2

The SFP+ test application performs the following automated steps for executing the **Crosstalk Source Rise Time (20%-80%)** calibration:

- 1 Triggers one cycle of the 8180 waveform on the rising edge.
- 2 Measures the logic 0 and logic 1 voltage levels. The measurement procedure of the logic 0 and logic 1 state is defined as per reference [3]. The average voltage level in the central 20% of each time interval is measured.
- 3 Measures the 20% to 80% rise time using the logic 0 voltage level as base level and logic 1 voltage level as top level of the isolated edges. From reference [2], the optical modulation

amplitude (OMA) test pattern (eight ones, eight zeros) is being used as the normative test pattern. The 0% level and 100% level are the voltage levels of the logic 0 state and logic 1 state respectively as defined by the xMA measurement procedure in the specification.

- 4 Analyzes the signal and verifies that this is as per the conformance limits as specified in reference [1].

Viewing Crosstalk Result

For each test trial, its result is displayed on the **Results** tab. Click the desired test to view its result. Details of the test results are described in the lower pane. A sample reference image based on the measured values is captured by the oscilloscope. You can click the sample reference image to view the details. For information about the test results, refer to **Viewing Results** in the Online help.

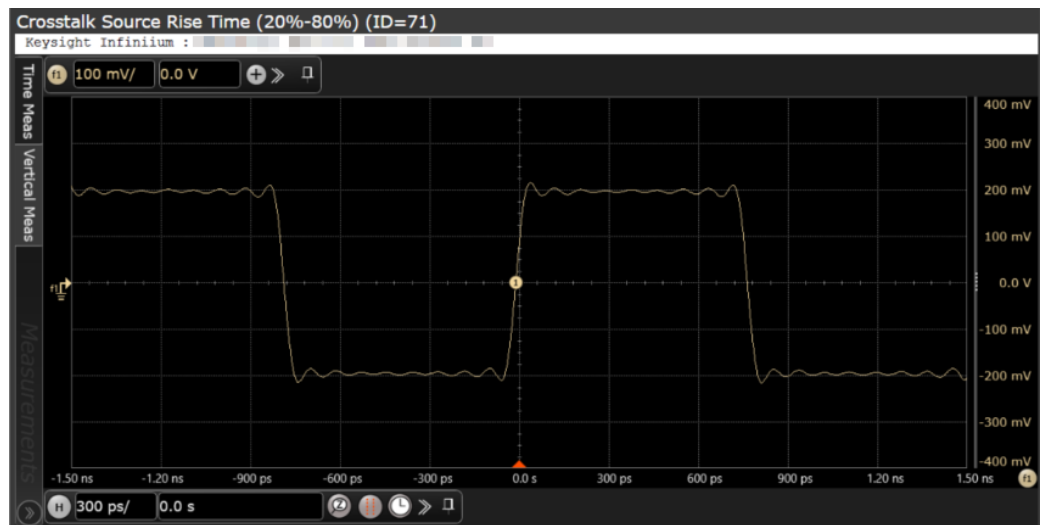

Figure 29 Reference Image for Crosstalk Source Rise Time (20%-80%)

Crosstalk Source Fall Time (80% - 20%) Calibration

The **Crosstalk Source Fall Time** calibration measures the (80%-20%) fall time for the crosstalk source calibration process.

NOTE

For information about the connection diagram, refer to [“Connecting the Host Transmitter Board”](#) on page 20.

Understanding the Calibration Flow

The following references from the IEEE802.3 specification are considered for the crosstalk source calibration process:

- [1] IEEE802.3ba-2010, Annex 86A, Table 86A-1
- [2] IEEE802.3ba-2010, Section 86A.5.3.3
- [3] IEEE802.3, Section 68.6.2

The SFP+ test application performs the following automated steps for executing the **Crosstalk Source Fall Time (80%-20%)** test:

- 1 Triggers one cycle of the 8180 waveform on the rising edge.
- 2 Measures the logic 0 and logic 1 voltage levels. The measurement procedure of the logic 0 and logic 1 state is defined as per reference [3]. The average voltage level in the central 20% of each time interval is measured.
- 3 Measures the 80% to 20% fall time using the logic 0 voltage level as base level and logic 1 voltage level as top level of the isolated edges. From reference [2], the optical modulation amplitude (OMA) test pattern (eight ones, eight zeros) is being used as the normative test pattern. The 0% level and 100% level are the voltage levels of the logic 0 state and logic 1 state respectively as defined by the xMA measurement procedure in the specification.
- 4 Analyzes the signal and verifies that this is as per the conformance limits as specified in reference [1].

Viewing Crosstalk Result

For each test trial, its result is displayed on the **Results** tab. Click the desired test to view its result. Details of the test results are described in the lower pane. A sample reference image based on the measured values is captured by the oscilloscope. You can click the sample reference image to view the details. For information about the test results, refer to **Viewing Results** in the Online help.

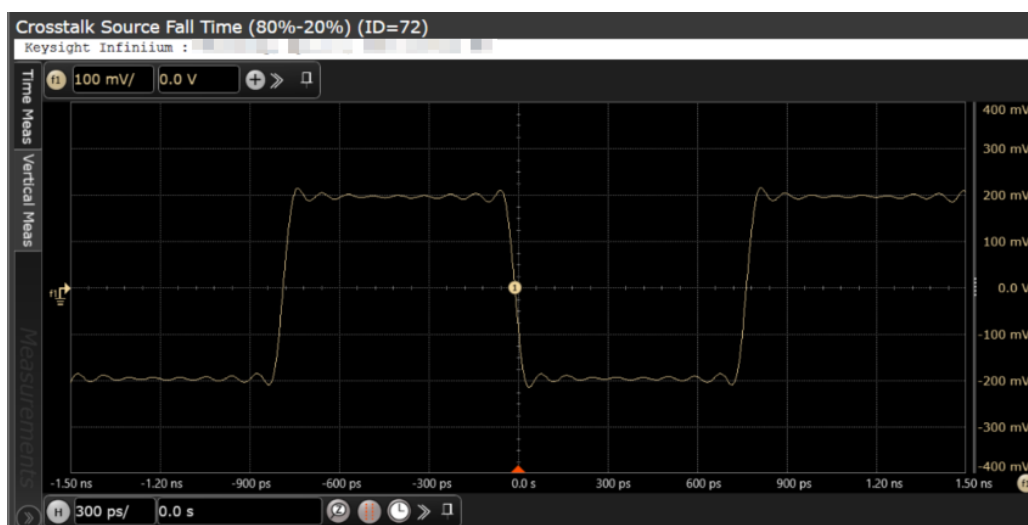

Figure 30 Reference Image for Crosstalk Source Fall Time (80%-20%)

After the crosstalk source calibration is applied to all the input lanes of the XLPPi host, the SFP+ test application executes various tests based on the following test pattern to conform that the test results at the output lane and signals are as per the conformance limits in the specification.

Test Pattern 8180

Test pattern 8180 represents a repeating square wave which consists of eight continuous 1s followed by eight continuous 0s. This test pattern is used to check the XLPPi compliance against the IEEE 802.3 specification for the following tests:

- Output Rise Time (20%-80%) Test/Output Fall Time (80%-20%) Test
- Qsq (V/V) Test

Output Rise Time (20%-80%) Test/Output Fall Time (80%-20%) Test

The **Output Rise Time (20%-80%)**/**Output Fall Time (80%-20%)** test measures the rise and fall time of a XLPP1 host transmitter respectively. The purpose of this test is to verify that the rise or fall time of the XLPP1 host transmitter is within the conformance limits of 28 ps as per the specification.

NOTE

For information about the connection diagram, refer to [“Connecting the Host Transmitter Board”](#) on page 20.

Configuring Test Parameter

To execute the **Output Rise Time (20%-80%)**/**Output Fall Time (80%-20%)** test, you need to configure the **#Averages(16)** parameter. The **#Averages(16)** parameter is used to reduce the effect of noise on the measurement. The value of one average is calculated by averaging multiple acquisitions of the waveform. Sixteen (16) is used as the default value but you can increase or decrease this number to reduce or upsurge the effects of noise and random signal variations.

NOTE

Averaging can be used to reduce measurement noise and increase measurement resolution; however, the specification does not provide any constraints on how much averaging may be used but increase in the value of the **#Averages(16)** parameter leads to diminishing results.

Understanding the Test Flow

The following references from the IEEE-802.3 specification are considered to check the compliance of the DUT:

- [1] IEEE802.3ba-2010, Annex 86A, Table 86A-1
- [2] IEEE802.3ba-2010, Section 86A.5.3.3
- [3] IEEE802.3, Section 68.6.2

The SFP+ test application performs the following automated steps for measuring the **Output Rise Time (20%-80%)**/**Output Fall Time (80%-20%)** test based on the above mentioned references:

- 1 Triggers one cycle of the 8180 waveform on the rising edge.
- 2 Analyzes the rise/fall time of the signal at logic 0 and logic 1 voltage levels. The measurement procedure of the logic 0 and logic 1 state is defined as per reference [3]. The average voltage level in the central 20% of each time interval is measured.
- 3 Measures the 20% to 80% rise time using the logic 0 voltage level as base level and logic 1 voltage level as top level of the isolated edges in case of the **Output Rise Time (20%-80%)** test. Measures the 80% to 20% fall time using the logic 1 voltage level as base level and logic 0 voltage level as top level of the isolated edges in case of the **Output Fall Time (80%-20%)** test. From reference [2], the optical modulation amplitude (OMA) test pattern (eight ones, eight zeros) is being used as the normative test pattern. The 0% level and 100% level are the voltage levels of the logic 0 state and logic 1 state respectively as defined by the xMA measurement procedure in the specification.
- 4 Analyzes the signal and verifies that this is as per the conformance limits as specified in reference [1].

Viewing Test Results

For each test trial, its result is displayed on the **Results** tab. Click the desired test to view its result. Details of the test results are described in the lower pane. A sample reference image based on the measured values is captured by the oscilloscope. You can click the sample reference image to view the details. For information about the test results, refer to **Viewing Results** in the Online help.

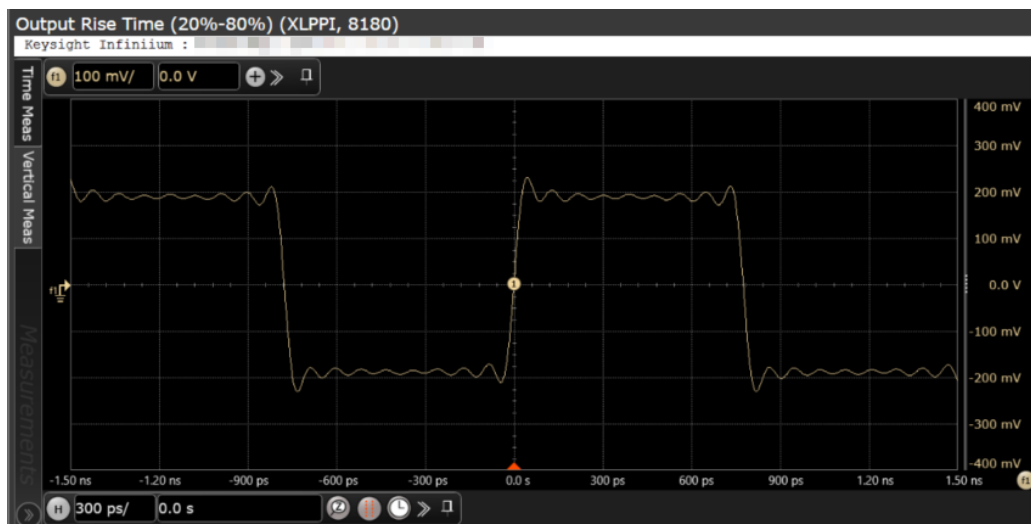

Figure 31 Reference Image for Output Rise Time (20%-80%) Test

Qsq (V/V) Test

The **Qsq (V/V)** test is a measure of reciprocal of signal to noise ratio (SNR) of the XLPP1 host transmitter.

$$Q_{sq} = \frac{1}{SNR}$$

As per IEEE802.3ba-2010, Section 86A.5.3.5, Q_{sq} is calculated using the following formula:

$$Q_{sq} = \frac{(VMA)}{(n1 + n0)}$$

whereby,

- n1 is the RMS noise of logic one
- n2 is the RMS noise of logic zero

The purpose of this test is to verify that the signal to noise ratio of the XLPP1 host transmitter is within the conformance limits of 45.

NOTE

For information about the connection diagram, refer to **“Connecting the Host Transmitter Board”** on page 20.

Configuring Test Parameter

To execute the **Qsq (V/V)** test, you need to configure the **#Waveforms(60)** parameter. The **#Waveforms(60)** parameter is used to reduce the effect of noise on the measurement. Sixty (60) is used as the default value but you can increase or decrease this number to reduce or upsurge the effects of noise and random signal variations.

Understanding the Test Flow

The following references from the IEEE802.3 specifications are considered to check the compliance of the DUT:

[1] IEEE802.3ba-2010, Annex 86A, Table 86A-1

[2] IEEE802.3ba-2010, Section 86A.5.3.5

The SFP+ test application performs the following automated steps for executing the **Qsq (V/V)** test based on the above mentioned references:

- 1 Triggers one cycle of the 8180 waveform on the rising edge.
- 2 Analyzes the rise/fall time of the signal at logic 0 and logic 1 voltage levels.
- 3 Measures the value for VMA using the logic 0 voltage level as base level and logic 1 voltage level. For information on the measurement of VMA, refer to ["Voltage Modulation Amplitude for Cu \(VMA\) \(p-p\) Test"](#) on page 30.
- 4 Measures the root mean square (RMS) noise for the logic 0 and logic 1 levels. From reference [2], the optical modulation amplitude (OMA) test pattern (eight ones, eight zeros) is being used as the normative test pattern. The 0% level and 100% level are the voltage levels of the logic 0 state and logic 1 state respectively as defined by the xMA measurement procedure in the specification.
- 5 Calculates the value of Q_{sq} using the formula mentioned above.
- 6 Analyzes the signal and verify that this is as per the conformance limits of 45 as specified in reference [1].

Viewing Test Results

For each test trial, its result is displayed on the **Results** tab. Click the desired test to view its result. Details of the test results are described in the lower pane. A sample reference image based on the measured values is captured by the oscilloscope. You can click the sample reference image to view the details. For information about the test results, refer to **Viewing Results** in the Online help.

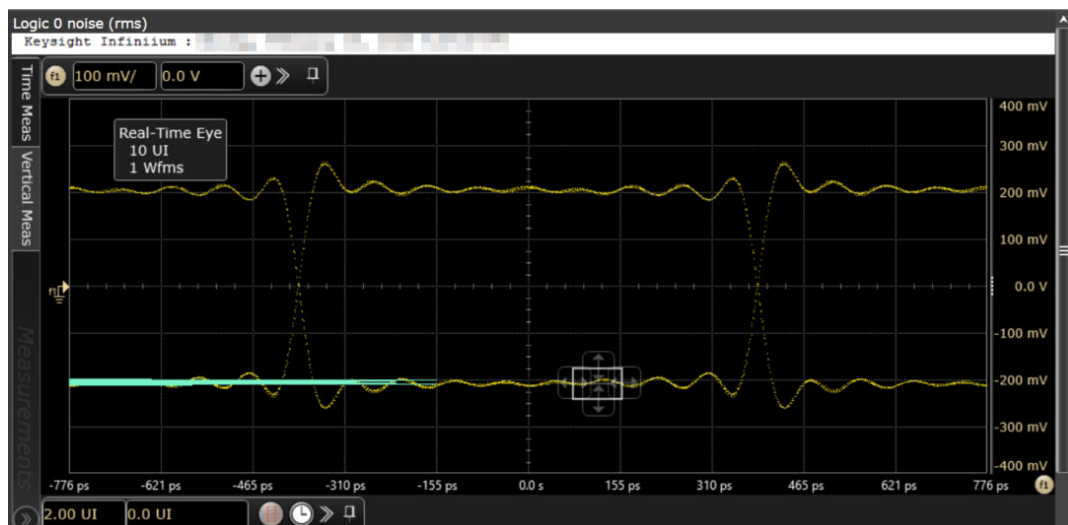

Figure 32 Reference Image for Qsq (V/V) Test for Logic 0

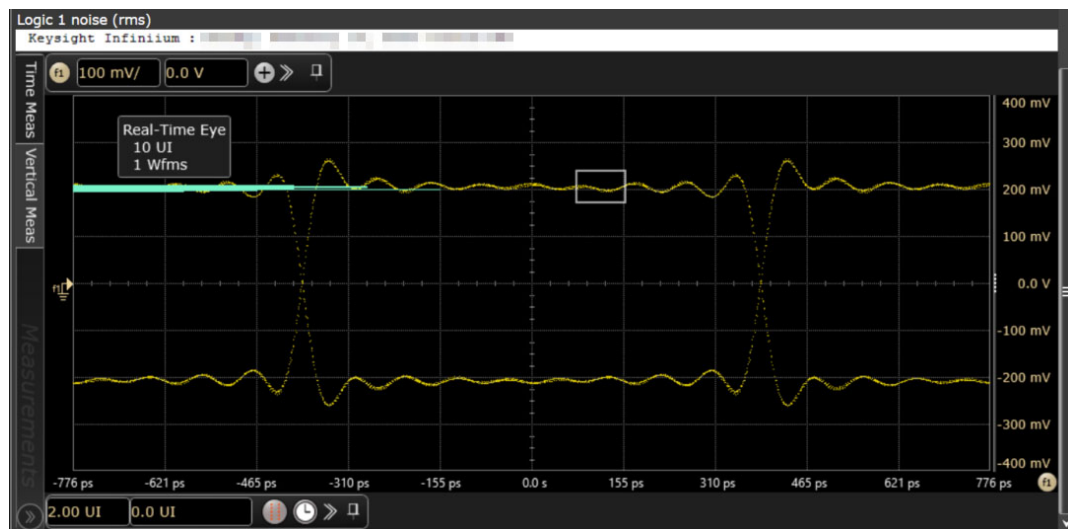

Figure 33 Reference Image for Qsq (V/V) Test for Logic 1

Test Pattern PRBS9

PRBS9 test pattern represents a pseudorandom binary sequence with a repetition period of 2^9-1 . This test pattern is used to measure the jitter for the **Data Dependent Pulse Width Shrinkage (DDPWS) (p-p)** test.

Data Dependent Pulse Width Shrinkage (DDPWS) (p-p) Test

The **Data Dependent Pulse Width Shrinkage (DDPWS) (p-p)** test measures the value of DDPWS from peak-to-peak (p-p) of a XLPP1 host transmitter.

NOTE

For information about the connection diagram, refer to “Connecting the Host Transmitter Board” on page 20.

Understanding the Test Flow

The following references from the SFF-8431 specification are considered to check the compliance of the DUT:

- [1] IEEE802.3ba-2010, Annex 86A, Table 86A-1
- [2] IEEE802.3ba-2010, Section 86A.5.3.5

The SFP+ test application performs the following automated steps for executing the **Data Dependent Pulse Width Shrinkage (DDPWS) (p-p)** test based on the above mentioned references:

- 1 Triggers 1024 cycles of the PRBS9 waveform.
- 2 Turns on EZJIT complete and sets the pattern analysis mode to periodic. As the PRBS9 pattern is relatively short, the DDPWS pattern completes in periodic pattern analysis mode.
- 3 Analyzes the signal and verifies that this is as per the conformance limits of 0.07UI as specified in reference [1]. For a capture with n edges, DDPWS is measured as the difference between one symbol period and the minimum pulse width of the entire capture. It is given by the algorithm:

$$DDPWS = T - \min(t_2 - t_1, t_3 - t_2, \dots, t_{256} - t_{255})$$

whereby, T is the symbol period of the data stream and t_n is the crossing time of edge n.

Viewing Test Results

For each test trial, its result is displayed on the **Results** tab. Click the desired test to view its result. Details of the test results are described in the lower pane. A sample reference image based on the measured values is captured by the oscilloscope. You can click the sample reference image to view the details. For information about the test results, refer to **Viewing Results** in the Online help.

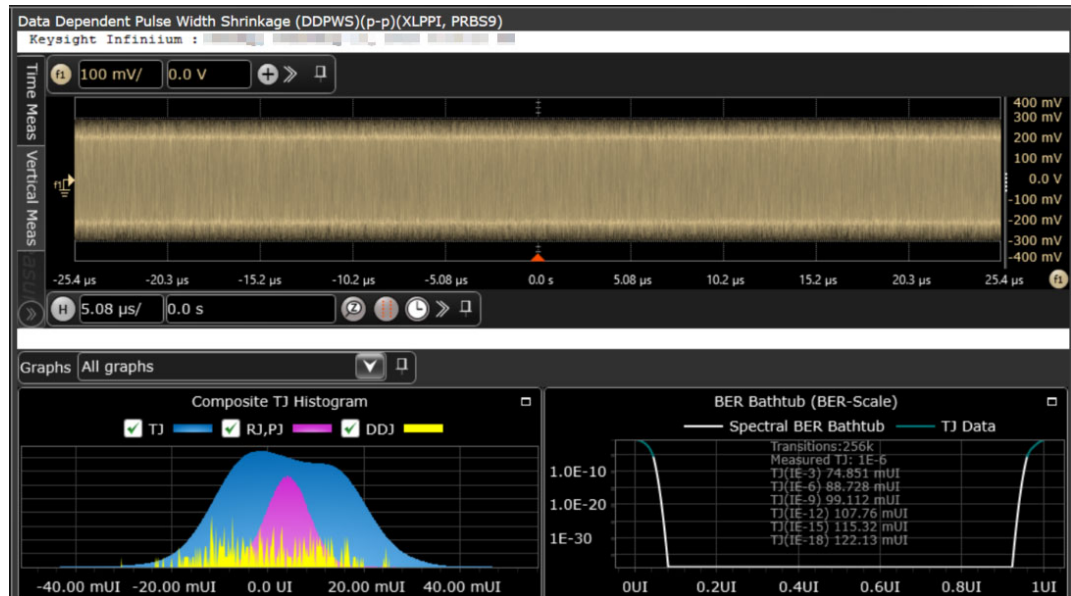

Figure 34 Reference Image for DDPWS (p-p) Test

Test Pattern PRBS31

PRBS31 test pattern represents a pseudorandom binary sequence with a repetition period of $2^{31}-1$. The sequence is defined in IEEE Std 802.3, 49.2.8. This test pattern is used to check the compliance of the XLPPI host transmitter output using the following tests:

- AC Common Mode Output Voltage (rms) Test
- Single Ended Output Voltage (Positive) Test/Single Ended Output Voltage (Negative) Test
- J2 Jitter (p-p) Test
- J9 Jitter (p-p) Test
- Eye Mask Hit Ratio Test

AC Common Mode Output Voltage (rms) Test

The **AC Common Mode Output Voltage (rms)** test measures the output AC common mode voltage of a XLPPI host transmitter.

NOTE

For information about the connection diagram, refer to [“Connecting the Host Transmitter Board”](#) on page 20.

Understanding the Test Flow

The following references from the IEEE802.3 specification are considered to check the compliance of the DUT:

[1] IEEE802.3ba-2010, Annex 86A, Table 86A-1

[2] IEEE802.3ba-2010, Section 86A.5.3.1

The SFP+ test application performs the following automated steps for executing the **AC Common Mode Output Voltage (rms)** test:

- 1 Triggers the PRBS31 waveform.
- 2 Folds the PRBS31 waveform.
- 3 Places a histogram with a width of 1 unit interval across the folded waveform. According to the procedure specified in reference [2], the RMS AC common mode voltage is measured by applying a histogram over one UI of the common mode signal. Multiple unit intervals are overlapped to get an averaged measurement. The scope is set to free run triggering as the oscilloscopes do not have the memory depth for 1 cycle of the PRBS31 waveform. For a compliant XLPPI host transmitter, reference [1] specifies a maximum AC common mode voltage of 15mV, rms.

Viewing Test Results

For each test trial, its result is displayed on the **Results** tab. Click the desired test to view its result. Details of the test results are described in the lower pane. A sample reference image based on the measured values is captured by the oscilloscope. You can click the sample reference image to view the details. For information about the test results, refer to **Viewing Results** in the Online help.

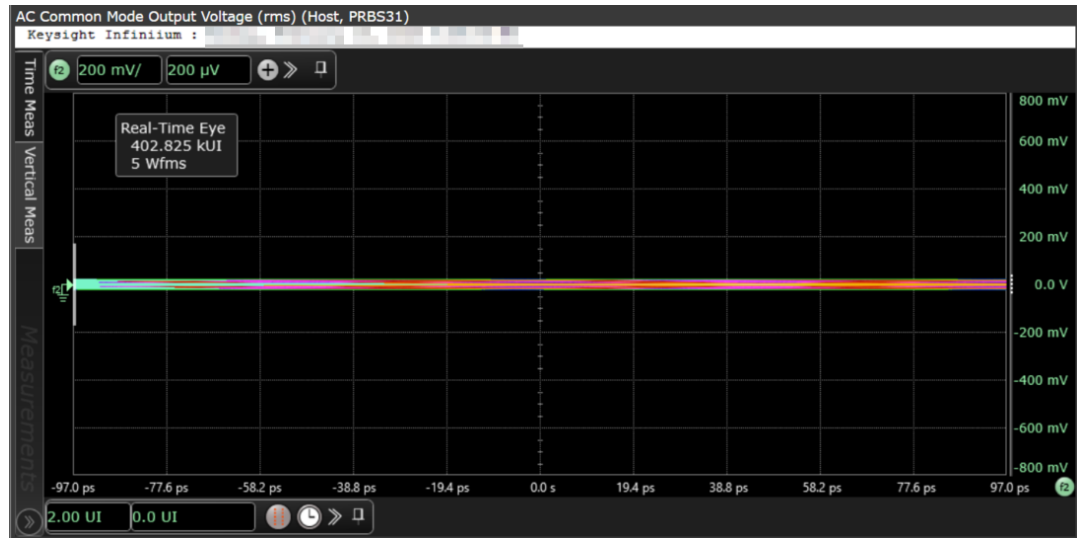

Figure 35 Reference Image for AC Common Mode Output Voltage (rms) Test

Single Ended Output Voltage (Positive) Test/Single Ended Output Voltage (Negative) Test

The **Single Ended Output Voltage (Positive)/Single Ended Output Voltage (Negative)** test measures the voltage range of the positive (TX+) and negative (TX-) signals respectively of a XLPP1 host transmitter.

NOTE

For information about the connection diagram, refer to [“Connecting the Host Transmitter Board”](#) on page 20.

Understanding the Test Flow

The following reference from the IEEE802.3 specification is considered to check the compliance of the DUT:

[1] IEEE802.3ba-2010, Annex 86A, Table 86A-1

The SFP+ test application performs the following automated steps for executing the **Single Ended Output Voltage (Positive)/Single Ended Output Voltage (Negative)** test based on the above mentioned reference:

- 1 Triggers the PRBS31 waveform.
- 2 Measures the peak-to-peak (p-p) voltage. For a compliant XLPP1 host transmitter, reference [1] specifies the single ended voltage range to be between -0.3V and 4.0V.

Viewing Test Results

For each test trial, its result is displayed on the **Results** tab. Click the desired test to view its result. Details of the test results are described in the lower pane. A sample reference image based on the measured values is captured by the oscilloscope. You can click the sample reference image to view the details. For information about the test results, refer to **Viewing Results** in the Online help.

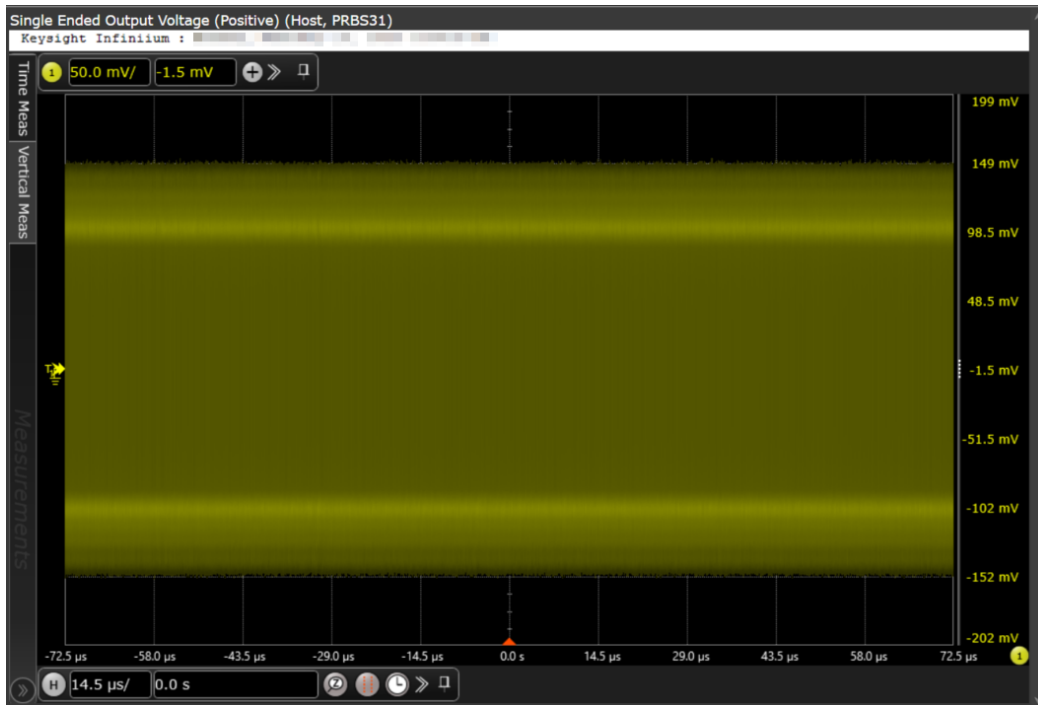

Figure 36 Reference Image for Single Ended Output Voltage (Positive) Test

J2 Jitter (p-p) Test

The **J2 Jitter (p-p)** test measures the J2 jitter of a XLPPI host transmitter and is defined as the time interval that includes all but 10^{-2} of the jitter distribution, which is the time interval from the 0.5th to the 99.5th percentile of the jitter histogram.

NOTE

For information about the connection diagram, refer to [“Connecting the Host Transmitter Board”](#) on page 20.

Understanding the Test Flow

The following reference from the IEEE802.3 specification is considered to check the compliance of the DUT:

[1] IEEE802.3ba-2010, Annex 86A, Table 86A-1

The SFP+ test application performs the following automated steps for executing the **J2 Jitter (p-p)** test based on the above mentioned reference:

- 1 Triggers the PRBS31 waveform.
- 2 Turns on EZJIT Complete, and set the pattern analysis mode to **Arbitrary** as the signal is relatively long.
- 3 Obtains the results for J2 for a compliant XLPPI host transmitter. Reference [1] specifies a maximum J2 of 0.17UI, peak-to-peak.

NOTE

The clock recovery method used is a second order PLL with a loop bandwidth of 4MHz and a slope of -20dB/decade with a peaking of 0.1dB.

Viewing Test Results

For each test trial, its result is displayed on the **Results** tab. Click the desired test to view its result. Details of the test results are described in the lower pane. A sample reference image based on the measured values is captured by the oscilloscope. You can click the sample reference image to view the details. For information about the test results, refer to **Viewing Results** in the Online help.

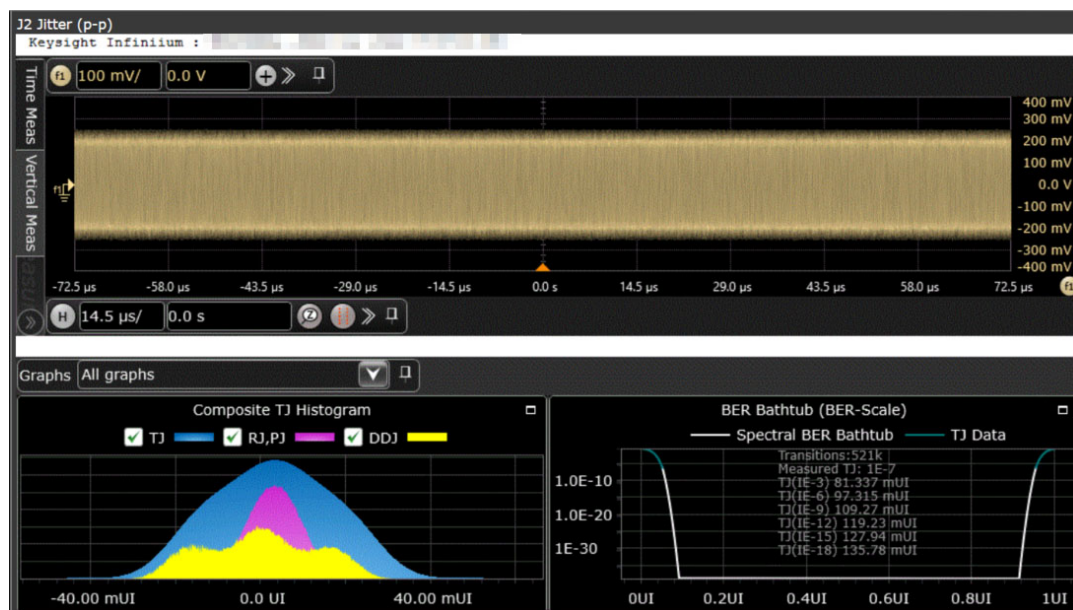

Figure 37 Reference Image for J2 Jitter (p-p) Test

J9 Jitter (p-p) Test

The **J9 Jitter (p-p)** test measures the J9 jitter of a XLPP1 host transmitter and is defined as the time interval that includes all but 10^{-9} of the jitter distribution.

NOTE

For information about the connection diagram, refer to ["Connecting the Host Transmitter Board"](#) on page 20.

Understanding the Test Flow

The following reference from the IEEE802.3 specification is considered to check the compliance of the DUT:

[1] IEEE802.3ba-2010, Annex 86A, Table 86A-1

The SFP+ test application performs the following automated steps for executing the **J9 Jitter (p-p)** test based on the above mentioned reference:

- 1 Triggers the PRBS31 waveform.
- 2 Turns on EZJIT Complete, and set the pattern analysis mode to **Arbitrary** as the signal is relatively long.
- 3 Obtains the results for J9 for a compliant XLPP1 host transmitter. Reference [1] specifies a maximum J9 of 0.29UI, peak-to-peak.

NOTE

The clock recovery method used is a second order PLL with a loop bandwidth of 4MHz and a slope of -20dB/decade with a peaking of 0.1dB.

Viewing Test Results

For each test trial, its result is displayed on the **Results** tab. Click the desired test to view its result. Details of the test results are described in the lower pane. A sample reference image based on the measured values is captured by the oscilloscope. You can click the sample reference image to view the details. For information about the test results, refer to **Viewing Results** in the Online help.

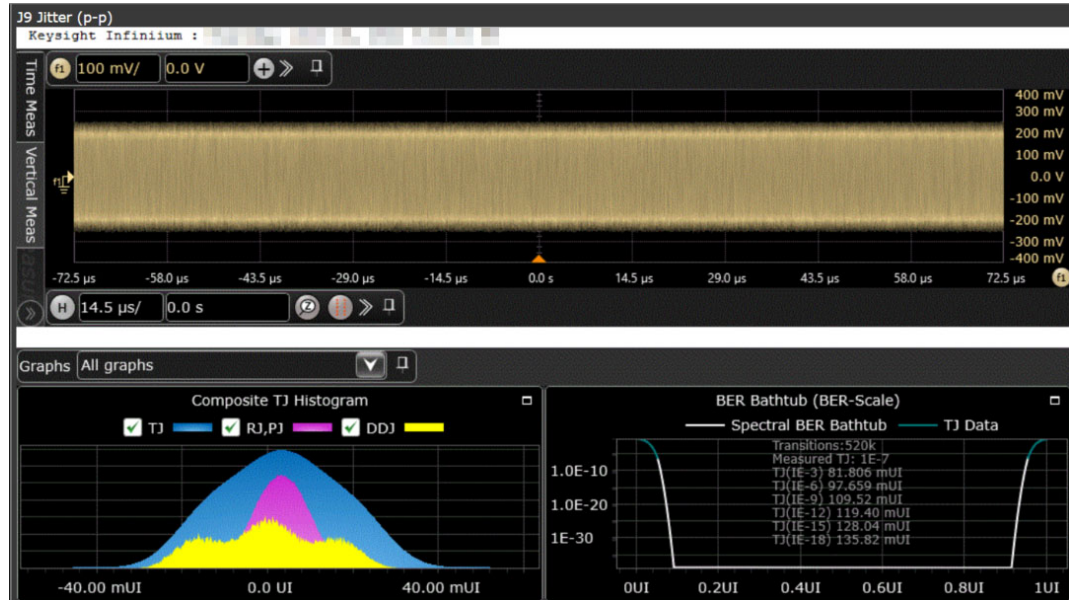

Figure 38 Reference Image for J9 Jitter (p-p) Test

Eye Mask Hit Ratio Test

The **Eye Mask Hit Ratio** test measures the mask hit ratio of XLPPI host transmitter. The eye mask is defined by the parameters X1, X2, Y1, and Y2. The eye is defined as measured using a receiver with an electrical -3dB bandwidth of 12GHz such as Bessel-Thomson response. As per the relevant standard, the mask hit ratio is set to 5×10^{-5} .

NOTE

For information about the connection diagram, refer to **“Connecting the Host Transmitter Board”** on page 20.

Understanding the Test Flow

The following reference from the IEEE802.3 specification is considered to check the compliance of the DUT:

[1] IEEE802.3ba-2010, Annex 86A, Table 86A-1

The SFP+ test application performs the following automated steps for executing the **Eye Mask Hit Ratio** test:

- 1 Enables the **Mask Test** and loads the test. Enabling the **Mask Test** allows you to conform the waveform as per the industry standards.
- 2 Triggers the PRBS31 waveform for the **Mask Test**.
- 3 Calculates the mask hit ratio. For a compliant XLPPI host transmitter, reference [1] specifies an Eye Mask Hit Ratio that is less than 5×10^{-15} .

The eye mask hit ratio is calculated using the formula:

$$\text{Hit Ratio} = \frac{\text{Total Mask Violations}}{\text{Total Number of Samples in 1UI}}$$

And the total number of samples in 1UI is given by:

$$\text{Total Number of Samples in 1 UI} = \text{Sampling Rate} \times 1UI$$

NOTE

The clock recovery method used is a second order PLL with a loop bandwidth of 4MHz and a slope of -20dB/decade with a peaking of 0.1dB.

Viewing Test Results

For each test trial, its result is displayed on the **Results** tab. Click the desired test to view its result. Details of the test results are described in the lower pane. A sample reference image based on the measured values is captured by the oscilloscope. You can click the sample reference image to view the details. For information about the test results, refer to **Viewing Results** in the Online help.

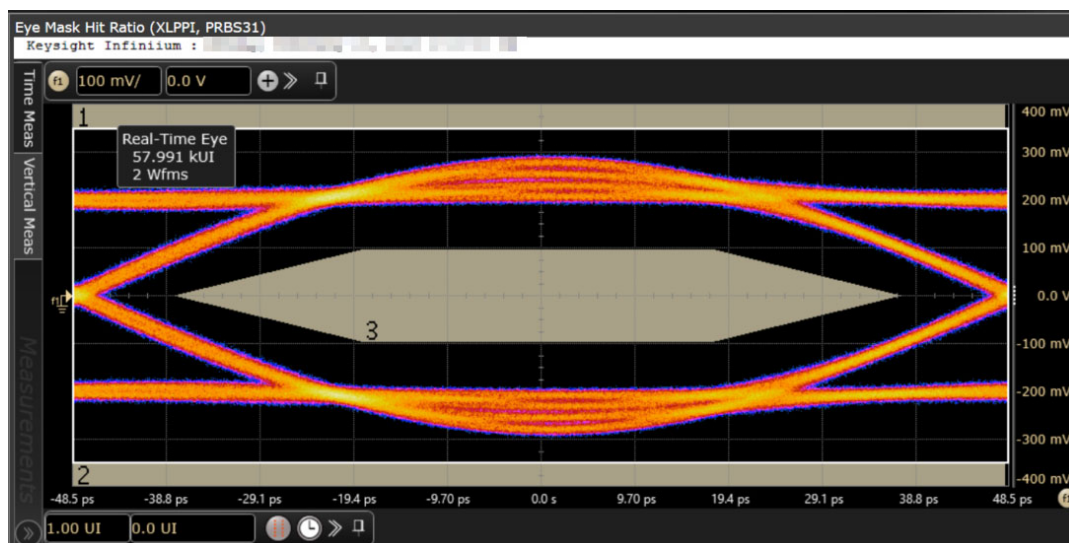

Figure 39 Reference Image for Eye Mask Hit Ratio Test

5 Calibrating the Infiniium Oscilloscope and Probe

Required Equipment for Calibration / 66
Internal or Self Calibration / 67
Probe Calibration and De-skew / 72

This section describes the calibration procedures for Keysight Infiniium Oscilloscopes other than the UXR-series oscilloscopes. For the calibration information related to the UXR-series oscilloscopes, refer to *Keysight Infiniium UXR Real-Time Oscilloscopes User's Guide*.

Additionally, probe calibration and de-skew steps have been described in this section. To get more information, you can refer to the respective probes documentation.

Required Equipment for Calibration

To calibrate the Infiniium oscilloscope in preparation for running the SFP+ automated tests, you need the following equipment:

- Keyboard, qty = 1, (provided with the Keysight Infiniium oscilloscope).
- Mouse, qty = 1, (provided with the Keysight Infiniium oscilloscope).
- Precision 3.5 mm BNC to SMA male adapter, Keysight p/n 54855-67604, qty = 2, (provided with the Keysight Infiniium oscilloscope).
- Calibration cable (provided with the 54850A series, 80000 and 90000A series Infiniium oscilloscopes). Use a good quality 50 Ω BNC cable.
- BNC shorting cap (provided with the Keysight Infiniium oscilloscope).

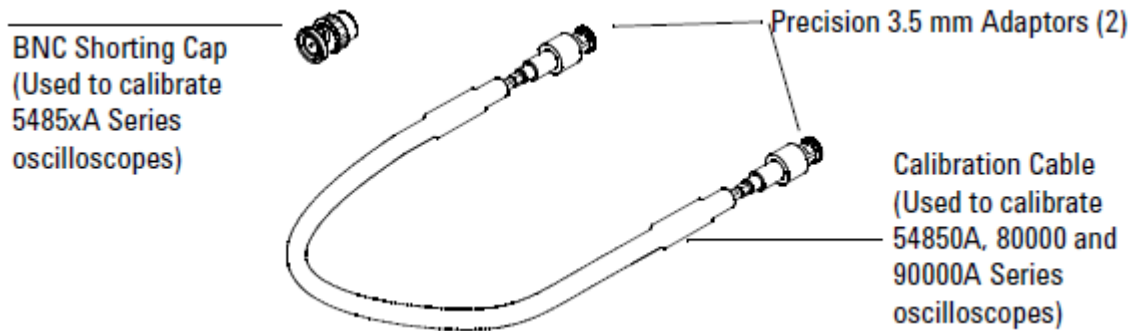

Figure 40 Accessories provided with the Keysight Infiniium Oscilloscope

Internal or Self Calibration

NOTE

Calibration time: It takes approximately 1 hour to run the self calibration on the Oscilloscope, including the time required to change cables from Channel to Channel.

The self calibration uses signals generated in the Oscilloscope to calibrate Channel sensitivity, offsets, and trigger parameters. You should run the self calibration

- yearly or according to your periodic needs,
- when you replace the acquisition assembly or acquisition hybrids,
- when you replace the hard drive or any other assembly,
- when the oscilloscope's operating temperature (after the 30 minute warm-up period) is more than ± 5 °C different from that of the last calibration.

For the internal or self calibration:

- 1 Let the Oscilloscope warm up before running the Self Calibration.
Perform self calibration only after the oscilloscope has run for 30 minutes at ambient temperature with the cover installed. Calibration of an Oscilloscope that has not warmed up may result in an inaccurate calibration.
- 2 From the Infiniium Oscilloscope's main menu, click **Utilities>Calibration...**

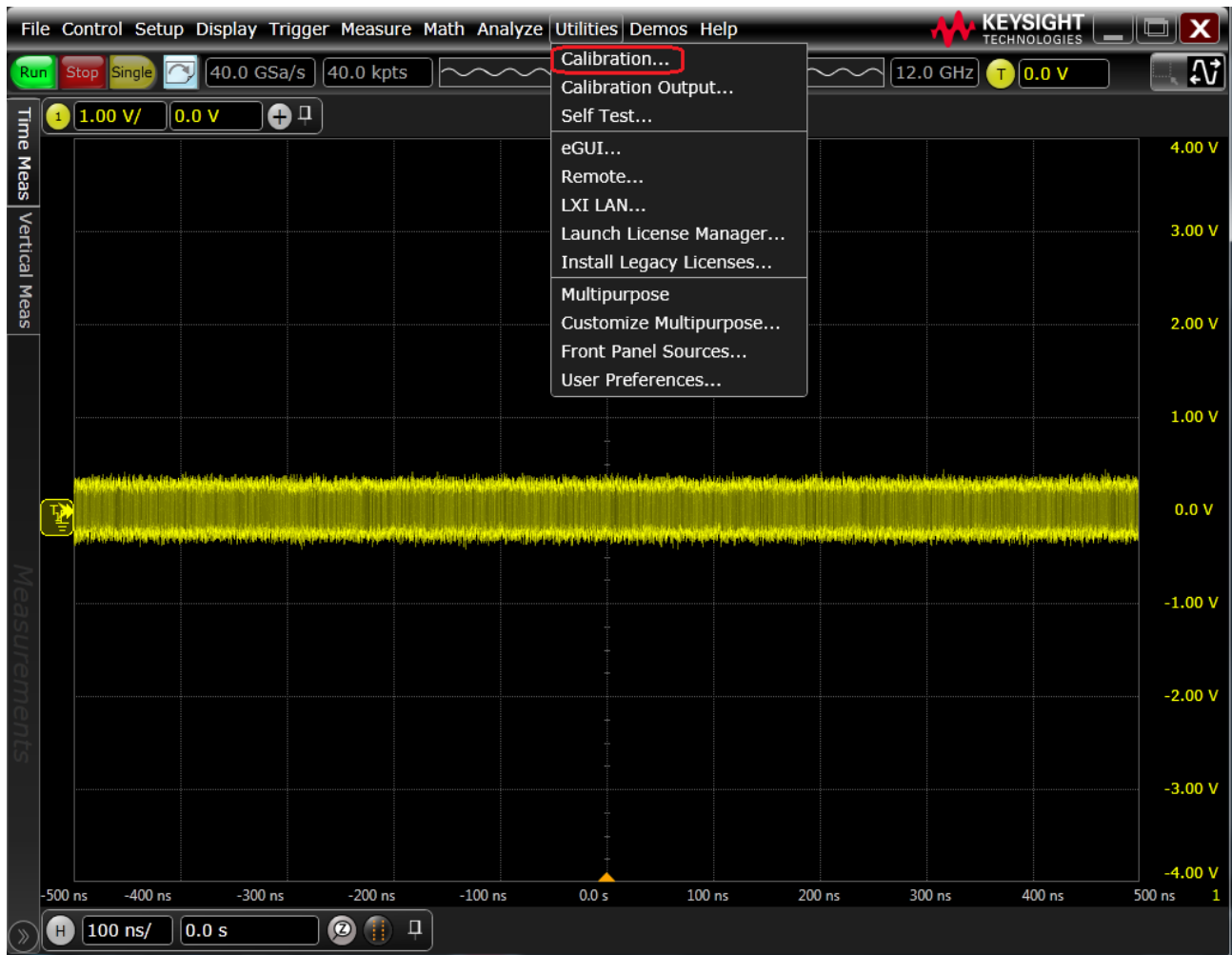

Figure 41 Accessing Calibration dialog on the Oscilloscope

The **Calibration** dialog appears.

- 3 To start the calibration process:
 - a Clear the **Cal Memory Protect** checkbox.
 You cannot run self calibration if this box is checked. See [Figure 42](#).



Figure 42 Clearing **Cal Memory Protect** and Starting Calibration

- b Click **Start** to begin calibration.
- c Follow the on-screen instructions.

- d During the calibration of any Oscilloscope Channel, if the oscilloscope prompts you to perform a Time Scale Calibration, select **Standard Cal and Default Time Scale** in the **Calibration Options** dialog.

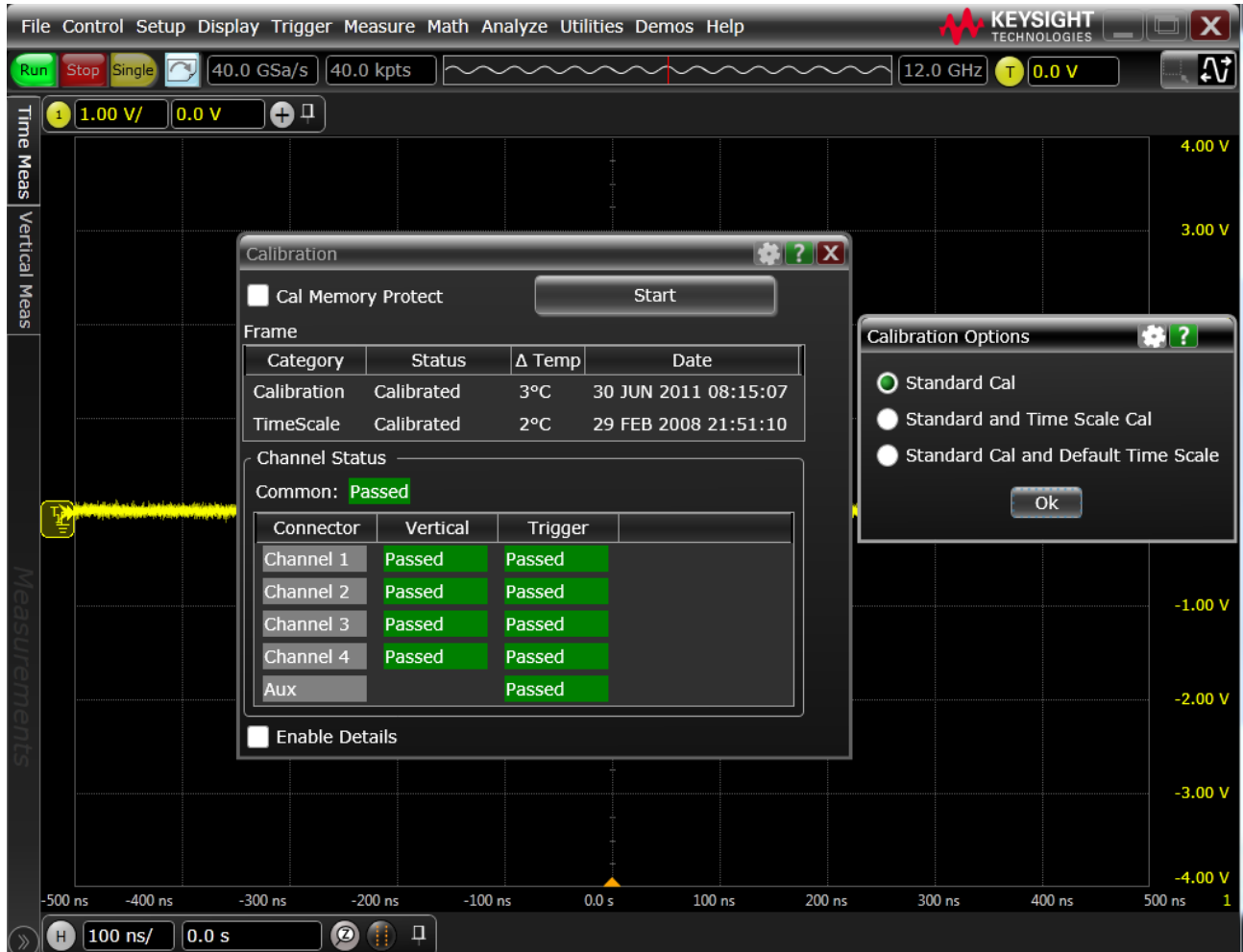

Figure 43 Selecting options from the **Calibration Options** dialog

The options under the **Calibration Options** dialog are:

- **Standard Calibration**—Oscilloscope does not perform time scale calibration and uses calibration factors from the previous time scale calibration and the reference signal is not required. The rest of the calibration procedure continues.
- **Standard and Time Scale Cal**—Oscilloscope performs time scale calibration. You must connect a reference signal to the Oscilloscope Channel, after ensuring that the reference signal meets the following specifications. Failure to meet these specifications result in an inaccurate calibration.

- **Standard Cal and Default Time Scale**—Oscilloscope uses the default time scale calibration factors and does not require the 10 MHz reference signal. The rest of the calibration procedure continues.
- e* Disconnect everything from all inputs and AUX Out.
- f* Connect the calibration cable from AUX Out to a specific Channel.
- g* Connect the calibration cable from AUX Out to each of the Channel inputs as requested.
- h* Connect the 50 Ω BNC cable from the AUX Out to the AUX Trig on the front panel of the Oscilloscope.
- i* A Passed/Failed indication is displayed for each calibration section. If any section fails, check the calibration cables and run the Oscilloscope **Self Test...** in the **Utilities...** menu.
- j* After the calibration procedure is completed, click **Close**.

Probe Calibration and De-skew

Along with calibrating the Infiniium Oscilloscope, it is a good practice to calibrate and de-skew the probes, before you start running the automated tests.

Differential SMA Probe Head Attenuation/Offset Calibration

Perform the following steps

- 1 Connect a shorting cap to the center SMA connector of the Differential SMA Probe Head.
- 2 Connect the BNC connector of the SMA to BNC adapter to AUX Out on the front panel of the Infiniium Oscilloscope.
- 3 Using the Differential SMA Probe Head, connect the Oscilloscope's AUX Out to the positive (+) side of InfiniiMax Probe Amplifier. Keep the negative (-) side of the InfiniiMax Probe Amplifier open.
- 4 On the Infiniium Oscilloscope,
 - a Click **Setup>Channel 1...**

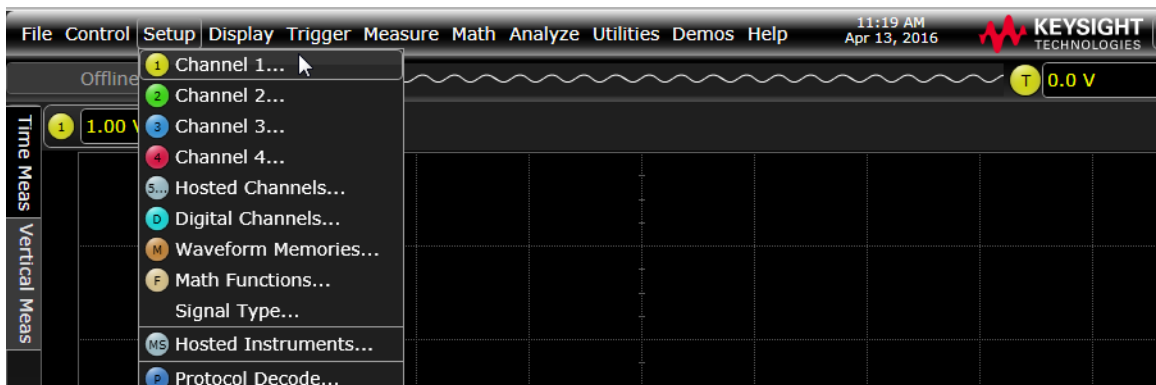

b The **Channel** dialog displays to set up Channel 1 of the Oscilloscope.



c Click **Probe...**. The **Probe Configuration** dialog displays.



- d In the **Probe Head** block, click the **Select Head...** button.
- e Select **N5380A/B** from the list.
- f In the **Calibration Status** area, click the **Cal...** button corresponding to **Atten/Offset**.

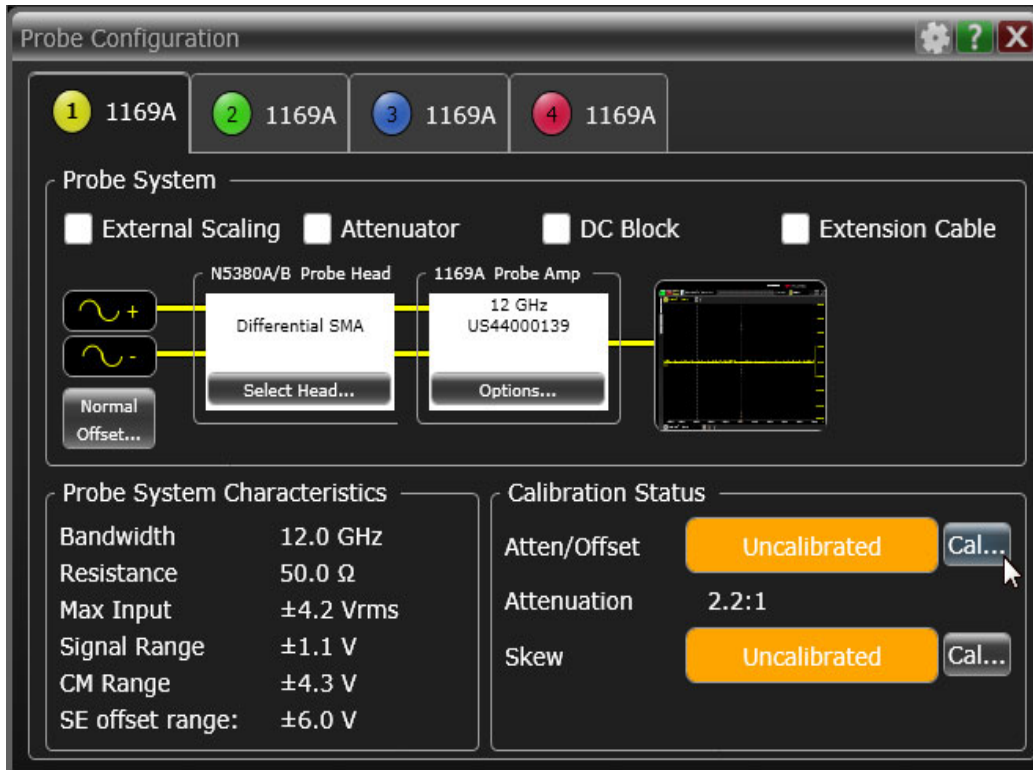

- g The **Probe Calibration** dialog displays. Click **Start Atten/Offset Cal...**



- h* The Calibration wizard displays. Follow the on-screen instructions. At the end of the Atten/Offset Calibration, perform the Skew Calibration for the Differential SMA Probe Head.

Differential SMA Probe Head Skew Calibration

This procedure ensures that the timing skew errors between channels are minimized. After the Atten/Offset Calibration is done, perform the following steps for skew calibration:

- 1 On the **Probe Calibration** dialog, click **Start Skew Cal...**

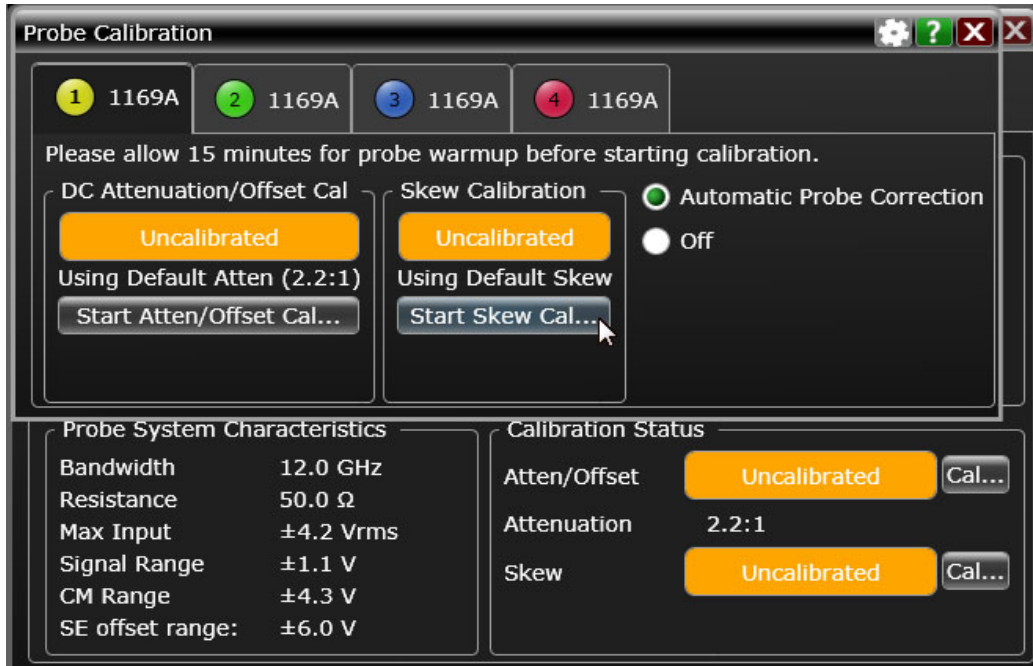

- 2 The Calibration wizard displays. Follow the on-screen instructions.

Differential Socketed Probe Head Atten/Offset Calibration

Perform the following steps

- 1 Ensure that an InfiniiMax Probe Amplifier, attached to a Differential Socketed Probe Head is connected to Channel 1 of the Oscilloscope.
- 2 Install the 80 Ω resistors into the Differential Socketed Probe Head. These resistors are required only for probe calibration and de-skew.
- 3 Connect the De-Skew fixture to AUX Out on the front panel of the Infiniium Oscilloscope.
- 4 Clip the resistors on the De-Skew fixture.

- 5 On the Infiniium Oscilloscope,
 - a Click **Setup>Channel 1....**

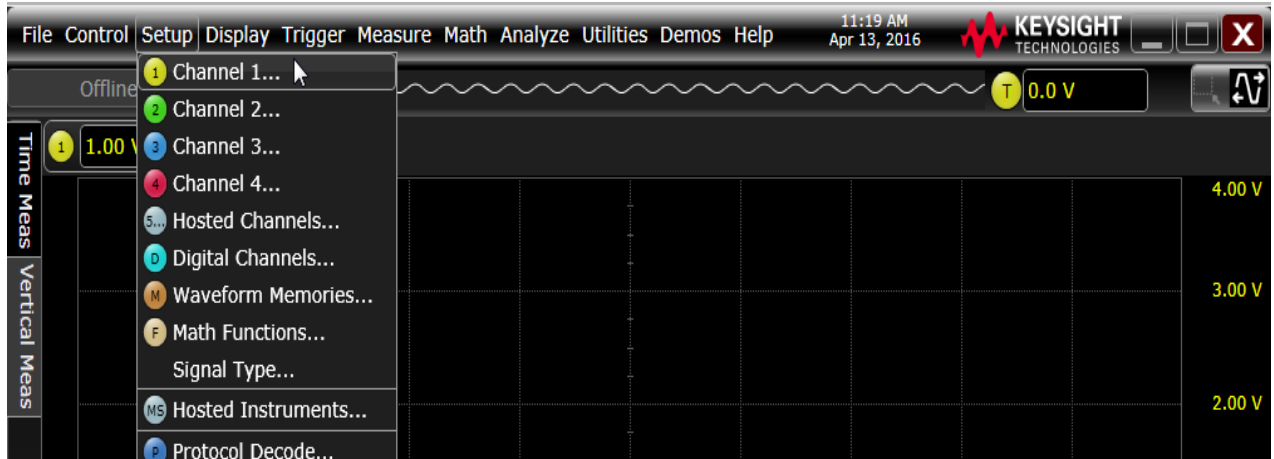

- b The **Channel** dialog displays to set up Channel 1 of the Oscilloscope.



c Click **Probe...**. The **Probe Configuration** dialog displays.

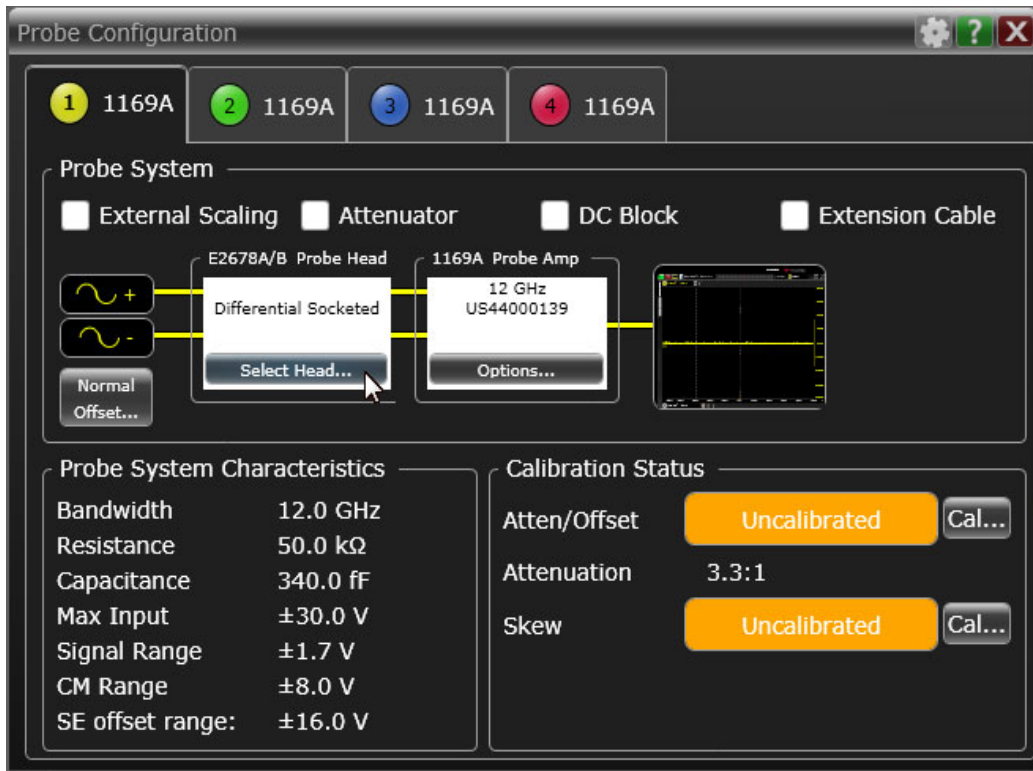

d In the **Probe Head** block, click the **Select Head...** button.

e Select **E2678A/B** from the list.

f In the **Calibration Status** area, click the **Cal...** button corresponding to **Atten/Offset**.

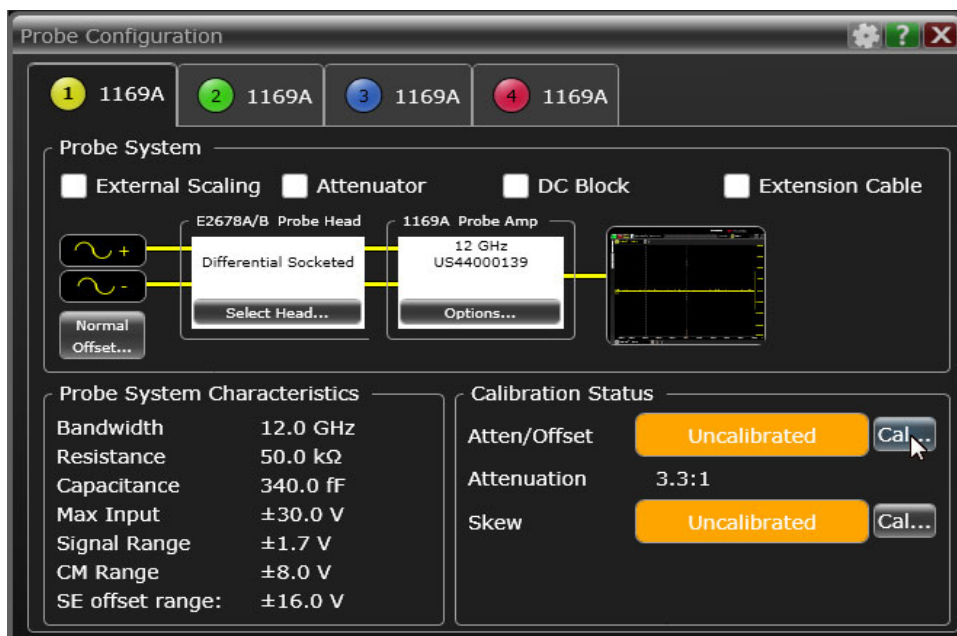

g The **Probe Calibration** dialog displays. Click **Start Atten/Offset Cal...**

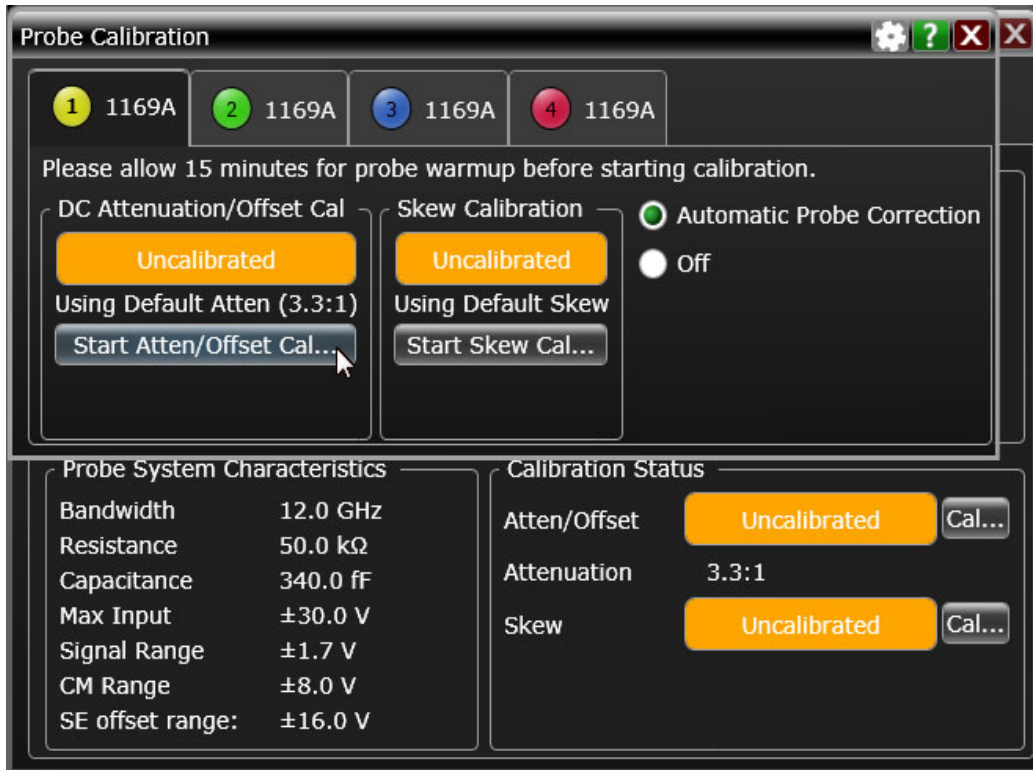

h The Calibration wizard displays. Follow the on-screen instructions. At the end of the Atten/Offset Calibration, perform the Skew Calibration for the Differential Socketed Probe Head.

Differential Socketed Probe Head Skew Calibration

This procedure ensures that the timing skew errors between channels are minimized. After the Atten/Offset Calibration is done, perform the following steps for skew calibration:

- 1 On the **Probe Calibration** dialog, click **Start Skew Cal...**

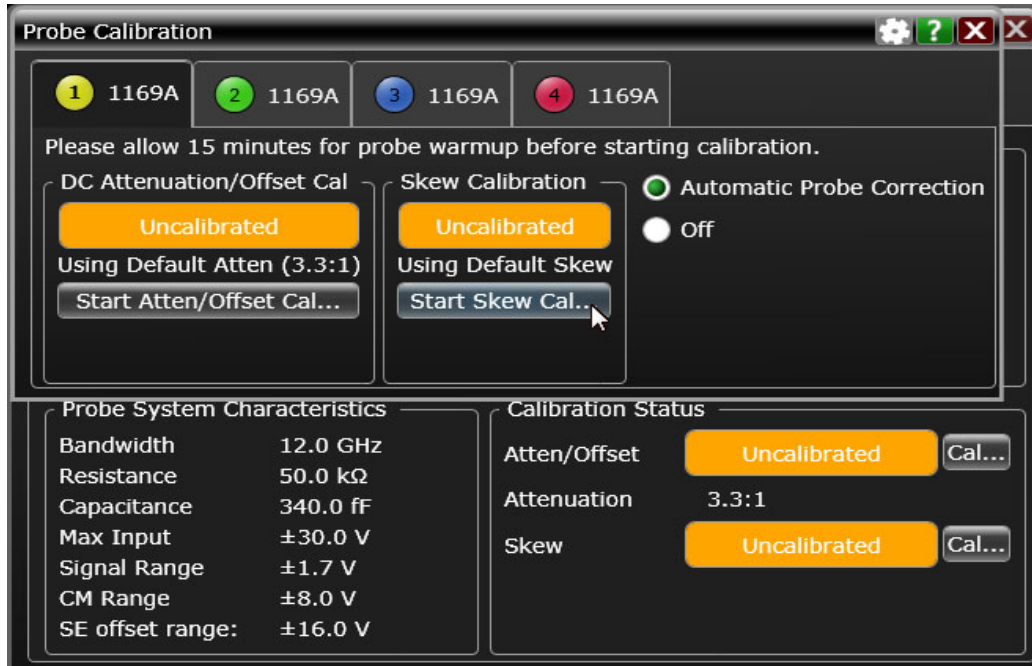

- 2 The Calibration wizard displays. Follow the on-screen instructions.

For more information on connecting probes to the Infiniium Oscilloscope, refer to the De-skew and Calibration manual. This manual comes together with the E2655A/B/C Probe De-skew and Performance Verification Kit.

NOTE

Each probe is calibrated to the Oscilloscope Channel to which it is connected. Do not switch probes between Channels or other Oscilloscopes, else it becomes necessary to calibrate them again. One of the best practices is to label the probes with the Channel number on which they are calibrated.

Index

Symbols

#Averages(16), 26, 52
#Hits(100), 35
#Waveforms(60), 29, 54

Numerics

40Gb/s parallel physical interface, 47

B

blocking capacitors, 18
BNC to SMA converter, 18

C

calibrating the oscilloscope, 65
calibration cable, 66
clock recovery method, 46

D

DDJ, 33
DDPWS, 34

E

enhanced small form factor
pluggable, 26
EZJIT, 33

H

host compliance board, 20, 42
HTML report, 22

I

in this book, 4
InfiniiSim, 23
internal calibration, 67

K

Keysight Web site, 10

L

license key, installing, 11

M

mask test, 46

O

optical modulation amplitude, 27

P

parameters, eye mask, 45
physical medium dependent, 47
PRBS9, 32, 55
precision probe/cable, 23

R

relative noise, 28
required equipment for calibration, 66
required fixtures and accessories, 16
rms technique, 28

S

SFI, 26
SFP+ compliance test application, 7
SMA cable, 20, 42
SMA to SMA converter, 18
standard reference, 7
switch matrix, 23

T

task flow, 22
threshold-crossing time, 32

V

voltage modulation amplitude, 28

W

waveform distortion penalty, 37

X

xMA, 27

