

Printed Version of
VNA Help File
Supports A.13.70.xx

Keysight VNA Series Network Analyzers

Documentation Warranty

THE MATERIAL CONTAINED IN THIS DOCUMENT IS PROVIDED "AS IS," AND IS SUBJECT TO BEING CHANGED, WITHOUT NOTICE, IN FUTURE EDITIONS. FURTHER, TO THE MAXIMUM EXTENT PERMITTED BY APPLICABLE LAW, KEYSIGHT DISCLAIMS ALL WARRANTIES, EITHER EXPRESS OR IMPLIED WITH REGARD TO THIS MANUAL AND ANY INFORMATION CONTAINED HEREIN, INCLUDING BUT NOT LIMITED TO THE IMPLIED WARRANTIES OF MERCHANTABILITY AND FITNESS FOR A PARTICULAR PURPOSE. KEYSIGHT SHALL NOT BE LIABLE FOR ERRORS OR FOR INCIDENTAL OR CONSEQUENTIAL DAMAGES IN CONNECTION WITH THE FURNISHING, USE, OR PERFORMANCE OF THIS DOCUMENT OR ANY INFORMATION CONTAINED HEREIN. SHOULD KEYSIGHT AND THE USER HAVE A SEPARATE WRITTEN AGREEMENT WITH WARRANTY TERMS COVERING THE MATERIAL IN THIS DOCUMENT THAT CONFLICT WITH THESE TERMS, THE WARRANTY TERMS IN THE SEPARATE AGREEMENT WILL CONTROL.

U.S. Government Rights

U.S. Government Rights. The Software is "commercial computer software," as defined by Federal Acquisition Regulation ("FAR") 2.101. Pursuant to FAR 12.212 and 27.405-3 and Department of Defense FAR Supplement ("DFARS") 227.7202, the U.S. government acquires commercial computer software under the same terms by which the software is customarily provided to the public. Accordingly, Keysight provides the Software to U.S. government customers under its standard commercial license, which is embodied in its End User License Agreement (EULA), a copy of which can be found at <http://www.keysight.com/find/sweula>. The license set forth in the EULA represents the exclusive authority by which the U.S. government may use, modify, distribute, or disclose the Software. The EULA and the license set forth therein, does not require or permit, among other things, that Keysight: (1) Furnish technical information related to commercial computer software or commercial computer software documentation that is not customarily provided to the public; or (2) Relinquish to, or otherwise provide, the government rights in excess of these rights customarily provided to the public to use, modify, reproduce, release, perform, display, or disclose commercial computer software or commercial computer software documentation. No additional government requirements beyond those set forth in the EULA shall apply, except to the extent that those terms, rights, or licenses are explicitly required from all providers of commercial computer software pursuant to the FAR and the DFARS and are set forth specifically in writing elsewhere in the EULA. Keysight shall be under no obligation to update, revise or otherwise modify the Software. With respect to any technical data as defined by FAR 2.101, pursuant to FAR 12.211 and 27.404.2 and DFARS 227.7102, the U.S. government acquires no greater than Limited Rights as defined in FAR 27.401 or DFAR 227.7103-5 (c), as applicable in any technical data.

TABLE OF CONTENTS

Home	16
PXIWhatsNew	17
Administrative Tasks	
Windows File Locations	20
Quick Start	
Multiport and Multisite Configuration	21
Connector Care	29
Programming the PXIe/USB VNAs	40
Configuration Wizard	43
SFP Launcher	48
PXIe VNA Front Panel Tour	54
USB VNA Front Panel	57
M9341 IO Module Front Panel	61
Screen Display Tour	63
USB VNA Rear Panel	67
Traces, Channels, Windows, and Sheets	69
QuickStart Dialog	93
Basic Measurement Sequence	100
Frequency Blanking	101
Connectivity Guide	104
Preferences	105
Dialog Transparency	114
Keyboard Shortcuts	116
Using Help	118
Help About	127
1. Set Up a Measurement	
Preset the VNA	129
Measurement Classes	131
Measurement Parameters	134
Frequency Range	146
Power Level	150
Receiver Leveling	157
Sweep Settings	165
Trigger Setup	178

External Triggering	183
Trigger Model Animation	192
Data Format	193
Scale	200
Receiver Gain	207
Customize Your Analyzer Screen	210
Copy Channels	232
DC Control	235
ADC Measurements	240
Undo/Redo	243
2. Optimize a Measurement	246
Dynamic Range	248
Number of Data Points	250
Phase Accuracy	252
Electrically Long Devices	256
Reflection Accuracy	258
Measurement Stability	261
Noise Reduction Techniques	263
Crosstalk	269
Effects of Accessories	270
Speed up PXIe Measurements	271
Fastest Sweep	272
Multiple State Measurements	274
Fastest Data Transfer	278
Shift LO	279
Using Macros	281
3. Calibrate a Measurement	
System Power Calibration	285
Select a Calibration	289
Calibration Thru Methods	293
Calibration Wizard	299
Guided Power Calibration	316
Calibrate All Channels	322
Using Cal Sets	334
Error Correction and Interpolation	345
ECal	
Using ECal	351
ECal User Characterization	361

Perform a 4-Port Cal with a 2-Port ECal Module	377
TRL Calibration	379
CalPod	384
Calibration Preferences	393
Cal Plane Manager	396
Port Subset Correction (Devolve Calibration)	412
Power Calibration	415
Fixture Compensation	437
Auto Fixture Removal	453
Port Extensions	463
Swap Adapters and Offset Delay Method	472
Concepts	
Calibration Overview	476
Measurement Errors	479
Accurate Calibrations	493
Calibration Thru Methods	293
Validity of a Cal	497
Calibration Standards	503
Modify Cal Kits	508
Why Modify a Cal Kit	513
Creating Custom Calibration Kits using a New Connector Family	514
How to Create a New Cal Kit from an Existing Cal Kit	516
VNA Cal Kit File Types	517
Connectors Tab	519
Standards Tab	522
SOLT Tab	531
TRL Tab	534
4. Analyze Data	
Locate Data Using Markers	538
Math & Memory Operations	574
8510 Mode	580
Equation Editor	582
Equation Editor Import Functions	598
External DC Meter Data Conversion	607
Parameter Conversion	611
Use Limits to Test Devices	614
Use Ripple Limit Test	624
Use Bandwidth Limit Test	631

5. Output Data	
Save and Recall Data	634
Print	656
Programming	662
SCPI	
Commands	
SCPI Command Tree	664
Common Commands	669
Abort	673
Automatic Fixture Removal (AFR)	674
Calculate	
Correction	691
Custom	703
Data	707
DTOPology	719
Equation	721
Filter	726
Format	733
FSimulator	736
Function	739
GCData	745
GCMeas	750
GroupDelay	754
Limit	757
Marker	767
Math	790
Measure	793
BLIMit	811
Correction	816
DATA	824
FILter	832
FUNcTion	839
GCData	845
GCMeas	851
GDElay	855
LIMit	858
MARKer	868
OFFSet	922

PARAmeter	925
RLIMit	931
SA	937
SMOothing	950
TRANsform	953
X	964
Mixer	967
Normalize	968
Offset	971
Parameter	974
RData	987
SA	989
Smoothing	1002
TDR	1005
Trace Hold	1034
Transform	1036
X Values	1047
Calpod	1050
Control	1057
Control Multiplexer	1081
ControlPXI	1085
CSET	1086
Display	1099
Format	1150
Hardcopy	1153
Initiate	1166
LXI	1169
Memory	1170
Output	1189
Sense	
Amplifier	1191
Average	1197
Bandwidth	1200
Class	1203
Control	1204
Correction	1222
Cal Kit	1259
Cal Stds	1274

Cal Sets	1300
Extensions	1320
Guided Cal	1335
Couple	1375
DC	1377
DUTControl	1381
FOM	1392
FOMSegment	1403
Frequency	1414
Gain Compression	1418
Mixer	1435
Multiplexer	1461
Noise	1475
Path	1493
Power	1500
Pulse	1501
Rosillator	1513
SA	1516
Segment	1581
Source	1612
Sweep	1615
SWITch	1630
XAxis	1634
Service	1635
Source	1636
Source Correction	1654
Status Register	1675
System	1696
CalAll	1734
CalPhase	1750
Capability	1758
CapabilityHardwareModule	1785
Communicate	1789
Config mmWave	1811
ConfigExtDevice	1830
ConfigExtDC	1841
ConfigExtPMAR	1854
ConfigExtPulseGen	1869

FIFO	1873
Preferences	1877
PXI Shared Memory Data Transfer	1895
TDR	1905
Uncertainty	1907
ServPVerif	1915
Trigger	1917
Examples	
SCPI Example Programs	1933
Automatic Fixture Removal (AFR)	
AFR Using One Differential 2X THRU	1935
AFR Using One Differential OPEN	1937
AFR Using One Single_Ended 2X THRU	1939
AFR Using One Single-Ended OPEN	1941
*ESR? Sweep Complete	1943
Cal All Channels Calibration	1945
Catalog Measurements using SCPI	1947
Channels, Windows, and Measurements using SCPI	1948
Control,Talk,Listen using SCPI	1951
Create a Balanced Measurement using SCPI	1953
Create a measurement using SCPI	1959
Create an FOM Measurement	1960
Create an SMC Fixed Output Meas	1964
Create_and_Cal_a_GCA_Measurement	1968
Create and Cal a Noise Figure Measurement	1976
Create and Cal a VMC Measurement	1980
Create and Cal an SMC Measurement	1985
Create and Cal Multiple SMC Channels	1990
Create New Cal Kit using SCPI	1993
Custom Power Meter Driver	2000
ECALConfidence Check using SCPI	2004
Establish a VISA Session	2008
External Test Set using SCPI wLink	2010
Getting and Putting Data using SCPI	2012
GPIB Pass Through	2016
GPIB using Visual C	2018
Load Eterms into Cal Sequence	2022
Modify a Calibration Kit using SCPI	2023

Guided 2-Port or 4-Port Cal	2025
Perform a Simple Source Power Cal	2029
Perform an ECal User Characterization	2031
Perform an Unguided Cal on a 4-Port PNA using SCPI	2040
Perform Guided 1-Port Cal using SCPI	2050
Perform Guided 1Port	2054
Perform Guided 2-Port Comprehensive Cal	2056
Perform Guided ECal	2065
Perform Guided Mechanical Cal	2067
Perform Guided TRL Calibration	2069
Perform an Unguided 1-Port Cal on Port 2	2072
Perform Unguided 2-Port Mech Cal	2074
Perform Unguided ECAL	2076
Perform Unknown Thru or TRL Cal	2078
Perform Multi DUT Parallel measurements	2081
Power Meter Uncertainty	2086
Setup Markers	2089
Setup Noise Figure Port Mapping	2091
Setup PNOP and PSAT Markers	2093
Setup RxLeveling	2096
Setup Sweep Parameters using SCPI	2098
Setup the Display using SCPI	2099
Show Custom Window during Calibration	2101
Sliding Load Cal using SCPI	2105
Spectrum Analyzer	2106
Status Reporting using SCPI	2109
Transfer Data using GPIB	2111
Triggering the VNA using SCPI	2113
Unguided_Cal_on_Multiple_Channels	2120
Upload and Download a Segment List	2125
Uploading a Source Power Cal using SCPI	2132
Perform Multi DUT Parallel measurements	2081
Concepts	
GP-IB Fundamentals	2136
The Rules and Syntax of SCPI Commands	2141
How to Configure for GPIB, SCPI, and SIDL	2146
Getting Data from the Analyzer	2149
Understanding Command Synchronization	2154

Calibrating the PNA Using SCPI	2161
Reading the Analyzer's Status Registers	2167
Referring to Traces, Measurements, Channels, and Windows Using SCPI	2172
Configure for VISA and SICL	2174
VEE Examples	
VEE Pro Runtime	2178
Basic Control VEE	2179
ECal with Confidence Check using VEE	2181
Data Access Map	
DataMapSet	2183
IO Connectors	
I/O Connector (M9485A)	2184
I/O Adapter (M98xxA/P50xxA)	2197
Material Handler IO Connector	2207
Programming Guide	662
New PXI Programming Commands	2223
Remotely Specifying a Source Port	2237
Using Macros	281
Multi DUT Parallel Measurement	2239
Applications	
Antenna Features	2243
Frequency Converter Application	2247
FCA Overview	2247
SMC Measurements	2259
MixerConverter Setup	2276
SMC plus Phase	2285
SMC Phase Reference Calibration	2290
Embedded LO	2300
Frequency Offset	
Frequency Offset	2305
Frequency Converting Device Measurements	2314
Frequency Offset Calibration	2315
Conversion Loss	2318
Conversion Compression	2322
Harmonic Distortion	2325
Return Loss and VSWR	2327
Vector-Mixer Calibration	2330
Gain Compression Application	2341

Gain Compression Cal	2369
Integrated Pulse Application	2373
Noise Figure	
Noise Figure Application	2384
Noise Figure Cal	2411
Noise Figure and TRL Cal	2420
Spectrum Analyzer	2425
Time Domain	2456
Millimeter Wave Configuration	
Overview	2475
Supported Applications	2477
Starting and Exiting Millimeter Wave Mode	2478
Millimeter Configuration	2480
Installation Cal	2483
Calibration	2487
Product Support	
Troubleshooting	2491
List of Error Messages	2494
About Error Messages	2581
Accessories	2585
Firmware Update	2592
Configurations and Options	2593
Option Enable	2602
Option Enable - M937xA	2608
Instrument Calibration	2612
Other Resources	2614
SCPI Errors	2615
Technical Support	2627
Licenses	2633
Diagnostic Tools and Adjustments	
Adjustment Overview	2635
System Verification	2637
Operators Check	2648
Troubleshooting Hint for M9485A	2651
10 MHz Reference Adjust	2665
Source Adjustment	2668
Receiver Cal	2670
Receiver Display	2672

System Settings	
Configure PXI Internal Modules	
RF Amplifier Module Control	2673
Switch Module Control	2676
DUT Control/8 bit Digital IO	2678
Configure a PXI SMU	2683
I/O Adapter (M98xxA/P50xxA)	2197
M9341 IO Module	61
Configure External Devices	2688
Configure an External Device	2688
Configure an External Source	2694
Configure a DC Device	2699
Configure a Power Meter As Receiver	2708
Configure an External Pulse Generator	2720
Synchronize an External PSG Source	2724
IO Connectors	
I/O Connector (M9485A)	2184
I/O Adapter (M98xxA/P50xxA)	2197
Material Handler IO Connector	2207
M9341 IO Module	61
Error Messages	2581
Direct Receiver Access	2726
Display Colors	2728
Frequency Blanking	101
Mechanical Devices	2732
Preferences	105
Power Limit and Power Offset	2735
Receiver Temperature	2738
Source Power Alignment	2739
System Impedance	2741
Windows File Locations	20
Tutorials	
App Notes	2742
Network Analyzer Basics	2745
Connector Care	29
ESD Protection	2746
Measurements	
Absolute Output Power	2747

AM-PM Conversion	2750
Amplifier Measurements	2755
Antenna Measurements	2758
Balanced Measurements	2761
Complex Impedance	2770
Comparing the Delay Functions	2773
Deviation from Linear Phase	2775
Directional Coupler Directivity Measurement	2779
Dual Band Parallel Noise Figure Measurement	2783
External Source Control	2724
FIFO and other Antenna Features	2243
Gain and Flatness	2789
Gain Compression	2792
Group Delay	2797
High-Gain Amplifier Measurements	2804
Phase Measurements	2806
Reverse Isolation	2810
Reflection Measurements	2813
Time Domain Measurements	2456
Synchronize an External PSG Source	2724
GUI Reference	
Avg BW	2818
Cal	2819
Channel	2820
Display	2821
Format	2822
Freq	2823
Macro	2824
Marker	2825
Math	2827
Meas	2829
Power	2830
Preset	2831
Save Recall	2832
Scale	2833
Search	2834
Setup	2837
Sweep	2838

System	2839
Trace	2841
Trigger	2842
Undo	2843
Glossary	2844
Specifications	2870

Soft Front Panel Help**Quick Start****1. Setup****2. Optimize****3. Calibrate****4. Analyze Data****5. Print/Save****System Settings****Programming****What's New**Rev A.13.70 (M980xA/P500xA) Rev A.13.10 (P937xA) Rev A.12.60.xx (M9485A/M937xA) -
20-May-2019**Measurement
Tutorials****Product Support / Specs****Links to App Notes****Starting the VNA SFP****Still looking for answers?**Post your question at the [Keysight Discussion Forums](#)

What's New

Notes

- The latest version includes changes from all previous versions.
- See [New Programming Commands](#)
- To see the code version, from the SFP click **Help**, then **About Network Analyzer**

What's New in VNA Code Version A.13.70

- Support P502xA / P5005A to 08A / M9805A to 08A

What's New in VNA Code Version A.13.40

- Support P5000A to 04A / M9800A to 04A
- Support [TraceManager_Dialog](#)

What's New in VNA Code Version A.13.50

- Support for [N5252A millimeter wave banded network analyzer system](#)

What's New in VNA Code Version A.13.10

P937xA

- [Automatic Fixture Removal \(Option S97007A\)](#)
- [Time Domain \(Option S97010A\)](#)
- [Frequency Offset Measurements \(Option S97080A\)](#)
- [Scalar Mixer Converter \(SMC\) measurements \(Option S97082A\)](#)
- [N Port Configuration \(Option S97551A\)](#)

What's New in PXIe Code Version A.12.60.02

M9485A/M937xA

- Support Ecal N469xD.

M937xA

- Support M9161D PXI Solid State Dual SP4T Switch

M9485A

- Support Shift LO

What's New in PXIe Code Version A.12.55

M9485A/M937xA

- Support Automatic Fixture Removal (Option 007)
- Support M9341B Digital/Analog I/O
- Support M9111A PXI SMU

M9485A

- Support M9161D PXI Solid State Dual SP4T Switch
- Support M9379A and M9161D control for Noise Figure measurement (Option 028)

What's New in PXIe Code Version A.12.50

M9485A

- Support Noise Figure measurement (Option 028)
- Support M9341A
- Support M9379A

What's New in PXIe Code Version A.03.10

- Support for N755xA ECal modules

What's New in PXIe Code Version A.03.00

- Ground Loop embedding/de-embedding
- Trigger Delay
- The following features are now standard:
 - Fixturing
 - Port Z Conversion
 - 4-Port De/Embed
 - Differential Z Conversion
 - Common Mode Z Conversion
 - Differential Port Matching
 - Power Compensation
 - Port Extensions
 - Equation Editor
- CalPod
- Cal Plane Manager

What's New in PXIe Code Version A.02.00

- Measurement Speed Enhancements

Windows File Locations

State files and most data file storage locations:

- Windows 7 or Windows 10: C:\

Firmware executable file locations:

- Windows 7 or Windows 10: c:\program files (x86)\Keysight\network analyzer
- On 32 bit PXI controllers, this returns: " "c:\program files\Agilent\network analyzer"

Support file locations

- Windows 7 or Windows 10: c:\programdata\Keysight\network analyzer

These file locations can be queried remotely.

SCPI Command: **SYSTem:CONFigure:DIRectory?**

See Also

[Your Programs on Windows](#)

Multiport and Multisite Configuration

When more than one module is installed, you can choose to configure them as a **Multiport VNA** or as **Multisite VNAs** .

- M937xA/M980xA
 - PXIe VNA Multiport (Multi module)
 - PXI VNA Multisite
- USB VNAs
 - USB VNA Multiport
 - Assigning Correct Chassis Number to Master Chassis
 - USB VNA Multisite

PXIe VNA Multiport (Multi Module)

(M937xA) With option 551 purchased for any single module, you can create a Multiport system as long as the single module with option 551 is included somewhere in the chassis.

For example:

The dialog shows 6 modules installed in the chassis in slots 5, 6, 7, 8, 15, 16. The module in slot 5 (PXI13) has option 551. In this case, slots 5, 6, and 7 are selected. Click **Run**. Those three modules behave as a Multiport (6-port) VNA. That instance of the SFP, and your remote programs, will allow you to calibrate and make measurements at ports 1 through 6. Each test port has a source, measurement receiver, and reference receiver.

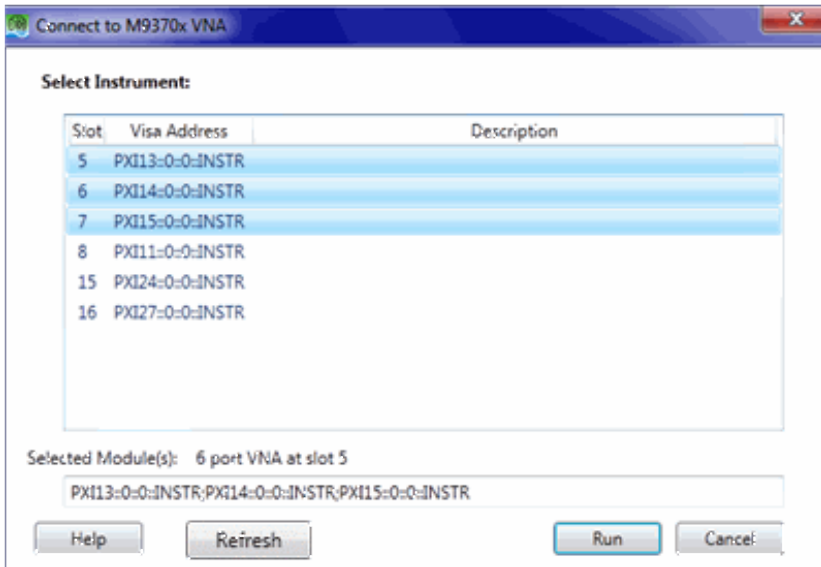

(M980xA) When S95551A is installed on your controller, you can create a multiport (Multi module) system for any modules.

- The modules MUST be **physically** configured as a Multiport VNA. Do this by connecting the front-panel Ref In/Out, Trigger In/Out, and LO In/Out lines.
 - Learn how in the M937xA Installation Guide at the M937xA documentation website .
 - See <https://www.keysight.com/find/m980xa-mm> for M980xA multi module configuration.
- (M937xA) The selected modules in a Multiport VNA MUST be sequential and must include at least ONE module with opt 551. For example, to configure a 6-port VNA using the above installed modules, you could choose Slots 5, 6, 7. You could NOT choose 5, 7, 8; they are not sequential. Nor could you choose 6, 7, 8; they do NOT include PXI13 which has option 551.
- Each VNA module has ports labeled 'Test Port 1' and 'Test Port 2'. In a Multiport VNA, test ports become virtually numbered beginning with the module in the lowest numbered slot to the highest numbered slot. In our example 6-port VNA, the module in slot 6 would be Test Port 3 on top, and Test Port 4 on bottom. The module in slot 7 would be Test Port 5 on top, and Test Port 6 on bottom.
- The first module, from left to right, is the Master module. To control the Reference, Triggering, and LO signals for the Multiport VNA, you make settings on the first module. The other modules follow.
- **Module Number** - A few remote commands require the module number. This is the order in which the module appears in the Multiport VNA. In the above example, Module 1 is in slot 5, module 2 is in slot 6, and so forth.
- (M937xA) The software supports up to 16 modules connected together to form a 32-port VNA. (M980xA) The software supports up to 66-port VNA with 11 * 6 port M980xAs.

See Also: Programming Multiport and Multisite configurations

PXIe VNA Multisite

Note: M980xA does not support this function.

While the one PXI VNA is running, you can also create a different, fully-functioning VNA which would run at the same time as the VNA. The only practical limit to the number of VNA instances is the CPU speed of the host controller. The benefit of creating Multisite VNAs is measurement throughput. You could test multiple devices at the same time.

Here is how to create a Multisite VNA:

1. With the first VNA already running, again click the desktop icon, which restarts the Launcher dialog.
2. The Launcher dialog shows the same selected slots as the previous time. The selection is 'sticky' to allow you to quickly run the same configuration as before.
3. Click each to unselect the previously-selected slots.
4. Then select one or more of the previously-unused VNA modules. In our example, this would be slots 8, 15, and 16.
5. Click **Run** and another SFP display appears.

USB VNA Multiport

With option S97551A purchased for any single module, you can create a Multiport system as long as the single module with option S97551A is included in the configuration.

Note: In a multiport configuration, the USB VNA is limited to a maximum of 4 ports by interconnecting two modules together.

- The modules **MUST** be **physically** configured as a Multiport VNA. Do this by connecting the front-panel Ref In/Out, Trig In/Out, and LO In/Out lines using semi-rigid cables as shown below. Y1701A Multiple USB instruments configuration kit is available.
 - Use a torque wrench for 3.5 mm to fasten the connectors (Keysight P/N 8710-1765, 0.9 Nm)

Y1701-001 Interconnect cables for multiport configuration of P937xA



Y1701A-002 Interconnect cables for multiport configuration of P50xxA (up to 20 GHz)

Y1701A-003 Interconnect cables for multiport configuration of P50xxA (above 20 GHz)

P50xxA (up to 20 GHz)



P50xxA (above 20 GHz)



Note: The 1H chassis should be placed above the 2H chassis in the middle case of the picture

Designator	Part number	Description	Qty
A	P5000-61603	Cable Assembly, Control 175mm-LG	1
	M9800-01201	Angle, Control Cable Assembly	2
	0515-4351	Screw-SKT-HD-Cap HEX-SKT M3X0.5 4mm-LG	2
B	P5000-61601	Cable Assembly, LO jumper, 1H	1
C	P5000-61602	Cable Assembly, LO jumper, 2H	1

- The kit to fix double-decker USB VNAs is also available. Y1701A-101 Latch kit for connecting two 1-slot USB instruments





- The modules in a Multiport VNA MUST include at least ONE module with opt S97551A.
- Each VNA module has ports labeled 'Port 1' and 'Port 2'. In a Multiport VNA, test ports become virtually numbered beginning with the module having the semi-rigid cable connections to its Ref Out, Trig Out, and LO Out. For example, in the graphic above, the module on the bottom (master) will have 'Port 1' and 'Port 2' and the module on top will have 'Port 3' and 'Port 4'.
- To control the Reference, Triggering, and LO signals for the Multiport VNA, you make settings on the first module. The other module follows.
- **Module Number** - A few remote commands require the module number. This is the order in which the module appears in the Multiport VNA.
- The software supports up to 2 modules connected together to form a 4-port VNA.

See Also: Programming Multiport and Multisite configurations

Assigning Correct Chassis Number to Master Chassis

In the multiport configuration using 2 modules, it is critical that the correct chassis number be assigned to the "master" chassis. The master chassis must have the lowest chassis number.

With a 4 port system using 2 chassis, there is a 50% chance that the wrong master is selected by the IO Libraries. If that is the case, after launching the firmware in 4 port mode, the following error is displayed:

Warning: Missing frequency reference.

To resolve the issue, you can either:

1. Physically swap the chassis and the cables.
2. Reconfigure the chassis numbers in the IO libraries:

How to Reconfigure the Chassis Numbers in IO Libraries

1. After setting up the hardware for multiport, launch the IO Libraries and display the PXI/AXIe Chassis view.

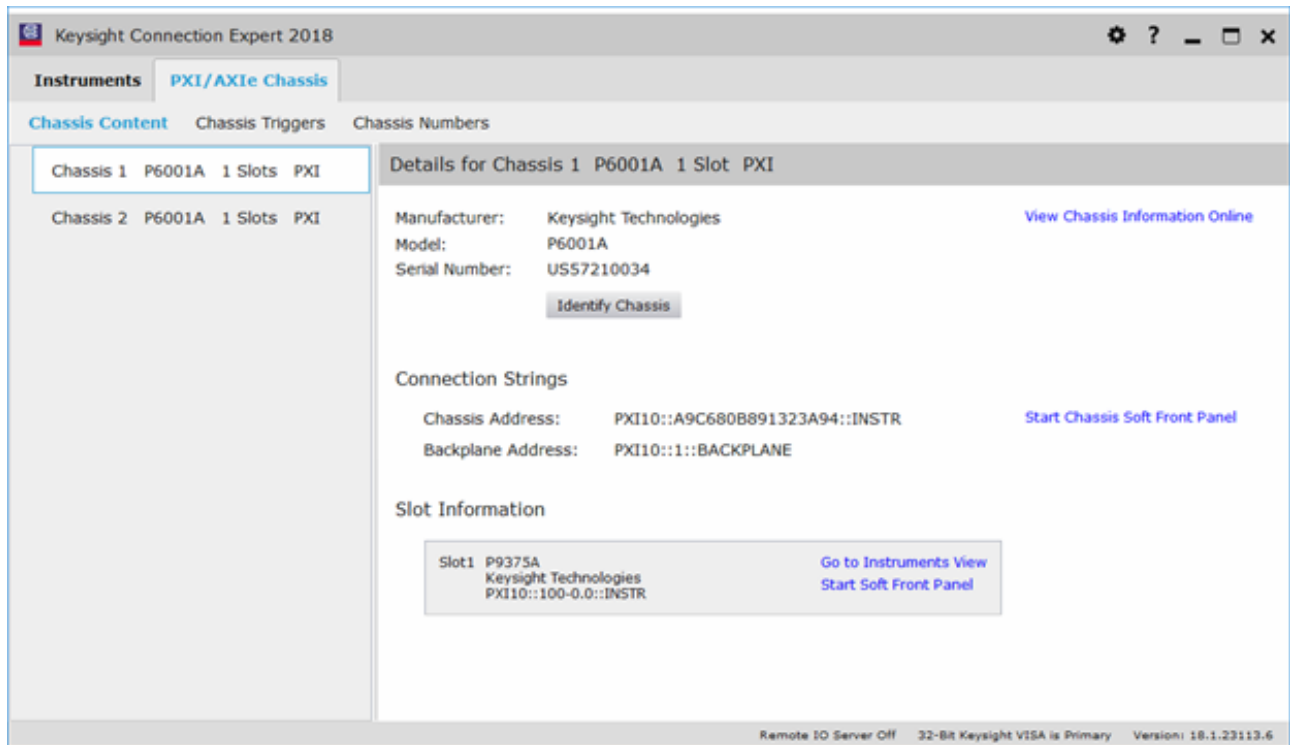

2. Click on the Chassis Number selection.

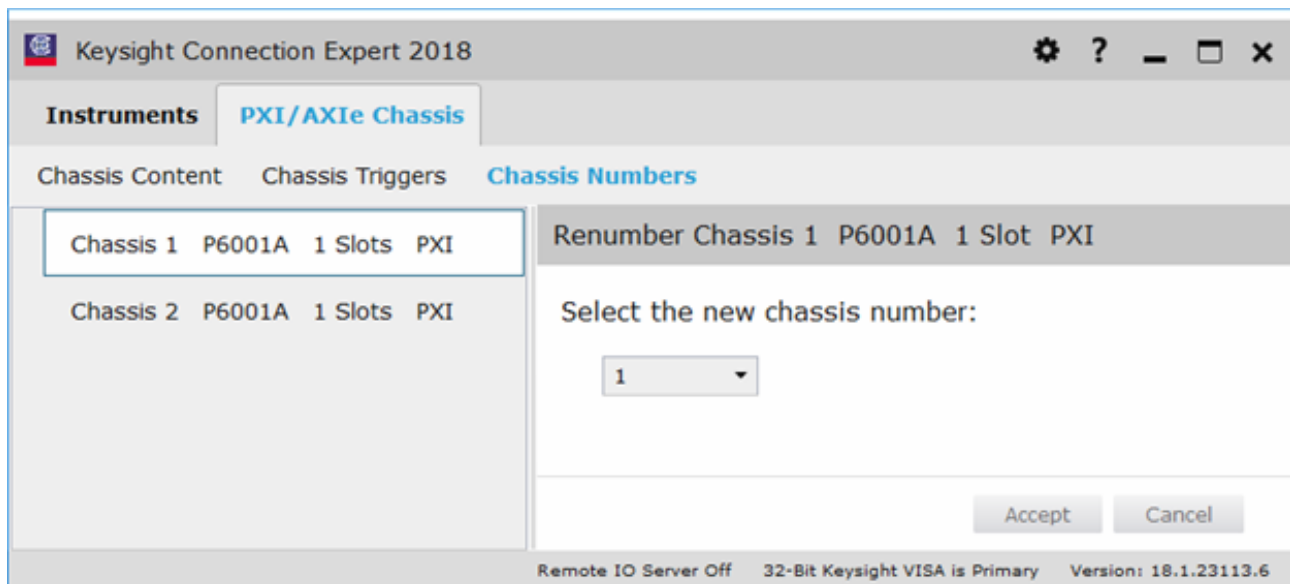

3. Change Chassis 1 to be Chassis 3, then click the **Accept** button.

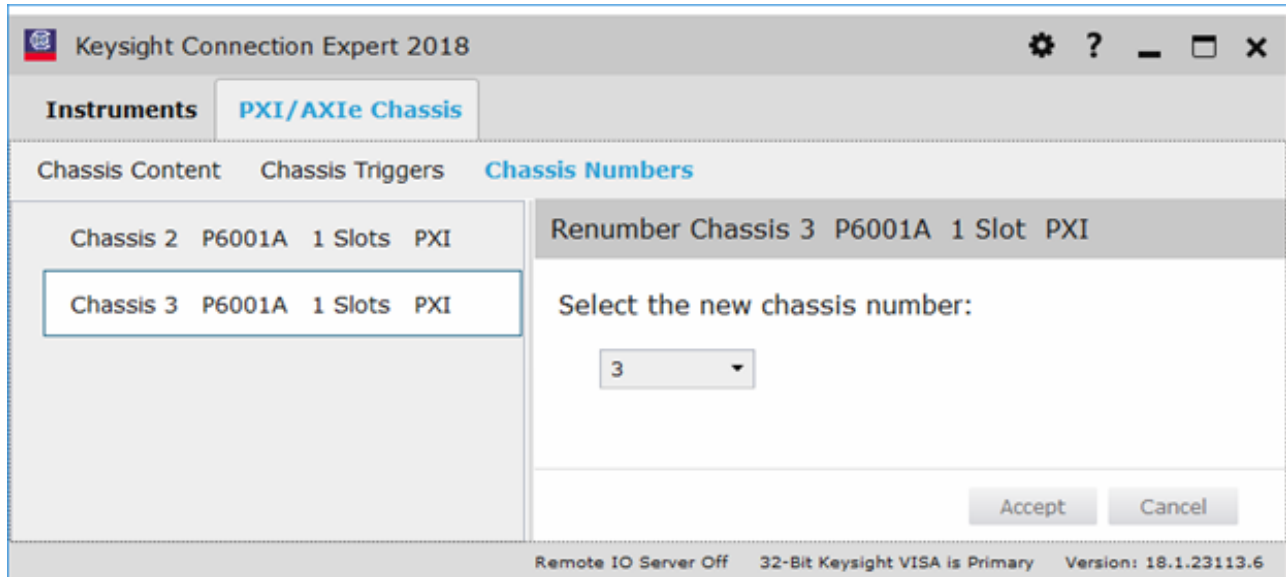

4. Chassis 2 now becomes the master chassis and Chassis 3 is the slave chassis.

P937xA Multisite VNA

Note: In a multisite configuration, the P937xA is limited to a maximum of 4 modules.

Note: P50xxA does not support this function.

The benefit of creating Multisite VNAs is measurement throughput. You could test multiple devices at the same time.

Here is how to create a Multisite VNA:

1. With the first VNA already running, again click the desktop icon, which restarts the Launcher dialog.
2. The Launcher dialog shows the same modules as the previous time. The selection is 'sticky' to allow you to quickly run the same configuration as before.
3. Click each to unselect the previously-selected modules.
4. Then select one or more of the previously-unused VNA modules.
5. Click **Run** and another SFP display appears.

Connector Care

Proper connector care is critical for accurate and repeatable measurements. The following information will help you preserve the precision and extend the life of your connectors - saving both time and money.

- [Connector Care Quick Reference Guide](#)
- [Connector Cleaning Supplies](#)
- [Safety Reminders](#)
- [About Connectors](#)
- [Gaging Fundamentals](#)
- [Connector Care Procedures](#)

See Also

mmWave Connector Care at http://na.support.keysight.com/pna/connectorcare/Connector_Care.htm

Preventing Test Port Connector Damage

Handling and Storing Connectors

Do

Keep connectors clean

Protect connectors with plastic end caps

Keep connector temperature same as analyzer

Do Not

Touch mating-plane surfaces

Set connectors contact-end down

Store connectors loose in box or drawer

Visual Inspection

Do

Inspect connectors with magnifying glass.

Look for metal debris, deep scratches or dents

Do Not

Use a connector with a bent or broken center conductor

Use a connector with deformed threads

Cleaning Connectors

Do

Clean surfaces first with clean, dry compressed air

Do Not

Use high pressure air (>60 psi)

Use lint-free swab or brush

Use any abrasives

Use minimum amount of alcohol

Allow alcohol into connector support beads

Clean outer conductor mating surface and threads Apply lateral force to center conductor

Gaging Connectors

Do

Inspect and clean gage, gage master and device tested

Use correct torque wrench

zero gage before use

Use multiple measurements and keep record of readings

Do Not

Use an out of specification connector

Hold connector gage by the dial

Making Connections

Do

Align connectors first

Rotate only the connector nut

Use correct torque wrench

Do Not

Cross thread the connection

Twist connector body to make connection

Mate different connector types

Connector Care and Cleaning Supplies

Description	Web Site
Swabs	http://www.berkshire.com/swabs.shtml
Lint Free Cloths- Air dusters	http://www.ccrwebstore.com
Isopropyl	http://www.techspray.com
Nitrilite Gloves and Finger Cots	http://www.techni-tool.com

Safety Reminders

When cleaning connectors:

- Always use protective eyewear when using compressed air or nitrogen.
- Keep isopropyl alcohol away from heat, sparks and flame. Use with adequate ventilation. Avoid contact with eyes, skin and clothing.
- Avoid electrostatic discharge (ESD). Wear a grounded wrist strap (having a 1 MΩ series resistor) when cleaning device, cable or test port connectors.
- Cleaning connectors with alcohol shall only be done with the instruments power cord removed, and in a well-ventilated area. Allow all residual alcohol moisture to evaporate, and the fumes to dissipate prior to

energizing the instrument.

About Connectors

- [Connector Service Life](#)
- [Connector Grades and Performance](#)
- [Adapters as Connector Savers](#)
- [Connector Mating Plane Surfaces](#)

Connector Service Life

Even though calibration standards, cables, and test set connectors are designed and manufactured to the highest standards, all connectors have a limited service life. This means that connectors can become defective due to wear during normal use. For best results, all connectors should be inspected and maintained to maximize their service life.

Visual Inspection should be performed each time a connection is made. Metal particles from connector threads often find their way onto the mating surface when a connection is made or disconnected. See [Inspection](#) procedure.

Cleaning the dirt and contamination from the connector mating plane surfaces and threads can extend the service life of the connector and improve the quality of your calibration and measurements. See [Cleaning](#) procedure.

Gaging connectors not only provides assurance of proper mechanical tolerances, and thus connector performance, but also indicate situations where the potential for damage to another connector may exist. See [Gaging](#) procedure.

Proper connector care and connection techniques yield:

- Longer Service Life
- Higher Performance
- Better Repeatability

Connector Grades and Performance

The three connector grades (levels of quality) for the popular connector families are listed below. Some specialized types may not have all three grades.

- **Production** grade connectors are the lowest grade and the least expensive. It is the connector grade most commonly used on the typical device under test (DUT). It has the lowest performance of all connectors due to its loose tolerances. This means that production grade connectors should always be carefully inspected before making a connection to the analyzer. Some production grade connectors are not intended to mate with metrology grade connectors.

- **Instrument** grade is the middle grade of connectors. It is mainly used in and with test instruments, most cables and adapters, and some calibration standards. It provides long life with good performance and tighter tolerances. It may have a dielectric supported interface and therefore may not exhibit the excellent match of a metrology grade connector.
- **Metrology** grade connectors have the highest performance and the highest cost of all connector grades. This grade is used on calibration standards, verification standards, and precision adapters. Because it is a high precision connector, it can withstand many connections and disconnections and, thus, has the longest life of all connector grades. This connector grade has the closest material and geometric specifications. Pin diameter and pin depth are very closely specified. Metrology grade uses an air dielectric interface and a slotless female contact which provide the highest performance and traceability.

Note: In general, Metrology grade connectors should not be mated with Production grade connectors.

Adapters as Connector Savers

Make sure to use a high quality (Instrument grade or better) adapter when adapting a different connector type to the analyzer test ports. It is a good idea to use an adapter even when the device under test is the same connector type as the analyzer test ports. In both cases, it will help extend service life, and protect the test ports from damage and costly repair.

The adapter must be fully inspected before connecting it to the analyzer test port and inspected and cleaned frequently thereafter. Because calibration standards are connected to the adapter, the adapter should be the highest quality to provide acceptable RF performance and minimize the effects of mismatch.

Connector Mating Plane Surfaces

An important concept in RF and microwave measurements is the reference plane. For a network analyzer, this is the surface that all measurements are referenced to. At calibration, the reference plane is defined as the plane where the mating plane surfaces of the measurement port and the calibration standards meet. Good connections (and calibrations) depend on perfectly flat contact between connectors at all points on the mating plane surfaces (as shown in the following graphic).

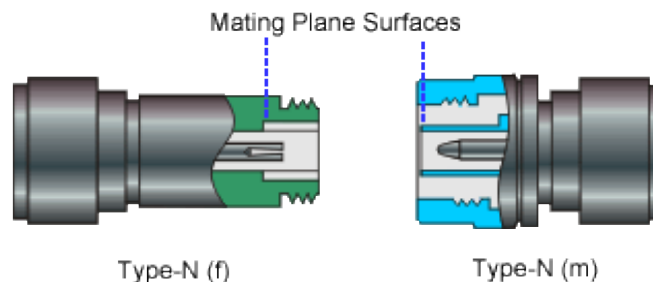

Gaging Fundamentals

Connector gages are important tools used to measure center conductor pin depth in connectors. Connector pin depth, measured in terms of recession or protrusion, is generally the distance between the mating plane and the end of the center conductor, or the shoulder of the center conductor for a stepped male pin.

Typical Connector Gage

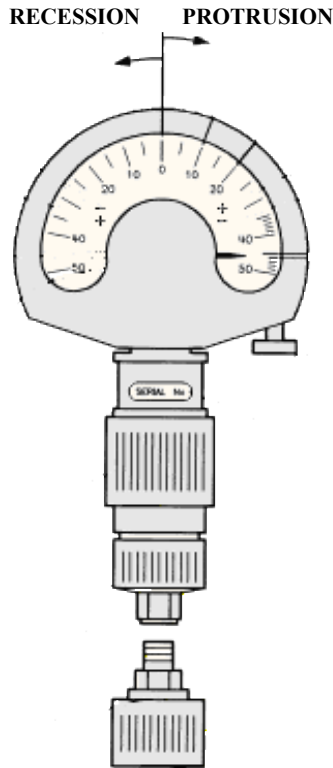

Recession and Protrusion

Pin depth is negative (recession) if the center conductor is recessed below the outer conductor mating plane, usually referred to as the "reference plane". Pin depth is positive (protrusion) if the center conductor projects forward from the connector reference plane.

Pin Depth

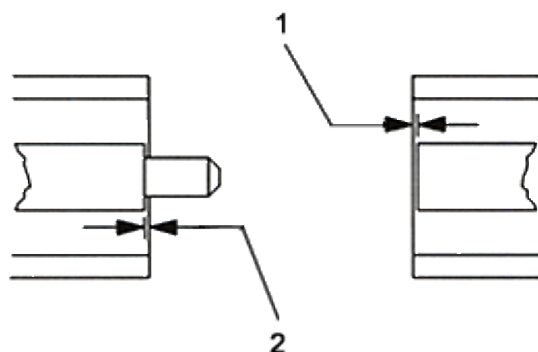

1. Recession of female contact
2. Recession of male pin shoulder

Difference with Type-N Connectors

Type-N connectors have the mating plane of the center conductors offset from the connector reference plane. In this case the zero setting "gage masters" generally offset the nominal distance between the center conductor mating plane and the connector reference plane.

When to Gage Connectors

- Before using a connector or adapter the first time.
- When visual inspection or electrical performance suggests the connector interface may be out of range.
- After every 100 connections, depending on use.

Connector Gage Accuracy

Connector gages (those included with calibration and verification kits), are capable of performing coarse measurements only. This is due to the repeatability uncertainties associated with the measurement. It is important to recognize that test port connectors and calibration standards have mechanical specifications that are extremely precise. Only special gaging processes and electrical testing (performed in a calibration lab) can accurately verify the mechanical characteristics of these devices. The pin depth specifications in the Keysight calibration kit manuals provide a compromise between the pin depth accuracy required, and the accuracy of the gages. The gages shipped with calibration and verification kits allow you to measure connector pin depth and avoid damage from out-of-specification connectors.

Note: Before gaging any connector, the mechanical specifications provided with that connector or device should be checked.

To Gage Connectors

1. Wear a grounded wrist strap (having a 1 M Ω series resistor).
2. Select proper gage for device under test (DUT).
3. Inspect and clean gage, gage master, and DUT.
4. Zero the connector gage.
 - a. While holding gage by the barrel, carefully connect gage master to gage. Finger-tighten connector nut only.
 - b. Use proper torque wrench to make final connection. If needed, use additional wrench to prevent gage master (body) from turning. Gently tap the barrel to settle the gage.
 - c. The gage pointer should line up exactly with the zero mark on gage. If not, adjust "zero set" knob until gage pointer reads zero. On gages having a dial lock screw and a movable dial, loosen the dial lock screw and move the dial until the gage pointer reads zero. Gages should be zeroed before each set of measurements to make sure zero setting has not changed.
 - d. Remove gage master.
5. Gage the device under test.
 - a. While holding gage by the barrel, carefully connect DUT to gage. Finger-tighten connector nut only.
 - b. Use proper torque wrench to make final connection and, if needed, use additional wrench to prevent DUT (body) from turning. Gently tap the barrel to settle the gage.
 - c. Read gage indicator dial for recession or protrusion and compare reading with device specifications.

Caution: If the gage indicates excessive protrusion or recession, the connector should be marked for disposal or sent out for repair.

6. For maximum accuracy, measure the device a minimum of three times and take an average of the readings. After each measurement, rotate the gage a quarter-turn to reduce measurement variations.
7. If there is doubt about measurement accuracy, be sure the temperatures of the parts have stabilized. Then perform the cleaning, zeroing, and measuring procedure again.

Connector Care Procedures

- [Inspecting Connectors](#)
- [Cleaning Connectors](#)

- [Making Connections](#)
- [Using a Torque Wrench](#)
- [Handling and Storing Connectors](#)

To Inspect Connectors

Wear a grounded wrist strap (having a 1 M Ω series resistor).

Use a magnifying glass ($\geq 10X$) and inspect connector for the following:

- Badly worn plating or deep scratches
- Deformed threads
- Metal particles on threads and mating plane surfaces
- Bent, broken, or mis-aligned center conductors
- Poor connector nut rotation

Caution: A damaged or out-of-specification device can destroy a good connector attached to it even on the first connection. Any connector with an obvious defect should be marked for disposal or sent out for repair.

To Clean Connectors

1. Wear a grounded wrist strap (having a 1 M Ω series resistor).
2. Use clean, low-pressure air to remove loose particles from mating plane surfaces and threads. Inspect connector thoroughly. If additional cleaning is required, continue with the following steps.

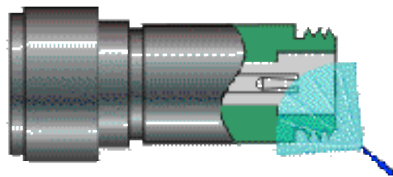

3. Moisten—do not saturate—a lint-free swab with isopropyl alcohol. See [Cleaning Supplies](#) for recommended type.
4. Clean contamination and debris from mating plane surfaces and threads. When cleaning interior surfaces, avoid exerting pressure on center conductor and keep swab fibers from getting trapped in the female center conductor.

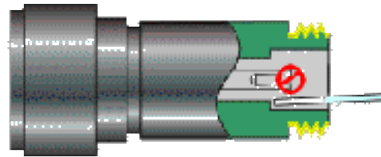

5. Let alcohol evaporate—then use compressed air to blow surfaces clean.
6. Inspect connector. Make sure no particles or residue remains.
7. If defects are still visible after cleaning, the connector itself may be damaged and should not be used. Determine the cause of damage before making further connections.

To Make Connections

1. Wear a grounded wrist strap (having a 1 M Ω series resistor).
2. Inspect, clean, and gage connectors. All connectors must be undamaged, clean, and within mechanical specification.
3. Carefully align center axis of both devices. The center conductor pin—from the male connector—must slip concentrically into the contact finger of the female connector.



4. Carefully push the connectors straight together so they can engage smoothly. Rotate the connector nut (not the device itself) until finger-tight, being careful not to cross the threads.

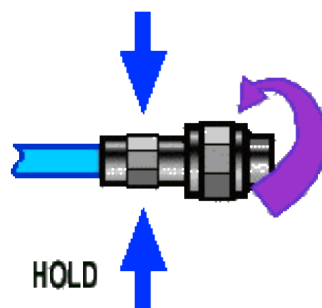

5. Use a torque wrench to make final connection. Tighten until the "break" point of the torque wrench is reached. Do **not** push beyond initial break point. Use additional wrench, if needed, to prevent device body from turning.

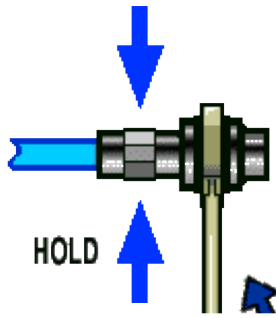

To Separate a Connection

1. Support the devices to avoid any twisting, rocking or bending force on either connector.
2. Use an open-end wrench to prevent the device body from turning.
3. Use another open-end wrench to loosen the connector nut.
4. Complete the disconnection by hand, turning only the connector nut.
5. Pull the connectors straight apart.

To Use a Torque Wrench

1. Make sure torque wrench is set to the correct torque setting.
2. Position torque wrench and a second wrench (to hold device or cable) within 90° of each other before applying force. Make sure to support the devices to avoid putting stress on the connectors.

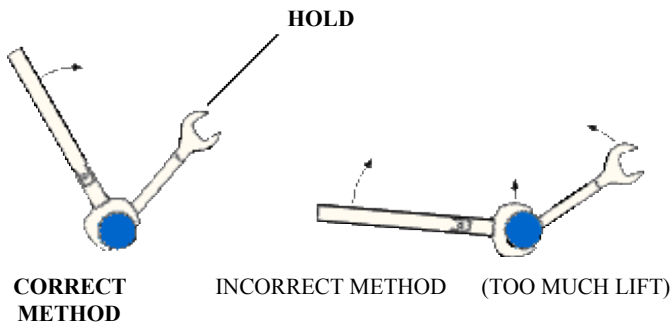

3. Hold torque wrench lightly at the end of handle—then apply force perpendicular to the torque wrench handle. Tighten until the "break" point of the torque wrench is reached. Do **not** push beyond initial break point.

TORQUING DIRECTION

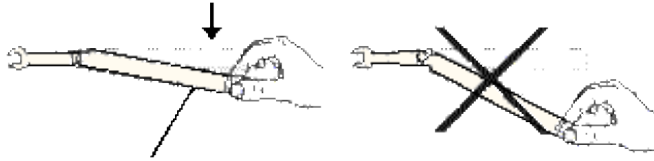

STOP WHEN HANDLE BEGINS TO YIELD

To Handle and Store Connectors

- Install protective end caps when connectors are not in use.
 - Never store connectors, airlines, or calibration standards loose in a box. This is a common cause of connector damage.
 - Keep connector temperature the same as analyzer. Holding the connector in your hand or cleaning connector with compressed air can significantly change the temperature. Wait for connector temperature to stabilize before using in calibration or measurements.
 - Do not touch mating plane surfaces. Natural skin oils and microscopic particles of dirt are difficult to remove from these surfaces.
 - Do not set connectors contact-end down on a hard surface. The plating and mating plane surfaces can be damaged if the interface comes in contact with any hard surface.
 - Wear a grounded wrist strap and work on a grounded, conductive table mat. This helps protect the analyzer and devices from electrostatic discharge (ESD).
-

Programming the PXIe/USB VNA

The following tips can help you successfully program the VNA.

SCPI (Standard Commands for Programmable Instruments)

The VNA is programmable using the SCPI language. The [SCPI documentation](#) is included in this help file.

In the VNA, SCPI commands **MUST** be sent through either **HiSLIP** or through the IVI-COM/Labview driver **pass-through**.

HiSLIP

The VNA software supports the HiSLIP interface for SCPI commands. This **MUST** be enabled from the Soft Front Panel using the IO configuration dialog. [Learn more](#).

Note: (M937xA) If you can NOT connect with an external PC using LAN (HiSLIP), add a single exception to the firewall – either for the 835x.exe or for port 4880.

IVI-COM / IVI-C / LabView Driver Interfaces

These drivers are the preferred programming interface to the VNA software. The IVI COM driver is extensively documented in its own help file located at "c:\program files\ivi foundation\ivi\drivers\agna\agna.chm". The IVI driver is also installed at the firmware installation.

- There are numerous examples for using the IVI-COM driver to perform common operations. They are located at: "c:\program files\ivi foundation\ivi\drivers\agna\examples".
- Each of these drivers has a SCPI **pass-through** interface that can be used to send SCPI commands directly to the instrument.
- It is NOT necessary to launch the soft front panel to use these drivers.

Live Soft Front Panel (SFP)

By default, the SFP is NOT visible when using the driver interface to connect to the VNA. However, both the remote program and the SFP can run simultaneously. This can be useful during development to help diagnose any programming errors. Start the SFP by clicking the "Network Analyzer" icon on the controller desktop.

PXI VNA connection string

The PXI addresses are available in three locations:

1. through the **Launcher application** (Network Analyzer icon on the desktop)
2. through Keysight IO Libraries
3. through the VISA library by using `viFindRsrc()`.

From the **Launcher application** copy the address on the dialog. For a 1-module example, a PXI address may be `PXI15::0::0::INSTR`

If you know the chassis and slot number of your module, you can also format the connection string this way:

M937xA / M980xA

`PXI0::CHASSIS<Chassis#>::SLOT<Slot#>::INSTR`. For example, if you only have 1 chassis (this is most common), and the PXI VNA is in slot 9, then the connection string would be:

```
PXI0::CHASSIS1::SLOT9::INSTR
```

USB VNA

`PXI0::CHASSIS<Chassis#>::SLOT<Slot#>::FUNC0::INSTR`. For example, if you only have 1 chassis (this is most common), then the connection string would be:

```
PXI0::CHASSIS1::SLOT1::FUNC0::INSTR
```

Speed up Measurements and Data Transfers

[Learn how.](#)

Multiple Modules (M937xA / P937xA / M980xA / P50xxA)

When using multiple VNA modules, you can choose to use them in a Multisite or Multi-port configuration.

Multiport

When connecting to multiple modules, at least one of the modules must have option 551 (M937xA) or option S97551A (P937xA/M980xA/P50xxA). The connection string for Multiport is a semicolon ";" delineated list of addresses.

For example (M937xA): The following creates a 4-port VNA using a VNA module in slot 9 combined and another in slot 10. Port 1 and Port 2 are measured on slot 9. Port 3 and Port 4 are measured on slot 10.

```
PXI0::CHASSIS1::SLOT9::INSTR;PXI0::CHASSIS1::SLOT10::INSTR
```

[Learn more about Multiport configurations.](#)

Multisite

Note: M980xA and P50xxA do not support this function.

When connecting to Multisite VNAs, simply connect to each of them separately and configure them individually.

When running your program on the PXI controller using the IVI-COM, Labview, or IVI-C driver, you can use the **PXI VNA connection string** (shown above). The VNA firmware does not need to be started with the launcher GUI.

You can also connect over LAN using the HiSLIP address. First, you must enable the HiSLIP interface using the **GPIB dialog**. Then, you must launch the VNA modules using the Launcher GUI. Use a unique address to identify each of the VNA firmware instances as follows for 2 VNA modules.

- `TCPIP0::<hostname>::hislip0::INSTR`
- `TCPIP0::<hostname>::hislip1::INSTR`

[Learn more about Multisite configurations.](#)

Mix and Match





You can mix-and-match your Multisite and Multiport instances. For example, with 4 M937xA PXI VNA modules, you can run a 6-port Multiport instance using 3 of your PXI VNA modules at the same time that you run a 2-port instance using the last module.

Port Configuration Wizard (M9485A)

Overview

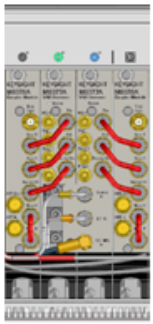
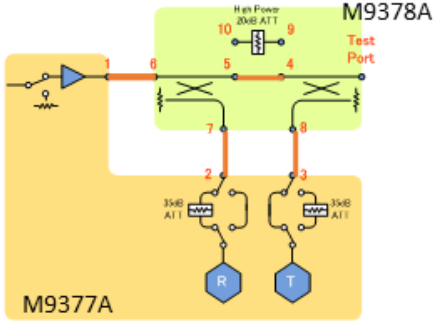
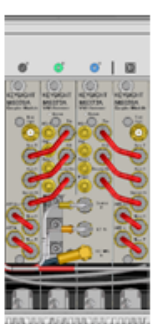
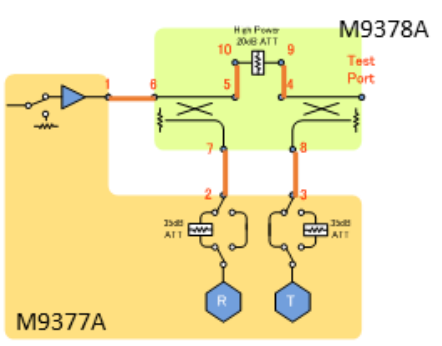
The Port Configuration Wizard helps you to configure all ports of M9377A Direct Access Receiver Modules and M9378A Coupler Modules in the M9485A PXI system. After setting up port configuration of all ports of the system with this Port Configuration Wizard, the port configuration information file of the system is generated and stored in a folder. The M9485A application (SFP) reads this configuration information file at startup to setup calibrated or nominal source power correction data for each port according to the configuration type of the port. This port configuration information is also used for the system power calibration tool.

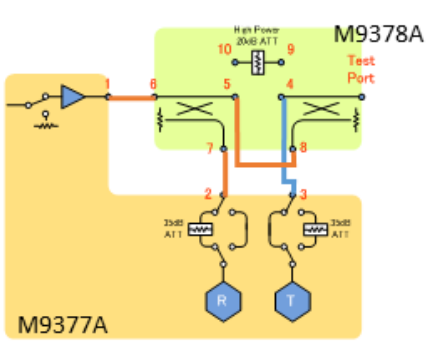
The following four configurations are available for a combination of M9377A and M9378A. The Direct Access receiver (DA) configuration is also available for the M9377A stand-alone usage.

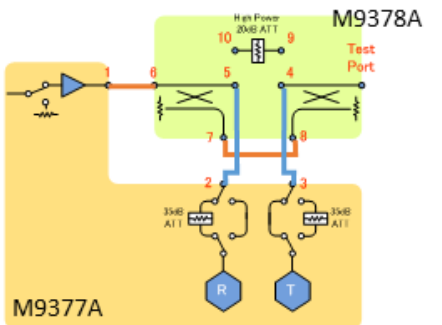
Configuration	Connection	Block Diagram
Standard		
High Power (HP)		
Wide Dynamic Range (WDR)		
High Gain (HG)		

The following color is assigned for each configuration:

- Standard: White
- High Power: Red
- Wide Dynamic Range: Blue
- High Gain: Yellow

This color helps to make a cable connection. The each jumper cables have the color label for each application. Pick up the cables which has your configuration color. Then connect the cables. The number in label of the cables shows the connector number on the module.

Procedure

Port Configuration Selection

1. Execute the Port Configuration Wizard
 - If your system has at least one M9377A Direct Access Receiver Module, the Port Configuration Wizard is automatically displayed just after M9485A SFP is executed for the first time.
 - Users can also start the Port Configuration Wizard from the soft key under System > Service > System Power Cal.. , then click Port Config button.
2. The Port Configuration Wizard detects the installed modules and show the module arrangement.
3. Select the configuration for each M9377A.

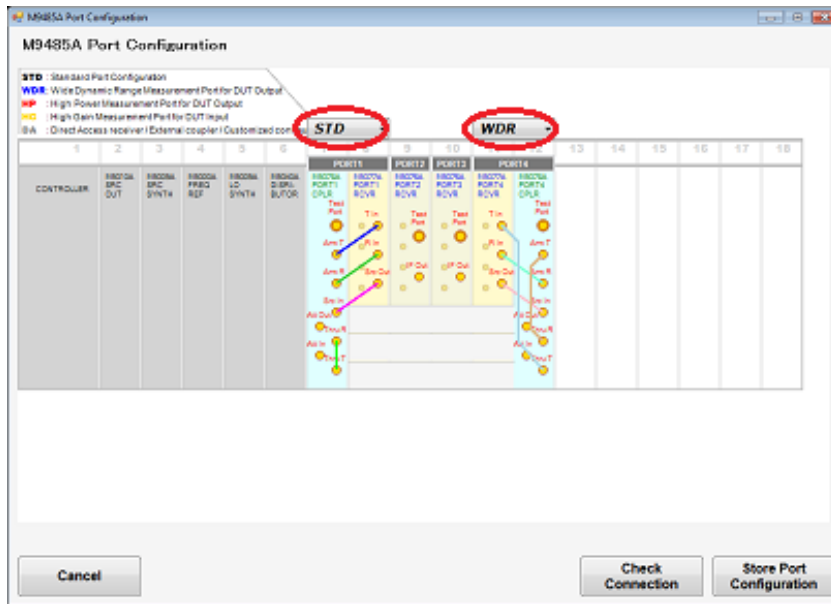

4. Cable Connections are displayed according to the selected configuration. Make or Confirm the cable connections.

Connection Check

After the port configuration selection, a connection check is recommended to execute. A thru cable is required.

1. Click Check Connection button.
2. The figure of block diagram is displayed.
3. Select two ports from your installed module for connection check.

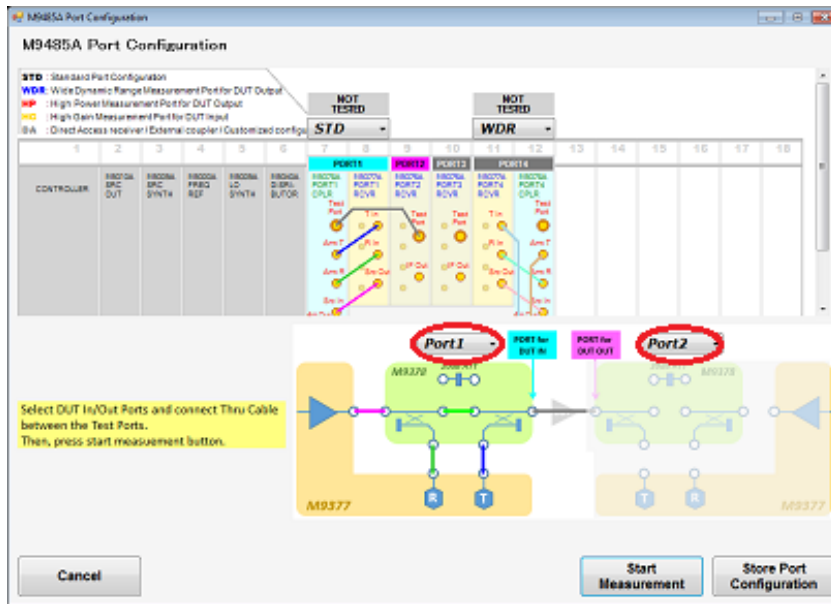

4. Connect the thru cables between the selected two ports. The required connection is displayed at the figure of modules.
5. Click Start Measurement .
6. If test is failed, confirm if the connection is correct.
7. Select the other ports for next connection check.
8. Continue until the connection for all ports are confirmed.

Port Configuration Setting Save

After port configuration selection and a connection check, port configuration setting must be stored.

1. Click Store Port Configuration button.

System Power Calibration is recommended to execute after the port configuration setup.

If the port configuration information is not saved, the M9485A SFP shows a warning at the message area that is "there is no configuration information and port powers are not accurate".

When you change the configuration, the Port Configuration Wizard should be executed.

VNA SFP Launcher

The VNA SFP (Soft Front Panel) is unique in that this software IS the firmware that runs the hardware. It does not send programming commands to the instrument, but instead communicates directly with the module hardware. It is a complete, FULL-FEATURED software package. This is a subtle difference, but has implications on how you will configure and connect to the VNA modules.

See Also: [Programming the PXIe/USB VNA](#).

In this topic:

- [How to start the SFP Launcher](#)
 - [M9485A](#)
 - [Multiport and Multisite Configuration](#) (separate topic)
-

How to start the SFP Launcher (All PXIe/USB VNA but M9485A)

Note: The minimum version of the Keysight I/O libraries required for the P937xA is 18.1.22916. Download the latest version from <http://www.keysight.com/find/iolibs>.



Click  on the host controller desktop to start the VNA Soft Front Panel (SFP).

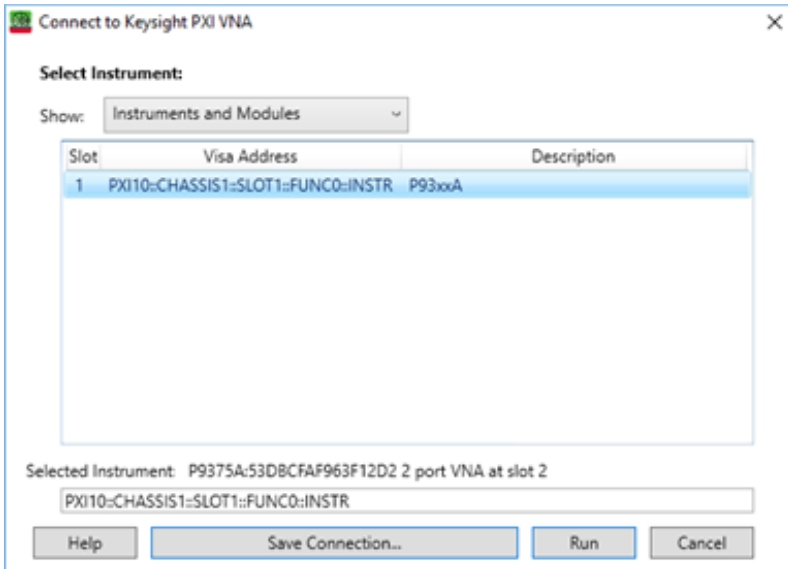

Select the modules to comprise the VNA.

Note: (USB VNA) When the connected unit is not displayed, reboot PC.

Learn how to configure [Multiport and Multisite Configuration](#).

Function	Description
	Select Instruments and Modules, Modules, or Saved Instruments.
	A list of the displayed Instruments and Modules is filtered by the following selection mode.
Show dropdown menu	<ul style="list-style-type: none"> • Instruments and Modules – shows both of Saved Instruments and Modules • Modules – shows the supported modules found through VISA discovery • Saved Instruments – shows the name of saved instruments (which are defined by saving a configuration into IVI Configuration Store)
Help	Open Help
Run	Launch SFP with the configuration of the selected instrument.
	Open “Save Instrument Connection” dialog. The configuration of the currently selected modules is saved into IVI Configuration Store as the specified name.

Save Connection...

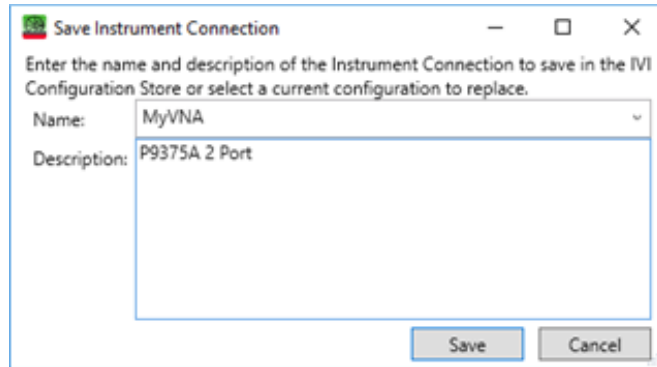

Note:

When you encounter the error "IviConfigServer.IviConfigStore.1: Serialized failed..." at clicking "save",

- Run the VNA SFP launcher as administrator.
- Add a write permission to the iviConfigurationStore.xml file after the IO library installation.

Delete the selected instrument definition.

Delete Saved Connection...

(When one of the saved instruments is selected in the displayed list, "Delete Saved Connection..." button appears instead of "Save Connection..." button.)

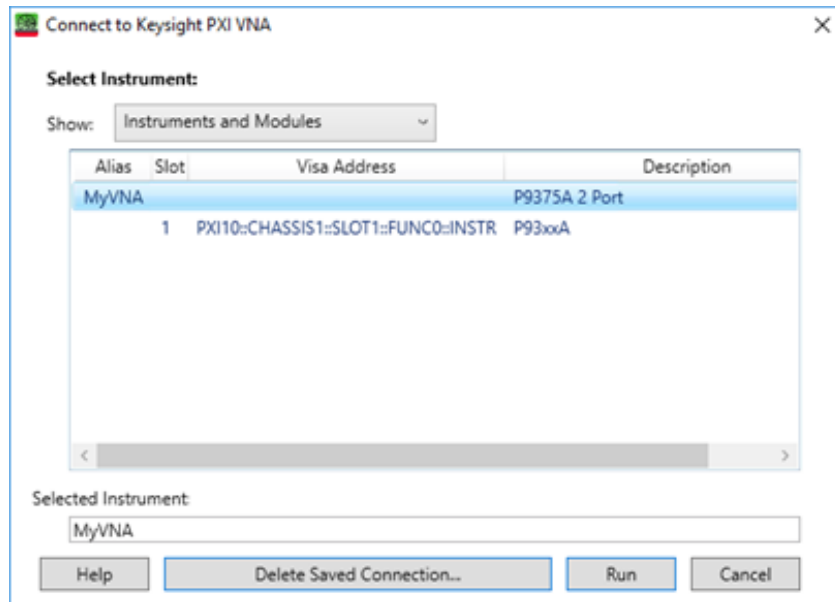

The launcher can be executed by the following two method as well.

- **Keysight IO Libraries** (Keysight Connection Expert). This method can start only a single module.

- **Command Prompt:** This method does not allow the use of an alias, but ONLY the PXI VISA address. To do this, run 835x.exe with the PXI instrument name as the only argument. The following are TWO examples:

- C:\program files (x86)\agilent\network analyzer\835x.exe
PXI14::0::0::INSTR;PXI10::0::0::INSTR **or**
- C:\program files (x86)\agilent\network analyzer\835x.exe
PXI0::CHASSIS1::SLOT6::FUNC0::INSTR;PXI0::CHASSIS1::SLOT7::FUNC0::INSTR

M9485A



- Click  on the host controller desktop to start the PXIe VNA Soft Front Panel (SFP).

The following modules are required to run the application.

- One M9300A Reference Module
- One M9310A Source Output Module
- Two M9309A Synthesizer Modules (One is for the source signal; another is for the local signal)
- One M9340A Distributer Modules for 1 chassis configuration. Four M9340A.Distributer Modules for 2 chassis configuration
- At least two of M9376A or M9377A Modules. (Number of modules should be even).

Function	Description
Show dropdown menu	<p>Select Instruments and Modules, Modules or Saved Instruments.</p> <p>A list of the displayed Instruments and Modules is filtered by the following selection mode.</p> <ul style="list-style-type: none"> • Instruments and Modules – shows both of Saved Instruments and Modules • Modules – shows the supported modules found through VISA discovery • Saved Instruments – shows the name of saved instruments (which are defined by saving a configuration into IVI Configuration Store)

When the modules cannot be detected, see the [Troubleshooting Hint for M9485A](#).

Help	Open M9485A Help
Run	Launch SFP with the configuration of the selected instruments. Open “Save Instrument Connection” dialog. The configuration of the currently selected modules is saved into IVI Configuration Store as the specified name.

Save Connection...

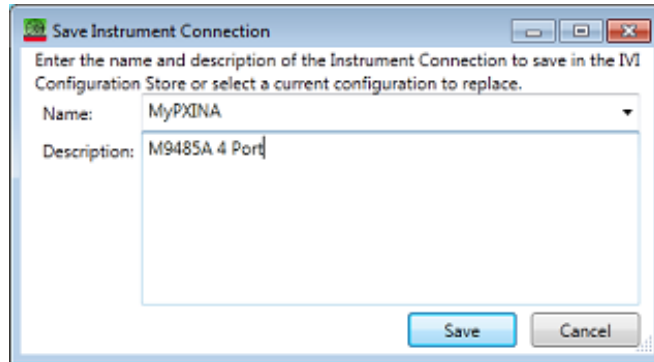

Delete Saved Connection...

(When one of the saved instruments is selected in the displayed list, “Delete Saved Connection...” button appears instead of “Save Connection...” button.)

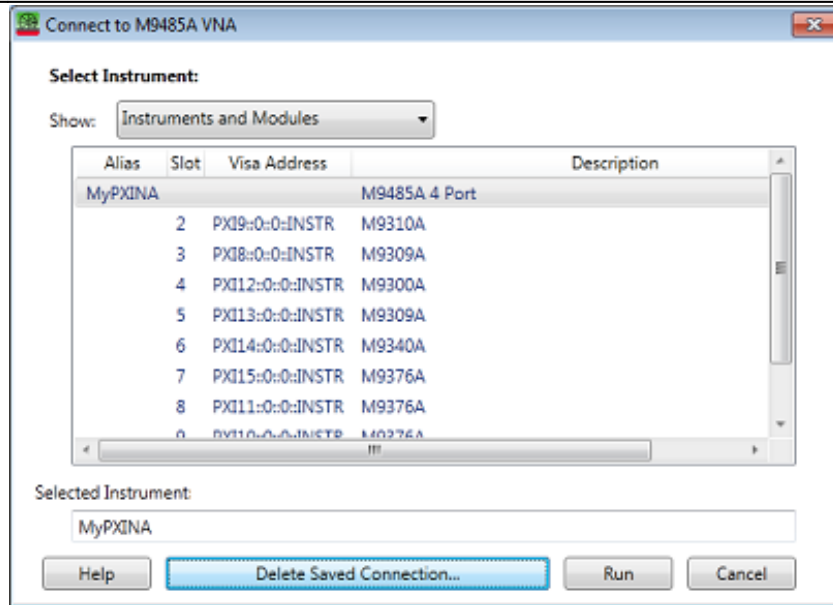

Delete the selected instrument definition.

Note:

- When multiple instruments are installed in the same PXI chassis and need run them, run the M9485A at the last. Otherwise M9485A measurement trigger may be terminated and VNA shows an error. You can recovery the error by closing error dialog and trigger the VNA again.
- Do not use sleep mode on PC. Confirm if Control Panel > Hardware and Sound > Power Options > Change when the computer sleeps > Put the computer to sleep is set at Never.

-When your OS is windows 8.1, the following setup is required.

1. Start Keysight Connection Expert
2. Click Manual Configuration tab
3. In "Add a LAN device" pane, set "localhost" for "Hostname or IP Address:" field. Select "HiSLIP" for "Set Protocol:" selection. Then press "Accept" button.
4. Confirm "Unknown Instrument, TCPIP::localhost::hislip0::INSTR" Connection is available in "Instruments" tab.
5. Close the Connection Expert window and then run the Launcher.

PXIe VNA Front Panel Tour

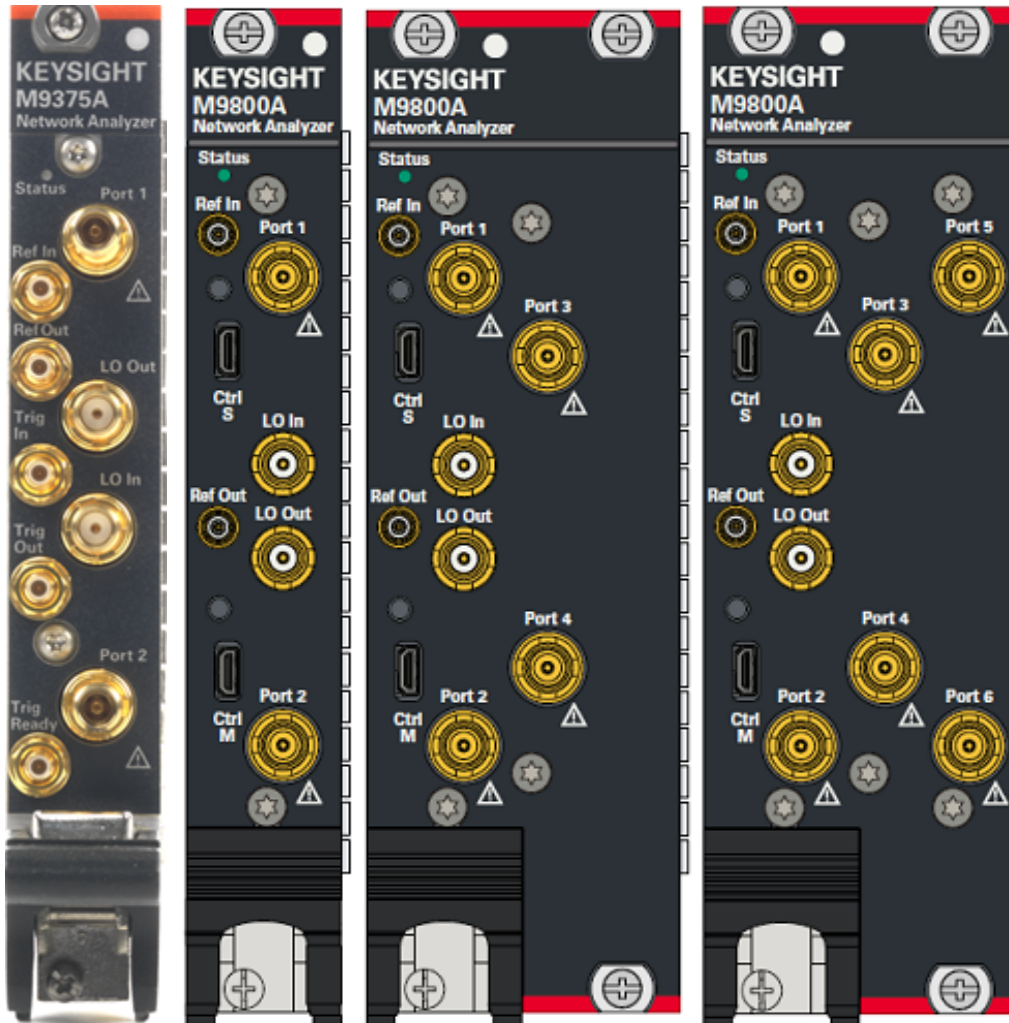

See Also

- [Soft Front Panel Tour](#)

Status LED

The following LED colors indicate the PXIe VNA status:

Green (solid) – Firmware is running but the PXIe VNA is NOT sweeping.

Green (blinking) - Each blink indicates a measurement sweep. The PXIe VNA may be sweeping faster than the indicator can blink.

Amber – Power is ON but the firmware is not running.

Red – A hardware error has occurred.

Off – Power is OFF.

Test Ports

All M937xA models are available with 2 test ports.

M980xA models are available with 2/4/6 test ports.

See [Specs](#) for more information about the Test port connectors and Input damage levels.

Ref In / OUT

IN When a 10 MHz external reference signal is detected at this port, it will be used as the instrument frequency reference instead of the internal frequency reference.

OUT This SMB(m) connector outputs a 10 MHz frequency reference signal for use by other modules and test equipment.

Note: To use an external reference signal, you must make a setting in the VNA application.

- From the soft front panel, click **Utility**, then **System**, then **Configure**, then check **External Reference**.
- From SCPI, use **SENS:ROSC:SOUR**

Trigger Lines (M937xA)

Trig IN When enabled, the module accepts signals on this connector which indicates that the external devices is ready to be triggered.

Trig OUT When enabled, the module outputs signals on these connectors either before or after a measurement.

Trig Ready When enabled, the module outputs a 'READY' signal on this connector to other devices. This indicates that the module is ready to be triggered.

[Learn more about External Triggering](#)

LO Out / LO In

For Daisy-chaining two or more modules. See the following information.

- M937xA Installation Guide.

- M980xA: <https://www.keysight.com/find/m980xa-mm/>

Ctrl M/Ctrl S (M980xA)

For Daisy-chaining two or more modules for multi-port or I/O adapter.

USB VNA Front Panel

P937xA



P50xxA 2 port



P5020A to P5024A 4 port

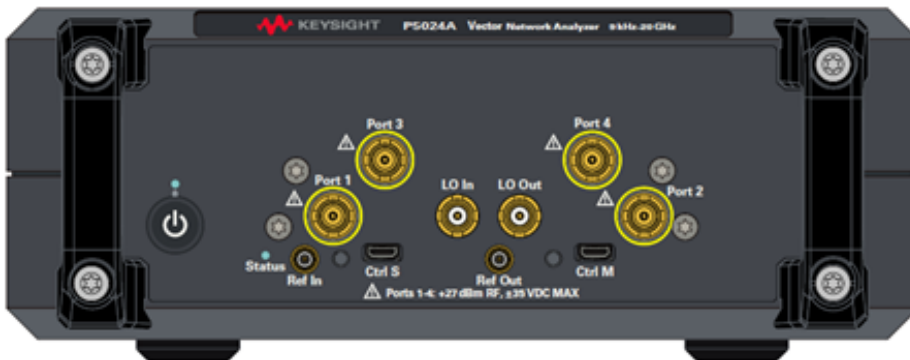

P5025A to P5028A 4 port

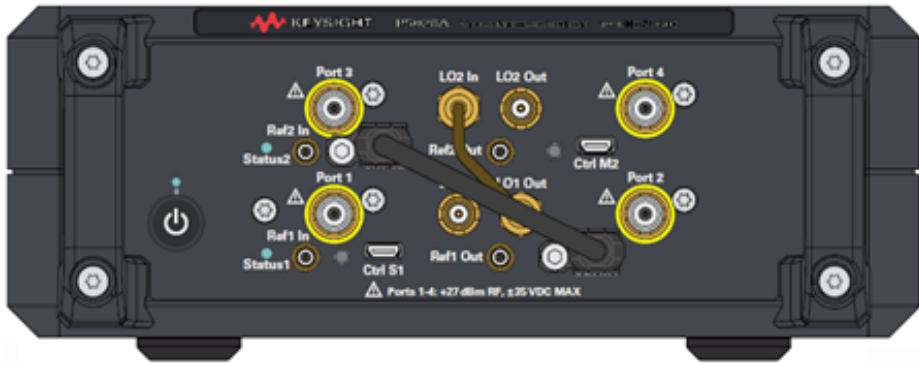

The LO cables and control cables must be connected as shown below.



P5020A to P5024 6 port



See Also

- [Soft Front Panel Tour](#)

Status LED

The following LED colors indicate the USB VNA status:

Green (solid) – Firmware is running but the USB VNA is NOT sweeping.

Green (blinking) - Each blink indicates a measurement sweep. The USB VNA may be sweeping faster than the indicator can blink.

Amber – Power is ON but the firmware is not running.

Red – A hardware error has occurred.

Off – Power is OFF.

Test Ports

All P937xA / P50xxA models are available with 2 test ports.

P502xA model is available with 4 or 6 ports.

See [Specs](#) for more information about the Test port connectors and Input damage levels.

Ref In / Out

Ref In When a 10 MHz external reference signal is detected at this port, it will be used as the instrument frequency reference instead of the internal frequency reference.

Ref Out This SMB(m) connector outputs a 10 MHz frequency reference signal for use by other modules and test equipment.

Note: To use an external reference signal, you must make a setting in the VNA application.

- From the soft front panel, click **Instrument**, then **Setup**, then **Internal Hardware**, then check **Ext Reference**.
- From SCPI, use **SENS:ROSC:SOUR**

Note: The P5025A to P5028A 4 port model has two set of reference In/Out ports on the front panel. Use Ref1 In and Ref1 Out.

Trigger Lines (P937xA)

Trig In When enabled, the module accepts signals on this connector which indicates that the external device is ready to be triggered.

Trig Out When enabled, the module outputs signals on these connectors either before or after a measurement.

Trig Ready When enabled, the module outputs a 'READY' signal on this connector to other devices. This indicates that the module is ready to be triggered.

[Learn more about External Triggering](#)

LO Out / LO In

For Daisy-chaining two units. See [Multiport and Multisite Configuration](#).

The P5025A to P5028A 4 port model has two set of LO Out/In ports on the front panel. You should connect the cable between LO1 Out and LO2 In. LO1 In and LO2 Out can be used for [IO adapter](#) and [Multiport and Multisite Configuration](#).

Ctrl M/Ctrl S (P50xxA)

For Daisy-chaining two units or [I/O adapter](#). See [Multiport and Multisite Configuration](#).

The P5025A to P5028A 4 port model has two sets of Ctrl M and Ctrl S ports on the front panel. You should connect the cable between Ctrl M1 and Ctrl S2. Ctrl S1 and Ctrl M2 can be used for [IO adapter](#) and [Multiport and Multisite Configuration](#).

IO Module Front Panel

PXI I/O module M9341A/B can work with both M937xA and M9485A.

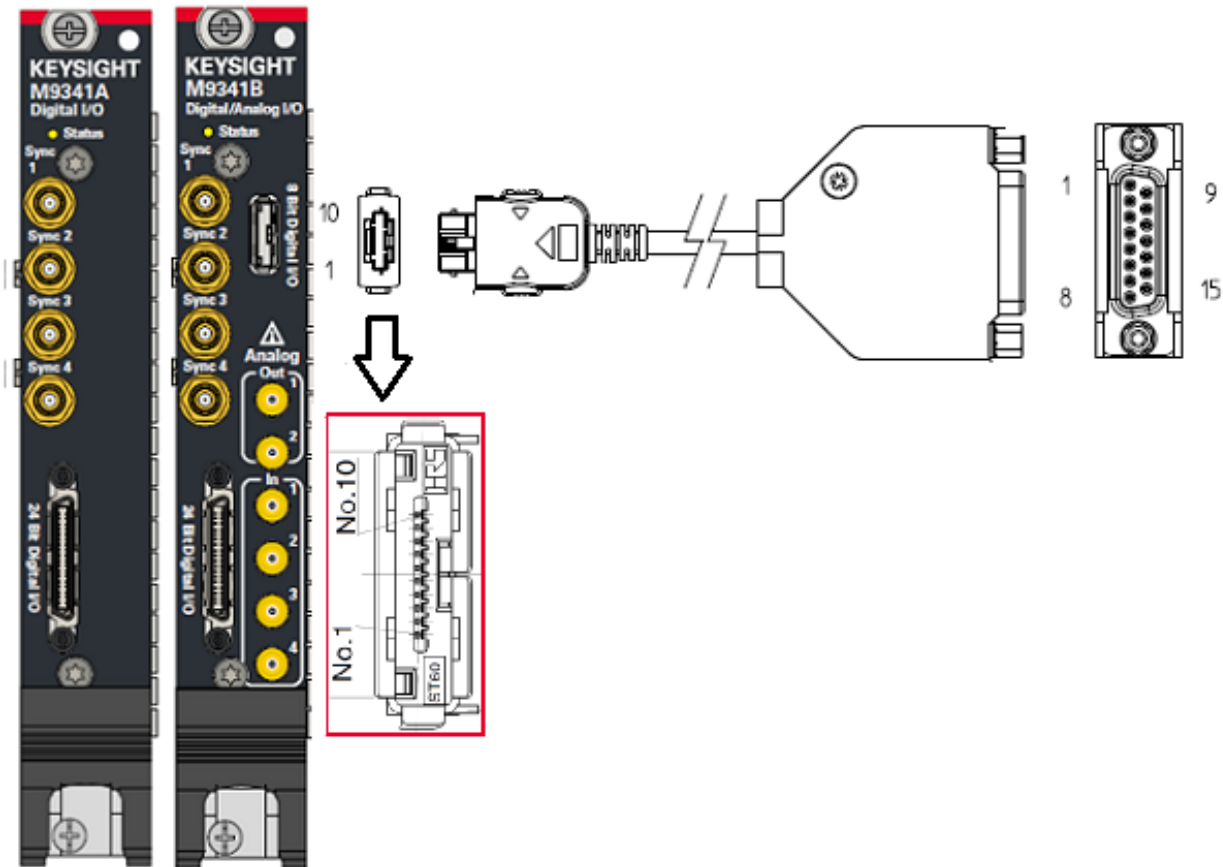

24 Bit Digital I/O

See [Material Handler Interface](#) for pin assignment

8 Bit Digital I/O

The ST40X-D sub 15 conversion cable is furnished with the M9341B option 001 Interface cables for M9341B. See [DUT Control and 8 bit Digital I/O](#).

ST40X Pin No.	D sub 15 Pin No.	Pin Description
1	1	Data 1 (PIO1)
2	2	Data 2 (PIO2)
3	3	Data 3 (PIO3)
4	4	Data 4 (PIO4)
5	5	Data 5 (PIO5)
6	6	Data 6 (PIO6)
7	7	Data 7 (PIO7)
8	8	Data 8 (PIO8)
-	9	N/A
-	10	N/A
-	11	N/A
9	12	Vout
-	13	N/A
-	14	N/A
10	15	GND

Note for Vout

Vout can supply the source up to 100 mA.

This circuit does not sink the current. Hence, when the voltage setting of Vout is changed, it may take time until the voltage reaches the setting value. The following figure shows the circuit diagram of Vout and Data on 8 bit digital I/O.

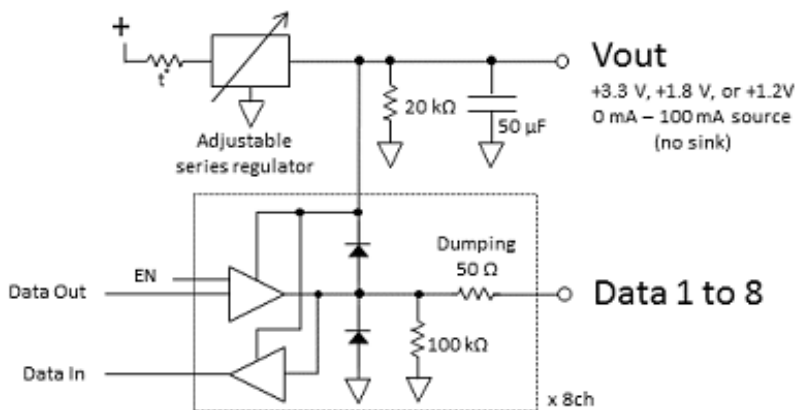

Screen Tour

Click on image areas to learn more.

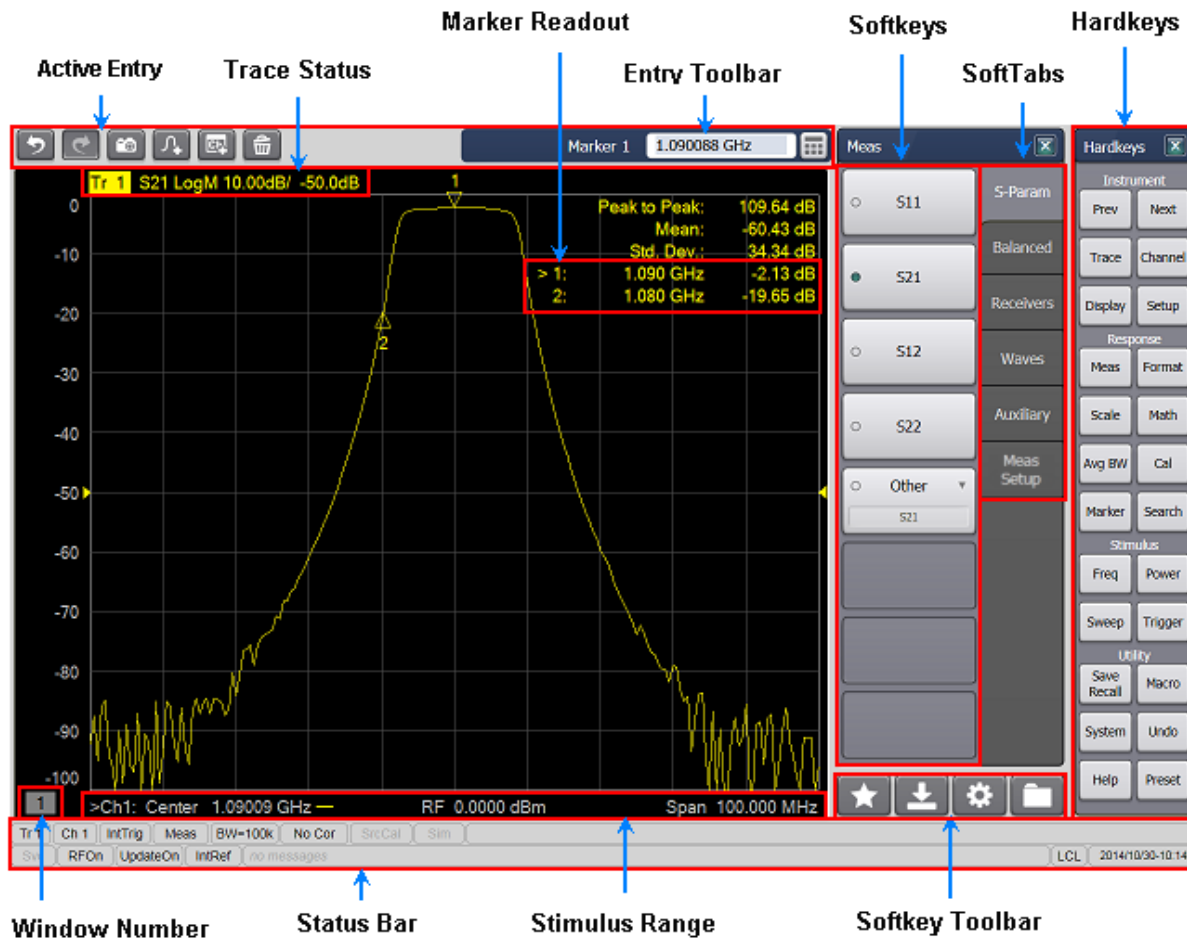

See Also

- Marker Drag
- Expanded Mouse capabilities
- Learn how to Customize the Screen

Active Entry

Allows you easily select the tools. [Learn more](#).

Trace Status

Provides details of each trace in the window. Highlighted trace indicates the active trace. [Learn more](#).

Entry Toolbar

Along with the softkeys, allows numeric values to be entered for settings. [Learn about all toolbars](#).

Marker Readout

Provides stimulus and response information for markers. [Learn about customizing the marker readout area](#). See also [Marker Drag](#).

Softkeys

The combination of hardkeys and softkeys allows easy access to all VNA features without a mouse.

SoftTabs

Pressing these tabs will display corresponding softkeys.

Hardkeys

Performs interface operations that are equivalent to those of keys in the INSTRUMENT keys, RESPONSE keys, STIMULUS keys and UTILITY keys on the front panel of VNA. [Learn more](#).

Window Number

Provides window identification which is useful for remote programmers.

Status Bar

Provides detail about all aspects of the status of the analyzer. [Learn more](#).

Stimulus Range

Displays the start and stop values of the sweep range.

Softkey Toolbar

These icons provide shortcuts to quickly select the softkey tools. [Learn more](#).

Marker Drag

Drag a displayed marker across the trace using a r mouse. [Learn more.](#)

Expanded Mouse Capabilities

- Cursor changes to a “hand” when hovering over a clickable object.
- Right-click on the Entry toolbar to launch a mouse-compatible numeric pad.

Windows

- Right-click or long press on a window area to make selections pertaining to that window.
- Double-click on a window area to maximize the window. To return to original window configuration, right-click on window area, then click **Tile** .
- Left-click on **X-axis** annotation to select the active channel/trace.
- Right-click on **X-axis** annotation and click **Start/Stop/Center** to change stimulus properties. Applications are not fully supported.
- Quickly change Scale, Reference Level, and Position. [Learn how.](#)
- Right-click on **Y-axis** annotation and click **Scale** to change Scale.
- Drag a trace from one window to another. Click or touch either the trace or the Trace Status . Drag the trace to another window, then release the mouse or lift your finger.

Traces

- Left-click a trace or Trace Status to make it the selected trace.
- Double-click on a trace or Trace Status to maximize the trace. Double-click again to return to the original trace configuration.
- Set a preference to **always** widen the active trace.
- Set a preference to **briefly** widen the active trace.
- Drag a trace from one window to another. Click or touch either the trace or the Trace Status . Drag the trace to another window, then release the mouse or lift your finger.

Markers

- Right-click on a trace or Trace Status to add a marker.

- Right-click a marker to make selections pertaining to that marker, such as Marker Search or Function.

Softkeys

- Use the Touchscreen or adjacent buttons to select from eight dynamic softkey menu choices.
- To Show the softkeys, press any front-panel hardkey and the corresponding softkey menu will be launched.

Softkey Annotations

Item	Description
Menu ...	Selection launches a dialog box.
Menu ▾	Selection launches another level of softkeys.
Item <input checked="" type="checkbox"/>	Indicates the item (marker, trace, window) is ON. Any number of objects can be ON.
Item <input type="checkbox"/>	Indicates the item (marker, trace, window) is OFF. Click to turn item ON.
Item <input checked="" type="radio"/>	Indicates the item IS selected.
Item <input type="radio"/>	Indicates the item is NOT selected. Click to select. Only one item in the collection can be ON.
* Item	Enter value in Entry toolbar.
Item on OFF	Capitalization indicates the current setting.

USB VNA Rear Panel



USB Hub

This USB hub contains two USB ports to power VNA peripherals.

USB 3.0 SuperSpeed Device [Learn more](#)

A USB 3.0 cable is required for USB 3.0 speeds. A USB 3.0 SuperSpeed A-to-C cable is shipped with the USB VNA.



10 MHz In/Out

Note: (M980xA/P50xx) Use the front panel connector for reference signal. Do not use those connectors.

The 10 MHz reference clock source can be set to use the **Internal** clock or an external clock source connected to the rear panel **10 MHz In** connector. The reference clock can be configured using the USB Chassis SFP.

Power

See Specifications

Trig 1/Trig 2

The Trig 1 and Trig 2 connectors are trigger ports that can be configured to receive an input or send an output trigger signal and can be assigned to any one of eight trigger lines (PXI0 through PXI7). Trig 1 and Trig 2 are controlled using the USB Chassis SFP.

Security Lock

Secure a keyed cable to the security lock on the USB VNA to prevent theft.

Traces, Channels, Windows, and Sheets on the Analyzer

It is critical to understand the meaning of the following terms as they are used on the analyzer.

- [Traces - Managing \(Trace Manager\)](#)
- [Channels - Managing](#)
- [Windows - Managing](#)
- [Sheets - Managing](#)

Other Quick Start topics

Traces

Traces are a series of measured **data points**. There is no theoretical limit to the number of traces. However, the practical limit is the **maximum number of windows** times the maximum number of traces per window (**24**).

In addition, one memory trace can be stored and displayed for every data trace. [Learn more about Math / Memory traces.](#)

Trace settings affect the presentation and mathematical operations of the measured data.

The following are Trace settings:

- [Parameter](#)
- [Format and Scale](#)
- [Smoothing](#)
- [Correction ON / OFF](#)
- [Electrical Delay](#)
- [Phase Offset](#)
- [Trace Math](#)
- [Markers](#)

- **Time Domain** (Opt S93010A/B/010)

Managing Traces

- How to **Add** a trace
- How to **Select** a trace
- How to **Delete** a trace
- How to **Move** a trace
- How to **Maximize** a trace
- How to perform **Trace Hold** (Max or Min)
- How to **Create** a new trace
- How to **Change** the trace parameter
- How to display a custom **trace title** (separate topic)
- How to display a **wide** active trace (separate topic)

How to Add a trace

The only measurements that can be selected are those in the same measurement class as is currently assigned to the channel. To select a measurement other than these, first select the appropriate measurement class to a new or existing channel. [Learn how.](#)

A trace must be selected (active) before its trace settings can be changed.

How to know which trace is Active?

Using **Hardkey/SoftTab/Softkey**

1. For Traces 1-7, press **Trace** > **Trace 1-7** > click left side **Trace 1-7** small button

Using a mouse

1. Right click in the grid box and then select

(Example: Click on left side Trace 1 small button and Trace 1 is active when it turns green, so Trace 1 added).

2. For Traces 8-15, press **Trace** > **Trace 8-15** > click left side **Trace 8-15** small button

New Trace....

(Example: Click on left side Trace 9 small button and Trace 9 is active when it turns green, so Trace 1 is added).

3. Another method of adding traces is by pressing **Trace** > **Trace 1-7** > **New Traces....**
4. For other traces numbers, press **Trace** > **Trace Setup** > **Add Trace**, then select **New Trace**, **New Trace + Channel**, **New Trace + Window**, **New trace + Channel + Window**, or **New Traces....**

Programming Commands

How to Select a Trace

The only measurements that can be selected are those in the same measurement class as is currently assigned to the channel. To select a measurement other than these, first select the appropriate measurement class to a new or existing channel. [Learn how.](#)

A trace must be selected (active) before its trace settings can be changed.

How to know which trace is Active?

Using **Hardkey/SoftTab/Softkey**

1. Press **Trace** > **Trace Setup** > **Select**.
2. Select a trace number which corresponds to the desired measurement parameter.

Using a mouse

1. Click on **Trace Status** label of any trace above the grid box.

Programming Commands

How to Delete a Trace

Using **Hardkey/SoftTab/Softkey**

1. For Traces 1-7, press **Trace** > **Trace 1-7** > click left side **Trace 1-7** small button

Using a mouse

1. Right-click the **Trace Status** label above the grid box, then click **Delete**

(Example: Click on left side Trace 1 small button and Trace 1 is inactive when it is not green).

2. For Traces 9-16, press **Trace** > **Trace 8-15** > click left side **Trace 8-15** small button

Trace.

(Example: Click on left side Trace 9 small button and Trace 9 is inactive when it is not green).

3. For other traces numbers, press **Trace** > **Trace Setup** > **Delete Trace**, then select a trace number.

Programming Commands

How to Move a trace to a different Window

You can **DRAG** a trace from one window to another, or...

Using **Hardkey/SoftTab/Softkey**

1. Press **Trace** > **Trace Setup** > **Trace Manager...**
2. Under the Window Column, reassign the active trace to another window number at the pulldown then click OK.

For some models

1. Press **Trace** > **Trace Setup** > **Move Trace....**
2. Select a window number in the following dialog, and then click OK.

Using a mouse

1. Right-click the **Trace Status** label above the grid box, then click **Trace Manager...**
2. Under the Window Column, reassign the active trace to another window number at the pulldown then click OK.

For some models,

1. Right-click the **Trace Status** label above the grid box, then click **Move Trace....**
2. Select a window number in the following dialog, and then click **OK**.

Programming Commands

Trace Manager dialog box help

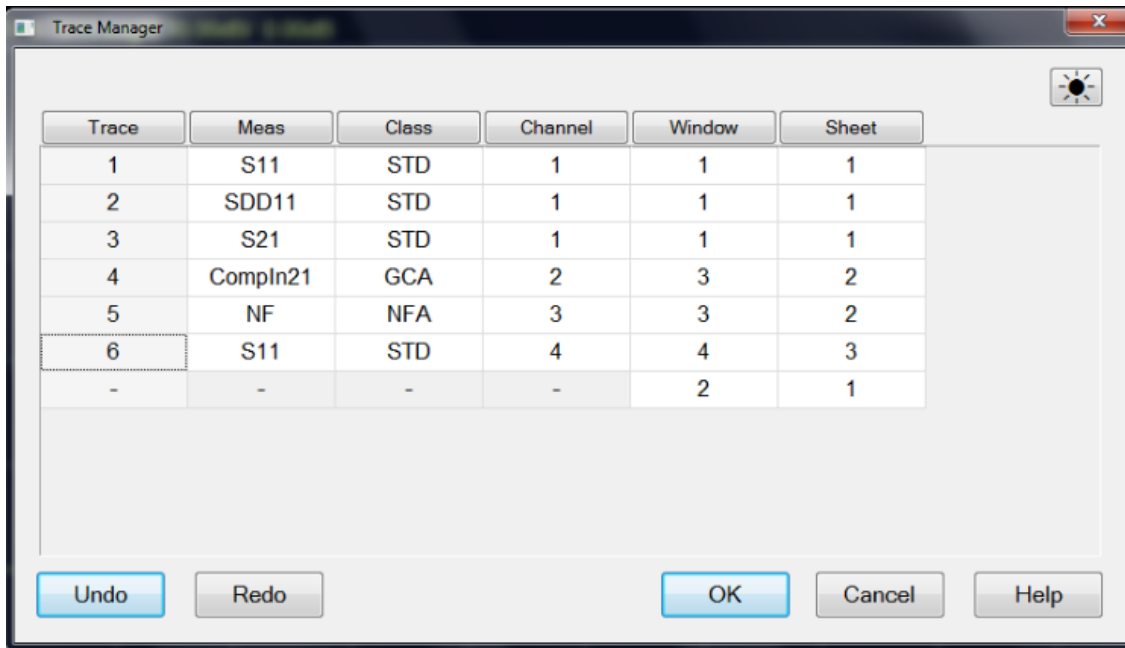

Trace Manager allows the user to see and modify all traces/channels/windows/sheets/formats in one table. The changes are updated immediately.

There is one row for each trace. By Clicking on a column heading will display the rows in ascending or descending order as defined by that column.

A row is selected by clicking on any cell in the row and the popup menu for the cell will appear. Multiple rows can be selected by click-drag-release. All selected rows will be highlighted and popup menu for the column will appear.

Undo Reverse back to the previous settings

Redo Change the settings again

Trace Column

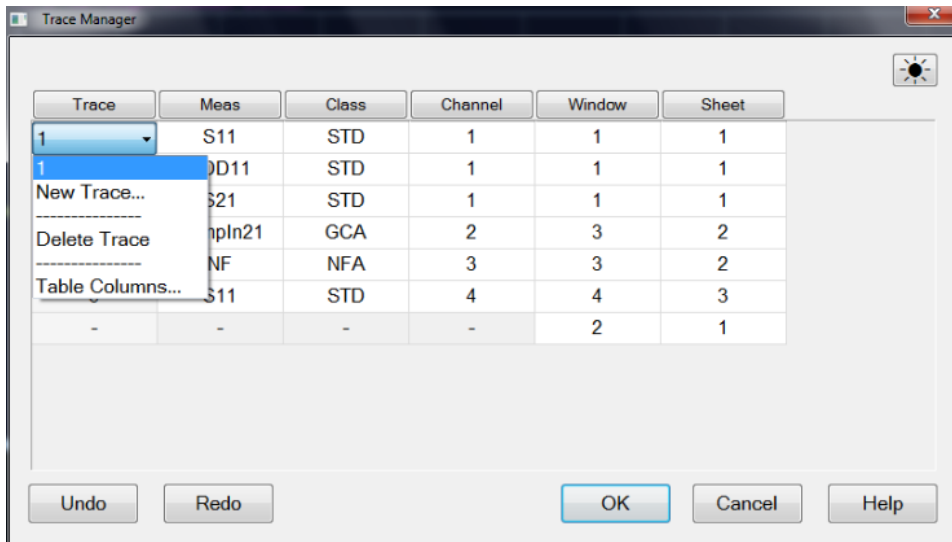

User is not able to edit trace numbers. User may select multiple rows; this allows user to delete multiple traces using the popup menu.

There is a special case where the trace entry in the row is empty. This is used to show when there is an empty window. If the users select this row and choose "Delete Trace", it will delete the empty window; this is a convenient feature; it is deleting a null trace.

New Trace To add a new trace. Selecting the cell will open the "Meas" dialog.

Delete Trace The selected trace will be deleted.

Table Columns A pop up dialog is opened which allows user to define the columns visible in the table. The default table column is: Meas/Class/Channel/Windows/Sheet.

Meas Column

Selecting the cell will open the "Meas" dialog. User cannot select multiple rows from a Meas cell.

Class Column

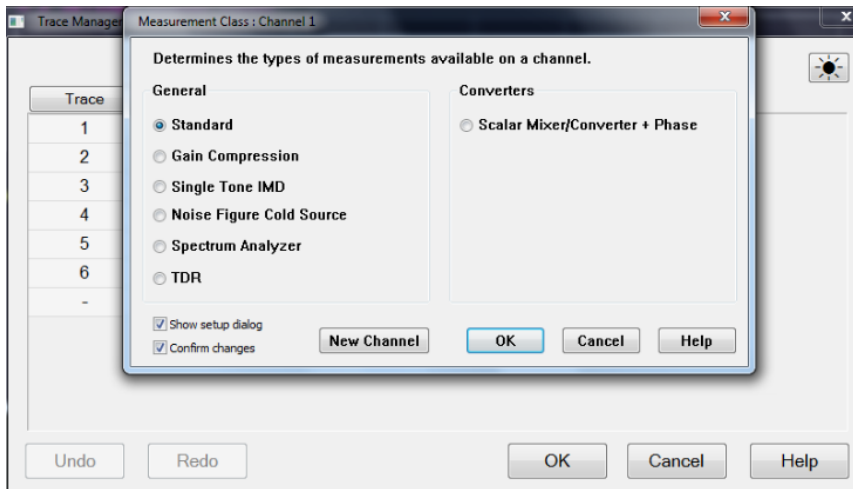

Selecting the cell will open the "Measurement Class" dialog. User cannot select multiple rows from a Class cell.

When the measurement class is changed, all traces numbers on the currently active channel will be assigned to the new measurement class. The window and sheet settings will be the same, but the "Meas" setting will be changed to default values for the selected class.

Channel Column

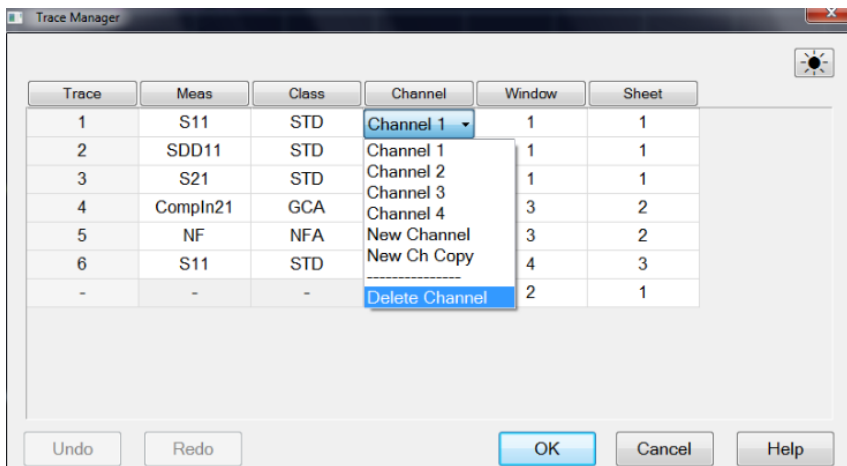

Selecting the cell will open a pulldown, and will select the row. User can click and drag to select multiple rows.

User may use the pulldown to reassign the active trace to another channel and delete the active channel.

When the channel for a trace is changed, the "Meas" setting will likely be changed.

Window Column

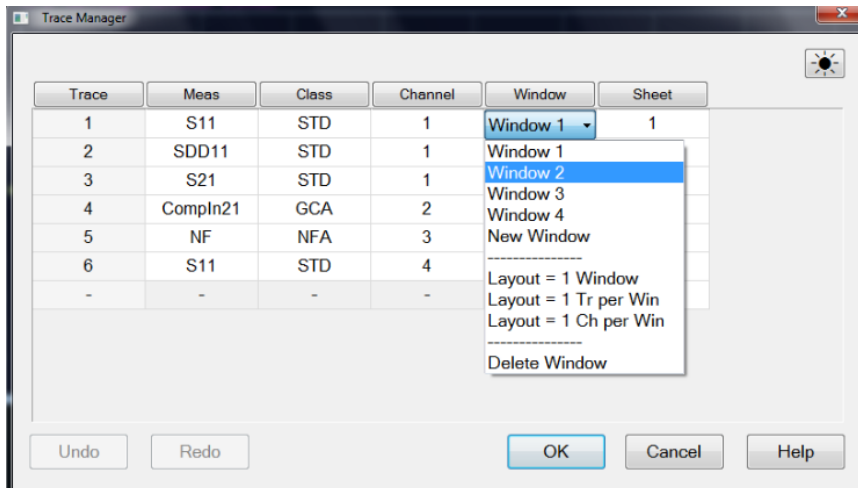

Selecting the cell will open a pulldown, and will select the row. User can click and drag to select multiple rows.

User may use the pulldown to reassign the active trace to another window, delete the active window and all traces on that window and change the layout of the windows.

If the active row has no trace assigned, then the window pulldown will not allow user to change the window number.

Sheet Column

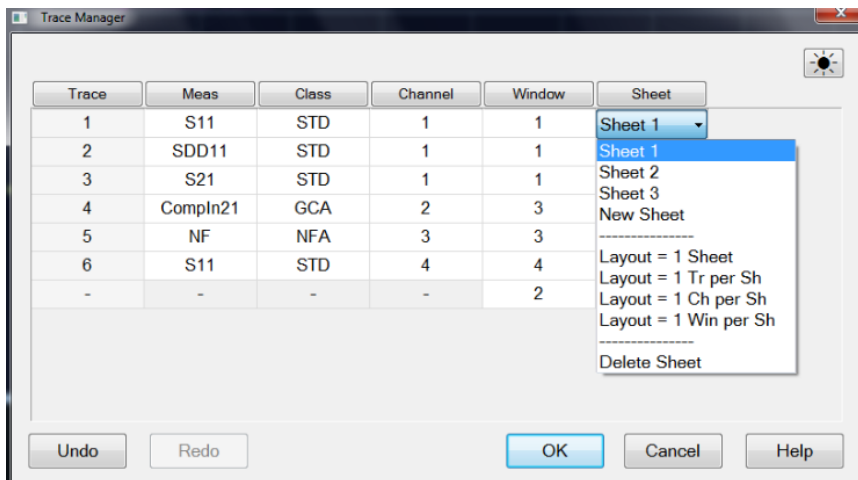

Selecting the cell will open a pulldown, and will select the row. User can click and drag to select multiple rows.

User may use the pulldown to reassign the active trace to another sheet, delete the active sheet and

all traces on that sheet and change the layout of the sheets.

If the active row has no trace assigned, then the sheet pulldown will not allow user to change the sheet number.

Format Column

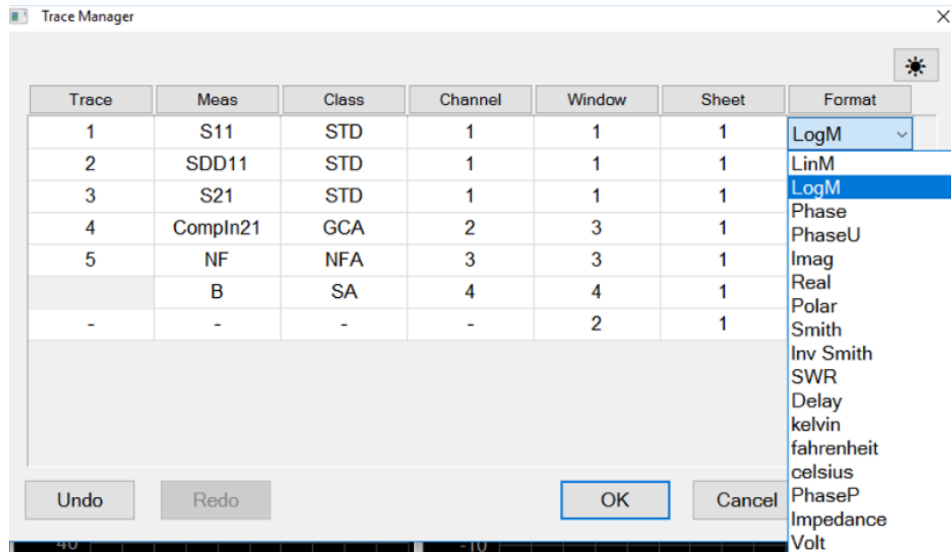

Selecting the cell will open a pulldown, and will select the row.

User may use the pulldown to select the trace formats. When the measurement class is SA, the selectable formats are only LinM and LogM.

Move Trace dialog box help (E5080A only)

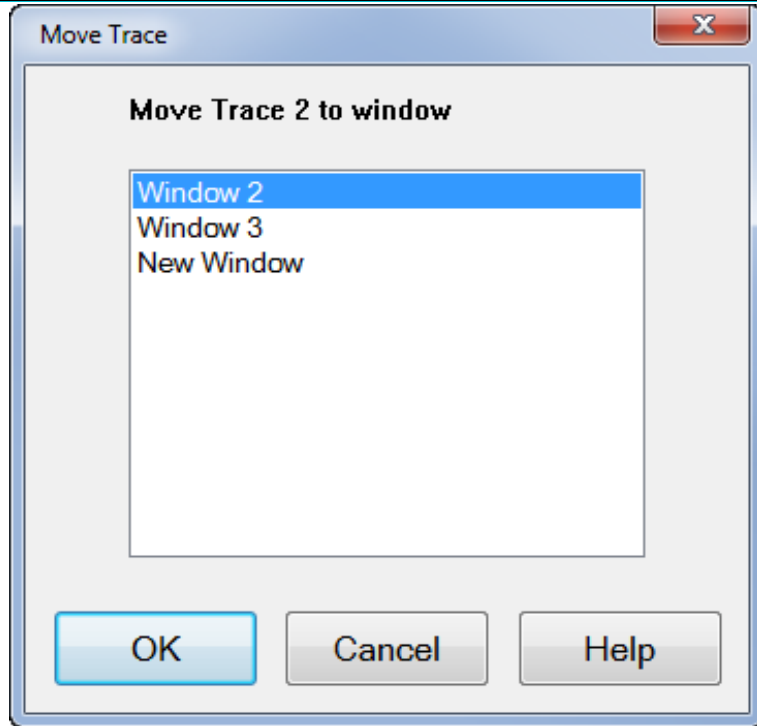

Note: Only ONE trace can be moved at a time.

1. Click the **Trace Status** label to select the trace to move.
2. **Move Trace N to window** - Transfer the selected trace to any Window listed or to a New Window.

Trace Max

How to maximize the active trace - the active trace is the ONLY trace on the screen display. All other traces are hidden.

Using **Hardkey/SoftTab/Softkey**

1. Press **Trace > Trace Setup > Trace Maximize (ON)**.
With Trace Max (ON), select a different trace to make that trace visible.
2. To make all traces visible again, select **Trace Maximize (OFF)**.

Using a mouse

1. Right-click the **Trace Status** label above the grid box, then click **Trace Maximize**.
2. Double click on the active trace to make all traces visible again.

Programming Commands

Trace Hold

How to hold the active trace at the maximum or minimum points.

Using **Hardkey/SoftTab/Softkey**

1. **Trace** > **Trace Setup** > **Trace Hold** > **OFF** | **Max** | **Min**.
2. **Restart** resets the trace.

Using a mouse

Not available

◀ Programming Commands ▶

Maximum/Minimum trace hold can be applied with several conditions:

- Feature is applicable to any data trace, but NOT to memory traces.
- When the stimulus or any data post processing setting is changed, the trace hold data will be reset. These settings include:
 - Smoothing on/off.
 - Smoothing Aperture.
 - Gating on/off.
 - Transform on/off.
 - Conversion state change, conversion type change.
 - Data Math Function (Data/Mem) change.
 - Equation Editor state change, formula change.
 - Parameter change.
 - Formatting change.
- Minimum/maximum comparison is done with formatted data. For Smith and Polar formats, absolute data is used and not phase.
- Trace hold data can be recalled.
- Data save files formats
 - SnP does NOT save trace hold data
 - Citifile, CSV, MDF, PRN DOES save trace hold data

Note: Citifiles can be recalled and viewed in the VNA.

- Use SCPI commands to get trace hold data. If trace hold is active, then the data returned from the remote interfaces will be the trace hold data.

Channels

Channels contain traces. The analyzer can have up to maximum **500 independent channels**.

Note: Actual maximum number of channel depends on the setup. A large number of NOPs and traces limit the maximum number of channel.

Channel settings determine **how** the trace data is measured . All traces that are assigned to a channel share the same channel settings. A channel must be selected (**active**) to modify its settings. To select a channel, click the **Trace Status** button of a Trace in that channel. The following are channel settings:

- **Frequency range**
- **Power level**
- **Calibration**
- **IF Bandwidth**
- **Number of Points**
- **Sweep Settings**
- **Average**
- **Trigger** (some settings are global)

Managing Channels

How to Select a Channel

A channel must be selected (active) before its settings can be changed.

To make a channel active, **select a trace** in that channel or click the **Trace Status** button of a Trace in that channel.

How to Add a channel

Using **Hardkey/SoftTab/Softkey**

1. Press **Channel** > **Channel 1-8** > click left side **Channel 1-8** small button

Using a mouse

Not available

(Example: Click on left side Channel 1 small button and Channel 1 is active when it turns green, so Channel 1 is added).

2. For other channel numbers, press **Channel** > **Channel Setup** > **Add Channel**, then select **New Trace + Channel** or **New Trace + Channel + Window**.

No programming commands are available for this feature

How to Delete a channel

Using **Hardkey/SoftTab/Softkey**

1. Press **Channel** > **Channel 1-8** > click left side **Channel 1-8** small button

Using a mouse

Not available

(Example: Click on left side Channel 1 small button and Channel 1 is inactive when it is not green).

- For other channel numbers, press **Channel** > **Channel Setup** > **Delete Channel**, then select a channel.

Programming Commands

Windows

Windows are used for viewing traces.

- The analyzer can show an **UNLIMITED** number of windows on the screen with the following limitations:
 - The **SCPI status register** can track the status of up to 576 traces.
- Each window can contain up to **24 traces**.
- Windows are completely independent of channels.
- See **Customize the analyzer screen** to learn how to make other window settings.

The following is a window containing two traces. Both traces use the same channel 1 settings as indicated by the annotation at the bottom of the window.

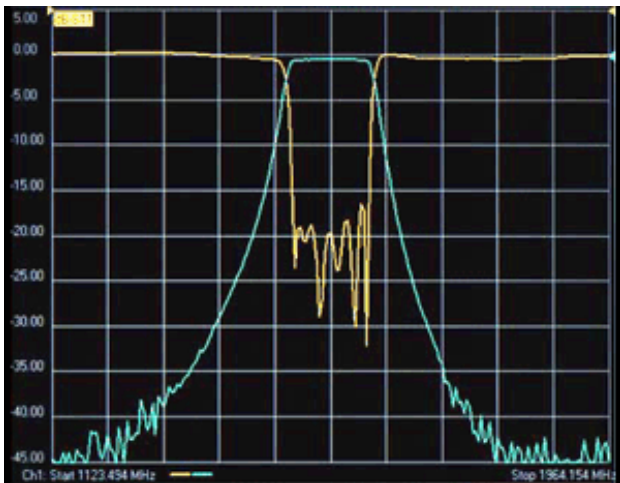

The window number shows in the lower-left corner of the window. The following shows window **5**.



Managing Windows

How to Add a window

Using **Hardkey/SoftTab/Softkey**

1. Press **Display** > **Window 1-8** > click left side **Channel 1-8** small button

Using a mouse

1. Right-click any area of grid box and then select **New**

(Example: Click on left side Window 1 small button and Window 1 is active when it turns green, so Window 1 is added).

Window.

2. For other windows, press **Display** > **Window Setup** > **Add Window**, then select **New Window**, **New Trace + Window**, or **New Trace + Channel + Window**.

Programming Commands

How to Delete a Window

Using **Hardkey/SoftTab/Softkey**

1. Press **Display** > **Window 1-8** > click left side **Channel 1-8** small button

Using a mouse

1. Right-click any area of grid box and then select **Close Window**.

(Example: Click on left side Window 1 small button and Window 1 is inactive when it is not green).

2. For other windows, press **Display** > **Window Setup** > **Delete Window**, then select a window.

Programming Commands

How to Move a Window to a different Sheet

Note: This feature is NOT available on M948xA and E5080A.

Using **Hardkey/SoftTab/Softkey**

1. Select a Window to move.
2. Press **Display** > **Window Setup** > **Move Window...**
3. Select a sheet number in the following dialog, and then click OK.

Programming Commands

Move Window dialog box help

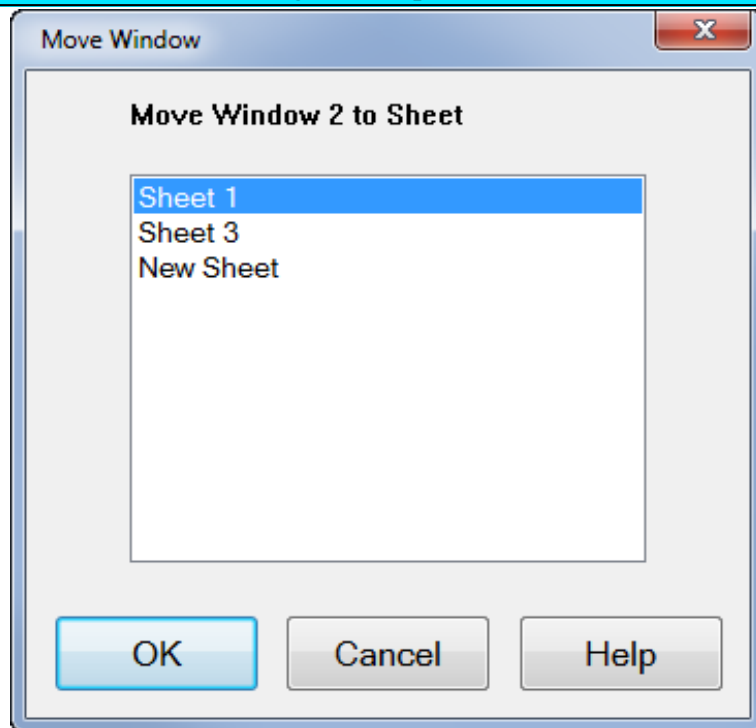

Note: Only ONE window can be moved at a time.

1. **Move Window N to Sheet N-** Transfer the selected window to any sheet listed or to a New Sheet.

How to Change Window Layout

Note: This feature is NOT available on M948xA and E5080A.

This is a window auto-layout option, for quicker selection instead of selecting the trace, channel, window and sheet separately. 7 auto-layout options are available.

Using **Hardkey/SoftTab/Softkey**

1. Press **Display** > **Window Setup** > **Window Layout**.
2. Select **1 Window**, **2 Windows**, **3 Windows**, **4 Windows**, **1 Trace per Window**, **1 Channel per Window**, or **Tile Windows**.

Programming Commands

How to maximize the active window - the active window is the ONLY window on the screen display. All other windows are hidden.

Using **Hardkey/SoftTab/Softkey**

1. Press **Display** > **Window Setup** > **Window Max (ON)**. With **Window Max (ON)**, select a different window to make that window visible.
2. To make all windows visible again, select **Window Max (OFF)**.

Using a mouse

1. Right-click in any area of the grid box and then select **Maximize**.

Programming Commands

Sheet

Sheets are used to group VNA windows. The sheet tabs provide an easy way to switch multiple display settings quickly.

Features and actions that can be performed with tabbed sheets:

- Add/Delete/Select sheet
- Move window to sheet
- Measurement can be performed on traces/channels in inactive sheets
- Easy setup for channel per window

- Easy setup for channel per sheet

Managing Sheet

How to Add Sheet

Using **Hardkey/SoftTab/Softkey**

1. Press **Display** > **Sheet Setup** > **Add Sheet**.
2. Then select one a **New Sheet, New Trace + Sheet** or **New Trace + Channel + Sheet**.

Using a mouse

1. Click on the sheet tab.

Programming Commands

How to Delete a Sheet

Using **Hardkey/SoftTab/Softkey**

1. Press **Display** > **Sheet Setup** > **Delete Sheet**.
2. Then select a sheet.

Using a mouse

1. Click on the sheet tab.

Programming Commands

How to View a Sheet

Using **Hardkey/SoftTab/Softkey**

1. Press **Display** > **Sheet Setup** > **Select**.
2. Then select a sheet.

Using a mouse

1. Click on the sheet tab.

Programming Commands

How to Change Sheet Title

Using **Hardkey/SoftTab/Softkey**

1. Press **Display** > **Sheet Setup** > **Sheet Title...**
2. In the pop up Sheet title box, enter the title and click OK.

Programming Commands

How to Change Sheet Layout

This is a sheet auto-layout option, for quicker selection instead of selecting the trace, channel, window and sheet separately. 4 auto-layout options are available.

Using **Hardkey/SoftTab/Softkey**

1. Press **Display** > **Sheet Setup** > **Sheet Layout**.
2. Select **1 Sheet**, **1 Trace per Sheet**, **1 Channel per Sheet**, or **1 Window per Sheet**.

Programming Commands

Quick Start Dialog

Quick start is a simple wizard which helps to setup the settings for typical measurements. This feature allows users to select from a set of pre-configured measurement layouts.

How to Open Quick Start Dialog Box

Using **Hardkey/SoftTab/Softkey**

1. Press **Setup** > **Main** > **Quick Start...**

◀ **Programming Commands** ▶

The measurement comprises the following THREE steps.

Step 1: Layout Templates

You are able to select a layout template for typical measurements.

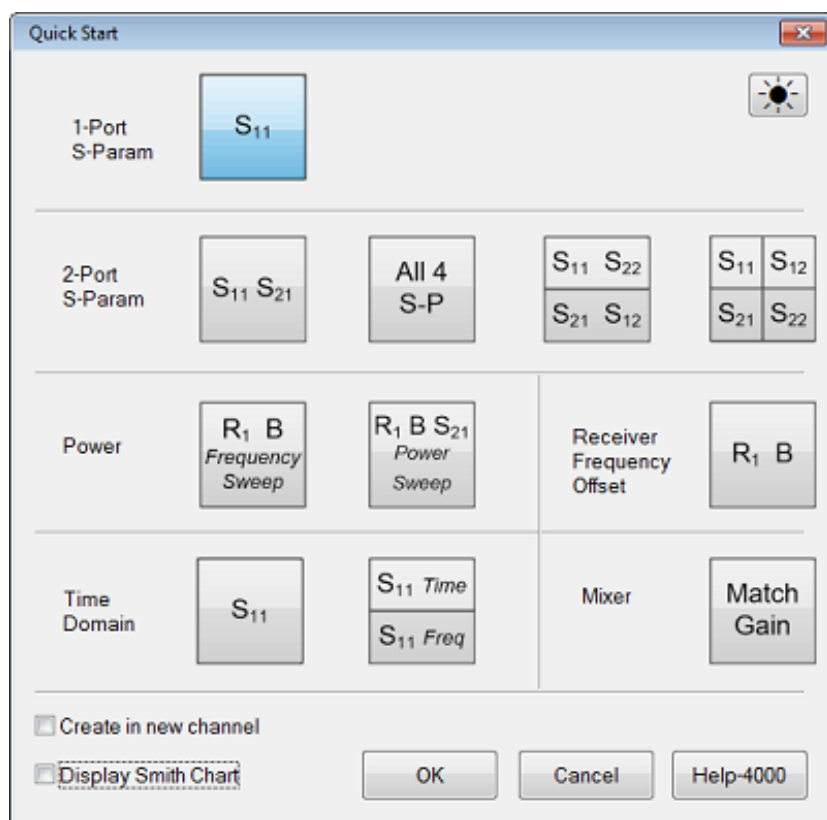

- ☑ If "**Create in new channel**" checkbox is enabled, a new channel and window(s) will be created.

If "**Create in new channel**" checkbox is disabled, when a template is selected then the active channel will be used for the new measurements. If the active trace is displayed in a window with traces on other channels, then the trace will be deleted and a new window(s) will be opened for the new measurements.

If "**Display Smith Chart**" checkbox is enabled, the active trace in a window will turn to display Smith Chart.

If "**Display Smith Chart**" checkbox is disabled, no changes on the active trace in a window.

Step 2: Stimulus Settings Dialogs

This step is used to set stimulus for the measurement.

Creates S11 and S21 measurements in a single channel and window.

Frequency Sweep Settings

Sweep

Start Frequency 10.000000 MHz

Stop Frequency 26.50000000 GHz

Center Frequency 13.255000000 GHz

Span Frequency 26.490000000 GHz

Sweep Type Lin Frequency

Power 0 dBm

IF Bandwidth 100.00 kHz

Number of Points 201

Calibrate this setup

OK Cancel Help

S-Parameters

Option
Required:
None

Enter:

- Start/Stop frequency
- Center Frequency
- Span Frequency
- Sweep Type: Lin or Log Frequency
- Power

- IF Bandwidth
- Number of Points

Learn more about [S-parameter measurements](#).

Creates Sdd11 and Sdd21 measurements in a single channel and window.

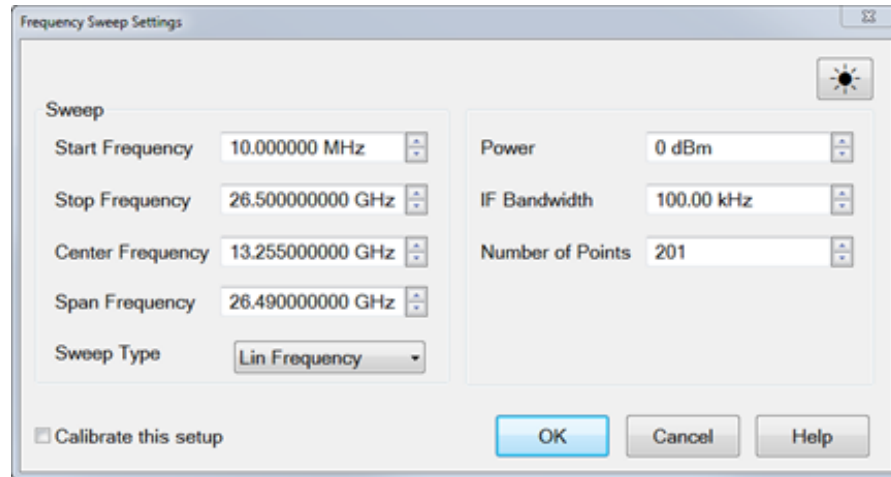

Differential

(Balanced)
Option
Required:
None

Enter:

- Start/Stop frequency
- Center Frequency
- Span Frequency
- Sweep Type: Lin or Log Frequency
- Power
- IF Bandwidth
- Number of Points

Learn more about [Differential \(Balanced\) measurements](#).

Creates R1 and B receiver measurements in a single channel and window. This allows you to view the DUT input power (R1) and output (B) power.

**Power
Frequency
Sweep**

Option
Required:
None

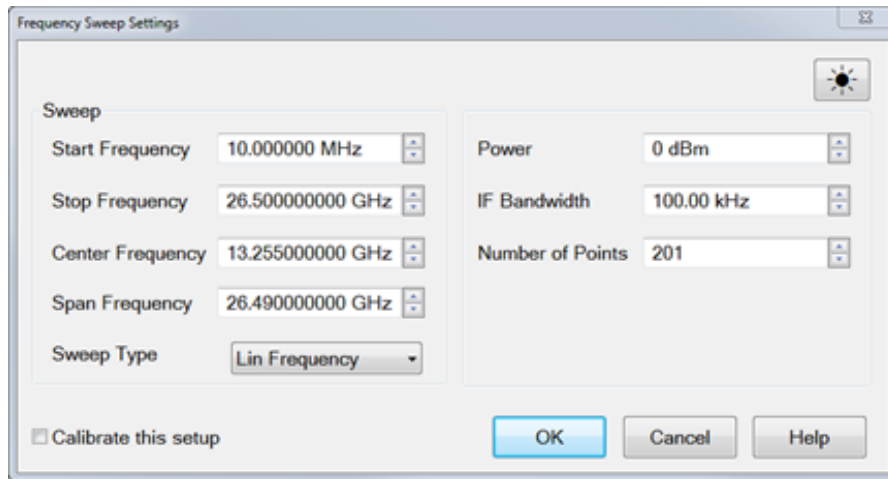

Enter:

- Start/Stop Frequency
- Center Frequency
- Span Frequency
- Sweep Type: Lin or Log Frequency
- Power
- IF Bandwidth
- Number of Points

Learn more about [Power Sweep measurements](#).

Creates a power sweep while viewing R1, B, and S21 measurements in a single channel and window. This allows you to view the DUT input power (R1), output power (B), and DUT gain (S21).

Power

Power Sweep

Option Required:
None

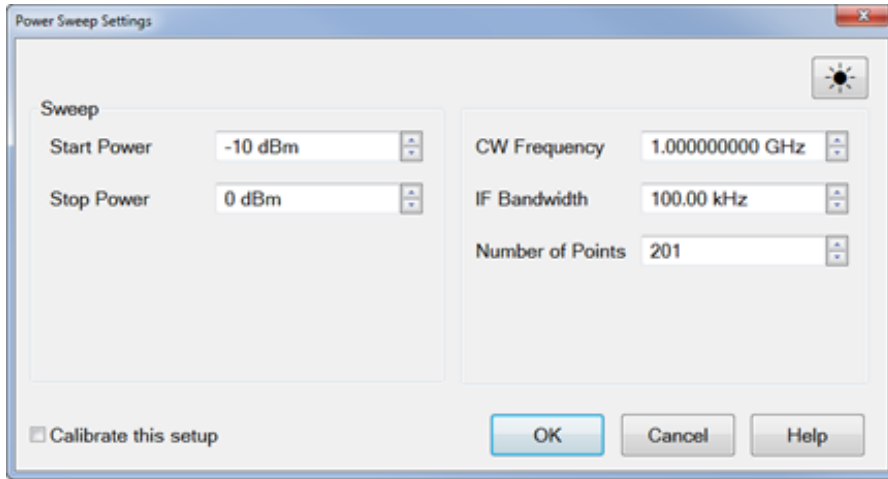

Enter:

- Start/Stop Power
- CW Frequency
- IF Bandwidth
- Number of Points

Learn more about [Power Sweep measurements](#).

Creates Frequency Offset Measurement while viewing R1 and B receivers in a single channel and window.

Receiver Frequency Offset

Option Required:

080

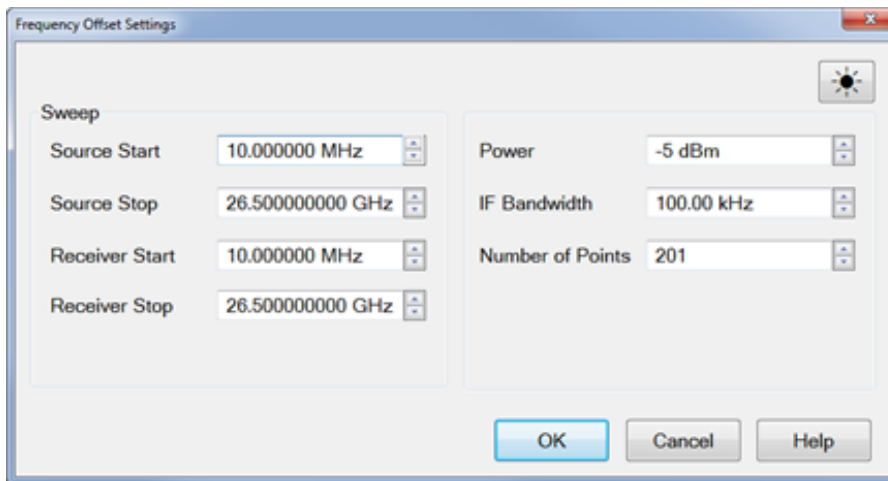

Enter

- Source Start

S97080A

- [Source Stop](#)
- [Receiver Start](#)
- [Receiver Stop](#)
- [Power Level](#)
- [IF Bandwidth](#)
- [Number of Points](#)

Learn more about [FOM](#).

Creates an S11 measurement and enables Time Domain.

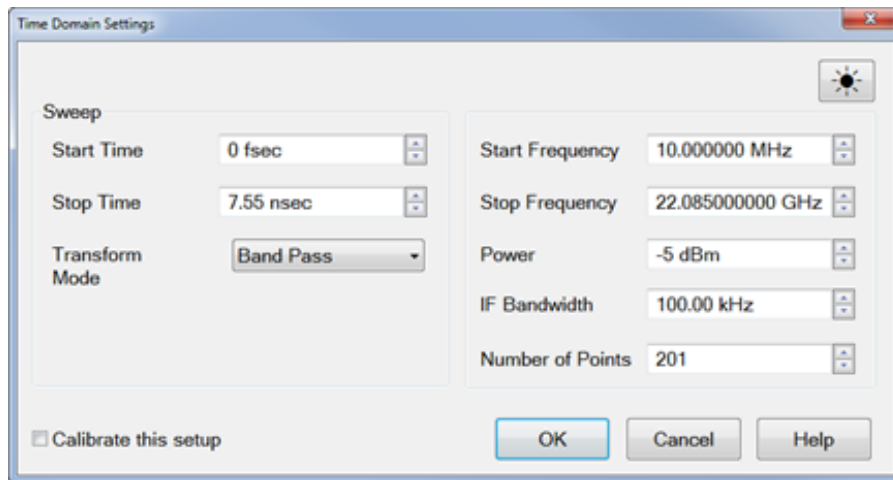

Time Domain

Option
Required:

010

S97010A

Enter:

- [Start/Stop Time](#)
- Transform Mode (Time Domain Settings dialog auto-select the start frequency if a LPF transform mode is selected.)
- [Start/Stop Frequency](#)
- [Power](#)
- [IF Bandwidth](#)
- [Number of Points](#)

Learn more about [Time Domain measurements](#).

If any one of the [SMC Measurements](#) is selected in Step 1, the Mixer

Quick Settings dialog will appear.

Mixer

Option
Required:

080

S97082A

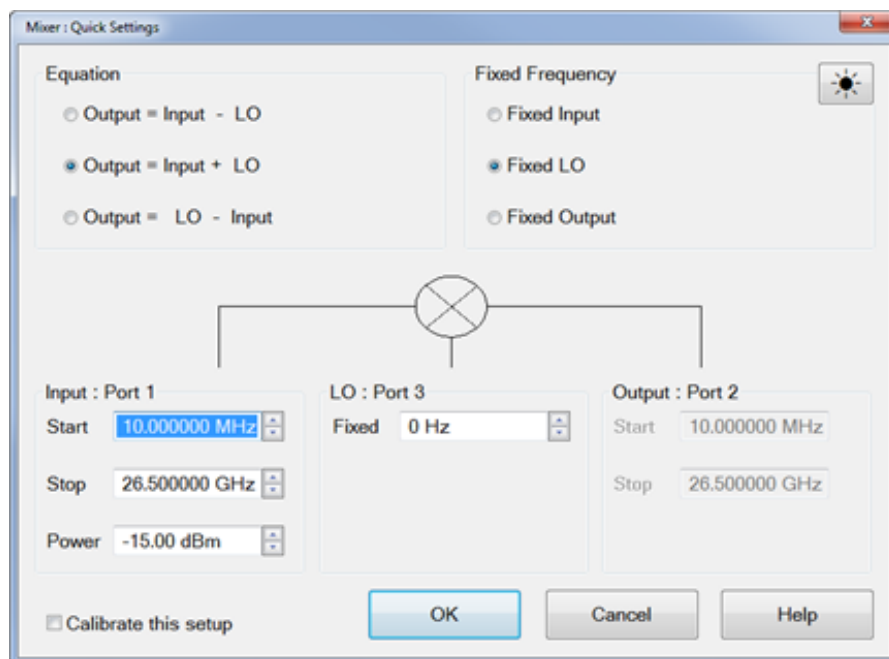

Enter:

- Equation: Output = Input - LO, Output = Input + LO, Output = LO - Input.
- Input, LO, and Output Frequencies and configuration.

Learn more about [SMC Measurements](#)

Steps 3: Cal Wizard Dialog (Optional)

If "**Calibrate this setup**" checkbox is enabled, the Cal Wizard Dialog will appear when Stimulus Settings Dialog is dismissed with the "OK" button.

If "**Calibrate this setup**" checkbox is disabled, the Cal Wizard Dialog will NOT appear.

Basic Measurement Sequence

The following process can be used to setup all analyzer measurements:

Step 1. Set Up Measurements

Reset the analyzer, create a measurement state, and adjust the display.

Step 2. Optimize Measurements

Improve measurement accuracy and throughput using techniques and functions.

Step 3. Perform a Measurement Calibration

Reduce the measurement errors by performing a calibration.

Step 4. Analyze Data

Analyze the measurement results using markers, math operations, and limit tests.

Step 5. Print, Save or Recall Data

Save or print the measurement data.

Frequency Blanking

For security reasons, you can prevent frequency information from appearing on the screen and printouts.

How to set Frequency Blanking

Using **Hardkey/SoftTab/Softkey**

1. Press **System** > **Main** > **Security...**

Using a mouse

1. Click **Utility**.
2. Select **System**.
3. Select **Security...**

◀ Programming Commands ▶

Security Setting dialog box help

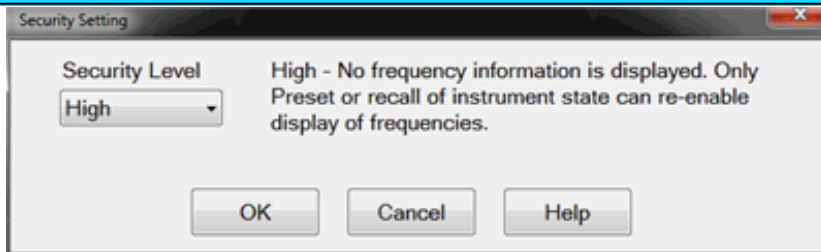

Notes

- To learn how to erase memory before moving your analyzer out of a secure area, see <http://na.support.keysight.com/pna/security.html>.
- An ECal Data Wipe Utility destroys all user data per US DoD 5220.22-M. Learn more at <http://na.support.keysight.com/pna/apps/applications.htm>
- VNA 'Undo' is disabled with **High** and **Extra** security levels. [Learn more](#).

Security Levels

None - All frequency information is displayed on the screen and printouts.

Low security level - Frequency information is blanked from the following:

- Display annotation
- Calibration properties
- All tables
- All toolbars
- All printouts
- **External sources** - See Also: **Preference to Deactivate External Devices on Preset**. **Note:** Frequency Blanking is fully supported ONLY on Keysight MXG sources with option 006. On MXG models without option 006 and all PSG models, the window state is turned OFF. When the “local” button is clicked on the source, then frequency is re-displayed.

High security level - Low security level settings PLUS:

- **GPIB console** is inactive

Extra security level - High security level settings PLUS:

- All ASCII **data saving** capability (.snp, .prn, .cti) is saved without frequency information. The X-axis information is replaced with data point numbers. Before A.08.50, saving these file types was NOT allowed.
- **Mixer setup files** (*.mxr) can NOT be saved.

For ALL security levels:

Frequency information is **NOT** blanked from the following:

- **Service Adjustment Programs**
- Your COM or SCPI programs.

Instrument State and Cal Sets

The security level is always saved and recalled with an instrument state. However, the instrument state may contain a Cal Set or link to a Cal Set. **Learn more**. This may influence the security level when the instrument state is recalled. Here is how.

- When a new Cal Set is created at the end of a calibration, the current system security level is stored with it.

- The only way to change an existing Cal Set's security level is by writing a new calibration into the Cal Set.
- When later applied to a channel, if the Cal Set has a **higher** security level than the current system security level, the system security level will become upgraded to that of the Cal Set.
- When saving an instrument state to either a *.csa or *.cst file, the security levels of the system and Cal Set are saved separately. When recalled, the higher security level of the two is applied.
- To view the security level of a Cal Set, see [Cal Set Properties](#).

Re-displaying frequency information

- When in **Low** security level, do any of the following:
 - Revisit this dialog box and select **None**
 - Perform an [instrument preset](#)
 - Recall an Instrument State/Cal Set with security level of **None**.
- When in **High** or **Extra** security level, do any of the following:
 - Perform an [instrument preset](#)
 - Recall an Instrument State/Cal Set with security level of **None**.

Networking and Connecting the VNA

GPIB / COM Programming

- [Configure for GPIB, SCPI, and SICL](#)

Controlling External Devices

- [Configure an External Device](#)
- [Handler IO Connector](#)

Preferences

Preferences are settings that survive a Preset or Shutdown. Preferences are listed on this page with links to locations that provide more information.

How to set Preferences

Using **Hardkey/SoftTab/Softkey**

1. Press **System** > **System Setup** > **Preferences....**

Using a mouse

1. Click **Utility**.
2. Select **System**.
3. Select **System Setup**.
4. Select **Preferences**.

[Programming Commands](#)

Preferences dialog box help

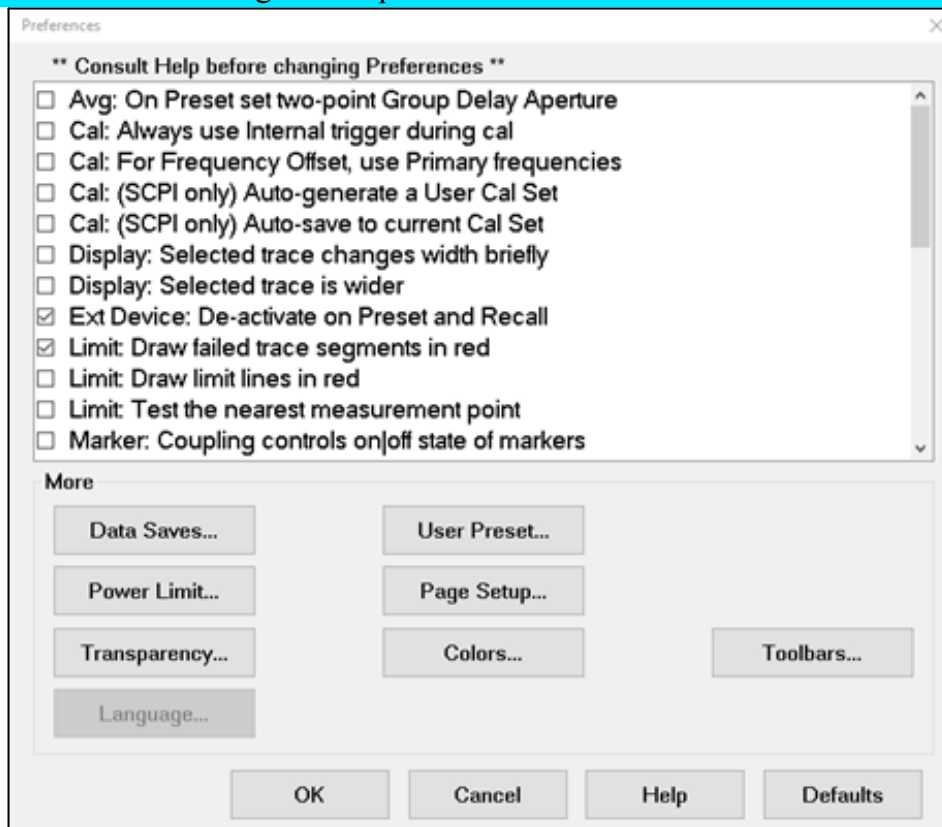

Preferences survive a Preset and a Shutdown.

A checked box makes the following statements true unless stated otherwise.

Avg: On PRESET set two-point group delay aperture Group delay aperture is set to 11 points.

Avg: On PRESET set two-point group delay aperture Group delay aperture set to 2 points. [Learn more.](#)

Cal: Always use Internal Trigger during cal - Only use Internal Trigger source

Cal: Always use Internal Trigger during cal (default) -use the other Trigger source

NOT implemented for M937xA/P937xA models.

Cal: ECal Extrapolation for IMD

Cal: ECal Extrapolation for IMD Allows Swept IMD and IMDx channels to be calibrated beyond the stop frequency of the ECal module by extrapolating the error terms. [Learn more.](#)

Cal: For Frequency Offset, use Primary Frequencies

Cal: For Frequency Offset, use Primary Frequencies Use when making mmWave measurements without a test set. [Learn more.](#)

This setting only affects calibrations performed using SCPI. Cals performed from the User Interface ALWAYS offer a choice to save to a named Cal Set.

Cal: (SCPI only) Auto-generate a User Cal Set Completed calibrations are automatically saved to Cal Registers; NOT to User Cal Sets.

Cal: (SCPI only) Auto-generate a User Cal Set Completed calibrations are automatically saved to an auto-named User Cal Set. Caution: this can cause a lot of saved User Cal Sets. [Learn more.](#)

The following message appears when both the Cal Set choices above and below are selected:

"Cal: Auto-save preferences conflict "

Cal: (SCPI) Auto-save to User Cal Set (above)- or - Cal: (SCPI) Auto-save to current Cal Set (below)

Uncheck one of these.

This setting only affects calibrations performed using SCPI. Cals performed from the User Interface ALWAYS offer a choice to save to a named Cal Set.

Cal: (SCPI) Auto-save to current Cal Set - Always automatically save a completed Cal to the Cal Set that is currently selected on the specified channel, which could be the channel Cal Register.

If the channel does not yet have a selected Cal Set, the Cal will be saved to a new User Cal Set with an automatically-generated name.

Cal: (SCPI) Auto-save to current Cal Set (default)- Do NOT automatically save a completed Cal to the Cal Set that is currently selected on the specified channel.

Display: Selected trace changes width briefly. The selected trace does NOT change width briefly in order to improve visibility.

Display: Selected trace changes width briefly.

Display: Selected Trace is wider. The selected trace is the narrow, default size.

Display: Selected Trace is wider. The active (selected) trace is always wider.

NOT implemented for M937xA/P937xA models.

Display: Touchscreen ON. Selections can be made by touching the screen.

Display: Touchscreen ON. Selections can NOT be made by touching the screen.

NOT implemented for M937xA models.

Ext Device: De-activate on PRESET and recall. External devices are de-activated when the VNA is Preset or when a Instrument State is recalled.

Ext Device: De-activate on PRESET and recall. External devices remain active when the VNA is Preset or when a Instrument State is recalled.

[Learn more about External Devices.](#)

Limit: Draw failed trace segments in red Failed segments are drawn in red. [Learn more.](#)

Limit: Draw failed trace segments in red Failed data points (dots) are drawn in red.

Limit: Draw Limit Lines in Red Limit lines are drawn in the same color as the trace.

Limit: Draw Limit Lines in Red All Limit lines are drawn in Red.

Limit: Test the nearest measurement point - When the stimulus of measurement point is not the same as the limit test point, the nearest limit test point is used for pass/fail judgement.

Limit: Test the nearest measurement point - The pass/fail is judged at only the stimulus of limit test point.

Markers: Coupling controls on/off state of markers - Turning a marker on or off will have no effect on the markers on other traces.

Markers: Coupling controls on/off state of markers - With Coupled Markers ON, when a marker is turned on, the same-numbered marker on all coupled traces will also be turned on. Likewise, turning off a marker will turn it off on all coupled traces.

Markers: On Preset, Coupled Markers is ON - Coupled Markers is OFF after Preset

Markers: On Preset, Coupled Markers is ON - Coupled Markers is ON after Preset

Markers: On Preset, Coupling Method is Channel - Marker Coupling Method is set to ALL after Preset.

Markers: On Preset, Coupling Method is Channel - Marker Coupling Method is set to Channel after Preset.

Marker: On Preset, set BW/Notch search reference to Peak - BW/Notch marker search reference is set to current marker position after Preset.

Marker: On Preset, set BW/Notch search reference to Peak - BW/Notch marker search reference is set to peak after Preset.

Marker: Programming treats Mkr 10 as Reference A marker programming command that includes 10 as its marker number argument will operate on the Reference Marker (NOT the general-purpose Marker 10). **See Marker commands.**

Marker: Programming treats Mkr 10 as Reference A marker programming command that includes 10 as its marker number argument will operate on the general-purpose Marker 10 (NOT the Reference marker).

Marker: Use single marker for marker search (default) - Use one marker for marker search. Sub Marker is displayed and used for Bandwidth, Notch searches.

Marker: Use single marker for marker search - Use multi marker for marker search.

NOT implemented for M937xA/P937xA models.

Meas: Mathematical offset for receiver attenuation The reported test port receiver power is mathematically offset by the amount of receiver attenuation. Default for all models.

Meas: Mathematical offset for receiver attenuation The reported test port receiver power is NOT mathematically offset by the amount of receiver attenuation.

[Learn more.](#)

NOT implemented for M937xA/P937xA models.

Meas: Mathematical offset for source attenuation The reported reference receiver power is mathematically offset by the amount of source attenuation.

Meas: Mathematical offset for source attenuation The reported reference receiver power is NOT mathematically offset by the amount of source attenuation.. [Learn more.](#)

Memory: Data Math 8510 Mode Standard data processing chain.

Memory: Data Math 8510 Mode Simulate the Keysight 8510 data processing chain as it pertains to Trace Math and Memory. [Learn more.](#)

- Memory: Interpolate ON is default condition** Set memory interpolation to OFF as the default.
- Memory: Interpolate ON is default condition** Set memory interpolation to ON as the default.
[Learn more.](#)

Power: On Preset turn power on Instrument Preset always turns source power ON.

Power: On Preset turn power on When the current source power setting is OFF, source power remains OFF after Preset. When the current power setting is ON, source power is turned ON after Preset. [Learn more.](#)

NOT implemented for M937xA/P937xA models.

For SCPI behavior only. [Learn more.](#)

Power: Report source unlevelled events as errors Source unlevelled events are reported as errors.

Power: Report source unlevelled events as errors Source unlevelled events are NOT reported as errors.

NOT implemented for M937xA/P937xA/M980xA/P50xxA models.

Power: Report when receiver is overloaded A warning message is displayed on the VNA screen indicating that a receiver is overloaded or in compression. The displayed data is probably not accurate. One error per sweep appears and is reported in the **Error Log**. (Always ON for M980xA, P50xxA.)

Power: Report when receiver is overloaded Do NOT show overload warnings on the screen or report these errors in the error log.

NOT implemented for M937xA/P937xA/M980xA/P50xxA models.

Power: Force RF power Off at end of sweep Turn RF power Off during a retrace of single-band frequency or segment sweeps.

Power: Force RF power Off at end of sweep Leave RF power On during a retrace of single-band frequency or segment sweeps. [Learn more.](#)

NOT implemented for M937xA/P937xA/M980xA/P50xxA models.

Power: Turn Source Power Off when receiver is overloaded. Power remains ON when a receiver is overloaded. (Always ON for M980xA, P50xxA.)

Power: Turn Source Power Off when receiver is overloaded. Turn OFF power to ALL ports when a receiver is overloaded. A notification dialog appears. Click **OK**, then lower the power level, then turn power ON. (Click **Stimulus**, then **Power**)

NOT implemented for M937xA/P937xA/M980xA/P50xxA models.

Power: Use Start Power during Power Sweep retrace At the end of a power sweep, while waiting to trigger the next sweep, the VNA maintains source power at the start power level.

Power: Use Start Power during Power Sweep retrace Maintain source power at the STOP power level. [Learn more.](#)

Preset: Confirm preset - When **Preset** hardkey button is pressed, VNA firmware immediately presets (Hardkey is required only).

Preset: Confirm preset (default) - When **Preset** > **Preset** is pressed, VNA firmware immediately presets (Hardkey and Softkey are required).

NOT implemented for M937xA/P937xA models.

Preset: On Preset enable TDR. Enable TDR on preset and power-up.

Preset: On Preset enable TDR. Do not enable TDR on preset and power-up.

Preset: On Preset show Quick Start dialog - Open Quick Start dialog on Preset.

Preset: On Preset show Quick Start dialog - Do not open Quick Start dialog on Preset.

Recall: Softkey order is most recently used - Recall softkey order which is most recently used.

Recall: Softkey order is most recently used (default) - Do NOT recall softkey order which is most recently used.

Scale: On Preset Couple scale to Window - Scale coupling is set to Window when **Preset**.

Scale: On Preset Couple scale to Window (default) - Scale coupling is set to Off by default when **Preset**.

NOT implemented for M937xA/P937xA/M9485A models.

Sweep: On Preset set Sweep Mode to Stepped - Sweep Mode set to Stepped after Preset.

Sweep: On Preset set Sweep Mode to Stepped - Sweep Mode set to Auto after Preset.

Sweep: Use only ramp sweeps for Auto Sweep Mode - Auto Sweep Mode set to use continuous ramp sweeps after Preset.

Sweep: Use only ramp sweeps for Auto Sweep Mode - Auto Sweep Mode set to not use ramp sweeps after Preset.

System: Enable sound (default) - Instrument speaker turns ON.

System: Enable sound - Instrument speaker turns OFF.

System: On Power-on show Keys toolbar - Display softkey toolbar after power-on.

System: On Power-on show Keys toolbar - Hide softkey toolbar after power-on.

NOT implemented for M937xA/P937xA models.

System: On VNA Start-up Run Self Tests (default) - Module self tests and connection checks are executed at start up

System: On VNA Start-up Run Self Tests - Module self tests and connection checks are NOT executed at start up

System: Use keyboard to navigate softkeys - Enable the keyboard to browse the softkeys.

System: Use keyboard to navigate softkeys (default) - Disable the keyboard to browse the softkeys.

System: Optimize memory for use with many channels - (M9485A only) The maximum number of channels will be extended but measurement speed may be decreased. The maximum number of channels depends on PC memory, NOP and traces.

System: Optimize memory for use with many channels (default) - (M9485A only) Standard mode (No memory optimization)

NOT implemented for M937xA/P937xA models.

Sets the scope of External Trigger Output signal properties. The VNA is **Preset** after changing this setting.

Trigger: External Trigger OUT is Global Channels can have different External Trigger OUT settings. Default for PNA-X and N522xA models. On the Trigger Setup dialog, **Trigger Mode = Point** is ignored for external triggering.

Trigger: External Trigger OUT is Global All channels have same External Trigger OUT settings. Default for VNA “C” and PNA-L models. Aux Trig OUT properties apply to all channels except the Per Point setting. To set Per Point for specific channels: On the **Trigger Setup** dialog, set **Trigger Scope = Channel**, under **Channel Trigger State**, select the channel, and set **Trigger Mode = Point**.

[See External Triggering dialog.](#)

The More buttons launch dialogs that contain predefined preferences:
<p>Data Saves... -</p> <p>Define Data Saves - While not explicitly called Preferences, all of these settings survive a shutdown. Learn more.</p>
<p>Power Limit</p> <p>Offsets and Limits - Sets Power Limits and Offsets. Learn more.</p>
<p>Transparency...</p> <p>Dialog Transparency - Some dialogs can be viewed in various levels of transparency. Learn more.</p>
<p>Language...</p> <p>Help - Sets the language of the built-in help (English or other localized language). Learn more.</p>
<p>User Preset...</p> <p>User Preset - Specify the Instrument State file that the analyzer will use when Preset. Learn more.</p>
<p>Page Setup...</p> <p>Page Setup - Standard printer settings (Paper, Orientation, and Size) do NOT survive a shutdown. All other settings DO survive a shutdown. Learn more.</p>
<p>Colors...</p> <p>Display Colors - Sets display items to custom colors. Learn more.</p> <p>Print Colors - Sets print items to custom colors. Learn more.</p>
<p>Toolbars...</p> <p>Show Toolbars/Other Bars - Select toolbars to display.</p> <p>Defaults - Restore preferences to their default values.</p>
NOT implemented for M937xA/P937xA models.
<p>Millimeter settings</p> <p>Sets MM Wave configurations. Learn more.</p>

Although they are called preferences, the following settings do NOT survive a shutdown.

Calibration	UI Setting
Show or not, the first 'Method' Page of the Cal Wizard.	Cal Preferences
Set and order default Cal Types	Cal Preferences
Perform orientation of the ECal module during calibration?	ECal Wizard
Specify ECal port mapping when orientation is OFF	ECal Wizard
Show or hide custom Cal Windows during Cal	Cal Window (remote commands only)

Dialog Transparency

Most VNA dialogs can be made to appear with various amounts of transparency. This allows you to view the VNA traces through the dialog as you make dialog settings.

How to set Transparency Level

There are three ways to make the transparency level setting:

1. Right-click in any non-control area of a dialog that allows transparency to see the following selections:

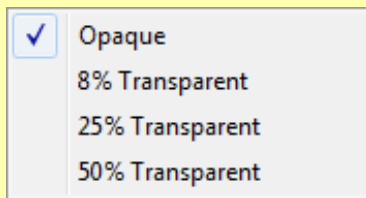

2. In tabbed dialogs, cycle through the above transparency settings by pressing  multiple times.

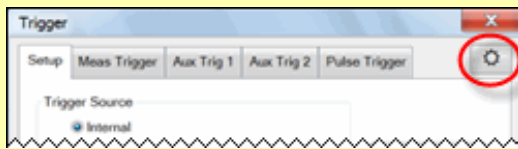

3. Launch the Transparency dialog (below) from the **Preferences** dialog.

This setting is not programmable

Dialog Transparency dialog box help

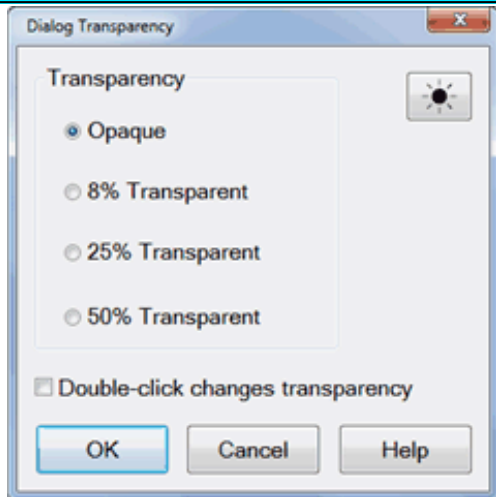

Note: This single Transparency setting applies to ALL supported VNA dialogs.

- Opaque (NOT Transparent) - Default setting
- 8% Transparency
- 25% Transparency
- 50% Transparency

Double-click changes transparency - When checked, cycle through the above transparency settings by double-clicking in any non-control area of a dialog that allows transparency.

Notes

- The transparency setting is stored as a **VNA Preference**.
- The setting survives a VNA Shutdown and Preset.
- It is NOT saved and recalled with instrument state.

Keyboard Shortcuts

Function	Shortcut
Instrument Keys	
PREV	PAGE UP
NEXT	SHIFT + CONTROL + LEFT ARROW
	SHIFT + CONTROL + COMMA
	PAGE DOWN
	SHIFT + CONTROL + RIGHT ARROW
	SHIFT + CONTROL + PERIOD
TRACE	SHIFT + CONTROL + T
CHANNEL	SHIFT + CONTROL + H
DISPLAY	SHIFT + CONTROL + D
SETUP	SHIFT + CONTROL + U
Response Keys	
MEAS	SHIFT + CONTROL + M
FORMAT	SHIFT + CONTROL + F
SCALE	SHIFT + CONTROL + S
MATH > Memory	SHIFT + CONTROL + O
MATH > Analysis	SHIFT + CONTROL + N
AVG BW	SHIFT + CONTROL + A
CAL	SHIFT + CONTROL + C
MARKER	SHIFT + CONTROL + R
SEARCH	SHIFT + CONTROL + E
Stimulus Keys	
FREQ	SHIFT + CONTROL + Q
POWER	SHIFT + CONTROL + P
SWEEP	SHIFT + CONTROL + W
TRIGGER	SHIFT + CONTROL + I
Utility Keys	
SAVE RECALL > Recall	SHIFT + CONTROL + L
SAVE RECALL > Save	SHIFT + CONTROL + Y
SYSTEM	SHIFT + CONTROL + Y
MACRO	SHIFT + CONTROL + G
SYSTEM > Help	CONTROL + H
Undo	CONTROL + Z
Redo	CONTROL + Y
PRESET	SHIFT + CONTROL + X
Other Features	
Trace 1	SHIFT + CONTROL + 1
Trace 2	SHIFT + CONTROL + 2
Trace 3	SHIFT + CONTROL + 3
Trace 4	SHIFT + CONTROL + 4
Hardkeys Toolbar	SHIFT + CONTROL + K
Minimize Application	SHIFT + CONTROL + Z
Mainframe Menu show/hide	SHIFT + CONTROL + B
File Open dialog	CONTROL + O
Save file	CONTROL + S

Save As dialog	CONTROL + A
Print dialog	CONTROL + P
Print to File dialog	CONTROL + T
Focus on Mainframe Menu	ALT
Softkey 1 to 8	CONTROL + 1, to CONTROL + 8

Using Help

This topic discusses the following:

- Documentation
- Printing Help
- Copying Help to your PC
- Launching Help
- Searching Help
- GUI Reference
- Help Languages
- Documentation Warranty

See Also

Help, About Network Analyzer

Other Quick Start Topics

Help Documentation

This Help file is the **Users Guide and Programming Manual for the PXie VNA Soft Front Panel**.

Hardcopies of this help file is NOT available for purchase.

All documentation, including the **latest online Web Help version** of this Help file, and a printable .PDF version of the Help file, are available at <http://na.support.keysight.com/pixvna/help> or <http://na.support.keysight.com/P937XA/help>.

Printing Help

A printable .PDF version of this Help file is available at <http://na.support.keysight.com/pixvna/help> or <http://na.support.keysight.com/P937XA/help>.

Copying Help to your PC

With the Help system on your PC, you can read about the analyzer while away from it. You can also Copy and Paste programming code from this Help system directly into your programming environment.

The Help file is located on your analyzer hard-drive at **C:/Program Files (x86)/Keysight/Network Analyzer/Help/<filename>.chm** . If both the analyzer and PC are connected to LAN, you can map a drive and copy the file directly.

The Help file can also be downloaded from <http://na.support.keysight.com/pixvna/help> or <http://na.support.keysight.com/P937XA/help> .

Launching Help

The Help system can be launched in the following ways:

1. From the **Help** drop-down menu.
2. From Dialog Box Help buttons.

Search Tab

TIP: To Search any topic for a keyword, press **Ctrl** and **F** .

The following rules apply for using full-text search:

- Searches are not case-sensitive.
- You can search for any combination of letters (a-z) and numbers (0-9).
- Punctuation marks (period, colon, semicolon, comma, and hyphen) are ignored during a search.
- You can group the words of your search using double quotes or parentheses. Examples: "response calibration" or (response calibration). This requirement makes it impossible to search for quotation marks.
- Use Wildcard expressions:
 - To search for one undefined character use a question mark (?). For example, searching for **cal?** will find **calc** and **calf**.
 - To search for more than one undefined character use an asterisk (*). Searching for **Cal*** will find **calibration** and **calculate**.
- Use Boolean operators to define a relationship between two or more search words.

Search for	Example	Results will show topics containing:
Two words in the same topic	response AND calibration	Both the words "response" and "calibration".
Either of two words in a topic	response OR calibration	Either the word "response" or the word "calibration" or both.
The first word without the second word in a topic	response NOT calibration	The word "response" but not the word "calibration".
Both words in the same topic, close together.	response NEAR calibration	The word "response" within eight words of the word "calibration".

GUI Reference

The GUI Reference corresponds to the GUI Hardkeys to help find information quickly:



The GUI Reference topics displayed in the table of contents are arranged in alphabetical order:

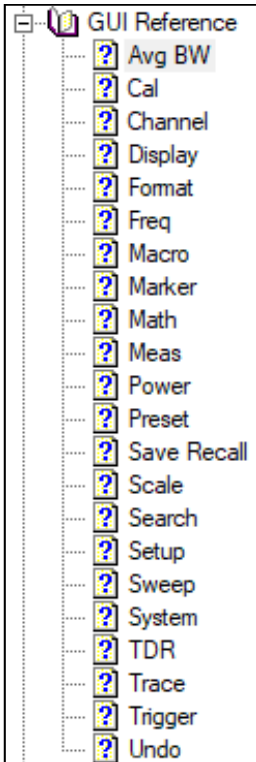

GUI Reference	
	Avg BW
	Cal
	Channel
	Display
	Format
	Freq
	Macro
	Marker
	Math
	Meas
	Power
	Preset
	Save Recall
	Scale
	Search
	Setup
	Sweep
	System
	TDR
	Trace
	Trigger
	Undo

The following procedure is a typical example of how to find information using the GUI Reference. This example shows how to search for the **Avg BW** Hardkey information with the Standard Measurement class selected.

1. Under GUI Reference in the table of contents, select the **Avg BW** topic. The following is displayed:

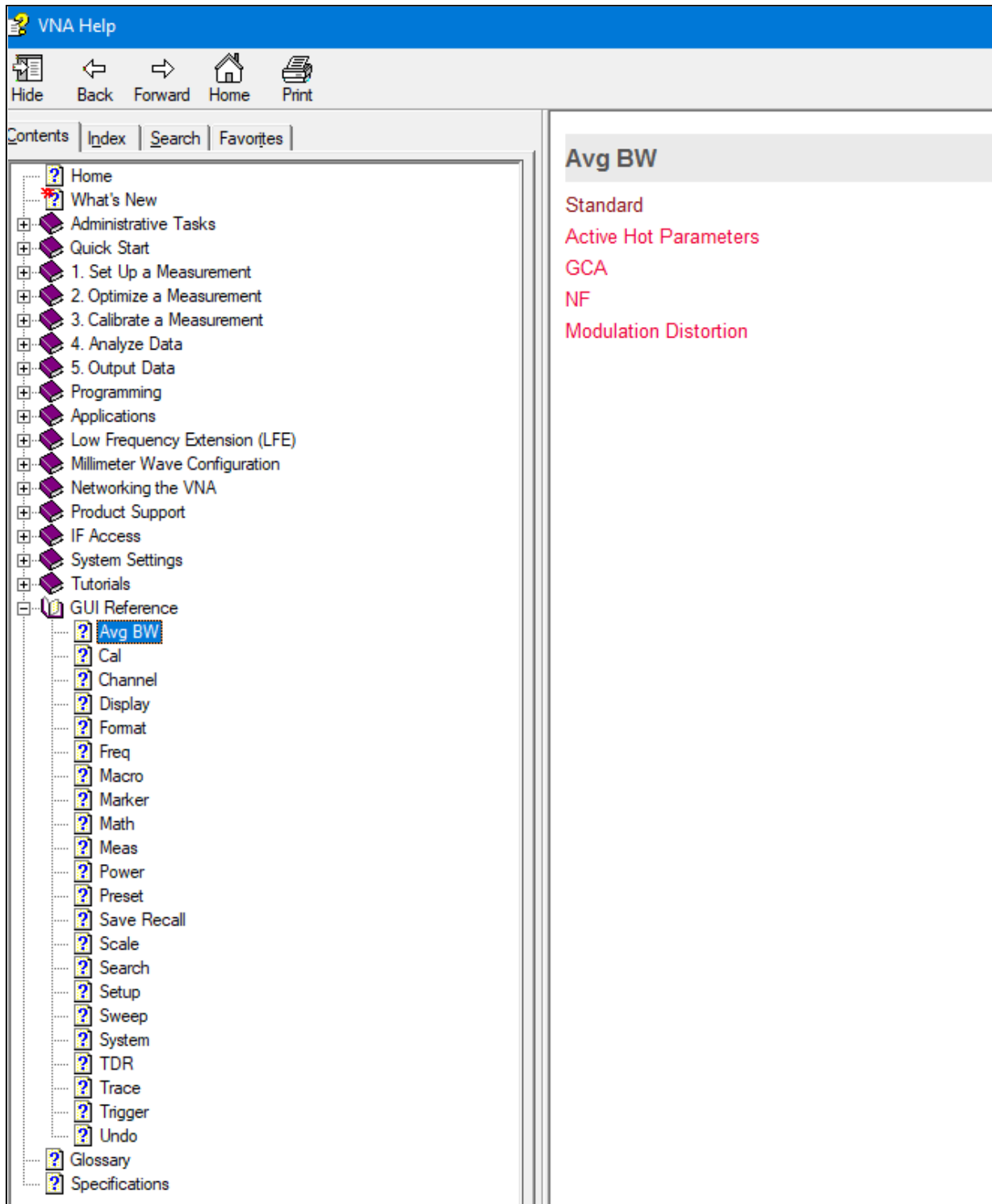

The links shown on this page correspond to Measurement Class names because some menus change with Measurement Class.

2. Click on the Standard link. The following is displayed:

VNA Help

Hide Back Forward Home Print

Contents | Index | Search | Favorites

- Home
- What's New
- Administrative Tasks
- Quick Start
- 1. Set Up a Measurement
- 2. Optimize a Measurement
- 3. Calibrate a Measurement
- 4. Analyze Data
- 5. Output Data
- Programming
- Applications
- Low Frequency Extension (LFE)
- Millimeter Wave Configuration
- Networking the VNA
- Product Support
- IF Access
- System Settings
- Tutorials
- GUI Reference
 - Avg BW
 - Cal
 - Channel
 - Display
 - Format
 - Freq
 - Macro
 - Marker
 - Math
 - Meas
 - Power
 - Preset
 - Save Recall
 - Scale
 - Search
 - Setup
 - Sweep
 - System
 - TDR
 - Trace
 - Trigger
 - Undo
- Glossary
- Specifications

Standard Avg BW

Main

- Averaging
- Averaging Restart
- Average Type
- IF Bandwidth
- LF Auto BW

Smoothing

- Smoothing
- Smooth Percent
- Smooth Points

Delay Aperture

- Aperture Percent
- Aperture Points
- Aperture Freq

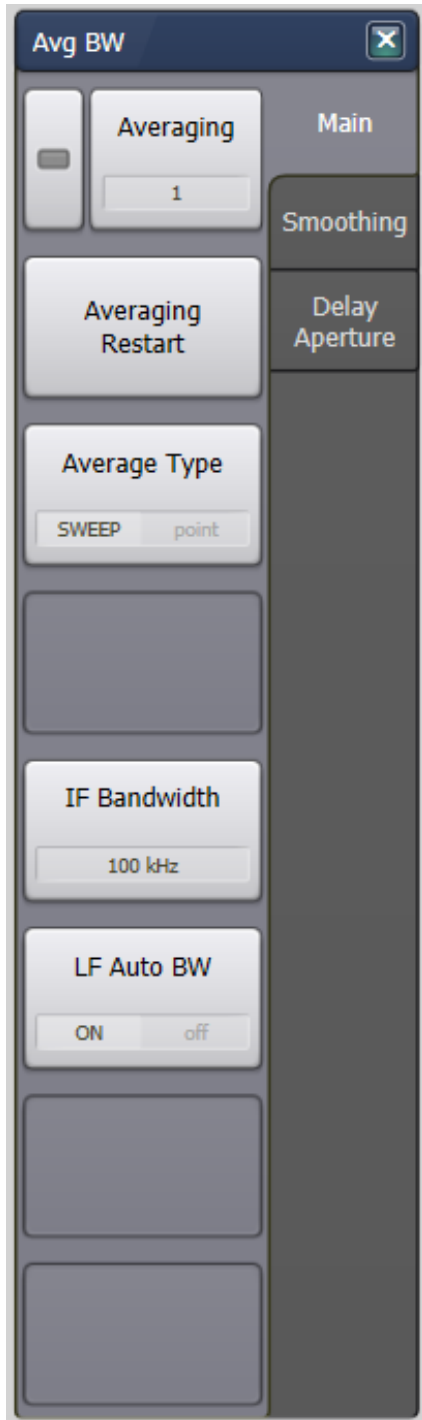

Main , **Smoothing** , and **Delay Aperture** correspond to the soft tab labels. The links correspond to the softkey labels.

3. Click on a link for information.

Help Languages

This help file is offered in English ONLY.

Glossary

The Glossary holds definitions of words, in alphabetical order.

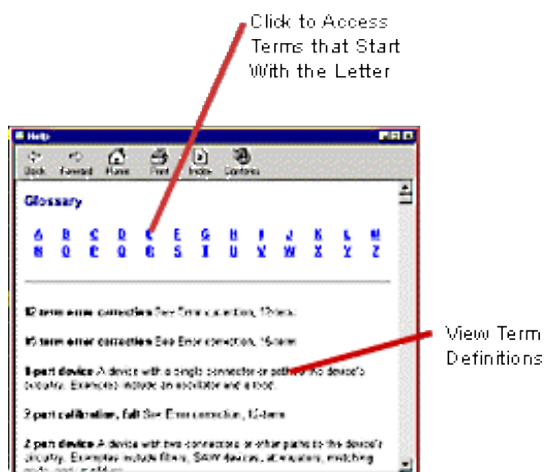

Documentation Warranty

THE MATERIAL CONTAINED IN THIS DOCUMENT IS PROVIDED "AS IS," AND IS SUBJECT TO BEING CHANGED, WITHOUT NOTICE, IN FUTURE EDITIONS. FURTHER, TO THE MAXIMUM EXTENT PERMITTED BY APPLICABLE LAW, KEYSIGHT DISCLAIMS ALL WARRANTIES, EITHER EXPRESS OR IMPLIED WITH REGARD TO THIS MANUAL AND ANY INFORMATION CONTAINED HEREIN, INCLUDING BUT NOT LIMITED TO THE IMPLIED WARRANTIES OF MERCHANTABILITY AND FITNESS FOR A PARTICULAR PURPOSE. KEYSIGHT SHALL NOT BE LIABLE FOR ERRORS OR FOR INCIDENTAL OR CONSEQUENTIAL DAMAGES IN CONNECTION WITH THE FURNISHING, USE, OR PERFORMANCE OF THIS DOCUMENT OR ANY INFORMATION CONTAINED HEREIN. SHOULD KEYSIGHT AND THE USER HAVE A SEPARATE WRITTEN AGREEMENT WITH WARRANTY TERMS COVERING THE MATERIAL IN THIS DOCUMENT THAT CONFLICT WITH THESE TERMS, THE WARRANTY TERMS IN THE SEPARATE AGREEMENT WILL CONTROL.

Help - About Network Analyzer

Click [System](#) > [Help](#) > [About NA...](#) to learn the capabilities of your analyzer.

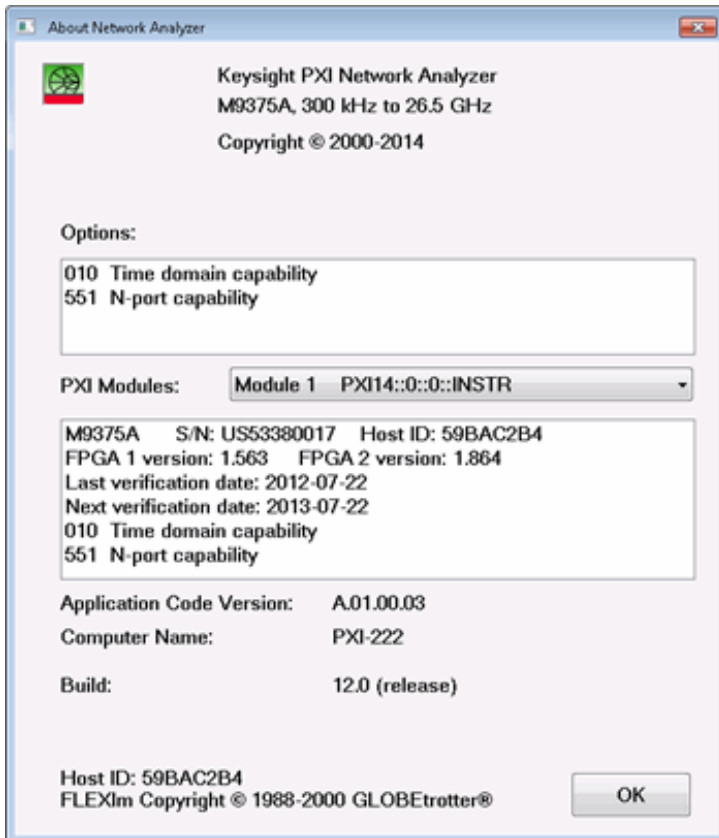

- Model number ([see list of models](#))
- Options ([Learn how to install software options](#))
- PXI Modules: Select the required module to show the information in the window below
 - Product number, S/N, [Host ID](#)
 - Calibration Date
 - Hardware options

- Computer Name - Full computer name of the Embedded Controller when used.
-

Preset the Analyzer

When you Preset the analyzer, it is set to known, or preset conditions. You can use the factory default preset conditions, or define your own User Preset conditions.

Note: Presetting the analyzer will not remove the calibration data in the Channel default CALREG calset.

- [Preset \(Default\) Conditions](#)
- [User Preset Conditions](#)

[See other 'Setup Measurements' topics](#)

Preset Default Conditions

How to Preset the Analyzer

Using **Hardkey/SoftTab/Softkey**

1. Press **Preset** > **Main** > **Preset**.

When **Confirm Preset** is Off,

1. Press **Preset**.

[Programming Commands](#)

User Preset Conditions

The analyzer can be **preset** to either **factory default** conditions or **User Preset** conditions.

How to set User Preset

Using **Hardkey/SoftTab/Softkey**

1. Press **Preset** > **Main** > **User Preset**.

[Programming Commands](#)

User Preset dialog box help

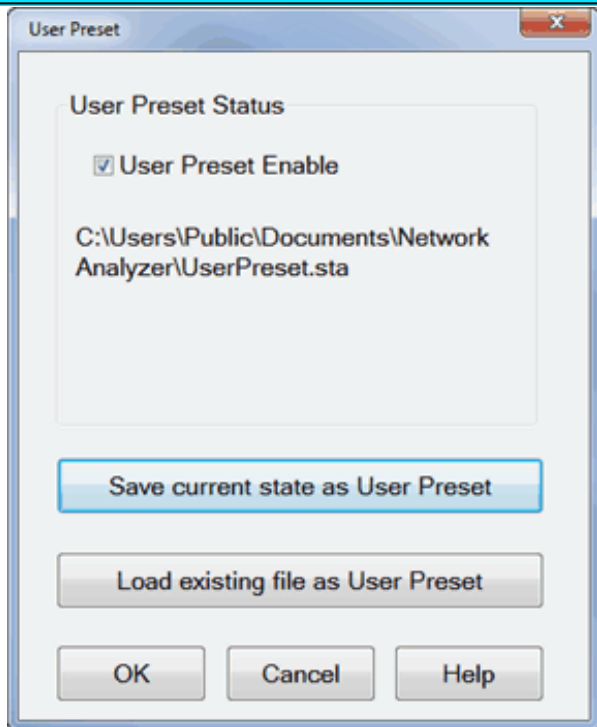

With a User Preset saved and enabled, when the VNA is Preset, the User Preset settings are recalled instead of the factory default settings. Calibration data is NOT recalled with a User Preset. [Learn more about instrument state settings.](#)

User Preset Enable

Check - The VNA is preset to **User Preset** conditions when the Preset button is pressed.

Clear - The VNA is preset to **Default** conditions when the Preset button is pressed.

Save current state as User Preset Click to store the current instrument state as the User Preset conditions. File is stored as c:\users\public\documents\network analyzer\UserPreset.sta.

Load existing file as User Preset Click to retrieve an instrument state to be used as the User Preset conditions.

Measurement Classes

Measurement Classes are categories of measurements that can coexist on a channel.

- [What are Measurement Classes](#)
- [How to assign a Measurement Class to a Channel](#)
- [Measurement Class Dialog Box Help](#)

Note: The M9370/71A/72A/73A/74A/75A does not support this function.

[See other 'Setup Measurements' topics](#)

What are Measurement Classes

Note: Measurement classes vary according to the VNA model and options installed.

The dialog below is an example showing the Measurement Classes currently available for a VNA. Within each of these classes there are a number of measurements.

Measurement Classes are categories of measurements that can coexist on a channel. A measurement from one class can NOT reside in a channel with a measurement from another class. For example, a Noise Figure measurement can NOT reside in a channel that is currently hosting Scalar Mixer Measurements.

The Measurement Class dialog is accessed in the following ways:

How to assign a Measurement Class to a Channel

Using **Hardkey/SoftTab/Softkey**

1. Press **Meas** > **S-Param** > **Meas Class...**

Using a mouse

1. Click **Instrument**.
2. Select **Meas Class...**

[Programming Commands](#)

[Measurement Class dialog box help](#)

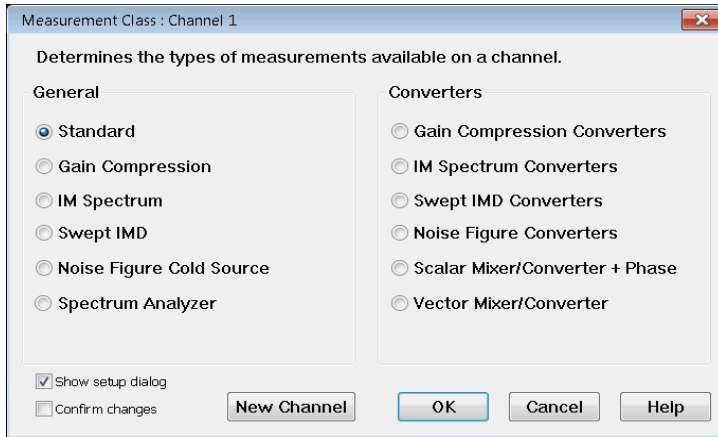

Measurement class dialog box shows the supported classes for your unit. The supported classes depends on the product and installed options. The above dialog box shows an example of PNA.

Measurements in a measurement class can NOT coexist in a channel with a measurement of a different measurement class.

Select a measurement class for the active channel or new measurement channel.

- The **Standard** measurement class contains S-Parameters, Balanced parameters, and Receiver measurements.
- All other measurement classes are commonly called "**Applications**".

Title Bar Indicates the active channel to which the measurement class will be assigned.

Show setup dialog

- Check to launch the selected Measurement Class dialog.
- Clear (default setting) to not launch the selected Measurement Class dialog. This setting survives a Preset and VNA Shutdown.

Confirm changes

- Check (default setting) to launch the Confirm Measurement Class Change dialog.
- Clear to perform the 'OK' actions without confirmation. This setting survives a Preset and VNA Shutdown.

New Channel Click to create the measurement class in a new channel and new window. A default measurement for that class is created in the channel.

To change the measurement, click **Trace**, then select a new measurement.

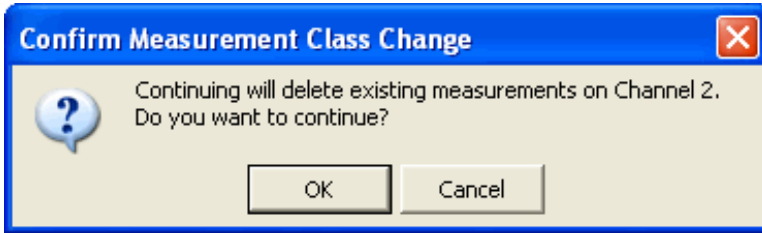

Choose to do the following:

- **OK** - Delete the existing measurements in the active channel. Create the new measurement class, and default measurement, in that channel.
 - **Cancel** - Do not create the new measurement class. Leave the old measurements (and class) in that channel and return to the Measurement Class dialog box.
-

Measurement Parameters

This topic contains the following information:

- [S-Parameters](#) (pre-selected ratios)
- [Ratioed](#) (choose your own ratio)
- [Unratioed Power](#) (absolute power)
- [How to Select a Measurement Parameter](#)
- [Auxiliary](#)

[Learn about Balanced Measurements](#)

[See other 'Setup Measurements' topics](#)

S-Parameters

S-parameters (scattering parameters) are used to describe the way a device modifies a signal. For a 2-port device, there are **four S-Parameters**. The syntax for each parameter is described by the following:

S **out** - **in**

out = analyzer port number where the device signal output is measured (receiver)

in = analyzer port number where the signal is applied (incident) to the device (source)

Move the mouse over each S-parameter to see the signal flow:

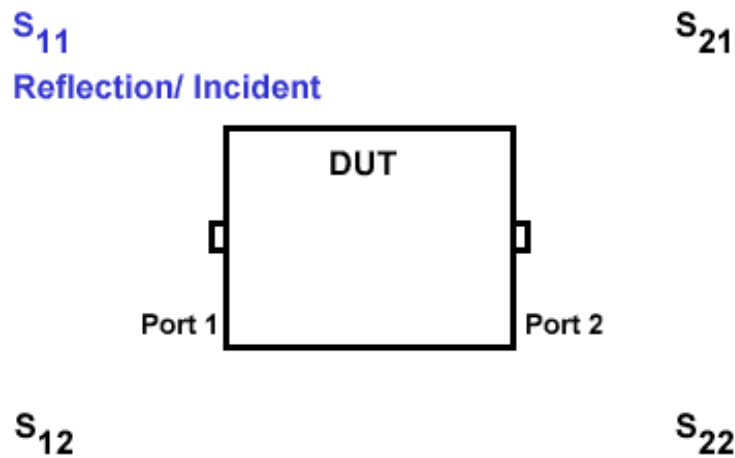

For two-port devices:

- When the source goes into port 1, the measurement is said to be in the **forward** direction.
- When the source goes into port 2, the measurement is said to be in the **reverse** direction.

The analyzer automatically switches the source and receiver to make a forward or reverse measurement. Therefore, the analyzer can measure all four S-parameters for a two-port device with a single connection.

See the [block diagram](#) (including receivers) of your VNA.

Common Measurements with S-Parameters

Reflection Measurements (S11 and S22)

- Return loss
- Standing wave ratio (SWR)
- Reflection coefficient
- Impedance
- S₁₁, S₂₂

Transmission Measurements (S21 and S12)

- Insertion loss
- Transmission coefficient
- Gain/Loss
- Group delay
- Deviation from linear phase
- Electrical delay
- S₂₁, S₁₂

Receiver Measurements

All analyzer models have test port receivers and reference receivers.

For 4-port models...

- R1, R2, R3, and R4 are reference receivers. They measure the signal as it leaves the analyzer source.
 - R1 measures the signal out of Port 1
 - ...
 - R4 measures the signal out of Port 4
- A, B, C, and D are test port receivers. They measure the signal out (or reflecting off) of the DUT.
 - A measures the signal into VNA Port 1
 - B measures the signal into VNA Port 2
 - C measures the signal into VNA Port 3
 - D measures the signal into VNA Port 4

Models with more than 4 ports must specify receivers using Logical Receiver Notation. [Learn more.](#)

Ratioed Measurements

Ratioed measurements allow you to choose your own ratio of any two receivers that are available in your analyzer. S-parameters are actually predefined ratio measurements. For example S11 is A/R1.

The following are common uses of ratioed measurements:

- Comparing the phase between two paths of a device. An example could be something simple like a power splitter or more complicated like a dual-channel receiver.
- Measurements that require a higher dynamic range than the analyzer provides with S-parameters.

Unratioed (Absolute Power) Measurements

The unratioed power parameter measures the absolute power going into any of the receivers that are available on your analyzer.

The reference receivers are internally configured to measure the source power for a specific analyzer port.

- **Measuring phase** using a single receiver yields meaningless data. Phase measurements must be a comparison of two signals.
- Averaging for Unratioed parameters is computed differently from ratioed parameters. [Learn more.](#)
- To calibrate ratioed or unratioed receiver (power) parameters, the recommended method is the **Guided Power Calibration**. The **Unguided Response Calibration** can also be used to calibrate a single unratioed or ratioed parameter at a time.

New / Change Measurement dialog box help

Note: The only measurements that are available are those in the **measurement class** currently assigned to the active channel. Other measurements are NOT compatible.

To create a measurement other than these, first assign the appropriate measurement class to a new or existing channel. [Learn how.](#)

Click a tab to create or change measurements.

- When creating NEW measurements, you can choose more than one.
- When changing an EXISTING measurement, you can choose ONLY one.

Tabs

S-Parameter Select a predefined ratioed measurements. [Learn more about S-parameters.](#)

For Setup: \leq 4-Port

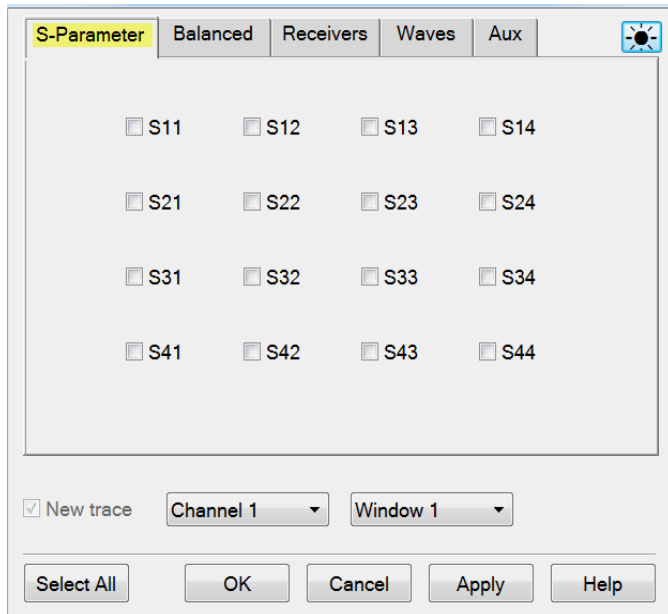

For Setup: Multiport (>4 ports)

Note: Greater than 4 ports is not supported on the P937xA.

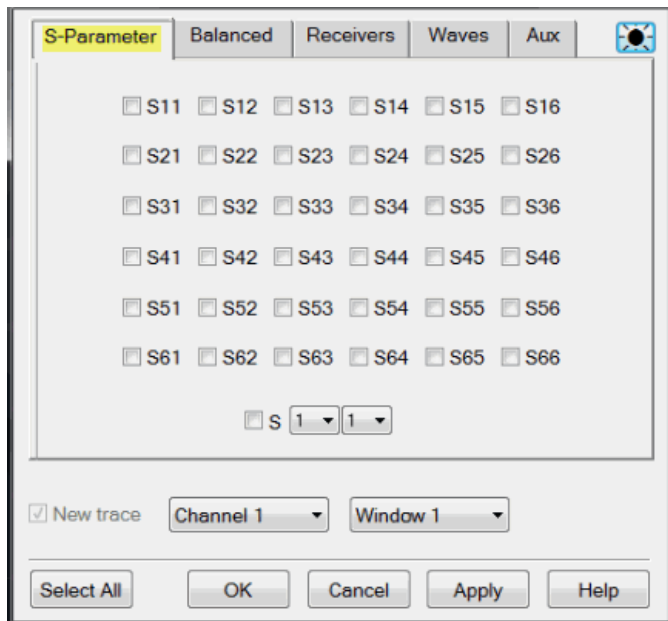

Balanced Select a balanced measurement type.

Topology Click to invoke the [Balanced DUT Topology / Logical Port mappings](#) dialog box. [Learn more about Balanced Measurements.](#)

For Setup: <= 4-Port

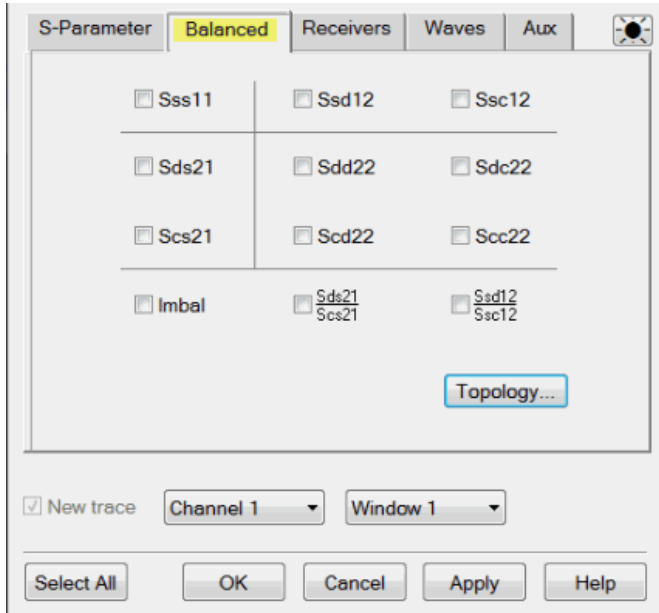

For Setup: Multiport (>4 ports)

Note: Greater than 4 ports is not supported on the P937xA.

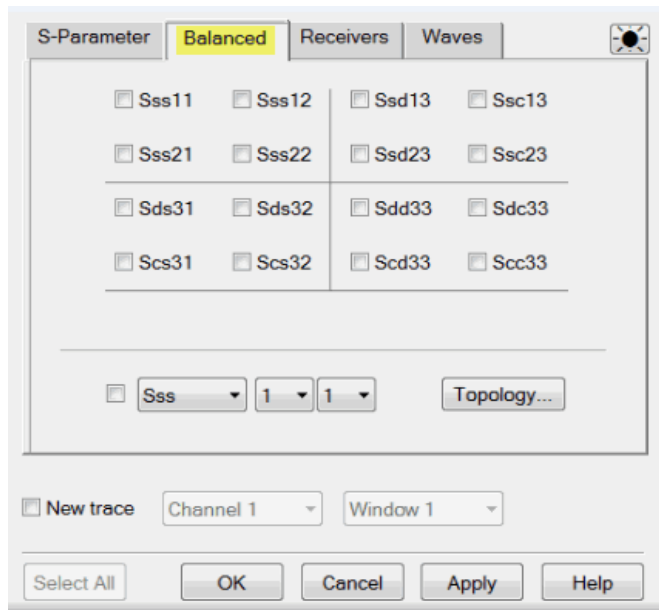

The table only show parameters for up to the first four VNA ports being used. Balanced Parameter Selector at the bottom allow you to select other parameters.

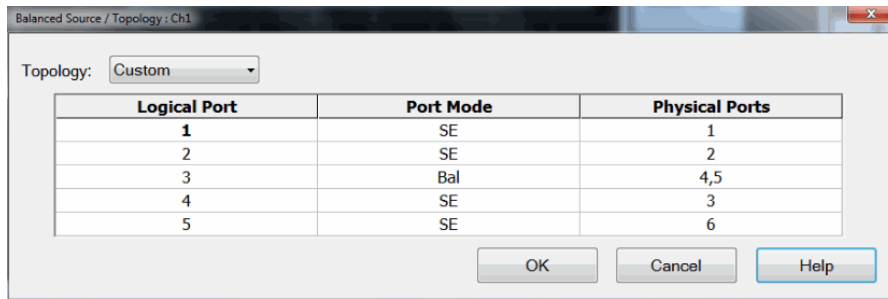

Multiport setup is shown in Custom under **Topology**. The setting in Custom only can change with SCPI command.

Select All Will only select the parameters shown and will not select the check box of the Receiver selector at the bottom.

Receivers Select receivers to make Ratioed and Unratioed (absolute power) measurements. [Learn more about receiver measurements.](#)

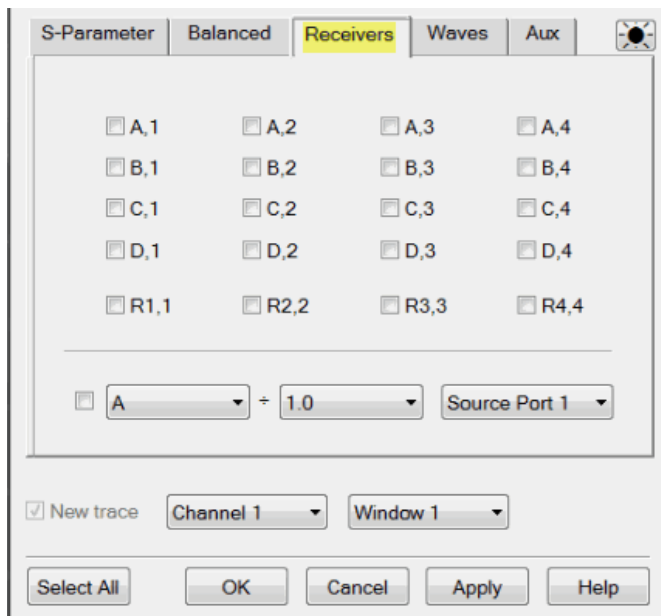

Ratioed Click on the check box to select the parameters and create measurement. Receiver selector at the bottom allow you to define ratios. Select a receiver for the Numerator, select another receiver for the Denominator, then select a source port for the measurement.

The **Source port** is ALWAYS interpreted as a logical port number.

For convenience, the table is populated with common choices.

Select All Will only select the parameters shown and will not select the check box of the

Receiver selector at the bottom.

- [Learn more about Ratioed Measurements.](#)

Unratioed Same as Ratioed, but select **1** as the Denominator.

- [Learn More about Unratioed Measurements.](#)

Waves Select receiver notation to make ratioed and unratioed measurements.

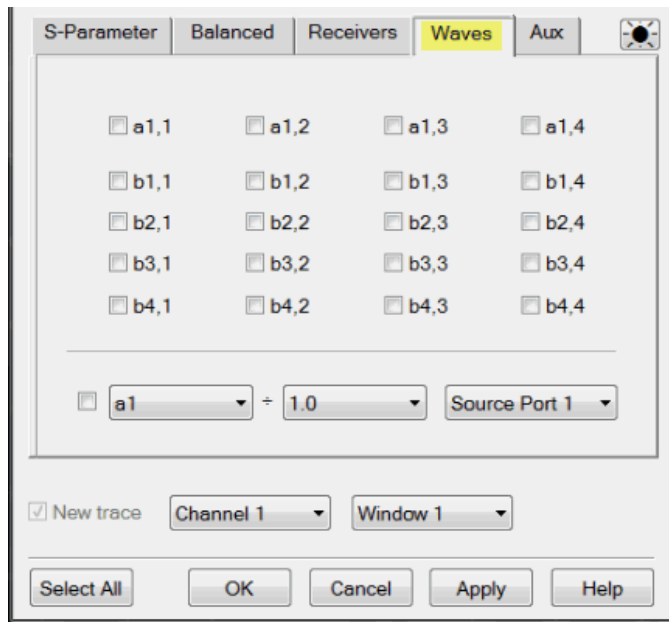

Click on the check box to select the parameters and create measurement. Wave selector at the bottom allow you to define ratio.

Select All Will only select the parameters shown and will not select the check box of the Wave selector at the bottom.

Receiver Notation

Receivers can be also selected using logical receiver notation. This "8510-style" notation makes it easy to refer to multi-port receivers.

- **aN** - Reference receiver for logical port N
- **bN** - Test port receiver for logical port N

For example:

- For **Ratioed** measurements: "b12/a1" refers to the logical test port 12 receiver / the logical port 1 reference receiver.
- For **Unratioed** measurements: "b10" refers to the logical test port 10 receiver.

The VNA-style notation (A, B, R1 and so forth) can still be used to refer to **physical** receivers in less than 4 ports. [Learn more.](#)

However, ratioed measurements **MUST** use the same notation to refer to both receivers; either the physical receiver notation (A, R1) or the logical receiver notation (aN, bN). For example, the following mixed notation is **NOT** allowed: A/b3 and a5/R2.

Programming

When entering receiver letters using programming commands, neither logical or physical receiver notation are case sensitive.

AUX Select input of Auxiliary on the rear panel to make DC measurement.

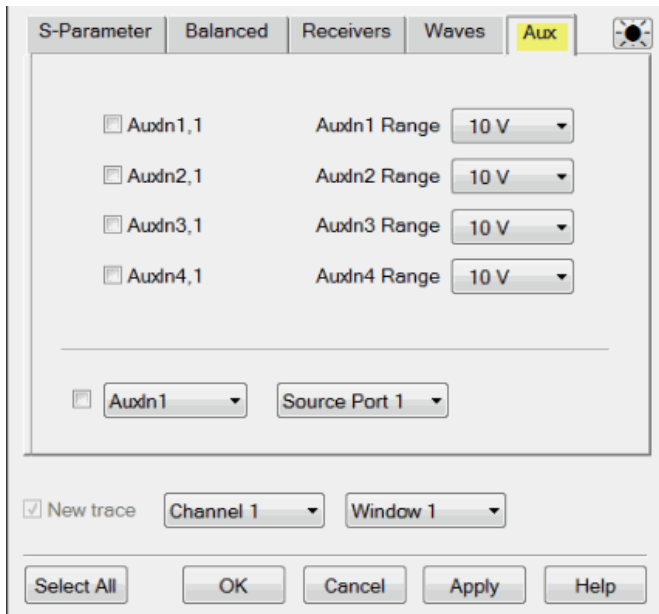

Click on the check box to select the input of auxiliary and create measurement. Auxiliary selector at the bottom allow you to define auxiliary and other parameters such as PMAR and DVMS.

AuxIn range Click on the drop down selection to select the DC range.

Select All Will only select the parameters shown and will not select the check box of the Auxiliary selector at the bottom.

Channel / Window Selections



These selections are NOT AVAILABLE when changing an EXISTING measurement. [Learn how to change a measurement.](#)

Channel Number Select the channel for the new traces.

Create in New Window

- Check to create new traces in a new window.
- Clear to create new traces in the active window. When the [traces per window limitation](#) has been reached, no more traces are added.

[About Measurement Parameters](#) (top of page)

Balanced Source / Topology dialog box help

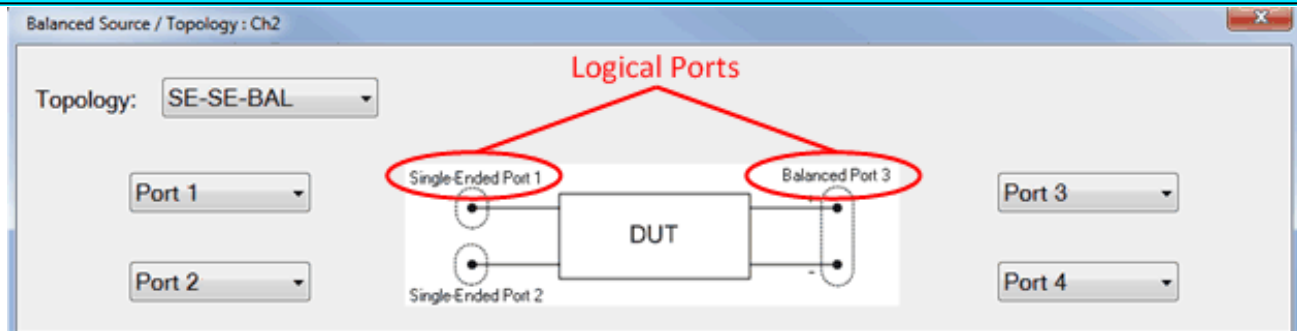

Create or edit DUT Topology and Logical Port Mapping.

A Logical Port is a term used to describe a physical analyzer test port that has been remapped to a new port number. You can assign logical single-ended ports to logical balanced ports.

Note: These selections apply to ALL measurements in the channel. If the device topology is changed, any existing measurements in the channel that are incompatible with the new topology will be automatically changed to one that is compatible.

Topology: Describes your DUT as you would like it tested. The following device topologies can be measured by a multiport analyzer.

- **Balanced / Balanced**
(2 logical ports - <4 actual ports>)
- **Single-ended / Balanced**
(2 logical ports - <3 actual ports>)
- **Single-ended - Single-ended / Balanced**
(3 logical ports - <4 actual ports>)

These topologies can be used in the reverse (<==>) direction to measure:

- **Balanced / Single-ended** topology
- **Balanced / Single-ended - Single-ended** topology

For example, to measure a **Balanced / Single-ended** topology, measure the S12 (reverse direction) of a **Single-ended / Balanced** topology.

See Also

- Learn more about [Balanced Measurements](#)
 - Balanced parameters can be saved to SNP files. [Learn more.](#)
-

Frequency Range

Frequency range is the span of frequencies you specify for making a device measurement.

- [How to Set Frequency Range](#)
- [Zoom](#)
- [CW Frequencies](#)
- [Frequency Resolution](#)

[See other 'Setup Measurements' topics](#)

How to set Frequency Range

You can also make these settings and more from the [Sweep Type](#) dialog.

See the [frequency ranges of all analyzer models](#).

Using [Hardkey/SoftTab/Softkey](#)

1. Press [Freq](#) > [Main](#) > [Start, Stop, Center](#), or [Span](#).
2. Enter desired frequency value.

Using a mouse

1. Right click on the X-axis label or stimulus range area under grid line.
2. Click on [Start/Stop/Center...](#)

Frequency Start/Stop - Center/Span - Step dialog box help

[Programming Commands](#)

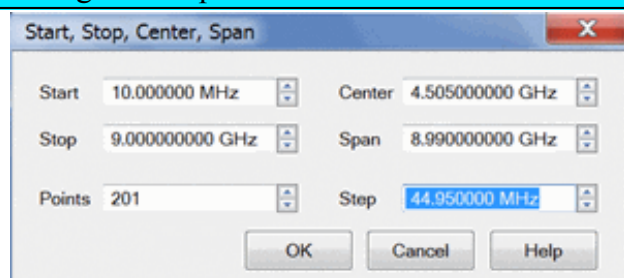

Either of the following pairs of settings determine the frequency range. The last value that you enter determines the X-Axis labels. For example, if you enter the Start and Span values, the X-Axis will show Center and Span labels.

Start /Stop - Specifies the beginning and end frequency of the swept measurement range.

Note: The start frequency at preset is not the minimum value in full range.

Center /Span - Specifies the value at the center and frequency range.

Either of the following settings determine the number of evenly-spaced data points across the frequency range.

Points - Specifies the number of evenly-spaced data points across the frequency range. [Learn more about Data Points.](#)

Step - Available ONLY in **Linear sweep type**. Specifies the frequency step size between evenly-spaced data points. Changes to this setting will cause the Points setting to adjust to the closest integer. Any 'remainder' will adjust either the Stop value or Span value depending on which is displayed on the X-Axis label.

Zoom

Zoom allows you to easily change the start and stop frequencies or start and stop power levels in a **power sweep**.

Zoom operates on the **Active Trace** and all traces in the same channel as the active trace, regardless of the window in which they appear.

How to Zoom in a measurement window

1. Left-click the mouse or use a finger, then drag across a portion of a trace.
2. Release the mouse or lift the finger and the following menu appears:
3. Select from the following:
 - **Zoom** - changes the channel stimulus settings to the left and right border values of the Zoom selection
 - **Zoom xy** - changes the channel stimulus settings as above. In addition, the Y-axis scale of the active trace changes to the approximate scale of the Zoom selection.
 - **Zoom Full Out** - changes the channel stimulus settings to the full span of the current calibration. If no calibration is ON, then the stimulus settings are changed to the full span of the VNA model.

Notes

- The stimulus settings are changed for **ALL** traces in the active channel, regardless of the window in which they appear.

- If markers are in the selected area, they remain in place.
- If markers are in the unselected area, they are moved to the right or left edge of the new span. When Zoom Full Out is selected, the markers are moved back to their original location.

Zoom is NOT available for the following:

- Smith Chart or Polar **display formats**
- **CW Time** and **Segment sweep type**

CW Frequencies

Measurements with a **CW Time sweep** or **Power sweep** are made at a single frequency rather than over a range of frequencies.

How to set CW Frequency

Using **Hardkey/SoftTab/Softkey**

1. Set **Sweep Type** to **CW Time** or **Power Sweep**.
2. Press **Freq > Main > CW**.
3. Enter desired CW frequency.

Using a mouse

1. Set **Sweep Type** to **CW Time** or **Power Sweep**.
2. Right click on the stimulus range area under grid box.
3. Click on **CW...**

Programming Commands

CW Frequency dialog box help

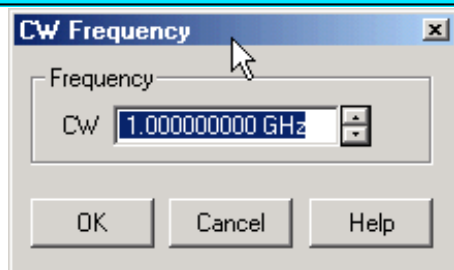

CW Type a value and the first letter of the suffix (k,m,or g) or use the up and down arrows to select any value within the range of the VNA.

Frequency Resolution

The resolution for setting frequency is 1 Hz.

Power Level

Power level is the power of the source at the test ports.

- [How to make Power Settings](#)
- [Power Dialog](#)
- [Power and Attenuator Dialog](#)
- [Power ON and OFF during Save / Recall and Preset](#)
- [Power ON and OFF during Sweep and Retrace](#)

[See other 'Setup Measurements' topics](#)

Power Settings

The test port output power is specified over frequency.

See the [Power Range specifications](#) for your analyzer.

How to make Power settings

Use one of the following methods to set port power.

Using **Hardkey/SoftTab/Softkey**

1. Press **Power** > **Main** > **Power Level** / **Start Power** / **Stop Power** to enter desired power level.
2. Press **Power** > **Main** > **RF Power** to turn ON or OFF the RF power.
3. Press **Power** > **Leveling & Offsets** > click left side **Slope** small button to turn ON or OFF the slope (Green color means the slope is turned ON; Grey color means the slope is turned OFF).

Using a mouse

1. Right click on the X-axis label or stimulus range area under grid line.
2. Click **Power....** and then **Power: Channel N** dialog box appears.

[Programming Commands](#)

[Power dialog box help](#)

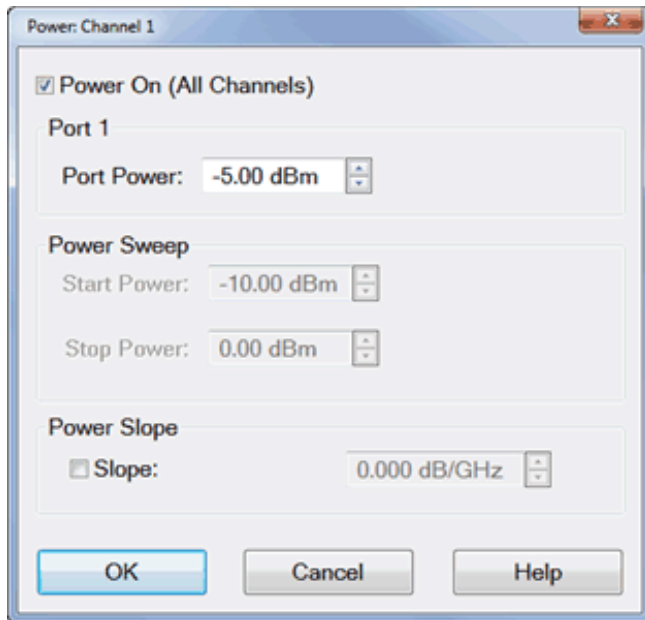

This dialog provides basic control of source power for a specific port.

See [Power and Attenuators dialog box](#).

Power On (All Channels) Check to enable source power for all channels. Only turns power ON if channel power setting is ON or Auto.

Port 'n' Active source port for which power is being set.

Port Power Sets the power level for the specified port.

Power Sweep

Start / Stop Power Set the start and stop power values of a power sweep.

- These settings are only available when [Sweep Type](#) is set to Power Sweep.
- Uncoupled power sweep power can be set from the [Advanced Power dialog](#).
- You can **Zoom** to easily change the start and stop power levels in a power sweep. [Learn how](#).
- [Learn more about Power Sweep](#).

Power Slope

Helps compensate for cable and test fixture power losses at increased frequency.

Slope Select to set the power slope. Clear to set power slope OFF. [Learn more about power slope](#).

How to make Power settings

Use one of the following methods to set port power.

Using **Hardkey/SoftTab/Softkey**

1. Press **Power** > **Main** > **Power and Attenuators** and then the **Power and Attenuators** dialog box appears.

Detailed settings for Power and Attenuators:

1. Press **Power** > **Main** > **RF Power** to turn ON or OFF the RF power.
2. Press **Power** > **Port Power** > **Select Port x** to active the selected port.
3. Press **Power** > **Port Power** > **Power Level / Start Power / Stop Power** to enter desired power level for selected port.
4. Press **Power** > **Port Power** > **Source State** to choose the source state either Auto, On or Off.
5. Press **Power** > **Port Power** > **Coupling** to turn ON or OFF Power Coupling.
6. Press **Power** > **Leveling & Offsets** > click left side **Slope** small button to turn ON or OFF the slope (Green color means the slope is turned ON; Grey color means the slope is turned OFF).

Programming Commands

Power and Attenuators dialog box help

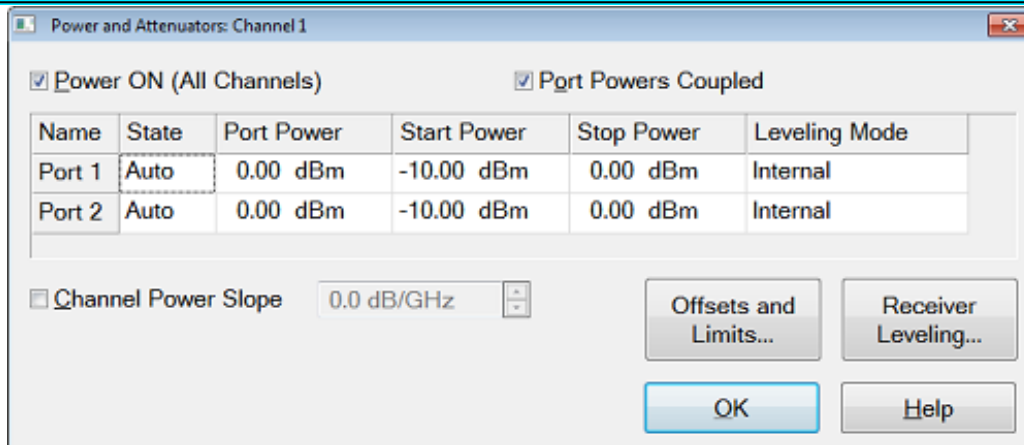

Defines and controls the source power and attenuation for the active channel.

External sources can be controlled from this dialog. [Learn more.](#)

Power On (All Channels) Check to enable source power for all channels (same function as **RF**

Power). Only turns power ON if channel power setting is ON or Auto.

Port Powers Coupled

- **Coupled** (checked) The power levels are the same at each test port. Set power at any test port and all test ports change to the same power level.
- **Uncoupled** (cleared) The power levels are set independently for each test port. Uncouple power, for example, if you want to measure the gain and reverse-isolation of a high-gain amplifier. The power required for the input port of the amplifier is much lower than the power required for the output port. A power sweep can also be performed with uncoupled power.

Name Lists the analyzer test ports.

State

- **Auto** Source power is turned ON at the specified test port when required by the measurement. This is the most common (default) setting. See also [Power ON and OFF during Save / Recall, User Preset, and Preset](#).
- **ON** Source power is ALWAYS ON, regardless of measurements that are in process. Use this setting to supply source power to a DUT port that always requires power, such as an LO port. This could turn OFF power at another test port.
- **OFF** Source power is never ON, regardless of the measurement requirements. Use this setting to prevent damage to a sensitive DUT test port.

Port Power Sets the power level at the output of the source.

- To accurately set the power level at any point after the test port, perform a [Source Power Calibration](#).
- See [specified power range of VNA model](#).
- See [ECal Module Compression Level](#)

Start / Stop Power Available ONLY when sweep type is set to Power Sweep. Set the start and stop power values of a power sweep. [Learn how to set Power Sweep](#).

- You can specify whether to maintain source power at either the start power or stop power level at the end of a power sweep. [Learn more](#).
- A power sweep can be performed with [uncoupled power](#). Different power ranges can be swept in the forward and reverse directions.

Leveling Mode (ALC Hardware Softkey)- Refer to the following diagram:

- **Internal** - Source correction factors are used to provide a flat output power within specifications. NO internal circuitry is used to level the output power. Therefore, the source will NEVER become unlevelled.
(M9485A) ALC leveling
- **Open Loop** - No ALC. The source power level accuracy is very compromised.
(M937xA/P937xA/M980xA/P50xxA do not support this.)
- **Receiver Rx** - Receiver Leveling. Select a receiver to use for leveling the source. [Learn more.](#)

Channel Power Slope

Helps compensate for cable and test fixture power losses at increased frequency. With power slope enabled, the port output power increases (enter positive value) or decreases (enter negative value) as the sweep frequency increases.

Slope Select to set the power slope. Clear to set power slope OFF.

Power slope is computed and applied from 0 GHz – not from the measurement start frequency.

For example, with the following measurement settings:

- Start / Stop Freq: 10 GHz to 20 GHz
- Power level: 0 dBm
- Slope: 1 dB/GHz

The power into the DUT from 10 GHz to 20 GHz is 10 dBm sloping to 20 dBm

Offset and Limits Launches the [Power Offset and Limits](#) dialog.

Receiver Leveling Launches the [Receiver Leveling](#) dialog.

Receiver Attenuator Launches the [Receiver Attenuator](#) dialog. (M9485A with M9377A only)

Source Unleveled

When the power level that is required at a test port is **higher** than can be supplied, a Source Unleveled [error message](#) appears on the screen and the letters LVL appear on the [status bar](#).

To resolve an unleveled condition, change either the Test Port Power or Attenuator setting.

Important Note: The available power range can also be adjusted AUTOMATICALLY by a Source Power Calibration, Guided Power Cal, or Power Compensation. If you are NOT seeing the range that you expect, or the correct power level at your DUT, view the Power Offset column in the [Power Limits and Offsets dialog](#).

Receiver Attenuators dialog box help

Receiver Attenuation is used to protect the VNA test port receivers from damage or compression.

M9485A (with M9377A only)

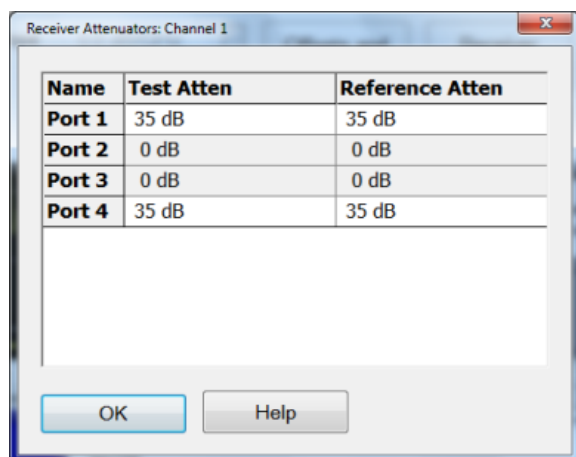

Attenuator level can be set either 0 dB or 35 dB for each receiver attenuator per channel. This setting is valid when segment sweep mode is not selected. When the segment sweep mode is selected, the setting in the segment is applied. Test attenuator and reference attenuator can be set independently.

CAUTION! You can damage the analyzer receivers if the power levels exceed the maximum values.

- See [Technical Specifications](#) for the maximum input power to a receiver and receiver compression.
- See [Receiver attenuation values for your VNA model](#).

Power ON and OFF during Save / Recall, User Preset, and Preset

To protect your DUT from being inadvertently powered ON, the following RF Power ON/OFF settings occur:

Instrument State Save/Recall

If power is OFF when an instrument state is saved, then power will always be OFF after the instrument state is recalled.

If power is ON when an instrument state is saved, and the current power setting is OFF, then power will be OFF after the instrument state is recalled.

Preset

Instrument Preset sets power ON by default.

This can be changed with a **Preference setting** so that, if the current power setting is OFF, then power will be OFF after Preset.

Power ON and OFF during Sweep and Retrace

Source power is NOT turned OFF during M937xA/P937xA frequency band crossings or during sweep retrace.

Caution: Avoid expensive repairs to your analyzer. Read **Electrostatic Discharge Protection**.

Receiver Leveling

Note: The M937xA/P937xA does not support this function.

Receiver Leveling adjusts the source power until the measured receiver power is equal to the Port Power.

In this topic:

- [Overview](#)
- [Receiver Leveling Process](#)
- [Features and Limitations](#)
- [How to make Receiver Leveling settings](#)
- [Receiver Leveling dialog box help](#)
- [Initial Power Selection](#)

See other '[Setup Measurements](#)' topics

Overview

Receiver Leveling uses receiver measurements to adjust the source power level across a frequency or power sweep. Before each measurement sweep, a variable number of background sweeps are performed to repeatedly measure power at the receiver for each stimulus point. Those power measurements are then used to adjust the source power level and achieve greater source power level accuracy.

This is similar to a [Source Power Calibration](#) which makes a **single sweep** to measure source power. The source power correction values are applied for all subsequent measurement sweeps. Because Receiver Leveling is performed for **every measurement sweep**, it provides more accurate source power levels, but also takes longer to perform each measurement sweep.

Note: Enabling [Safe Mode](#) when using receiver leveling may be necessary to ensure stable results.

Receiver Leveling Process

Leveling sweeps are performed in the background (not visible) before every measurement sweep to measure and apply source correction data.

1. For each leveling sweep, source power is applied at each data point and measured by the specified receiver. [Learn how the initial power level is selected.](#)
2. The deviation is calculated between the measured power and the port power.
3. The deviation is applied to the current source power, and the updated source power levels are applied on the following leveling sweep.
4. This process continues until the receiver power at each data point has achieved the port power within the specified tolerance value, or until the specified number of leveling sweeps (iterations) has been reached.

Features and Limitations

- Receiver Leveling can be used with most [sweep types](#), including Segment sweep and Power sweep.
- Receiver Leveling is ALWAYS enabled for the controlled source when Phase Control (Opt S93088A/B) is enabled.
- Receiver Leveling is available for standard S-parameter measurements and with [FCA](#), [GCA](#), and [IMD](#) applications.
- Turn ON Receiver Leveling **before** or **after** doing a Calibration. When turned ON before calibrating, it is turned OFF during the calibration, then back ON after calibration.
- Power Offset on the [Offsets and Limits dialog](#) can be used when there exists an additional attenuator or booster amplifier in the source path. An offset should be set to improve the leveling speed. This power offset is automatically used to set the port power.

Use Receiver Leveling for the following:

- Correcting for short term drift when using an external component, such as a booster amplifier. The booster amplifier must be connected to the front-panel jumpers, in front of the reference receiver. See the Block diagram for your VNA, located at the end of every [Specifications document](#).
- Extending the accuracy of power leveling at very low powers where the internal detector may be too noisy.
- Providing controlled power during [Pulsed measurements](#) in an open loop mode.
- Controlling the power at the outputs of MM-Wave heads.

Note: Increase the sweep delay if output power is not accurate when Receiver Leveling is applied to two or more ports.

How to make Receiver Leveling settings

Start the **Power and Attenuators** dialog box as follows:

Using **Hardkey/SoftTab/Softkey**

1. Press **Power** > **Main** > **Power and Attenuators....**
2. On the Power and Attenuators dialog, click **Receiver Leveling** button.

Using a mouse

1. Click **Stimulus, Power**, then **Power and Attenuators.**
2. On the Power and Attenuators dialog, click **Receiver Leveling** button.

◀ **Programming Commands** ▶

Receiver Leveling dialog box help

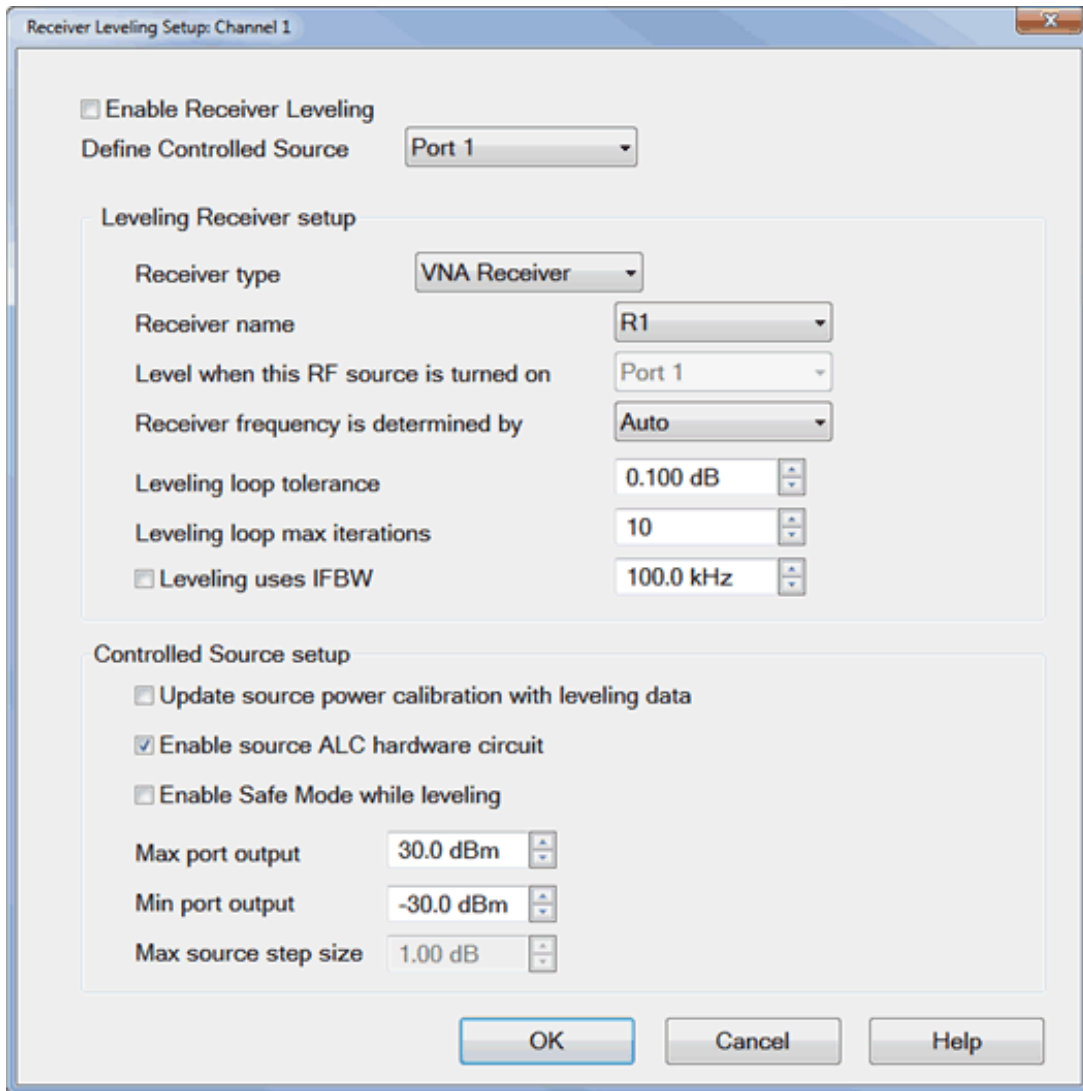

[Learn about Receiver Leveling](#) (scroll up).

Enable - Checkbox enables/disables receiver leveling. The default is disabled (unchecked).

Define Controlled Source (Port)

Each source port to be leveled is configured individually. Select a source to be configured for receiver leveling. Choose from: Port 1, Port 2, Port 3, Port 4, or any active external source. [Learn more about External Devices](#).

Leveling Receiver Setup

Receiver Type Receiver type does an initial sort to make it easier to select a receiver. Choose from: VNA Receiver or Ext. Device (**PMAR**).

Receiver Select a receiver to be used to level the specified source.

For VNA Receiver type, choose from any VNA receiver using standard or receiver notation.

To level power at the source output or DUT input choose the reference receiver for the source port. For example, to level the source power at port 1, then choose "R1". To level power at the DUT output, choose the receiver that is used to measure the DUT output. If the DUT output is connected to port 2, then select "B" or "b2". [Learn about Receiver Notation](#).

When Phase Control is enabled, the ratioed receivers used in Phase Control are selected and can NOT be changed. However, the Reference Source CAN also be selected for Receiver Leveling.

For Ext Device type, choose a configured PMAR device.

Level when this RF source is turned ON: The Controlled Source is selected automatically and can NOT be changed.

Receiver frequency is determined by: Available ONLY when the selected receiver is a VNA Receiver or power meter. This setting determines which receiver frequencies are measured. Choose from:

- **Auto** - always uses the frequency range that is assigned to the measurement receiver.
- **FOM Receiver** - FOM Receiver frequency range. Learn more about [Frequency Offset Mode](#).
- **FOM Source** - FOM Source frequency range.
- **DUT Input** - Mixer/Converter input frequency range.
- **DUT Output** - Mixer/Converter output frequency range.

Leveling Loop Tolerance The source is considered leveled when each stimulus data point has achieved the power level +/- (plus or minus) this tolerance value.

Leveling Loop Max Iterations If every stimulus data point does NOT achieve the port power after this number of leveling sweeps, the measurement sweep occurs using the correction values obtained from the last leveling sweep. The message: **Not settled, noisy trace** appears when the Max Iterations is reached. If you see this message, you can increase the Max Iterations, reduce the IFBW, or increase the Tolerance setting.

Note: If the Max Iterations is set to zero, there will be no pre-sweep for the receiver leveling, but the value of the receiver data will be used to correct the next sweep. In this way setting the value to zero provides a post sweep correction and can be useful for correcting slow drift in a system where a booster amplifier or open loop ALC is used, without adding pre-sweeps to the sweep-acquisitions.

Leveling IFBW Available only for VNA receivers. By default, the IFBW for the leveling sweeps is set to 100 kHz. [Learn more about IFBW.](#)

- Increase this value to make faster, but noisier leveling sweeps.
- Decrease this value to make slower, more repeatable leveling sweeps.
- Uncheck the box to use the same IFBW as the measurement sweeps.

Controlled Source Setup

Update source power calibration with leveling data Available only when using an RF Source and VNA receiver.

- When checked, the latest correction data is copied to the Source Power Cal correction array. When Leveling Mode is switched back to Internal (on the Power and Attenuators dialog), **Source Power Cal** is automatically turned ON using this correction data.
- When cleared, Source Power Cal is NOT turned ON when Leveling Mode is switched back to Internal.

Enable Source ALC hardware circuit (Not available on M980xA/P50xxA)
NOT available with External sources.

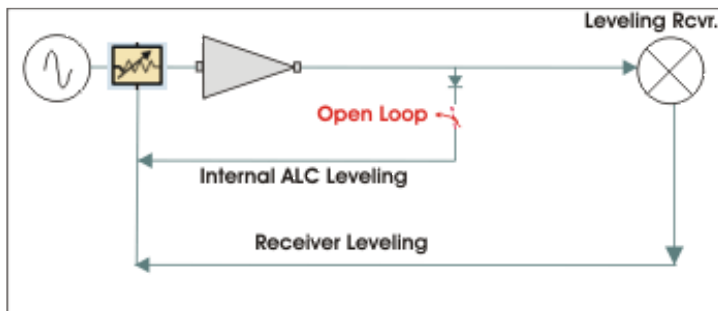

- **Checked** - Internal ALC leveling and Receiver Leveling (Recommended).
- **Cleared** - NO ALC leveling; Receiver Leveling ONLY.

Enable Safe Mode while leveling

To protect your DUT and ensure stable results, these settings control the extent to which the source power will be changed to achieve the port power as measured at the reference receiver. These settings could be necessary when using external components with a large variation in frequency response (flatness).

When checked:

- The Min source output is used as the initial power level for the leveling loop process.
- The controlled source is never stepped more than the Max source step size.

When cleared:

- The initial power for the leveling loop may be determined by the Min source output, the Max source output, the last setting of the leveling loop, or the target value of the leveling loop. [See Initial Power below.](#)
- The Max source step size is ignored.

Max source step size When Safe Mode is enabled, the change in source power at each data point from one sweep to the next is limited to this value. For example, assume Safe Mode is enabled, and Max Power Step is set to 1 dB. On the first leveling sweep, the first data point measures 3 dB lower than the port power, then source power for data point 1 will be increased by 1 dB for the next sweep, and likely for the following two sweeps.

Max port output Always limits the maximum power out of the source to this value. The message: **Power set to Max Power** appears when this limit is reached.

If the maximum port power out of the VNA is reached at any time during the leveling sweeps, the following message appears: **Power set to user power limit.**

Min port output Always limits the minimum power out of the source to this value. The message: **Power set to Min Power** appears when this limit is reached. When Safe Mode is enabled, this value is used as the initial power level for the leveling loop process.

Note: The MAX/MIN limit is always used regardless of the safe mode state. In addition, the MAX/MIN limit is for port power and related to power offset. If the power offset is not set correctly, the MAX/MIN limit is not correct and it may impact the leveling. Ensure that the power offset in the channel is the same as power offset during calibration. If the exact power offset is not known, choose a limit for source and then it will not be related to power offset.

Initial Power Selection

For each displayed data point, the leveling algorithm must select an initial power to begin the iteration process. This value is chosen as follows:

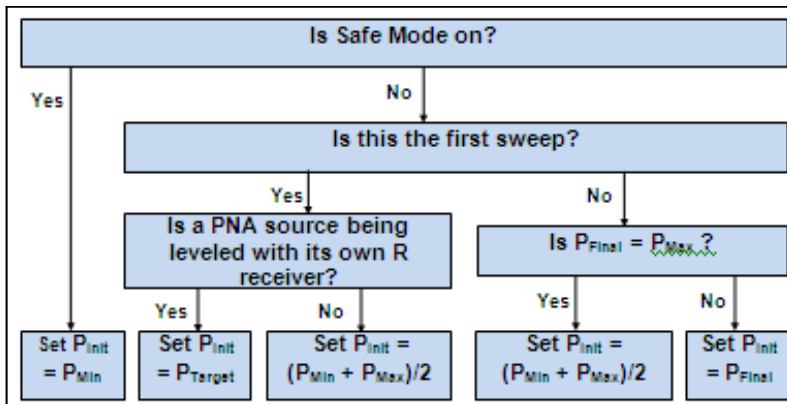

Where:

P_{Init} = the initial power for the iteration process.

P_{Final} = the final power setting from the previous leveled sweep.

P_{Min} = the minimum controlled source output level as specified in the Receiver leveling setup.

P_{Max} = the maximum controlled source output level as specified in the Receiver leveling setup.

P_{Target} = the target power level for the selected leveling receiver.

Sweep Settings

A sweep is a series of consecutive data point measurements taken over a specified sequence of stimulus values. You can make the following sweep settings:

- [Number of Points](#) (Separate topic)
- [Sweep Type](#)
 - [Linear / Log](#)
 - [Power Sweep](#)
 - [CW Time](#)
 - [Segment Sweep](#)
- [Frequency Range: Start/Stop](#) (Separate topic)
- [Power Sweep](#)
- [Segment Sweep](#)
 - [How to make segment sweep settings](#)
 - [Segment Table dialog](#)
- [X-Axis Point Spacing - Segment Sweep ONLY](#)
- [Arbitrary Segment Sweep](#)
- [Sweep Time](#)
- [Sweep Setup](#)
 - [Fast Sweep](#)
 - [Auto vs Stepped](#)
 - [Dwell and Delay](#)
 - [Standard vs Point Sweep](#)

See [Triggering](#) and other '[Setup Measurements](#)' topics

How to set Sweep Type

Using **Hardkey/SoftTab/Softkey**

1. Press **Sweep > Main > Sweep Type**.

Using a mouse

1. Right click on the **stimulus range** area under grid box.
2. Click **Sweep Setup....**
3. Select **Sweep Type** tab and select type.
4. Click **Apply** to implement the setting changes.

Sweep Type dialog box help

Programming Commands

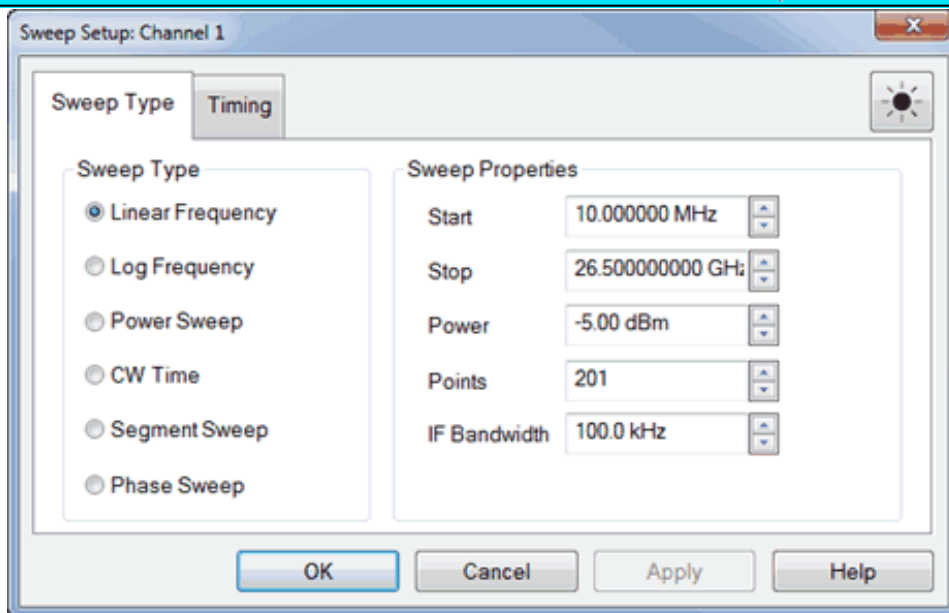

Note: Sweep Settings are not applied until either **OK** or **Apply** is pressed.

Channel The active channel when Sweep Type was selected. Sweep settings will be applied to this channel.

Sweep Type

Linear Frequency Sets a linear frequency sweep that is displayed on a standard grid with ten equal horizontal divisions.

- **Start** Sets the beginning value of the frequency sweep.

- **Stop** Sets the end value of the frequency sweep.
- **Points** Sets the number of data points that the analyzer measures during a sweep. Range: 2 to 20001.(Default is 201).
- **Power** - Sets the power level or the source. [Learn more.](#)
- **IF Bandwidth** - Sets the IF (Receiver) bandwidth. [Learn more.](#)

Log Frequency The source is stepped in logarithmic increments and the data is displayed on a logarithmic x-axis. This is usually slower than a continuous sweep with the same number of points.

- **Start** Sets the beginning value of the frequency sweep.
- **Stop** Sets the end value of the frequency sweep.
- **Points** Sets the number of data points that the analyzer measures during a sweep. Range: 2 to 20001. (Default is 201).
- **Power** - Sets the power level or the source. [Learn more.](#)
- **IF Bandwidth** - Sets the IF (Receiver) bandwidth. [Learn more.](#)

Power Sweep Activates a power sweep at a single frequency that you specify. [Learn about power sweep](#)

- **Start** Sets the beginning value of the power sweep.
- **Stop** Sets the end value of the power sweep.
- **CW Frequency** Sets the single frequency where the analyzer remains during the measurement sweep.
- **Points** Sets the number of data points that the analyzer measures during a sweep. Range: 2 to 20001. (Default is 201).
- **IF Bandwidth** - Sets the IF (Receiver) bandwidth. [Learn more.](#)

CW Time Sets the analyzer to a single frequency, and the data is displayed versus time. [Learn more.](#)

- **CW Frequency** Sets the frequency where the analyzer remains during the measurement.
- **Sweep Time** Sets the duration of the measurement, which is displayed on the X-axis.
- **Points** Sets the number of data points that the analyzer measures during a sweep. Range: 2 to 20001.(Default is 201).

- **IF Bandwidth** - Sets the IF (Receiver) bandwidth. [Learn more](#).

Segment Sweep Sets the analyzer to sweep through user-defined sweep segments. [Learn how to make these settings](#).

OK Applies setting changes and closes the dialog box.

Apply Applies setting changes and leaves the dialog box open to make more setting changes.

Cancel Closes the dialog. Setting changes that have been made since the last Apply button click are NOT applied.

Help - Display the **Sweep Type** dialog box help.

Power Sweep

A power sweep either increases or decreases source power in discrete steps. Power sweep is used to characterize power-sensitive circuits, with measurements such as gain compression.

In the Sweep Type dialog, specify Start power, Stop power, and CW Frequency. Power can be swept over any attainable range within the [analyzer ALC range](#).

The remaining power settings apply in power sweep mode:

- Test Port Power setting is not available.
- Port Power can be coupled or uncoupled.
- Attenuator Control is always Manual.
- Power Slope (dB/GHz) is ignored (output frequency is CW).
- Press **Sweep** > **Main** > **Number of Points** to change the step size of the power sweep.

Notes:

- Using a [preference setting](#), you can specify whether to maintain source power at either the start power or stop power level at the end of a power sweep.
- Power Sweep is optimized for speed. For highest measurement accuracy during a power sweep, it may be necessary to increase the [Dwell Time](#) to allow the source more time to settle.

Segment Sweep

Segment Sweep activates a sweep which consists of frequency sub-sweeps, called segments. For each segment you can define independent power levels, IF bandwidth, and sweep time.

Once a measurement calibration is performed on the entire sweep or across all segments, you can make calibrated measurements for one or more segments.

In segment sweep type, the analyzer does the following:

- Sorts all the defined segments in order of increasing frequency
- Measures each point
- Displays a single trace that is a composite of all data taken

Restrictions for segment sweep:

- The frequency range of a segment is not allowed to overlap the frequency range of any other segment.
- The number of segments is limited only by the combined number of data points for all segments in a sweep.
- The combined number of data points for all segments in a sweep cannot exceed the **max number of data points per trace**.

How to make segment sweep settings

Using **Hardkey/SoftTab/Softkey**

1. Press **Sweep > Segment Table > Segment Table...**

Using a mouse

1. Right click on the X-axis label or stimulus display area under grid line.
2. Click **Sweep Setup...** then select **Segment Sweep** under sweep type.
3. Click **Segment Table...**

Programming Commands

Segment Table dialog box help

Segment Table Softkeys

Add Segment - adds a sweep segment at last segment.

Insert Segment - adds a sweep segment before the selected segment. You can also click the "down"

arrow on your keyboard to quickly add many segments.

Delete Segment - removes the selected segment.

Delete All Segments - removes all segments.

Note: At least ONE segment must be ON or **Sweep Type** is automatically set to **Linear**.

Segment Table dialog box

X-Axis Point Spacing - Check to scale the X-axis to include only the segments. [Learn more](#).

Allow Arbitrary Segments - Check to allow arbitrary frequencies (overlapped or reverse sweep). [Learn more](#).

Display Center/Span Freq - Check to display the center/span frequency.

Independent Setting Per Segment

Power Level - Sets the **Power level** for the segment. Also, the test port power can UNCOUPLE. See [Power Coupling](#).

IF Bandwidth - Sets the **IF Bandwidth** for the segment.

IF Bandwidth Per Port - Sets the different bandwidth with different port for the segment.

Sweep Time - Sets the **Sweep time** for the segment.

Dwell Time - Specifies the time the source stays at each measurement point before the analyzer takes the data.

Vector Averaging - Enables SA vector average for the segment.

Video Bandwidth - Enables SA video bandwidth for the segment.

Delay - Sets the time to wait just before acquisition begins for each segment.

Sweep Mode - Sets the sweep mode to auto or stepped.

Shift LO - Sets the state of Shift LO.

Receiver Atten Per Port - Enables receiver attenuation per port for the segment.

Receiver Gain - Sets **Receiver Gain**.

Reference Tone - Enables SA multitone reference for the segment.

SA Data Threshold - Enables SA data threshold for the segment.

Save Table - Saves the setting changes in segment table.

Load Table - Apply the setting changes in segment table.

To Modify an Existing Segment

To make the following menu settings available, the segment table must be displayed first. (Press **Sweep** > **Segment Table**).

State - Click the box on the segment to be modified. Then, use the up/down arrow to turn the segment ON or OFF.

Start - Sets start frequency for the segment. Click the box and type a value and the first letter of a suffix (**KHz**, **Mhz**, **GHz**). Or double-click the box to select a value.

Stop - Sets stop frequency for the segment. Click the box and type a value and the first letter of a suffix (**KHz**, **Mhz**, **GHz**). Or double-click the box to select a value.

Note: The segment table truncates the frequency resolution. To verify the frequency resolution that you input, create a marker at the start or stop frequency settings.

Points - Sets number of data points for this segment. Insert a value or double-click the box to select a value.

To set **Power Level**, **IF Bandwidth/IF Bandwidth Per Port**, **Sweep Time**, **Delay**, **Receiver Attenuator Per Port**, **Sweep Mode** and **Shift LO** independently for each segment:

1. Press **Sweep** > **Main** > **Sweep Type** > **Segment Sweep**.
2. Click on **Segment Table** > **Segment Table...**
3. Check the box corresponding to the segment setting to set then click **OK**.
4. Click in the box at the bottom of the display and use the up/down arrows to enter a value or double-click the box and select a value with the numeric keypad.

Note: If the following are NOT set, the entire sweep uses the channel IFBW, Power, and Time

settings.

X-Axis Point Spacing - Segment Sweep ONLY

This feature affects how a segment trace is drawn on the screen.

How to select X-Axis Point Spacing

Using **Hardkey/SoftTab/Softkey**

1. Press **Sweep** > **Segment Table**. > **Segment Table...**
2. Check **X-Axis Point Spacing**.

Using a mouse

1. Right click on the X-axis label or stimulus display area under grid line.
2. Click **Sweep Setup...** then select **Segment Sweep** under sweep type.
3. Click **Segment Table...**
4. Check **X-Axis Point Spacing**.

Programming Commands

- **Without X-axis point spacing**, a multi-segment sweep trace can sometimes result in squeezing many measurement points into a narrow portion of the x-axis.
- **With X-axis point spacing**, the x-axis position of each point is chosen so that all measurement points are evenly spaced along the x-axis.

For example, given the following two segments:

	STATE	START	STOP	POINTS
1	ON	45.000000 MHz	50.000000 MHz	21
2	ON	170.000000 MHz	180.000000 MHz	21

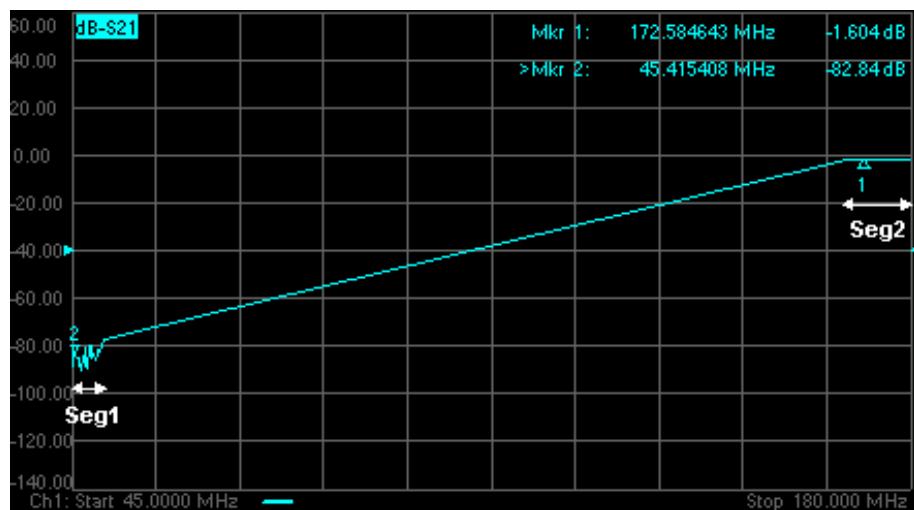

Without X-Axis Point Spacing

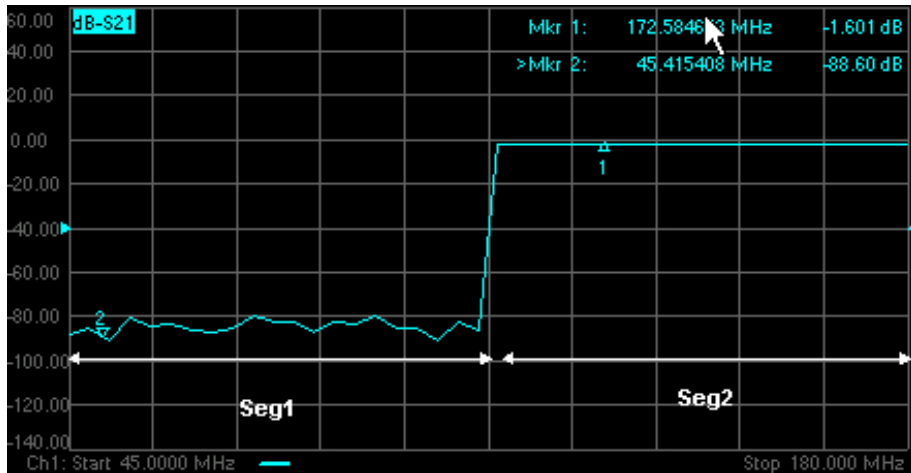

With X-Axis Point Spacing

Arbitrary Segment Sweep

This feature allows arbitrary frequencies to be entered into the segment sweep table. With this capability, segments can have:

- overlapping frequencies.
- the stop frequency less than the start frequency (reverse sweep).

However, there are several limitation:

- Sweep mode: Stepped only.
- Sweep time: When reverse sweep is performed, the sweep time and the wait time before the measurement point becomes longer.

How to enable Arbitrary Segment Sweep

Using **Hardkey/SoftTab/Softkey**

1. Press **Sweep** > **Segment Table**. > **Segment Table...**
2. Check **Allow Arbitrary Segments**.

Using a mouse

1. Right click on the X-axis label or stimulus display area under grid line.
2. Click **Sweep Setup...** then select **Segment Sweep** under sweep type.
3. Click **Segment Table...**
4. Check **Allow Arbitrary Segments**.

Programming Commands

Notes:

- Unusual results may occur when using arbitrary sweep segments with markers, display settings, limit lines, formatting, and some calibration features.
- When Allow Arbitrary Segments is checked, **X-axis point spacing** is automatically turned ON.
- When the segment table has both forward and reverse frequency sweep, the correction interpolation may not work properly. Use the same segment table setting for both correction and measurement. (Make a measurement at the condition where "Cor" is displayed.)
- When the measurement data size of segment table exceeds its limitation, an error occurs. In this case, reduce the measurement data size (i.e., NOP, number of channels).

Sweep Time

The analyzer automatically maintains the fastest sweep time possible with the selected measurement settings. However, you can increase the sweep time to perform a slower sweep.

How to set Sweep Time

Using **Hardkey/SoftTab/Softkey**

1. Press **Sweep** > **Sweep Timing** > **Sweep Time**.
2. Input the desired sweep time.

Using a mouse

1. Right click on the X-axis label or stimulus range area under grid line.
2. Click on **Sweep Setup....**
3. Select **Timing** tab.
4. Deselect the **Auto Sweep Time** box.
5. Input the desired sweep time.

Time dialog box help

Programming Commands

Sweep Time Specifies the time the analyzer takes to acquire RF data for a sweep. The maximum sweep time of the analyzer is 86400 seconds or 1 day. [Learn about other settings that affect sweep speed.](#)

Note: When a channel has an Aux In or SMU trace, the measurement time for DC voltage/current will be added.

Note: Ignore CW time as labeled on the X-axis and marker readout. It is NOT at all accurate.

Sweep Setup

How to make Sweep Setup settings

Using **Hardkey/SoftTab/Softkey**

1. Press **Sweep** > **Sweep Timing**.

Using a mouse

1. Right click on the X-axis label or stimulus range area under grid line.
2. Click on **Sweep Setup....**
3. Select **Timing** tab.

Sweep Setup dialog box help

Programming Commands

Time

Sweep Time - same as [Sweep Time Softtab Help](#).

Dwell Time - Specifies the time the source stays at each measurement point before the analyzer takes the data. Only applies to stepped sweep. The maximum dwell time is 20 seconds. See also [Electrically Long Devices](#).

Sweep Delay - Specifies the time to wait just before acquisition begins for each sweep. This delay is in addition to Dwell Time (per point) and [External Trigger delay](#) if enabled.

Fast Sweep Available ONLY with Opt. 103. Not available on M980xA and P50xxA. When checked, in Analog Sweep mode the analyzer source settling times are shortened in both frequency and power-control (ALC) circuits. In Stepped Sweep mode, the settling time at ALL data points are shortened. This nearly doubles the sweep speed at preset conditions, but at the expense of frequency accuracy and a few dB of amplitude variation. For ratioed measurements, such as S-Parameters, these errors substantially ratio out.

- By default, Fast Sweep is always OFF to provide maximum accuracy and stability.
- Fast Sweep is NOT allowed with [Power Limit](#) enabled.
- **Note:** Performance specifications do NOT apply in Fast Sweep.

Sweep Mode

Auto - Automatic adjusts the sweep time and dwell time. When "Auto Sweep Time" is checked, the sweep time and dwell time will disable to edit.

Stepped When checked (Stepped Sweep) the analyzer source is tuned, then waits the specified Dwell time, then takes response data, then tunes the source to the next frequency point. This is slower than Analog Sweep, but is more accurate when testing electrically-long devices.

When cleared (Analog Sweep) the analyzer takes response data AS the source is sweeping. The sweep time is faster than Stepped, but could cause measurement errors when testing electrically-long devices.

When the dialog check box is cleared, the analyzer could be in either Analog or Step mode. The mode can change from sweep to sweep. There is **NO way** to determine whether the analyzer is in Analog or Stepped Sweep. If you want to be sure what the current sweep mode is, then switch it to Stepped.

Stepped sweep is automatically selected for a number of reasons. Here are some of the reasons:

- **IF Bandwidth** is at, or below, 5 kHz.
- When step mode is a faster way to take the data.
- For all **FOM** measurements.

Sweep Sequence

Note: This feature is not available on the M948xA, M980xA and P50xxA.

Standard Sweep When checked, the analyzer sweeps all data points for each source port in turn. For a 2-port analyzer, this means that all data points are swept in the forward direction, then all data points are swept in the reverse direction. Even when NO reverse parameters are displayed (S22 or S12), reverse measurements are necessary when a full 2-port calibration is correcting the channel. This is the default behavior.

Point Sweep Available ONLY on standard S-parameter channels. When checked, the analyzer measures all parameters at each frequency point before stepping to the next frequency. The display trace is updated as each data point is measured.

- Point sweep usually results in slower sweeps and is useful only in rare circumstances.
- Point sweep is the same as stepped sweep mode on the 8510 and 8530.
- **PMAR** is not compatible with Point Sweep mode.

Trigger

A trigger is a signal that causes the analyzer to make a measurement sweep. The analyzer offers great flexibility in configuring the trigger function.

View the interactive [Trigger Model](#) animation to see how triggering works.

- [How to Set Trigger](#)
- [Source](#)
- [Scope](#)
- [Channel Settings](#)
- [Restart](#)
- [External Triggering](#) (separate topic)

[See other 'Setup Measurements' topics](#)

How to set Triggering

Using [Hardkey](#)/[SoftTab](#)/[Softkey](#)

1. Press **Trigger** > **Main** > **Trigger...**

Using a mouse

1. Right click on the **Trig** or **Meas** icons on the status bar.
2. Select **Trigger...**

[Programming Commands](#)

Note: The **Continuous**, **Single**, and **Hold** settings apply ONLY to the active channel. These settings are available from the Trigger menu, Active Entry keys, and softkeys

Trigger Setup dialog box help

M937xA/P937xA/M9485A

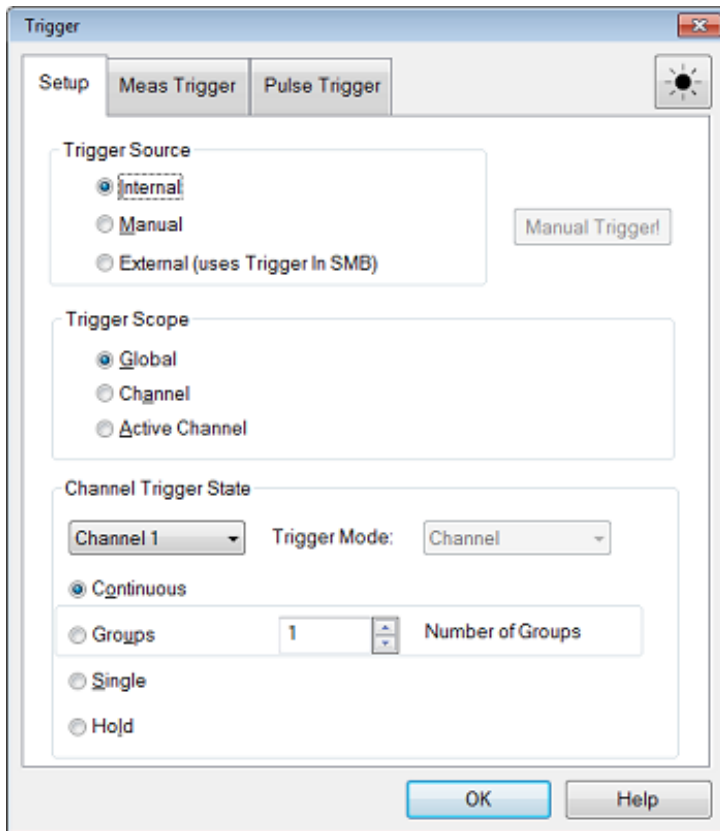

View the interactive [Trigger Model](#) animation to see how triggering works.

Trigger Source

These settings determine **where** the trigger signals originate for all existing channels. A valid trigger signal can be generated only when the analyzer is not sweeping.

Internal Continuous trigger signals are sent by the analyzer as soon as the previous measurement is complete.

Manual One trigger signal is sent when invoked by the Trigger button, the active tool bar, or a programming command.

External Trigger signals received from the trigger source. The trigger source can be defined in [External and AUX Triggering](#).

Manual Trigger! - Manually sends one trigger signal to the analyzer. Available **ONLY** when Manual trigger is selected.

Trigger Scope

These settings determine **what** is triggered.

Global All channels not in Hold receive the trigger signal [Default setting]

Channel Only the next channel that is not in Hold receives the trigger signal. This is not obvious or useful unless Trigger Source is set to Manual. This setting enables **Point Sweep** mode.

Active Channel - Trigger are sent only to the active channel. The active channel does not change.

Channel Trigger State

These settings determine **how many** trigger signals the channel will accept.

Continuous The channel accepts an infinite number of trigger signals.

Groups The channel accepts only the number of trigger signals that is specified in the Number of Groups text box, then goes into Hold. Before selecting groups you must first increment the Number of Groups text box to greater than one.

Number of Groups Specify the number of triggers the channel accepts before going into Hold. If in Point Sweep, an entire sweep is considered one group.

First increment to desired number, then select 'Groups'.

Single The channel accepts ONE trigger signal, then goes into Hold.

Another way to trigger a single measurement is to set **Trigger Source** to Manual, then send a **Manual trigger**. However, ALL channels are single triggered.

Hold The channel accepts NO trigger signals.

Trigger Mode

These settings determine what EACH signal will trigger.

Sweep and **Point** modes are available ONLY when both **Trigger Source** = MANUAL or EXTERNAL AND **Trigger Scope** = CHANNEL.

- **Channel** Each trigger signal causes **ALL traces** in that channel to be swept in the order specified below.
- **Point** Each Manual or External trigger signal causes one data point to be measured. Subsequent triggers go to the same trace until it is complete, then other traces in the same channel are swept in the order specified below. When in Groups or Single trigger, the count is decremented by one after ALL data points on ALL traces in the channel are measured. See Also, the (point) **Sweep Indicator** and **SCPI Triggering example** for use with External.

- **Trace** Available ONLY when **Point Sweep** is selected. Each trigger signal causes two identical measurements to be triggered separately - one trigger signal is required for each measurement. Other trigger mode settings cause two identical parameters to be measured simultaneously. Trace triggering is NOT permitted when a channel is using a 2 port (or more) S-Parameter calibration.
- **Sweep** Each Manual or External trigger signal causes **ALL traces that share a source port** to be swept in the order specified below. When in Groups or Single trigger, the count is decremented by one after ALL traces in ALL directions are swept.

When multiport correction is ON, which requires sweeps in more than one direction, traces on the screen will not update until all of the relevant directions have been swept. For example, with all four 2-port S-Parameters displayed:

- When Full 2-port correction is ON, trigger 1 causes NO traces to update; trigger 2 causes ALL S-Parameters to update. [Learn more about sweeps with correction ON.](#)
- When correction is OFF, trigger 1 causes S11 and S21 to update; trigger 2 causes S22 and S12 to update.

Trace Sweep Order

For ALL Trigger Modes, trigger signals continue in the same channel until all traces in that channel are complete. Triggering then continues to the next channel that is not in HOLD.

Traces within each channel are always swept in the following order:

- Traces are swept sequentially in source-port order. For example, in a channel with all four 2-port S-parameters, first the source port 1 traces (S11 and S21) are swept simultaneously. Then the source port 2 traces (S22 and S12) are swept simultaneously.
- In addition, when **Alternate sweep** is selected, traces are swept sequentially in source-port / receiver-port order. In the above example, first the S11 trace is swept, then S21, then S12, then S22.

Restart (Available only from the Trigger menu) Channels in Hold are set to single trigger (the channel accepts a single trigger signal). All other settings are unaffected, including decrementing trigger Groups.

See Also

- [External Triggering](#)
- Interactive [Trigger Model](#) animation



External and Auxiliary Triggering

External and auxiliary triggering is used to synchronize the triggering of the analyzer with other equipment.

- [Overview](#)
- How to make Trigger Settings:
 - [Auxiliary Triggering](#)
 - [Meas Trig \(IN\) Dialog](#)
 - [Pulse Triggering](#)

See Also

- [Controlling a Handler](#)
 - [Synchronizing an External Source](#)
 - [Internal Triggering](#)
 - [Pulse Triggering](#) (separate topic)
-

Overview

Ready Signals versus Trigger Signals

A 'Ready for Trigger' signal is different from a Trigger signal. The ready signal indicates that the instrument sending the signal is ready for measurement. The instrument receiving the ready signal would then send a trigger signal, indicating that the measurement will be, or has been, made. Usually the slower instrument sends the trigger signal.

Learn more about each type of triggering signal:

- [Meas Trig RDY and Meas Trig IN](#) - This pair of signals is easy to use and limited in ability to configure.
- [AUX TRIG OUT](#) - These two pair of connectors and signals are highly configurable. Use them to synchronize with any number of devices and equipment.

Meas (External) Trigger dialog box help

M937xA/P937xA

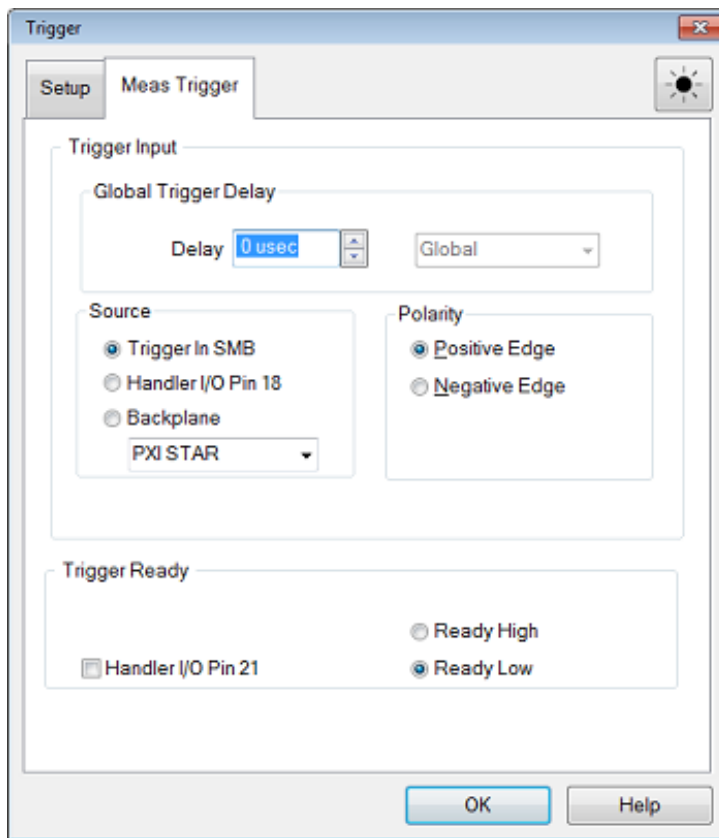

M9485A

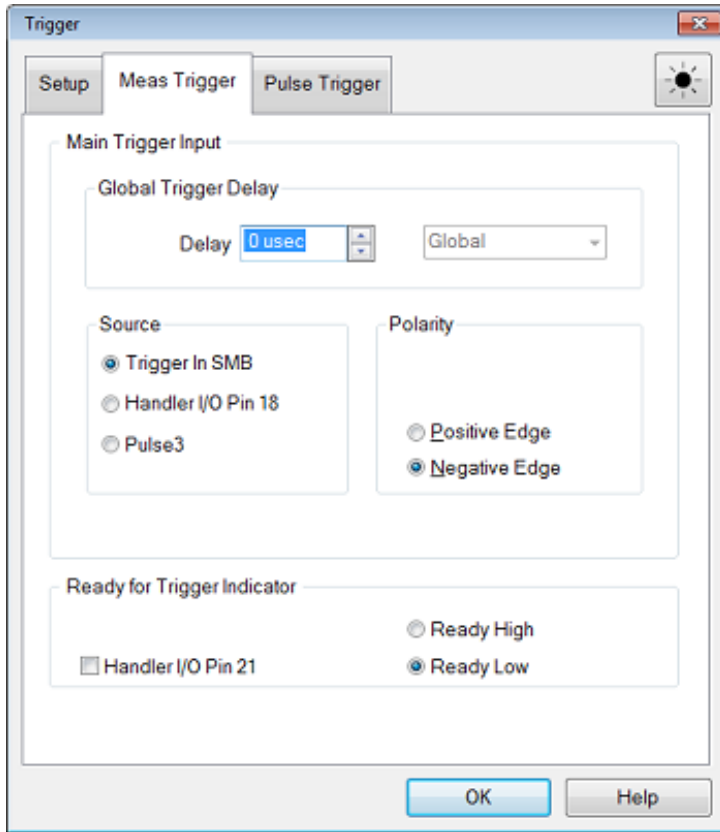

M980xA/P50xxA

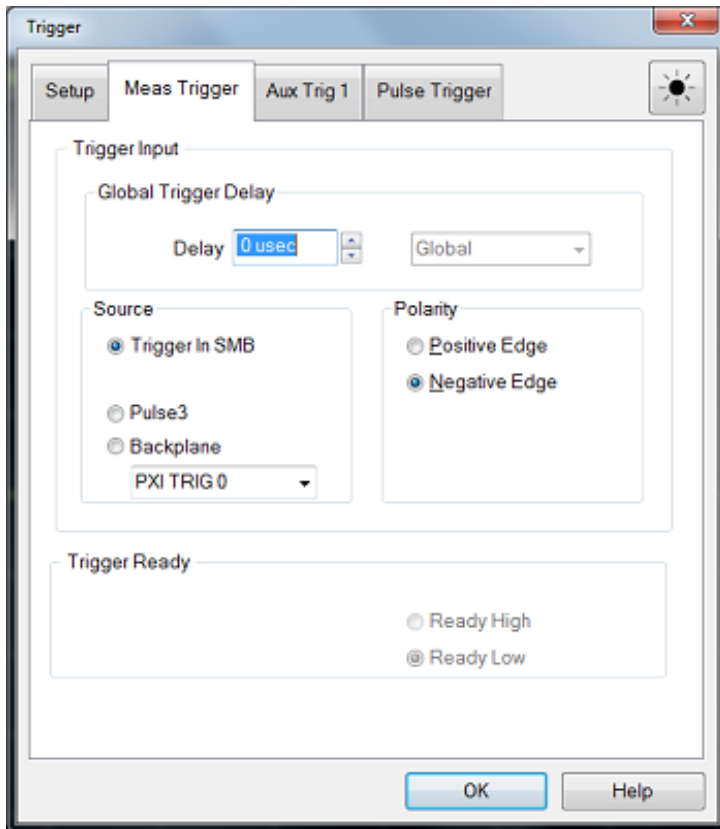

See how to access the Trigger Dialog

Trigger Ready and Trigger IN

The Trigger connectors are located on the front-panel. M980xA and P50xxA requires **I/O Adapter (M98xxA/P50xxA)** and a setup for trigger port assignment. Refer to **I/O Connector (M9485A)** for M9485A.

These signals can be used when the VNA is communicating with a slow mechanical device. A material handler is very mechanical and takes a relatively long time to load and discharge parts. Here is how these signals work together to communicate:

1. The VNA sends a 'Ready' signal when it is ready to make a measurement.
2. The external device sends a trigger signal to the VNA when it is ready for a measurement.

Dialog Settings

To cause the VNA to respond to Meas Trig IN or Handler I/O signals, select **External** on the **Trigger Setup tab, Source** setting.

Note: You must select **External** when you use any external triggers.

Also on the Trigger **Setup** tab, Scope setting, choose whether one external trigger signal will apply to ALL channels (Global) or one trigger signal per Channel. The following settings apply accordingly.

Main Trigger Input

Global / Channel Trigger Delay After an external trigger is received, the start of the sweep is held off for this specified amount of time plus any inherent latency.

- When **Trigger Scope** = Channel, the delay value is applied to the specified channel.
- When **Trigger Scope** = Global, the same delay value is applied to ALL channels.

Source The VNA accepts Trigger IN signals through the following connectors:

- Trig In SMB (on front panel of module [M937xA/P937xA], On **I/O Adapter** [M980xA/P50xxA])
- **Handler I/O Pin 18** (This appears when the M9341A is included at launcher.)

Note: When Handler I/O Pin 18 is selected, the connection between Meas Trig In SMB and M9341A is required. See **M9341A Module Installation**.

- **Pulse3** (M9485A/M980xA/P50xxA): Trigger signals are routed internally without the need of a cable connection between the pulse 3 output and the external trigger input.
- **Back Plane: (USB VNA)** In order to use Trig1/Trig 2 pin on USB chassis rear panel as an external trigger pin, the following procedure is necessary.
 1. Open USB chassis SFP, and show **Configuration** tab.
 2. Set Trig1 to "Input, PXI_TRIG2 (for example)", then check "Enable".
 3. In VNA FW, open **Trigger** dialog (**Trigger** -> **Trigger**).
 4. In **Setup** tab, set trigger source to "External".
 5. In **Meas Trigger** tab, set Source to "Backplane" and select "PXI TRIG 2" from drop down list for this example.

Level / Edge

Positive Edge After the VNA arms, it will trigger on the next positive edge.

Negative Edge After the VNA arms, it will trigger on the next negative edge.

Ready for Trigger Indicator (Trigger Ready)

On the VNA, when External is selected on the Trigger Setup tab, then both Meas Trig IN and Meas Trig Ready are enabled.

Note: The Ready for trigger is available only when the trigger source is set at External.

Choose a connector to send the VNA Ready OUT signal:

- [Handler I/O p21](#) (This appears when the M9341A is included at launcher.)

Choose Polarity of the 'Ready OUT' signal.

- **Ready High** - TTL High indicates the VNA is ready for trigger. (Not available on M980xA and P50xxA)
- **Ready Low** - TTL Low indicates the VNA is ready for trigger (default setting).

See Also

- [Learn how to External Trigger during Calibration](#)

Aux Trig 1 - Aux Trig 2 dialog box help

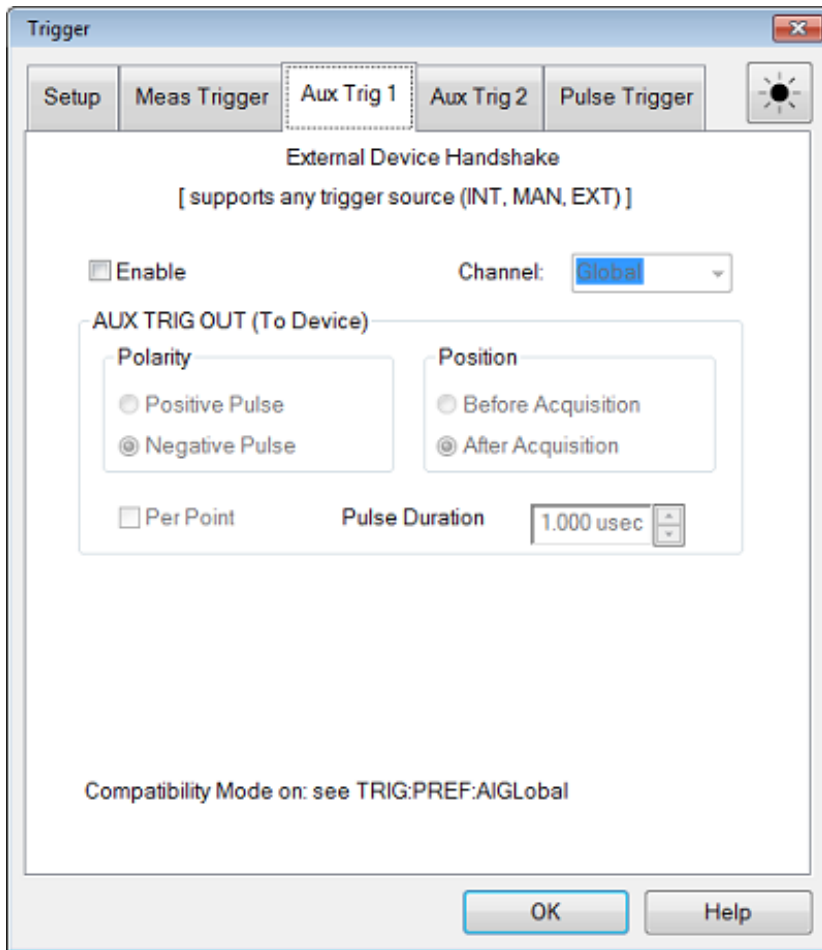

See how to access the Trigger Dialog

AUX TRIG OUT

(M9485A) when you assign the I/O 1 or 2 port on the M9376A/M9377A as AUX trigger port, AUX Trig (1 & 2) Tag appears. See the [I/O Connector \(M9485A\)](#) for assignment of I/O port.

(M980xA/P50xxA) you can use the AUX TRIG output when the port 3 of the sub side of [I/O Adapter \(M98xxA/P50xxA\)](#) is assigned as AUX trigger output. AUX Trig 2 is not supported.

These signals are highly configurable. They can be used with all types of external devices to receive signals.

- The Aux Trig OUT signal can be configured to be sent either just BEFORE the measurement is made or AFTER the measurement is complete. When communicating ONLY with an external source, the Aux Trig OUT signal should be sent AFTER the measurement is complete to indicate that the external source can setup for the next measurement.

Dialog Settings

The Aux Trig 1 and Aux Trig 2 tabs are identical. Two pair of connectors are available to allow two external devices to be controlled simultaneously.

Enable Check to use the Aux1 or Aux2 connectors to output signals to an external device.

Channel: This setting is controlled by a **VNA Preference setting**.

- **Global** - ALL Aux Trig settings apply to ALL channels. The Per Point setting (see below) is made on the **Trigger Setup tab** which also applies to ALL channels.
- **Channel** - ALL Aux Trig settings apply to the specified channel. Each channel can be configured independently.

AUX TRIG OUT (To Device)

The following settings control the properties of the signals sent out the rear panel AUX TRIG OUT (1&2) connectors:

Polarity

Positive Pulse Outgoing pulse is positive.

Negative Pulse Outgoing pulse is negative.

Position

Before Acquisition Pulse is sent immediately **before** data acquisition begins.

After Acquisition Pulse is sent immediately **after** data acquisition is complete.

Per Point Check to cause a trigger output to be sent for each data point. Clear to send a trigger output for each sweep.

When the Aux Trig - "**Global**" **VNA Preference** is selected, then the Point setting is made on the **Trigger Setup tab**. It then applies to ALL channels. When more than one channel is present, the channel setting that was made last is used.

Pulse Duration Specifies the duration of the positive or negative output trigger pulse.

See Also

- See how to use these connectors to **synchronize with External Sources**.

- Pulse Triggering

Note: Guided and Unguided Calibration CAN be performed in External Trigger mode. With this optional behavior, while Trigger Source is set to External, trigger signals must be sent for Calibration sweeps. This behavior does not apply to FCA calibrations.

You can **set a Preference** to calibrate using Internal trigger signals while Trigger Source is set to External.

The following dialog box appears on the screen while waiting for an External trigger signal.

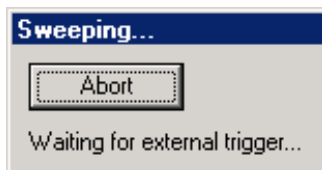

Click **Abort** to cancel the wait for a trigger signal.

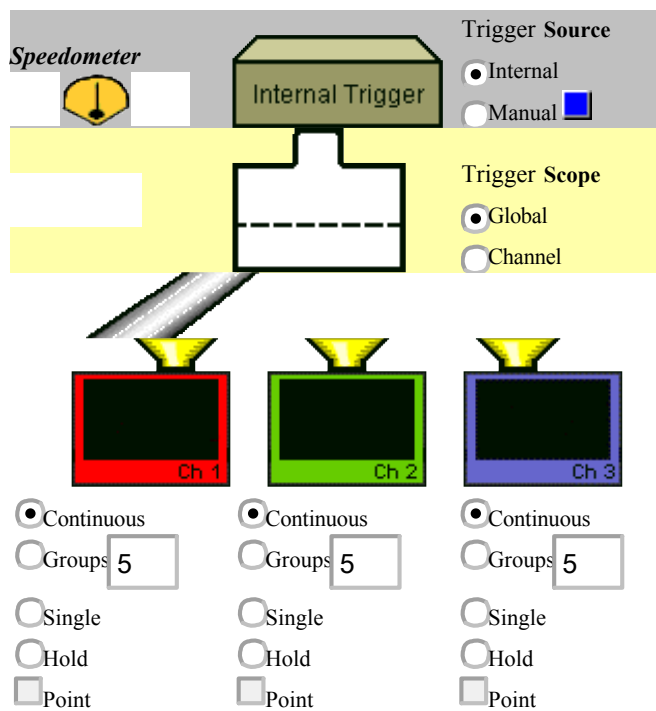

About the trigger model

Read [Text description](#) of triggering behaviors.

This model does not include [Sweep trigger mode](#).

Data Format

A data format is the way the analyzer presents measurement data graphically. Pick a data format appropriate to the information you want to learn about the test device.

- [How to set Format](#)
- [Rectangular \(Cartesian\) Display Formats](#)
- [Polar](#)
- [Smith Chart](#)

[See other 'Setup Measurements' topics](#)

How to set the Display Format

Using **Hardkey/SoftTab/Softkey**

1. Press **Format** > **Format 1** or **Format 2**.

Using a mouse

1. Right-click on the trace status area above the grid box.
2. Click **Format**.
3. Select the desired format.

[Programming Commands](#)

Format dialog box help

Click a link to learn about that format:

Log Mag	Polar
Phase / Unwrapped Phase	Linear Mag
Group Delay	SWR
Smith / Inverse Smith Chart	Real
	Imaginary

Format Unit

Only the following Formats allow a Unit selections:

Log Mag - Choose from:

- **dBm** (Power)
- **dBmV** (dB milli Volts) - used for unratiod receiver measurements.
- **dBmA** (dB milli Amps) - used for unratiod receiver measurements.

Lin Mag - Choose from:

- W (Watts), V, (volts), A (amps)

Rectangular Display Formats

Seven of the nine available data formats use a rectangular display to present measurement data. This display is also known as Cartesian, X/Y, or rectilinear. The rectangular display is especially useful for clearly displaying frequency response information of your test device.

- Stimulus data (frequency, power, or time) appears on the X-axis, scaled linearly
- Measured data appears on the Y-Axis.

Log Mag (Logarithmic Magnitude) Format

- Displays Magnitude (no phase)
- Y-axis: dB
- Typical measurements:

- Return Loss
- Insertion Loss or Gain

Phase Format

Measures the phase of a signal relative to the calibration reference plane with a range of +/- 180 degrees.

- Displays Phase (no magnitude)
- Y-axis: Phase (degrees)
- The trace 'wraps' every 180 degrees for easier scaling.
- Typical Measurements:
 - Deviation from Linear Phase

Unwrapped Phase

- Same as Phase, but without 180 degree wrapping.

Note: Phase is unwrapped by comparing the phase from one data point to the next. If the phase difference between two points is greater than 180 degrees, or if the phase of the first data point is greater than 180 degrees from DC, then the phase measurement is probably NOT accurate.

Positive Phase

Displays the phase wrapped between 0 to +360 degrees.

Group Delay Format

- Displays signal transmission (propagation) time through a device
- Y-axis: Time (seconds)
- Typical Measurements:
 - Group Delay

See Also:

[Group Delay \(Measurement\)](#)

Comparing the analyzer Delay Functions.

Phase Measurement Accuracy

Linear Magnitude Format

- Displays positive values only
- Y-axis: Unitless (**U**) for ratioed measurements
Watts (**W**) for unratioed measurements.
- Typical Measurements:
 - reflection and transmission coefficients (magnitude)
 - time domain transfer

SWR Format

- Displays reflection measurement data calculated from the formula $(1+\rho)/(1-\rho)$ where ρ is reflection coefficient.
- Valid only for reflection measurements.
- Y axis: Unitless
- Typical Measurements:
 - SWR

Real Format

- Displays only the real (resistive) portion of the measured complex data.
- Can show both positive and negative values.
- Y axis: Unitless
- Typical Measurements:
 - time domain
 - auxiliary input voltage signal for service purposes

Imaginary Format

- Displays only the imaginary (reactive) portion of the measured data.
- Y - axis: Unitless
- Typical Measurements:
 - impedance for designing matching network

Polar Format

Polar format is used to view the magnitude and phase of the reflection coefficient (Γ) from your S_{11} or S_{22} measurement.

You can use Markers to display the following:

- Linear magnitude (in units) or log magnitude (in dB)
- Phase (in degrees)

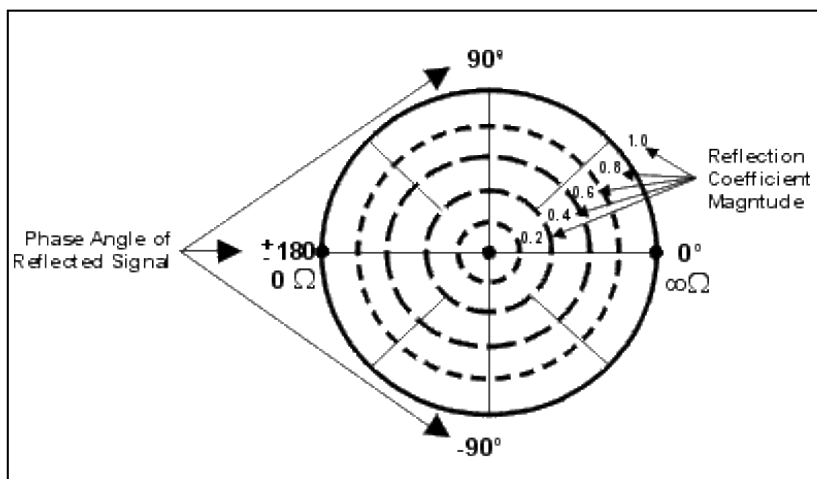

- The dashed circles represent reflection coefficient. The outermost circle represents a reflection coefficient (Γ) of 1, or total reflected signal. The center of the circle represents a reflection coefficient (Γ) of 0, or no reflected signal.
- The radial lines show the phase angle of reflected signal. The right-most position corresponds to zero phase angle, (that is, the reflected signal is at the same phase as the incident signal). Phase differences of 90° , $\pm 180^\circ$, and -90° correspond to the top, left-most, and bottom positions on the polar display, respectively.

Smith Chart Format

The Smith chart is a tool that maps the complex reflection coefficient (Γ) to the test device's impedance.

In a Smith chart, the rectilinear impedance plane is reshaped to form a circular grid, from which the series resistance and reactance can be read ($R + jX$).

You can use Markers to display the following:

- Resistance (in units of ohms)
- Reactance as an equivalent capacitance (in units of farads) or inductance (in units of henrys)

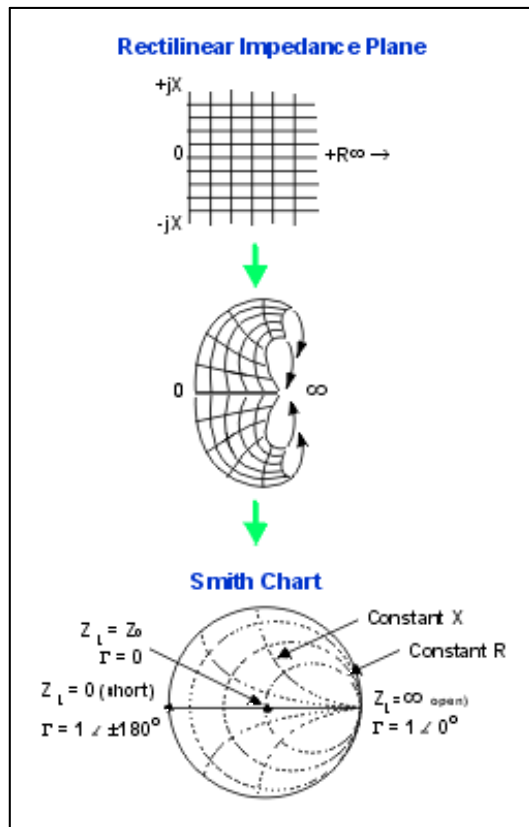

Inverse Smith Chart (also known as Admittance)

Same as standard Smith Chart , except:

- The plot graticule is reversed right-to-left.
- Admittance (in units of siemens) instead of resistance.

Interpreting the Smith Chart

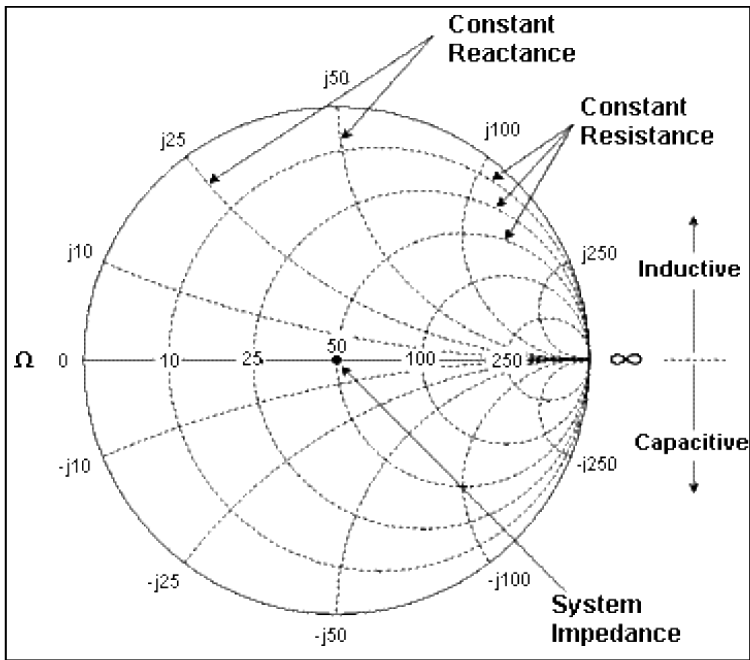

- Every point on the Smith Chart represents a complex impedance made up of a real resistance (r) and an imaginary reactance ($r+jX$)
- The horizontal axis (the solid line) is the real portion of the impedance - the resistance. The center of the horizontal axis always represents the system impedance. To the far right, the value is infinite ohms (open). To the far left, the value is zero ohms (short)
- The dashed circles that intersect the horizontal axis represent constant resistance.
- The dashed arcs that are tangent to the horizontal axis represent constant reactance.
- The upper half of the Smith chart is the area where the reactive component is positive and therefore inductive.
- The lower half is the area where the reactive component is negative and therefore capacitive.

Scale

The Scale, Reference Level and Reference Position settings (along with **Format**) determine how the data trace appears on the VNA screen.

- [Scale, Reference Level and Position](#)
- [Scale Coupling](#)
- [Magnify Mode and Zoom Preference](#)
- [Electrical Delay](#) (Separate topic)
- [Magnitude Offset & Magnitude Slope](#)
- [Phase Offset](#) (Separate topic)

[See other 'Setup Measurements' topics](#)

Scale, Reference Level and Position

The Scale, Reference Level and Reference Position settings (along with format) determine how the data trace appears on the VNA screen.

How to set Scale, Reference Level, and Position

Using **Hardkey/SoftTab/Softkey**

1. Press **Scale** > **Main** > **Scale / Reference Level / Reference Position**.
2. Input the desired value.

Using a mouse

1. Right-click on **Y-axis** annotation or the **trace status** label above the grid box.
2. Select **Scale...**

[Programming Commands](#)

[Scale dialog box help](#)

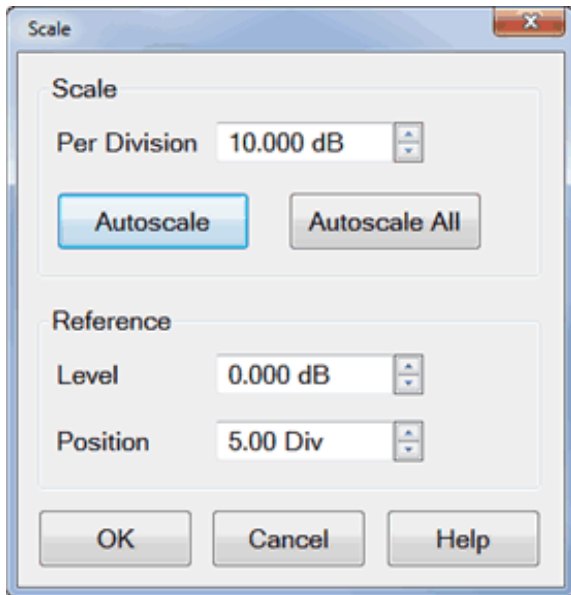

Note: The scale settings are set to couple with other traces in each window. The following settings assume that Scale Coupling is set to OFF. [Learn more about Scale Coupling.](#)

Scale

Per Division Sets the value of the vertical divisions of a rectangular display format. In Polar and Smith Chart formats, scale sets the value of the outer circumference. Range: 0.001dB/div to 500 dB/div.

Tip: Click on the Y-axis labels, then use a mouse scroll wheel to change scale in preset increments. Or Right-click on **Y-axis** annotation to change Scale.

Autoscale - Automatically sets value of the vertical divisions and reference value to fit the ACTIVE data trace within the grid area of the screen. The stimulus values and reference position are not affected.

The analyzer determines the smallest possible scale factor that will allow all the displayed data to fit onto 80 percent of the vertical grid.

The reference value is chosen to center the trace on the screen.

Tip: Double click on the Y-axis labels to autoscale the active trace.

Autoscale All Automatically scales ALL data traces in the ACTIVE WINDOW to fit vertically within the grid area of the screen.

Reference

Level In rectangular formats, sets the value of the reference line, denoted by **0.00**  on the

screen. Range: -500 dB to 500 dB.

In Polar and Smith chart formats, reference level is not applicable.

Tip: Click on the Y-axis labels, then drag up or down to change the reference level in preset increments.

Position In rectangular formats, sets the position of the reference line. Zero is the bottom line of the screen and ten is the top line. Default position is five (middle).

In Polar and Smith chart formats, reference position is not applicable.

Tip: Click on the triangle , then drag up or down to change the reference position in preset increments.

Scale Coupling

With Scale Coupling enabled, traces that have the same format will have the same Scale, Reference Level, and Reference Position. You can choose to couple the scale of traces that are in the same window, couple the scale of all traces in all windows, or to have NO coupling.



How to set Scale Coupling

Using **Hardkey/SoftTab/Softkey**

1. Press **Scale** > **Main** > **Scale Coupling...**

Using a mouse

1. Right-click on **Y-axis** annotation.
2. Select **Scale Coupling...**

 **Programming Commands** 

Scale Coupling dialog box help

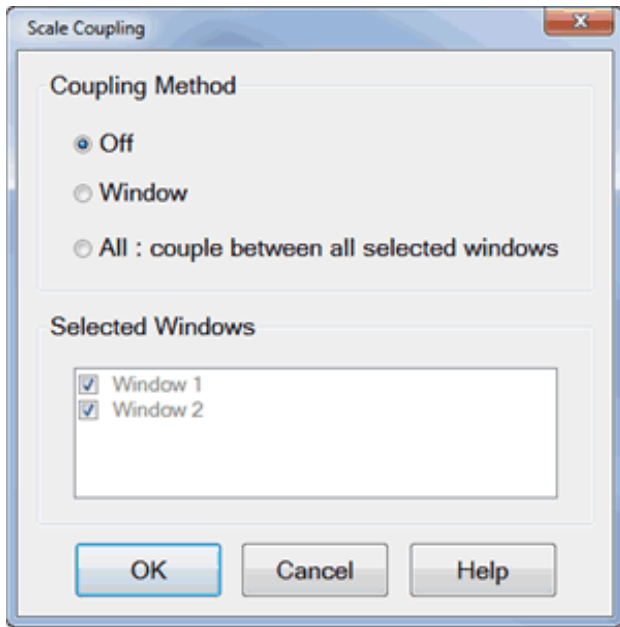

Allows traces that share the same **format** to have the same **Scale**, **Reference Level** and **Reference Position**.

Coupling Method

Off - No coupling. Traces are scaled individually. Default setting.

Window - All traces with the same format in each selected window share the same scale settings.

All - All traces in ALL selected windows with the same format share the same scale settings.

- When **Window** or **All** coupling is enabled, the scale settings for the active trace are assumed by other coupled traces with the same format.
- When there are traces with a different format present, all traces with that format assume the trace settings of the lowest-numbered trace of that format.
- Once enabled, scale settings for all coupled traces with the same format can be changed with any coupled trace being active.

Selected Windows

Available when either the **Window** or **All** method is selected. Selected windows will participate in scale coupling. All windows are selected by default. Clear a checkbox to 'Opt-out' of scale coupling for that window.

About Autoscale and Scale Coupling

Autoscale (not Autoscale All) affects the active trace in the active window. All traces that are coupled to this trace assume the new scale settings of the active trace. This could cause some traces to NOT show on the screen.

Autoscale All with Coupling Method...

- **Off** - All traces in the active window are autoscaled independently.
- **Window** - All traces in each selected window are autoscaled to fit within a common set of scaling factors.
- **All** - All traces in all selected windows are autoscaled to fit within a common set of scaling factors.

Magnify Mode and Zoom Preference

The magnify feature allows to magnify all traces in the active window. It allows to zoom into a portion of the display to see the response in detail.

How to magnify the trace

Using **Hardkey/SoftTab/Softkey**

None

Using a mouse

1. Left-click and select the area you want to magnify
2. Select **Magnify** from the pop-up menu.

Programming Commands

Other methods to set the magnify mode includes:

- When the Zoom Preference is set to Magnify, a 2-finger spread gesture will turn ON the Magnify mode
- Click on the Magnify icon at the top of the screen

- Enable the zoom box select mode and drag the zoom box to select an area, and then choose the Magnify option in the popup menu.

When the Magnify Mode is turned on:

2-finger pinch on the display changes the x and y magnification. If magnification is pinched down to 1:1 scaling, the magnify mode will be turned off.

1-finger drag across display changes the reference of the magnified x and y.

Zoom Preference Dialog Box Help

Zoom Preference allows you to decide the default operation of the 2-finger pinch gesture, from these 4 choices:

2-finger pinch automatically turns on magnify mode so that x and y-axis can be magnified/ This is the default setting.

2-finger pinch changes y-axis scale.

2-finger pinch changes y-axis scale and x-axis stimulus.

2-finger pinch does nothing.

Magnitude Offset

Magnitude Offset allows you to offset the magnitude (not phase) data by a fixed and / or sloped value in dB. If the display format is Linear Magnitude or Real (unitless), the conversion from dB is performed and the correct amount of offset is implemented.

How to set Magnitude Offset

Using **Hardkey**/**SoftTab**/**Softkey**

1. Press **Scale** > **Constants** > **Mag Offset / Mag Slope**.

Programming Commands

Magnitude Offset dialog box help

Magnitude Offset allows you to offset the magnitude (not phase) data by a fixed and / or sloped value in dB. If the display format is Linear Magnitude or Real (unitless), the conversion from dB is performed and the correct amount of offset is implemented.

The Magnitude offset setting affects only the active trace.

Mag Offset Offsets the entire data trace by the specified value.

Mag Slope Offsets the data trace by a value that changes with frequency. The offset slope begins at 0 Hz.

For your convenience, the offset value at the start frequency is calculated and displayed.

Receiver Gain

M938xA/P50xxA can fix the receiver gain. When the receiver gain is lower than expected, for example due to an unexpected spurious signal, this function allows you to fix the gain level to improve the dynamic range. The measurement speed is almost the same even if the range is fixed.

How to make Receiver Gain settings

Use one of the following methods to set port power. The softkey is available on standard measurement class only.

Using **Hardkey/SoftTab/Softkey**

1. Press **Setup > Internal Hardware > Receiver Gain...**

Using a mouse

1. Click **Instrument > Setup > Internal Hardware > Internal Hardware > Receiver Gain...**

Programming Commands

The M938xA/P50xxA have the independent error terms for high and low receiver settings.

In Auto, the analyzer measures the error terms for both high and low settings automatically See **Cal Set Viewer**.

Receiver Gain dialog box help

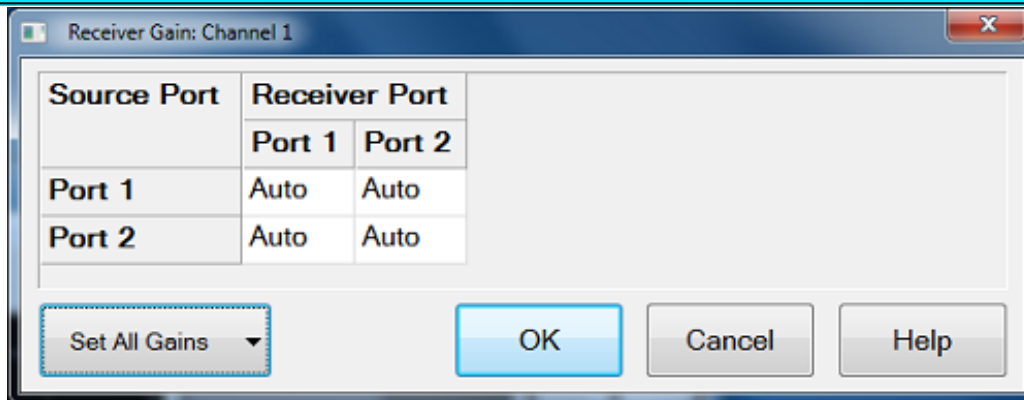

This dialog provides basic control receiver for a specific port.

This table consists of source port rows and receiver port columns. Each cell is corresponded to measurements in the active channel. (e.g. 'Receiver port 1 – Source port 3' is corresponded to S13, a1,3 and b1,3.)

The each cell sets the setting by the following drop down list.

- Auto - (Default) Receiver gain is controlled automatically for each measurement points according to the input signal level.
- High - Fix the gain setting at high
- Low - Fix the gain setting at low

Set All Gains - Sets all cells at one time.

Receiver Gain for Segment Sweep dialog box help

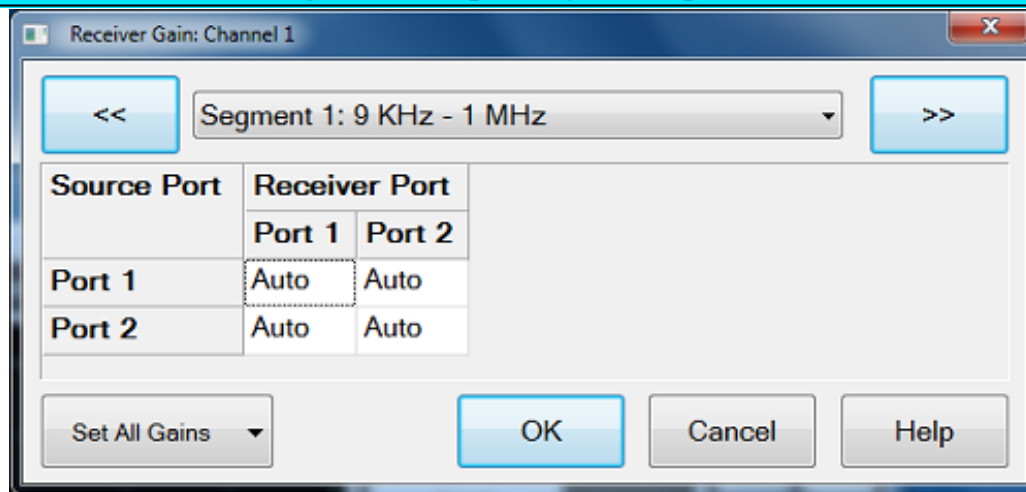

This dialog provides basic control receiver gain of the specified segment for a specific port in the **segment sweep**. The **receiver gain in Segment Table** dialog box should be turned on, then click **Edit** under **Rev Gain** column in the Segment Table,

Select your required segment to define the setup in the selection at the top of dialog box.

This table consists of source port rows and receiver port columns. Each cell is corresponded to measurements in the active channel. (e.g. 'Receiver port 1 – Source port 3' is corresponded to S13, a1,3 and b1,3.)

The each cell sets the setting by the following drop down list.

- Auto - (Default) Receiver gain is controlled automatically for each measurement points according to the input signal level.

- High - Fix the gain setting at high
- Low - Fix the gain setting at low

Set All Gains - Sets all cells at one time.

Customize the Analyzer Screen

You can customize your analyzer screen by showing or hiding the following display elements. All of these selections are made from the **Response > Display** menu.

- Windows (Separate topic)
- Display Labels
 - Trace Status
 - Y-axis Labels
 - X-axis Labels
- Marker Display (Separate topic)
- Tables
- Toolbars
 - Softkey
 - Hardkey
 - Port Extension
 - Transform
 - Marker
 - Cal Set Viewer
 - Title Bars
 - Active Entry
 - Status bars
 - System Date and Time
- Display Colors (Separate topic)
- Grid: SOLID | Dotted
 - Grid Lines

- Y-axis Divisions
- Show Table
- Tools
- Colors
- Window Title
- Trace Title
- Frequency/Stimulus
- Minimize Application

See Also

Traces, Channels, and Windows

See other 'Setup Measurements' topics

Labels

You can display different labels for traces status, Y-axis and X-axis labels.

How to display labels

Using **Hardkey** /*SoftTab* /Softkey

1. Press **Display** > *Display Setup* > **Customize Display...** .
2. Select **Labels** tab.

OR

1. Press **Marker** > *Marker Setup* > **Marker Display...** .
2. Select **Labels** tab.

Using a mouse

1. Right click on any window area.
2. Click **Customize Display...** .
3. Select **Labels** tab.

◀ Programming Commands ▶

Labels tab Dialog Box Help

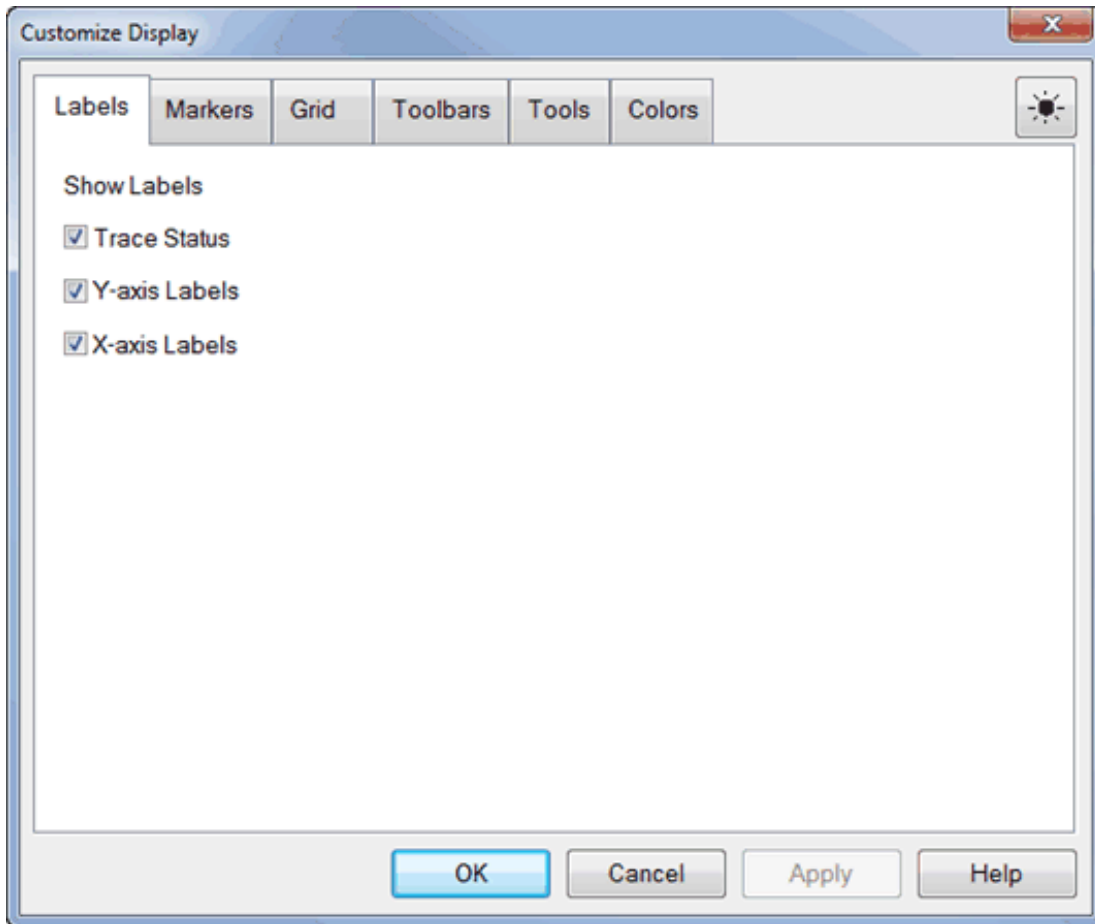

Show Labels

Trace Status

Tr 1 S11 LogM 10.00dB/ 0.00dB Tr 2 S12 LogM 10.00dB/ 0.00dB

Trace status is annotated at the top of each window.

The highlighted trace number indicates **Active Trace** .

Click the title to select a trace.

Trace Status shows the following:

- Trace number (Tr x). This is the trace number of the channel; NOT the window trace number which is used in many programming commands.
- Measurement parameter. This can be replaced with a custom Trace Title .
- Format
- Scaling factor

- Reference level

How to show/hide Trace Status.

Y-axis Labels



" **Y-axis Labels** " - allows user to show or hide the y-axis labels.

How to show/hide Y-axis Labels.

X-axis Labels



"**X-axis Freq Resolution** " - allows user to choose the resolution of the frequency display. The pull down selects: 6-digit, GHz, MHz, kHz, Hz. It shows 1Hz resolution, but only shows significant digits.

How to show/hide X-axis Labels.

Grid

How to set VNA Grid and display tables.

Each window can display only one table at a time.

Using **Hardkey /SoftTab /Softkey**

1. Press **Display** > **Display Setup** > **Customize Display...**
2. Select **Grid** tab.

OR

1. Press **Marker** > **Marker Setup** > **Marker Display...**
2. Select **Grid** tab.

Using a mouse

1. Right click on any window area.
2. Click **Customize Display...**
3. Select **Grid** tab.

◀ Programming Commands ▶

Grid Dialog Box Help

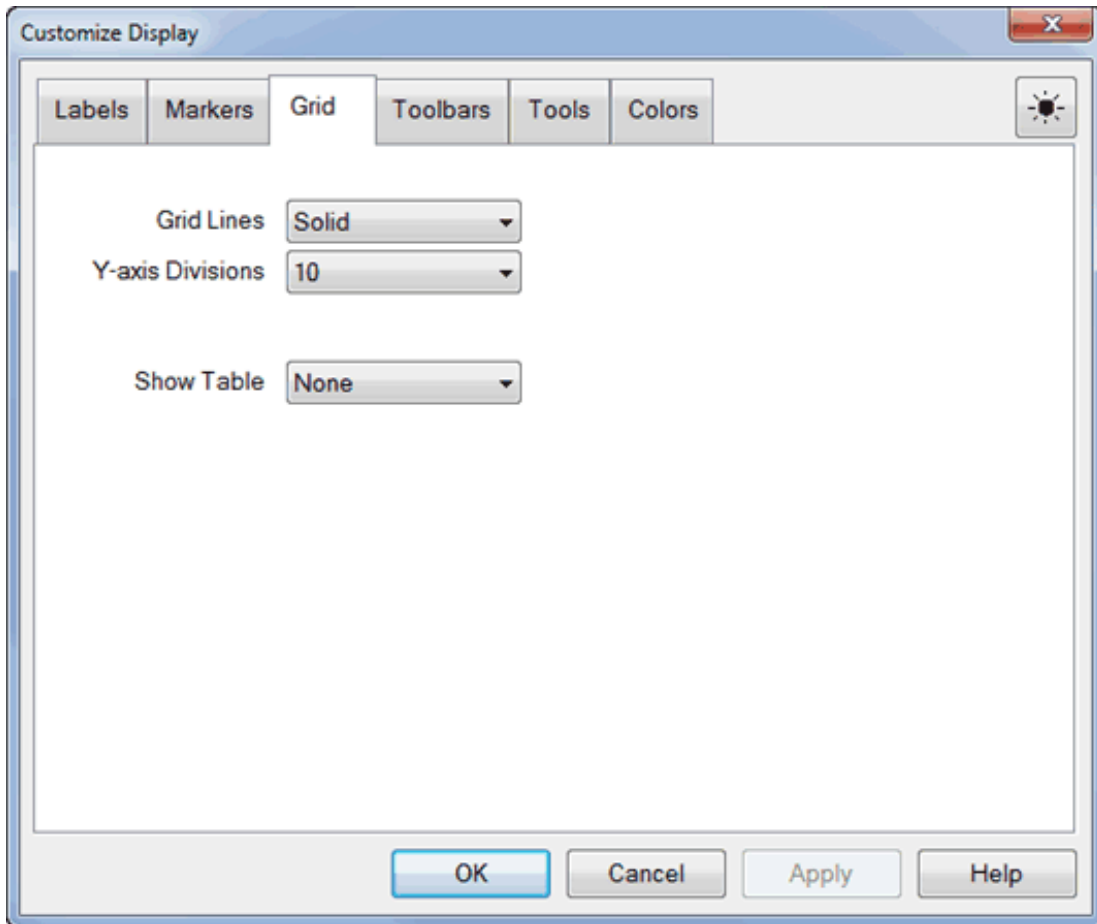

Grid Lines: Solid | Dotted - Set whether to display ALL open window grid lines in solid or dotted lines. The selected setting is shown in CAPS. Once set, new windows are created using this setting. Grid lines return to SOLID when the VNA is Preset.

Set the color of the grid using Display Colors.

How to display grid settings

Y-axis Divisions - Set the desired rows of Y-axis, it can shows 2 to 30.

Show Table

None - Turn OFF the table.

Marker Table

You can display a table of marker settings. These settings include the:

- Marker number
- Marker reference (for delta measurements)
- Frequency
- Time and Distance (for Time Domain measurements)
- Response

Learn more about Markers

Limit Line Table

You can display, set up, and modify a table of limit test settings. These include:

- Type (MIN, MAX, or OFF)
- Beginning and ending stimulus values
- Beginning and ending response values

Learn more about Limit Lines .

Ripple Table

You can display, set up, and modify a table of maximum ripple limit over frequency range settings. These include:

- Type (ON or OFF)
- Beginning stimulus value
- Ending stimulus value
- Maximum ripple

Learn more about Ripple limits .

Segment Sweep Table

You can display, set up, and modify a table of segment sweep settings. These include:

- State (On/Off)
- Start and Stop frequencies
- Number of Points
- IF Bandwidth (if independent levels)
- Power Level (if independent levels)
- Sweep Time (if independent levels)

Learn more about Segment Sweep .

Distortion Table

You can display, set up, and modify a table of modulation distortion measurement parameters. Each row represents a measurement band. Each column represents a measurement parameter.

Learn more about the Distortion Table.

Toolbars

You can display different toolbars to allow you to easily set up and modify measurements.

How to display Toolbars

Using **Hardkey** / **SoftTab** / **Softkey**

1. Press **Display** > **Display Setup** > **Customize Display...**
2. Select **Toolbars** tab.

OR

1. Press **Marker** > **Marker Setup** > **Marker Display...**
2. Select **Toolbars** tab.

Using a mouse

1. Right click on any window area.
2. Click **Customize Display...**
3. Select **Toolbars** tab.

◀ **Programming Commands** ▶

Toolbars Dialog Box Help

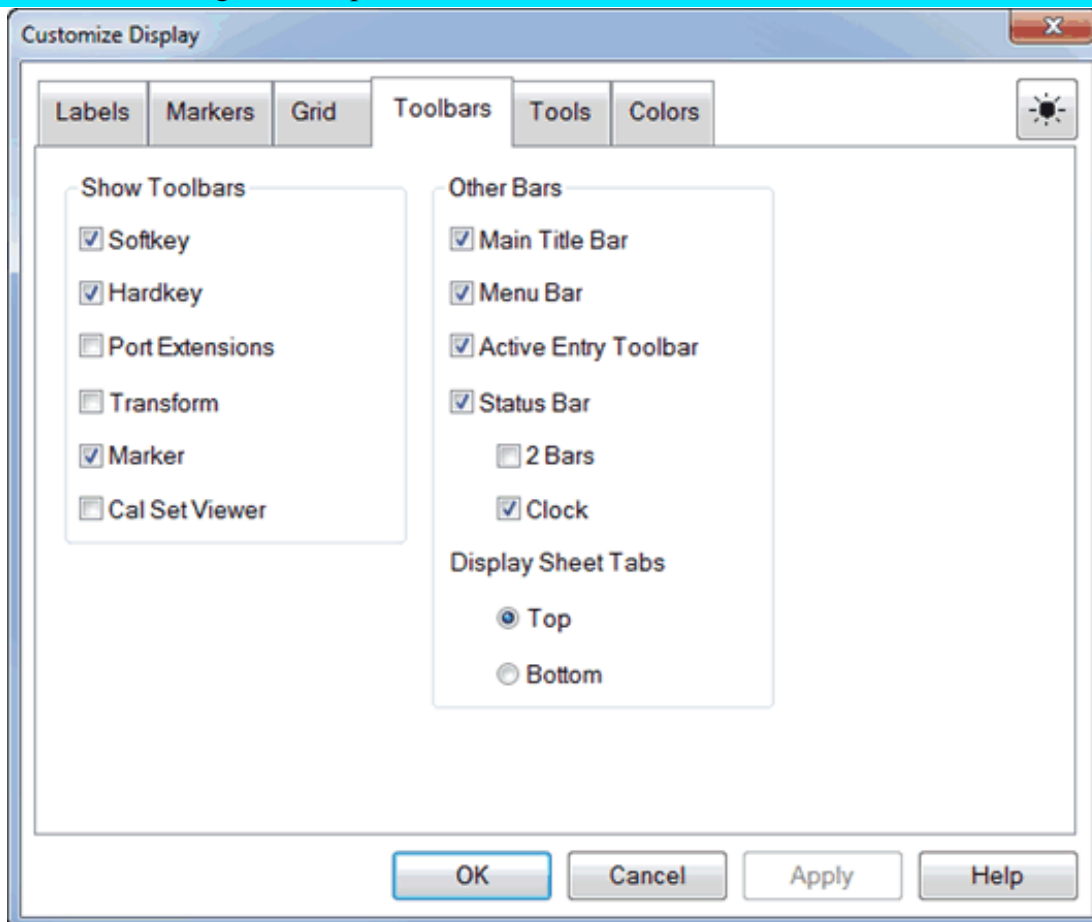

Show Toolbar

Note: There is also a Cal Set toolbar available for Monitoring Error Terms

Softkey

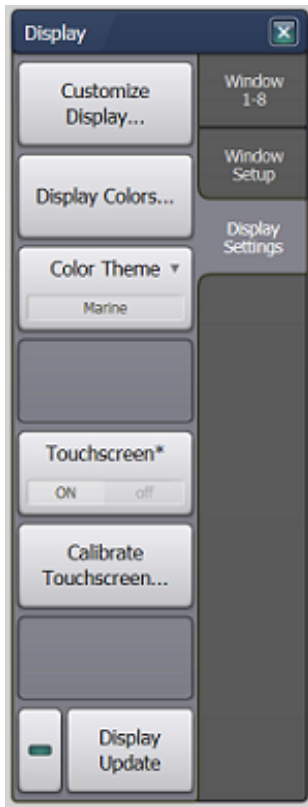

Softkey is a combination of softkeys and SoftTabs. Softkeys are automatically turned ON when one of the 'function' hardkeys is pressed. This setting allows you to turn the softkeys OFF to show more measurement space on the screen. The softkeys will reappear when another function hardkey is pressed.

Hardkey



These keys also known as Front Keys, perform interface operations that are equivalent to those of keys in the INSTRUMENT keys, RESPONSE keys, STIMULUS keys and UTILITY keys on the front panel of VNA. Learn more.

Port Extensions Toolbar

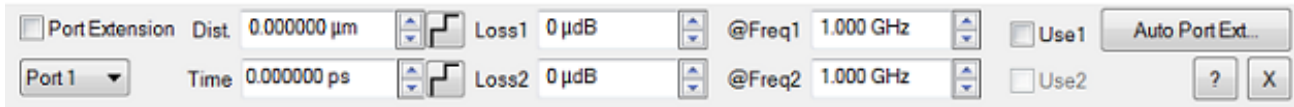

The Port Extension toolbar allows you to set Port Extensions while viewing the measurement trace. Learn more about Port Extensions .

Transform (Time Domain) Toolbar

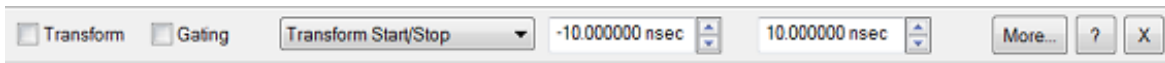

The Time Domain toolbar allows you to do the following:

- Turn **Transform** and **Gating** ON/OFF.
- Change the Start/Stop times for both Transform and Gating.
- **More...** - Launches the Time Domain Transform dialog box.
- **?** - Display the help file.
- **X** - Closes the toolbar.

Markers Toolbar

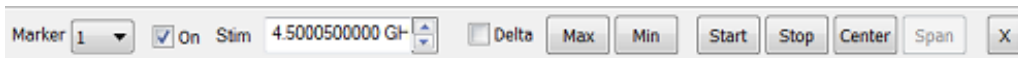

The markers toolbar allows you to set up and modify markers. It shows:

- Marker number
- Stimulation value
- Marker functions:
 - Delta
 - Max/Min
 - Start/Stop
 - Center/Span

Tip: To use the Front Panel Knob to change marker position, first click the **Stimulus** field of the marker toolbar and then turn the knob.

Learn more about Markers

Cal Set Viewer Toolbar

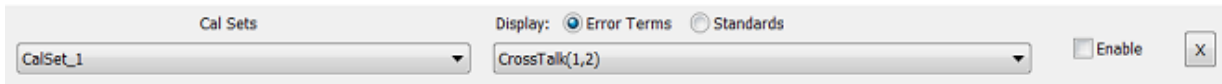

Learn more about Cal Set Viewer .

All Off (NOT on softkeys)

This allows you to **hide all toolbars** with a single selection. NOT available on softkeys.

Other Bars

Main Title



The Main Title shows the title of VNA window and Minimize / Maximize icons.

- Checked - Title bars for all VNA window are shown.
- Cleared - Title bars for all VNA window are hidden. This allows more room to display measurement results.

Active Entry Toolbar



When used with softkeys, this area allows numeric values to be entered for settings. From the keyboard, enter G for Giga, M for Mega or milli, K for kilo and so forth.

Status Bar

2 Bars



When enabled, the status bar is displayed along the bottom of the VNA screen. The primary status bar shows the following:

Tip: Right-click on many of these items in the status bar for quick access to settings.

- Active trace
- Active channel
- Trigger source
- Channel Trigger State (Hold, Single, Continuous)
- IF Bandwidth
- Error correction for the active trace to the Basic cal, Smart cal and Calibrate All Channels.
 - F: Full Port Calibration, R: Response Calibration, -: Nothing
- Reference (Internal/ External[PXIe VNA] , External [USB VNA])
- Source Power Calibration
- Service
- RF power
- Display Update
- Error messages
- GPIB status : Local (LCL), Remote Talker Listener (RMT), or System Controller (CTL).
- System Date and Time - Can be set ON or OFF. How to show/hide the VNA clock.

Note: A second level status bar appears when using External Test Set Control or Interface control.

The status bar state (ON or OFF) will not change when the VNA is Preset.

Clock (System Date and Time)

The VNA system date and time can be shown in the far right corner of the status bar.

The format is: year-month-day hr:min and can NOT be changed.

To hide the clock, right click the mouse on the clock and then click **Hide Clock** .

Learn how to set the VNA time settings.

Display Sheet Tabs

Top - Display sheet tabs above display.

Bottom - Display sheet tabs below display.

Tools

How to set Tools settings

Using **Hardkey** /**SoftTab** /**Softkey**

1. Press **Display** > **Display Setup** > **Customize Display...**
2. Select **Tools** tab.

OR

1. Press **Marker** > **Marker Setup** > **Marker Display...** .
2. Select **Tools** tab.

Using a mouse

1. Right click on any window area.
2. Click **Customize Display...** .
3. Select **Tools** tab.

Programming Commands

Tools Dialog Box Help

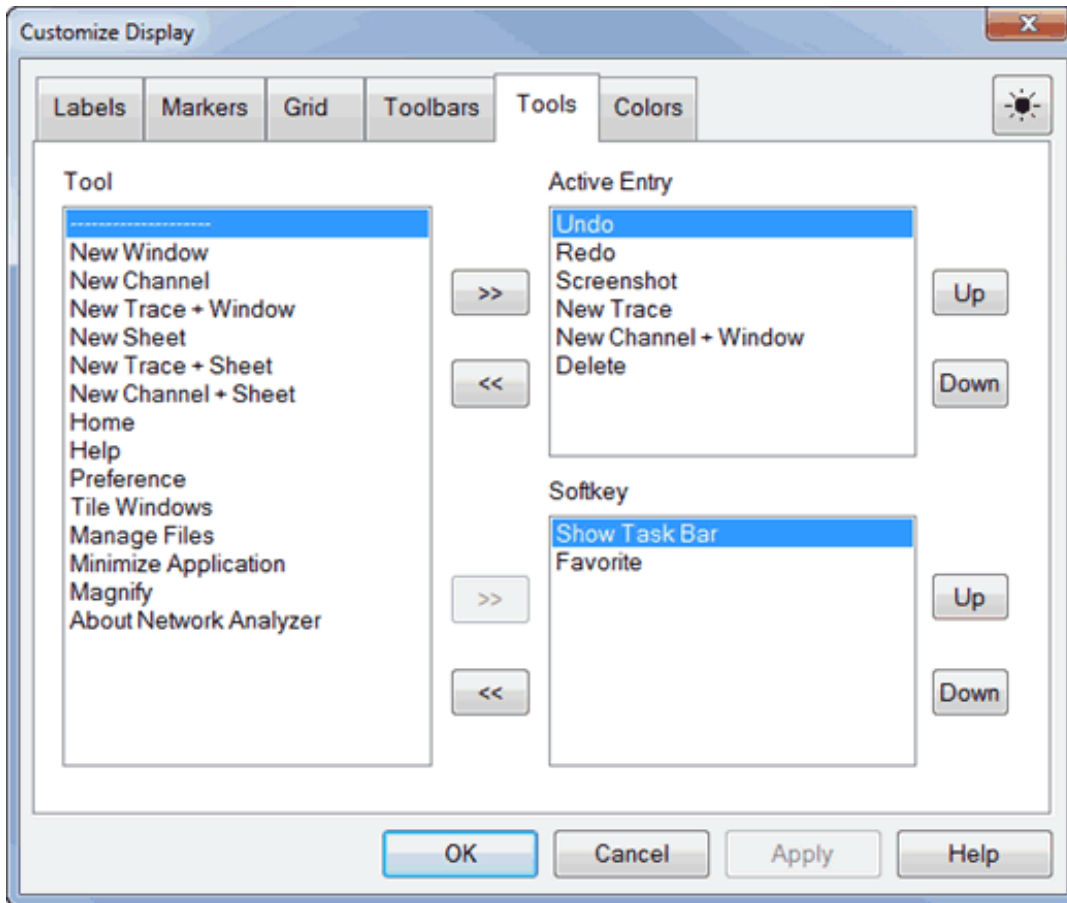

Tools function to create a shortcut icon to display on Active Entry or Softkey Toolbar. The maximum icons can display on Active Entry is 9, while Softkey Toolbar is 12.

New Window - Create a new window.



New Channel - Create a new channel on active window.



New Channel + Window - Create a new trace and channel to a new window.



New Trace - Create a new trace on active window.



New Trace + Window - Create a new trace to a new window, but the channel is remain.



New Sheet - Create a new sheet.



New Trace + Sheet - Create a new trace to a new sheet, but the channel is remain.



New Channel + Sheet - Create a new trace and channel to a new sheet.



Home - Display VNA Home softkeys.



Favorite - Set favorite application. To Add a Favorite, press and hold any softkey for three seconds and select the desired Favorite number (Favorite 1 to 3).



Help - Shows Help file.



Show Task Bar - Shows Window bar.



Preference - Display preference dialog box.



Tile Windows



Manages Files - Use to manage the saved files in the "D:\\" drive folder. [Learn more.](#)



Minimize Application - Restore VNA screen. [Learn more.](#)



About Network Analyzer - Display About Network Analyzer dialog box.



Undo - Recover to previous version. [Learn more.](#)



Redo - Set to latest version. [Learn more.](#)



Screenshot - Save screen figure to "D:\\" drive (D:\).



Delete - Delete the active window.



Colors

How to set colors

Using **Hardkey** / **SoftTab** / **Softkey**

1. Press **Display** > **Display Setup** > **Customize Display...**
2. Select **Colors** tab.

Using a mouse

1. Right click on any window area.
2. Click **Customize Display...**
3. Select **Colors** tab.

Programming Commands

Colors Dialog Box Help

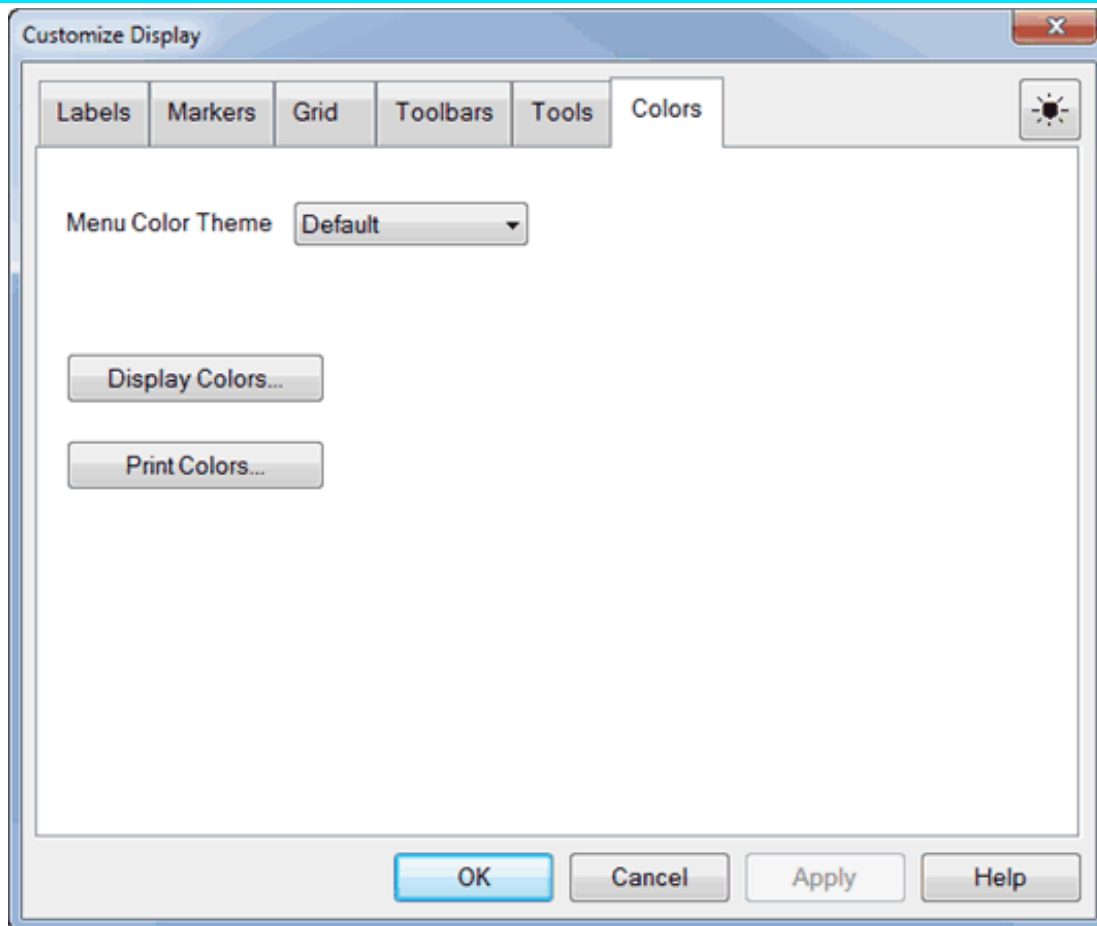

Menu Color Theme - Select color theme

Display Colors... - See Display Colors

Print Colors... - See Print Preview

Window Title

You can create and display a title for each **window**.

- The limit is set by the number of windows that are displayed.
- The title (My Window) is annotated in the upper-left of the window as follows:



How to enter a Window Title

Using **Hardkey** /**SoftTab** /**Softkey**

1. Press **Display** > **Window Setup** > **Window Title...** .

Using a mouse

1. Move a cursor in the grid and then right click.
2. Select **Title...** .

◀ **Programming Commands** ▶

Window Title Dialog Box Help

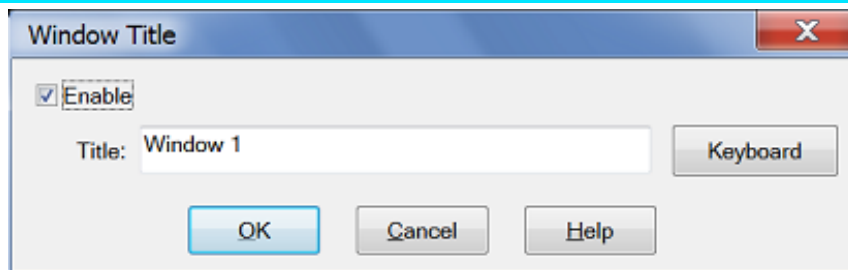

1. Click **Enable** , then type the window title. Click **Keyboard** to type with a mouse.
2. To remove the window title, clear the **Enable** checkbox or delete the text from the dialog entry.

Trace Title

A Trace Title overwrites the Measurement Parameter in the Trace Status area, the Status Bar and hardcopy prints .

- This title has priority over Equation Editor titles.

- The practical limit is about 70 characters if there is only one trace.
- Spaces are accepted but not displayed; use underscores.
- The title is annotated as follows:

Tr 1 Trace A LogM 10.00dB/ 0.00dB

How to enter a Trace Title

Using **Hardkey** /**SoftTab** /**Softkey**

1. Press **Trace** > **Trace Setup** > **Trace Title...** .

Using a mouse

1. Move a cursor in the grid and then right click.
2. Select **Trace Title...** .

Programming Commands

Trace Title Dialog Box Help

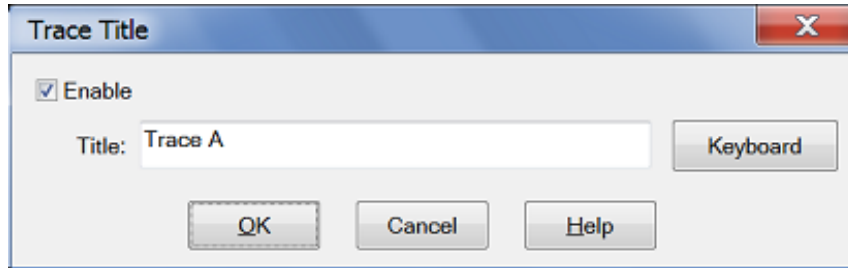

1. Click **Enable** , then type the window title. Click **Keyboard** to type with a mouse.
2. To remove the window title, clear the **Enable** checkbox or delete the text from the dialog entry.

Frequency/Stimulus

1 >Ch1: Start 100.000 kHz — Stop 9.00000 GHz

Frequency/stimulus information is displayed at the bottom of each window on the screen. It shows:

- Channel number
- Start value
- Stop value

Minimize Application

The Network Analyzer application can be minimized to show the desktop and Windows taskbar.

1. Click **System** > **Main** > **Minimize Application** .

To restore the VNA application, double-click the VNA application on the desktop.

Copy Channels

Copy channels allows you to make a duplicate channel with the same stimulus conditions as an existing channel.

- [Why Copy Channels](#)
- [How to Copy Channels](#)
- [List of Channel Settings](#)

Other Setup Measurements Topics

Why Copy Channels

Copy channel settings if you need to create several channels that have slightly different settings.

For example, if you have an amplifier that you want to characterize over a frequency span with several different input power levels.

Follow these steps:

1. Create one measurement with your optimized channel settings.
2. Copy that channel to new channels.
3. Change the power level on the new channels.

The alternative to using Copy Channels is to create new default measurements on new channels. Then change every channel setting to your new requirement. This is very time consuming and thus shows the benefit of the Copy Channels feature.

How to Copy Channels

Using **Hardkey/SoftTab/Softkey**

1. Press **Channel** > **Channel Setup** > **Copy Channel**.
2. Click **Copy to Active Window/Copy to New Window/Copy Channel...**

Programming Commands

Copy Channel dialog box help

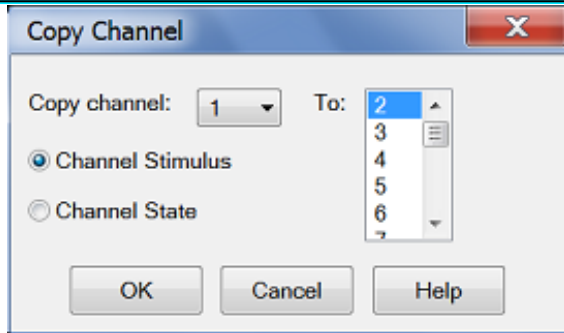

Copies an existing channel's settings to another channel. Measurement traces from the source channel are NOT copied.

Copy channel (also known as '**Source**' channel): Select a channel to copy.

to (also known as '**Destination**' channel): Scroll to select a channel to copy settings to. Compatible channel numbers that are currently being used are highlighted. They can be selected and overwritten.

The following are compatible destination channels:

- A channel that does not yet exist. The new channel is created with the channel's default measurement.
- A channel that contains no measurements. Again, the destination channel is created with the channel's default measurement.

Notes:

- You can copy channel settings to ONLY one new or existing channel. Repeat this operation to copy to more than one channel.
- The source channel is ALWAYS copied to the Active window. If you want the destination channel in a separate window, first create a compatible new measurement in a new window. Then make sure it is the Active window before you copy the channel into it.
- The measurement in the destination channel becomes the active measurement.

For example:

1. **Source** channel 1: Standard S21 measurement
2. **Destination** NEW channel 2
3. **Result:** Source channel 1, S21 Measurement AND channel 2, S11 measurement. Both with same

stimulus settings and in the same window. Channel 2, S11 measurement is the active measurement.

For more information see [Traces, Channels, and Windows](#)

List of Channel Settings

- [Frequency Span](#)
 - [Power](#)
 - [Cal Set usage](#)
 - [IF Bandwidth](#)
 - [Number of Points](#)
 - [Sweep Settings](#)
 - [Average](#)
 - [Trigger \(some settings\)](#)
-

DC Source Control

When a DC Source (power supply) is configured as an external device and an internal device, the new DC source can be controlled from the VNA using this dialog. Internal DC Sources are also controlled from this dialog.

- [How to start the DC Source Control dialog](#)
- [The DC Source Control dialog box](#)
- [The DC Limits dialog box](#)

See Also

[Configure the DC Source as an External Device](#)

[Internal DC Sources - ADC Measurements](#)

[M9341A/B Module Installation](#)

Other Setup Measurements Topics

How to start the DC Source Control dialog

Using **Hardkey/SoftTab/Softkey**

1. Press **Sweep** > **Source Control** > **DC Source....**

Using a mouse

1. Click **Stimulus**.
2. Select **Sweep**.
3. Select **Source Control**.
4. Select **DC Source**.

[Programming Commands](#)

DC Source Control dialog box help

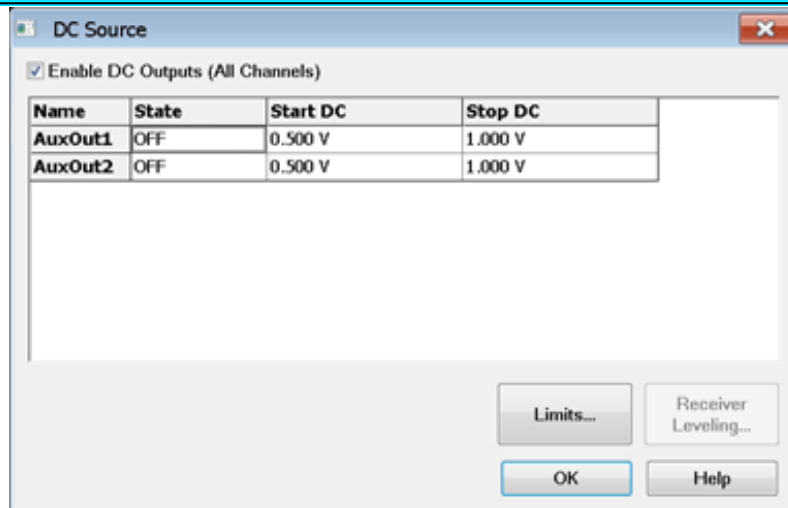

Name Lists the names of the configured DC Sources. In the above image:

- **AuxOut1** and **AuxOut2** are internal VNA DC sources that are available
 - Analog Out 1 and 2 on the M9341B.
- **MyDCSupply** is the name of an external DC Source. [Learn how to setup and configure an External DC Source and DC Meter.](#)

State Set the state of the DC source.

- **ON** DC Source is always ON.
- **OFF** DC source is always OFF.
- **Per Port** The Name selection for that DC source expands to allow an Port <n> / N/A setting for each VNA port. When the RF source for that port <n> is ON, then the DC source for port <n> is also ON. Select 'N/A' to turn the DC Source OFF for that port.

Start / Stop DC Set the start and stop voltages of the DC source. The VNA will step the voltage of the DC source from Start to Stop in increments = (Stop - Start)/Number of data points.

Buttons

Limits Click to start the DC Limits dialog.

Receiver Leveling For future use.

DC Limits dialog box help

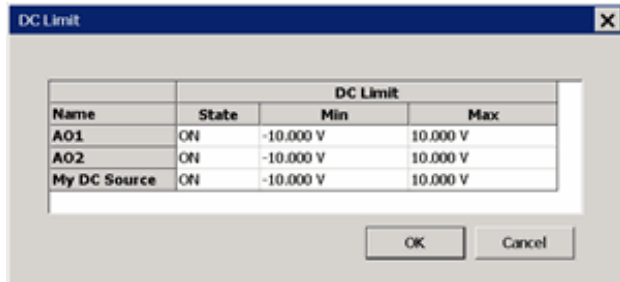

Select the Minimum and Maximum voltages to which the specified DC sources can be set by the VNA. When the DC source level exceeds the limit, DC source is turned off and the measurement sweep stops. For M9485A only, DC source is clumped at the limit level and the measurement sweep continues.

Note: When the M9341B is not located at the next slot of the most right receiver (M9378A/B can be placed between M9377A and M9341B), the measurement speed may be slower. In this configuration, the DC source level exceeding makes sweep stop and DC source off.

Analog Out dialog box help

This tab is displayed only when the M9341B is installed.

Note (M9485A): The M9341B should be placed at next slot of the most right receiver (M9376A/77A). For the M9377A, the M9378A/B can be placed between M9341B and M9377A. Otherwise, the measurement speed becomes slow.

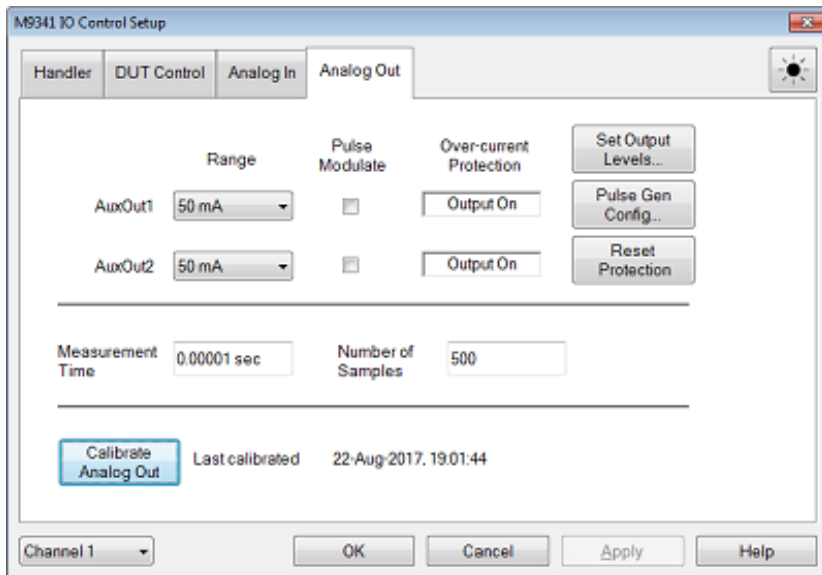

Range Selects the current range of output from 50 m or 500 mA

Pulse Modulate Enable the pulse modulation for Analog output signal. The Analog output signal is output synchronized with the pulse signal which is inputted into SMB Sync 4 port on the M9341B. When the basic RF pulse measurement option (025) is installed, connecting SMB sync 4 and any connector from P1 to P4 allows you to make a pulsed AUX output with the internal pulse signal. When the option is NOT installed, only AuxOut can be pulse modulated and the external pulse signal is required.

Over-current Protection Shows the status of signal output, Output On or Output Off. Note that when the protection turns off the output, the "DC Source" dialog the state of the analog output may still indicate that it is "on" because this state is independent of the protection.

Set Output Levels Displays **DC source** dialog box to define the DC source.

Pulse Gen Config... Displays **Pulse Setup Dialog box** to define the internal pulse signals. This button is displayed and available only when the pulse basic RF pulse measurement option (025) is installed.

Reset Protection Resets the over-current protection for all channels

Measurement Time Specifies the measurement time. This can be calculated by (Number of Samples) x 20 nsec. This is the same entry in **Analog In** Tab.

Number of Samples Specifies number of ADC samples for one point. One ADC sample takes 20 nsec. Increasing this number improves the stability of DC measurement. This is the same entry in **Analog In** Tab.

Calibrate Analog Out Executes the analog out calibration. No setup is required for calibration. Validation of calibration: 1 hour and ± 3 c° from previous calibration.

ADC Measurements

When M937xA, P937xA, and M9485A work with [M9341B Analog/Digital I/O](#), you can measure or output DC signal.

- Analog Inputs (AI1 to AI4) can be used for measuring from -10V to +10V. These inputs can be considered auxiliary measurement receivers and used in a similar way as S-Parameter receivers.
- Analog Output (AOC1 and AOC2) can be used to monitor the current of corresponding DC output..

Note: When analog inputs are measured along with analog output, the input measurement may have some transient noise if output voltage is changed significantly. The timing and level of transient noise will be varied depending on the load of device for analog output. Extending dwell time and sampling period can reduce the influence of noise.

New Trace (ADC) dialog box help

On the [New Trace dialog](#), click the **Receivers** tab.

Activate - check any empty line to create a trace.

Numerator - select from the following:

- **AIx** - Input x: x is Input No.
- **AOCx** - Monitor the current in Amp. of DC output source x: x is output No.

Denominator - NOT available (ONLY unratiod measurements)

Source Port - The ADC receiver is measured when the specified source port is sweeping. Select None to always measure the ADC receiver.

How to Setup Analog Input

Using **Hardkey/SoftTab/Softkey**

1. Press **Setup** > **Internal Hardware** > **PXI Device...**
2. Click **M9341 IO Control Setup..**

Using a mouse

1. Click **Instrument**
2. Select **Setup**
3. Select **Internal Hardware**
4. Select **PXI Device..**
5. Select **M9341 IO Control Setup..**

Programming Commands

Analog In dialog box help

This tab is displayed only when the M9341B is installed.

Note (M9485A): The M9341B should be placed at next slot of the most right receiver (M9376A/77A). For the M9377A, the M9378A/B can be placed between M9341B and M9377A. Otherwise, the measurement speed becomes slow. When you make a pulsed measurement (Option 025), it must be placed at next slot of the most right receiver.

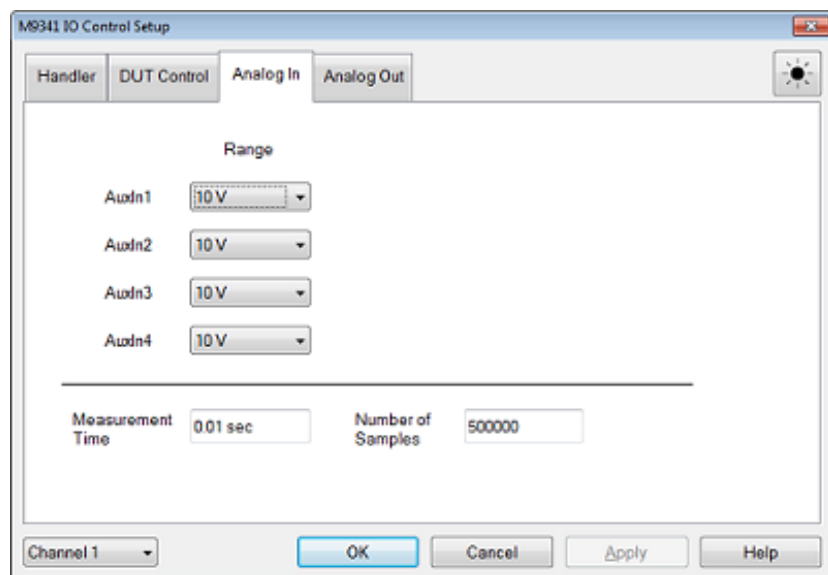

Range : Select from 1, 5 or 10 V. Smaller range has better resolution.

Measurement Time : DC measurement time for one point. This can be calculated by (Number of Samples) x 20 nsec.

Number of Samples : Number of ADC samples for one point. One ADC sample takes 20 nsec. Increasing this number improves the stability of DC measurement.

ADC receiver traces are labeled as shown in the following images:



Tr 2 S22 LogM 10.00dB/ 0.00dB
Tr 4 ADC1,2 Real 2.000U/ 0.00U

- The ADC1 input is being measured, with 2 as the source port.
- The Y axis is U (unitless).
- The default trace **format** is Real (linear).

ADC Traces and other useful VNA functions

Although most VNA functions work with ADC traces, the following may be especially useful.

- **Equation Editor** can be used with the trace data. Although the VNA ADC is measuring voltage, by using a trace formula, this voltage can represent other types of measurement parameters (such as current, temperature, or a scaled voltage). **See PAE example.**
- **Trace averaging** and **Trace Smoothing** can be used to remove trace noise.
- **Dwell time** can be used to allow for settling.

VNA Functions Not Supported

- Calibration for ADC receivers is NOT supported.
- Not supported in **Noise Figure application**

Undo/Redo Settings

If you make an incorrect setting, you can quickly recover by selecting Undo. If you then incorrectly Undo a setting, you can Redo the undone setting.

- Undo and Redo applies ONLY to **selected settings**.
- The Undo stack remembers 16 levels of Undo-able settings.

How to Undo or Redo a setting

Tips:

- Click or touch the Undo and Redo Icons:



Undo Redo

- With a mouse, right-click on the Softkeys or on the Entry toolbar.
- With a keyboard:
 - Undo....Ctrl+Z
 - Redo....Ctrl+Y

Using **Hardkey/SoftTab/Softkey**

1. Press **Undo** > **Main**.
2. Click **Undo** or **Redo**.

Using a mouse

1. Click **Undo** and **Redo** Icons on Active Entry or Softkey Toolbar.

SCPI and COM programming and Undo/Redo:

- There are NO Programming commands to invoke Undo/Redo
- Programing commands are NOT Undo-able.
- The Undo stack is cleared when programming commands are sent to the VNA.

Return To Task

To return to the previous task, press **Undo** > **Main** > **Return To Task**.

Clear Undo History

To clear the Undo stack, press **Undo** > **Main** > **Clear Undo History**.

Undo and Security

- Undo/Redo is disabled with **High** and **Extra** security levels. [Learn more](#).
- State files that are saved for Undo/Redo purposes (for example: Preset) are deleted when any of the following occur:
 - The Security level is changed
 - The Network Analyzer App is started or closed.

Selected Undo-able settings

You can Undo or Redo the following **settings**:

Note: There are several settings that are NOT Undo-able. Because of this, when you attempt to Undo a long sequence of operations, it is unlikely that the original state can be recreated exactly.

- **Preset**
- **File Recall**
- Frequency Settings
- **Turn off Marker** and **Marker All OFF**
- **Number of Points**
- **Power Level** - most applications and S-parameters
- **Turn OFF Channel**
- **Close Window**
- **New Channel , new Window, and new Trace.**
- Delete Trace
- Window Tile
- Change Layout (1x, 2x, 3x, 4x)

- Move Trace, Drag Trace
 - Zoom XY, Zoom Out Full
 - Autoscale All, Autoscale
 - Scale, Reference Level, Reference Position
 - Scale Coupling dialog
 - Electrical Delay
 - Phase Offset
 - Measurement Setups dialog
 - Format
 - Sweep Type
 - Data->Memory
 - Single Marker Searches (Max, Min, Target, Peak...)
 - Multi-marker Searches (Bandwidth, Power Saturation, Normal Operating Pt)
 - Change a Marker's stimulus value: softkeys, dialog or drag
 - Change cell in Segment Table
 - Mechanical Settings dialog
-

Optimize Measurements

A measurement has many interdependent settings. You can modify the settings to achieve the goals of your measurement application: faster throughput or greater measurement accuracy.

Increase Measurement Throughput

- [Achieve Fastest Sweep](#)
- [Switch Between Multiple Measurements](#)
- [Data Transfer Speed](#)
- [Using Macros](#)
- [Speed up PXIe Measurements](#)

Improve Measurement Accuracy

- [Increase Dynamic Range](#)
 - [Reduce Noise](#)
 - [Averaging](#)
 - [IFBW](#)
 - [Smoothing](#)
 - [Group Delay](#) (Separate Topic)
 - [Improve Phase Measurement Accuracy](#)
 - [Improve Accuracy for Electrically Long Devices](#)
 - [Improve Reflection Accuracy on Low-Loss 2-Port Devices](#)
 - [Increase Measurement Stability](#)
 - [Decrease Receiver Crosstalk](#)
 - [Reduce the Effects of Test Accessories](#)
 - [Reduce the unnecessary image response](#) (Shift LO)
-

Caution: Avoid expensive repairs to your analyzer. Read [Electrostatic Discharge Protection](#).

Dynamic Range

Dynamic range is the difference between the analyzer receiver's maximum input power and the minimum measurable power (noise floor). For a measurement to be valid, input signals must be within these boundaries.

Increasing dynamic range is important if you need to measure very large variations in signal amplitude, such as filter bandpass and rejection. The dynamic range is shown below for an example measurement.

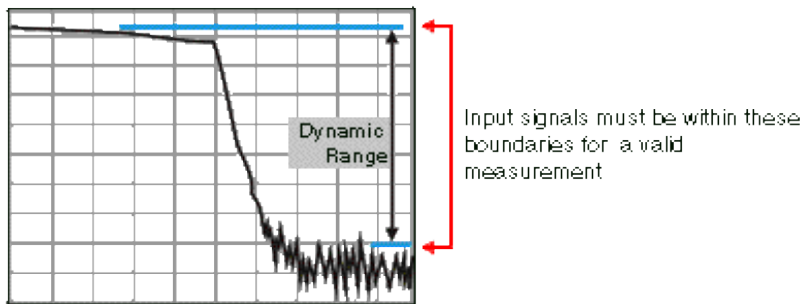

To help reduce measurement uncertainty, the analyzer dynamic range should be greater than the response that the DUT exhibits. For example, measurement accuracy is increased when the DUT response is at least 10 dB above the noise floor. The following methods can help you increase the dynamic range.

- Increase the Device Input Power
- Reduce the Receiver Noise Floor

Other topics about Optimizing Measurements

Increase Device Input Power

Increase the DUT input power so that the analyzer can more accurately detect and measure the DUT output power. However, use caution - too much power can damage the analyzer receiver or cause compression distortion.

Caution! Receiver input damage level: +15 dBm.

See how to increase input power to the device

Tip: You can further increase dynamic range by using an external booster amplifier to increase the input power to the DUT. See High Power Amplifier Measurements.

Reduce the Receiver Noise Floor

You can use the following techniques to lower the noise floor and increase the analyzer's dynamic range.

- Reduce crosstalk between the VNA receivers when measuring signals close to the noise floor. See [Receiver Crosstalk](#).)
 - Use **Sweep Averaging** - learn more about [Sweep Average](#)
 - Reduce the **IF Bandwidth** - learn more about [IF Bandwidth](#).
 - In [Segment sweep](#) mode each segment can have its own IF bandwidth. For example, when measuring a filter:
 - In the passband, the IF bandwidth can be set wider for a fast sweep rate, as long as high-level trace noise is kept sufficiently small.
 - In the reject band, where noise floor contributes significantly to measurement error, the IF bandwidth can be set low enough to achieve the desired reduction in average noise level.
-

Number of Points

A data point is a sample of data representing a measurement at a single stimulus value. You can specify the number of data points that the analyzer measures across a sweep. (A "sweep" is a series of consecutive data point measurements, taken over a sequence of stimulus values.)

The analyzer sweep time changes proportionally with the number of points. However, the overall measurement cycle time does not. See [Technical Specifications](#) for more information on how the number of points, and other settings, affect the sweep time.

How to change the number of data points

Select a number or click Custom to invoke a [dialog box](#)

Using [Hardkey/SoftTab/Softkey](#)

1. Press [Sweep](#) > [Main](#) > [Number of Points](#).

[Programming Commands](#)

Number of Points dialog box help

Specifies the number of data points that the analyzer gathers during a measurement sweep. You can specify any number from **1** to **100,001**. For M980xA and P50xxA, you can specify any number from **1** to **100,003**. The default value is 201.

Two data points are required for [Time Domain](#).

Tips:

- To achieve the greatest trace resolution, use the maximum number of data points.
- For faster throughput use the smallest number of data points that will give you acceptable resolution.
- To find an optimized number of points, look for a value where there is not a significant difference in the measurement when you increase the number of points.
- To ensure an accurate measurement calibration, perform the calibration with the same number of points that will be used for the measurement.

The number of points is the number of data items collected in one sweep. It can be set for each channel independently.

- To obtain a higher trace resolution against the stimulus value, choose a larger value for number of points.
 - To obtain higher throughput, keep the number of points to a smaller value within an allowable trace resolution.
 - To obtain higher measurement accuracy after calibration, perform calibration using the same number of points as in actual measurements.
-

Phase Measurement Accuracy

You can increase the accuracy of phase measurements by using the following features

- [Electrical Delay](#)
- [Phase Offset](#)
- [Spacing Between Frequency Points \(Aliasing\)](#)

See Also

[Port Extensions](#)

[Comparing the Delay Functions](#)

[Learn more about Phase measurements](#)

Electrical Delay

Electrical delay is a mathematical function that simulates a variable length of lossless transmission line.

Use the electrical delay feature to compensate for the linear phase shift through a device. This feature allows you to look at only the [deviation from linear phase](#) of the device.

You can set the electrical delay independently for each measurement trace.

How to set Electrical Delay

Using [Hardkey](#)/[SoftTab](#)/[Softkey](#)

1. Press [Scale](#) > [Electrical Delay](#).

[Programming Commands](#)

Electrical Delay dialog box help

Electrical Delay Specifies the value of delay added or removed, in Time or Distance. This compensates for the linear phase shift through a device. You can set the electrical delay independently for each measurement trace.

Velocity Factor Specifies the velocity factor that applies to the medium of the device that was inserted after the measurement calibration. The value for a polyethylene dielectric cable is 0.66 and 0.7 for PTFE dielectric. 1.0 corresponds to the speed of light in a vacuum.

Velocity factor can also be set from the [Port Extensions](#) dialog and [Time Domain Distance Marker Settings](#).

Softkey Display Allows you to enter delay in either Time or Distance using the softkeys and [Active Entry toolbar](#).

Delay Distance Changes the value when the Delay Time or Delay Distance values are changed.

Distance Units Select from Meters, Inches, or Feet. The step size will not change automatically when this value is changed.

Media

Coax Select if the added length is coax. Also specify the velocity factor of the coax.

Waveguide Select if the added length is waveguide. Also specify the low frequency cutoff of the waveguide.

Cutoff Freq Low frequency cutoff of the waveguide.

Learn about [Electrical Delay](#) (scroll up)

Phase Offset

Phase offset mathematically adjusts the phase measurement by a specified amount, up to 360°. Use this feature in the following ways:

- **Improve the display of a phase measurement.** This is similar to the way you would change the reference level in an amplitude measurement. Change the phase response to center or align the response on the screen.
- **Emulate a projected phase shift in your measurement.** For example, if you know that you need to add a cable and that the length of that cable will add a certain phase shift to your measurement, you can use phase offset to add that amount and simulate the complete device measurement.

How to set Phase Offset

Using **Hardkey/SoftTab/Softkey**

1. Press **Scale** > **Constants** > **Phase Offset**.

◀ **Programming Commands** ▶

Phase Offset dialog box help

Phase Offset Type a value or use the up and down arrows to select any value up to 360 degrees.

Learn about **Phase Offset** (scroll up)

Spacing Between Frequency Points (Aliasing)

The analyzer samples data at discrete frequency points, then connects the points, creating a trace on the screen.

If the phase shift through a device is $>180^\circ$ between adjacent frequency points, the display can look like the phase slope is reversed. This is because the data is undersampled and aliasing is occurring.

If you are measuring group delay and the slope of the phase is reversed, then the group delay will change sign. For example, the following graphic shows a measurement of a SAW bandpass filter.

- The left measurement has 51 points and indicates the group delay is negative, which is a physical impossibility. That is, the response is below 0 seconds reference line.
- The right measurement shows an increase to 201 points which indicates the group delay is positive. That is, the response is above the 0 seconds reference line.

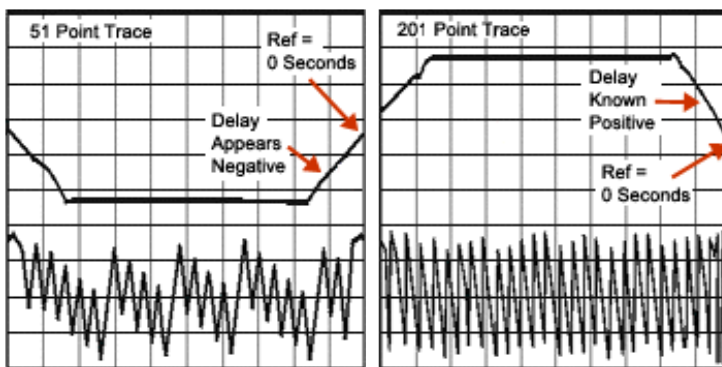

Tip: To check if aliasing might be occurring in a measurement, either **increase the number of points** or **reduce the frequency span**.

Electrically-Long Device Measurements

A signal coming out of a device under test may not be exactly the same frequency as the signal going in to a device at a given instant in time. This can sometimes lead to inaccurate measurement results. You can choose between two techniques to eliminate this situation and increase measurement accuracy.

- Why Device Delay May Create Inaccurate Results
- Solutions to Increase Measurement Accuracy
 - Slow the Sweep Speed

Other topics about Optimizing Measurements

Why Device Delay May Create Inaccurate Results

The following graphic shows an example of this situation:

- In the network analyzer, the source and receiver are locked together and sweep simultaneously through a span of frequencies.
- The signal flow through the Device Under Test (DUT) is shown as different colors for different frequencies.
- You can see as a stimulus frequency travels through the DUT, the analyzer tunes to a new frequency **just before** the signal arrives at the receiver. This causes inaccurate measurement results.

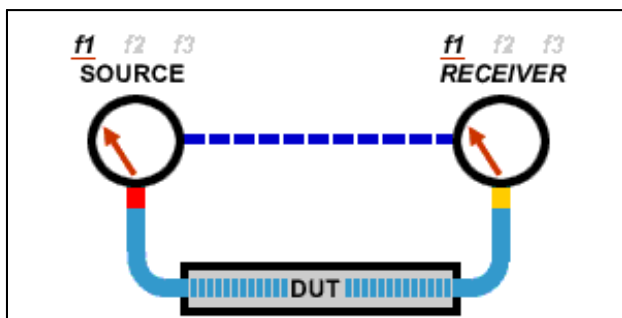

If the analyzer is measuring a long cable, the signal frequency at the end of the cable will lag behind the network analyzer source frequency. If the frequency shift is appreciable compared to the network analyzer's IF bandwidth (typically a few kHz), then the measured result will be in error by the rolloff of the IF filter.

Note: There is no fixed electrical length of a device where this becomes an issue. This is because there are many variables that lead to measurement speed. When high measurement accuracy is critical, lower the sweep speed until measurement results no longer change.

Solutions to Increase Measurement Accuracy

Choose from the following methods to compensate for the time delay of an electrically long device.

Slow the Sweep Speed

The following methods will slow the sweep speed.

- Increase the Sweep Time
 - Increase the Number of Points
 - Use Stepped Sweep
 - Set Dwell Time
-

Reflection Accuracy on Low-Loss 2-Port Devices

To make accurate reflection measurements that have a 1-port calibration, you should terminate the unmeasured port.

- [Why Terminate the Unmeasured Port](#)
- [How to Terminate the Unmeasured Port](#)
- [Resulting Measurement Uncertainty](#)

Other topics about Optimizing Measurements

Why Terminate the Unmeasured Port

A 2-port calibration corrects for all 12 twelve error terms. A 1-port calibration corrects for directivity, source match and frequency response, but not load match. Therefore, for highest accuracy, you must make the load match error as small as possible. This especially applies for low-loss, bi-directional devices such as filter passbands and cables. You do not need to be concerned with load match when you are measuring a device with high reverse isolation, such as an amplifier.

How to Terminate the Unmeasured Port

Use one of the following methods:

- Connect a high-quality termination load (from a calibration kit, for example) to the unmeasured port of your device. This technique yields measurement accuracy close to that of a Full SOLT 2-port calibration.
- Connect the unmeasured port of your device directly to the analyzer, inserting a 10 dB precision attenuator between the device output and the analyzer. This improves the effective load match of the analyzer by approximately twice the value of the attenuator, or 20 dB.

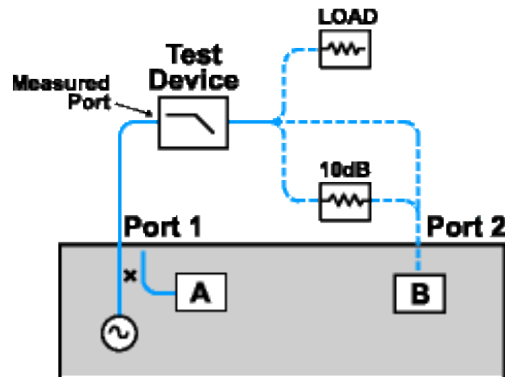

Resulting Measurement Uncertainty

The following graph illustrates the measurement uncertainty that results from terminating **with** and **without** a precision 10 dB attenuator on the output of the test device.

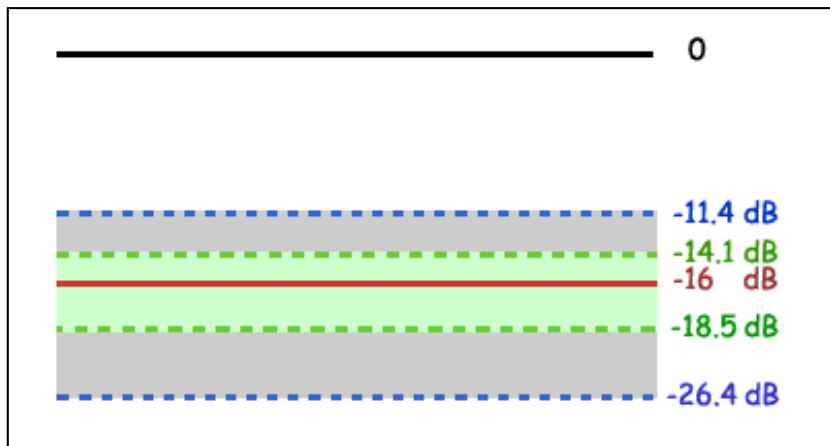

Legend

- Filter Reflection
- - - - - Uncertainty **with** attenuator
- Uncertainty **without** attenuator

The calculations below show how adding a high-quality 10 dB attenuator improves the load match of the analyzer.

Note: The corresponding linear value is shown in parentheses.

Network Analyzer:

$$\text{Load match (NA}_{LM}) = 18 \text{ dB } (.126)$$

$$\text{Directivity (NA}_{D}) = 40 \text{ db } (.010)$$

Filter:

$$\text{Insertion loss (F}_{IL}) = 1 \text{ dB } (.891)$$

$$\text{Return loss (F}_{RL}) = 16 \text{ dB } (.158)$$

Attenuator:

$$\text{Insertion loss (A}_{IL}) = 10 \text{ dB } (.316)$$

$$\text{SWR (A}_{SWR}) = 1.05 (.024)$$

$$32.26 \text{ dB Return Loss}$$

Calculations:

	Without Attenuator	With Attenuator
ρ_{NA}	$= (F_{IL}) * (NA_{LM}) * (F_{IL})$ $= (.891) * (.126) * (.891)$ $= .100$	$= (F_{IL}) * (A_{IL}) * (NA_{LM}) * (A_{IL}) * (F_{IL})$ $= (.891) * (.316) * (.126) * (.316) * (.891)$ $= .010$
$\rho_{Attenuator}$	NA	$= (F_{IL}) * (A_{SWR}) * (F_{IL})$ $= (.891) * (.024) * (.891)$ $= .019$
Worst Case Error (EWC)	$= \rho_{NA}$ $= .1$	$= \rho_{NA} + \rho_{Attn.}$ $= .01 + .019$ $= .029$

Uncertainty Adds	$= -20\log(F_{RL}) + (EWC) + (NA_{D})$ $= -20\log(.158) + (.100) + (.010)$ = 11.4 dB	$= -20\log(F_{RL}) + (EWC) + (NA_{D})$ $= -20\log(.158) + (.029) + (.010)$ = 14.1 dB
-------------------------	---	---

Uncertainty Subtracts	$= -20\log(F_{RL}) - (EWC) - (NA_{D})$ $= -20\log(.158) - (.100) - (.010)$ = 26.4 dB	$= -20\log(F_{RL}) - (EWC) - (NA_{D})$ $= -20\log(.158) - (.029) - (.010)$ = 18.5 dB
------------------------------	---	---

Measurement Stability

There are several situations that can cause unstable measurements. To ensure that you are making repeatable measurements, you can use various methods to create a stable measurement environment.

- [Frequency Drift](#)
- [Temperature Drift](#)
- [Inaccurate Measurement Calibrations](#)
- [Device Connections](#)

Other topics about Optimizing Measurements

Frequency Drift

The analyzer frequency accuracy is based on an internal 10 MHz frequency oscillator. See [Technical Specifications](#) for stability and aging specifications.

If your measurement application requires better frequency accuracy and stability, you can override the internal frequency standard and provide your own high-stability external frequency source through the 10 MHz Reference Input connector on the rear panel.

Temperature Drift

Thermal expansion and contraction changes the electrical characteristics of the following components:

- Devices within the analyzer
- Calibration kit standards
- Test devices
- Cables
- Adapters

To reduce the effects of temperature drift on your measurements, do the following.

- Switch on the analyzer 1/2 hour before performing a measurement calibration or making a device measurement.

- One hour before you perform a measurement calibration, open the case of the calibration kit and take the standards out of the protective foam.
- Use a temperature-controlled environment. All specifications and characteristics apply over a $25\text{ }^{\circ}\text{C} \pm 5\text{ }^{\circ}\text{C}$ range (unless otherwise stated).
- Ensure the temperature stability of the calibration kit devices.
- Avoid handling the calibration kit devices unnecessarily during the calibration procedure.
- Ensure the ambient temperature is $\pm 1^{\circ}\text{C}$ of the measurement calibration temperature.

Inaccurate Measurement Calibrations

If a measurement calibration is inaccurate, you will not measure the true response of a device under test. To ensure that your calibration is accurate, you should consider the following practices:

- Perform a measurement calibration at the points where you connect the device under test, that is, the reference plane.
- If you insert any additional accessory (cable, adapter, attenuator) to the test setup after you have performed a measurement calibration, use the port extensions function to compensate for the added electrical length and delay.
- Use calibration standards that match the definitions used in the calibration process.
- Inspect, clean, and gage connectors. See [Connector Care](#).

See [Accurate Measurement Calibrations](#) for more detailed information.

Device Connections

Good connections are necessary for repeatable measurements. To help make good connections, do the following:

- Inspect and clean the connectors for all of the components in the measurement setup.
 - Use proper connection techniques.
 - Avoid moving the cables during a measurement.
-

Noise Reduction Techniques

Random electrical noise which shows up in the analyzer receiver chain can reduce measurement accuracy. The following features help reduce trace noise and the noise floor which can lead to better dynamic range and more accurate measurements.

- [Averaging](#)
- [IF Bandwidth](#)
- [LF Auto BW](#)
- [Trace Smoothing](#)

See Also

[Group Delay](#)

[Increase Dynamic Range](#)

Other topics about Optimizing Measurements

Averaging

Averaging is a feature that reduces the effects of random noise on a measurement. There are two types of averaging: Point or Sweep.

The Point averaging type computes averaging on each data point before stepping to the next data point. You determine the number of measurements by setting the averaging factor (enabled by clicking the Averaging button). The higher the averaging factor, the greater the amount of noise reduction.

The Sweep averaging type computes averaging on subsequent sweeps until the required number of averaging sweeps are performed.

Effects of Sweep Average

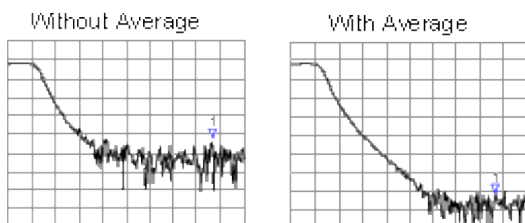

Both **Averaging** and **IF Bandwidth** can be used for the same benefit of general noise reduction. For minimizing very low noise, Averaging is more effective than reducing IF bandwidth. Generally, Averaging takes slightly longer than IF bandwidth

reduction to lower noise, especially if many averages are required. Also, changing the IF bandwidth after calibration results in **uncertain accuracy**.

How to Set Averaging

Using **Hardkey/SoftTab/Softkey**

1. Press **Avg BW** > **Main** > **Averaging**.
2. Enter the Averaging number.

Using a mouse

1. Click **Response**.
2. Select **Avg BW**.
3. Select **Averaging...**

Average dialog box help

Programming Commands

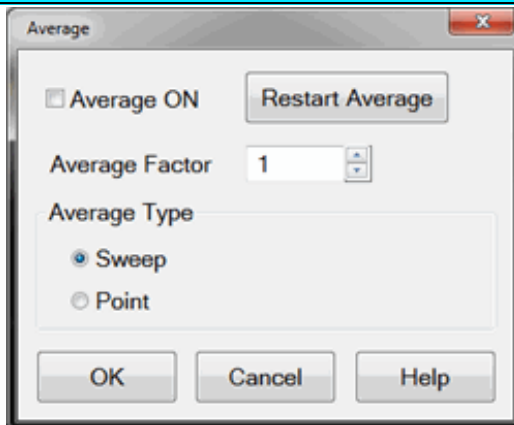

Average ON Check to enable Averaging.

Average Factor Specifies the number of measurements that are averaged. Range of 1 to 65536 (2^{16}).

Average Type

Sweep Each data point is based on the average of the same data point measured over consecutive sweeps. When the number of sweeps = Average Factor, the averaging continues following the **Sweep Averaging formula**.

(Sweep) Restart Begins a new set of measurements that are used for the average. Applies only to Sweep averaging - NOT Point.

Point Each data point is measured the number of times specified by the Average Factor, and then averaged, before going to the next data point.

- On subsequent sweeps, averaging is automatically restarted by measuring each data point again the number of times specified by the Average Factor.
- Because measurements occur quickly in the background, the Average Counter is NOT updated.

- Point averaging is NOT available in **Gain Compression**, or **Noise Figure** Apps.

Notes

- An **Average Counter** appears on the screen when Sweep averaging is selected, displaying the number of sweeps that has been averaged. The effect on the signal trace can be viewed as the Average Factor increases. This can assist in the selection of the optimum number of sweep averages. The Average Counter is NOT updated for **Point** averaging.
- **Channel-wide scope-** Averaging is enabled and the factor is set for all measurements in a channel. The Average counter is displayed for each channel.
- **Calibration** - Because averaging is a mathematical process that occurs after the raw measurement is made, averaging can be turned ON before or after calibration without invalidating the error correction terms. If averaging is ON before calibration, the measurement of calibration standards are averaged measurements. More time is needed to perform the calibration, but there will be less noise in the resulting error correction terms. Subsequent corrected measurements will also have less noise error. In addition, noise is further reduced by turning Averaging ON after calibration.
- **Triggering** is implemented separately from Averaging. For example, setting averaging factor to 4 has NO effect on the number of triggers that are required to achieve 4 sweeps or 4 data points.
- **Unratioed** measurements - Although averaging unratioed (single receiver) measurements is allowed, you may see unexpected results.
 - The noise floor does not drop when averaging unratioed measurements as on ratioed measurements.
 - Phase results may tend toward 0. This is because phase measurements are relative by nature. Measuring absolute phase with a single receiver appears random. Averaging random positive and negative numbers will tend toward 0.

Sweep Averaging Formula

$$\text{NewAvg} = (\text{NewData}/n) + [\text{OldAvg} * (n-1/n)] \text{ 'where } n = \text{average factor}$$

From the formula, you can see that data from the first **n** sweeps continues to be included in the results of subsequent sweeps. Its effect is increasingly smaller but never diminishes to zero. For example, with $n = 5$, the average of the 5 sweeps is displayed. On the 6th sweep, you see $4/5$ the average of the first 5 sweeps plus $1/5$ the new sweep.

The effects of older data can be eliminated by clicking **Restart**.

[Learn more about Averaging](#) (scroll up)

IF Bandwidth

The received signal is converted from its source frequency to a lower intermediate frequency (IF). The bandwidth of the IF

bandpass filter is adjustable down to a minimum of 1 Hz. The maximum IF varies depending on the VNA model.

Reducing the IF receiver bandwidth reduces the effect of random noise on a measurement. Each tenfold reduction in IF bandwidth lowers the noise floor by 10 dB. However, narrower IF bandwidths cause longer sweep times.

- **Channel** - IF bandwidth can be set independently for each channel
- **Segment sweep** - IF bandwidth can be set independently for each segment of segment sweep.
- **Calibration** - Changing the IF bandwidth after calibration will cause a 'C-delta' correction level, which means that calibration accuracy is uncertain.

Effect of Reducing IF Bandwidth

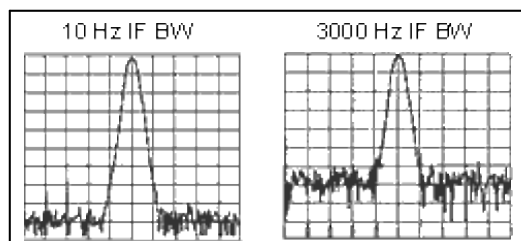

How to set IF Bandwidth

Using **Hardkey/SoftTab/Softkey**

1. Press **Avg BW** > **Main** > **IF Bandwidth**.
2. Enter the IF Bandwidth value.

Using a mouse

1. Right click on the BW icons on the status bar.
2. Select an **IF Bandwidth...**

IF Bandwidth dialog box help

◀ Programming Commands ▶

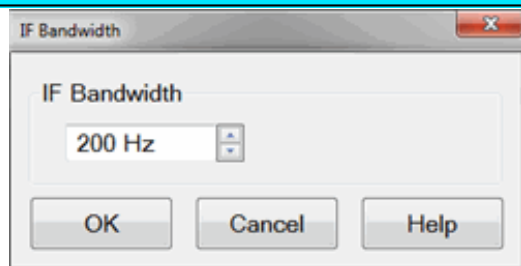

IF Bandwidth Specifies the IF (receiver) bandwidth. The value of IF bandwidth is selected by scrolling through the values available in the IF bandwidth text box. The IF BW is set independently for each channel.

Right click on the BW icons on the status bar then select **IF Bandwidth...** to display the IF Bandwidth dialog:

[Learn about IF Bandwidth](#) (scroll up)

LF Auto BW

When **LF Auto BW** is ON (default), the VNA uses a smaller IF Bandwidth than the selected value at low frequencies. . [Learn about IF Bandwidth](#) (scroll up).

How to enable/disable LF Auto BW

Using [Hardkey](#)/[SoftTab](#)/[Softkey](#)

1. Press [Avg BW](#) > [Main](#) > [LF Auto BW](#).
2. ON enables and OFF disables **LF Auto BW**.

Trace Smoothing

Trace smoothing averages a number of **adjacent** data points to smooth the displayed trace. The number of adjacent data points that get averaged together is also known as the smoothing aperture. You can specify aperture as either the number of data points or the percentage of the x-axis span.

Trace Smoothing reduces the peak-to-peak noise values on broadband measured data. It smooths trace noise and does not increase measurement time significantly.

Because Trace Smoothing follows Format in the data processing map, the formatted data is smoothed. Smoothing is automatically turned off if the format is Polar or Smith Chart.

[Learn more about Data Format Types.](#)

[See the data processing map.](#)

Tips:

- Start with a high number of display points and reduce until you are confident that the trace is not giving misleading results.
- Do not use smoothing for high-resonance devices, or devices with wide trace variations. It may introduce misleading information.
- Smoothing is set independently for each trace.

Effects of Smoothing on a Trace

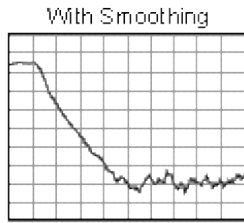
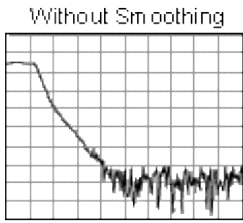

How to set Trace Smoothing

Using **Hardkey/SoftTab/Softkey**

1. Press **Avg BW** > **Smoothing** > **Smoothing ON|OFF**.

◀ **Programming Commands** ▶

Smoothing ON When checked, applies smoothing to the displayed trace.

Percent of Span Specify percent of the swept stimulus span to smooth. For example, for a trace that contains 100 data points, and specify a percent of span = 11%, then the number of data points that are averaged is 11.

Points Specify the number of adjacent data points to average.

[Learn about Trace Smoothing](#) (scroll up)

Crosstalk

Crosstalk is energy leakage between analyzer signal paths. This can be a problem with high-loss transmission measurements. Although the **crosstalk specification** of the analyzer is exceptional, you can reduce the effects of crosstalk by doing the following:

- [Set the Sweep to Alternate](#)
- [Perform an Isolation Calibration](#)

Other topics about Optimizing Measurements

Set the Sweep to Alternate

This selection is no longer available from the user interface. [Learn more.](#)

Perform an Isolation Calibration

For transmission measurements, a response and isolation measurement calibration helps reduce crosstalk because the analyzer measures and then subtracts the leakage signal during the measurement calibration. The calibration improves isolation so that it is limited only by the noise floor.

Note: Isolation is never performed on a Smart (Guided) Calibration. [Learn more.](#)

Generally, the isolation error falls below the noise floor. So when you are performing an isolation calibration you should use a noise reduction technique such as sweep averages or reducing the IF bandwidth.

Effects of Accessories

Accessories in a configuration may affect the results of a device measurement. You can choose between these analyzer features that reduce or remove the effects of accessories

- [Power Slope to Compensate for Cable Loss](#)
- [Gating to Selectively Remove Responses](#)
- [De-embedding a 2-port device](#) (separate topic)

Other topics about Optimizing Measurements

Power Slope to Compensate for Cable Loss

If you have a long cable or other accessory in a measurement configuration where a power loss occurs over frequency, apply the power slope function. This function increases the analyzer source power by a rate that you define (dB/GHz).

1. Press **Power** > **Leveling & Offsets**.
2. If the slope function is not already switched on, click the button beside **Slope**.
3. In the **Slope** box, enter the rate that you want the source power to increase over the frequency sweep.

Gating to Selectively Remove Responses

Gating is a feature in the time domain (option S93010A/B) that allows the analyzer to mathematically remove responses. You can set the gate for either a reflection or transmission response, but you will see different results.

- **Gating a reflection response** isolates a desired response (such as a filter's return loss), from unwanted responses (such as adapter reflections or connector mismatches).
- **Gating a transmission response** isolates a specific path in a multipath device that has long electrical lengths.

See [Time Domain Gating](#) for more information.

Speed up PXIe VNA Measurements

The following features can be used together, or separately, to make faster VNA measurements:

Option 103 - Fast sweep mode.

- [Learn more about the feature.](#)
- [See the SCPI command.](#)

Use PXI-specific 'Trigger' commands

- [SCPI command to set index line logic.](#)
- [SCPI command to efficiently trigger multiple channels.](#)

Shared Memory Data Transfer

- [See SCPI commands](#)

See Also

- [General VNA Measurement Speed Techniques](#)

Achieve Fastest Sweep

You can achieve the fastest measurement sweep by adjusting the following:

- [Sweep Settings](#)
- [Noise Reduction Settings](#)
- [Measurement Calibration Choice](#)
- [Unnecessary Functions](#)

Other topics about Optimizing Measurements

Sweep Settings

Consider changing each of the following settings as suggested.

- **Frequency Span** - Measure only the frequencies that are necessary for your device.
- **Segment Sweep** - Use segments to focus test data only where you need it.
- **Switch Off Stepped Sweep** - Use linear swept mode to minimize sweep time when possible.
- **Auto Sweep Time** - Use this default to sweep as quickly as possible for the current settings.
- **Number of Points** - Use the minimum number of points required for the measurement.

For more information on how number of points and other settings affect sweep cycle time, see [Technical Specifications](#).

Noise Reduction Settings

Using a combination of these settings, you can decrease the sweep time while still achieving an acceptable measurement.

- **IF Bandwidth**. Use the widest IF bandwidth that will produce acceptable trace noise and [dynamic range](#).
- **Average**. Reduce the average factor, or switch Average off.

Measurement Calibration Choice

Choose the appropriate type of calibration for the required level of accuracy.

When full 2-port error correction is applied, the analyzer takes both forward and reverse sweeps to gather all 12 error correction terms. This occurs even with a single S11 measurement displayed. All displayed measurements are updated as the second sweep is performed. Both sweeps are performed using the specified sweep time.

When calibrating greater than 2 ports, the following formula is used to determine the number of sweeps required:

- $N * (N-1)$ where N = the number of ports.

When full 3-port calibration is applied, 6 sweeps are required; forward and reverse for each port pair. With full 4-port correction, 12 sweeps are required, and so forth.

To limit the measurement time, perform ONLY the level of calibration that your measurements require. For example, if making only an S11 measurement, perform a 1-port calibration on that port.

Sweep speed is about the same for uncorrected measurements and measurements done using a response calibration, or one-port calibration. For more information see [Select a Calibration](#).

Unnecessary Functions

The analyzer must update information for all active functions. To achieve an additional increase in sweep speed, switch off all of the analyzer functions that are not necessary for your measurement application.

- [Delete Unwanted Traces](#)
- [Switch Off Unwanted Markers](#)
- [Switch Off Smoothing](#)
- [Switch Off Limit Testing](#)
- [Switch Off Math Functions](#)

Analyzer sweep speed is dependent on various measurement settings. Experiment with the settings to get the fastest sweep and the measurement results that you need.

Switch Between Multiple Measurements

If you need to make multiple measurements to characterize a device, you can use various methods to increase throughput. Experiment with these methods to find what is best for your measurement application needs.

- [Set Up Measurements for Increased Throughput](#)
 - [Arrange Measurements in Sets](#)
 - [Use Segment Sweep](#)
 - [Trigger Measurements Selectively](#)
- [Automate Changes Between Measurements](#)
- [Recall Measurements Quickly](#)

Other topics about Optimizing Measurements

Set Up Measurements for Increased Throughput

To achieve optimum throughput of devices that require multiple measurements, it is helpful to know the operation of the analyzer. This knowledge allows you to set up the measurement scenarios that are best for your applications.

[Learn more about Traces, Channels, and Windows](#)

Arrange Measurements in Sets

If you arrange measurements to keep the complete set of device measurements in one instrument state, you can save them so that you can later recall a number of measurements with one recall function.

See [Pre-configured Measurement Setups](#) for more information.

Use Segment Sweep

Segment sweep is helpful if you need to change the following settings to characterize a device under test.

- Frequency Range
- Power Level
- IF Bandwidth
- Number of Points
- Delay
- Sweep Mode
- LO Offset

The segment sweep allows you to define a set of frequency ranges that have independent attributes. This allows you to use one measurement sweep to measure a device that has varying characteristics.

See [Segment Sweep](#) for more information.

Trigger Measurements Selectively

You can use the measurement trigger to make measurements as follows:

- Continuously update only the measurements that have rapidly changing data.
- Occasionally update measurements that have infrequently changing data.

For example, if you had four channels set up as follows:

- Two channels measuring the data that is used to tune a filter
- Two channels measuring the data for the out-of-band responses of the filter

You would want to constantly monitor only the measurement data that you use for tuning the filter. If you continuously update all of the channels, this could slow the response of the analyzer so that you would not be able to tune the filter as effectively.

Note: You must either trigger the infrequent measurement manually or with remote interface commands.

To trigger measurements selectively:

This procedure shows you how to set up two different measurements with the following behavior:

- Channel 1 measurement will continuously update the data.
 - Channel 2 measurement will occasionally update the data.
1. Press **Setup > Quick Start**.
 2. At the **Quick Start** dialog box, click **Create in new channel**.
 3. **Frequency Sweep** dialog box shows. Enter the preferred sweep setting.

Set Up a Measurement Trigger for Continuous Updates

1. Press **Trigger > Trigger Source** and select **Internal**.
2. Press **Trigger > Trigger....**
3. At the **Trigger** dialog box under **Channel Trigger State**, select **Channel 1**, and click **Continuous**.

Set Up a Measurement Trigger for Occasional Updates

1. At the **Trigger** dialog box under **Channel Trigger State**, select **Channel 2**, and click **Single, OK**.
2. Press **Trigger > Restart**.

Update the Measurement

1. Click on the lower window to make Channel 2 the active measurement.
2. On the active entry toolbar, click the type of trigger you set up.
 - o Click **Single** if you set up the analyzer for a single sweep per trigger.
 - o Click **Groups** if you set up the multiple sweeps per trigger.

Note: A trace must be active for you to initiate a trigger for that measurement.

Automate Changes Between Measurements

If there are slight differences between the various measurements that you need to characterize a device, you may find that it is faster to change the measurement settings using programming.

Recall Measurements Quickly

The most efficient way to recall measurements is to recall them as a set of measurements (instrument state).

- It only takes a short time longer to recall an instrument state that includes multiple measurements, than it does to recall an instrument state with only one measurement.
- Each recall function has time associated with it. You can eliminate that time by setting up the measurements as a set so you can recall them as a set.

See [Save and Recall Files](#) for more information.

Data Transfer Speed

When testing devices remotely using SCPI, the following techniques can be used to transfer data quickly between the analyzer and remote computer, helping you achieve the best measurement throughput.

- Use **single sweep (trigger) mode** to ensure that a measurement is complete before starting a data transfer.
- **Transfer the minimum amount of data** needed. For example, a trace with a few points, using segment sweep rather than a full trace with many linearly spaced points. Also, use markers instead of trace transfers.
- **Choose the REAL data format** to provide the fastest transfer speed when using SCPI programs for automated applications.
- Use **SCPI over LAN** for applications that are automated with SCPI programs.
- Use **Shared Memory Data Transfer**. [Learn how.](#)

Other topics about Optimizing Measurements

Setting Shift LO (Reducing Unnecessary Image Response)

- [Overview](#)
- [Turning ON Shift LO Mode](#)

Other topics about Optimizing Measurements

Overview

The Shift LO mode is used to set the local signal (LO). Generally, the VNA sets the local signal (LO) as $RF+IF$. However, this causes image response at certain frequencies. To reduce the unnecessary image response, the LO mode allows you to select the local signal (LO). This function is available on the E5080A, M980xA, P50xxA and M9485A.

Shift LO mode should be turned ON for frequencies below the center frequency of the bandpass filter and turned OFF for frequencies above the centre frequency of the bandpass filter.

- Shift LO mode ON: $LO = RF-IF$
- Shift LO mode OFF: $LO = RF+IF$

Note: This function is not available for frequencies below 150 MHz (E5080A), 400 MHz (M9485A), 322.375 MHz (M980xA, P50xxA).

How to turn on Shift LO mode

Using [Hardkey](#)/[SoftTab](#)/[Softkey](#)

1. Press [Sweep](#) > [Source Control](#) > [Shift LO](#).
2. Input the maximum frequency.
3. Click the switch of the softkey to turn on the Shift LO function.

[Programming Commands](#)

Note: System calibration (adjustment) is not taken into account when Shift LO mode is ON. Calibration should be performed before your measurement. If this function is turned ON after a calibration, “C” is changed to "CΔ" on the status bar.

Note: When List Shift LO in Segment Sweep is OFF, the setting of global setting (**Sweep** > **Source Control** > **Shift LO**) is used.

Max Frequency

Sets the maximum frequency for the measurement sweep. By default, the maximum frequency is set to the maximum frequency of the unit.

Note: This setting is only valid when the Shift LO mode is turned ON.

Using Macros

Macros are executable programs that you write, load into the analyzer, and then run from the analyzer. You can have up to 25 macros set up to run on the analyzer.

- [How to Setup Macros](#)
- [How to Run Macros](#)
- [Macro Example](#)

How to Setup Macros

Using [Hardkey](#)/[SoftTab](#)/[Softkey](#)

1. Press **Macro** > **Key Setup** > **Macro Setup....**

In the Macro Setup dialog box:

1. Create an executable program and save it on the VNA hard drive. See [SCPI](#) example programs in VBScript.
2. Use a mouse or the front-panel 'down-arrow' to select a blank line below the last entry. (There may be NO entry.)
3. Click **Edit** to start the **Edit Macro Setup** dialog.
4. In the **Macro Title** box, type a descriptive title for your macro.
5. Click **Browse**.
6. Change **Files of Type**.
7. Find and select your executable file. Change **Files of Type** if necessary.
8. Click **OK** on the Edit Macro Setup dialog.
9. Click **OK** on the Macro Setup dialog.
10. Press **MACRO** to run. It may be necessary to first Preset the VNA to see your macro in the menu.

Macro Setup dialog box help

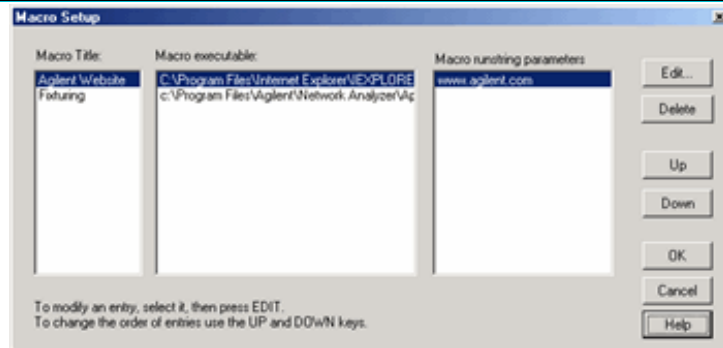

Macro setup allows you to create up to 25 macros that can be launched from the VNA application.

An external keyboard is required to enter the Macro Title and the Run string parameters.

To add a Macro, use a mouse or the front-panel 'down arrow' (NOT the 'Down' key) to select a blank line. Then click **Edit**.

Macro Title Shows the titles that appear in the softkeys and menu when you press the Macro key. These titles are associated with the executable files and should be descriptive so you can easily identify them.

Macro Executable Lists the complete path to the executable file. To follow the example of launching the Keysight VNA Series Home Page, the path to the executable could be "C:/Program Files/Internet Explorer/iexplore.exe".

Macro Runstring Parameters Lists the parameters that get passed to the program that is referenced in the executable file. Again following the example of launching the VNA Series Home Page, you could assign the runstring parameters "http://www.Keysight.com/find/pna".

Edit Invokes the **Macro Edit dialog box**.

Delete Deletes the selected macro.

Up Allows you to reorder the macros, moving the selected macro up one line. This order determines how they appear in the VNA Menu and in the softkeys and when you press the Macro front-panel key.

Down Moves the selection down one line in the list of macros.

Macro Edit dialog box help

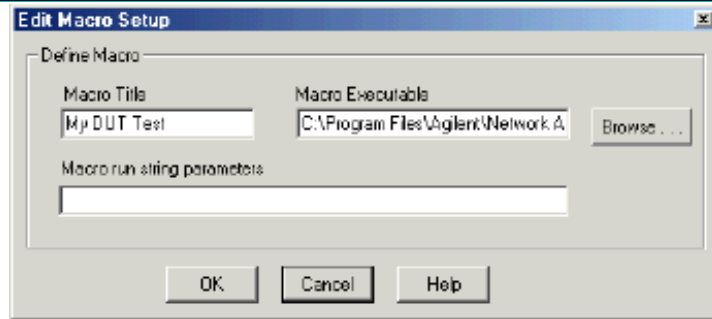

Macro Title Add a title that appears in the softkeys and menu.

Macro Executable Set the complete path to the macro executable file. Click **Browse** to navigate to the macro executable file and establish the complete path to the file.

Macro run string parameters Optionally add parameters that are passed to the program referenced in the executable file.

[See Macro Setup dialog box](#)

How to Run Macros

Using **Hardkey/SoftTab/Softkey**

1. Press **Macro > Macro<#>**.

Macro Example

The following is an example Visual Basic Scripting (vbs) program that you can copy, install, and run on your VNA.

Note: Print these instructions if viewing in the analyzer. This topic will be covered by the Macro Setup dialog box.

1. Copy the following code into a **Notepad file**.
2. Save the file on the analyzer hard drive in the **C:/Documents** folder. Name the file **FilterTest.vbs**
3. Close Notepad

4. Setup the macro in the VNA
5. Run the macro

```
'Start copying here
'This program creates a S21 measurement
'It is written in VBscript using SCPI commands

Dim app
Dim scpi
'Create / Get the VNA application
Set app = CreateObject ("AgilentPNA835x.Application")
Set scpi = app.ScpIStringParser

'Preset the Analyzer.FPREset presets the setting and deletes all traces and windows
scpi.Execute ("SYST:FPREset")
'Create and turn on window 1
scpi.Execute ("DISPlay:WINDow1:STATE ON")
'Define a measurement name, parameter
scpi.Execute ("CALCulate:PARAmeter:DEFine:EXT 'MyMeas', 's21'")
'Associate ("FEED") the measurement name ('MyMeas') to WINDow (1), and give the new
TRACE a number (1).
scpi.Execute ("DISPlay:WINDow1:TRACe1:FEED 'MyMeas'")

'End copying here
```

System Power Calibration (M9485A)

Overview

The system power calibration is required after the configuration setup for M9485A. After you installed all modules, the system power calibration should be executed once. The calibrated data is stored in your PC with your configuration. It is valid unless the configuration is changed. The purpose of calibration and procedure are different depending on the receiver module. This feature is available only on the M9485A.

M9376A

- Purpose
 - Calibrate the source power level and linearity at the test ports.
 - Calibrate the source power for the parallel measurements.
- Procedure
 - Calibration for power level only.

M9377A Direct Access Receiver configuration

- Purpose
 - Calibrate the source power level and linearity at the M9377A source output ports.
- Procedure
 - Calibration for power level only.

Combination of M9377A and M9378A

- Purpose
 - Calibrate the source power level and linearity at the test ports.
 - Acquire 1 port error term.
- Procedure
 - Calibration for power level, S parameters and absolute measurement parameters.

- In the procedure, one port is assigned as a reference port. The port is calibrated with a power sensor, then the other ports are calibrated with the reference port. If your configuration has any M9376As, the lowest number port of M9376A is assigned as the reference port. If your configuration has sets of M9377A and M9378A only, two ports are assigned as reference ports with the following priority (standard configuration, Wide Dynamic Range configuration, High Power configuration, High Gain configuration).

Note: Error Terms of cal set does not include the error terms of both M9377A and M9378A after user calibration.

Notes

- Setting **User Preset** file is highly recommended when your configuration includes M9377A and M9378A modules. This can avoid occurring power unlevelled error after every boot up.
- Procedure
 - When you restart the firmware, set start frequency and initial power level properly. Then use the setting as “User preset status” from Preset > User Preset..., and select Save current state as User Preset and check User Preset Enable.
- Typical setting for each configuration:
 - Configuration / Start frequency / Power
 - STD / 50 MHz / 0 dBm
 - DA / 50 MHz / 0 dBm
 - WDR / 500 MHz / -15 dBm
 - HP / 50 MHz / -30 dBm
 - HG / 500 MHz / -35 dBm

Procedure

Required Equipment

- 50 Ω Termination (A 50 Ω Termination is equipped on the IF Out connector on M9376A and ATT out connector on M9378A at factory shipment.) (This is optional for M9377A Direct Access Receiver configuration)

- Power Sensor and Power Meter (**Supported Power Meters**, excepts 437B/438A) and a cable about 50 cm/20 inch for connection (This is optional for M9376A)
- Mechanical **Calibration Kits** or **ECal** (3.5mm, frequency range:1 M to 9 GHz) (This is required for a combination of M9377A/M9378A.)

Using **Hardkey/SoftTab/Softkey**

1. Wait 45 minutes after power on for warm up
2. When a power sensor is used, execute the power sensor zeroing and calibration.
3. Confirm if the HiSlip is enabled and address is set at 0 by clicking **System** > **System Setup...** > **Remote Control...**
4. Press **System** > **Service** > **System Power Cal...**

When your configuration does not include any M9377As:

1. Click Ok
2. Follow the instruction to complete the calibration.
3. The calibration takes about 30 to 40 minutes depending the installed module configuration.
4. Software Front Panel must be restarted after the calibration is done.

When your configuration includes M9377A:

1. Click Calibration button.
2. The System Power Calibration Dialog is displayed.
3. Confirm the installed module and port configuration for M9377A/M9378A. If the port configuration change is required, click Edit Config. button.
4. The required equipment is shown in the dialog.
5. Follow the instruction to complete the calibration.
6. The calibration takes about 30 to 50 minutes depending the installed module configuration.
7. Software Front Panel must be restarted after the calibration is done.

Note: If the system power calibration is aborted, restart the Software Front Panel.

When the system power calibration and port configuration (for M9377A/78A) is not performed on the current configuration, the one of following messages is displayed at power on.

- Set configuration using Port config wizard. Port config data is not found and typical data of DA config is used.
- Port config data was found but corresponded system power cal file is not found. Typical system power cal data is used.

When the configuration is changed such as the module is replaced, this message will be displayed again and required to execute port configuration and system power calibration.

Select a Calibration Type

The following calibration types are available in the VNA.

Cal Type	Interface	Accuracy	Thru Methods allowed
TRL Family	Both	Very High	All except Unknown Thru
SOLT	Both	High	All
Enhanced Response	SmartCal	High	Defined Thru or Flush Thru
QSOLT (Quick SOLT)	SmartCal	Medium	Defined Thru or Flush Thru
1-Port Reflection	Both	High	Not Applicable
Open/Short Response	Unguided	Low	Not Applicable
Thru Response	Unguided	Low	Known Thru or Flush Thru

[Learn how to select a default Cal Type.](#)

Other Cal Types (Separate Topic)

- [Source and Receiver Power Cals](#)

[See other Calibration Topics](#)

TRL Family

Application: Used to accurately calibrate any pair of ports when calibration standards are not readily available.

Note: A Delta Match Cal may be required.

- [Learn more about TRL family cal](#)
- For more information on modifying standards, see [Calibration Standards](#).

Calibration Method: [SmartCal](#), [Unguided Calibration](#)

General Accuracy: Very High

Standards Required: THRU, REFLECT, LINE or similar combination

Systematic Errors Corrected:

- Directivity
 - Source match
 - Isolation ([see exceptions](#))
 - Load match
 - Frequency response transmission tracking
 - Frequency response reflection tracking
-

SOLT

Application: Used to accurately calibrate any number of ports.

General Accuracy: High

Calibration Method: **SmartCal**, **Unguided Calibration**, **ECal**

Standards Required: (SHORT, OPEN, LOAD, THRU) or ECal module

Systematic Errors Corrected (on all ports):

- Directivity
 - Source match
 - Isolation (**see exceptions**)
 - Load match
 - Frequency response transmission tracking
 - Frequency response reflection tracking
-

Enhanced Response

Application: Used to calibrate two ports when only measurements in one direction (forward OR reverse) are required. Measurements are faster because a second sweep is NOT required.

- Reflection Standards (OPEN, SHORT, LOAD) are connected to the source port to be calibrated.
- **Defined THRU** or **Flush THRU** standard is connected between port pairs.
- Much quicker than SOLT when using a mechanical cal kit. ECal can also be used.

To select Enhanced Response:

For a standard S-parameter Cal, select **Cal** > **Main** > **Basic Cal...**

Then, In the **Basic Cal** dialog box:

1. Under 'Cal Type', select **Enh Response 1-> 2 Enh** or **Response 2-> 1**.
-

General Accuracy: High

Calibration Method: **SmartCal**, **ECal**

Standards Required: (SHORT, OPEN, LOAD, **Defined THRU** or **Flush THRU**)

Systematic Errors Corrected:

- Directivity (source port)
 - Source match (source port)
 - Isolation (**see exceptions**)
 - Load match (receiver port) - used only to produce transmission tracking term.
 - Frequency response transmission tracking (receiver port).
 - Frequency response reflection tracking (source port).
-

QSOLT (Quick SOLT)

Application: Used to quickly calibrate any number of ports. Developed specifically for use with external multiport test sets.

Note: A Delta Match Cal is required to cal test ports that do not have a dedicated reference receiver.

- Reflection Standards (OPEN, SHORT, LOAD) are connected to only ONE of the ports to be calibrated. The lower port number of the ports to be calibrated is selected by default. This can be changed through the **Modify Cal / Cal Type** setting.
- **Defined THRU** or **Flush THRU** standards are connected from the reflection standard port to the remaining ports to be calibrated.
- Much quicker than SOLT when using a mechanical cal kit.
- Based on TRL math.

General Accuracy: Not as high as SOLT

Calibration Method: **SmartCal, ECal**

Standards Required: (SHORT, OPEN, LOAD, **Defined THRU** or **Flush THRU**)

Systematic Errors Corrected:

- Directivity
- Source match
- Isolation (**see exceptions**)
- Load match
- Frequency response transmission tracking
- Frequency response reflection tracking

1-Port (Reflection)

Application: Used to accurately calibrate any single test port for reflection measurements only.

Calibration Method: **SmartCal, Unguided Calibration, ECal**

General Accuracy: High

Standards Required: (SHORT, OPEN, LOAD) or ECal module

Systematic Errors Corrected:

- Directivity
- Source match
- Frequency response reflection tracking

Open / Short Response

Application: Used to quickly calibrate any single test port for reflection measurements only.

Calibration Method: **Unguided Calibration**

General Accuracy: Low

Standards Required: OPEN or SHORT

Systematic Errors Corrected:

Frequency response reflection tracking

Thru / Transmission Response (Isolation Optional)

Application: Used to quickly calibrate any pair of test ports for transmission measurements only.

Isolation is not usually recommended. Learn more about **Isolation**

Calibration Method: **Unguided Calibration** and Guided Cal from the 'Select DUT Connectors page', check **Modify Cal**, then click **Next**.

General Accuracy: Low

Standards Required: THRU

Isolation: One LOAD for each VNA test port.

Systematic Errors Corrected:

- Frequency response transmission tracking
 - Isolation
-
-

Calibration Thru Methods

- [What is a Non-Insertable Device](#)
- [Choosing a Thru Method](#)
- [Flush Thru](#)
- [Adapter Removal](#)
- [Swap Adapters and Offset Delay](#) (separate topic)
- [Defined Thru](#)
- [Unknown Thru](#)
- [ECal Thru Method Choices](#)

Other Cal Topics

What is a Non-Insertable Device

To understand the Thru method choices, you must first understand what is meant by "Non-Insertable device". These definitions also apply to ECal modules. Substitute "ECal module" for "device". Then see [ECal Thru Method Choices](#).

A **non-insertable device** is one whose connectors could NOT mate together. They either do not have the same type of connector or they have the same gender. This also means that the test port cables would not mate together, as in the following diagram.

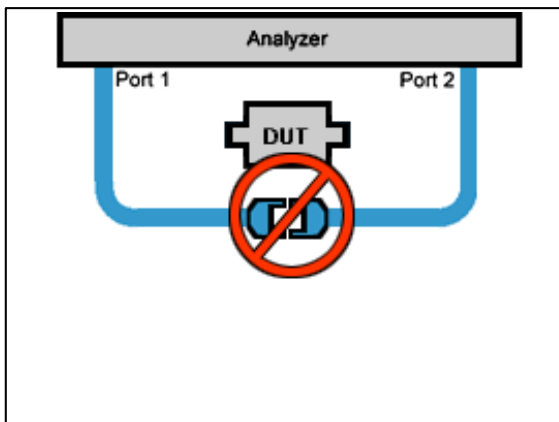

An **insertable** device is one whose connectors could mate together. They have the same type of connector and opposite, or no, gender. This also means that the test port cables would mate together, as in the following diagram.

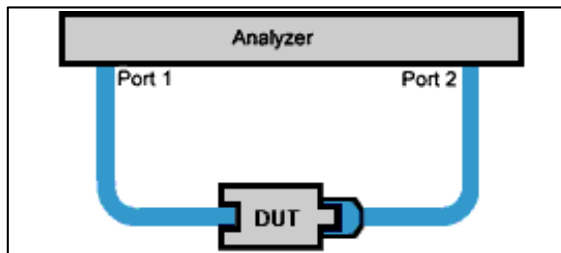

Choosing a Thru Method of Calibration

The Thru method is selected from the Cal Wizard. Select the **Modify** checkbox in the **Select DUT Connectors and Cal Kits** dialog box.

Notes:

For ECal, the following choices have different meanings. See [THRU methods for ECal](#).

For 4-port calibration, see [How can we measure only 3 THRU connections?](#)

Choice for Insertable Devices: FLUSH Thru (also known as Zero-length Thru)

When calibrating for an insertable device, the test ports at your measurement reference plane connect directly together. This is called a zero-length THRU, or Flush THRU meaning that the THRU standard has zero-length: no delay, no loss, no capacitance, and no inductance. Your calibration kit may not have a physical THRU standard because it is assumed you have an insertable device and will be using a zero-length THRU.

Choices for Non-Insertable Devices

The following methods calibrate for a non-insertable device:

- **Adapter Removal** Accurate, but least convenient.
- **Defined Thru**
- **Unknown Thru Cal** Preferred method.

Adapter Removal Calibration

The accuracy of the Adapter Removal calibration is very similar to the accuracy of the Unknown Thru calibration. However, the Unknown Thru calibration has fewer connections and therefore has the potential of being more accurate than the Adapter Removal calibration.

Two full 2-port calibrations are performed: one with the adapter connected at port 1, and the other with the adapter connected to port 2. The result of the two calibrations is a single full 2-port calibration that includes accurate characterization and removal of the mismatch caused by the adapter.

Performing an Adapter Removal Cal requires:

- a THRU adapter with connectors that match those on the DUT.
- calibration standards for both DUT connectors.

To select Adapter Removal during a SmartCal, select the **Modify** checkbox in the **Select DUT Connectors and Cal Kits** dialog box. The Cal Wizard will guide you through the steps.

Learn how to perform an [Adapter Removal Cal using ECal](#).

Defined Thru (also known as Known Thru, Cal Kit Thru, ECal Thru, Characterized Thru)

Defined Thru uses the THRU definition that is stored in the Cal Kit file or ECal module. The THRU standard may have worn over time, making it not as accurate as when it was new. Defined Thru is usually more accurate than Adapter Removal, but not as accurate as [Unknown Thru](#) method.

Notes

- If performing an ECal, this is the THRU standard in the ECal Module.
- If Defined Thru appears as a potential THRU method in the [SmartCal Wizard](#), this means that there is a defined THRU standard in the selected Cal Kit. This could be a [Zero-length Thru](#). The SmartCal Wizard will prompt you to connect the required standard when appropriate.

To define a THRU standard in a Cal Kit (not ECal module):

1. Click [Cal](#) > [Cal Sets & Cal Kits](#).
2. Click [Cal Kit...](#)
3. Select the Cal Kit from the list.
4. Click [Edit...](#)

5. Select the **Standards** tab.
6. Click **Add...**
7. Select **THRU**.
8. Complete the dialog box.

The next time you perform a Guided Cal, this Defined THRU standard will be available if the DUT connector types match the THRU standard.

Unknown Thru Cal

Unknown Thru Cal is the **preferred** THRU method of calibrating the analyzer to measure a non-insertable device.

The Unknown Thru calibration is also known as **Short-Open-Load-Reciprocal Thru** (SOLR) calibration.

- Very easy to perform.
- Better accuracy than **Defined Thru** and usually better than **Adapter Removal**.
- Does not rely on existing standard definitions that may no longer be accurate.
- Causes minimal cable movement if the THRU standard has the same footprint as the DUT. In fact, the DUT can often BE the THRU standard.
- NOT recommended when there is 40 dB or more of combined loss in the Unknown Thru and calibration path. This would NOT allow enough signal to accurately measure at the receiver.

About the Unknown Thru Process

SmartCal guides you through the process. Although the following process describes ports 1 and 2, Unknown Thru can be performed on any two ports when using a multiport analyzer.

1. Perform 1-port cal on port 1.
2. Perform 1-port cal on port 2.
3. Connect Unknown Thru between ports 1 and 2.
4. Measure Unknown Thru.
5. **Confirm Estimated Delay**. This estimate may be wrong if there are too few frequency points over the given frequency span. You can measure the delay value independently and enter that value in the dialog box.

The Unknown Thru Standard

- Can have up to 40 dB of combined loss in the Unknown Thru and calibration path.
- Must be reciprocal: $S_{21}=S_{12}$.
- Must know the phase response to within 1/4 wavelength (see step 5 above).
- Can be the DUT if it meets these conditions.

Unknown Thru Limitations

- Unknown Thru is NOT supported during a TRL calibration from the GUI.
- Cable movement introduces measurement errors.

ECal Thru Method Choices

When the ECal module connectors exactly match the DUT connectors, choose from the following THRU methods:

ECal Thru as Unknown Thru [Learn more about Unknown Thru.](#)

- Measures the THRU state of the ECal module as an Unknown Thru.
- The default method when the ECal module connectors match the DUT.
- Very accurate and easy.

Flush Thru (zero-length Thru) [Learn more about Flush Thru](#)

- Requires an insertable ECal module / DUT.
- Remove the ECal module and connect the two reference planes directly together for a zero-length thru.
- Accurate, but not as easy as 'ECal Thru as Unknown Thru'.

ECal (Defined Thru)

- Measures the THRU state of the ECal module.
- Very easy, but not as accurate as 'ECal Thru as Unknown Thru'

Unknown Thru

- Remove the ECal module.
- Then connect a Thru adapter to be measured as Unknown Thru.

When the ECal module connectors do NOT exactly match the DUT connectors, choose from the following two methods:

Adapter Removal

- Can be used with ECal when your DUT is **NON-insertable**. However, the ECal module **MUST** be insertable, and the adapter connectors must exactly match the connectors of the DUT as in the following diagram.
- Adapter removal performs 2-port measurements on both sides of the adapter.

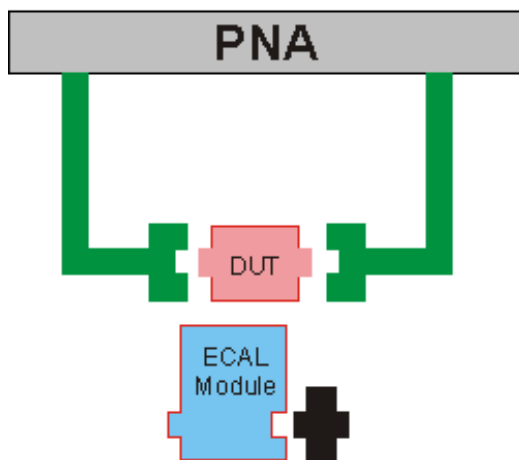

ECal User Characterization

In cases when adapter removal cannot be performed, ECal **User Characterization** is ALWAYS possible if you have the right adapters. A User Characterization is performed once and stored in the ECal module. However, accuracy is compromised every time you remove, then reconnect, the adapter with the ECal module.

Calibration Wizard

The Calibration Wizard allows you to choose a Calibration method and then perform the calibration.

- [How to Start Calibration Wizard](#)
- [SmartCal \(Guided Calibration\)](#)
- [Basic Calibration](#)
- [Unguided Calibration](#)
- [Saving a Calibration](#)

Other Cal Topics

How to start Calibration Wizard

Using [Hardkey/SoftTab/Softkey](#)

1. Press [Cal](#) > [Other Cals](#) > [Smart Cal...](#)

[Programming Commands](#)

The Calibration Window / Channel

During a Guided Calibration, a 'Cal Window' is created for you to view the connection of calibration standards before standards are measured. This Cal Window uses a new Cal channel that is created and duplicates the settings in the channel being calibrated. **Correction is ALWAYS OFF** for the displayed calibration channel. At the completion of the calibration, the calibration channel and window are deleted.

The measurement of calibration standards can be performed while viewing any VNA window configuration you choose. The Cal Window is appended to your Custom Cal Window setting, and all windows are visible and sweeping below the Cal Wizard before the Measure (cal standard) button is pressed. The windows to be viewed and channels to be swept during the cal process are specified using **Remote commands**. [See an example](#).

SmartCal (Guided Calibration)

A Guided Calibration automatically determines the calibration type and suggests a calibration kit that matches your DUT connectors.

Guided Calibration can perform the following Cal Types:

- ALL Cals **EXCEPT Open, Short, and Thru Response** Cals.
- ECal on one or more ports.
- TRL - [Learn how to do TRL cals](#)

◀ Programming Commands ▶

Note: SmartCal DOES allow you to measure calibration standards in any order. However, you must click **Next** and **Back** without measuring standards until you get to the standard you want to measure.

The following dialog boxes appear when performing a Guided calibration on standard channels.

Select Ports for Guided Calibration dialog box help

Allows you to select ports to calibrate.

Cal Type Selection Select the number of ports to calibrate.

N Port Cal Configuration If not calibrating all ports, specify which ports to calibrate.

Show Advanced Settings (Orientation & Thru Cal Section) Available only for **ECal**.

Back Return to **Cal Wizard Begin** dialog.

Select DUT Connectors and Cal Kits dialog box help

	Connectors	Cal Kits
DUT Port 1	APC 3.5 male	85052B
DUT Port 2	APC 3.5 male	85052B
DUT Port 3	APC 3.5 male	85052B
DUT Port 4	APC 3.5 female	85052B

Cal Method: 4-PORT, SOLT

Modify Cal
[Modify Cal] ENABLED. Press [Next] when ready.

< Back Next > Cancel Help

Allows you to select the connector type and Cal Kit for each DUT port to be calibrated.

Connectors To change selection, click the connector field for each DUT port.

If your DUT connectors are **not listed**, you can create your own connector type and calibration kit

file. The VNA includes the following example cal kits that can be used as a template. See [Calibration kits](#) for more information.

- If using a gendered (male and female) connector type, select **Type A** as the connector type.
- If using a connectorless device such as on-wafer probes., select **Type B** as the connector type.

Cal Kits Select the Cal Kit to be used to calibrate each test port. The list for each DUT Port displays kits having the same connector type as the DUT.

Identical ECal models connected? ECal modules can be distinguished by serial number. This can have implications on your remote [SCPI](#) programs.

Cal Kit Notes

85056K

The 85056K definitions in the analyzer are for 2.92mm standards (2.4mm plus 2.92 adapters). To calibrate 2.4 mm connectors using the 85056K cal kit, select 85056A as the cal kit when you need the sliding load. Otherwise, select 85056D as the cal kit. Both the 85056A and the 85056D kits contains exactly the same standards as the 85056K cal kit WITHOUT the adapters.

TRL

- To perform a [TRL Cal](#), assign a TRL Cal Kit to the lowest port number of each port pair.

Modify Cal Check, then click Next, to [Modify Cal](#) (Standards AND Thru Method).

Error dialog box help

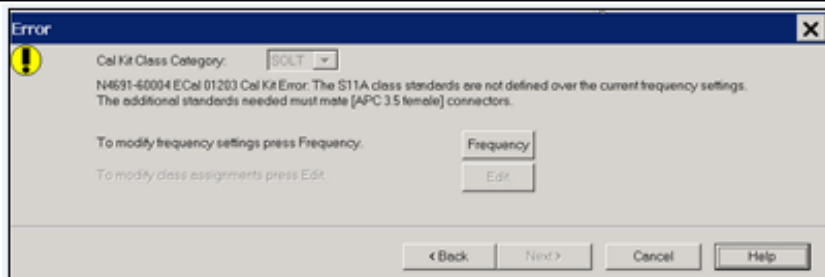

The current cal kit does not cover the current frequency range of the measurement. Do one of the following to correct the problem:

Cal Kit Class Category Choose from SOLT and TRL. Not available with ECal modules. Click **Edit** to modify the appropriate class assignments.

Frequency Change the frequency range of the active channel.

Edit Modify the class assignments so that a different standard is selected.

Back Select a different Cal Kit that covers the required frequency range.

Cancel Exit the Cal Wizard

Modify Cal dialog box help

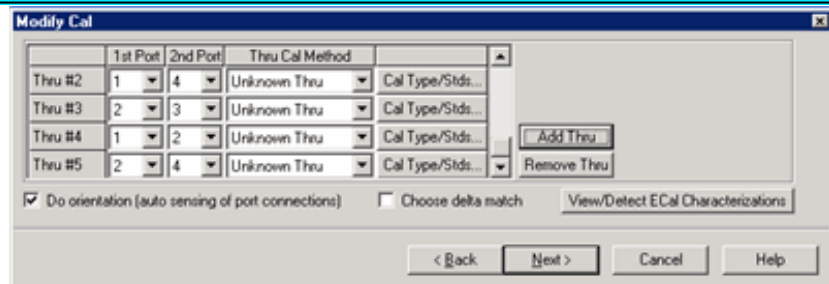

Thru #n

Lists the proposed Thru connections to be made during the calibration process. You can change these Thru connections to better suit your test setup.

- The proposed Thru connections are listed automatically.
- Additional Thru connections can be selected for higher accuracy. [Learn more.](#)

Add Thru

Click to add a Thru connection. [Learn more](#)

Remove Thru

Select a Thru by clicking the "Thru #N" field or the "1st Port / 2nd Port" field. Then click "Remove Thru". This selection is NOT available if the selected Thru is required for the calibration.

1st Port / 2nd Port

Click to select the two ports to be included in the Thru connection. The order of the port numbers is not critical.

Thru Cal Method

Lists the available Thru Cal methods for the specified port pairs.

[Learn about the Thru Cal Method choices.](#)

Cal Type/ Stds

Click to invoke the [View / Modify Properties of Cal dialog box](#)

Do orientation - Appears ONLY if an ECal module is selected for use.

When this box is checked (default) the analyzer automatically senses the model and direction in which an ECal module port is connected to the test ports. If power to the ECal module is too low, it will appear as if there is no ECal module connected. If you use low power and are having this problem, clear this check box to provide the orientation manually.

Orientation occurs first at the middle of the frequency range that you are calibrating. If a signal is not detected, it tries again at the lowest frequency in the range.

View/Detect ECal Characterizations - Appears ONLY if an ECal module is selected for use.

Click to invoke the [View ECal Modules and Characterizations](#) dialog box. Displays a list of connected ECal modules.

View/Modify Properties of Cal for Ports... dialog box help

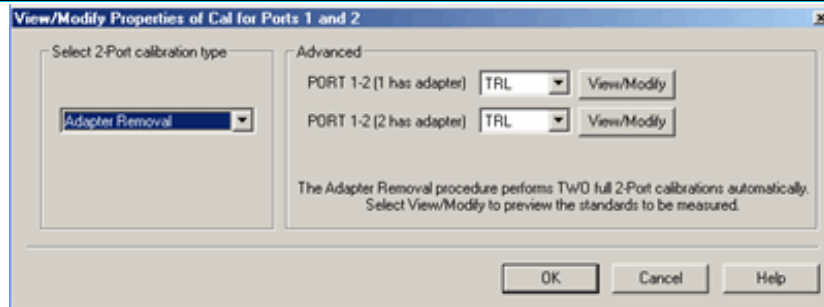

Select calibration type

Another chance to change the Thru method.

[Learn about the Thru Cal Method choices.](#)

Advanced

Select the cal method for each connector of the Thru pair.

- **TRL** - Available ONLY when a TRL cal kit was selected for the lowest port number of the port pair.
- **QSOLT** Available ONLY when "Defined Thru" or "Flush Thru" is selected. "**QSOLT 2 <= 1**" refers to the receive port 2 and source port 1 (where reflection standards are connected).
- **Enhanced Response** Available ONLY when "Defined Thru" or "Flush Thru" is selected. "**EnhResp 2 <= 1**" refers to the receive port 2 and source port 1.
- **Transmission Response** Available ONLY when "Defined Thru" or "Flush Thru" is selected, when Mechanical Cal is selected, and when 2 ports are being calibrated. "**TransResp 2 <= 1**" refers to the receive port 2 and source port 1.

View Modify Click to invoke the [Preview and Modify Calibration Selections](#) dialog box.

Note: Changes made to the Cal Kit through this dialog are **temporary** that last only for this calibration. To make permanent changes to the Cal Kit, perform [Advanced Modify Cal Kits](#).

Calibration Steps dialog box help

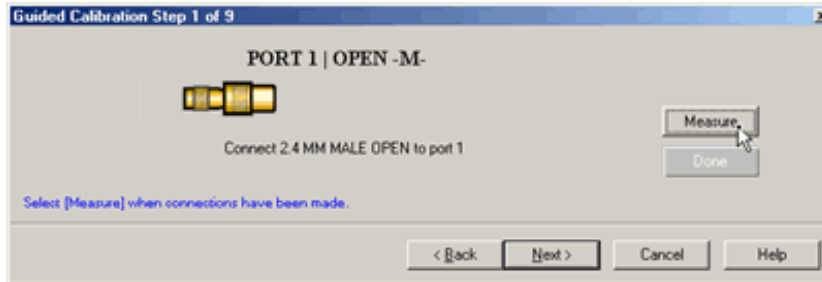

Note: Calibration can be performed with External triggers. [Learn more.](#)

As each new cal step prompt appears, the traces are setup for the next standard measurement. Also, sweeps are triggered continuously until the Measure button is pressed. This way you can view the integrity of the standard connection.

Prompts for standards to be measured.

Measure Click to measure the standard.

Done Click **after** a standard is re-measured and all measurements for the calibration are complete.

Next Click to continue to the next calibration step. Does **NOT** measure the standard.

If a standard is NOT measured, a warning appears and **Done** will not be available after the last Cal step.

Note: Smart (Guided) Cal allows you to measure calibration standards in any order. However, you must click **Next** and **Back** without measuring standards until you get to the standard you want to measure.

Sliding Load Measurement dialog box help

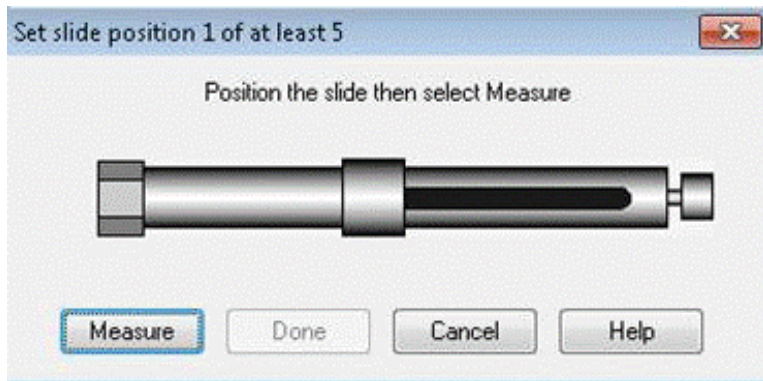

Allows you to measure the sliding load standard.

To Measure a Sliding Load:

1. Connect the sliding load to the measurement port following the procedure described in the Calibration Kit User's and Service Guide.

Note: Do NOT set the center conductor to be an interference fit with the center conductor of the testport.

2. Position the sliding element, then click **Measure**. Do not move the sliding element until measurement is complete.

Note: The direction in which the slide moves is NOT important. You can start with the slide at the front and move it backward or start at the back and move it forward. To minimize stability errors it is important to start at one end and move it in the same direction for each of the measurement steps.

3. Measure the sliding load for at least **five** positions for best accuracy.

Note: The positions of the sliding element should cover the full length of the slide, but be unequally spaced to reduce the possibility of overlapping data points. Most sliding loads have marks for each slide position.

4. Click **Done** after the final measurement.
5. Disengage sliding load lock (if available), and remove sliding load from the measurement port.
6. Measure the remaining standards.

How to Verify Sliding Load Calibration Measurements

Once the calibration is completed, the sliding load can be measured again. The magnitude of the return loss should remain nearly constant as the slide is moved. If the slide spacing was not adequate due to slide position selections, there will be frequency ranges where the magnitude will not remain nearly constant.

Specify delay dialog box help

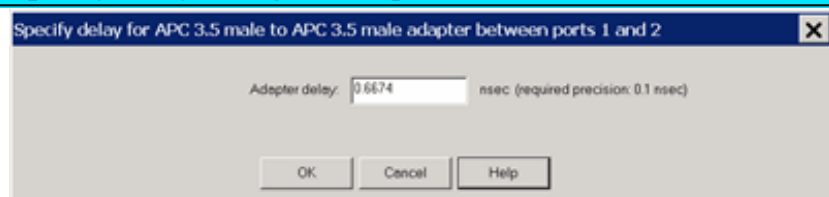

This dialog appears ONLY when **Adapter Removal** or **Unknown Thru** calibrations are performed.

The following values were estimated from the measurement. Most of the time, they are adequate. However, for CW sweep or frequency sweep with large step sizes, the accuracy of the values may be improved.

Adapter delay To improve this value, measure and record the delay of the adapter with a dense step size. Enter that value here. The required precision value is the accuracy that is required to characterize the delay value.

Nominal phase offset (Waveguide ONLY). To improve this value, measure and record the phase offset of the Waveguide adapter with dense step size. Enter that value here.

When one connector is coax and the other connector is waveguide, the phase offset has an ambiguity of 180 degrees. For consistency, the estimate provided here is always between 0 and 180 degrees. You can change this estimate to any value between -180 degrees and +180 degrees.

The **Calibration Complete** dialog box appears after all standards are measured.

Basic Calibration

Basic Calibration

Using **Hardkey/SoftTab/Softkey**

1. Press **Cal** > **Main** > **Basic Cal....**

Programming Commands

It provides basic calibration. The limitations of basic calibration are:

- one connector type
- one cal kit
- one cal type
- no isolation cal
- no power calibration

Basic Cal dialog box help

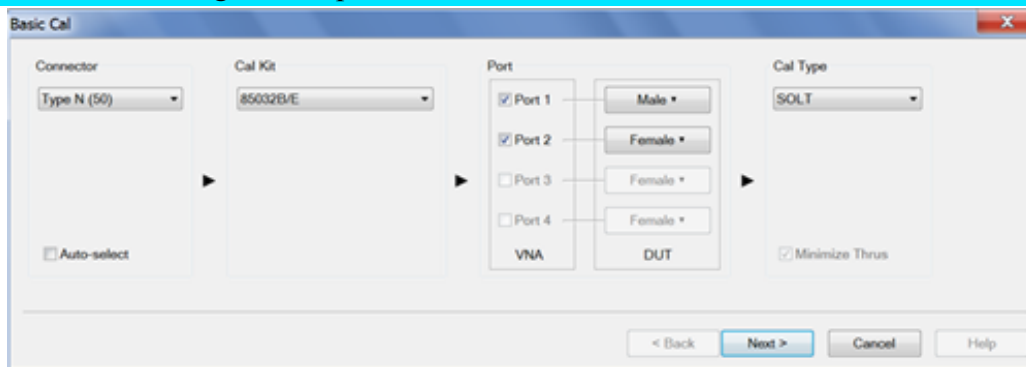

Connector Type Allows user to select single connector type.

Cal Kit Allows users to select single Cal Kit. The displayed selection options are according to the selected connector type.

Port Allows users to select the port gender. *No Connect* indicates that no port is connected to the VNA.

Cal Type Allows users to select calibration type. The displayed selection options are according to the selected cal kit, connector type and gender.

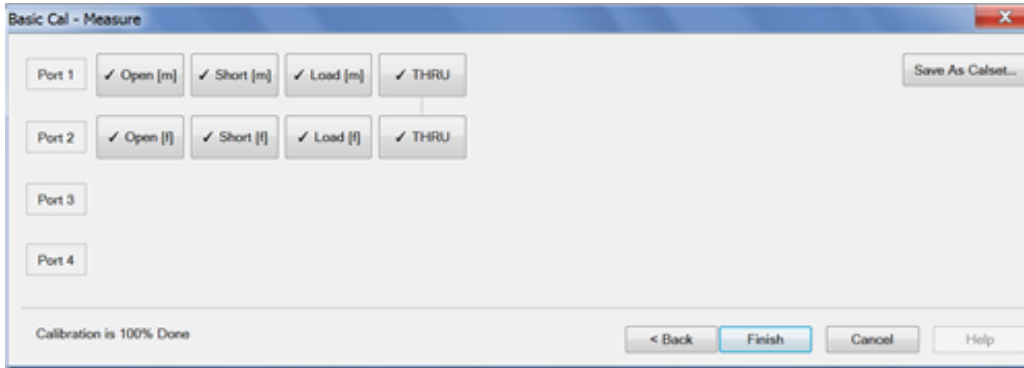

Save As Calset... Its grayed out when calibration is incomplete. Once the calibration is completed, press this button to save the calibration.

Unguided Calibration

Unguided Calibration

Using **Hardkey/SoftTab/Softkey**

1. Press **Cal > Main > Other Cals > Response Cal....**

◀ **Programming Commands** ▶

The following dialog boxes appear when performing an Unguided calibration:

Select Calibration Type for Mechanical Standards dialog box help

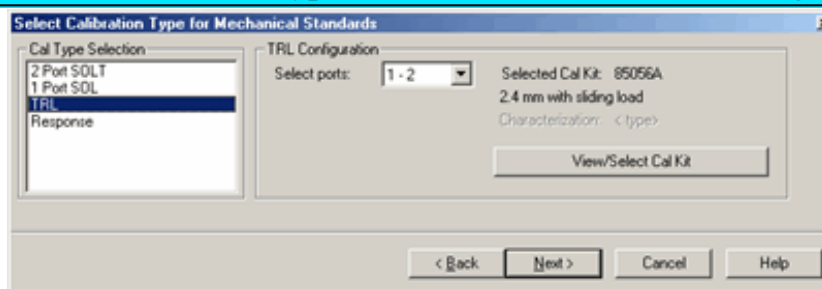

Unguided calibration does **NOT** support cals greater than 2 ports or **ECal** calibrations.

Calibration Type Selection

- **2-Port SOLT**

- **1-Port SOL**
- **TRL** - [Learn more about TRL](#)
- **Response** - Reflection and Thru (if the active measurement is transmission)

Cal Configuration If not calibrating all test ports, specify which ports to calibrate.

Back Return to [Cal Wizard Begin](#) dialog.

View/Select Cal Kit Click to invoke the [Select Cal Kit dialog box](#).

Note: When selecting a Cal Kit with an impedance other than 50 ohms (Waveguide = 1 ohm), it is **NO LONGER NECESSARY** to change the [System Impedance](#) setting before performing a calibration. The impedance for the calibration is now derived from the Cal Kit impedance.

Next Click to continue to [Measure Mechanical Standards](#) dialog box.

Select Cal Type dialog box help

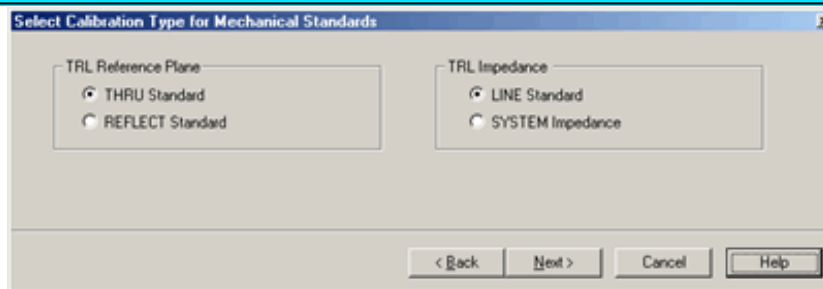

This dialog box appears **ONLY** when the selected Cal Type is TRL in the previous dialog box.

TRL Reference Plane Select which standard to use to establish the position of the measurement reference plane.

THRU Standard Select if the THRU standard is zero-length or very short.

REFLECT Standard Select if the THRU standard is not appropriate **AND** the delay of the REFLECT standard is well defined.

TRL Impedance

LINE Standard Specifies that the characteristic impedance of the LINE standard should be used as the system impedance. This ignores any difference between Offset Z0, Offset Loss, and System Z0.

SYSTEM Impedance Transforms the LINE standard impedance and loss to that of the system

impedance for use with the calibration error terms. The TRL calibration will first compute the error terms assuming the LINE standard impedance is the system's characteristic impedance (same as previous LINE selection), then modify the error terms to include the impedance transformation. This should only be used with coax since the skin effect model used is a coaxial model.

[Learn how to change System Z0.](#)

To learn to substitute other calibration kits, see [Advanced Modify Cal Kits](#)

Select Cal Kit dialog box help

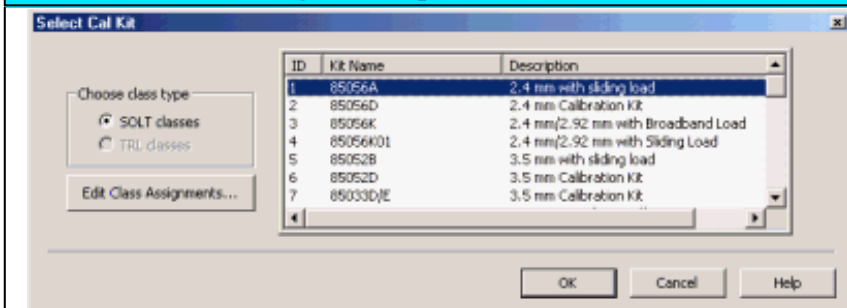

Displays the calibration kit files available for Unguided calibration. Select the desired calibration kit file and click **OK**.

Choose class type

Edit Class Assignments Allows modification of the selected Cal Kit class assignments.

- To learn to substitute other calibration kits, see [Advanced Modify Cal Kits](#)
- Unguided Cal can access only mechanical cal kits #1 through #95, although more cal kits can imported. [Learn how.](#)

Note: When selecting a Cal Kit with an impedance other than 50 ohms (Waveguide = 1 ohm), it is **NO LONGER NECESSARY** to change the [System Impedance](#) setting before performing a calibration. The impedance for the calibration is now derived from the Cal Kit impedance.

Measure Mechanical Standards dialog box help

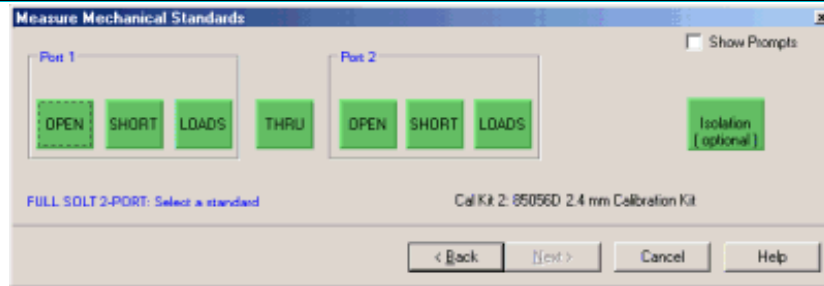

Note: Calibration can be performed with External triggers. [Learn more.](#)

Displays the calibration kit file and standards required for the calibration.

- Standards may be connected and measured in any order.
- Connect the standard to the measurement port and click its associated green button. A check mark indicates the standard has been measured.
- If a standard type contains multiple standards, the [Multiple Standards dialog box](#) opens to display the multiple standards included in the calibration kit file.
- If a sliding load is included in the calibration kit file, the [Sliding Load dialog box](#) opens to perform the measurement with the standard.
- **Reflection Response** Select EITHER Open or Short standard, then click **Next**.
- **Isolation** Requires one load for each test port. [Learn more about Isolation.](#) Use when your measurement requires maximum dynamic range (> 90 dB). See also [Isolation Portion of 2-Port Calibration.](#)
- **Normalize** Available when performing a response cal for any measurement. After Normalize is pressed and the Cal is complete, the data trace is flat when the same physical connections are present on the port. This is similar to [Data/Memory](#), except that the response cal is [saved with Cal data](#) and can be applied to other like measurements. Data/Memory is still available after using Normalize. You would usually connect a THRU standard when calibrating a transmission measurement, and a SHORT standard when calibrating a reflection measurement.

Show Prompts Check to provide a reminder for the required connection when you click on the standard.

Multiple Standards dialog box help

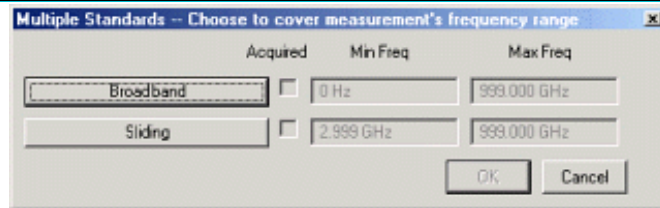

Select the standards to be measured.

Note: You may see both male and female standards. The Unguided cal has no knowledge of the gender of your connector types. **Choose the gender of your DUT connector**; NOT the test port. Then click OK.

To modify this calibration class to show only one standard, on the Calibration menu, click **Advanced Modify Cal Kits**. Select the Cal kit and click **Edit Kit**. In **Class Assignment**, click **Edit**. Learn more about [Modify Calibration Class Assignments](#).

- Connect the standard to the measurement port and click its associated button. A check mark in the **Acquired** box indicates the standard has been measured.
- To cover the entire frequency range, you may need to measure more than one standard. The order in which the standards are measured is important. The last standard that is measured will override the others in respect to the frequency range of the standard definition. **Example:** In the case of measuring both a broadband load and a sliding load, you would measure the sliding load last. This is because the frequency range of the sliding load is a subset of the broadband load.

Saving a Calibration

SmartCal, ECal, and Unguided Calibrations end with the following dialog box:

Calibration Completed dialog box help

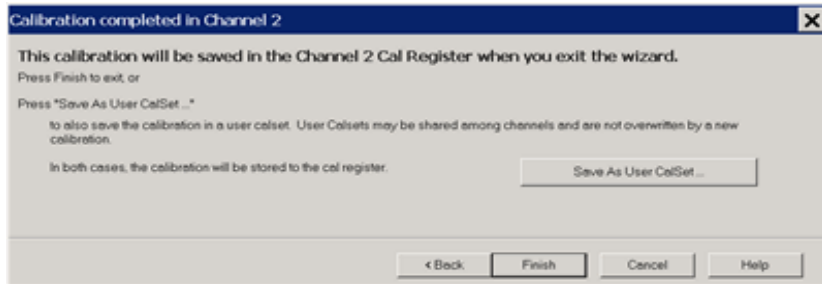

Finish Save to the channel's calibration register.

Save As User Cal Set Invokes the [Save as User Cal Set dialog box](#) AND save to the channel's calibration register.

Cancel Calibration is NOT applied or saved.

Learn about [Calibration Registers](#).

Learn about [User Cal Sets](#)

Copy Cal Set dialog box help

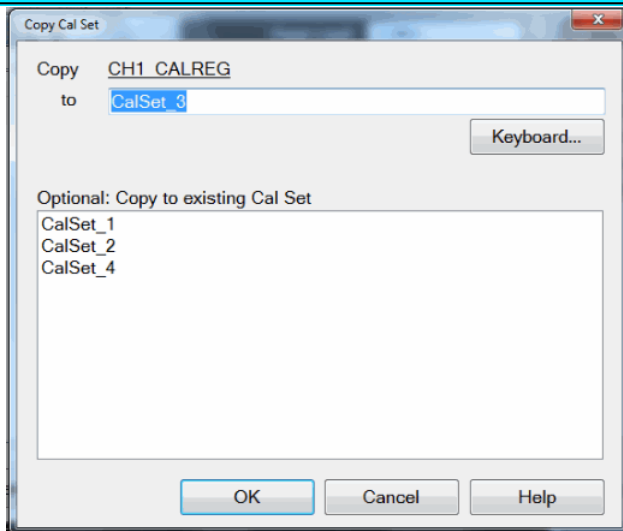

Existing Cal Sets - Lists the previously-saved Cal Set names.

to Specify a name for the new Cal Set. Either accept the suggested new name, type a new name, or select a name from the list to overwrite an existing name.

OK Saves the Cal Set to the new Cal Set name and exit the dialog message.

Guided Power Calibration

Source and Receiver Power Calibration can be performed during a standard S-parameter Guided Calibration. This power cal provides the following enhancements over the standard source and receiver power calibration:

- A source and receiver power cal can be performed for all PNA ports with a single power sensor connection.
- **Multiple power sensors** can be used to cover wide frequency ranges.
- The receivers are corrected automatically.
- Optionally compensates for an adapter that may be used to connect the power sensor.
- Provides **optional match-corrected power measurements**.
- Source and Receiver power correction is stored to the Cal Set along with S-parameter correction.

Note: A Guided Power Calibration is not accurate when **Frequency Offset Mode** is enabled.

Learn more about the standard **Source** and **Receiver** Power Cals.

How to perform a Guided Power Cal

1. In a **Standard (S-parameter)** channel, setup your measurements (sweep type, frequency range, IFBW, and so forth). A special version of this feature is available on mmWave SMC measurements. [Learn more](#).
2. Connect the Power Meter / Sensor the same as a standard Source Power Cal. [Learn more](#).
 - See [Supported Power Meters](#)
 - See Important first-time USB connection note.
3. Start the **Cal Wizard**, then select **Guided (Smart) Cal**. [Learn how](#).

[Programming Commands](#)

On the following **Select Ports** dialog, check **Calibrate source and receiver power**, then click **Next**.

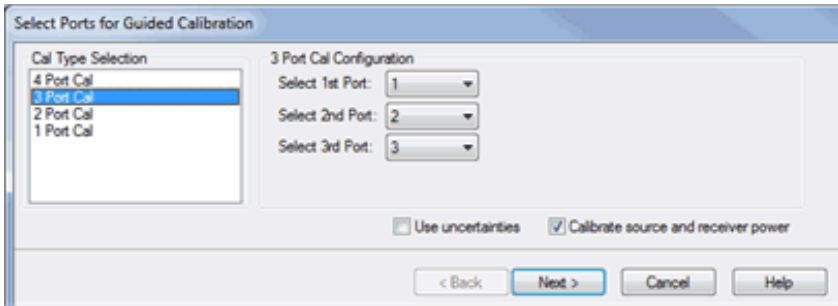

Two Cal Wizard pages later, complete the following dialog.

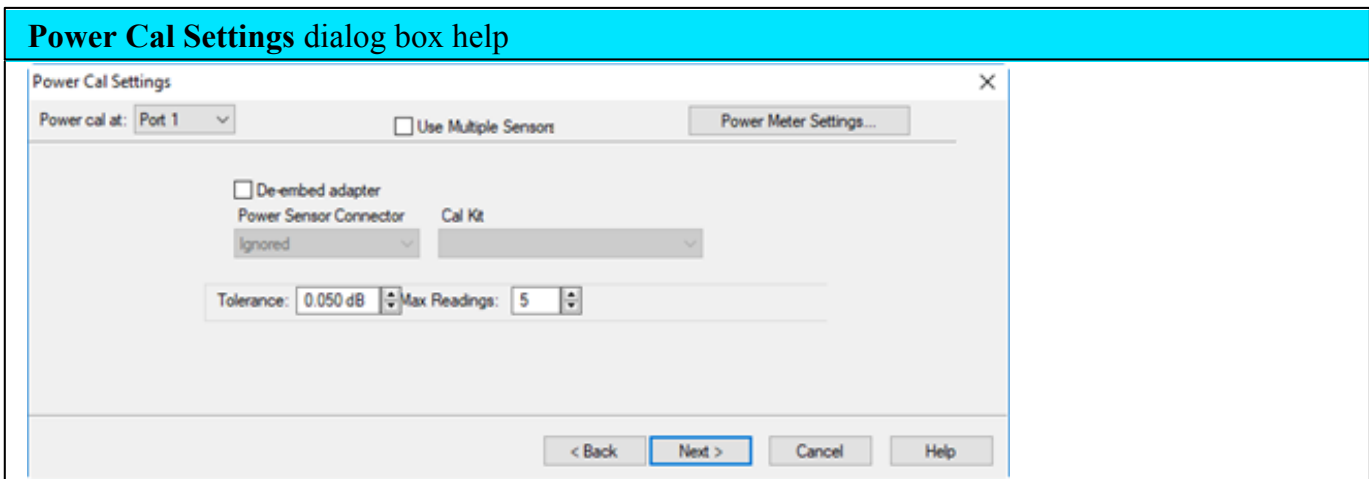

Note: A **Use Power Table** checkbox (not shown) is available when a mmWave SMC measurement is active. Learn more.

Power Cal at: Select the source port for which a Power Calibration will be performed. The source and receiver correction will be transferred to all other sources and receivers involved in the S-parameter measurements.

Use Multiple Sensors NOT available with SMC measurements.

Check this box to use one or more power sensors that are **configured as PMAR devices**. This dialog is replaced with the **Multiple Sensors** dialog. See following image.

When "Use Multiple Sensors" is cleared (default setting), click **Power Meter Settings** to configure the power meter.

De-embed (power sensor) adapter When the power sensor connector is NOT the same type and gender as the DUT connector for the specified port, then for optimum accuracy, extra cal steps are required to measure and correct for the adapter that is used to connect the power sensor to the reference plane.

Clear this box to NOT compensate for the added adapter.

Check this box to perform extra calibration steps to measure and correct for the adapter.

Then select the **Power Sensor Connector** type and gender of the power sensor. "Ignored" does NOT compensate for the added adapter, just as if the checkbox were cleared.

When this connector matches the DUT connector for the same port, then the PNA assumes that there is no adapter. Extra cal steps are NOT required and the Cal Kit selection is not available.

Otherwise, select the **Cal Kit** to be used to calibrate at the adapter.

See [Accuracy Settings](#) below.

Power Cal Settings - Use Multiple Sensors dialog box help

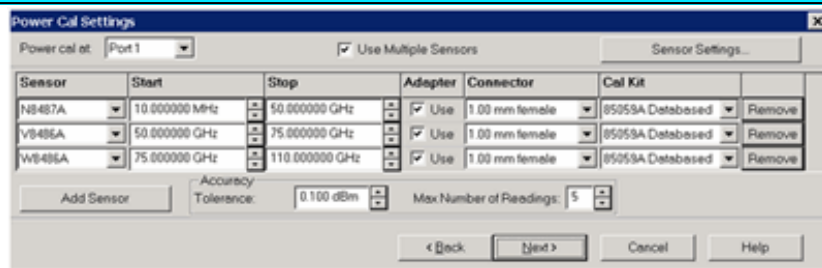

Notes

"Multiple sensors" are allowed ONLY on standard channels and during a **Cal All calibration**.

The power sensors that are used as "multiple sensors" MUST be configured **PMAR devices**.

Power Cal at: Select the source port for which a Power Calibration will be performed. The source and receiver correction will be transferred to all other sources and receivers involved in the S-parameter measurements.

Sensor Settings Click to start the Sensor Settings dialog, used to **ADD / Configure an External Device**.

Sensor Grid

Sensor Select the power sensor and the associated **Start** and **Stop** frequency range.

Adapter When the power sensor connector is NOT the same type and gender as the DUT connector for the specified port, then for optimum accuracy, extra cal steps are required to measure and correct for the adapter that is used to connect the power sensor to the reference

plane.

Clear this box to NOT compensate for the added adapter.

Check this box to perform extra calibration steps to measure and correct for the adapter. Then specify the **Power Sensor Connector** type and gender of the power sensor. When this connector matches the DUT connector for the same port, then extra cal steps are NOT required, and the Cal Kit selection is not available. Otherwise, select the **Cal Kit** to be used to calibrate at the adapter.

Remove Click to remove the power sensor from the list.

Add Sensor Click to add a new line, then click the down-arrow to select a sensor. If a power sensor does NOT appear in the list, click the **Sensor Settings** button to configure a power sensor.

Accuracy

Tolerance When consecutive power sensor readings are within this value of each other, then the reading is considered settled.

Max Readings Sets the maximum number of readings the power sensor will take to achieve settling. Each power reading is "settled" when either:

- Two consecutive readings are within this **Tolerance** value or
- When the **Max Number of Readings** has been met.

The readings that were taken are averaged together to become the "settled" reading.

Set Power For Best Accuracy Select to use the power level associated with the best uncertainty for a specific power meter.

Programming Commands

Power Sensor Connection step dialog box help



Power Level Set the power level at which the Source Power Cal is to be performed.

It is usually best to perform the Source Power Cal at 0 dBm because the power sensor is calibrated at that level. If 0 dBm is not achievable for your measurement, then set to the power level with the lowest level of measurement noise.

Turn OFF Match Correction

During a Guided Power Cal, the match between the power sensor and the VNA source port is measured. The source power correction array is compensated to account for the measured mismatch. In addition, the reference receiver measurement is also compensated to account for the mismatch of the DUT.

How to turn OFF match correction:

Click **Cal** > **Main** > **Correction Methods**....

Correction Methods dialog box help

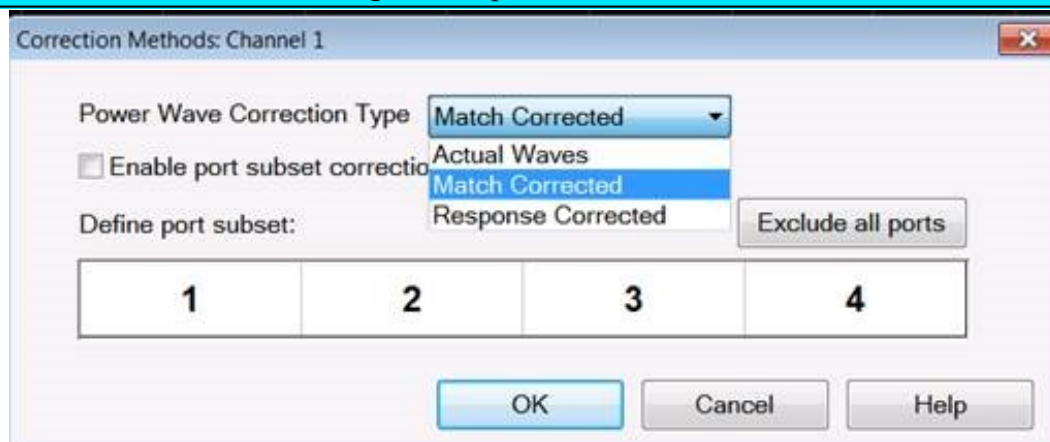

Power Wave Correction Type

Match Corrected - Guided Power Cal applies match correction on all receivers used on this channel. However, you may not want match correction in the following cases:

- When making non-traditional measurements, such as high-power or multipoint configurations. Because of

added components or reconfigurations, the mismatch measurement may not be valid.

- When you have a remote program that already accounts for the match effects of the sensor.

Actual Waves - These are the full error corrected actual waves at device reference planes.

Response Corrected - These are response corrected waves.

Port subset correction

Refer to [Port Subset Correction \(Devolve Calibration\)](#).

Calibrate All Channels

"Cal All" allows you to calibrate multiple channels in a single calibration session. This not only reduces the number of connections that need to be made, but also the number of cal standard measurements that must be performed.

Note: Beginning with the A.12.80 release, Cal All has been extended in order to deal with the new Low Frequency Extension option. If a user has a mixture of LFE and non-LFE channels and they would like to use Calibrate All to calibrate them at the same time, two calibration channels are created to account for the hardware differences between the two situations. When using the GUI or COM to set calibration and stimulus conditions, the settings are applied to both calibration channels. With SCPI, the user can query the primary guided calibration channel using `SYST:CAL:ALL:GUID:CHAN:VAL?`. This will return the primary calibration channel. When subsequent Guided Cal commands are used, settings will be transferred to the second calibration channel. If there is a desire to set these settings separately, the user should query for all Cal All Calibration channels with `SYST:CAL:ALL:GUID:CHAN:LIST?`. The user should set values for the primary calibration first, and then secondary calibrations. When initializing the calibration and acquiring steps, use the primary cal all channel number.

In this topic:

- Features
- Limitations
- How to perform a Cal All Channels Calibration
 - Select Channels dialog
 - Measurement Class Cal Properties dialog
 - Setting Up an Independent Power Calibration
 - Calibration Attenuator Settings dialog
 - Select DUT Connectors and Cal Kits dialog
 - Power Cal Settings dialog
 - Cal Steps dialog
 - Finish

Other Cal Topics

Features

Cal All offers a single, optimized calibration procedure for all channels (with some limitations, see below). The optimizations include:

- Minimizing the number of physical connection of standards.
- Minimizing the number of power meter calibration sweeps.
- User-settable power levels for S-Parameter as well as power calibration steps.
- Accounting for different switch and attenuator settings among different channels. This reduces the number of measurements required to characterize different switch/attenuator settings (channel setup differences).
- Cal All will produce the same number and format of Cal Sets (error terms) that would be realized had the calibrations been performed one at a time.
- Calibrate External Sources that are connected to the analyzer using Configure an External Source .

Limitations

- Cal All is performed at one IFBW.
- All channels that are calibrated are forced into stepped sweep mode .
- All channels to be calibrated MUST have the same cal reference plane . In other words, Cal All cannot compensate for any path changes that occur external to the analyzer.

How to perform a Cal All Channels Calibration

Using **Hardkey** / **SoftTab** / **Softkey**

1. Press **Cal** > **Other Cals** > **Cal All...** .

Programming Commands

Selected Channels dialog box help

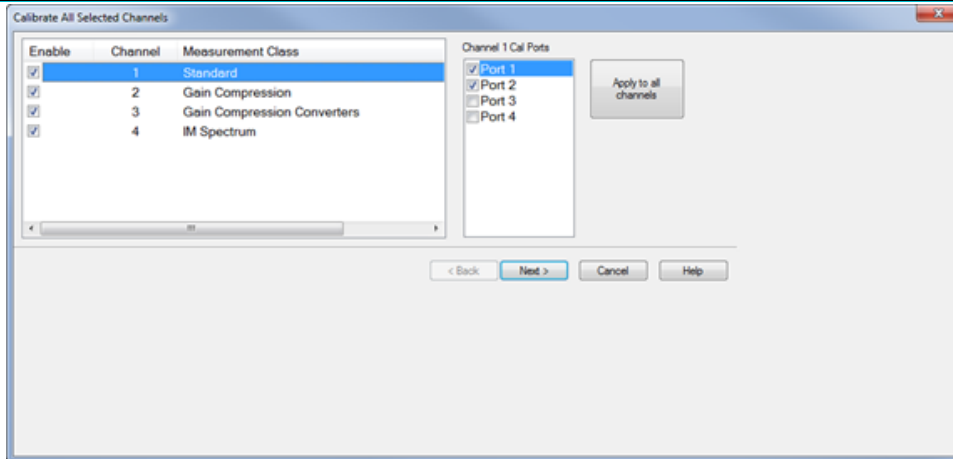

1. Check the channels to be calibrated.
2. Check the ports to be calibrated. Click on the **Apply to all channels** button to apply the port selections to all channels.
3. Click **Next>**

Note: In M9485A, Only ports 1 to 4 can be set even if your unit has more than 4-port configuration.

Measurement Class Cal Properties dialog box help

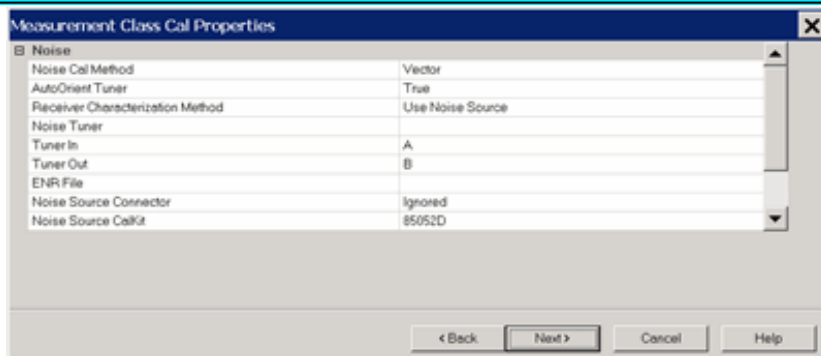

Confirm or change the following unique cal properties for each channel to be calibrated. Click a link to learn about these properties.

The properties with **(NOT available in Cal All)** are NOT available in a Cal All calibration as they are in a stand-alone calibration.

SMC

Mixer Delay	"Mixer Delay"	Real number indicating delay value.
Receiver Characterization Cal Set	"Calset"	String of Cal Set Name
Characterized mixer (s2p file) (NOT available in Cal All)		

Standard Channel

Programming		
UI Setting	Property	Value
Include Power Calibration	"Include Power Calibration"	"true" or "false"
	"Enable Extra Power Cals"	"Port 1", "Port 2", "Port 3", "Port 4", and/or "Port 1 Src2"
	"Port 1 Src2 Cal Power"	Integer indicating valid calibration power. For example, "-20" indicates a power level of -20 dBm. Only valid if an independent port calibration on Port 1 Src2 is selected.

The power cal is optional only if none of the selected channels require a power cal.

Setting Up an Independent Power Calibration

Independent Power Calibration

Several applications control internal and external sources in a mode that is often decoupled from the span over which the receivers are swept. This includes, for instance, Differential IQ, and Spectrum Analyzer. Cal All can add a power calibration for any port (including external sources) over an arbitrary frequency span defined by the user.

For all ports selected for an independent power calibration (except for Port 1 Src 2, see below), a power sensor calibration measurement is performed. The resulting source match correction terms are added to the calsets for ALL channels selected for the Cal All calibration. The power calibrations used in Cal All have all the same features as typical power calibrations. These include the ability to specify power offsets, the power at which the calibration is completed, and the ability to use multiple power sensors (note that using multiple power sensors is a feature only available on

regular PNA ports – that is, not external sources or auxiliary ports).

Port 1 Src2 Calibration

The Port 1 Src2 calibration is a special case: In this case, a calibration is requested for situations where the Port 1 Bypass Switch is in “Combiner Path” mode and either the “Port 3 Bypass Switch” (4-port PNA-X) or the “Source 2 out 1 Bypass Switch” (2-port 2-source PNA-X) is also in “Combiner Path”. Therefore, if a user requests a calibration of this port:

1. Port 1 will also be calibrated at the same frequencies in the combiner path (*note: The user can still elect to add more Port 1 independent cal ranges, but this will be done in “Bypass” mode, not “Combiner mode.”)
2. The calibrations for both Port 1 and Port 1 Src2 will be done with both sources on, but offset by 10MHz (to more accurately characterize the behavior during use).
3. These calibrations will ONLY be applied to user channels in which both the Port 1 Bypass Switch and either the Port 3 or Source 2 Out 1 Bypass Switches are set to “Combiner Path.”

Important Notes:

- If a user selects an independent power calibration on a port also used for the typical S-parameter calibration, then the frequencies calibrated will be *in addition* to those frequencies used via the typical calibration (a separate measurement will be completed at the time).
- Previously a user could select a similar calibration of “LO” ports for application channels (for instance, in a GCX measurement with Port 3 used for LO1, a user can select (via GUI or remote) to do an “LO1” calibration. This will do a power sensor calibration of LO1 (port 3) at the frequencies specified by the channel. This is still available, but if the user selects to do an Independent Power Calibration instead, this will override the selection by the channel.
- If the user has a mixture of LFE (Low Frequency Extension) and non-LFE channels the calibration will be done by default in the NON-LFE configuration (this is because most applications do not support LFE and external sources and sources like Src2 Out 1 do not have LFE paths). Instead, if it's desired to do these calibrations in LFE mode, the user must select *only* LFE channels over which to do the cal all calibration.

Independent Power Calibration for Cal All Setup

1. Start the **Cal All Wizard** .
2. In the **Measurement Class Cal Properties** dialog, enable Independent Power Calibration by selecting the port(s) to cal then clicking **OK** .

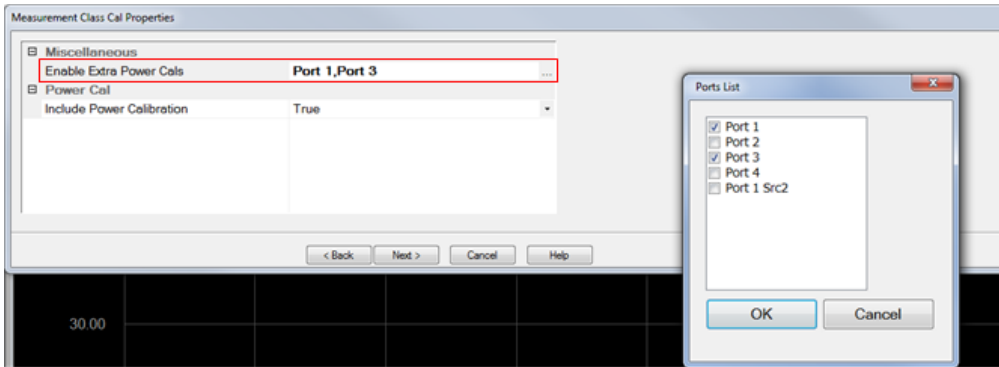

3. If **Port 1 Src2** is a selected port, the **Port 1 Src2 Cal Power** level is displayed allowing a calibration power level to be entered.

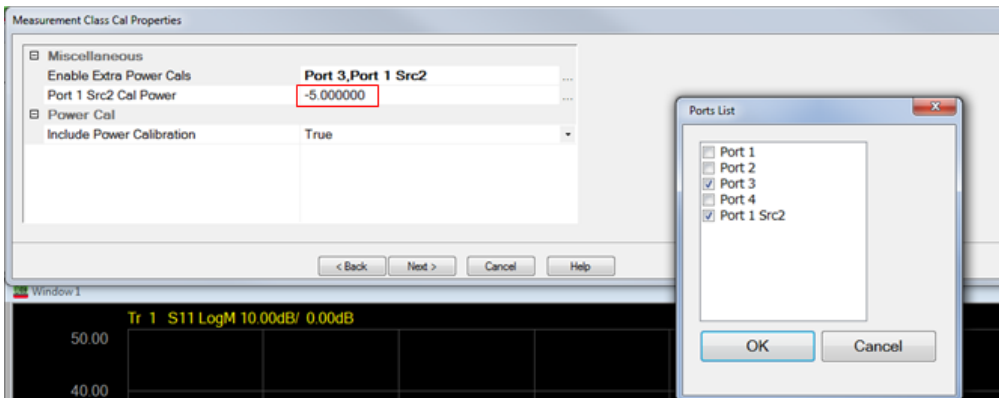

4. To enter the **Port 1 Src2 Cal Power** level, click in the field then enter a valid calibration power level.

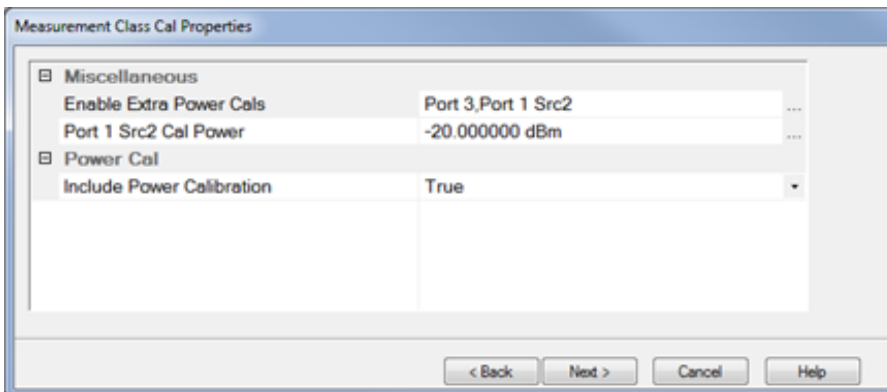

5. In the **Power Cal Settings for Port<n>** dialog, select the port from the **Power cal at** dropdown.
6. To add a new Cal range, click the **New** button.
7. Specify a frequency range for each **Range Name** by clicking in the corresponding **Settings** field then clicking on the **Edit** button that appears.

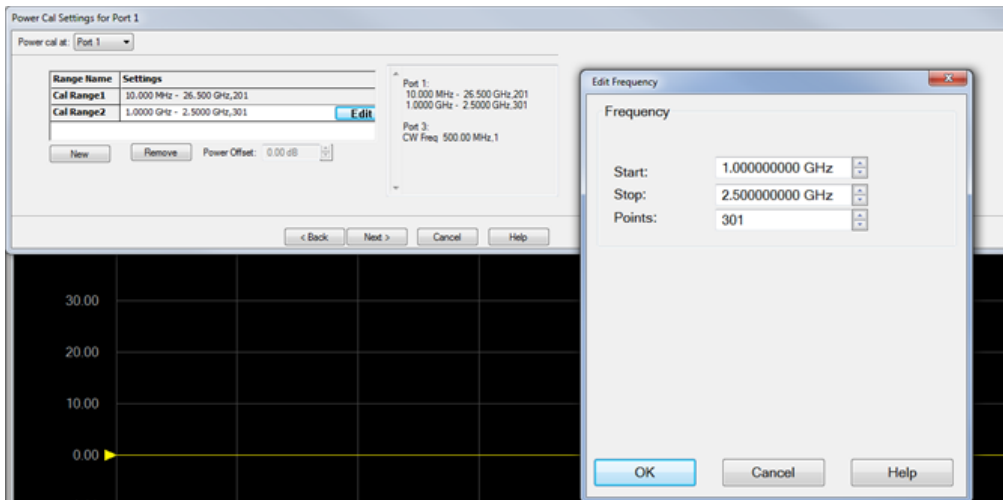

8. Enter the **Start** and **Stop** frequency and the number of **Points** then click **OK** .
9. Continue the Cal All process by clicking on the **Next** button.

Calibration Attenuator Settings dialog box help

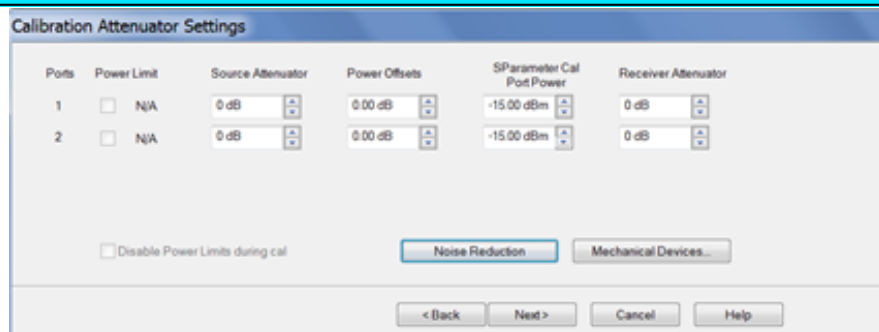

This dialog shows the Power, Attenuator, and IFBW settings for the Cal All calibration. The default values for the Cal All session are the preset values of a standard S-parameter channel. These values are not necessarily the same as those of the channels that are selected for calibration. When there are differences in measurement path (switch) settings between the Cal All channel and the selected channels, these differences are detected by Cal All and additional measurements are made for each path condition. These additional measurements allow Cal All to produce error terms appropriate for each of the selected channels. In general, the Cal All session should be performed at a power level that is high enough to prevent noise in the error terms. However, an increase in power could cause compression or damage to the analyzer receivers. The following settings allow you to increase the power level **ONLY** during the Cal All session.

Power Limit (Disable)

Cal All shows you when power limits are enabled. This setting provides you a convenient way to **TEMPORARILY** disable these limits in order to take advantage of the power settings available in

Cal All. If power limits are on, your DUT is probably a high-gain device and the attenuator settings in your channels are high resulting in lower power at the cal reference plane. This lower signal can result in noisier measurements during the acquisition of cal. This situation is precisely what Cal All is intended to improve. Cal All allows you to configure the calibration conditions for better signal-to-noise performance during the cal while leaving your DUT conditions alone. You can elect to clear the “Disable Power Limits during cal” checkbox when you prefer to calibrate at a higher power level than is allowed by your limit. The limit is restored after the Cal All session.

Source / Receiver Attenuator

By default, the Cal All calibration is performed with Source and Receiver attenuators set to 0. Change the Source or Receiver attenuator settings when external hardware (such as a booster amplifier) would cause the analyzer receivers to be compressed or damaged.

You may also want to change the attenuator or path configuration settings to force the cal channel to match settings of the selected channels. If all of the selected channels are set to identical hardware settings, it may be better to apply these settings to the cal channel. For example, if your channels all use a 5 or 10 dB attenuator step at port 1, you might elect to change the Cal All channel to use the same low attenuator settings. This will result in the cal measurements being made under the same path conditions as the channel and it will eliminate the need to mathematically compensate for the difference. However, if large attenuator values are used, the default Cal All settings will likely improve your results.

S-Parameter Cal Port Power

Set the power level at which the S-Parameter cal is performed.

Power Offsets

Power Offsets are channel-scoped. Consequently, offsets that you already set are NOT automatically copied to the Cal All session. This setting allows you to also apply a Power Offset during the Cal All session. Learn about Power Offsets .

Noise Reduction

This button accesses the following dialog for settings that help reduce trace noise and the noise floor which can lead to better dynamic range and more accurate measurements. Learn more .

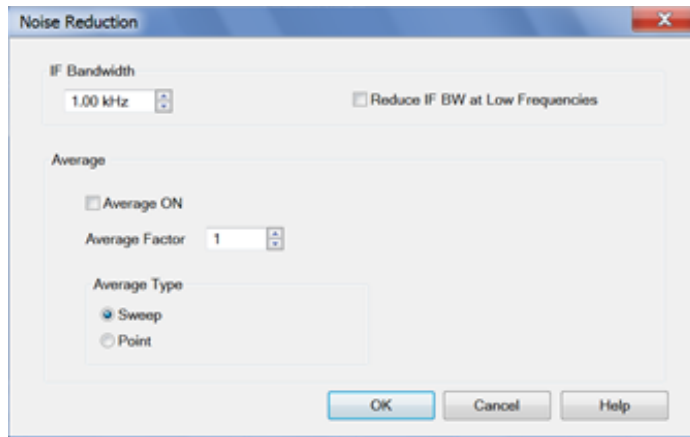

IF Bandwidth

Set the IFBW used to perform the Cal All calibration. The default IFBW setting of 1 kHz is a good nominal setting for most measurements. Lowering the IFBW removes noise from the calibration measurement, but also causes slower sweeps.

Always ON

Check to enable averaging.

Average Factor

Specifies the number of measurements that are averaged. Range of 1 to 65536 (2^{16}).

Average Type

Sweep Each data point is based on the average of the same data point measured over consecutive sweeps.

(Sweep) Restart Begins a new set of measurements that are used for the average. Applies only to Sweep averaging - NOT Point.

Point Each data point is measured the number of times specified by the Average Factor, and then averaged, before going to the next data point.

Reduce IF BW at Low Frequencies

When this box is checked, the VNA uses a smaller IF Bandwidth than the selected value. [Learn more](#) .

Select DUT Connectors and Cal Kits dialog box help

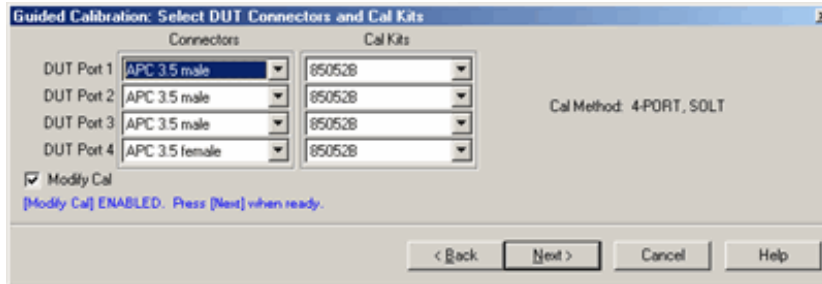

For each DUT port:

- Select the connector at the calibration reference plane (where the cal standards will be connected).
- Select the cal kit to be used.

Check **Modify Cal** to change the Thru method. An Unknown Thru cal is performed by default. Learn about THRU methods .

Learn more about this dialog .

Power Cal Settings dialog box help



A guided power cal is performed on the source ports for the Cal All calibration.

This dialog is displayed for each source port to receive a power cal.

To perform an LO power cal for a mixer channel, set the LO port to a VNA or external source in the Mixer Setup dialog . Then select that port in the Selected Channels dialog .

- To use the **same** power sensor for all power cals, do **NOT** check Use Multiple Sensors.
- To use **different** power sensors, check **Use Multiple Sensors** . The sensor must be configured as a PMAR device. Learn how .

Learn about this dialog box .

Cal All Summary dialog box help

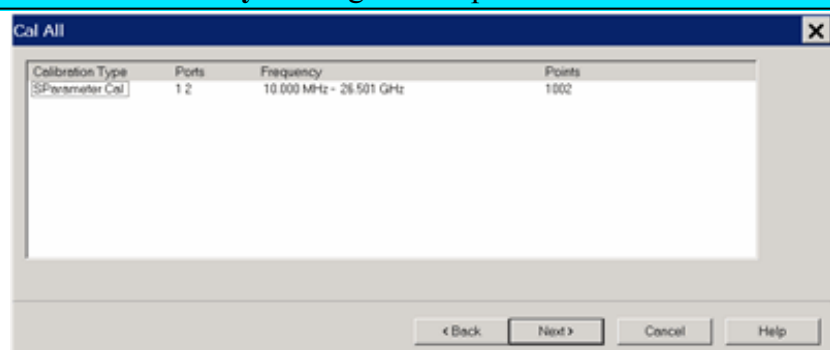

This page is a summary of the Cal All settings. Confirm the settings, then click **Next >** or **< Back** to change settings.

Cal Steps dialog box help

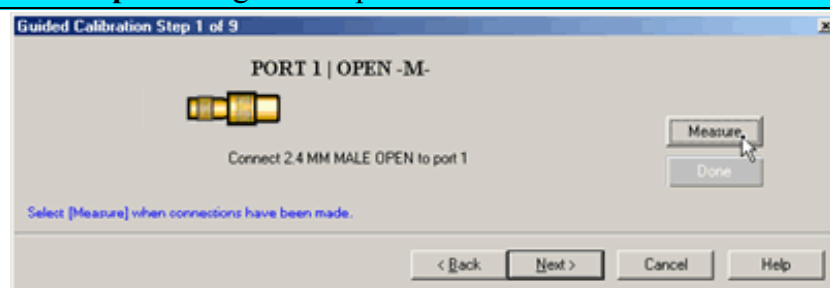

Follow the prompts to connect each standard. Then click **Measure** .

Click **Re-measure** if necessary.

Then click **Next >**

Finish Cal dialog box help

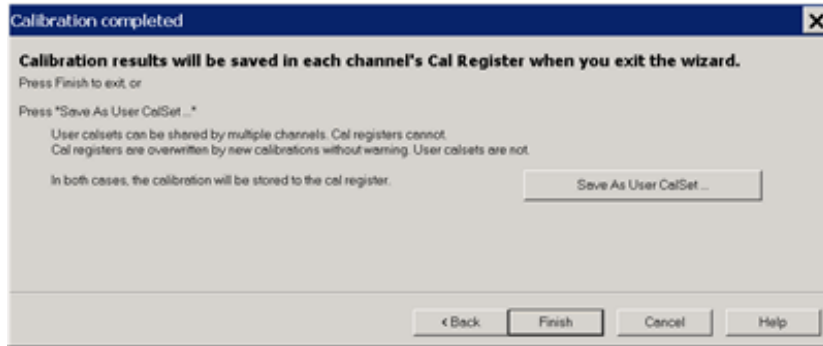

Click **Finish** to save the Cal All session results to Cal Registers.

Or click **Save As User CalSet** , then enter a prefix title. The Meas Class and channel number are appended to this prefix to save to a User Cal Set for each calibrated channel.

Learn more about this dialog.

Using Calibration Sets

- [What are Cal Sets](#)
- [Cal Registers and User Cal Sets](#)
- [How to Manage and Apply Cal Sets](#)
 - [Cal Set Selection dialog box help](#)
 - [Cal Set Properties dialog box help](#)
 - [Select Cal Set -- Choose Stimulus Settings dialog box help](#)
- [Examples of Cal Set Usage](#)
- [Archiving Cal Sets using .cal files](#)

See Also

Save and Recall: [Instrument States and Cal Set Data](#)

[See other Calibration Topics](#)

What are Cal Sets

At the completion of a calibration, all calibration data is stored to a Cal Set. The Cal Set can be applied later to any channel that has the same stimulus settings as the Cal Set, thereby saving the time it takes to perform another calibration. The following data is saved to a Cal Set:

- Name
- Cal Set Description
- Cal Set Attributes - stimulus settings, cal type, port association
- Standards data - *The "Standards data" container in the Cal Set is intended for internal use only. External access is provided for use in diagnosing calibration problems. Users should not form any expectations as to the presence of the data or the naming conventions used.*
- Error term data
- GUID (**G**lobally **U**nique **I**Dentifier)

Cal Registers and User Cal Sets

There are two types of Cal Sets:

- **Cal Registers** (channel specific)
- **User Cal Sets**

Calibration data is automatically saved to a Cal Register at the end of every calibration. You can also choose to save the cal data to a User Cal Set.

Calibration Registers

Calibration Registers are designed to simplify calibrations for most users. When a calibration is complete, the data is automatically saved to the channel's Cal Register, overwriting (or **appended to**) the previous cal data stored in that register. This concept is similar to 'legacy' Vector Network Analyzers.

- Every channel has ONE dedicated Cal Register. They are named CH n _CALREG, where n is the channel number. The name cannot be changed.
- Cal Registers are more volatile because they are overwritten (or **appended**) each time a calibration is performed on that channel. The Cal data is always saved, but only temporarily.
- Cal Registers can be applied to other measurements, but **ONLY** on the same channel as the Cal Register.

User Cal Sets

At the end of a calibration, you can choose to **also** save cal data to an existing or new User Cal Set.

- User Cal Sets can be applied to any number of channels simultaneously.
- User Cal Sets are named by you for easy identification.
- You can have an unlimited number of User Cal Sets.
- At any time, you can copy Cal Register data to create a User Cal Set. See **Cal Set Properties**.

Appending Data in a Cal Set

At the end of a calibration, data is saved to the channel's Cal Register and, if you choose, to a User Cal Set. When you choose to save to an existing User Cal Set, the analyzer attempts to append the new error terms to the existing User Cal Set. The existing Cal Set data is completely overwritten **UNLESS** the new data can coexist with the existing data according to the following two rules:

- The stimulus settings of the new data must exactly match the existing data.
- The new cal must involve different ports from the existing cal.

For example:

Case 1 - An existing Cal Set contains a full 2-port cal between ports 1 and 2. Using the same stimulus settings, you perform a 1-port cal on port 3. At the end of the cal, you click **Save As User Cal Set** and select the existing full 2-port User Cal Set.

Result: The 1-port cal is appended to the 2-port User Cal Set. There is NO overlap between them.

Case 2 - Same situation as Case 1, except the 1-port cal is performed on port 1.

Result: The Cal Set will contain a 1 port cal on port1 and a 1 port cal on port 2. The overlapping tracking terms are removed rendering the original full 2 port cal invalid.

How to Manage and Apply Cal Sets and Cal Types

The analyzer attempts to apply a Cal Set and turn error correction ON for ALL of the measurements on the active channel. This may not always be possible. For example, suppose a channel contains both S11 (reflection) and S21 (transmission) measurements. If a Cal Set that contains only an S11 **Cal Type** is applied to that channel, the Cal Set does not contain the error terms to correct the S21 measurement. Error correction is turned ON for the S11 measurement and NOT turned on for the S21 measurement.

There are two ways to apply an existing Cal Set (Cal Register or User Cal Set) to a measurement:

1. Recalling an Instrument State with Cal data (**.cst file**) - A .cst file contains an Instrument State with all measurement attributes AND a 'pointer' to the Cal Set that was used to calibrate the measurement. Before saving a .cst file, be sure that a User Cal Set (NOT a Cal Register) is being used for the measurement. Because Cal Registers are automatically overwritten when a new calibration is performed, it is likely that the Cal Register data will change before the .cst file is recalled.
2. Create a new measurement and select a Cal Set to apply to the active channel.

Note: NEVER copy or modify Cal Sets from Windows Explorer or other applications. Cal Sets should only be accessed through the VNA Application.

How to select and apply a Cal Set to the active channel

Using **Hardkey/SoftTab/Softkey**

1. Press **Cal** > **Cal Sets & Cal Kits** > **Cal Set...**

◀ **Programming Commands** ▶

Cal Set Selection dialog box help

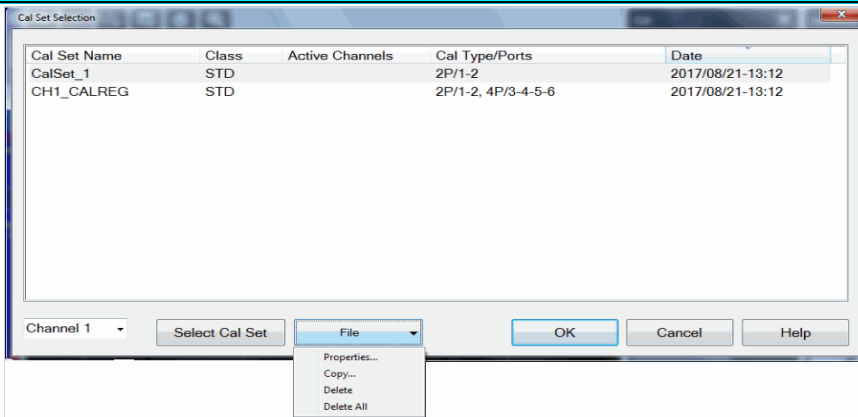

This dialog allows you to manage and apply Cal Sets

Since the number of Cal Sets you can have is limited by the amount of analyzer memory, old Cal Sets (with 'stale' data) should be deleted or overwritten.

- Learn about [Cal Registers](#).
- Learn how to [View the Error Terms of a Cal Set](#).

To apply a Cal Set to the active channel, click a row to select that Cal Set, then click OK. The Cal Set used by the currently active channel is indicated with dotted outline. Currently selected Cal Set is indicated with blue highlight.

Note: A Cal Set must have been generated from the same **measurement class** as the active channel in order for it to Applied.

Columns click a heading to sort by that column

Cal Set Name Name to identify the Cal Set.

Class Indicates the type of channel that created the calset.

Active Channels Channel numbers that are currently using this Cal Set. A blank entry means it is not currently in use.

CalType / Ports Type of Cal contained in the Cal Set. [Learn about applying appropriate Cal Types.](#)

Cal Type Abbreviations:

1P, 2P, 3P, 4P... - Port list indicating which ports were calibrated.

+ - Indicates source and receiver Power Correction is included for the ports that are listed. So **2P+(2,3)** means that the test and reference receivers on ports 2 and 3 are power calibrated.

R - Response (parameter).

ER/x-y **Enhanced Response**, where **x** is the receive port; **y** is the source port. **ER/2-3**, therefore, corrects **S23**.

ER+/x-y Enhanced response plus power. Also contains tracking terms for **bx** and **ay**.

Date Date and time the Cal Set was last modified.

Buttons

Select Cal Set Applies the selected Cal Set to the active channel. If the stimulus settings of the Cal Set and channel are different, **a choice must be made**. This button is greyed-out if the highlighted Cal Set is not compatible with the active channel.

Unselect Cal Set Available ONLY if the selected Cal Set is being used by the active channel. Click 'Unselect Cal Set', then click **OK** to exit with the Cal Set un-applied.

OK Always APPLIES THE SELECTED CAL SET to the active channel, then closes the dialog box. If the currently highlighted Cal Set is not compatible with the active channel and click **OK**, a message dialog will be displayed and indicate the selected Cal Set is not compatible with the active channel. Click **OK** to dismiss the message dialog.

Cancel Exit the dialog box. Performs no further action.

Drop-Down Selector

Channel To choose the active channel.

File This includes **Properties**, **Copy**, **Delete** and **Delete All**.

Properties Starts the **Cal Set Properties** dialog box. This allows you to view all of the Cal Set properties.

Copy Invokes the **Copy Cal Set** dialog box. Type a name for the copy of the selected Cal Set

data.

Delete Permanently deletes the Cal Set after you choose OK to a warning prompt.

Delete All Permanently deletes ALL listed Cal Sets and Cal Registers after you choose OK to a warning prompt.

Cal Set Properties dialog box help

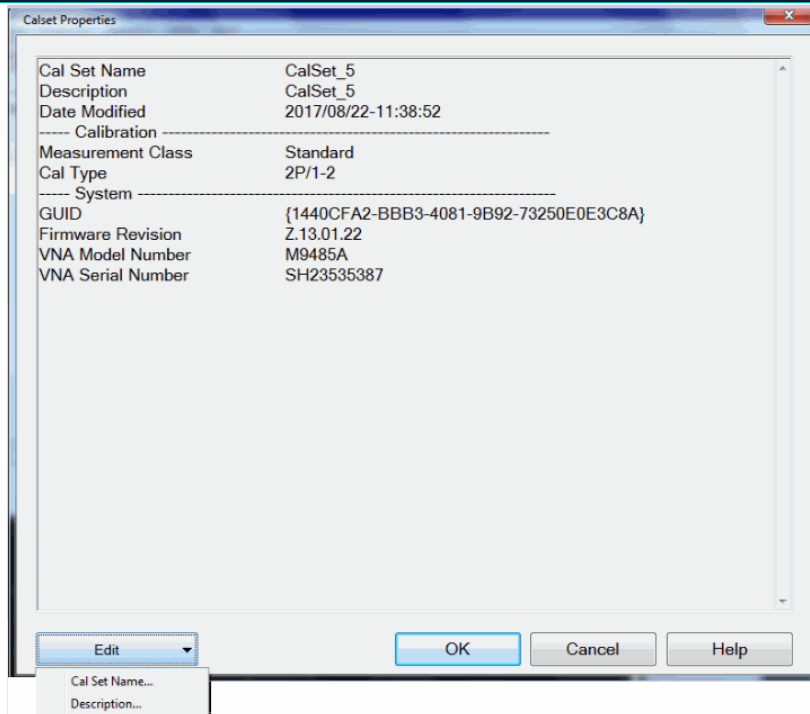

Allows you to view all of the Cal Set properties.

Drop-Down Selector

Edit This includes Cal Set Name and Description.

Cal Set Name Edit name of the User Cal Set. You CANNOT change the name of a Cal Register.

Description Descriptive text to further identify the Cal Set.

Buttons

OK Applies the changes on Cal Set name or description if any and then closes the dialog box.

Cancel Discard changes made to the Cal Set name or description.

Learn how to [View the Error Terms of a Cal Set](#).

Note: Only temperature compensated calibrations show the temperature in the Calset Properties dialog.

Correction Properties dialog box help

Tabs

Summary

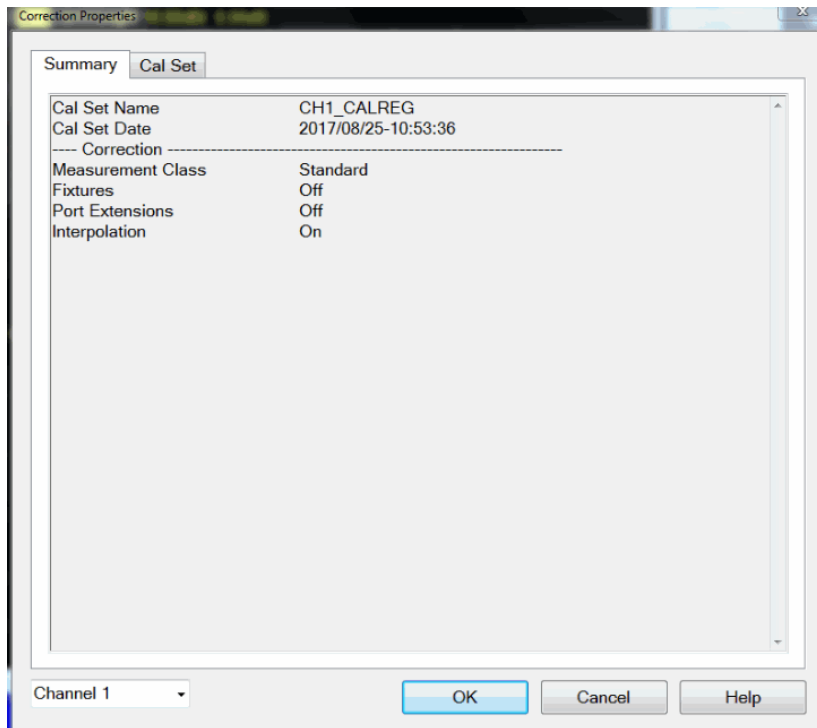

Allow you to view summary of correction properties including Correction, Receiver Power, Source Power and Correction Level.

Channel Selector Select the channel that you want to view the summary of correction properties.

Cal Set

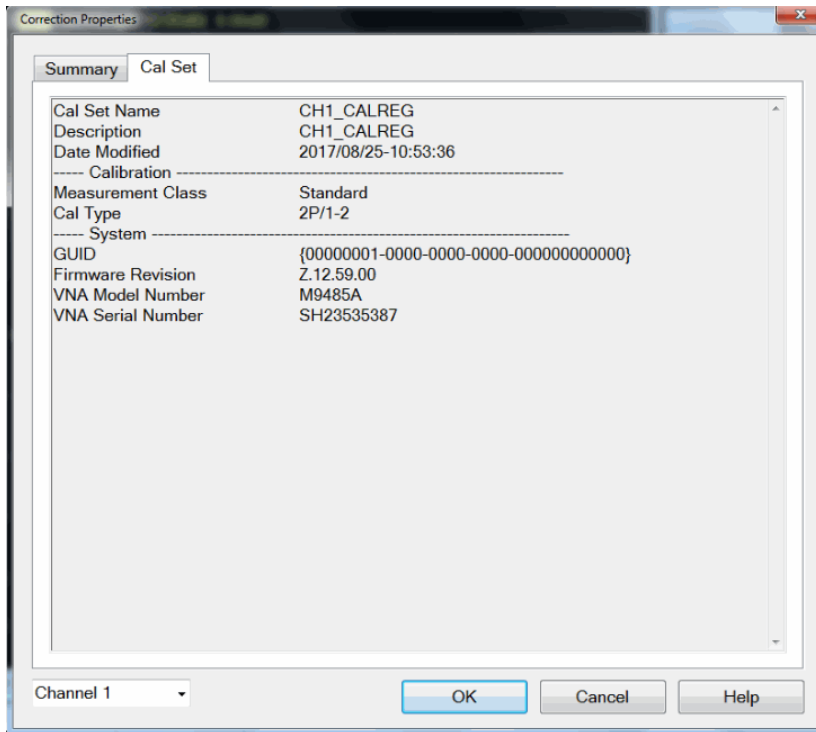

Allow you to view the Cal Set properties. Shows the same data as shown in the [Cal Set Properties dialog](#) accessed from the [Cal Set Selection dialog](#).

Channel Selector Select the channel that you want to view the Cal Set properties.

Stimulus Setting Different between Cal Set and Measurement

Select Cal Set -- Choose Stimulus Settings dialog box help

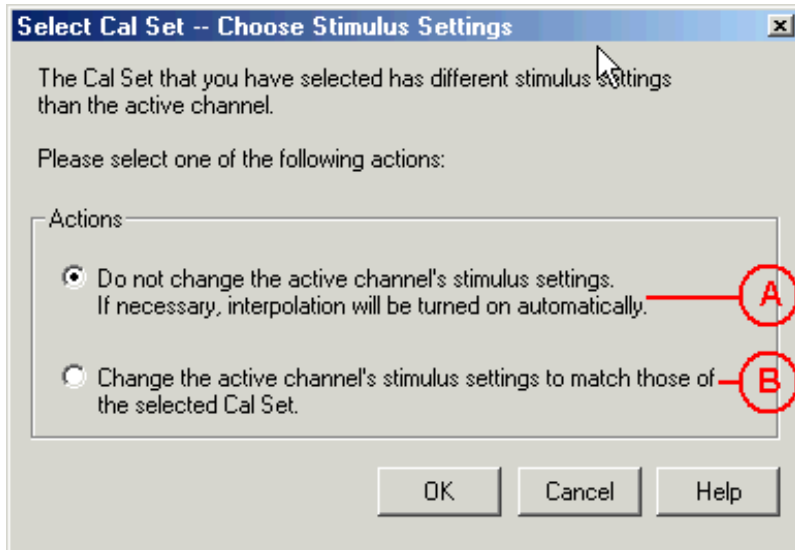

The Cal Set contains the channel stimulus settings that were in place when the Cal Set was saved. This dialog appears when the Cal Set channel settings are different than those of the channel to which the Cal Set is being applied. Choose between the following options.. (See above image).

- A. Keep the Active Channel Stimulus settings. Interpolate if possible.
 - If the Cal Set frequency range is greater the active channel, then Interpolation will be turned ON. Learn more about [Interpolation Accuracy](#)
 - If the Cal Set frequency range is less than the active channel, then this option is not available.
- B. Keep the Cal Set Stimulus settings. The Active Channel stimulus setting are changed.

OK Make the change.

Cancel Cal Set will NOT be applied.

Examples of Cal Set Usage

The following examples show how Cal Sets increase flexibility and speed in making analyzer measurements.

- Using one User Cal Set with many Channels
- [Using one Measurement with many Cal Sets](#)

Using one User Cal Set with many Channels

It is possible to do one calibration, then apply it to several channels.

An example:

During a manufacturing process, you may have many calibrated channels. You may wish to continuously cycle through the measurements and examine them individually. Occasionally, you may wish to refresh the calibration without having to recreate all the measurement state files.

Here is how: Examine the stimulus settings for each channel. Then make the User Cal Set stimulus range a super-set of the whole group. Each channel can then use the same User Cal Set. Some calibrations will be interpolated. **Note:** Make sure that **interpolation** is turned on.

Notice in the following image, Cal Set 78 is used on more than one channel, in this case Channel 5 and 16 .

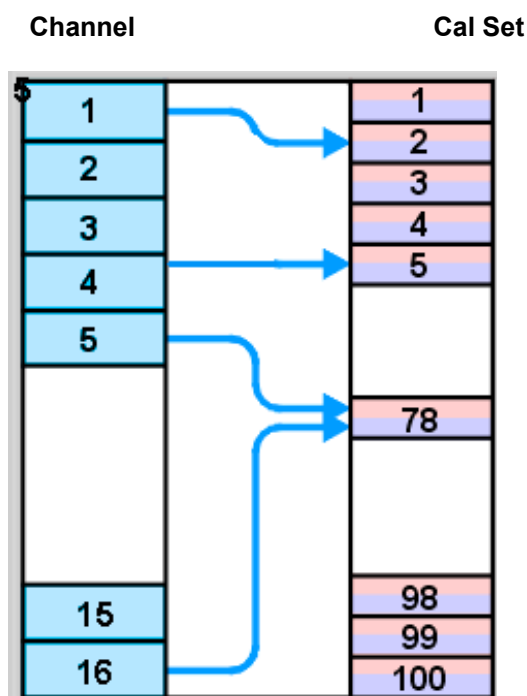

Using one Measurement with many Cal Sets

The drawback with having one very large User Cal Set associated with many instrument states could be a loss of accuracy due to interpolation. In such cases, consider using one User Cal Set for each stimulus setting.. The stimulus conditions can then be changed for a channel by applying different User Cal Sets. Other settings (window setups, measurement definitions, scaling, limits, markers) will not change. This may result in faster state changes than if you saved and recalled *.cst files for each set of stimulus conditions.

Example #1: An amplifier needs to be measured at several input power levels. Calibrate at several power levels and save each calibration in a separate User Cal Set. Then, apply the User Cal Sets to the single measurement consecutively.

Example #2: Making an S21 Measurement, you need to measure both wide span and narrow span characteristics of the device. One Cal Set covers the wide span setup; another the narrow span setup.

Archiving Cal Sets using .cal or .csa files

Because User Cal Sets can easily be deleted, provide extra backup by also saving your calibration as a .cal or .csa file (see [saving a .cal file](#)).

Example:

One person performs a calibration, names and saves it as a User Cal Set. This Cal Set is available for any other person to use. A second user could accidentally delete or modify the User Cal Set requiring the originator to repeat the calibration.

Security can be provided for calibration data by saving the Cal Set to a .cal file or .csa file. At a later time, the file could be recalled and the original calibration restored.

Error Correction and Interpolation

Error Correction and Interpolation settings work together to provide you with the highest level of calibration accuracy possible.

- [How to set Error Correction](#)
- [Error Correction](#)
- [Viewing Correction Levels](#)
- [How to set Interpolation](#)
- [Interpolation Accuracy](#)

See other Calibration Topics

How to set Error Correction

Using [Hardkey](#)/[SoftTab](#)/[Softkey](#)

1. Press [Cal](#) > [Main](#) > [Correction](#) > [Channel Correction On](#)|[Channel Correction Off](#).

[Programming Commands](#)

Error Correction

The Error Correction ON setting means that the calibration error terms are applied to the measurement. Error Correction is automatically turned ON when a calibration is performed or if a Cal Set is applied to a measurement. The VNA attempts to turn error correction ON for ALL of the measurements on the active channel. This may not always be possible when applying Cal Sets. For more information, see [Applying Cal Sets](#).

When full 2-port error correction is ON, both forward and reverse sweeps are required to gather all 12 error terms, even if only one reflection measurement is displayed. This may result in a higher measurement speed than expected. [Learn more](#).

You can always turn Error Correction OFF for the active measurement by clicking Correction OFF. The VNA will turn Error Correction OFF automatically when making stimulus changes [under some conditions](#). To turn correction back ON, click **Correction ON**. Then:

- If Interpolation can NOT be performed, a dialog box will ask if you would like to **change the stimulus settings** to those of the applied calibration. Click OK or Cancel.
- If Interpolation can be performed, the stimulus setting will change and correction turned ON.

How to set Factory Error Correction

Using **Hardkey/SoftTab/Softkey**

1. Press **Cal** > **Main** > **Factory Cal On | Off**



Factory Calibration

The factory calibration is a calibration which is done at the factory shipment or service centers for periodical calibration.

Viewing Correction Level

The correction level provides information about the accuracy of the active measurement. Correction level notation is displayed on the status bar for different calibration types like response, full 2-port, TRL, or power calibration.

To View Correction Levels:

Right-click in the display, select **Customize Display**, select **Toolbars** tab, then select **Status Bar**. The status bar appears and displays the following items:

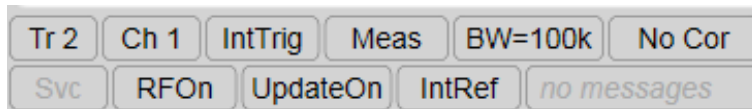

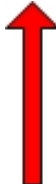
Correction Level		Accuracy	
C N-Port	Full N Port	Highest	
C Enh Resp	Enhanced Response		
C Resp	Response		
Factory	Factory calibration at test port		
No Cor	No Correction		Lowest
C*	Interpolated		Uncertain
CΔ	Changed	Uncertain	

C N-Port

Full N Port correction, where N is the number of fully calibrated ports.

This correction is applied to SParameters.

If the calibration was performed with a receiver power cal, this correction can be applied to receiver measurements. (eg: a_1 , b_1 , A , R_1 , b_1/a_1). (See [Correction Methods](#) for the ability to control the level of calibration applied to receiver measurements).

C Enh Resp

Enhanced response cal is an aggregate of a 1 Port calibration and a transmission response cal.

This correction is applied to reflection and transmission parameters in either the forward direction (S_{11} , S_{21}) or the reverse direction (S_{12} , S_{22}) depending on how the calibration was performed.

For reflection measurements, Enhanced Response correction is equivalent to C 1-Port correction. For transmission measurements, the correction is equivalent to a match-corrected transmission response cal.

C Resp

Response calibrations are one term calibrations that correct for the frequency response of the measurement. It does not correct for impedance mismatches.

No Corr No Correction

The following will cause the VNA to turn Error Correction OFF for the channel:

- Decrease the start frequency
- Increase the stop frequency
- Change start frequency, stop frequency, or number of points with Interpolation OFF.
- **Change sweep type**

The correction pop up pane, accessed by right-clicking on the Correction item in the status bar, indicates port by port correction methods for a VNA with 12 or less test ports. This table is updated when the **port subset correction** is turned on to reflect the correction methods being applied. In the image below, the pane indicates a full 4-port calibration. On the **right**, the table indicates the methods after the correction was devolved to ports 1, 2, and 3.

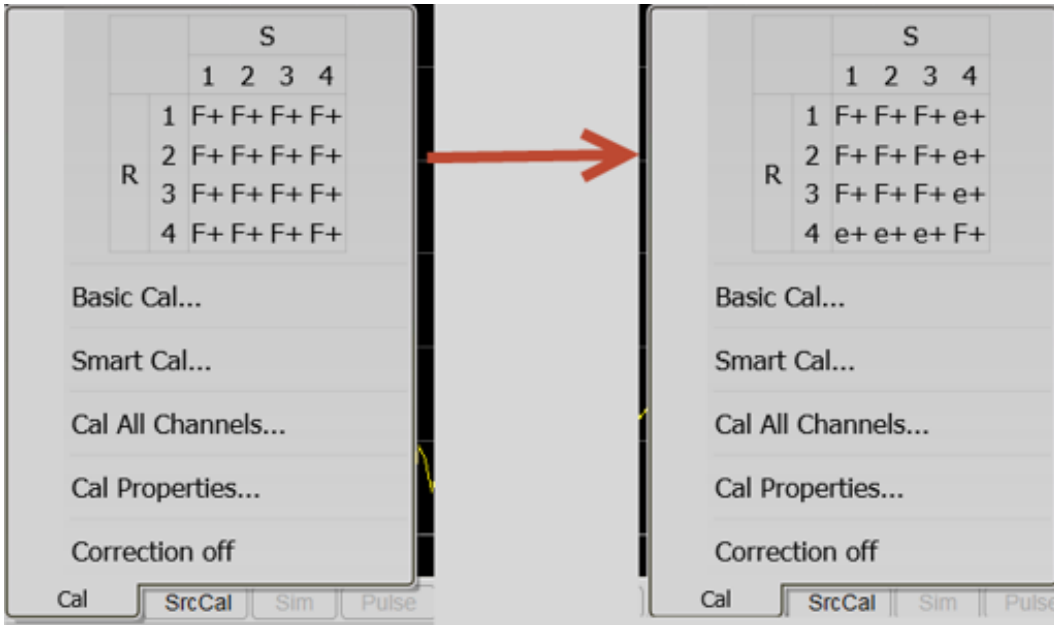

The **F+** indicates that the port had the full error correction applied. The **e+** indicates that the enhanced response correction method was applied to the port.

C* Interpolated Correction

"C star" appears in the status bar when a measurement is being interpolated. See Interpolation (above) and [Interpolation Accuracy](#).

CΔ Changed Settings

"C-delta" appears in the status bar when one or more of the following stimulus settings change. The resulting measurement accuracy depends on which parameter has changed and how much it has changed. For optimum accuracy, recalibrate using the new settings.

- Sweep time
- IF Bandwidth
- Port power
- Stepped sweep enabled/disabled

How to set Interpolation

Using **Hardkey/SoftTab/Softkey**

1. Press **Cal** > **Main** > **Interpolation ON|OFF**.

Programming Commands

Interpolation

Calibration interpolation adjusts calibration error terms to match changes to the following settings that you make **AFTER** a calibration is performed or a **Cal Set applied**.

The Interpolation **ON** setting means that interpolation is **enabled** for the active measurement. This does not necessarily mean that the measurement is interpolated. When enabled (ON), if interpolation becomes necessary because you change any of the following stimulus settings, **then** interpolation will be applied. When stimulus settings change while interpolation is OFF, interpolation is NOT applied but instead, error correction is turned OFF.

Interpolation occurs (if enabled) when you change any of the following settings:

- Start frequency increased
- Stop frequency decreased
- Number of points

Note: Decreasing the start frequency, or increasing the stop frequency will always turn correction **OFF**. (Exception: **Power Calibration** DOES extrapolate to the start and stop frequencies.)

Interpolation Accuracy

When a measurement is interpolated, the accuracy of the measurements cannot be predicted. It may be affected significantly or not at all. Identifying measurement errors in these cases must be determined on a case-by-case basis. In general, the magnitude and phase stimulus from the VNA and the response from the DUT need to be smooth and continuous for measurement interpolation to give accurate results.

Significant measurement inaccuracy **WILL** occur when the phase shift response between measurement points increases changes more than 180 degrees. The VNA will incorrectly interpolate the new phase data. For more information, see **phase accuracy**.

In general, the chances of significant inaccuracy increases when interpolating measurements under the

following conditions:

- when frequency span between measurement points becomes much greater.
- when measurement frequencies are above 10 GHz where phase changes happen more rapidly.
- when interpolating across frequency band crossings. [Learn more about band crossings.](#)

Note: When the interpolation algorithm encounters an abrupt or large change in the response magnitude or phase, such as can occur at band crossings, large interpolation errors can be included in the displayed data. These errors can be seen as steps or spikes. If this occurs, consider turning off interpolation, changing the measurement parameters, or creating [sweep segments](#) that skip over the band crossings.

Using ECal

This topic discusses all aspects of performing an ECal:

- [ECal Overview](#)
- [Connect ECal Module to the Analyzer](#)
- [How to Perform a Calibration Using ECal](#)

See Also:

[ECal User-Characterization](#)

[Perform a 4-Port Cal with ONE 2-Port ECal Module](#)

[Restore ECal Module Memory](#)

[See other Calibration Topics](#)

ECal Overview

ECal is a complete solid-state calibration solution. Every ECal module contains electronic standards that are automatically switched into position during a measurement calibration. These electronic standards have been measured at the factory and the data stored within the memory of the ECal module. The analyzer uses this stored data, along with the measured data, to calculate the error terms for a measurement calibration.

ECal modules are available in 2-port and 4-port models and a variety of connector types, covering many frequency ranges. See [Analyzer Accessories](#) for more about available ECal modules and ordering information.

You can perform the following calibrations with ECal:

- 1-Port Reflection calibration
- Full 2-Port calibration
- Full 3-Port calibration
- And so forth...

Verify the validity of a mechanical or ECal calibration with [ECal confidence check](#).

Care and Handling of ECal Modules

You can improve accuracy, repeatability, and avoid costly repair of equipment in the following ways.

- Practice proper connector care. See [Connector Care](#).
- Protect equipment against ESD damage. Read [Electrostatic Discharge Protection](#).

Power Level into an ECal module

- NEVER exceed the following Damage levels to the ECal module.
- For highest accuracy, do not exceed the following ECal Compression levels when calibrating:

Model	Compression level	Damage level
N469x series	-5 dBm	+10 dBm
N4432A series	-7 dBm	+20 dBm
N4433A series		
N4431x series	+7 dBm	+20 dBm
N755xA series	-5 dBm	+10 dBm
8509x series	+9 dBm	+20 dBm

The power level can be increased after calibration with minimal impact on measurement accuracy.

Connect ECal Module to the Analyzer

ECal modules are controlled and powered through a USB connection. When you connect the module, the type of module, frequency range, and connector type are automatically recognized.

For PXI modules, connect the ECal module to a USB port on the remote or embedded controller.

Important Note: DO NOT connect/disconnect USB devices during ECal calibrations. Doing so may cause problems with the calibration.

Notes:

- Unused ECal modules that have completed a calibration may remain connected to the USB port.

- You can connect and disconnect the ECal module while the analyzer is operating. However, DO NOT connect or disconnect the module while data transfer is in progress. This can result in damage or at least corrupted data.

How to Perform a Calibration Using ECal

Select an ECal module that has connectors of the same type and gender as the DUT. If such an ECal module is not available, a module with connectors different from the DUT can be used by using [Advanced Settings](#) or [User Characterization](#). See Also: [Perform a 4-Port Cal with ONE 2-Port ECal Module](#)

Connect the ECal module ports to the analyzer ports. During the calibration process the analyzer can either automatically detect how the ECal module is connected, or the orientation can be performed manually.

1. Connect the ECal module USB cable to the analyzer USB. See [Connect ECal Module to USB](#).
2. Allow the module to warm up until it indicates **READY**.
3. Enter the analyzer settings. See [Set Up Measurements](#).
4. Do one of the following to start the [Calibration Wizard](#)

Using [Hardkey/SoftTab/Softkey](#)

1. Press [Cal](#) > [Main](#) > [Other Cals](#) > [Ecal...](#)

Programming Commands

2. In the [Guided Calibration Wizard](#) dialog box (step 2), select ECal option from the Cal Kits combo box.

Select Calibration Ports and ECal Module dialog box help

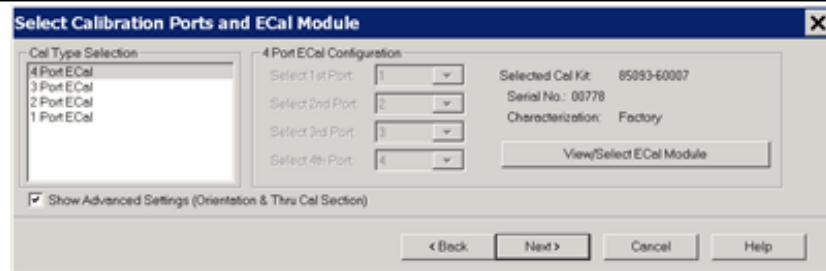

Allows you to select calibration type and settings.

Cal Type Selection / Configuration Select the number of ports to calibrate. Then select the port number configuration.

4 Port ECal

3 Port ECal

2 Port ECal

1 Port ECal- (Reflection) Advanced Settings are not available.

View/Select ECal Module Click to **Select the ECal module** if more than one ECal module is connected to the USB. Also, **Select the User Characterization** within the module. Learn more about **User Characterization**.

Show Advanced Settings Check to display the **Advanced Settings** when **Next** is clicked.

Back Return to **Cal Wizard Begin** dialog.

Note: ECal isolation is not performed. The inherent isolation of the analyzer is better than that attained with correction using an ECal module.

Note: Terminate any unused ECal ports with a 50 ohm load. Refer to **Determining Effects of Not Terminating Unused ECal Ports**.

Note: Do not connect any USB memory during ECal calibration.

ECal module not found dialog box help

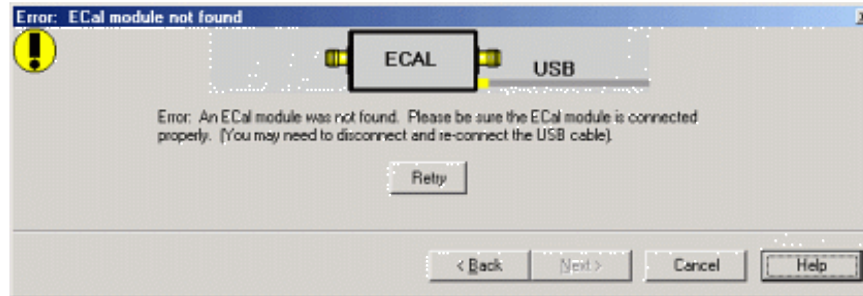

When this dialog appears, the ECal module is not connected or has not been recognized by the network analyzer.

Retry Check the USB connections and click to continue.

Notes:

- If your ECal module is not detected, try to unplug, then reconnect to the USB.
- When the ECal module is connected to the network analyzer for the first time, it may take approximately 30 seconds for the analyzer to recognize the module and make it available for calibration.
- For best accuracy, allow the ECal module to warm-up until it indicates READY.
- See [Connect ECal Module to USB](#).

Select Module and Characterization dialog box help

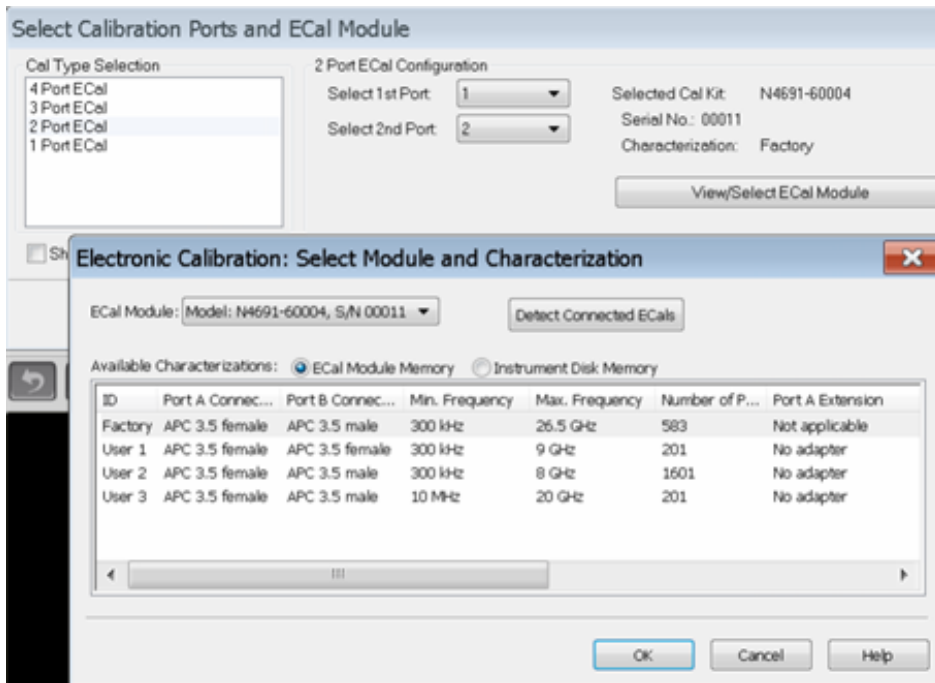

Note: User Characterizations listed in the dialog below that have no temperature shown cannot be temperature-compensated during calibrations. Also, this is true of CalPod as ECal characterizations that were performed prior to this temperature capability in the VNA firmware, because temperature was not measured-and-recorded. However, the firmware will still recognize those and allow them to be used for cals.

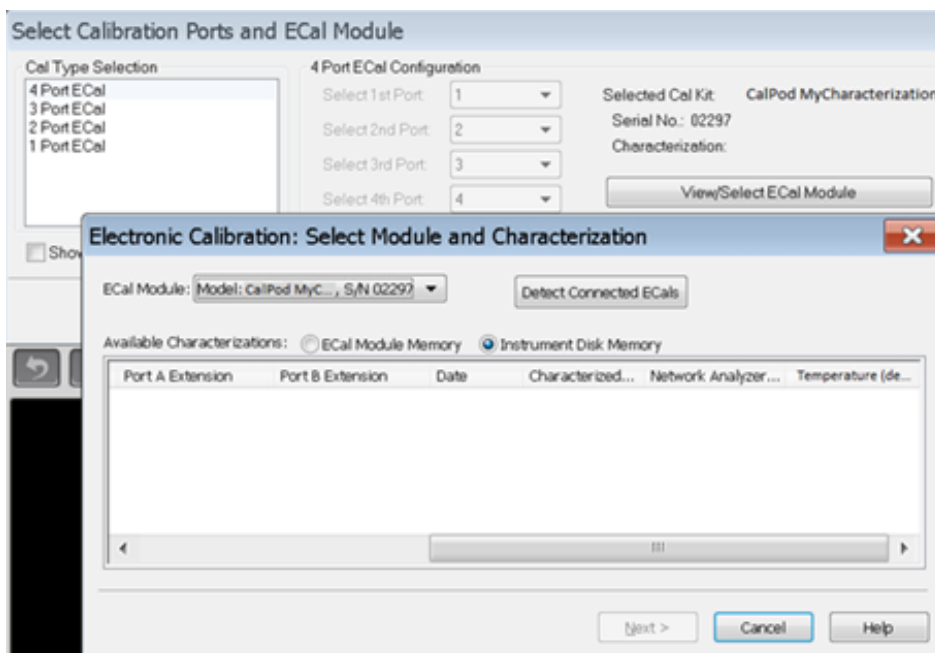

ECal Module Select one of the ECal modules that are connected to the analyzer.

Detect Connected ECals Click to rescan the USB for ECal modules.

Available Characterizations

ECal Module Memory - Displays the factory and **user characterizations** that are stored in the ECal module.

Instrument Disk Memory - Displays the user characterizations that are stored in Disk Memory. [Learn more User Characterizations in Disk Memory.](#)

Temperature - Displays the temperature reading at the time a characterization was performed.

The information in the Calset Properties dialog confirms which of those characterizations were temperature-compensated during calibration. The **(compensated)** notation for a CalPod indicates that the CalPod's characterization was temperature-compensated when that cal's error terms were computed (it also implies the factory thermal data for that CalPod must be present on the VNA). Whereas the **(uncompensated)** notation indicates that temperature-compensation could not be done for that characterization during the cal, which could mean either that one is an older characterization that didn't record its temperature, or else factory thermal data for that CalPod serial # was not installed on the VNA.

Select the characterization data to use for the calibration. Once selected, that characterization becomes the default selection until the analyzer is turned OFF and restarted. When restarted, **Factory** again becomes the default selection.

Error: Frequency Range dialog box help

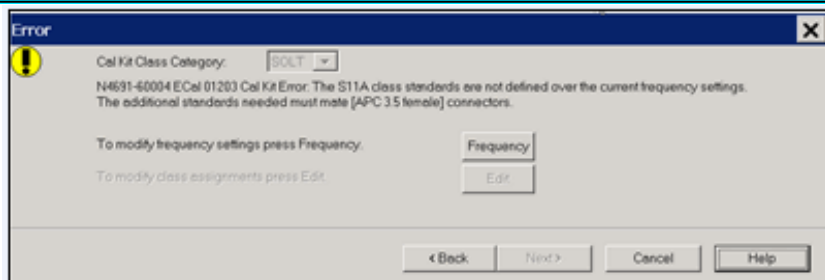

When this dialog appears, the current cal standards (or ECAL module) does not cover the current frequency range of the measurement. Do one of the following to correct the problem:

Cal Kit Class Category Not available with ECal modules.

Frequency Change the frequency range of the active channel.

Edit Not available with ECal modules.

Back Select a different characterization that covers the required frequency range.

Cancel Re-characterize the module with an increased frequency range.

Select DUT Connectors and Cal Kits dialog box help

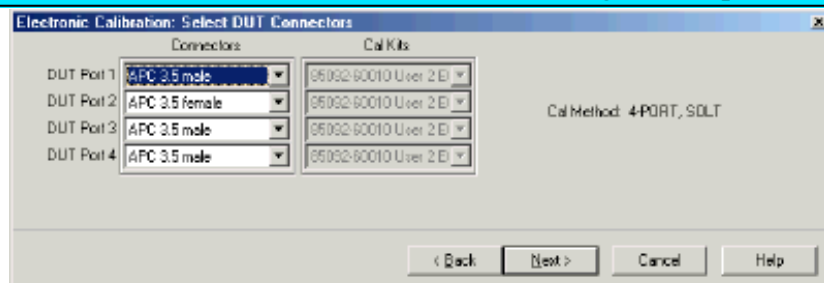

If the ECal module or selected User Characterization has more than one connector type, then the following dialog box is presented which allows you to describe the DUT connector type. Otherwise, click next to proceed to [Advanced Settings](#) (if checked) or [ECal Steps](#).

Connectors

The available connectors are listed for each DUT port.

Advanced Settings dialog box help

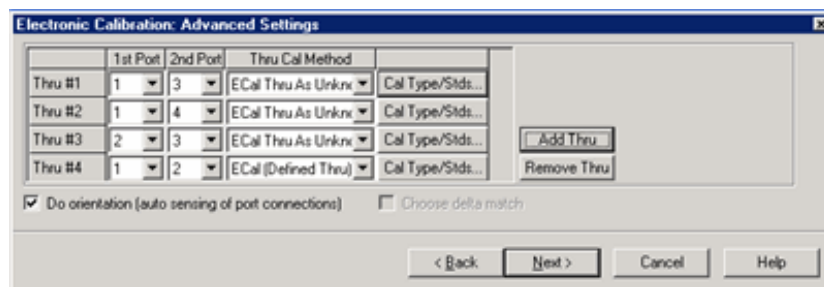

Thru #n

Lists the proposed Thru connections to be made during the calibration process. You can change these Thru connections to better suit your test setup.

- The proposed Thru connections are listed automatically.
- Additional Thru connections can be selected for higher accuracy. [Learn more](#).

- For Balanced measurements, [learn which Thru paths to select](#).

Add Thru

Click to add a Thru connection. [Learn more](#)

Remove Thru

Select a Thru by clicking the "Thru #N" field or the "1st Port / 2nd Port" field. Then click "Remove Thru". This selection is NOT available if the selected Thru is required for the calibration.

1st Port / 2nd Port

Click to change the two ports to be included in the Thru connection. The order of the port numbers (1st or 2nd) is not critical.

Thru Cal Method

Lists the available Thru Cal methods for the specified port pairs.

[Learn about ECal Thru Methods](#)

Cal Type/ Stds

Click to invoke the [View / Modify Properties of Cal dialog box](#)

Do orientation

When this box is checked (the default setting) the VNA automatically senses the model and direction in which an ECal module port is connected to the VNA ports. If power to the ECal module is too low, it will appear as if there is no ECal module connected. If you use low power and are having this problem, clear this check box to provide the orientation manually.

Orientation occurs first at the middle of the frequency range that you are calibrating. If a signal is not detected, it tries again at the lowest frequency in the range.

Choose delta match

Available only when a Delta Match Cal is required.

- Check, then click **Next** to invoke the [Select Cal Set for Delta Match](#) dialog box.
- Clear - The Cal Wizard uses the Global Delta Match Cal if available.

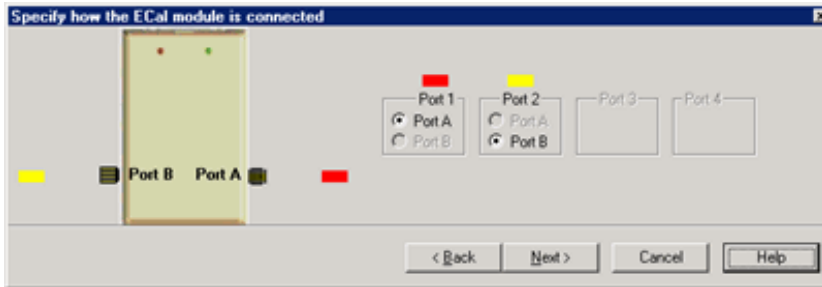

Specify how the ECal module is connected dialog box help

This dialog box appears when the **Do orientation** checkbox in the previous dialog box is cleared.

Click the ECal Port that is connected to each VNA port.

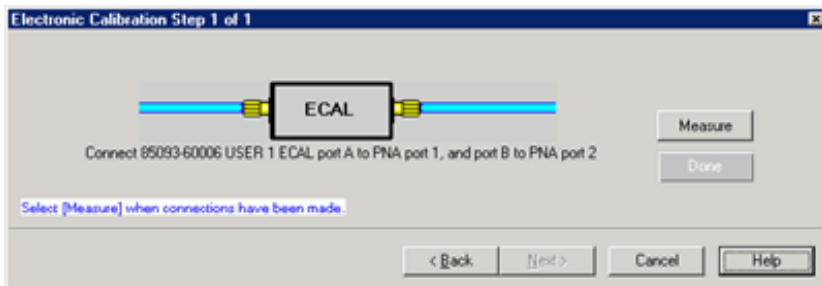

Electronic Calibration Steps dialog box help

Note: Beginning in VNA Rev. 6.0, ECal can be performed with External triggers. [Learn more.](#)

Displays the instructions for each measurement required for calibration.

Measure Measures the ECal standards.

Done Click when last standard has been measured.

Saving an ECal Calibration

When complete, you can save the new calibration. [Learn how.](#)

ECal User Characterization

- [Overview](#)
- [How to Perform a User Characterization](#)
- [Manage Disk Memory](#)
- [Restore ECal Module Memory](#)

See Also

[Using ECal](#)

[Perform a 4-Port Cal with a 2-Port ECal Module](#)

Other Calibration Topics

Overview

A user-characterized ECal module allows you to add adapters to the ECal module, re-measure the standards in the ECal module, INCLUDING the adapters, then add that data to ECal memory or save it to disk memory. This extends the reference plane from the module test ports to the adapters.

Compared to legacy ECal modules, the new N755xA ECal modules have greater flash memory.

Important Note: DO NOT connect/disconnect USB devices during ECal calibrations. Doing so may cause problems with the calibration.

Why perform a User Characterization?

- If you need to use adapters with your ECal module, you could characterize your ECal module with the adapters attached and perform subsequent ECals in a single step.
- If you have a 4-port ECal module, you could configure the module with adapters of different connector types, then perform a User Characterization of the module. When you need to test a DUT with a pair of the connector types on your module, calibrate the analyzer with a 1-step ECal using the same two connectors on the User-characterized module.

- If you test devices in a fixture, you could embed the characterization of the fixture in the characterization of the module. To do this, during the mechanical calibration portion of the User Characterization, calibrate at the reference plane of the device as you would normally calibrate. Then remove the fixturing to be embedded and insert the ECal module to be characterized. When measuring the ECal module, the analyzer removes the effects of the fixturing and stores the measurement results in the user characterized ECal module. Subsequent calibrations with that user-characterized module will also remove the fixture effects.

Notes:

- Both 2-port and 4-port ECal modules support User Characterization.
- User Characterization does not delete the factory characterization data. The factory data is saved in the ECal module in addition to the User Characterization data.
- The ECal Data Wipe Utility is the only way that data can be deleted from the module. Learn more at <http://na.support.keysight.com/pna/apps/applications.htm>.
- A User Characterization can be performed beyond the frequency range of the ECal module. Although this practice is allowed, calibration accuracy with the extended User Characterization is likely to be degraded. To determine the level of degradation, compare measurements of a variety of devices with a mechanical cal kit calibration versus an ECal extended User Characterization calibration.
- You can save up to 12 User Characterizations in a single ECal module. Previous releases allowed up to 5. There are memory limitations. The analyzer will determine if the contents of a User Characterization will fit inside the module before it is performed.
- A User Characterization can be performed remotely. [See programming commands.](#)

User Characterizations can be saved to **Disk Memory**. [Learn how.](#)

This feature provides the following benefits:

- A User Characterization using connectors that are NOT included in the [supported connector table](#) can NOT be stored to the ECal module. But when stored to disk memory, ANY connector type is allowed by firmware using a description of any length for the User Characterization.
- There is NO limit to the number of data points allowed in a User Characterization stored to disk memory. When stored in the ECal module, the number of data points is limited to a maximum of 65535 per characterization, or less as dictated by the remaining free memory in the module.
- The number of User Characterizations that can be stored to disk memory is limited only by available disk space.
- User Characterizations stored to disk memory can be freely shared between analyzers.

[Learn how to Manage User Characterization in Disk Memory.](#)

How to Perform a User Characterization

SUMMARY (A detailed procedure follows.)

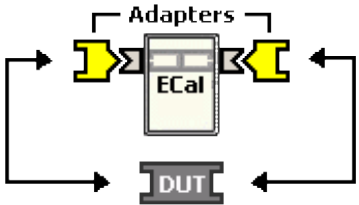
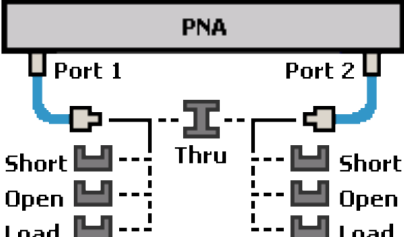
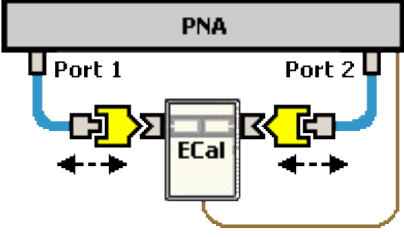
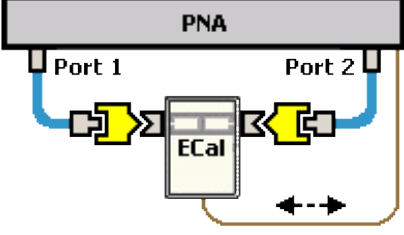
	<p>1. Select adapters for the module to match the connector configuration of the DUT.</p>
	<p>2. Either calibrate the analyzer using mechanical standards or recall an existing Cal Set.</p>
	<p>3. Measure the ECal module, including adapters, as though it were a DUT.</p>
	<p>4. The measurement results are the characterization data that then gets stored inside the module or to disk.</p>

Note

A 2-port analyzer can be used to perform a User Characterization on a 4-port ECal module. However, a 4-port ECal module has SIX different port pairs. The analyzer must be recalibrated for each port pair that uses unique connector types or gender.

- If all 4 ECal module ports have the same connector type and gender, then only one calibration is required to measure all six port pairs.
- If all 4 ECal module ports have different connector types or gender, then 6 calibrations are required.

When more than one calibration is required during a User Characterization, then ALL calibrations must be performed using the standard Cal Wizard, saved to Cal Sets, and then **recalled from Cal Sets DURING** the User Characterization.

Detailed steps to Perform a User Characterization

1. Connect the ECal module to the network analyzer with the USB cable. See **Connect ECal Module USB to the analyzer USB**.
2. Allow the module to warm up until it indicates **READY**.
3. **Preset** the analyzer.
4. **Set up the measurement**. For best accuracy, the **IF bandwidth** should be set to **1 kHz** or less.
5. Start and complete the **Characterize ECal Module** Wizard:

Using **Hardkey/SoftTab/Softkey**

1. Press **Cal > Cal Sets & Cal Kits > ECal > Characterize ECal...**

Programming Commands

Select Module and Location dialog box help

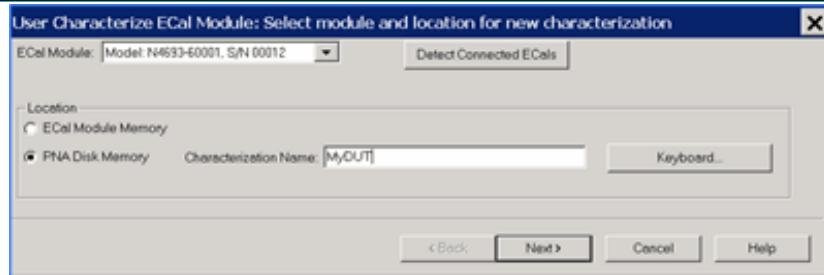

ECal Module Select one of the ECal modules that are connected to the analyzer.

Detect Connected ECals Click to rescan the USB for ECal modules.

Location

- **ECal Module Memory** Click Next to see the following dialog.
- **Disk Memory** Enter a Characterization Name. This name appears when selecting a User Characterization to be used with subsequent calibrations.
 - [Learn how to manage characterizations that are stored to disk memory.](#)
 - [See the benefits of storing the User Characterization to disk Memory.](#)

Keyboard Launches a keypad that can be used to type a characterization name from the analyzer front panel.

Next Click to continue to the [Select Connectors for the Characterization](#) dialog box.

[See note regarding extended frequency use.](#)

Select User Number for new characterization dialog box help

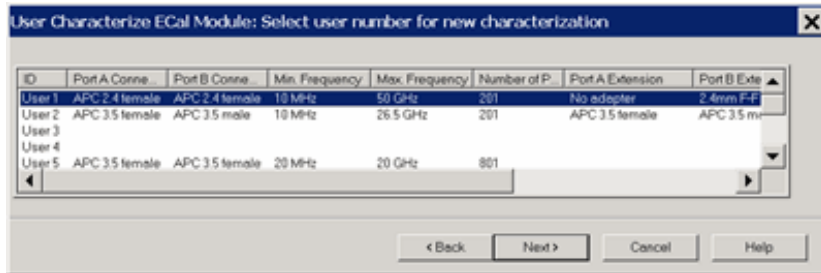

Scroll to view all of the parameters of the stored characterizations. Select an empty location or select to overwrite an existing characterization.

Next Click to continue to the [Select Connectors for the Characterization](#) dialog box.

[See note regarding extended frequency use.](#)

Select Connectors for the Characterization dialog box help

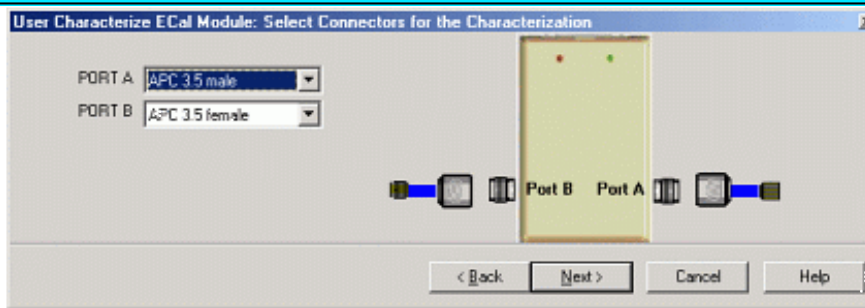

Connector Notes

When performing an ECal User Characterization, do NOT use a **custom connector name** that you added to this list. If you need to use a custom-defined connector type, select "Type B", or one of the "Type A" variations from the list of connectors for each port.

A User Characterization using connectors that are NOT included in the [supported connector table](#) can NOT be stored to the ECal module. But when stored to disk memory, ANY connector type is allowed. [Learn more about storing to Disk Memory.](#)

Select the adapters for the ECal module test ports. Select **No adapter** if no adapter is used on a port.

PORT A Lists the connector types available for Port A.

PORT B Lists the connector types available for Port B.

PORT C Lists the connector types available for Port C (available with a 4-port ECal module).

PORT D Lists the connector types available for Port D (available with a 4-port ECal module).

Next Click to continue to the [Calibrations to perform or recall](#) dialog box.

Calibrations to perform or recall dialog box help

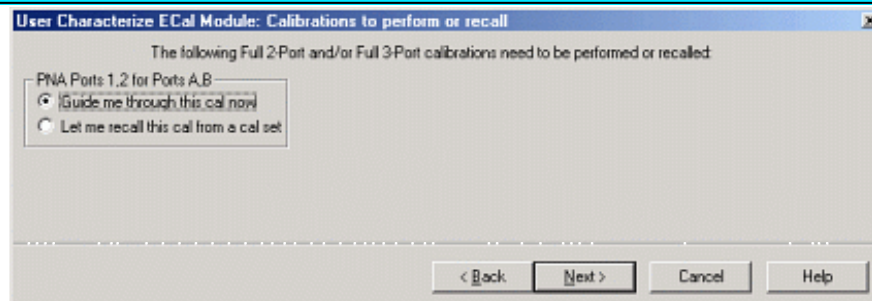

The analyzer must be calibrated before measuring the ECal module and necessary adapters. This dialog box displays the number and types of mechanical calibrations required for the characterization.

Guide me through this cal now Click to perform a Guided calibration. A calibration kit is required for each connector type.

If more than one calibration is required, the following selection is not available. [See Note.](#)

Let me recall this cal from a cal set Click to select an existing Cal Set. You cannot select a Cal Set that is currently in use. Learn more about [Using Cal Sets.](#)

Next Click to continue to either the [Select Cal Kits](#) or the [Select Cal Set](#) dialog box.

Select Cal Kits dialog box help

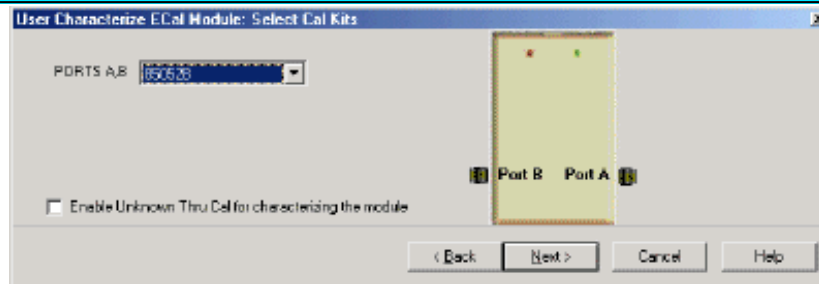

Provides a list of calibration kits to perform the calibration. Select the Cal Kit you will use for each port.

Enable Unknown Thru for characterizing the module Check to enable. This reduces the number of steps required to characterize the THRU standard.

Next Click to continue to the [Select Cal Set](#) dialog box.

Select Cal Set dialog box help

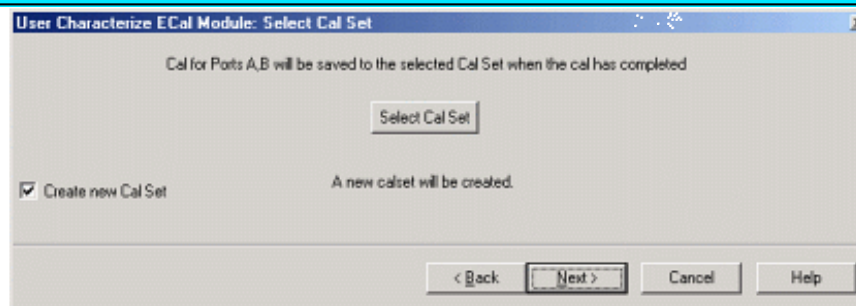

The calibration that you perform will be written to a Cal Set. This dialog box allows you to select a Cal Set to overwrite, or to write to a new Cal Set. The current choice is visible below the **Select Cal Set** button.

Select Cal Set Click to open the **Select A Cal Set** dialog box.

Create new Cal Set Check to create a new Cal Set to store the calibration. Clear to select and overwrite a stored Cal Set.

Next Click to continue to the [Guided Calibration Steps](#) dialog box.

Note: Remember the Cal Set name for future reference.

Guided Calibration Steps dialog box help

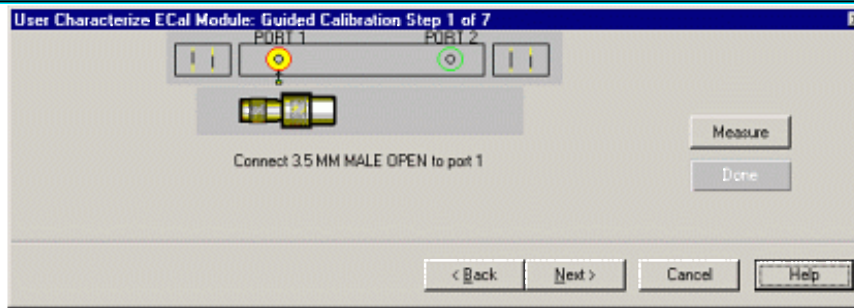

Instructs you to connect each calibration standard to the measurement port.

Measure Click to measure the standard.

Back Click to repeat one or more calibration steps.

Done Click **after** a standard is re-measured and all measurements for the calibration are complete.

Next Click to continue to the next calibration step. (Does **not** measure the standard.)

Cancel Exits Calibration Wizard.

The **Specify nominal delay** or **Guided Calibration completed** dialog box appears when the steps are completed.

Specify nominal delay dialog box help

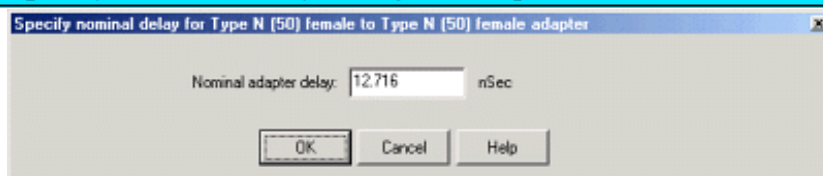

This dialog **ONLY** appears when **Adapter Removal** or **Unknown Thru** calibrations are performed.

The following values were estimated from the measurement. Most of the time, they are adequate. However, for CW sweep or frequency sweep with large step sizes, the accuracy of the values may be improved.

Nominal adapter delay To improve this value, measure and record the delay of the adapter with a dense step size. Enter that value here.

Nominal phase offset (Waveguide ONLY). To improve this value, measure and record the phase offset of the Waveguide adapter with dense step size. Enter that value here.

When one connector is coax and the other connector is waveguide, the phase offset has an ambiguity of 180 degrees. For consistency, the estimate provided here is always between 0 and 180 degrees. You can change this estimate to any value between -180 degrees and +180 degrees.

Guided Calibration completed dialog box help

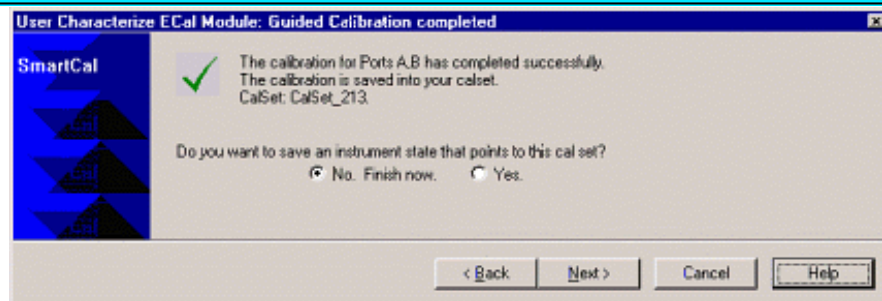

Allows you to finish the calibration and continue to the next characterization steps.

No. Finish now Select to save Cal Set data.

Yes Allows selection of Save options.

Next Click to continue to the [Exit to Inspect Quality of Calibration](#) dialog box.

Exit to Inspect Quality of Calibration dialog box help

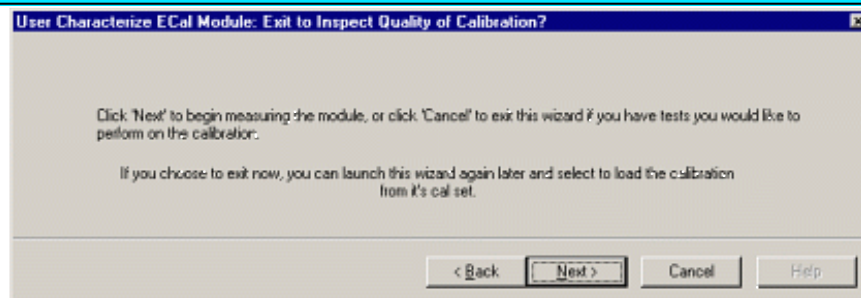

Allows you to exit User Characterization to [validate the calibration](#) before proceeding with the characterization.

Back Allows you to repeat calibration.

Next Click to continue to the [Characterization Steps](#) dialog box.

Cancel Exits the Calibration.

To return to the current step:

1. Start User Characterization.
2. In the **Select user number for new characterization** dialog box, click **Next**.
3. In the **Select Connectors for Characterization** dialog box, click **Next**. (Previous entry is stored in memory.)
4. In the **Calibrations to perform or recall** dialog box, recall the Cal Set that you just performed.

Characterization Steps dialog box help

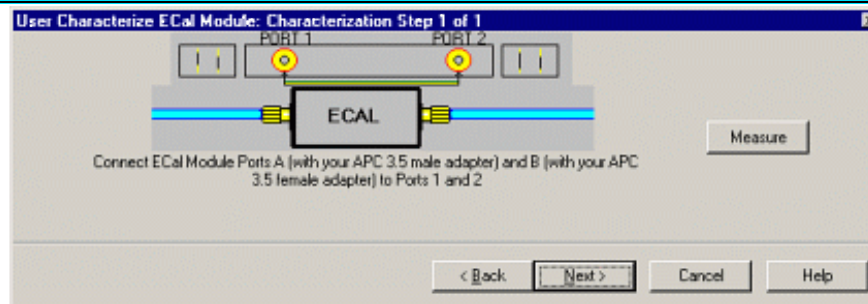

Describes the instructions for each measurement required for characterization.

Measure Measures the ECal module.

Next Click to continue to the **Information for the New Characterization** dialog box when measurements are complete.

Information for the New Characterization dialog box help

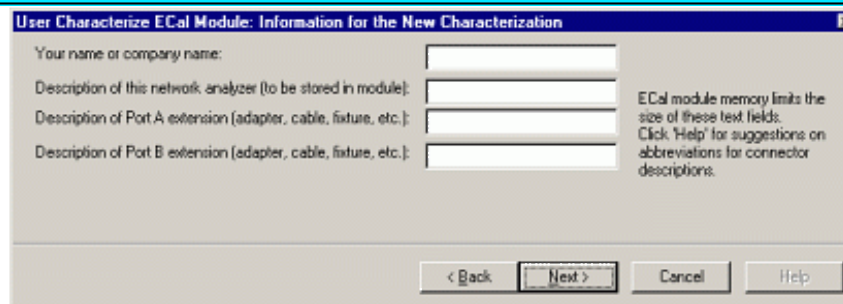

Allows you to describe the properties of the User Characterization.

Suggestions for connector abbreviations

To minimize the number of characters, we suggest using the following 3-character codes to describe the connectors listed.

A User Characterization using connectors that are NOT included on this list can NOT be stored to the ECal module. But when stored to disk memory, ANY connector type is allowed. [Learn more about storing to Disk Memory.](#)

Connector Type	3-Character Code
1.0 mm female	10F
1.0 mm male	10M
1.85 mm female	18F
1.85 mm male	18M
2.4 mm female	24F
2.4 mm male	24M
2.92 mm female	29F
2.92 mm male	29M
3.5 mm female	35F
3.5 mm male	35M
7-16 female	16F
7-16 male	16M
Type F female	F7F
Type F male	F7M
N50 female	N5F
N50 male	N5M
N75 female	N7F
N75 male	N7M
APC 7	7MM
K-band waveguide	KBW
P-band waveguide	PBW
Q-band waveguide	QBW
R-band waveguide	RBW
U-band waveguide	UBW
V-band waveguide	VBW
W-band waveguide	WBW
X-band waveguide	XBW

Next Click to continue to the **Write Characterized Data to the ECal module** dialog box.

Write Characterized Data dialog box help

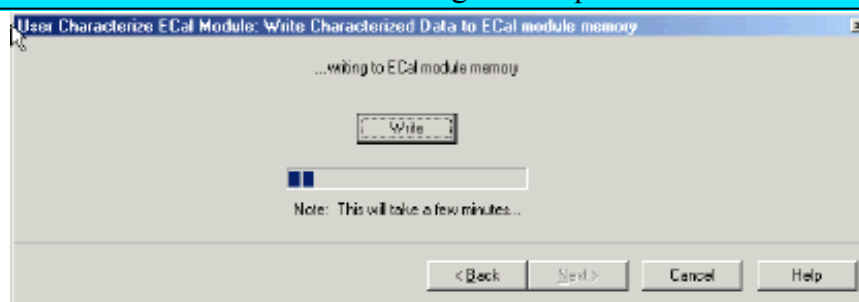

User Characterization and factory characterization data is written to either the disk memory or the ECal module memory.

Write Click to write data.

The **Summary of new User Characterization** dialog box opens after data is saved to module.

- Existing data will be overwritten if you selected a User Characterization number that already has data. [Learn more](#)
- For more information, see [Restore ECal module memory](#).
- The ECal Data Wipe Utility is the only way that data can be deleted from the module. Learn more at <http://na.support.keysight.com/pna/apps/applications.htm>.

Summary of new User Characterization dialog box help

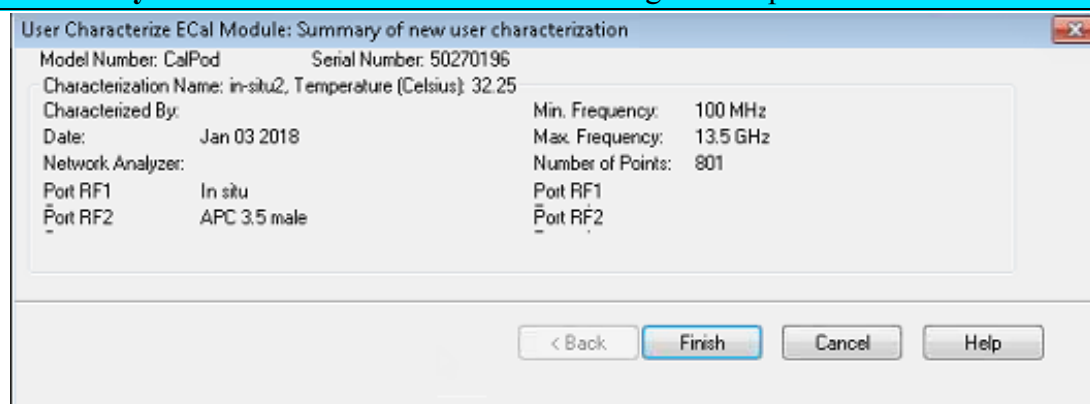

Verify the status of the ECal User Characterization.

- ECal module model number
- summary from User Characterization

Cancel Click to exit (characterization complete).

Finish Click to exit (characterization complete).

Manage ECal User Characterizations in Disk Memory

Normally, User Characterizations that are stored in disk memory can be used indefinitely without needing them to be managed. However, this dialog allows you to backup the characterizations in case they are accidentally erased, or to save them to a file that can be moved to another analyzer.

How to Manage ECal User Characterizations in Disk Memory

Using **Hardkey/SoftTab/Softkey**

1. Press **Cal** > **Cal Sets & Cal Kits** > **ECal** > **Manage ECal Disk Memory...**

◀ **Programming Commands** ▶

Manage ECal User Characterizations in Disk Memory dialog box help

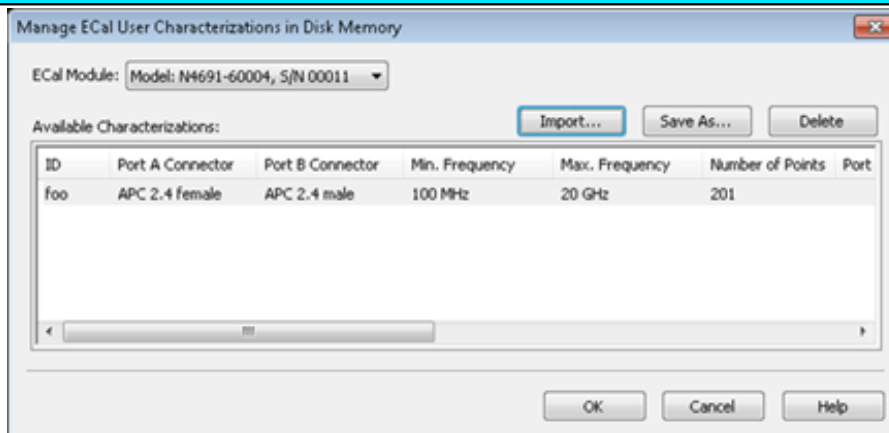

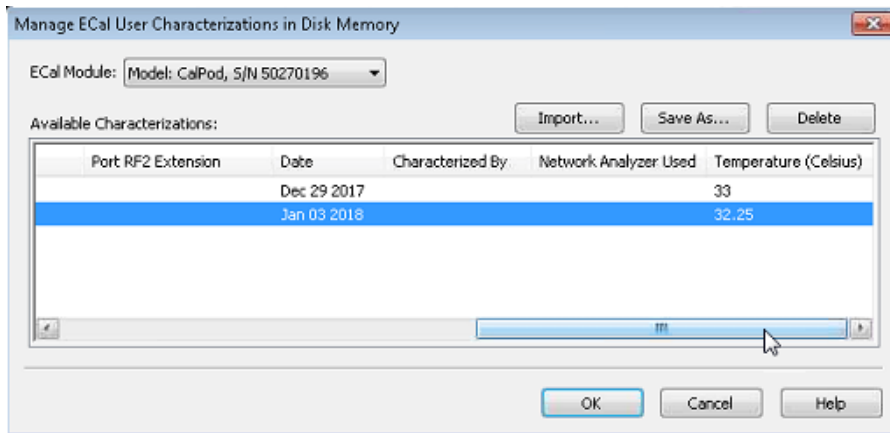

This dialog allows you to do either of the following:

- Save an existing User Characterization in disk memory to an *.euc file.
- Load a previously saved *.euc file for use on the analyzer with the specified ECal module.

[Learn more about User Characterizations stored to Disk Memory.](#)

ECal Module Select an ECal Module from the list for which User Characterizations are currently stored in disk memory.

Save As Saves a User Characterization that is currently in disk memory to a *.euc file. This file can be used as a backup in case the archive file is accidentally deleted, or allows you to move the file to another analyzer to be used with the selected ECal Module.

Import Loads a previously saved *.euc file for use on the analyzer with the specified ECal module.

Delete Removes a User Characterization from disk memory.

Note: If a temperature is shown in the **Temperature** column, then the temperature during characterization was measured and recorded. For VNA ports on which a CalPodAsECal user characterization is used during a calibration, the cal error terms for those ports in the CalSet will have been computed with compensation for temperature at the time of calibration if the following two conditions are true: 1) The user characterization must show a temperature value in the Temperature column in this dialog box, and 2) the CalPod must be a Thermal or TVAC CalPod whose factory temperature data has been installed on the VNA by the installer package that was provided with the CalPod.

Restore ECal Module Memory

When user-characterized data is written to the ECal module, the entire contents of ECal memory is also written to the disk memory, including the factory ECal data. In the unlikely event that your ECal

module memory is lost, you can restore all ECal data to ECal memory.

Caution: If a new factory cal was performed **after** the ECal memory was written to disk memory, the new factory cal data will also be overwritten.

Note: An ECal Data Wipe Utility destroys all user data per US DoD 5220.22-M. Learn more at <http://na.support.keysight.com/pna/apps/applications.htm>

How to Restore ECal Module Memory

Using **Hardkey/SoftTab/Softkey**

1. Press **Cal** > **Cal Sets & Cal Kits** > **ECal** > **Restore ECal Memory...**

No Programming commands are available for this feature.

Module to be restored dialog box help

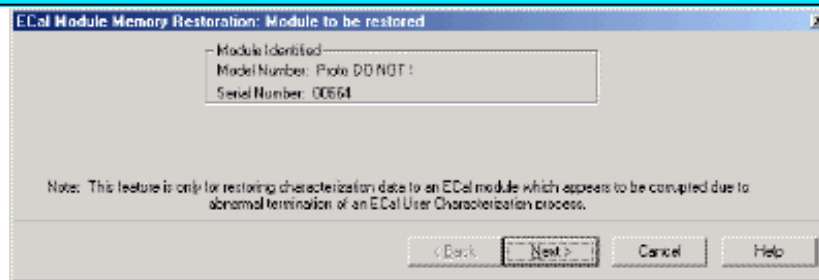

Verify the serial number of the module to be restored. If two modules are connected, choose the one to have data restored.

Next Click to write data to the module.

Perform a 4-Port Cal with One 2-Port ECal Module

You can perform a 4-port calibration with a 2-Port ECal Module. When all four DUT connectors are the same type and gender, the calibration can occur with only four connections, the same number of connections you would make with a 4-port ECal module.

- The ECal module must span the frequency range of the measurement.
- The ECal module must have connectors that match the DUT connectors. Because we are using a 2-port ECal module, this means that the DUT must have only TWO unique connector types and gender. When the DUT has more than two connector types/genders, you can select a different cal kit for each port using SmartCal.

Important Note: DO NOT connect/disconnect USB devices during ECal calibrations. Doing so may cause problems with the calibration.

Procedure

1. Connect the 2-port ECal module to a VNA USB port.
2. Press **Cal** > **Main** > **Other Cals** > **Smart Cal...**
3. Select **4 Port Cal**, then click **Next** to see the following dialog:

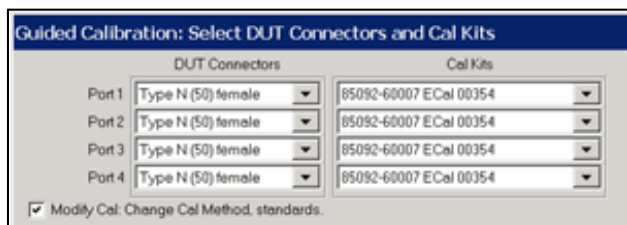

4. Select the DUT Connectors for each port. In this example, all four DUT connectors are Type N, female.
5. Select the attached ECal module. We are using a **85092-60007 ECal** module.
6. Select **Modify Cal (Show Advanced Settings for ECal)** then click **Next** to see the following dialog:

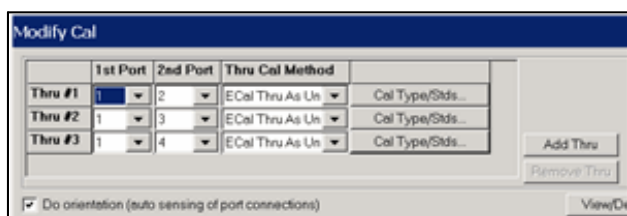

7. For the fewest number of physical connections, select the default port assignments.

- The **1st Port** selection for each port pair is 1.
 - For single-ended (standard) measurements, THREE is the minimum number of Thru connections. For Balanced measurements, FOUR Thru connections should be made. [Learn more](#).
 - For higher accuracy, select **Add Thru**. The Cal Wizard will add another port pair which results in more physical connections.
8. Select **ECal Thru as Unknown**. This is the most accurate and easiest Thru Cal Method. [Learn more](#).
 9. You may need to clear **Do Orientation** when calibrating at low power levels. [Learn more](#). This will add additional connection steps.
 10. Follow the prompts to complete the calibration:
 1. Connect ECal to ports 1 and 2. Click **Measure**.
 2. Connect ECal to ports 1 and 3. Click **Measure**.
 3. Connect ECal to ports 1 and 4. Click **Measure**.
 11. At the **Specify Delay** dialogs, click **OK**. This is the measured delay for each of the Thru connections in the ECal module. [Learn more](#).
 12. Click either **Save As User Cal Set**, or **Finish**.
-

TRL Calibration

TRL (Thru, Reflect, Line) represents a **family** of calibration techniques that measure two transmission standards and one reflection standard to determine the 2-port 12-term error coefficients. For example, **TRM** (Thru, Reflect, Match), **LRL** (Line, Reflect, Line), **LRM** (Line, Reflect, Match) are all included in this family.

The traditional SOLT calibration measures one transmission standard (T) and three reflection standards (SOL) to determine the same error coefficients.

- [Why Perform a TRL Cal?](#)
- [The TRL Calibration Process](#)
- [TRL Cal Kits](#)
- [Cal Standards Used in TRL](#)
- [TRL with an External Test Set](#)

[See other Calibration Topics](#)

Why Perform a TRL Cal?

TRL calibration is extremely accurate, in most cases more accurate than an SOLT cal. However, very few calibration kits contain TRL standards. TRL Cal is most often performed when you require a high level of accuracy and do not have calibration standards in the same connector type as your DUT. This is usually the case when using test fixtures, or making on-wafer measurements with probes. Therefore, in some cases you must construct and characterize standards in the same media type as your DUT configuration. It is easier to manufacture and characterize three TRL standards than the four SOLT standards.

Another advantage of TRL calibration is that the TRL standards need not be defined as completely and accurately as the SOLT standards. While SOLT standards are completely characterized and stored as the standard definition, TRL standards are modeled, and not completely characterized. However, TRL cal accuracy is directly proportional to the quality and repeatability of the TRL standards. Physical discontinuities, such as bends in the transmission lines and beads in coaxial structures, will degrade the TRL calibration. The connectors must be clean and allow repeatable connections.

To learn more about Cal Standard requirements, see [Cal Standards Used in TRL](#).

Note: Virtual Device describes a non-physical (connect the two test port reference planes together) type of connection description during the calibration. So, in a cal kit definition, you should **not** define more than one Thru standard with the same connector/gender pairing to each **Virtual Device**. This could cause those Thru standards to all be treated as the same physical connection step during a calibration, which would especially be a problem for TRL calibrations if a Thru standard and Line standard were measured as the same connection step.

The TRL Cal Process

Although TRL can be performed using the Cal Wizard Unguided Cal selection, the following process uses the easier **SmartCal** selection. Both selections require that you already have TRL calibration standards defined and included in a VNA cal kit.

1. Preset the VNA
2. Set up a measurement and the desired stimulus settings.
3. Press **Cal > Main > Other Cals > Smart Cal...**
4. **Select the DUT connectors and Cal Kit** for each port. The **LOWEST** port number of each **port pair** **MUST** include TRL standards. TRL appears as the Cal Method.
5. Check **Modify Cal, Next**, then **View/Modify** to change **default TRL options** if necessary.
6. Follow the prompts to complete the calibration.
7. **Check the accuracy** of the calibration

TRL Cal Kits

Keysight Technologies offers two cal kits that include the required standards to perform a TRL calibration: 85050C (APC 7mm) and 85052C (3.5mm). Both kits include the traditional Short, Open, and Load standards. (The Thru standard, not actually supplied, assumes a **zero-length Thru**). In addition, the kits include an airline which is used as the LINE standard. To use the airline, the kits include an airline body, center conductor, and insertion / extraction tools. The APC 7 kit includes an adapter to connect the airline to the APC connector.

Cal Standards Used in TRL

These standards must be defined in your TRL cal kit:

THRU

Note: All THRU calibration methods are supported in a TRL Cal EXCEPT Unknown Thru.

- The THRU standard can be either a zero-length or non-zero length. However, a zero-length THRU is more accurate because it has zero loss and no reflections, by definition.
- The THRU standard cannot be the same electrical length as the LINE standard.
- If the insertion phase and electrical length are well-defined, the THRU standard may be used to set the reference plane.
- Characteristic impedance of the THRU and LINE standards defines the reference impedance of the calibration.
- If a THRU standard with the correct connectors is NOT available, an adapter removal cal can be performed.

REFLECT

- The REFLECT standard can be anything with a high reflection, as long as it is the same when connected to both VNA ports.
- The actual magnitude of the reflection need not be known.
- The phase of the reflection standard must be known within 1/4 wavelength.
- If the magnitude and phase of the reflection standard are well-defined, the standard may be used to set the reference plane.

LINE

The LINE and THRU standards establish the reference impedance for the measurement after the calibration is completed. TRL calibration is limited by the following restrictions of the LINE standard:

- Must be of the same impedance and propagation constant as the THRU standard.
- The electrical length need only be specified within 1/4 wavelength.
- Cannot be the same length as the THRU standard.
- A TRL cal with broad frequency coverage requires multiple LINE standards. For example, a span from 2 GHz to 26 GHz requires two line standards.
- Must be an appropriate electrical length for the frequency range: at each frequency, the phase difference between the THRU and the LINE should be greater than 20 degrees and less than 160 degrees. This means in practice that a single LINE standard is only usable over an 8:1 frequency range (Frequency Span / Start Frequency). Therefore, for broad frequency coverage, multiple lines are required.
- At low frequencies, the LINE standard can become too long for practical use. The optimal length of the LINE

standard is 1/4 wavelength at the geometric mean of the frequency span (square root of $f_1 \times f_2$).

Note: The TRL LINE standard must have a delay that is greater than 0 (zero) ps. Otherwise, calibration correction calculations will contain unpredictable results.

MATCH

If the LINE standard of appropriate length or loss cannot be fabricated, a MATCH standard may be used instead of the LINE.

- The MATCH standard is a low-reflection termination connected to both Port 1 and Port 2.
- The MATCH standard may be defined as an infinite length transmission line OR as a 1-port low reflect termination, such as a load.
- When defined as an infinite length transmission line, both test ports must be terminated by a MATCH standard at the same time. When defined as a 1-port load standard, the loads are measured separately. The loads are assumed to have the same characteristics.
- The impedance of the MATCH standard becomes the reference impedance for the measurement. For best results, use the same load on both ports. The load may be defined using the data-based definition, the arbitrary impedance definition, or the fixed load definition.

See Also

- See [Modify Calibration Kits](#) for detailed information about creating and modifying Calibration kit definitions.
- For more information, read [Specifying Calibration Standards and Kits for Keysight Vector Network Analyzers \(Application Note 1287-11\)](#)

TRL with an External Test Set

Beginning with the VNA code revision 5.25, TRL CAN be performed with an External Test Set enabled. Previously, a TRL calibration required a VNA with a reference receiver for each test port. With the new TRL method, a Delta Match Calibration is first performed and applied.

Note: See Delta Match Calibration to learn which models require this.

The accuracy of this TRL cal greatly depends on the accuracy of the Delta Match Calibration. With an accurate Delta Match Calibration, the difference in accuracy between a traditional TRL cal and this TRL cal is negligible.

How to Perform a TRL Cal in these cases

1. Press **Cal** > **Main** > **Other Cals** > **Smart Cal...**
 2. Select a TRL cal kit for the ports to be calibrated.
 3. During the calibration, the Cal Wizard prompts you for a **valid Delta Match Cal**.
-

CalPod

Note: The M9485A/M980xA/P50xxA do not support this function.

CalPod is a system that simplifies the process of recalibrating the VNA without requiring the removal of the DUT or the physical connection of standards. This allows recalibration from a remote location such as when the DUT is in a temperature chamber.

Note: This feature is available to GCA , NF and standard (S-Parameter) channels.

In this topic:

- Overview
- How to start the CalPod dialog
- CalPod dialog
- CalPod Setup dialog
- CalPod Operational Check

See Also

CalPod as ECal

Other Calibration topics

Process Overview

Note: The following overview assumes the CalPod system has been installed and configured. See the **CalPod User's Guide** for installation instructions at: http://na.support.keysight.com/pna/calpod/calpod_ug_85523-90005.pdf.

The following process assumes a 2-port DUT connected to the VNA ports 1 and 2 through CalPod modules as follows:

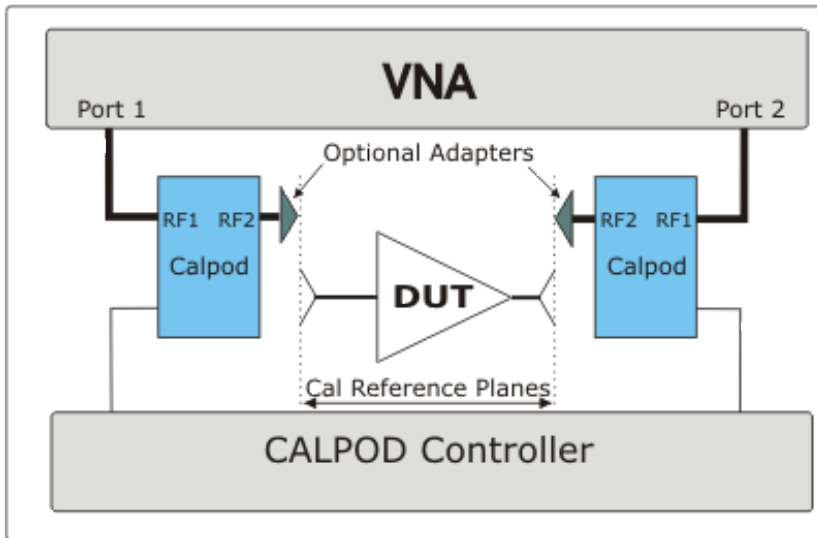

The Blue boxes represent CalPod modules with internal Thru, Short, Open, and Load states.

1. After configuring and assigning CalPod modules to VNA ports 1 and 2, connect the CalPod modules to the VNA, directly or using short cables. Learn how to configure CalPod.
2. Setup measurements on a channel. An IFBW of 1 kHz or lower with eight averages is recommended. CalPod does not support measurements below 100 MHz.
3. Perform a full 2-port calibration for the channel with the CalPod outputs as the reference plane.
4. Click **Initialize Channel** to automatically perform the following steps:
 - a. The OPEN, SHORT, AND LOAD states of both Calpod modules are switched in and S11/S22 are measured.
 - b. The resulting measurements are stored in the channel's Cal Set as additional standard measurements. These measurements are used to characterize the Calpod states - they are NOT used at this time to change the error correction.

Notes:

- Because the OPEN, SHORT, AND LOAD states in the CalPods are measured, it is not important what is connected to the CalPod when Initialize is pressed. Therefore, for highest accuracy, click Initialize IMMEDIATELY and ONLY ONCE after performing the calibration - before causing ANY cable movement.
- If an adapter is required to connect the DUT to a CalPod, use a high-quality adapter. Any temperature drift due to the adapter is NOT recorrected.
- Always connect the DUT as close as possible to the CalPod modules.

5. Connect the DUT to the CalPod outputs.
6. Click **Recorrect Channel** or **Recorrect All Channels** whenever necessary. Any of the following actions will cause the current calibration to become invalid and require recorection:
 - a. Moving the CalPod modules to the ends of long cables.
 - b. Changing the cables.
 - c. Extreme temperature variations.
 - d. Measurement drift over long time periods.
7. The following steps occur automatically during recorection for the active channel:
 - a. The OPEN, SHORT, AND LOAD states of both CalPod modules are switched in and S11/S22 are measured.
 - b. Additional (de-embedded) error terms are computed to compensate for changed conditions from the Initialize measurements.
 - c. Another Cal Set is created using the original name with the CalPod number appended. The modified error terms are saved to that Cal Set and applied to the channel. The measurements are now fully corrected.

How to start the CalPod dialog

Using **Hardkey** / **SoftTab** / **Softkey**

1. Press **Cal** > **Cal Sets & Cal Kits** > **Cal Pod...** .

Programming Commands

CalPod dialog box help

Learn all about the CalPod process.(Scroll up)

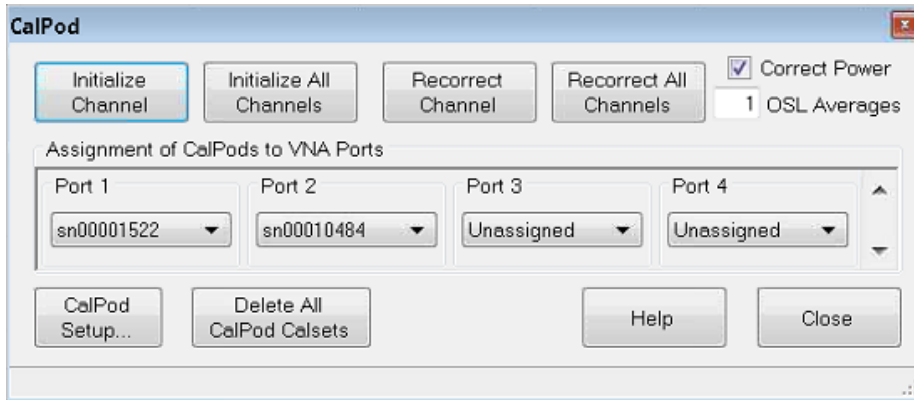

Initialize Channel Calibrated measurements of the CalPod states are performed as initial reference data points for the active channel.

Initialize All Channels Calibrated measurements of the CalPod states are performed as initial reference data points for all current channels. This command is not recommended, it is generally preferable to initialize each channel immediately following calibration.

Recorrect Channel Recorrects the active channel Cal Set to match the initial reference.

Recorrect All Channels Recorrects the Cal Sets on ALL channels that were initialized.

Correct Power

This checkbox causes power to be recorrected ONLY when source power correction data is stored as error terms in the CalSet. This occurs only when a Guided Power Cal is performed and when an app channel is calibrated such as a FCA, GCA, IMD, and Noise Figure channel. This checkbox has NO effect when a S-parameter Cal or a standard Source Power Cal has been performed, because source power correction data is not stored in the CalSet.

When any of the above power calcs have been performed, and when this box is checked, the power output at the VNA port is adjusted to compensate for any change in path loss when Recorrect is performed. For example, if the path loss between the VNA port and the CalPod was increased by two dB following initialization, then the VNA output power will be increased by two dB upon recorection. Do this when you add a significant amount of loss in the calibration path, or when the power level at the DUT is important.

When a significant amount of loss is introduced in the calibration path, it may not be possible to increase the source power enough to overcome the loss. In this case, an **Unleveled source** message may appear on the VNA screen.

When the checkbox is cleared, the source power level is not corrected.

OSL Averages Controls the number of sweeps worth of raw measurements to be measured and averaged together for the recorection computations for each state of each CalPod.

Assignment of CalPods to VNA Ports

For each VNA port, select a CalPod module.

Note: A CalPod can be assigned up to 16 test ports in each measurement channel in multiport PNA mode.

CalPod Setup Starts the CalPod Setup dialog

Delete All CalPod Cal Sets Deletes all recorection Cal Sets and reinstates the Initialization Cal Set.

CalPod Setup dialog box help

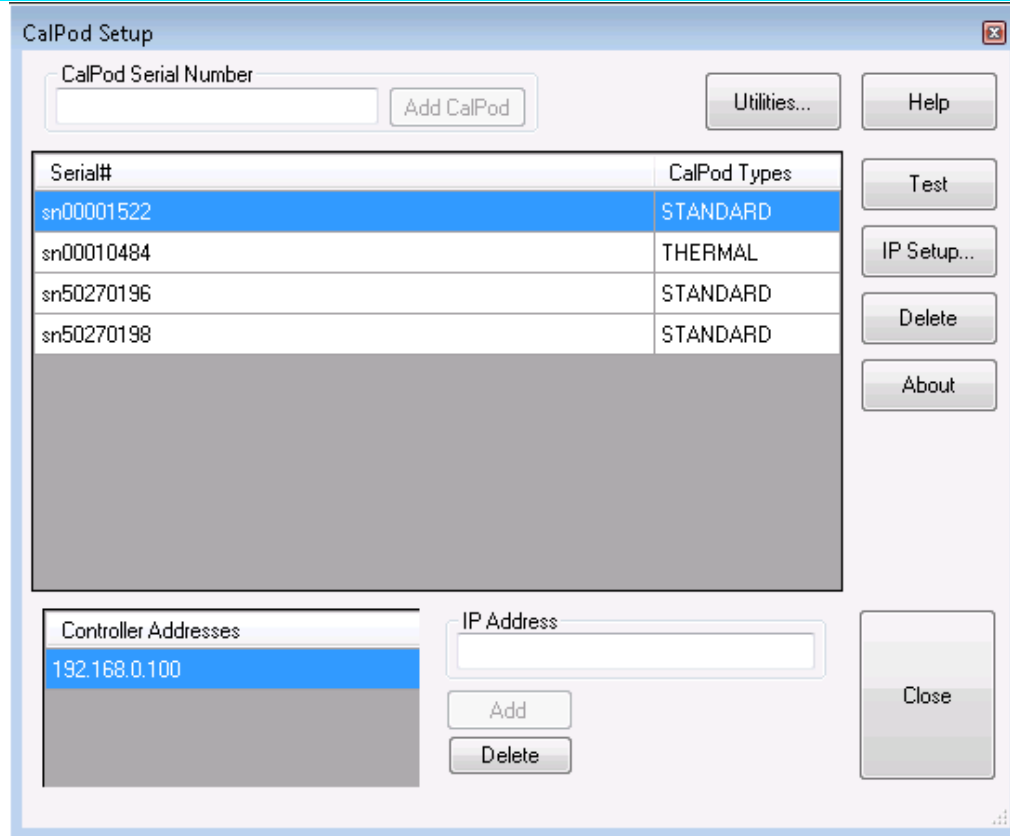

To start this dialog, click **CalPod Setup** in the CalPod dialog box.

CalPod Serial Number Type the CalPod module (without 'sn'), then click **Add CalPod**. The new module is added to the list of available CalPod modules.

Serial # and CalPod Types

Shows the list of available CalPod modules. A CalPod module type may be STANDARD or THERMAL (include temperature correction). A CalPod module will be listed as a STANDARD type unless the thermal characterization data was previously loaded into the PNA from the USB flash drive that came with the CalPod. Once thermal characterization data has been loaded into the PNA, the CalPod is automatically listed in the CalPod Setup dialog.

Note: Loading thermal characterization data from the USB flash drive is the only method of setting up a THERMAL CalPod. Simply entering the serial number in the CalPod Setup dialog will set the **CalPod Type** to be **STANDARD**.

STANDARD and THERMAL data files are stored in **C:\e-trak\adapters**.

Buttons

Utilities Launches the VNA CalPod Utilities used to configure the CalPod Controller and VNA over LAN.

Note: Before using a CalPod Controller, the LAN MUST be set up using the CalPod Utilities or an error message will be displayed indicating that the VNA is unable to communicate with the CalPod Controller.

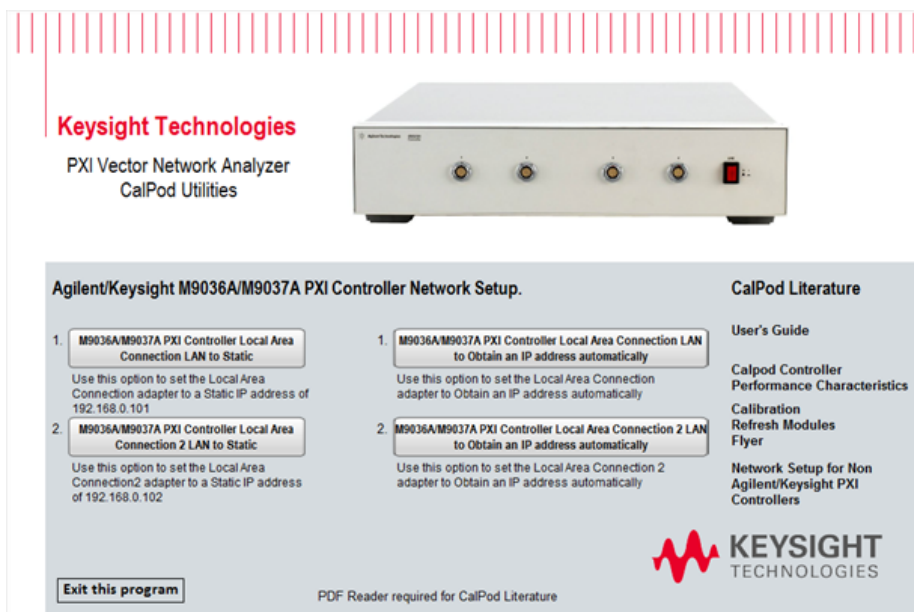

M9036A/M9037A PXI Controller Local Area Connection LAN to Static Sets the Local Area Connection adapter to a static IP address of 192.168.0.101.

M9036A/M9037A PXI Controller Local Area Connection 2 LAN to Static Sets the Local Area Connection 2 adapter to a static IP address of 192.168.0.102.

M9036A/M9037A PXI Controller Local Area Connection LAN to Obtain an IP address automatically Sets the Local Area Connection adapter to obtain an IP address automatically.

M9036A/M9037A PXI Controller Local Area Connection LAN to Obtain an IP address automatically Sets the Local Area Connection 2 adapter to obtain an IP address automatically.

Test Click to test the connection between the controller and the selected CalPod module. The message box displays the connection status and temperature for both Ambient and Thermal modules. Only the Thermal module will apply test temperature for recorection.

IP Setup Starts the IPSetup dialog box to confirm the CalPod controller settings.

Delete Removes the selected STANDARD CalPod module from the list.

To delete a THERMAL CalPod from the list:

1. Navigate to the c:/e-trak/adapters/itm directory.
2. Delete the .xml file associated with the CalPod serial number.
3. Exit all CalPod dialog boxes and restart the CalPod dialog.
4. The CalPod may now be removed using the **Delete** button.

About Shows the CalPod software version information.

Controller Addresses

Each controller can support 4 modules directly, and up to 48 modules using external splitters. Additional controllers may be required if more than 48 CalPod modules are needed.

IP Address Enter the IP Address of the Controller, then click **Add** . The IP address is configured using the IPSetup Utility. The default IP=192.168.0.100, but different static network settings can be configured if required.

Delete Select the Controller Address, then click **Delete** to remove the address from the list.

For more CalPod Setup information, see the CalPod web site:

<http://na.support.keysight.com/pna/calpod> . Click **CalPod Controller Configuration** .

CalPod Operator's Check

This program is provided as a convenience to help determine the operational status of each 855xxA Series CalPod and its associated CalPod Controller. While this check is not intended to be a complete test, it does check each unit enough to provide greater than 95% confidence that the CalPod is functioning properly.

- When the max frequency of the CalPod is higher than the max frequency of the VNA, the full frequency range of the CalPod is not tested.
- Up to four CalPod modules may be checked at once. All four devices must be of the same frequency range.
- The software revision for the Operator's Check code is displayed in the upper left-hand corner of the window

Before running Op Check

The CalPod system must be installed and configured on the VNA.

See the **CalPod User's Guide** for instructions at:

http://na.support.keysight.com/pna/calpod/calpod_ug_85523-90005.pdf

Required equipment:

- An appropriate ECal or mechanical Cal Kit.
- A high-quality cable.
- A female-female adapter of the calibration connector type.
- A fixed attenuator up to 10 dB (3 dB preferred) or other frequency insensitive device with similar loss.

How to perform CalPod Operators Check

Click **Utility**, then **System** , then **Service**, then **Verification** , then **Operator's Check** .

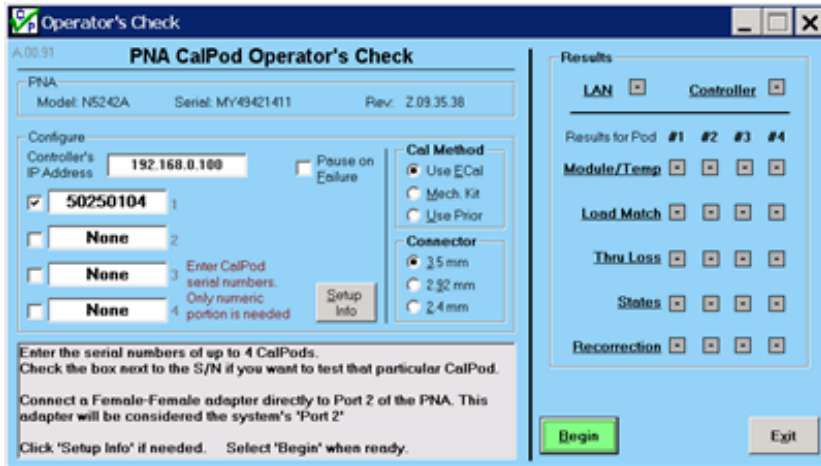

Click **Setup Info** to learn more about this dialog.

Also, click **Cal Method** or **Connector** for additional explanation for these areas.

Configure

1. Enter information in the “Configure” area.
2. Each time a 2-port cal is performed, the results are saved in a file. The “Use Prior” selection uses the saved calibration.
3. When the calibration connector type does not mate with the CalPod connectors, perform the calibration and then use adapters to connect to the CalPod module.
4. Click **Begin** to start the Op Check.
5. Follow the prompts in the gray box.

Op Check Results

- The Results area shows Op Check progress.
- Click a test label for test information.
- When the check has finished, the results are saved to a text file. The default path and filename is: C:/Program Files/Keysight/Network Analyzer/Service/calpodopchklog.txt. To save multiple results, rename the file or save it to a different location.
- For assistance in troubleshooting CalPod Operator's Check failures or for additional information, see the appropriate FAQ at the CalPod web site: <http://na.support.keysight.com/pna/calpod>

Calibration Preferences

Cal type preferences are set from this dialog.

How to change Cal Preferences

Programming commands are NOT available for the preference settings discussed in this topic, although there are other **Cal Preferences** that can be set remotely.

Using a mouse

1. Click **Response**
2. Select **Cal**
3. Select **Cal Sets & Cal Kits**
4. Select **Cal Preferences...**

Cal Type Preferences dialog box help

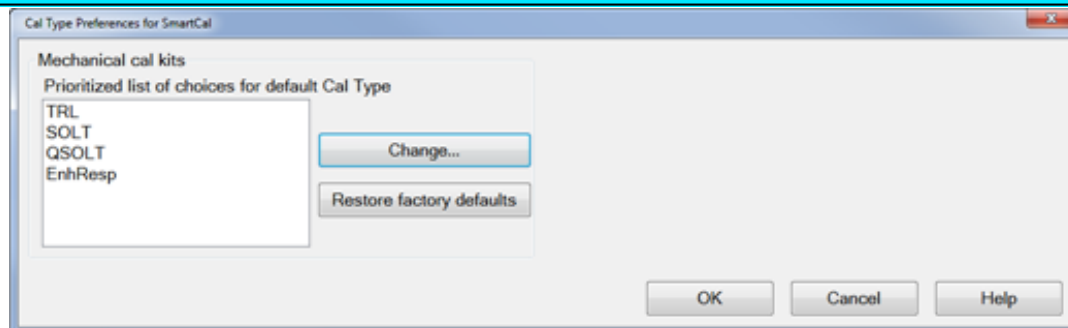

This dialog is used to set which Cal Types are available, and the order in which they are selected as the default choice, during a SmartCal with Mechanical Standards. This setting is also used to set the default Cal Type for Guided calibrations using SCPI or COM.

Note: Your Cal Type settings are saved only until the NA application is closed. When re-opened, the factory default settings are restored.

The specified Cal Type order should allow you to make fewer changes to the Cal Type during a SmartCal with Mechanical Standards.

For example, in the above image, the first Cal Type on the list is TRL. When doing a SmartCal with Mechanical Standards:

- If a TRL Cal Kit is available for the specified DUT connectors, then TRL becomes the default Cal Type.
- If a TRL Cal Kit is NOT available, then the second Cal Type on the list (SOLT) is evaluated for compatibility with the available Cal Kits, and so forth with the Cal Types that remain on the list.
- If TRL is removed from the list, that Cal Type is NOT available for selection during a SmartCal with Mechanical Standards.

[Learn more about Cal Types.](#)

[See where you choose Cal Type during a SmartCal](#)

Prioritized list of choices for default Cal Type Shows the current list of Cal Types and the order in which they will be selected for Mechanical calibrations.

Change Click to invoke the [Modify list of default Cal Types](#) dialog.

Restore factory defaults Returns the list to the original selections and order. The factory defaults are in order of accuracy from highest (TRL) to lowest (QSOLT).

Cancel Closes the dialog without making changes.

Modify list of default Cal Types dialog box help

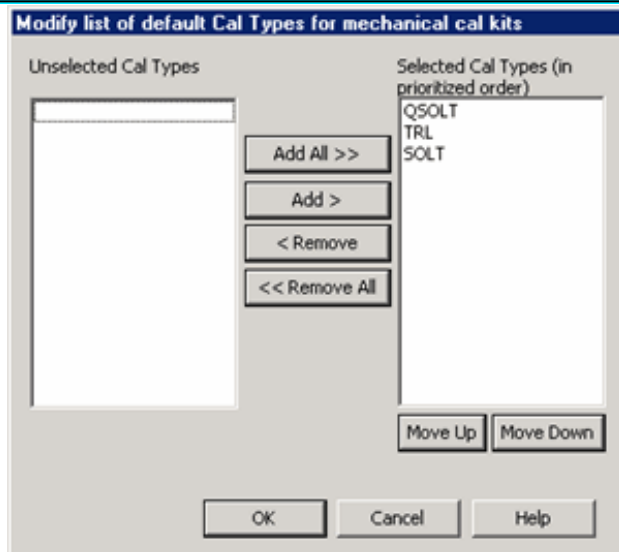

Use this dialog to Add, Remove, and re-order the available Cal Types. There must be at least ONE selected Cal Type to perform a SmartCal with Mechanical Standards.

Unselected Cal Types Cal Types in this list will not be presented as a choice during a Calibration.

Selected Cal Types Cal Types in this list will be presented, in order, as the default choice during a Calibration. Click a Cal Type to select it, then click the following buttons to perform that operation.

Add / Remove buttons Click to Add and Remove the selected Cal Types from the Selected Cal Types list.

Move Up / Down Click to re-order the Selected Cal Types list.

Cal Plane Manager (CPM)

Adapters, fixtures, and probes are often used for DUTs that have non-coaxial interfaces. This could make it difficult to calibrate with traditional cal standards. Cal Plane Manager (CPM) allows you to mathematically remove (de-embed), a characterized adapter, test fixture, or probe head from measurements.

In this topic:

- Features
- Using Cal Plan Manager
 - Cal Plane Manager
 - Characterize Adapter/Fixture and Apply
 - Calset Selection
 - Port Selection
 - Phase Pivot
 - Select Files
 - Apply De-embedding
 - Select Channels to De-embed
 - Select Calsets to De-embed
- Other Actions
 - Reverse Port Order
 - Create a Transmission Only S2P File
 - Cascade Two S2P Files
 - Cascade an ENR file with an S2P file

Other Cal Topics

Features

- Characterizes adapters and fixtures in SnP files.
- Applies the characterizations to existing Cal Sets and channels.
- Writes to VNA power loss table using the S2P files of fixtures/adapters.
- Reverses the port order of an existing S2P file.
- Creates a forward-only S2P file from an existing S2P file.
- Cascades two S2P files.

Important Notes

- **Adapter/fixture** definition: Any physical 2-port device or component that is to be mathematically removed from channel measurements or Cal Sets.
- The adapter/fixture to be characterized **MUST** be reciprocal ($S_{21} = S_{12}$).
- Two Tier-1 cals must be performed and saved to Cal Sets **BEFORE** performing the CPM characterization.

Using Cal Plan Manager

How to start Cal Plane Manager

Using **Hardkey** / **SoftTab** / **Softkey**

1. Press **Cal** > **Fixtures** > **Cal Plane Manager...** .

Using a mouse

1. Click **Response**
2. Select **Cal**
3. Select **Fixtures**
4. Select **Cal Plane Manager**

Choose from the following, then click **Next >** :

- **Characterize Adapter/Fixture and Apply** - Given that you have already performed calibrations both before and after the adapter/fixture, SNP files are generated which characterize the adapter/fixture. These files are then used to de-embed the fixture from the channel and a new calset. Learn how.
- **Apply Adapter/Fixture** - The *.SNP files are already saved. Use these files to de-embed the fixture from the channel and a new Cal Set.
- **Other Actions**

Characterize Adapter/Fixture and Apply dialog box help

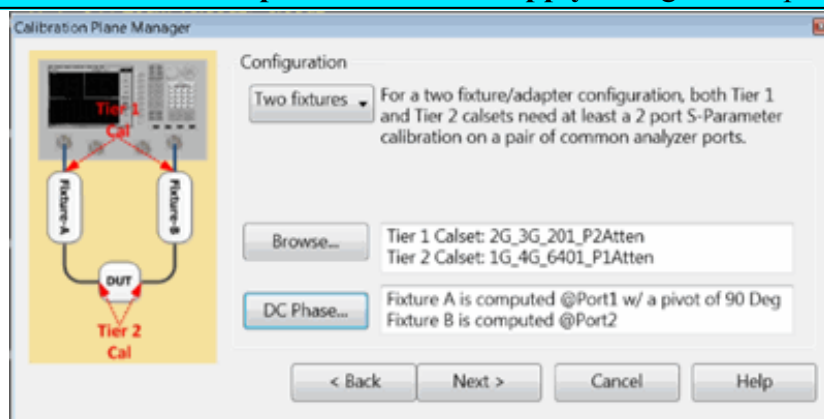

Requirements

- You must have already performed a Tier 1 calibration at the input of the fixture/adapter(s) AND a Tier 2 calibration at the output of the fixture/adapter(s) as in the above image.
- In addition, the calibrations must have been saved to Cal Sets on the analyzer.

Note: The mechanical switch / attenuator settings of the Tier 1 and Tier 2 cal for CPM MUST be the same settings. Also, when the span or number of points are different between the two cal tiers, there must be sufficient data points to ensure that phase wrapping does NOT occur. This is accomplished when the delta frequency for either calset is less than $12/\text{combined length of the test port cables in meters}$.

Applications

The following images show the calibration planes of the Tier 1 and Tier 2 calibrations:

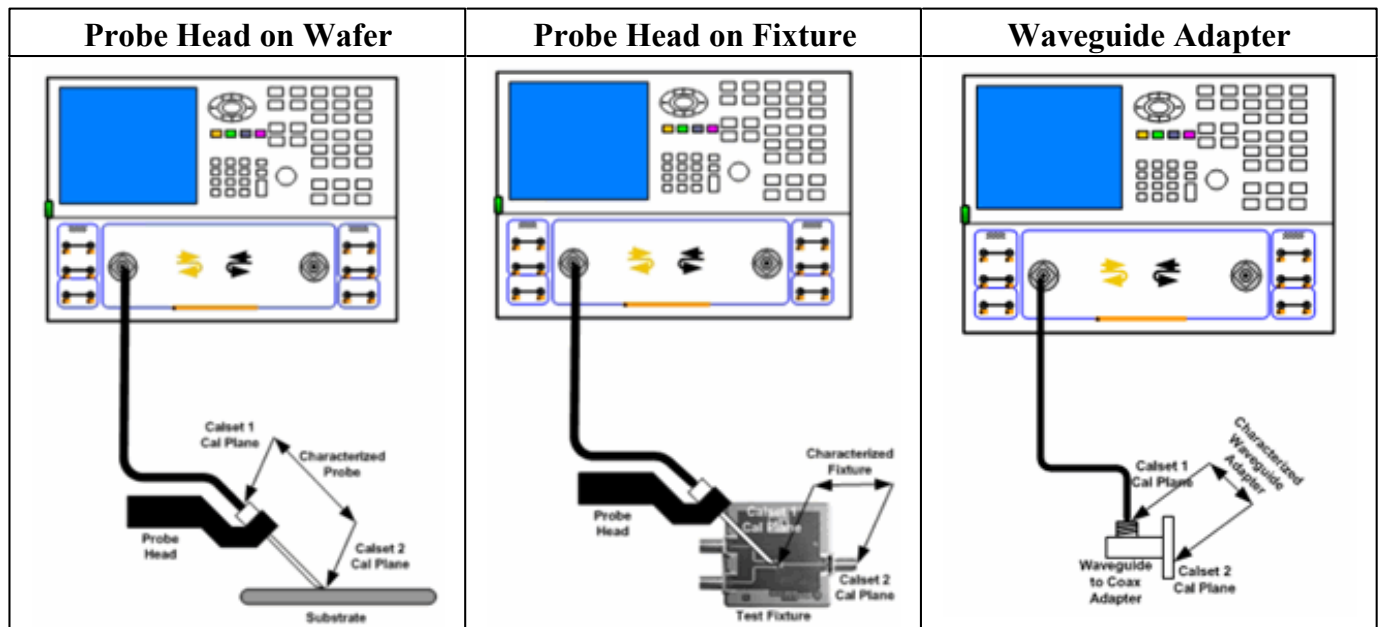

Procedure

Configuration Select the number of adapter/fixtures to be characterized and de-embedded.

- Choose **One fixture** when you have a single fixture/adapter on either the input or output of the DUT.
- Choose **Two fixtures** when you have a fixture/adapter on BOTH the input AND output of the DUT.

Browse - Starts the following Calset Selection dialog.

DC Phase - Starts the Phase Pivot dialog .

Click **Next** >

Calset Selection dialog box help

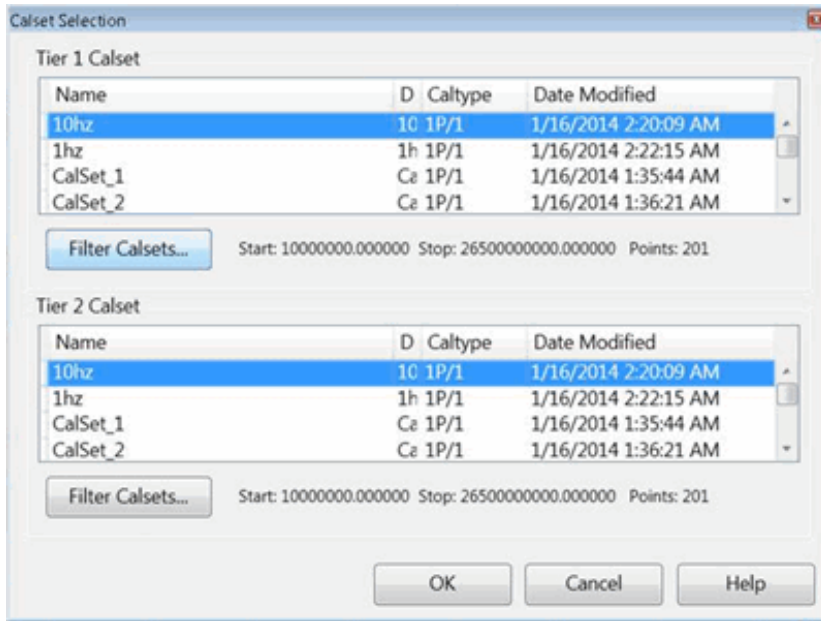

Choose from the listed Cal Sets on the analyzer to use for the Tier 1 and Tier 2 calibrations.

- The Tier-1 calset MUST be from a calibration that was performed at the input to the adapter/fixture.
- The Tier-2 calset MUST be from a calibration that was performed at the DUT reference plane.

Click **Filter Calsets** to start the following dialog.

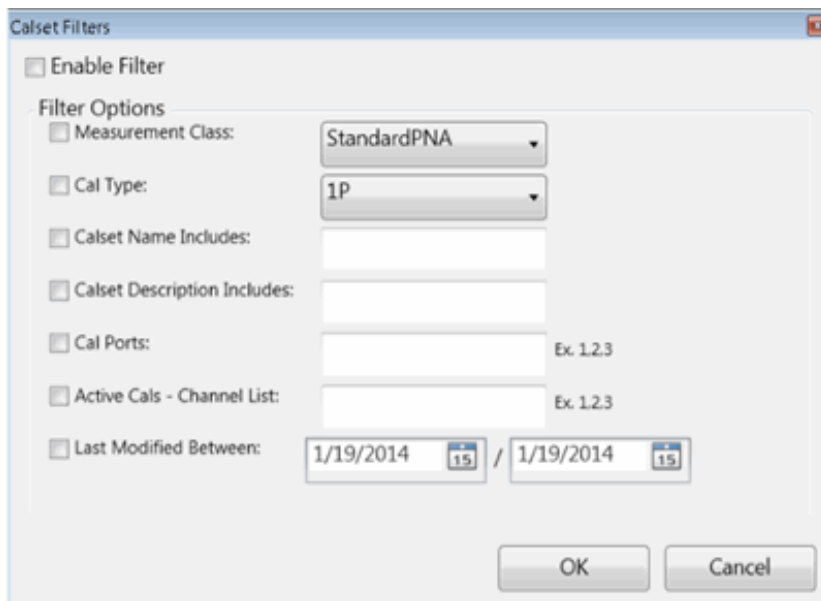

Check **Enable Filter**, then provide advanced filter requirements to narrow the search for appropriate Cal Sets.

Filter Options

Measurement Class - The classes listed are those that are enabled on the analyzer.

Cal Type - Filter for 1P (one-port) or 2P (two-port) Cal Sets.

Calset Name Includes - Filter to include any text that appears in the calset name.

Calset Description Includes - Filter to include any text that appears in the calset description.

Cal Ports - Filter to include only the analyzer ports to be de-embedded.

Active Cals - Filter to include only the Cal Sets that are currently in use on the analyzer.

Last Modified Between - Filter to include only the Cal Sets that were last modified between the two specified dates.

Port Selection dialog box help

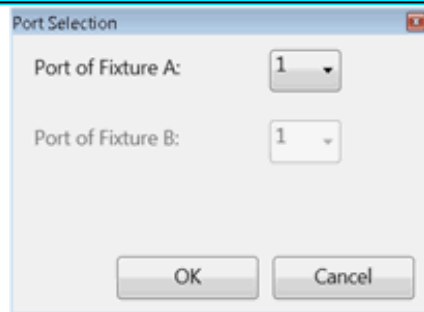

In the previous dialog, when a multiport calset is selected for a characterization that involves fewer ports, then select the port in the calset that is used to characterize the fixture/adaptor.

Phase Pivot dialog box help

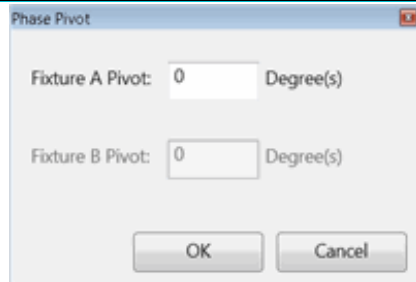

For most devices, the projected phase of S21 at DC crosses the X-axis between 0° and -180°.

The phase pivot point specifies the center of the phase window. It is normally 1 Pi wide. The default value of 0° should be adequate for the majority of adapters.

However, when characterizing electrically long cables, cables with significant mismatch, or high noise in the measurements, it is possible that the projection of phase goes above 0°. This results in a 180° phase difference between the results computed by CPM versus the results you might get by measuring the same adapter with a 2-port calibration.

In these cases, you may have to change the default value to capture the projected phase of S21 at DC.

Select Files dialog box help

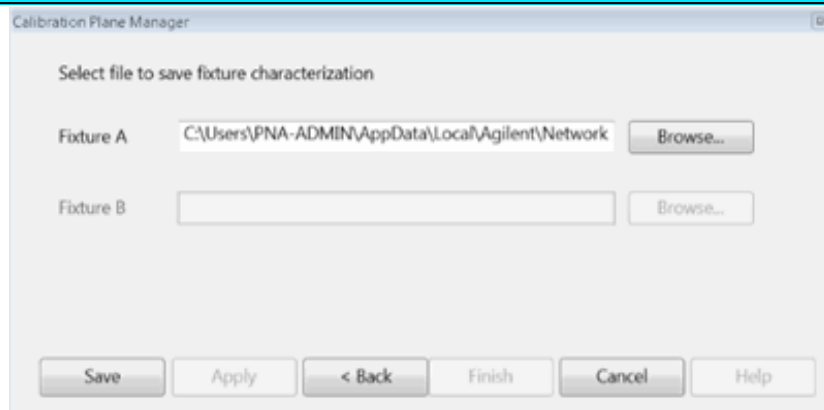

For each Fixture (A and B):

- Click **Browse** , then navigate to the folder to where the S2P files are to be saved.
- Enter a filename, then click **S2P Format** , then choose the format in which the data is to be saved:

- Log Magnitude & Angle (default)
- Lin Magnitude & Angle
- Real & Imaginary

Click **Apply** to continue to de-embed the fixture.

Click **Finish** to end with the characterization and close the dialog.

Apply De-embedding dialog box help

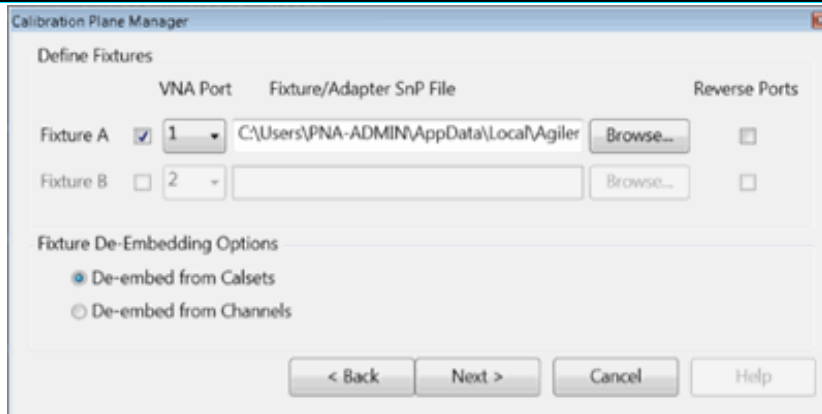

Given one S2P file for each fixture/adaptor, this dialog will remove the effects of the fixture/adaptor from either:

- one or more Calsets
- or one or more channels.

For each Fixture (A and B)

1. Check to enable fixturing.
2. Select the VNA port the fixture is connected to.
3. Click **Browse** , then navigate to the S2P file that represents the fixture/adaptor.
4. **Reverse Ports** - S2P files that are created using CPM ALWAYS reference port 1 of the fixture/adaptor on the side closest to the analyzer and port 2 of the fixture/adaptor ALWAYS on the DUT side of the device as in the following image. The application of the S2P file (this dialog) assumes this same orientation. If your S2P files were created using a different (external) application, check the orientation and check **Reverse Port Order** if necessary.

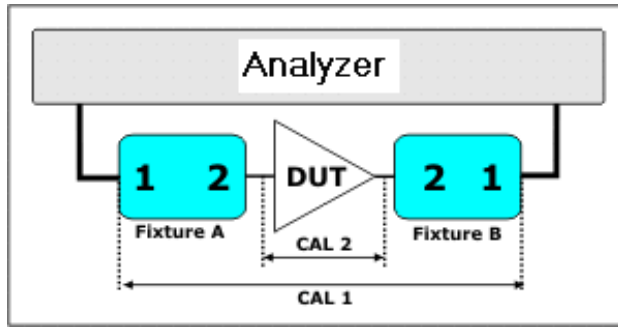

5. Choose one of the following De-embed Options

- **De-embed from Calsets** - Starts the Select Calsets to De-embed dialog box.
- **De-embed from Channels** - Starts the following Select Channels to De-embed dialog.

Select Channels to De-embed dialog box help

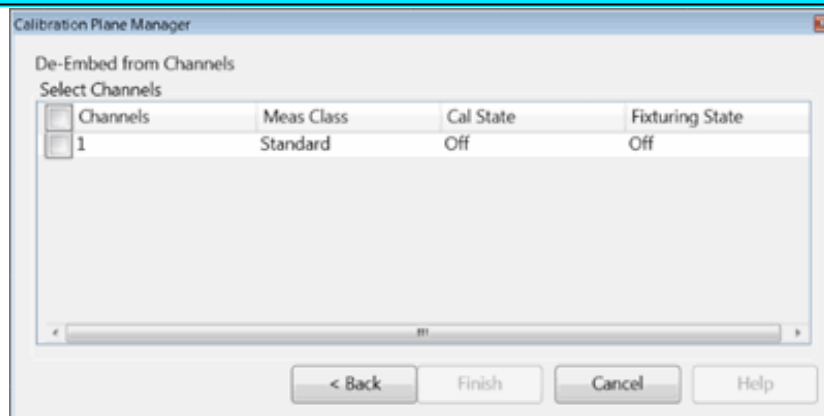

De-embedding is performed and applied to specified channels on the analyzer.

Select one more channels currently displayed on the analyzer from which to de-embed the adapter/fixture.

Select Calsets to De-embed dialog box help

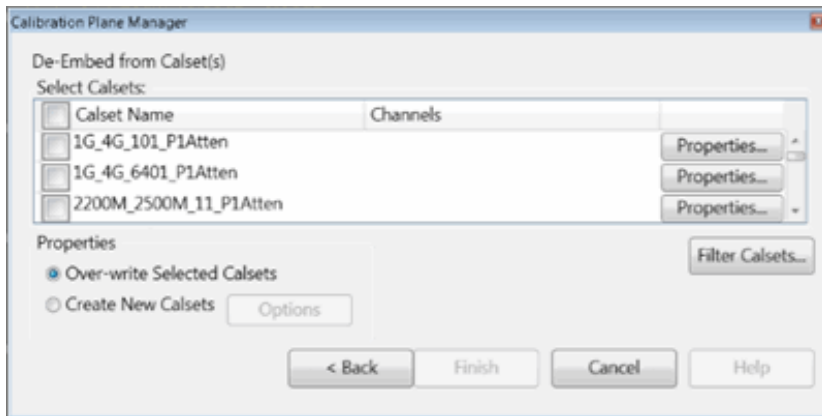

This dialog appears when **De-embed from Calsets** is selected in the previous dialog.

De-embedding is performed and applied to specified Cal Sets. This allows you to easily apply de-embedding in the future by simply applying the de-embedded calset to any channel.

Select Calsets : Select the Cal Sets to which de-embedding will be applied.

Properties View information about the corresponding calset.

Properties

- **Overwrite Selected Calsets** - The selected Cal Sets are overwritten with the adapter/fixture de-embedded.
- **Create New Calsets** - Select the Cal Sets from which new Cal Sets will be created.

Click **Options** to start the following dialog.

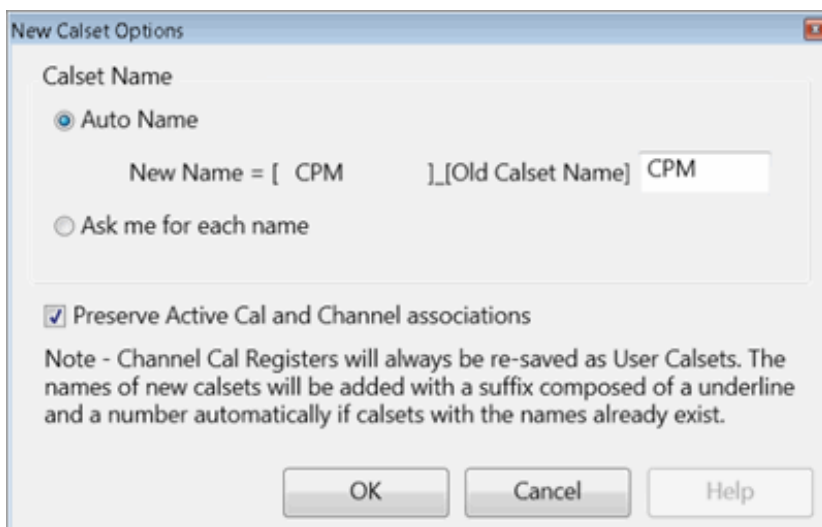

Calset Name

Auto Name - By default, a new calset will be created using the old calset name with the specified text ("CPM" by default) appended to the beginning of the name. You can change the specified text.

Ask me for each name - Starts the following dialog when **OK** is pressed.

Preserve Active Cal and Channel associations - When checked (default) the new de-embedded Cal Sets will be used to correct the same displayed channels as the current Cal Sets.

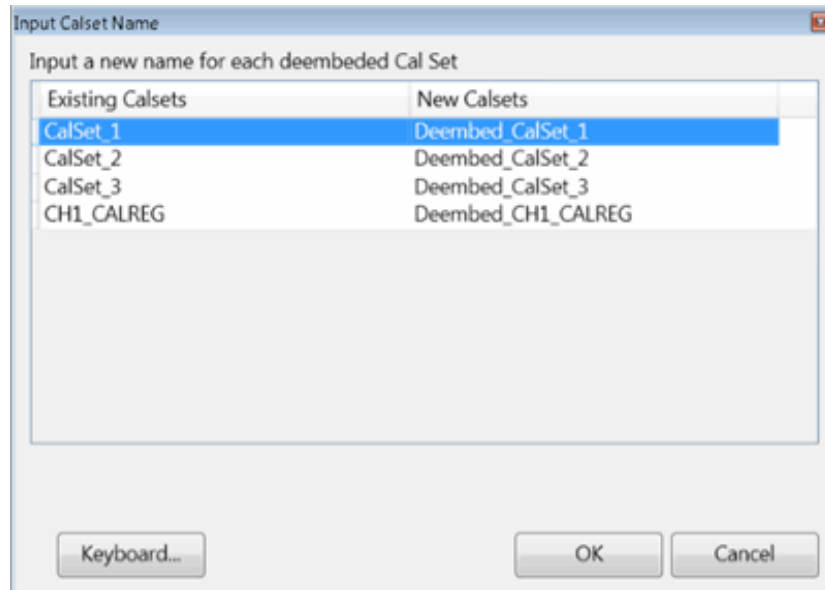

The Existing Calsets that you selected for de-embedding appear in the left column.

The proposed New Calset names appear in the right column.

To change the new Calset name, select, then edit the name.

When finished, click **OK** .

Other Actions dialog box help

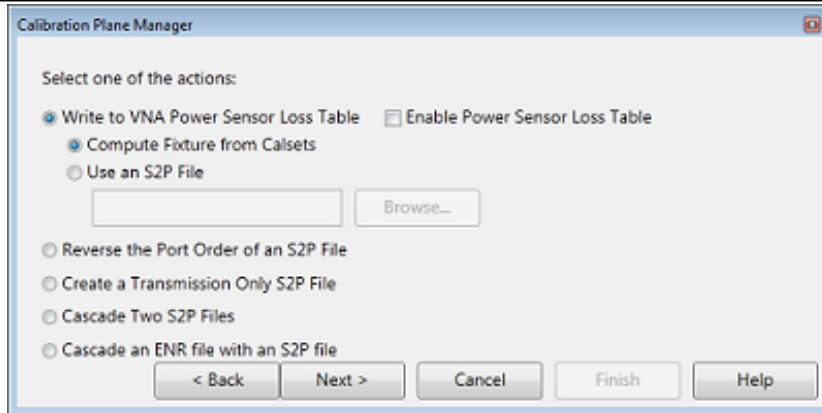

Select one of the actions:

- Reverse the Port Order of an S2P File .
- Create a Transmission Only S2P File.
- Cascade two S2P files .
- Cascade an ENR file with an S2P file

Write to VNA power sensor loss table . Loads the S2P Frequency / Loss pairs into the VNA Power Loss Compensation table to compensate for losses that occur when using the device to connect a power sensor to the measurement port during a Source Power Cal.

- **Enable Power Sensor Loss Table**
- Then choose from the following:
 - **Compute fixture from Calsets** . Computes the transmission loss of the fixture based on the selected Cal Sets. This choice is NOT available until two valid Cal Sets are selected.
 - **Use an S2P file** . Uses the S21 data in an existing S2P file to build the VNA's power loss table. Select, then click **Browse** , then navigate to the S2P file, then click **Next >** .

Note: In the VNA Power Loss Compensation table, loss is expressed as a positive number. CPM assumes that any negative S21 value in the S2P file is a loss and therefore multiplies the S21 values in the file by -1 to express that value as a positive number. This ensures proper handling of the offset during a source power cal.

Reverse Port Order dialog box help

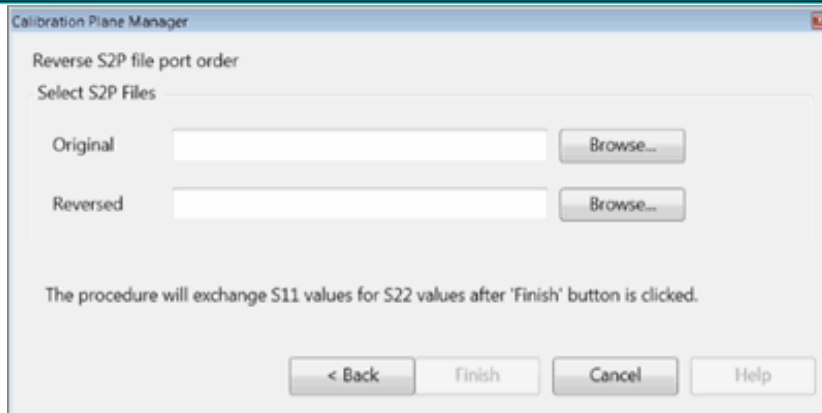

S2P files that are created using CPM ALWAYS reference port 1 of the fixture/adaptor on the side closest to the analyzer and port 2 of the fixture/adaptor ALWAYS on the DUT side of the device as in the following image.

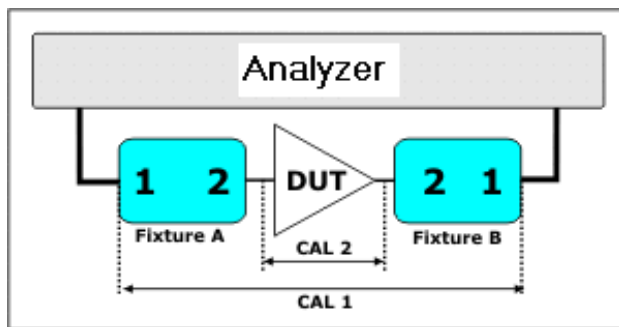

This action causes ports to be reversed on an existing S2P file.

- The data for S11 becomes the data for S22 and vice versa.
- The data for S21 becomes the data for S12 and vice versa.

The resulting file is written in the standard S2P file format.

1. **Original** - Navigate to the S2P file to be reversed.
2. **Reversed** - Navigate to the folder where the new reversed S2P file will be saved. Enter a filename. By default, the file is saved to the same folder using the filename: <old filename>_Reversed.s2p
3. Click **Finish**. The Reversed file is saved to the specified location.

Create a Transmission Only S2P File dialog box help

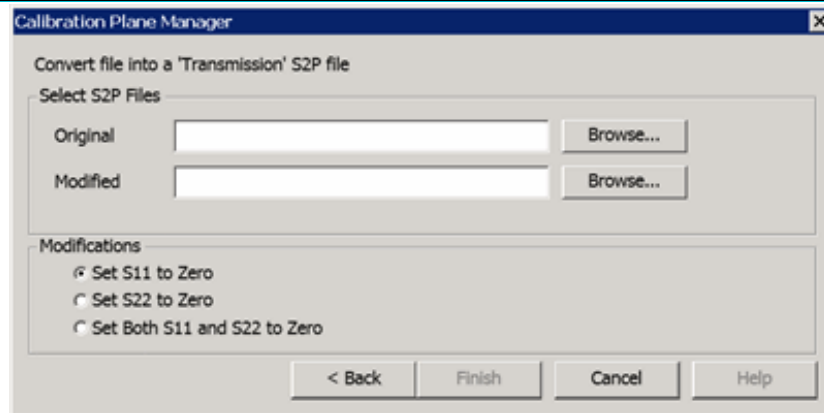

From an existing S2P file, this feature allows you to zero the S11, S22, or both data columns. The original S21 and S12 data are preserved. This is useful for Enhanced Response calibration / de-embedding.

Original - Click **Browse** , then navigate to the file to be modified.

Modified - Click **Browse** , then navigate to the folder and enter or change the filename of the resulting S2P file. The file select dialog allows you to change the format of the data. Click **Format** , then choose from the following:

- Log Magnitude & Angle (default)
- Lin Magnitude & Angle
- Real & Imaginary

Modifications

Choose to Zero the S11, S22, or both data columns.

Click **Finish**. The transmission only file is saved to the specified location.

Cascade Two S2P Files dialog box help

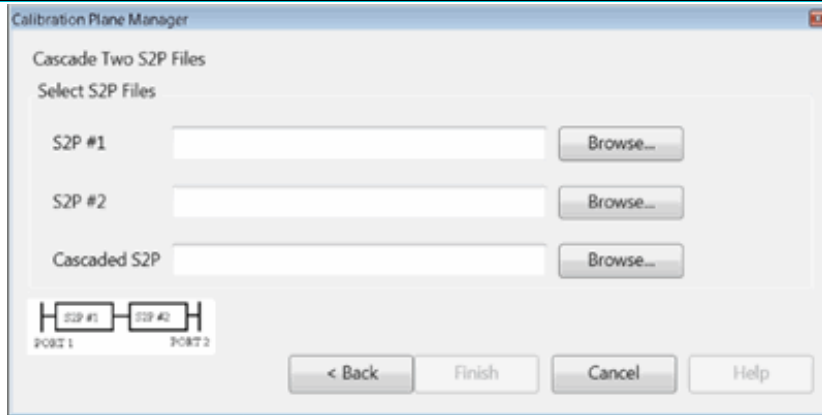

This dialog combines the losses and phase shift of two S2P files into a single S2P file.

The stimulus settings of the two input S2P files need not be identical. The frequency range of the cascaded S2P file will be the frequency range that is common between the two input files. In addition, the cascaded S2P file will use the data points of the input file with the denser data points.

For example:

S2P #1: Frequency range = 1 GHz to 5 GHz; 201 pts.

S2P #2: Frequency range = 2 GHz to 6 GHz; 1001 pts.

Cascaded S2P: Frequency range = 2 GHz to 5 GHz using the data points of S2P #2.

S2P #1 - Click **Browse** , then navigate to one of the S2P files to be cascaded.

S2P #2 - Click **Browse** , then navigate to the other S2P file to be cascaded.

Cascaded S2P - Click **Browse** , then navigate to a folder and enter the filename of the resulting S2P file.

Click **Finish** . The cascaded file is saved to the specified location.

Cascade ENR Files dialog box help

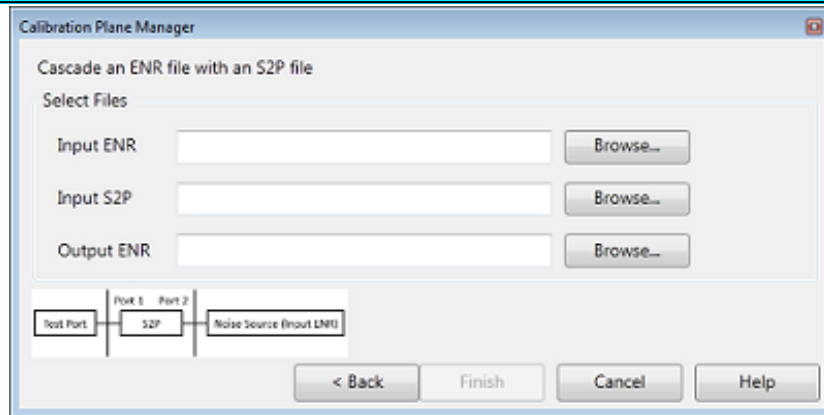

This dialog generates a new ENR file by embedding an adapter to an existing ENR file.

Input ENR - Click **Browse** , then navigate to ENR files to be cascaded.

Input S2P - Click **Browse** , then navigate to the S2P file to be cascaded.

Output ENR - Click **Browse** , then navigate to a folder and enter the filename of the resulting ENR file.

Click **Finish** . The cascaded file is saved to the specified location.

Port Subset Correction (Devolve Calibration)

It is often convenient to calibrate all the ports of the instrument so that corrected data is available at every port. However, applying the resulting calset results in every port being swept. This level of correction is appropriate if every port is connected to the DUT. However, sweeping ports that are disconnected unnecessarily slows down measurement throughput. To remedy this situation, the user can tell the instrument to exclude selected ports from the correction process. This is called "port sub-setting" or "devolve calibration". This process does not modify the calset in any way. There are two settings associated with port sub-setting: an on/off state, and the list of ports that should be included in the correction for the channel.

Port sub-setting values are independent of calset selection. They are essentially a mask that is applied to the calset.

Restricting correction to Enabled Ports

For example, on a 4 port instrument, the user is measuring two DUTs. Device #1 is connected to ports 1 and 2. Device #2 is connected to ports 3 and 4. The two devices are not interconnected in any way. Channel 1 is used to measure device #1. Channel 2 is used to measure device #2. If you apply a 4 port calset to each of these channels, both channels will sweep all 4 ports. Port sub-setting can be used to reduce the level of the correction for each channel.

Channel	Port subset values	Measurements	Correction applied
Channel 1	ON, ports 1 and 2 enabled	S11, S21, S12, S22	Full 2 Port (1,2)
Channel 2	ON, ports 3 and 4 enabled	S33, S43, S34, S44	Full 2 Port (3,4)

In this condition, when the user performs a 4 port calibration and applies the same user calset to both channels. Channel 1 sweeps ports 1 and 2. Channel 2 sweeps ports 3 and 4.

Best Effort on Disabled Ports

If measurements are added to the channel that utilize ports that are disabled in port sub-setting, those measurements will be corrected on a "best effort" basis: some correction may be applied depending on the contents of the calset. The level of correction is limited to enhanced response calibration or simple response calibration.

Channel	Port subset values	Measurements	Correction applied
Channel 1	ON, ports 1 and 2 enabled	S11, S21, S12, S22 S43	Full 2 Port (1,2) Enhanced Response(4,3)
Channel 2	ON, ports 3 and 4 enabled	S33, S43, S34, S44 S11	Full 2P(3,4) 1 Port (1)

This "best effort" correction cannot be turned off using the dialog. But there are SCPI commands for disabling this feature.

See [SENS:CORR:METH:PORT:SUBS:FULL:VAL](#) and [SENS:CORR:METH:PORT:SUBS:RESP:VAL](#).

Click [Cal](#) > [Main](#) > [Correction Methods....](#)

Correction Methods dialog box help

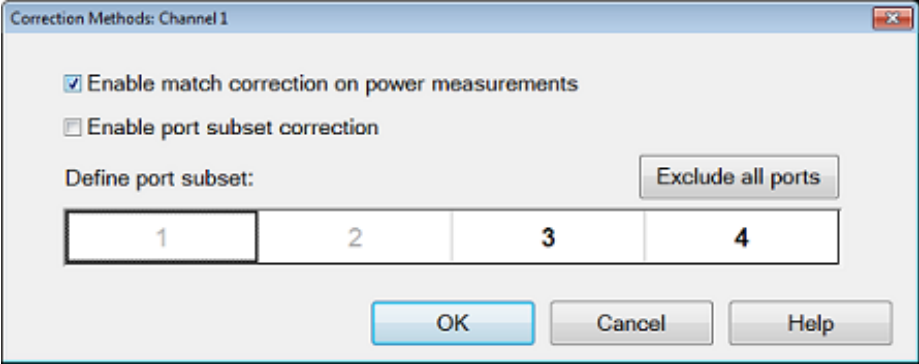

Enabling match correction on power measurement Apply match correction on all receivers used on this channel. See [Matching](#)

Enable port subset correction Enabling port subset correction to reduce the number of corrected ports.

Define port subset Selects which ports should be included in a full N-port correction. Un-selected ports will be corrected on a “best effort” basis: In other words, these ports will be corrected with an enhanced response calibration if the error terms are available in the calset.

Exclude all ports Excludes all ports from correction. The button will change to **Select all ports** to include all ports for correction.

The correction pop up pane, accessed from the status bar, indicates port by port correction methods for VNA with 12 or less test ports. This table is updated when the port subset correction is turned on to reflect the correction methods being applied. In the image below, the pane indicates a full 4 Port calibration. On the right, the table indicates the methods after the correction was devolved to ports 1,2,3.

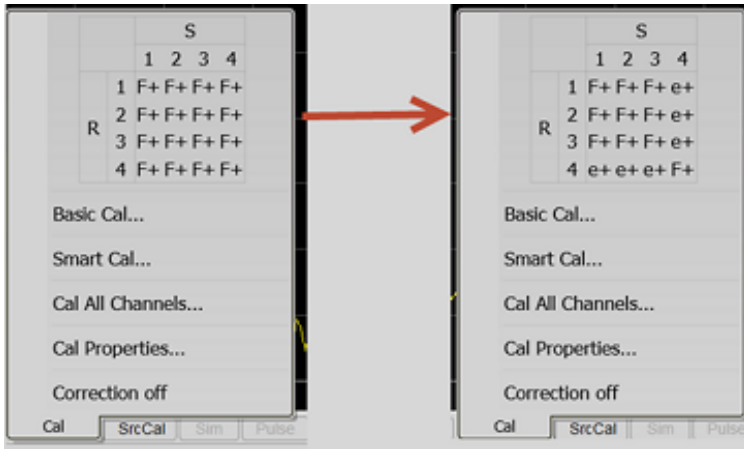

Power Calibration

Note: It is recommended that [SmartCal](#) be used instead of the following Power Calibration procedures. The procedures in this topic are for those who cannot change their existing test program/procedure with their installed-base PNAs.

Note: Source and Receiver Power Calibrations are NOT available in M937xA/P937xA PXI.

Source and Receiver Power Calibrations work together to provide very accurate power levels from the source, and very accurate power measurements from the VNA receivers.

- [Source Power Calibration Overview](#)
- [Supported Power Meters and Sensors](#)
- [How to perform Source Power Calibration](#)
- [Setup](#)
- [Source Power Cal dialog](#)
 - [Source Power Calibration Options dialog](#)
 - [Power Meter Settings dialog](#)
 - [Power Loss Compensation dialog](#)
 - [Power Sensor Settings dialog \(Zero / Calibrate\)](#)
- [Copy a Source Power Calibration to other Channels](#)
- [Saving a Source Power Calibration](#)
- [Reducing Time to Complete a Source Power Calibration](#)
- [Receiver Power Calibration](#)
- [Saving Receiver Cals](#)

Other Source Power Cal choices

- **Guided Power Cal** can be performed during an S-parameter Guided Calibration. [Learn more.](#)
- **Receiver Leveling** can be used to provide 'real-time' source power cal. [Learn more.](#)

- **See Also:** [Configure an Power Meter As a Receiver \(PMAR\)](#)

See other Calibration Topics

Source Power Calibration Overview

Note: Source and Receiver Power Calibrations are NOT available in M937xA PXI.

Perform Source Power Calibration when you need accurate power levels at some point in the measurement path between the VNA test ports. For example, you need to characterize the gain of an amplifier across a frequency range at a specified input power. You would perform a source power cal at the input of the amplifier to ensure the **exact** power level into the amplifier across the frequency range.

Using a Source Power Cal, you can expect the power at the point of calibration to be within the range of the uncertainty of the power meter and sensor that is used.

Source Power Calibration...

- Is independent of measurement type. It corrects the VNA source regardless of which receivers are being used in a measurement. Therefore, it can be used with both **ratio or non-ratio measurements**.
- Applies **ONLY** to those measurements on the selected channel that use the test port that was **specified as the Source** for the calibration. For example, if you specify Channel 1 and Port 1 as the source to be calibrated, only those measurements on channel 1 that use port 1 as the source will be corrected.
- Can be used in conjunction with other measurement calibrations, such as a full 2-port calibration. For highest accuracy, perform the measurement calibration **AFTER** the source calibration.
- Can be used with **Power Sweep** type. Source Power Cal will correct the power at all power levels across the power sweep.
- Can be used with **Port Power Uncoupled**.
- Forces **sweep mode to Stepped** on measurements with source power correction turned ON.
- Beginning with VNA Rev. 7.50, an external source can be calibrated using Source Power Cal.

Overview of How it works:

See Important First-time USB connection note.

[Click to see the detailed procedure](#)

1. Specify the measurement settings (frequency range, IFBW and so forth).

2. Start Source Power Calibration.

Note: When using an Keysight 848X power sensor (sensors that do NOT have built-in calibration factors), enter the Cal Factors using the **Power Sensor Settings** dialog, because the VNA instructs the power meter to NOT use the Cal Factor tables internal to the power meter.

3. Connect a power meter sensor to the point at which you want a known power level. This may be at the input or output of your device, or some other point between the test ports.
4. The VNA source is stepped through the specified frequency range, and power is measured with the power meter. At each data point, the source power is adjusted until the measured power is within your specified accuracy level.
5. When complete, the power meter is preset. The source power calibration can be **saved as part of the instrument state**.
6. The power meter is removed and the measurement path reconnected.
7. The calibration is automatically applied to the channel. All measurements on that channel using that source port benefit from the source power cal.
8. Perform an S-parameter calibration AFTER a Source Power Cal. The S-parameter cal is performed using the corrected stimulus power levels for the relevant ports.

Verify the source power calibration using the following procedure.

1. Connect the power meter as it was during the source power calibration.
2. Set the VNA to **Point Trigger** mode.
3. Trigger the VNA across the trace. Read about the behavior of the **sweep indicator**.
4. At each data point, the power meter should read the corrected power level within the specified tolerance.

Supported Power Meters and Sensors

See [Keysight's Power Meters and Sensors Webpage](#).

USB Power Sensors

- U848x Series USB Thermocouple Power Sensors (A.09.90.08 and later).
 - These include the following models: U8481A, U8485A, U8487A, U8488A, U8489A
 - External Calibration (connecting the sensor to the 1 mW ref port) is NOT supported.

- **IMPORTANT:** See <http://na.support.keysight.com/pna/pseriesmeter.html>
- U202x X-Series USB Peak and Average Power Sensors.
 - The VNA does NOT support peak mode in these sensors, but measures average power.
- U2000 Series USB Power Sensors.
- U204x X-Series USB and LAN Power Sensors.
- U205xXA/U206xXA Series USB Power Sensors.

USB Notes:

- From a standard power cal (this topic), only one USB power sensor can be used to cover the entire frequency span. To use multiple power sensors, perform a Guided Power Cal. [Learn how.](#)
- To select a USB power sensor for a standard power cal:
 1. Connect the sensor directly to one of the VNA USB ports.
 2. From the [Source Power Cal](#) dialog, click **Power Meter Config**.
 3. On the [Power Meter Settings](#) dialog, select **USB**.
- See Important First-time USB connection note.
- See note about [Zeroing USB Power Sensors](#).
- See also: [Power Meters as Receivers \(PMAR\)](#)

LAN Notes:

- LAN power sensors can only be controlled via LAN.
- Typical LAN ports found on a PC or Keysight instrument are used for data transfer and communication only and will not power up a U2049XA LAN Power Sensor.
- LAN power sensors must connect to a PoE port (Power over Ethernet), which will supply DC power required to power up the sensor and to transfer data.

- To select a LAN power sensor for a standard power cal:
 1. Connect the sensor to a PoE/LAN connection.
 2. From the **Source Power Cal** dialog, click **Power Meter Config**.
 3. On the **Power Meter Settings** dialog, select **LAN** and enter the host name of the power sensor.

Power Meters

- P Series power meters (N1911A and N1912A) and all supported sensors.
- EPM Series power meters (N1913A and N1914A) and all supported sensors.
- EPM-P Series power meters (E4416A and E4417A) and all supported sensors.
- E Series power meters (E4418 and E4419) and all supported sensors.

Power Meter Notes:

- N1911A, 12A, 13A, and 14A power meters have a **device-side USB connector**  and are controlled by the VNA exactly like a USB sensor. See **USB Power Sensors** (above). Although these meters may also have a front-panel USB port, USB power sensors must be connected directly to one of the VNA USB ports.
- Source Power Calibration operates slowly with the Keysight E930x and E932x power sensors.
- Some Keysight power meters have a mode that emulates the command set of the 437B or 438A power meter. The VNA does NOT support this emulation mode.
- The 82357A USB/GPIB Interface can be used to control power meters.
- [Create a Custom Power Meter Driver](#) for use with other power meters.

Non-Keysight Power Sensors

- Rohde and Schwarz NRP-Z power sensors (limited support). [Learn how to install the drivers.](#)
- VDI PM5 power meter (limited support). [Learn how to install the driver and set up the power meter.](#)

How to perform Source Power Calibration

Note: Guided Power Cal can be performed during an S-parameter Guided Calibration. [Learn more.](#)

1. Setup your measurement (sweep type, frequency range, IFBW, and so forth). By default, a Source Power Cal is performed on the source port of the active measurement.
2. Connect coax cable, GPIB cable, and power sensors to the VNA as shown in graphic below.

This image does NOT apply to USB power sensors, which are connected directly to a VNA USB port.

See Important First-time USB connection note.

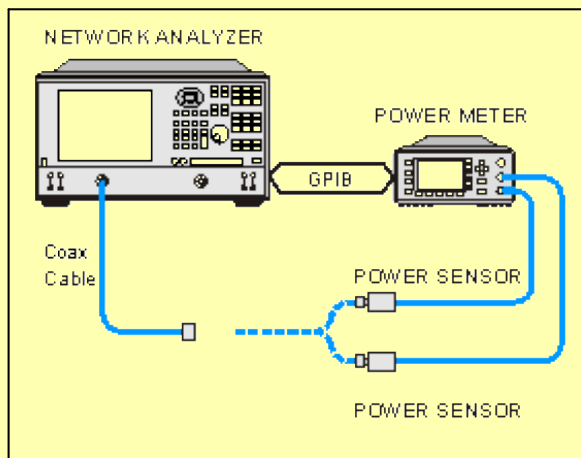

3. Apply power to the power meter and allow 30 minutes warm-up time before beginning calibration.
4. Select **Source Power Cal** as follows:

Using **Hardkey/SoftTab/Softkey**

1. Press **Cal** > **Main** > **Other Cals** > **Source Power Cal...**

◀ **Programming Commands** ▶

5. Complete the Source Power Cal dialog box (below), including **Options**, **Loss Compensation** and **Power Sensor Settings**, as needed.

Note: When using an Keysight 848X power sensor (sensors that do NOT have built-in calibration factors), enter the Cal Factors using the **Power Sensor Settings** dialog, because the VNA instructs the power meter to NOT use the Cal Factor tables internal to the power meter.

6. When complete, click **Take a Cal Sweep** in the Source Power Cal dialog box.
7. Follow the prompts to connect the sensors as required.
8. At this time you can change the Source Port setting and perform a Source Power Cal on a different port.
9. When calibration is finished, click **OK**. Correction is then applied and turned ON for the relevant ports on

the active channel.

10. Remove sensor.
11. **SrcPwrCal** is displayed in the status bar when Source Power Correction is applied to the Active Measurement.
12. Perform a S-parameter calibration, which would use the corrected stimulus power levels for the relevant ports.

To turn Source Power Correction OFF:

- On the **Calibration** menu, point to **Power Calibration**, then click **Source Power Correction on/OFF**.
- ONLY correction for the source port of the ACTIVE MEASUREMENT is turned OFF (regardless of **port power coupling setting**.)

Interpolation or Extrapolation

If the original stimulus settings are changed, Interpolation or EXTRAPOLATION is applied and **SrcPwrCal*** is displayed in the status bar. This is different from [measurement calibration interpolation](#). For example, if the frequency span is increased, the VNA will extrapolate new correction values rather than turn correction off. This is to protect your test device from being overpowered by the source. If the original settings are restored, then source power calibration returns to full correction.

Source Power Cal dialog box help

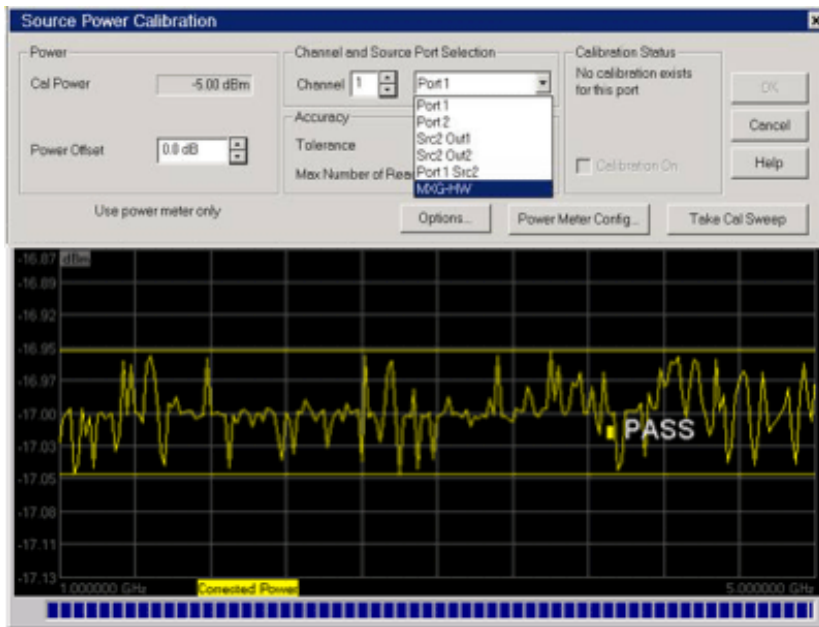

Note: Be sure that the frequency range of your power sensor covers the frequency range of your measurement. This does NOT occur automatically.

Power

Cal Power The calculated power (in dBm) at the calibration point. This value is the specified VNA source power plus the Power Offset value.

Power Offset Allows you to specify a gain or loss (in dB) to account for components you connect between the source and the reference plane of your measurement. These components will remain during a measurement. For example, specify 10 dB to account for a 10 dB amplifier in the path to your DUT. Following the calibration, the VNA power readouts are adjusted to this value.

To account for components that will be removed when the calibration is complete, use the [Loss Compensation table](#).

Channel and Port Selection

Channel Specifies the channel on which to perform the calibration. This setting defaults to the active channel.

Source Port Specifies the source port to be corrected. This setting defaults to the source port for the active measurement.

Note: External sources can be calibrated using this dialog. [Learn more](#).

Accuracy

At each data point, power is measured using the **specified Power Meter Settling Tolerance**, then adjusted until the reading is within this Accuracy **Tolerance** or the **Max Number of Readings** has been met. The **last** power reading is plotted on the screen against the Tolerance limit lines.

Tolerance Sets the maximum desired deviation from the specified **Cal Power** level in 0.005 dB increments from 0 to 5 dB.

Max Number of Readings Sets the maximum number of readings to take at each data point for iterating the source power. Enter a value between 1 and 1000.

Calibration Status

Allows you to turn Source Power Cal ON | OFF and view Cal data for each port, regardless of the active measurement. This feature allows the Internal Second Source to be calibrated and turned ON | OFF, even when being used as an incidental source in a measurement, such as an LO.

Calibration ON Check to turn Source Power Calibration ON for the specified source port.

The displayed text indicates when **interpolation** is applied for the calibration.

Buttons

Options Invokes the **Source Power Cal Options** dialog. Label to the left of the button displays the current 'Options' setting.

Power Meter Config Invokes the **Power Meter Settings** dialog box

Take Cal Sweep Begins source power calibration measurement.

OK Applies calibration. This button is disabled until the Take Cal Sweep has been pressed.

Cancel If a sweep is in progress, cancels the sweep. Press again to close the dialog.

Attention please: the power meter is operating in 200 r/s mode.

During a measurement, some Keysight power meters may display this message on the screen: It means that the meter is operating in 200 readings/sec which is the fastest speed setting for this meter. This is normal operation.

Pass / Fail Limits

Limit lines are drawn on the Source Power Cal measurement graticule area. These lines are at the Cal Power +/- the current setting of Accuracy Tolerance. A FAIL during the Source Power Cal sweep means that the VNA was unable to measure power to within the Accuracy Tolerance. Tight

tolerances are more difficult to achieve at lower Cal Power levels. When a FAIL indication appears, increase the Max Number of Readings. If this does not cause a PASS condition, then decrease the Accuracy Tolerance value.

See Also

- Learn more about [Source Power Cal](#)
- Learn about External Testsets and Source Power Cal.

Source Power Calibration Options dialog box help

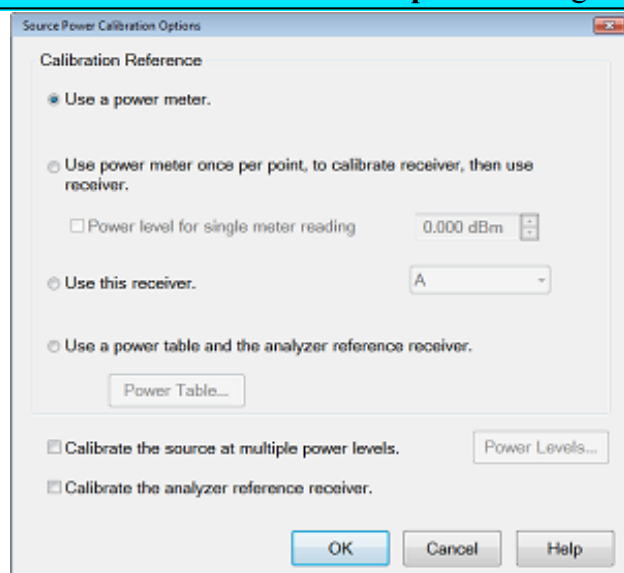

Provides options for measurement of the source power.

Note: At low power levels (less than -30 dBm) most power meters are not as accurate as a VNA receiver.

Calibration Reference Choose power meter/VNA receiver to use to measure power.

- **Use a power meter.** Traditional source power calibration using only a power meter to measure the source power at each data point. Most accurate (at higher power levels) and slowest method.

Note: Because the following two settings use VNA receivers to make power measurements, they do NOT work correctly when a [Frequency Offset](#) value is being used.

- **Use a power meter once, to calibrate receiver, then use receiver.** When checked, the first reading at

each data point uses a power meter to calibrate the reference receiver. Subsequent readings, if necessary to meet your accuracy requirement, are measured using the reference receiver. This technique is much faster than using the power meter, and more accurate when measuring low power levels.

Note: Do NOT use this setting if there is a component before the power sensor that exhibits non-linear behavior, such as a power amplifier in compression. Use a power meter and [Calibrate the source at multiple power levels](#).

- **Use this receiver.** Select a VNA Receiver or a PMAR (Power Meter as Receiver).

VNA receiver - For highest accuracy, first calibrate the receiver by performing a source power cal using a power meter, then a [receiver cal](#). That receiver can then be used to quickly calibrate other VNA source ports, or used on another channel with different stimulus settings. This would be useful, for example, if the power level of the measurement was below the sensitivity of the power sensor. Calibrate the VNA receiver using a source power cal that is within the sensitivity of the sensor. Then, use the calibrated receiver to perform a second source power cal at the reduced power level.

- The VNA receiver is specified using either standard receiver notation or [logical receiver notation](#).
- It is best to use the reference receiver for the source port to be calibrated. For example, if calibrating source port 2, specify "R2" or "a2" which is the same port 2 reference receiver using [logical receiver notation](#).
- To ensure an accurate source power cal, the frequency range over which the receiver was calibrated must be the same or larger than the "receiver only" source power calibration.
- All accuracy and settling tolerance and number of reading settings apply just as they do with a power meter reading.

PMAR Device - The power meter/sensor must first be configured. [Learn how to Configure a PMAR device](#).

- **Use a power table and the analyzer reference receiver** Used to provide power leveling with mmWave test set and modules. [Learn more](#).

Calibrate the source at multiple power levels Used primarily with mmWave measurements.

This feature can also be used with standard VNA measurements when a component is used in the source path such as a booster amp which does NOT have linear gain or loss over frequency. If this is not true for your setup but want to improve your source power accuracy, consider using the [Receiver Leveling](#) feature.

When checked, source power is measured using the specified 'Cal Reference' device (power meter/sensor or VNA receiver) and iterated on a sweep-to-sweep basis to construct a 2-dimensional power table: Power IN, Power OUT, over all frequencies.

- Click **Power Levels** to launch the **Source Cal Power Levels dialog box** to set the power levels at which source power is to be measured.
- The source power cal is saved, but the power table is NOT accessible.

Calibrate the analyzer reference receiver Check to calibrate the appropriate reference receiver to the power level that is measured at the calibration plane. Do this to make very accurate measurements using the calibrated reference receiver. This cal is done in addition to the standard source power cal using the any of the methods listed above. At the end of the source power cal measurement sweep, you can optionally save the reference receiver cal to a Cal Set to be recalled at a later time. The Cal is saved when the **OK** button is clicked to close the Source Power Cal dialog.

Source Cal Power Levels dialog box help



This dialog appears when you click **Power Levels** on the **Source Power Cal Options dialog**.

Specify the power levels at which the Source Power will be calibrated. These values should be set to a few dB more or less than the measurement power levels.

Max Power - The highest power level at which to calibrate. This value should be a few dB **higher** than the highest power level of your measurement.

Note: Setting the **Max Power** will override power settings entered manually in a Power Table (**InputPower**). Therefore, when using a power table, set the **Max Power** value to the same value shown in the Power Table (**InputPower**).

Min Power - The lowest power level at which to calibrate. This value should be a few dB **lower** than the lowest power level of your measurement.

Power Step - Calibrate at every incremental power level, between the Max and Min Power settings.

Power Meter Settings dialog box help

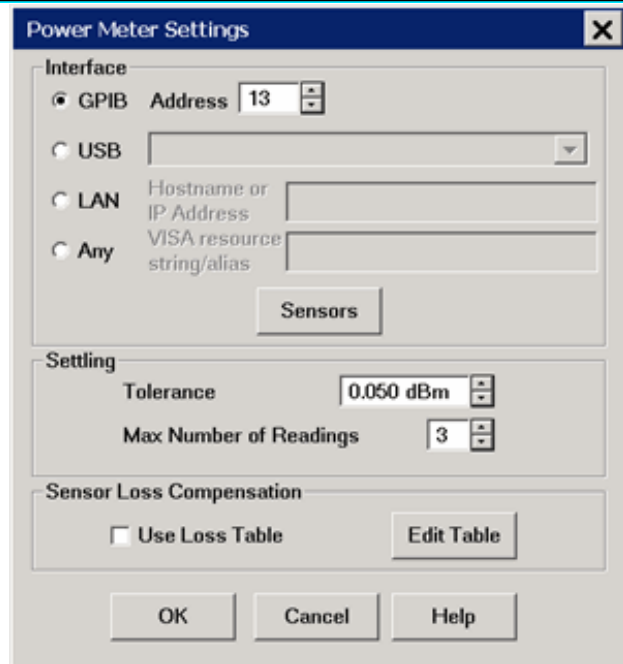

This dialog appears when you click the **Power Meter Config** button on many dialog boxes.

Communication

- **GPIB / Address** Select GPIB power meter. Then select the address for the power meter. Default is 13. The VNA will search VISA interfaces that are configured in the Keysight IO Libraries on the VNA. **Note:** Use this selection when using a 82357A USB/GPIB Interface,
- **USB** VNA scans for USB power sensors or **N191x device-side USB power meters**. Select a power sensor from the list. Only ONE USB power sensor can be configured to cover the entire frequency range of the calibration. To use multiple power sensors, perform a **Guided Power Cal**.
- **LAN** Specify the Hostname or IP address of the Power Meter.
- **Any** This can be used if you wish to spell out the exact **VISA resource string/alias** for your power meter's I/O connection, for GPIB, USB, LAN or any other I/O protocol supported by VISA. For example, you must use this to use a VDI PM5 power meter, and the VISA resource string/alias in that case must be **ASRL3::INSTR**.

Note: The VDI PM5 driver software must be installed to use VDI power sensors. Refer to [Install VDI PM5 Driver](#).

Sensors Invokes the [power sensor settings](#) dialog box.

Settling

These Settling settings do not apply when a VNA receiver is the power measurement device. Each power meter reading is "settled" when either:

- two consecutive meter readings are within this **Tolerance** value or
- when the **Max Number of Readings** has been met.

The readings that were taken are averaged together to become the "settled" reading. The settled reading is then compared to the [Accuracy Tolerance requirements](#) (tolerance and max readings) specified on the Source Power Cal dialog box.

Tolerance When consecutive power meter readings are within this value of each other, then the reading is considered settled.

Max Number of Readings Sets the maximum number of readings the power meter will take to achieve settling.

Sensor Loss Compensation

Use Loss Table Select this checkbox to apply loss data to Source Power calibration correction (such as for an adapter on the power sensor).

Edit Table Invokes the [Power Loss Compensation dialog box](#).

Power Loss Compensation dialog box help

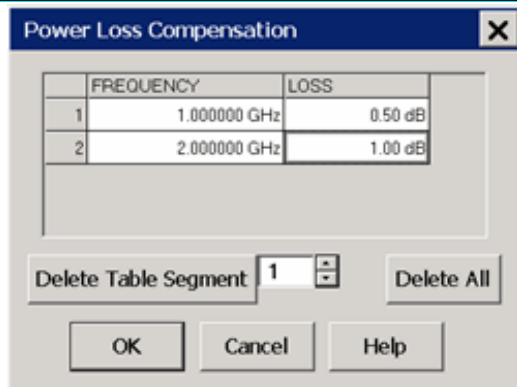

To Add a Row to the table, click on a row in the table and press the down arrow on either the VNA front panel or keyboard.

To Edit a value, double-click in the cell to be edited.

Compensates for losses that occur when using an adapter or coupler to connect the power sensor to the measurement port. These components will be removed when the calibration is complete. To account for components that will remain during the measurement, use the **Power Offset setting**.

The Frequency / Loss pairs define the amount of loss for the entire frequency range. For example, using the entries in the above dialog image:

- 0.5 dB is used to compensate power sensor measurements up to 1 GHz.
- Each data point between 1 GHz to 2 GHz is linearly interpolated between 0.5 dB and 1 dB.
- 1 dB is used above 2 GHz.
- A single frequency/loss segment is applied to the entire frequency range.

Beginning with A.09.80, enter up to **9999** segments to achieve greater accuracy. Previously the limit was 100.

Note: Large segment counts with one or more power sensors can result in long load and close times for the VNA Application.

Frequency Enter a frequency in Hz.

Loss Enter a loss as a POSITIVE value in dB. To compensate for gain, use NEGATIVE values.

Delete Table Segment Deletes row indicated in the field.

Delete All Deletes all data in the table.

The Power Loss Compensation table survives VNA Preset and Power OFF. To NOT use Loss compensation, clear the Use Loss table checkbox on the **Power Meter Settings** dialog.

Power Sensor Settings dialog box help

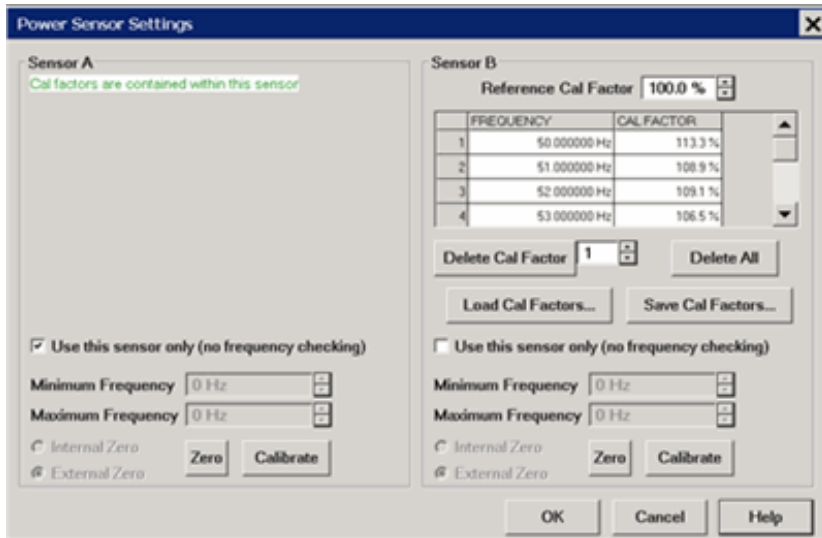

This dialog appears when you click the **Sensors** button on the **Power Meter Settings** dialog.

Note: Be sure that the frequency range of your power sensor covers the frequency range of your measurement. This does NOT occur automatically.

Sensor A (B) Displays one of the following messages depending on type of sensor.

- **Not connected** The VNA is not detecting a power sensor.
- **Cal factors are contained within this sensor** This message is displayed when the Internal Reference Cal Factor and Cal Factor data are contained in the sensor and automatically accessed.
- **Sensor Data** Allows the following entries for power sensor data:
 - **Reference Cal Factor** Specifies the sensor's Reference Cal Factor.
 - **Cal Factor Table** Specifies the frequency and corresponding Cal Factor for the sensor.
 - **Delete Cal Factor** Deletes the indicated row in the table.
 - **Delete All** Deletes all data in the table.
 - **To Add a Row** to the table, click on a row in the table and press the down arrow on either the VNA front panel or keyboard. A row is added to the bottom of the table. The table is automatically sorted by frequency when OK is pressed.

Load Cal Factors Click to load cal factors from a *.csv file that you create from the cal factors that appear on the sensor. The first line of the file MUST have the reference Cal Factor (typically 100), followed by Freq / Cal Factor pairs as show in the following image:

	1	2
1	100	
2	50	113.3
3	51	108.9
4	52	109.1
5	53	106.5

Save Cal Factors Click to save the cal factor table to a *.csv file.

Use this sensor only Check this box to use this sensor over the entire frequency span of the measurement, even if two sensors are connected to power meter.

Clear this box to allow entry of minimum and maximum frequencies for the sensor. Only ONE of the two sensors can have this box checked. You will be prompted to connect the appropriate sensor during the power calibration.

Minimum Frequency Specifies the minimum frequency range for the sensor when using dual sensors.

Maximum Frequency Specifies the maximum frequency range for the sensor when using dual sensors.

Zero and Calibrate the Power Sensor

For highest accuracy, Zero AND Calibrate the power sensor before measuring data. Follow prompts that may appear.

Zero - If the following settings are 'greyed', Internal or External zeroing is selected automatically based on the power meter/sensor model. Otherwise, select the appropriate type of zeroing to perform, then press Zero.

- **Internal Zero** - A switch inside the power sensor removes the sensor from the incident power.
- **External Zero** - Requires that you physically remove the sensor from incident power.

Note: For the U2000 Series USB power sensors

Calibration is NOT available. Select External Zero ONLY when the power to be measured is **below** the specified level. Otherwise, the U2000 series performs internal zeroing automatically when needed. See your power sensor documentation for more details.

- U200xA - below -30 dBm
- U200xH - below -20 dBm
- U200xB - below 0 dBm

If your U2000 power sensor 'hangs' when external zeroing, upgrade the power sensor firmware to Rev. A.01.02.00 or higher to fix this problem.

Note: For the U2020 X-Series USB power sensors

The U2020 X-Series support only internal zeroing. But like the U2000 series, they default to performing zeroing automatically when needed.

Calibrate - Available when the selected sensor has calibration capability. Calibration involves measuring an internal 1 mW source.

- Keysight P-Series sensors and U2020 X-Series USB sensors have an internal reference so you can calibrate them without connecting to a meter's reference port.
- Keysight U2000 USB power sensors do not require calibrating.
- For other sensors, refer to the documentation to determine if it has calibration capability.

Press **Calibrate**, then follow the prompts.

Copy a Source Power Calibration to other Channels

A macro application is now available that copies a Source Power Calibration to other channels. Once downloaded and installed on a VNA, the **macro** is automatically configured up. To learn more, click **Help** on the application main dialog. Get the application from <http://na.support.keysight.com/pna/apps/applications.htm>.

Saving a Source Power Calibration

Because Source Power Cal calibrates source hardware, the calibration data is saved as part of the **Instrument State**, in either a .sta file or a .cst file. This correction is applied to all measurements on the channel that uses the calibrated source. See [Save Instrument State](#).

Reducing Time to Complete a Source Power Calibration

The time required to perform a Source Power Calibration depends on source power, number of points, and number of readings taken. You can reduce this measurement time with the following methods:

- **Reduce number of points before calibration.** You can reduce the number of points before the measurement, then return the number of points to its original value after calibration is complete and correction is ON. The analyzer will perform a linear interpolation, although with some loss in accuracy.
- **Use an Keysight E-Series sensor.** You can obtain 40+ readings per second over GPIB with this type of sensor on the VNA.
- **Increase power to the sensor.** Lower power may have longer settling time with some sensors.
- **Check [Use Reference Receiver for Iteration](#).**

Receiver Power Calibration

Note: Source and Receiver Power Calibrations are NOT available in M937xA PXI.

Note: A Guided Power Cal can be performed during an S-parameter Guided Calibration. [Learn more](#).

Receiver power calibration mathematically removes frequency response errors in the specified VNA receiver, and adjusts readings to the same, or a value offset from, the source power calibration level. It is the same as doing a **Response Cal** or **Data / Memory, (Normalization)** but with the data shifted to the **Cal Power** value.

Use Receiver Power Calibration to make very accurate absolute power (amplitude) measurements.

Receiver Power Calibration:

- Is ONLY allowed when making absolute power (**unratioed**) measurements.
- Is most accurate when a source power calibration was performed first.
- Applies to all unratioed measurements in the active channel using that receiver.
- Can be saved in a Cal Set and later reapplied to a like measurement.

Interpolation

Like other calibration types, if the original stimulus settings are narrowed, interpolation is applied and **C* Rcvr Pwr** is displayed in the status bar. If the original stimulus settings are made wider, the VNA will turn Receiver Power Correction **OFF**.

If the original settings are restored, then receiver power calibration returns to full correction.

How to perform a Receiver Power Calibration

1. Perform a **Source Power Calibration**.
2. Set the active measurement to unratioed. [Learn How_](#)
3. Connect a THRU line from the source port to the receiver port.
 - When performing a receiver power cal on a reference receiver (source 1 and receiver R1), no connection is necessary as the receiver is internally connected to the source.
 - When the source port and receiver port are the same (receiver A, source port 1), then connect an open or short to get maximum power to the receiver. This practice is not recommended. It is best to use different ports for the source and receiver.
4. Ensure correction for Source Power Calibration is ON as indicated by **Src Pwr Cal** or **Src Pwr Cal*** in the status bar.
5. Start the **Calibration Wizard**

Using **Hardkey/SoftTab/Softkey**

1. Set the active measurement to unratioed. [Learn How_](#)
2. Press **Cal > Main > Other Cals > Receiver Power Cal...**

Programming Commands

Select Calibration Type for Unratioed Measurement dialog box help

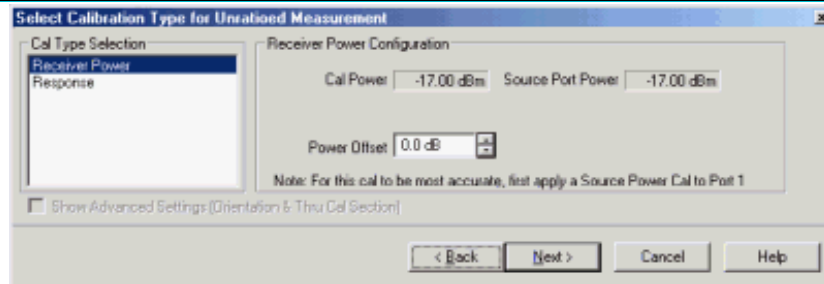

Cal Type Selection Select Receiver Power

Receiver Power Configuration

Cal Power Specifies the power level to be displayed on the measurement when complete. (Source Port Power + Power Offset).

Source Port Power Test port Power set for the measurement. [Learn how to change Test Port Power](#)

Power Offset Allows you to specify a gain or loss (in dB) to account for components you connect between the source and the reference plane of your measurement AFTER a source power cal has been performed. Following the calibration, the VNA power readouts are adjusted to the Cal Power value.

Next Click to continue the Calibration Wizard.

Notes:

- When Receiver Power Cal is finished, **'Response'** is displayed in the status bar and correction data is applied to subsequent sweeps. This is done because Receiver Power Cals are essentially Response Cals once they are stored and applied. See Saving a Receiver Power Cal below.
- To turn correction **OFF**, click **Cal** > **Main** > **Correction** > **Channel Correction OFF**.

[Learn more about Receiver Power Cal \(scroll up\).](#)

Saving a Receiver Power Calibration

Beginning with VNA Revision 5.0, Receiver Power Cal is saved to a **Cal Register** and optionally to a **User Cal Set**. It can be applied to measurements in the same way as other Cal Types. Previously, Receiver Power Cal data was saved as part of an Instrument State and was only applied to the measurement on which it was performed.

[Learn more about Saving VNA files types.](#)



Fixture Simulator

The following features allow you to mathematically add (embed) or remove (de-embed) circuits to, or from, your measurements. The mathematical models are applied to specific ports for all measurements on the channel.

Notes

- The following features are available in **GCA, Noise Figure Apps**:
 - **Port Extensions** (Not available in Swept IMD, IMDX, Noise Figure, NFX, or Diff IQ)
 - **2 Port De-embedding**
 - **Port Matching**
 - **Port Z Conversion**
 - **Power Compensation**
- All other Fixturing features are available **ONLY** in a **standard channel**.

See Also

- **Procedures: To Embed or De-embed?**
- **"De-embedding and Embedding S-Parameter Networks Using a Vector Network Analyzer"** App note. for more conceptual information on Fixture Simulation.
- **See an example** of how these functions can be used to de-embed unwanted effects of a test fixture, and then mathematically embed the DUT in the circuit in which it is used.

Order of Fixture Operations

Click to learn more about each operation.

First, the following **Single-ended** measurement functions are processed in this order:

1. **Port Extensions**
2. **2-Port De-embedding**

3. Ground loop de-embedding / embedding
4. Port Matching Circuit Embedding
5. Port Z (Impedance) Conversion
6. 4-Port Network (single-ended) Embed/De-embed

Note: The operation for ground loop embedding and ground loop de-embedding will always occur as the 3rd step. It cannot be moved. By default, this is after the 2-Port DeEmbedding operation.

Then, **Balanced** measurement functions are processed in this order:

7. Balanced Conversion
 8. Differential / Common Mode Port Z Conversion
 9. Differential Port Matching
- Source power compensation is then optionally applied to compensate for the aggregate loss through all enabled fixturing operations.

Notes

- The fixturing operations are applied to the measurement results.
- The order of operations **1 through 5** can be changed using the SCPI command: **CALC:FSIM:SEND:OORD**. Learn how to send this command from the **GPIB Command Processor Console**.
- The order of the operations **6 through 9** can NOT be changed.
- In the **Data processing chain**, the Fixture Simulator functions occur at the same time as the **Apply Error Terms** block.
- When fixturing is enabled, all of the enabled fixturing features are applied when **snp files are saved**.

How to select Fixturing Simulator

About Fixturing ON/off

BOTH of the following must occur to turn a fixturing selection **ON**.

EITHER ONE will turn a fixturing selection **OFF**.

1. Turn **Apply Fixtures ON/off**
Port Extensions is NOT affected by Fixturing ON/off.
2. Check **Enable** on the individual fixturing selection dialog box.

Using **Hardkey/SoftTab/Softkey**

1. Press **Cal > Fixtures > Apply Fixtures**.

◀ Programming Commands ▶

Port Matching dialog box help

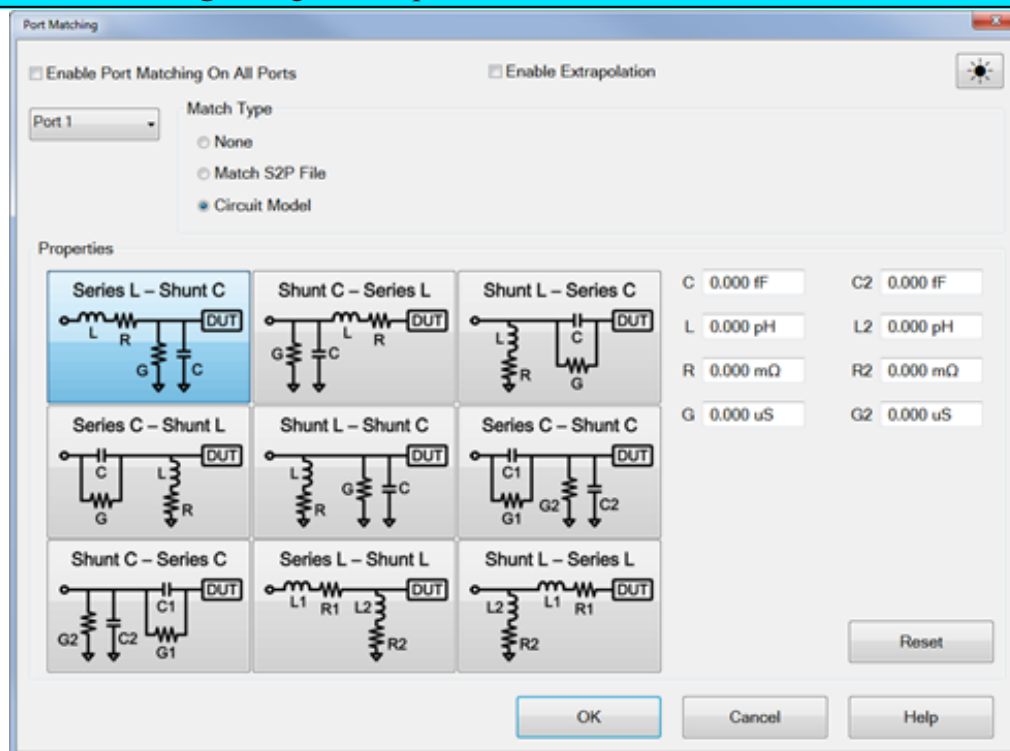

Note: This feature is available in the following measurement classes: **GCA**, **Noise Figure**, and standard

(S-Parameter) channels.

This function specifies a circuit to embed (add) to the measurement results. See [Order of Fixture Operations](#).

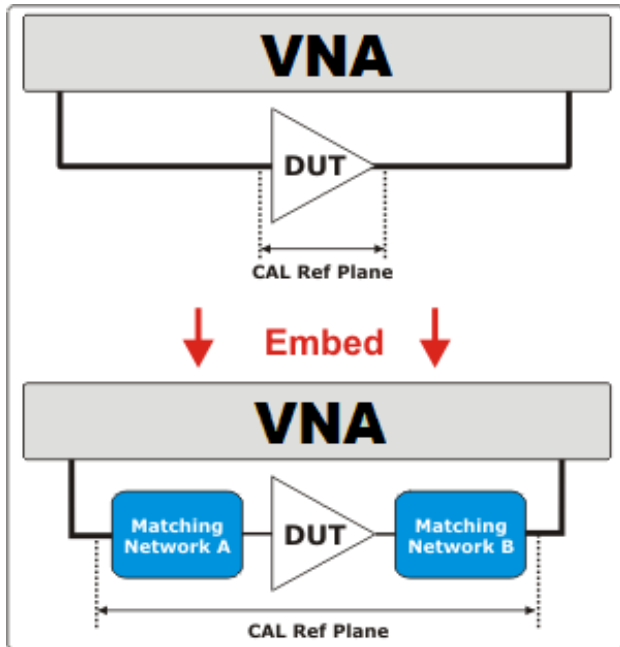

Enable Port Matching Check to apply the settings to the measurement results. Must also enable [Fixturing ON/off](#).

Port - Select Port in which to apply simulation.

Circuit Model for Matching - Choose one of the following that best emulates your fixture at the selected VNA port:

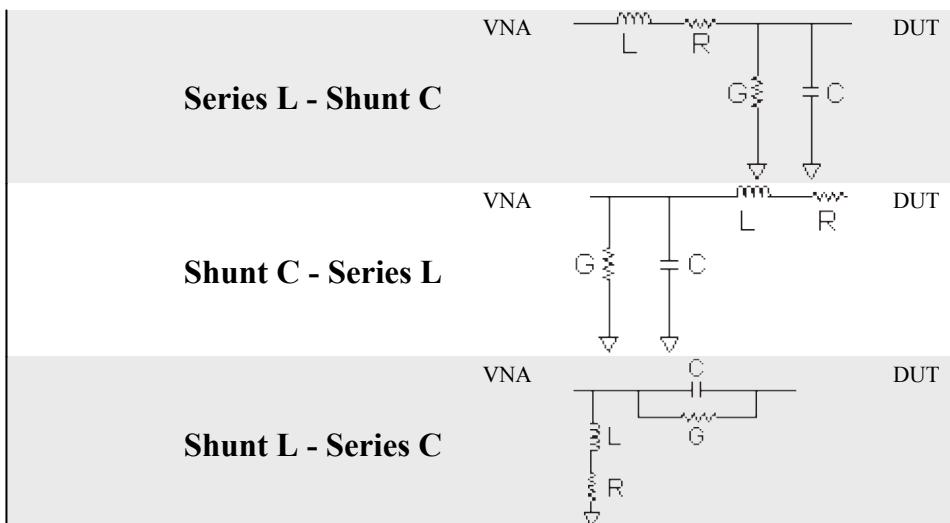

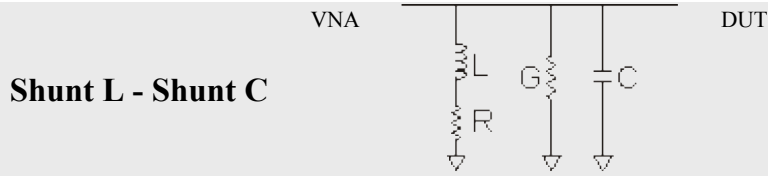
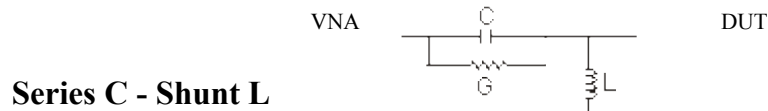

User Defined (S2P File) Load a file that is specified with **User S2P File** button.

None Use no circuit model.

User S2P File Click to specify an S2P file of the circuit model to embed at the selected port. If the normalized impedance value in a recalled User .S2P file is different from the port reference impedance setting of the VNA, the VNA setting is used.

Circuit Values

Capacitance (C), Inductance(L), Resistance(R), Conductance(G) Values for the specific components of the circuit type that models your fixture.

Reset Restores the default values.

2 Port De-embedding dialog box help

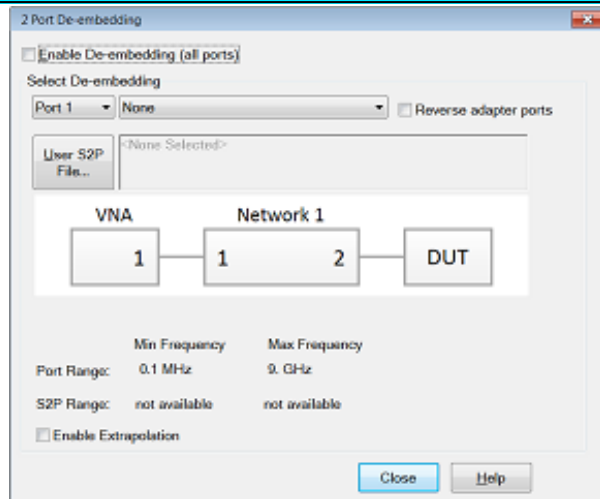

Note: This feature is available in the following measurement classes: **GCA**, **Noise Figure**, and standard (S-Parameter) channels.

De-Embed when you have performed a calibration and then added a fixture (an adapter, an attenuator, a longer cable, etc.) that connects between the Cal reference plane and your DUT. This function **removes** the effects of a component or test fixture from the measurement results.

Note: De-embedding a component with more than 20 dB of loss becomes impractical because of an inability to accurately measure the match of the DUT through such a device.

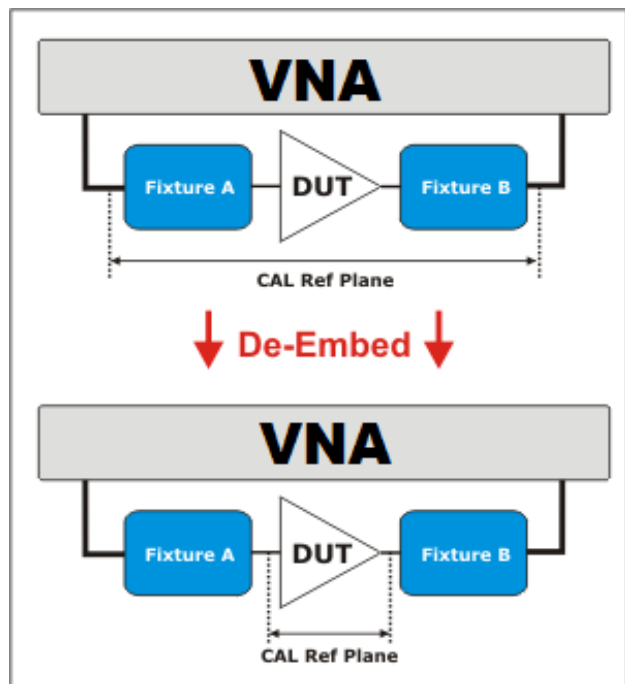

The de-embedding operation recalls an .s2p file (Touchstone format) which includes the electrical characteristics of a 2-port fixture or device. The file can be in any standard format (real-imaginary, magnitude-angle, dB-angle).

Enable De-embedding Check to apply the settings to the measurement results. Must also enable **Fixturing ON/off**.

Enable Extrapolation Check to apply a simple extrapolation when the S2P file has a narrower frequency range than the channel. The values for the first and last data points are extended in either direction to cover the frequency range of the measurement. The frequency ranges of both the channel and the S2P file are displayed at the bottom of the dialog.

When extrapolation is necessary and enabled, a message is displayed showing the frequency range to be extrapolated. When extrapolation is necessary and disabled, a message is displayed offering to enable extrapolation.

This setting also causes **4-port Extrapolation** to be enabled and disabled.

Port The VNA port to which the recalled de-embedding file is applied.

From the drop-down menu, select **User Defined (S2P File)**.

Reverse Adaptor Ports Check to cause the Fixture/Adapter to be configured with Port 2 connected to the VNA and Port 1 to be connected to the DUT. The image in the dialog reflects that change.

User S2P File Click to specify an existing .S2P file. If the normalized impedance value in a recalled User .S2P file is different from the port reference impedance setting of the VNA, the VNA setting is used.

Port Z (Impedance) Conversion dialog box help

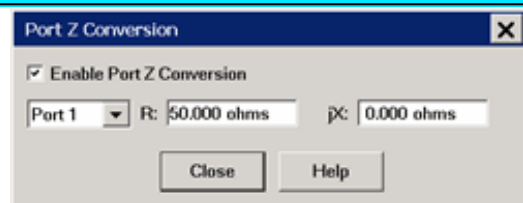

Note: This feature is available in the following **measurement classes**: **GCA**, **Noise Figure**, and standard (S-Parameter) channels.

This function corrects the measurement and displays the results as if the measurement had been made into the specified impedance value. However, the physical port termination is still approximately 50 ohms.

The specified impedance value is applied to all of the measurements on **ONLY** the active channel.

[See Order of Fixture Operations.](#)

Enable Port Z Conversion Check to apply the settings to the measurement results. Must also enable **Fixturing ON/off**.

R Real part of the impedance value.

jX Imaginary part of the impedance value.

Close Applies the entries and closes the dialog box

Note: Port Z (Impedance) conversion uses values in the following prioritized order:

1. **Balanced (Differential or Common Mode)** - if enabled, these values are always used.
2. **Single Port Impedance** - if enabled, this value is used if Balanced is not enabled.
3. **System Impedance** - if neither balanced or single port is enabled, this value is used.

4/6/8-Port Embed/De-embed dialog box help

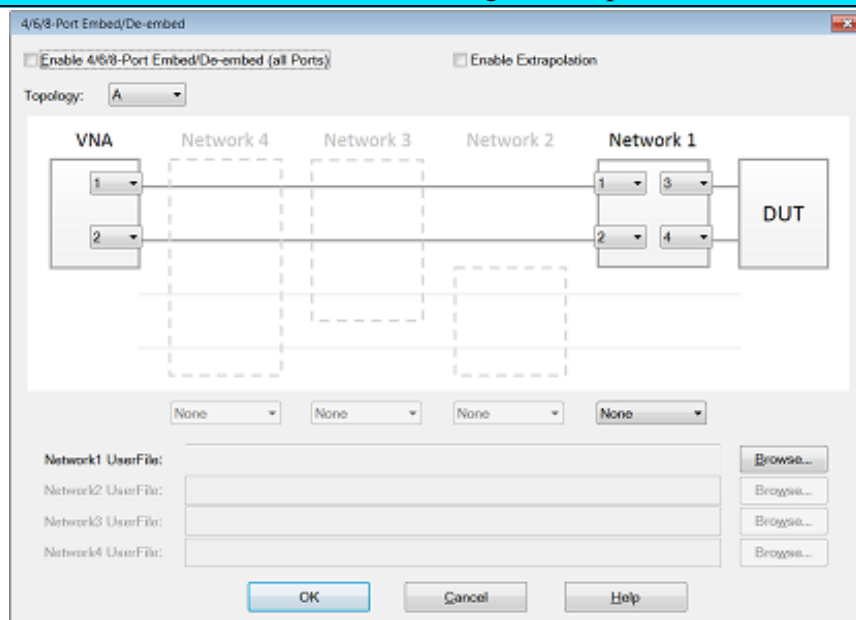

This function specifies a single-ended 4-port circuit (*.S4P file) to embed (add) or de-embed (remove) from the measurement results. Computation takes place BEFORE Balanced conversion. See Order of Fixture Operations.

There is a single normalized impedance value for each port in the *.S4P file. This impedance value must match the impedance of the previous Port Z setting, or the VNA port impedance.

The VNA will interpolate if the number of data points that are read is different from the current VNA setting.

Enable 4-Port Embed/De-embed Check to apply the settings to the measurement results. Must also enable Fixturing ON/off.

Enable Extrapolation Check to apply a simple extrapolation when the S4P file has a narrower

frequency range than the channel. The values for the first and last data points are extended in either direction to cover the frequency range of the measurement. The frequency ranges of both the channel and the S4P file are displayed at the bottom of the dialog.

When extrapolation is necessary and enabled, a message is displayed showing the frequency range to be extrapolated. When extrapolation is necessary and disabled, a message is displayed offering to enable extrapolation.

This setting also causes **2-port Extrapolation** to be enabled and disabled.

Topology

Select a DUT topology. Refer to the images on the 4-port embed/De-embed dialog box.

- **A** - Network 1
- **B** - Network 1/3
- **C** - Network 1/2/4

NA Ports - Select the VNA Port that is connected to each circuit port.

Network Ports Select the network ports that represent the configuration of the S4P file. By default, ports 1 and 2 are connected to the VNA and ports 3 and 4 are connected to the DUT.

None, Embed, De-embed For Network1 and Network2, select:

- **None** - The same as disabling.
- **Embed** - Add the specified network circuit to the measurement results. [See 2-port Embed image.](#)
- **De-embed** - Remove the specified network circuit from the measurement results. [See 2-port De-embed image.](#)

Browse For both Network1 and Network2, navigate to find the .*S4P file to embed or de-embed.

OK Applies the changes and closes the dialog box.

Cancel Does NOT apply the changes and closes the dialog box.

Differential Impedance Conversion dialog box help

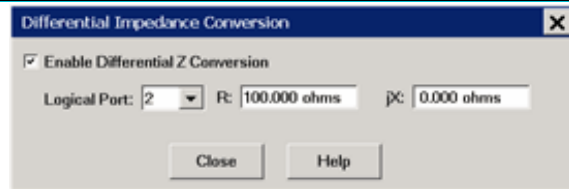

This function sets the Differential impedance value for each balanced port.

The default value for **R**: is the SUM of the impedance values for both ports that make the logical port. If **Port Z Conversion** is not enabled, then **System Z0** values for both ports are summed.

See [Order of Fixture Operations](#).

Enable Differential Z Conversion Check to apply the settings to the measurement results. Must also enable **Fixturing ON/off**.

Logical Port Select the logical (balanced) port to receive impedance value. To see logical port numbers, see the [measurement topology](#).

R Real part of the impedance value.

jX Imaginary part of the impedance value.

Close Closes the dialog box.

See [note about Port Impedance priority](#).

Common Mode Impedance Conversion dialog box help

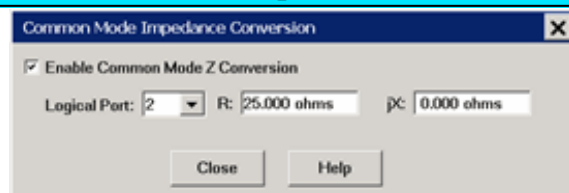

This function sets Common Mode Impedance value for each balanced port.

The default value for **R**: is calculated as follows.

$$(Z1 * Z2) / (Z1 + Z2)$$

Where ports 1 and 2 comprise the logical port:

Z1 = the Port Impedance values for port 1

Z_2 = the Port Impedance values for port 2

If **Port Z Conversion** is not enabled, then **System Z0** values for port 1 and 2 are used in the calculation.

See [Order of Fixture Operations](#).

Enable Common Mode Z Conversion Check to apply the settings to the measurement results. Must also enable **Fixturing ON/off**.

Logical Port Select the logical (balanced) port to receive impedance value. To see logical port numbers, see the [measurement topology](#).

R Real part of the impedance value.

jX Imaginary part of the impedance value.

Close Closes the dialog box.

See [note about Port Impedance priority](#).

Differential Port Matching dialog box help

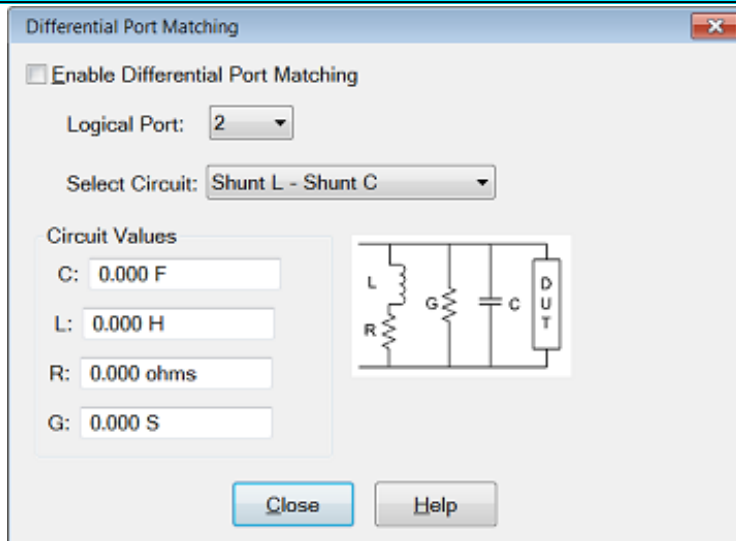

This function allows the embedding of a differential matching circuit at a balanced port.

See [Order of Fixture Operations](#).

Enable Differential Port Matching Check to embed the selected matching circuit to the measurement results. Must also enable **Fixturing ON/off**.

Logical Port Choose **Logical DUT port** to receive the selected matching circuit. To see logical port numbers, see the [measurement topology](#).

Select Circuit Select a matching circuit. Choose from:

- **Shunt L - Shunt C** Predefined circuit.

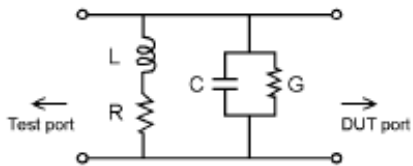

Circuit Values Choose from:

- **C** Capacitance value
 - **G** Conductance value
 - **L** Inductance value
 - **R** Resistance value
- **User defined** Select an *.S2P file that represents the matching circuit. Then click **Browse** to navigate to the *.S2P file.

Note: For the *.S2P file:

Port 1 of the circuit is assumed to be connected to the VNA

Port 2 of the circuit is assumed to be connected to the DUT.

- **None** No embedded circuit on selected port.

Close Closes the dialog box.

Power Compensation dialog help

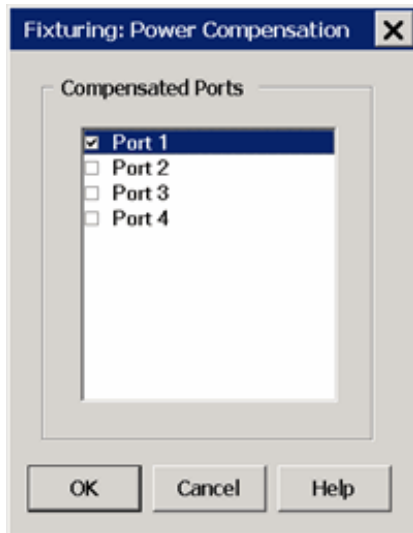

Note: This feature is available in ALL [measurement classes](#).

This function adjusts the source power at the specified port to compensate for the combined amount of gain or loss through specific fixturing operations. Use this function to set the power level at the DUT input.

Power Compensation adjusts the source power for the gain/loss through 2-port de-embedded fixture components.

- It does not compensate for any port matching networks.
 - To work around this limitation, compute the anti-network of the matching circuit and use that data to generate an S2P file. Change the fixture type from port matching to De-embed. This should result in the same measurement data but will also enable the port power compensation feature.
- It does not compensate for any fixture networks with more than 2 ports.
 - There is no work around for this limitation. There is a coarse adjustment for port power using Power Offsets. Calculate the loss through the fixture, use that number to set the power offset, and then set the desired power level at the port.

For example:

- Your DUT requires a fixture on the input port which is connected to VNA port 1.
- The fixture description (such as an S2P file at the [2-port De-embed function](#)) indicates the fixture has approximately 2 dB of loss across the frequency span.
- You set source power to 0 dBm. But you want 0 dBm at the DUT input (the fixture output).
- Check Power Compensation on Port 1 and enable [Fixturing](#).

- Power Compensation causes the source power to be increased by approximately 2 dB so that the power at the fixture output plane will remain at 0 dBm.

Power Compensation affects all measurements in the channel.

Enable **Fixturing** to use Power Compensation.

Note: Use caution when applying power compensation. Always test your setup without a DUT in a place. If you are using S2P files, **Recall** your S2P file into the VNA so you can verify that the device your S2P file describes is what you intended it to be. It is too easy to misalign data in S2P files if they are constructed by hand.

Ground Loop De-embedding / Embedding

Ground loop de-embedding removes the effect of a non-ideal ground connection between the DUT's ground and the analyzer's ground reference. Typically, the non-ideal component is the parasitic inductance of the ground contacts.

Ground loop embedding adds the effect of a non-ideal component on the ground contacts.

The Ground Loop De-embedding / Embedding can be specified by circuit model type or touchstone file.

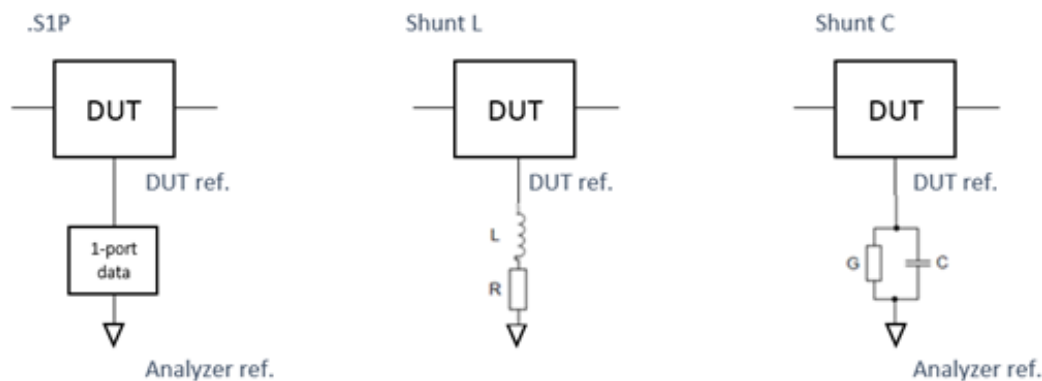

Ground loop de-embedding / embedding is only available from **SCPI remote interface**.

Fixture Simulator Example

The following example shows a DUT and the matching circuit with which the DUT will be used in its intended application. When the DUT is tested in a high-volume manufacturing environment, multiple test fixtures are often required. The most accurate way to test the DUT and ensure measurement consistency between the different test fixtures is to use a simple, repeatable, test fixture without the actual matching elements.

To get the desired performance data, the parasitic effects of the fixture must first be removed (de-embedded) from the measured data. Then a perfect "virtual" matching circuit must be simulated and

added mathematically (embedded) to the corrected, measured data. The result is an accurate display of the DUT as though it was actually tested with a physical matching circuit, but without the uncertainties of using real components.

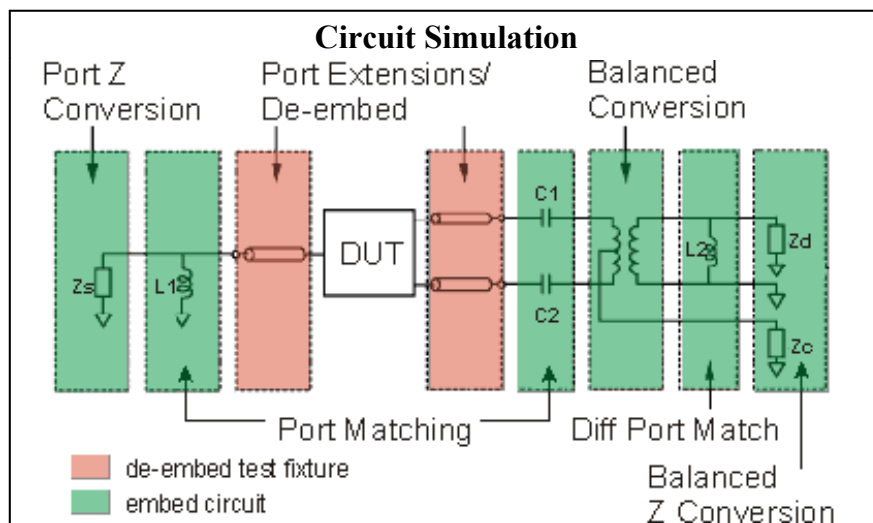
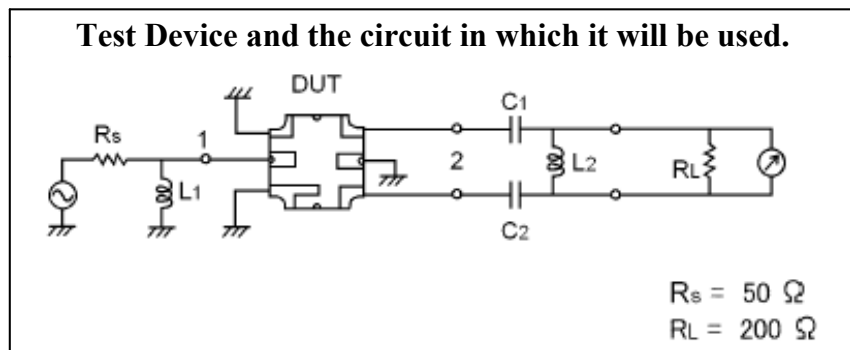

This diagram does NOT refer to the order in which operations are performed.

See [Order of Fixture Operations](#).

1. **Create a balanced measurement** using single-ended to balanced (SE-Bal) **topology**. Include all relevant measurement settings (IFBW, number of points, and so forth). Once the measurement is created and calibrated, the measurement parameter can be easily changed. For example, Sdd22 to Sds21.
2. Calibrate the measurement at the point where the simple test fixture is connected to the VNA. Use accurate calibration standards and definitions.
3. Remove the effects of the three uncalibrated transmission lines of the simple test fixture. This can be done in several different methods. The easiest is to use manual or automatic **Port Extensions** to move the calibration reference plane to the DUT. This removes the electrical length and loss of the fixture's transmission lines, but does not account for fixture mismatch. Another method is to de-embed previously-created *.S2p files of the 3 transmission lines. The files can be created using external ADS modeling software. Another alternative is to

create the *.S2P files by independently measuring all 3 ports of the test fixture and **saving the results of each to an S2P file.**

4. With the test fixture connected to the VNA and a DUT inserted, the measurement results now appear as though calibration was performed at the connections to the DUT, and the device was measured in a 50-ohm single-ended test environment. The following steps will cause the results to reflect the performance of the device as though the device is embedded in the circuit in which it will be used.
 5. Port 1 of the device is a single-ended port and sees a source impedance the same as the VNA system impedance, so no change is required. However, if R_s were a value other than 50 ohms, **Port 1 Impedance Conversion** would be used to simulate the different impedance.
 6. **Port Matching** is used to simulate L1 inductance. Select any of the Shunt L circuits to embed (add) to the measurement results. Enter the value of L and R. The C and G values can be entered as 0 (zero).
 7. **Port Matching** is used to simulate C1 and C2 capacitance. For both port 2 and port 3, select any of the **Series C** circuits to embed (add) to the measurement results. Enter the value of C and G. The L and R values can be entered as 0 (zero).
 8. **Balanced Conversion** mathematically simulates the measurement in balanced mode.
 9. **Differential Port Matching** is used to simulate L2 inductance. Select Shunt L- Shunt C and enter the inductance / resistance value. The C and G values can be entered as 0 (zero).
 10. Finally, **Differential Z Conversion** is used to simulate a circuit termination of 200 ohms. If you are making Common Mode measurements, specify **Common Mode Z Conversion**.
-

Automatic Fixture Removal (AFR)

Note: This feature requires Option S9x007A or 007.

In this topic:

- [Overview](#)
- [Requirements](#)
- [Automatic Fixture Removal Wizard](#)

Overview

Fixtures are often used for DUTs that have non-coaxial interfaces. This feature allows you to mathematically remove, or de-embed, a characterized test fixture from displayed measurement results of the test fixture and DUT.

Before starting the AFR process, **Perform a calibration** at the connectors of the test fixture (red lines in images below).

The AFR Wizard will guide you through these steps:

1. Press **Cal** > **Fixtures** > **Auto Fixture Removal...**
2. Describe your fixturing situation.
3. Specify How the Thru fixture characterization will occur.
4. Do characterization.
5. Remove the effects of the test fixture. Leaves **ONLY** the displayed results of the DUT.
6. Touchstone files are saved that characterize the two halves of the test fixture.

Requirements

- Test fixture and either a complete Thru **OR** Left and Right Thru halves, all shown below.
- Both the Test fixture and Thru are made of the exact same medium; preferably fabricated **ON** the same piece of medium.

Single-ended Fixtures

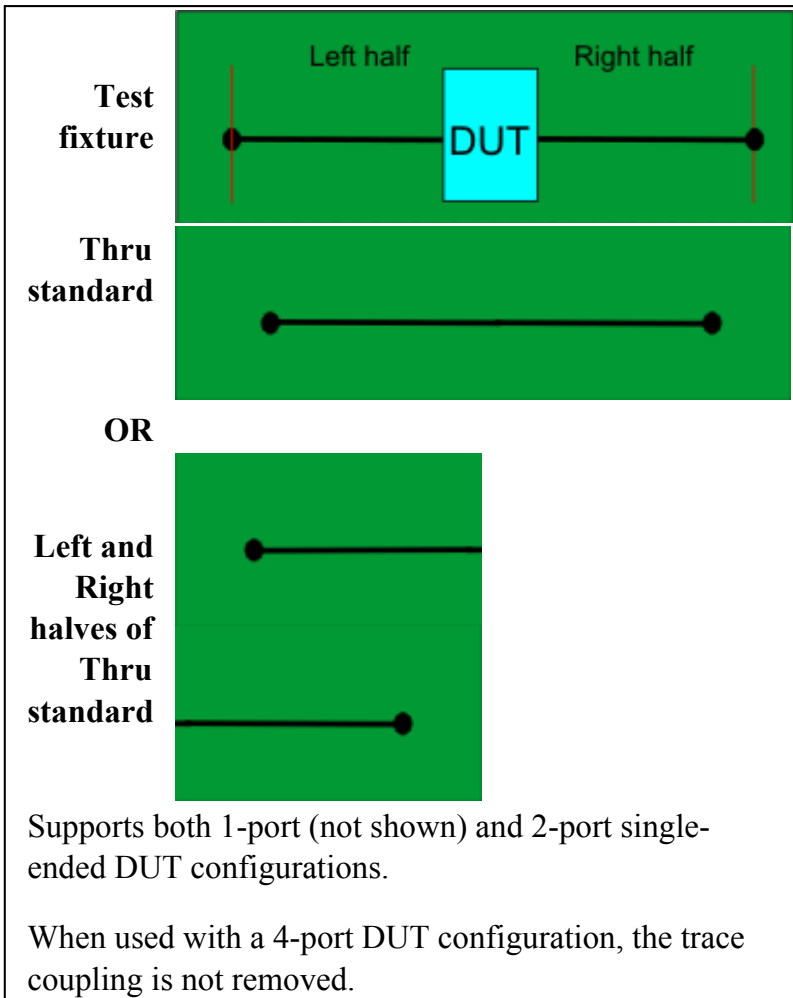

Differential (Balanced) Fixtures

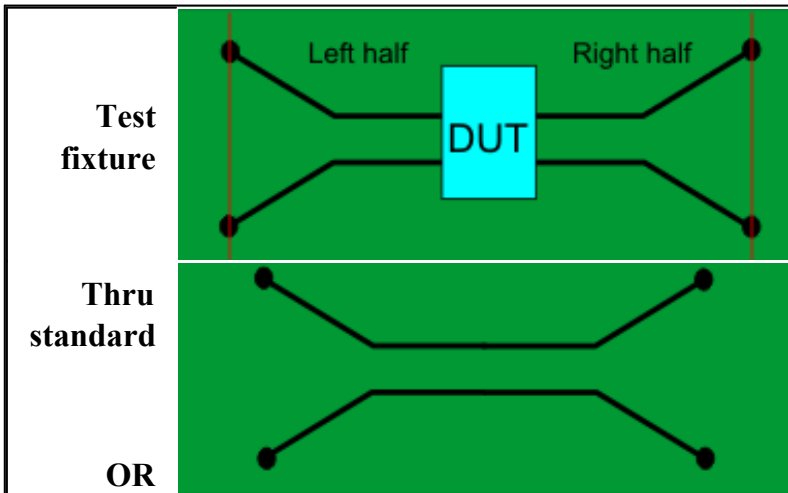

Left and
Right
halves of
Thru
standard

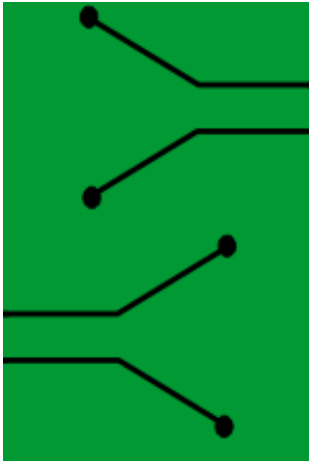

Supports 4-port DUT configuration ONLY which includes removing the effects of coupling between the differential traces.

How to start the Automatic Fixture Removal Wizard

With a calibrated measurement of the DUT in the test fixture present:

Click **Response**, then **Cal**, then **Fixtures**, then **Automatic Fixture Removal**

Note: The dialogs below show images for a Single ended DUT, but Differential works exactly the same, only with Differential S4P files.

Automatic Fixture Removal Wizard

Programming Commands

For best results, follow the AFR Wizard tabs from steps 1 through 5 by either clicking **Next >** or clicking the tabs.

In this section:

1. Describe Fixture
2. Specify Standards
3. Measure Standards
4. Remove Fixture
5. Save Fixture

1. Describe Fixture

The choices that you make in the dialog are reflected in the diagram and text (red box in following image).

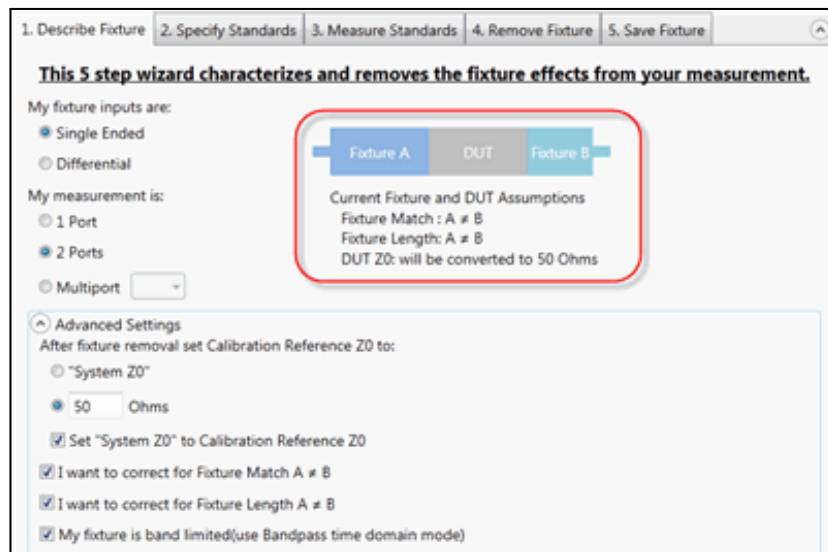

My fixture inputs are:

- **Single Ended** - The fixture and DUT have single-ended inputs and outputs.
- **Differential** - The fixture and DUT have differential inputs and outputs.

My measurement is:

- **1-port** - such as S11.(single-ended only)
- **2-port** - such as S21 (single-ended) or SDD11 (differential)
- **4-ports** - such as SDD21 (differential only)
- **Multiport** - available when using a testset with more than 4 ports.

Advanced Settings (click ^ to show and hide)

After fixture removal set Calibration Reference Z0 to: (Choose one of these settings)

- **System Z0** - Sets impedance to the System Impedance setting. [Learn how to set System Z0.](#)
- **Measured Fixture Z0** - Sets impedance to the value that is measured during the AFR process. Not allowed when 'band limited' is selected below.
- **<nn> ohms** - Sets impedance to an arbitrary value.

- **Set 'System Z0' to Calibration Reference Z0** - When the impedance is measured or set to an arbitrary value, check to also set the System Z0 to the same value.

Select all that apply:

- Check if this is true: **I want to correct for when the match** (Return Loss) of Fixture A is NOT equal to the match of Fixture B.
- Check if this is true: **I want to correct for when the electrical length** of Fixture A is NOT equal to the electrical length of Fixture B.
- Check if this is true: **My fixture is band limited**. Bandpass mode will be used during the Time Domain measurement. If NOT checked, then **Lowpass** mode is used. Because Lowpass mode includes impedance in the calculation, it renders the best accuracy. [Learn more about these settings.](#)

Note

When using **Lowpass** mode and an error message appears ("**Measurement settings are not adequate...**"), change the start frequency and the number of points so that the frequency span between data points equals the start frequency. This can be done by selecting values using the following logic:

Start freq = 10 MHz

then either:

Stop freq = 20 GHz

Number of points = 2000

or

Stop freq = 50 GHz

Number of points = 5000

In either case, the frequency span between data points equals 10 MHz, the start frequency.

2. Specify Standards

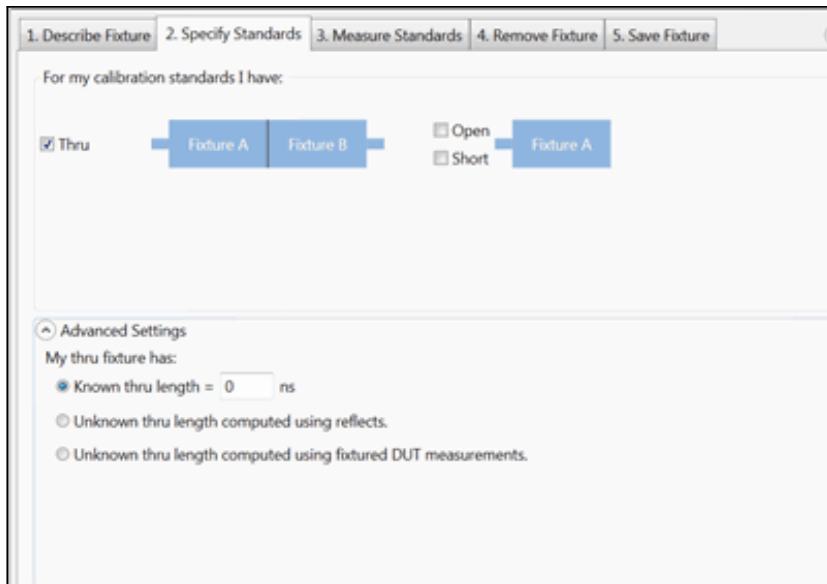

Note: The term 'Standards' is used here because this process can be thought of as the second in a '2-tier' calibration. The first tier of the calibration must already be performed (the VNA calibrated) before starting the AFR process. Another way of describing this step would be:

"How will you be measuring or loading the characterization of the Thru standard?"

- **Thru** - Both halves together.
- Both **Thru** halves separately. Specify either **Open**, **Short**, or **Both** at the end of each half of the standard.

Advanced Settings

This setting is used to describe any ADDITIONAL length between the halves of the Thru or added to either of the individual halves.

If the electrical length of the Thru standard is identical to the test fixture, then make no changes to the default settings (Known length = 0).

My Thru fixture has:

- **Known thru length** - Enter the length in nanoseconds. See a simulated length in the diagram between the two halves of the Thru.
- **Unknown thru length computed using reflects.** This setting requires the two halves of the Thru fixture be characterized separately with a reflect standard.
- **Unknown thru length computed using fixtured DUT measurements.** This setting requires an additional characterization of the Fixture + DUT.

3. Measure Standards

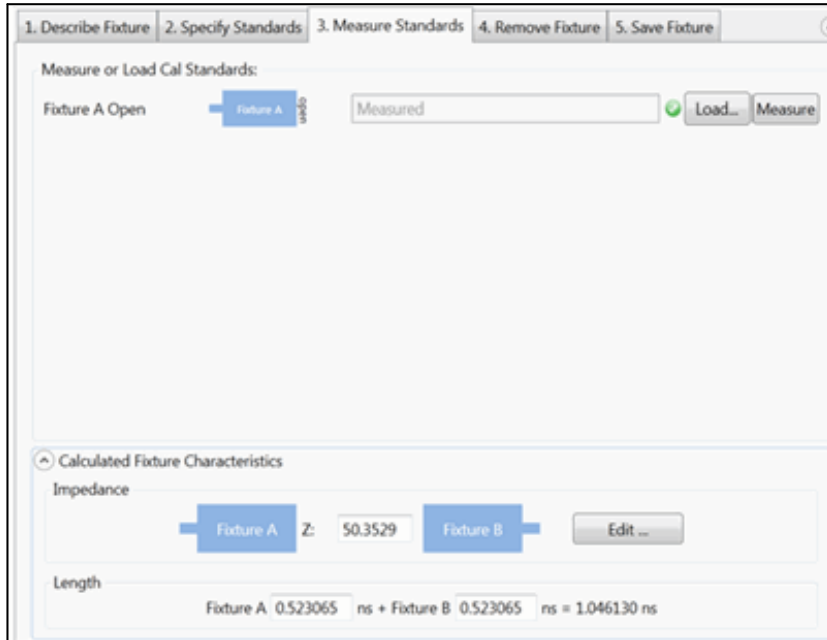

This step characterizes the Thru standards. This is done by either performing measurements or by loading one or more *.snp files that describe the characterization of the Thru standards.

Connect the standards and click **Measure**, or click **Load** and navigate to the *.snp file that describes the standard that is pictured.

Calculated Fixture Characteristics

Note: The fixture length must be 4 times the rise time. If not, an error message will be displayed. For example, a measurement at 26.5 GHz has a rise time of 37.7 ps. Therefore, the fixture length must be $4 * 37.7 \text{ ps} = 151 \text{ ps}$.

The loaded or measured Impedance and Electrical Length of the fixture are calculated and displayed here.

4. Remove Fixture

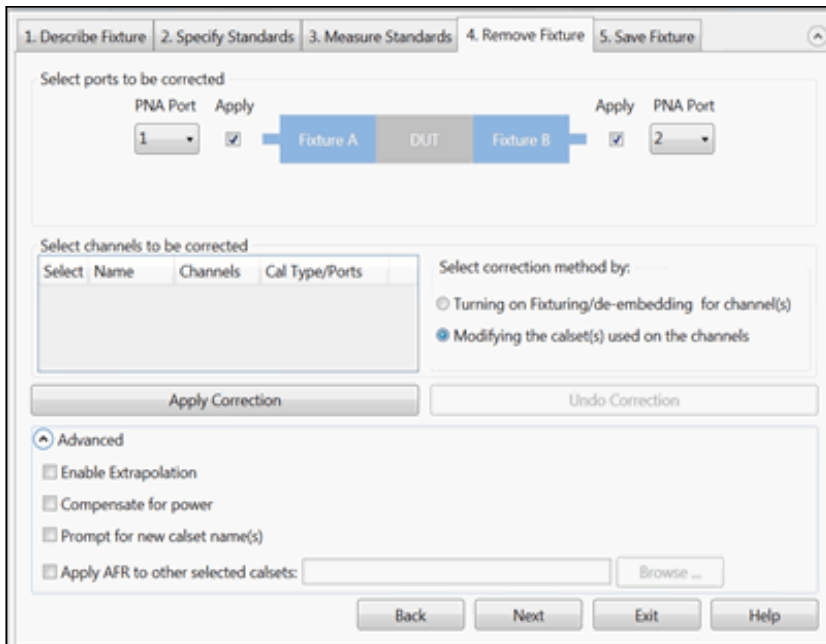

Note: First choose **Select correction method**, then make other selections, then click **Apply Correction**.

Both operations can be performed, but only one at a time.

- **Turning on Fixturing/de-embedding for channels.** Usually only one channel is being used on the VNA, so only one channel will appear in the choices of channels to be corrected.
 - **Select the channels to be corrected.**
 - Fixturing and de-embedding will be enabled for the selected channels in the VNA.
 - Advanced settings
 - **Enable Extrapolation** - When fixture data is loaded from a file and the frequency span of the data is not as wide as that of the channel, check this box to calculate and use linearly-extrapolated fixture data.
 - **Compensate for power** - When checked, test port power is increased to compensate for loss in the fixture.
- **Modifying the calset(s) used on the channels.** Usually only one calset is in use on the VNA, so only one choice would be available.
 - Advanced settings
 - **Enable Extrapolation** - When fixture data is loaded from a file and the frequency span of the data is not as wide as that of the measurement, check this box to calculate and use linearly-

extrapolated fixture data.

- **Compensate for power** - When checked, test port power is increased to compensate for loss in the fixture.
- **Prompt for new calset names** - When cleared, when you apply AFR to a calset, the calset is overwritten. Once done, this process is NOT reversible. When checked, you are prompted to enter a new calset name and the original is preserved. The new calset is written with AFR correction.
- **Apply AFR to other selected Calsets** - When checked, allows you to apply AFR correction to other calsets not currently in use on the VNA. Click Browse, then navigate to the calsets to be corrected.

5. Save Fixture

Select File format to save fixture data:

- **Touchstone (*.snp)**
- **Touchstone 2 (*.ts)**
- **Citifile (*.cti)**

Choose port assignment for save fixture files:

The port assignments are interpreted differently when the file is opened in each program.

Choose which program software you will be using to open the saved file: PLTS, VNA, ADS.

Choose the directory and base names for the saved files:

Click **Browse** to navigate to a directory folder.

With a base file name: The resulting filename will appear as follows (assuming a Touchstone format):

- <base file name>_1.S4P - The left half of a Differential fixture.
- <base file name>_2.S4P - The right half of a Differential fixture.
- <base file name>_1.S2P - The left half of a single-ended fixture.
- <base file name>_2.S2P - The right half of a single-ended fixture.

Click **Save Fixture Files** to save the files to the specified directory.

Port Extensions

Port extensions allow you to electrically move the measurement reference plane after you have performed a calibration.

Note: This feature is available in **GCA** and standard (S-Parameter) channels.

- [Why and How to use Port Extensions](#)
- [Manual Port Extensions Procedure](#)
- [Port Extensions dialog and Toolbar](#)
- [Step Size dialog](#)
- [Automatic Port Extension dialog](#)

See Also

[Data Flow Map](#)

[Fixture Compensation features](#)

[Phase Accuracy](#)

[Comparing the VNA Delay Functions](#)

Other Calibration Topics

Why use Port Extensions

1. You are unable to perform a calibration directly at your device because it is in a test fixture. Perform a calibration at a convenient place, then use port extensions to compensate for the time delay (phase shift), and optionally the loss, caused by the fixture.
2. You have already performed a calibration, and then decide that you need to add a length of transmission line in the measurement configuration. Use port extensions to "tell" the analyzer you have added the length to a specific port.

Important Note: Port Extensions and VNA Data Flow

See [VNA Data Flow diagram](#)

Normally, Port Extensions are applied to individual S-parameters in the **Phase Correction** process and only applies to displayed S-parameters.

However, when **Fixturing** is ON or when making a **Balanced Measurement**, Port Extension compensation is applied in the **Apply Error Terms** process which affects ALL S-parameters, whether displayed or not. This allows all underlying S-parameters to have proper extensions applied.

Therefore, when using Port Extensions with features that require more than a single S-parameter (such as k-factor in equation editor), do one of the following:

- Enable **Fixturing** - Individual Fixturing features are NOT required to be enabled.
- Use **8510 Mode Data Processing**.

When Port Extension compensation is applied in the **Apply Error Terms** process, after a **Data-to-Memory** operation has been performed, further changes to Port Extensions settings will NOT be applied to the Memory trace.

How to use Port Extensions

- If you know the **electrical length** of the fixture or additional transmission line, enter the value directly to the **Time** setting.
- If you know the **physical length** of the fixture or additional transmission line, enter the value directly to the **Distance** setting.
- If you do **NOT** know either the electrical or physical length of the fixture or additional transmission line, you must be able to connect an OPEN or SHORT to the new reference plane - in place of the DUT. In most cases, removing the DUT will leave a suitable OPEN at the new reference plane.
- Port Extensions can then be added manually (as follows), or by using **Automatic Port Extensions**.

Manual Port Extensions Procedure

1. Select a calibrated S11 measurement.
2. Select Phase format.

3. With an OPEN or SHORT at the calibration reference plane, verify that the phase across the frequency span is at or near zero.
4. Connect the fixture or added transmission line and attach an OPEN or SHORT in place of the DUT. In most cases, removing the DUT will leave a suitable OPEN at the new reference plane. On the Port Extension toolbar or dialog, increase either **Time** or **Distance** until the phase response is flat across the frequency span of interest.
5. If you know the loss of the additional transmission line, enter the **Loss Compensation** values using either one or two data points.

Note: Most OPEN and SHORT standards have delay. Therefore, adjusting delay with this method results in a delay equal to two times the delay of the OPEN or SHORT.

How to set Port Extensions

Using **Hardkey/SoftTab/Softkey**

1. Press **Cal** > **Port Extension** > **Port Extensions....**

Programming Commands

Port Extensions dialog and Toolbar help

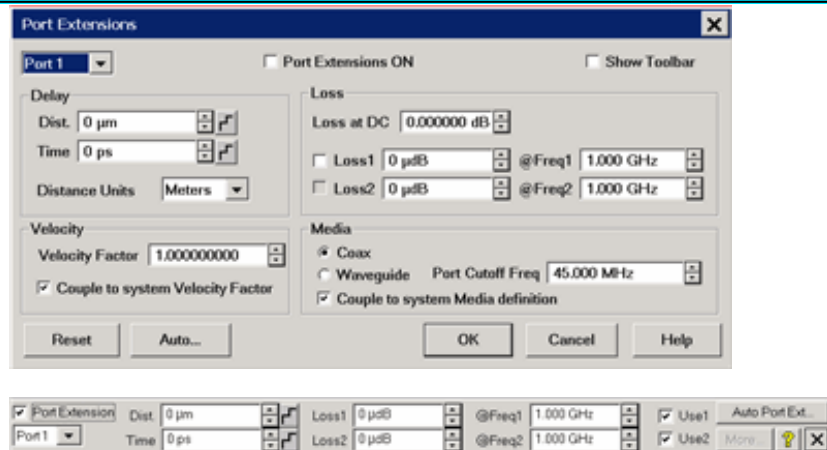

Note: This feature is available to **GCA** and standard (S-Parameter) channels.

Port extensions settings affect all measurements on the active channel that are associated with a particular port.

[Learn Why and How to use Port Extensions](#) (scroll up).

Port Select a port for delay and loss values. Port Extensions settings affect ALL measurements on the active channel that are associated with a particular port.

Port Extension Turns ON and OFF port extensions on all ports.

Show Toolbar Check to show the Port Extensions toolbar. The toolbar allows you to make adjustments to the port extensions while showing more of the screen. This is the only way to show or hide the toolbar.

Delay

Enter delay in either Distance or Time by entering a value or clicking the up/down arrows. Click  to start the **Step Size** dialog.

Time The amount of port extension delay in time. Enter a positive value.

Distance The amount of port extension delay in physical length. Enter a positive value.

Distance Units (Dialog ONLY) Select from Meters, Inches, or Feet. The Step Size setting will not change automatically. [Learn more.](#)

Loss

The following settings allow the entire frequency span to be corrected for loss.

Loss at DC Offsets the entire frequency span by this value. Loss1 or Use1 must also be checked. To compensate for loss at DC, enter a positive value which causes the trace to shift in the positive (up) direction.

Loss @Frequency Check the box, and enter values for Loss and Frequency

When **Loss1** or **Loss1/Loss2** are used, a curved-fit algorithm is used as follows:

Loss1 ONLY:

$$\text{Loss}(f) = \text{Loss1} * (f/\text{Freq1}) ^ 0.5$$

Loss1 and Loss2:

Set the lower frequency to Loss1, and the higher frequency to Loss2.

$$\text{Loss}(f) = \text{Loss1} * (f/\text{Freq1}) ^ n$$

Where:

$$n = \log_{10} [\text{abs}(\text{Loss1}/\text{Loss2})] / \log_{10} (\text{Freq1}/\text{Freq2})$$

Note: abs = absolute value

Velocity

Velocity Factor For each port, sets the velocity factor that applies to the medium of the device that was inserted after the measurement calibration. The value for a polyethylene dielectric cable is 0.66 and 0.7 for PTFE dielectric. 1.0 corresponds to the speed of light in a vacuum.

Couple to system Velocity Factor When unchecked, the Velocity Factor is set for only the specified port and only for Port Extensions. When checked, sets the Velocity Factor for all ports. In addition, changing this value also changes this setting for the **Electrical Delay** and **Time Domain Distance Marker** features.

Media

For each port, select the media of the added transmission line or fixturing.

Coax Select when the fixture or added transmission line is coax. Also specify the velocity factor of the coax.

Waveguide / Cutoff Frequency Select when the fixture or added transmission line is waveguide. Also enter cutoff (minimum) frequency of the waveguide.

Note: when using a Waveguide cal Kit, set **System Z0** to 1 ohm before calibrating.

Couple to system Media Definition. When unchecked, the Waveguide Cutoff Frequency is set for only the specified port and only for Port Extensions. When checked, sets the Waveguide Cutoff Frequency for all ports. In addition, changing this value also changes this setting for the **Electrical Delay** feature.

Reset All port extensions settings are changed to preset values. The Port Extension ON / OFF state is NOT affected.

Auto Ext. Starts the **Automatic Port Extensions** dialog box

Note: Individual receiver port extensions (A,B, and so forth) cannot be set.

Step Size dialog box help



Changes the step size that occurs when the Time or Dist up/down arrows are pressed on the Port Extension toolbar. The Units for step size are changed on the Port Extension dialog.

Auto Step Size is set to the default value.

User Defined Enter a step size value, then click OK.

This value remains the same when the units are changed. For example if a step size of 12 is entered on this dialog, then you change the units from Inches to Feet, the step size of 12 inches becomes 12 feet, not 1 feet. Therefore, change the units first, then set the step size.

Learn about [Port Extensions](#) (scroll up)

Automatic Port Extension dialog box help

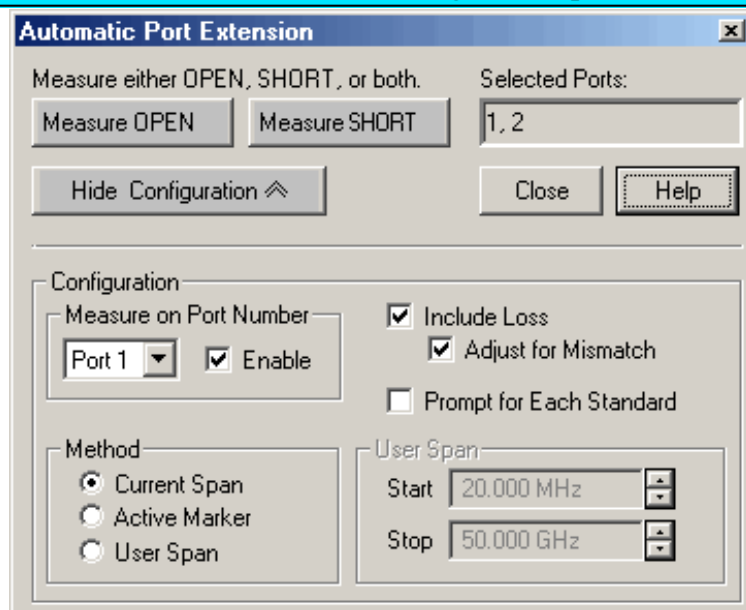

Automatic Port Extension AUTOMATICALLY performs the same operation as [Manual Port Extension](#). By connecting a SHORT or OPEN, the reference plane is automatically moved to the point at which the standard is connected. In addition, Automatic Port Extension will optionally

measure and compensate for the loss of the additional transmission line.

Auto Port Extension is NOT available when:

- Sweep type is set to power sweep
- Frequency Offset is ON
- Media is set to Waveguide

Note: Turn OFF **Equations** that may exist on the active trace when using Automatic Port Extensions.

Auto Port Extensions Procedure

1. Connect the added transmission line or fixture. Attach an OPEN or SHORT to all affected ports at the new reference plane. In most cases, removing the DUT will leave a suitable OPEN at the new reference plane.
2. On the Port Extension toolbar, click **Auto Port Ext**. Click **Show Configuration** to make additional settings.
3. Click **Measure** to perform the port extension calculations. The resulting delay and loss settings are entered into the port extension toolbar. These settings are saved with Instrument Save or you can manually record the values and enter them again when required.

Settings

Measure either OPEN, SHORT, or both Press a button to make the measurement of the reflection standard.

Measure either OPEN or SHORT depending on which is most convenient. An ideal OPEN and SHORT, with zero loss and delay, is assumed. Therefore, accuracy is most affected by the quality of the standard. In most cases, removing the DUT will leave a suitable OPEN at the new reference plane. When measuring both OPEN and SHORT standards, the average of the two is used and will slightly improve accuracy.

Selected Ports Indicates the ports that currently have automatic port extension enabled. By default, ALL analyzer ports are enabled. To disable a port, see **Measure on Port Number** below.

Note: Port Extensions settings affect ALL measurements on the active channel that are associated with a particular port.

Show/Hide Configuration Press to either show or hide the following configuration settings in the dialog box.

Measure on Port Number

Select port number to enable or disable automatic port extension.

Enable Check to enable the specified port. All enabled ports will have their reference plane automatically adjusted after performing Automatic Port Extension.

Include Loss Check to automatically measure the loss in the additional transmission line and apply compensation. To calculate loss compensation, frequencies at 1/4 and 3/4 through the frequency range are usually used as Freq1 and Freq2 values. [Learn more about Loss Compensation.](#)

Adjust for Mismatch Only available when **Include Loss** is checked. Mismatch adds ripple to the S11 and S22 traces. If the ripple is large, S11 and S22 can appear greater than 0 dB which leads to numeric instabilities in using the S-parameters. Adjust for mismatch increases the loss of the fixture so that the peak of the ripples is below 0 dB. While this adds more error (all the error is negative) it does allow the S-parameters to be used in simulators without numerical instabilities.

Check - Offsets the trace to cause all of the data points to be at or below zero.

Clear - Most accurate application of the curve-fit calculation, but allows positive responses.

Prompt for Each Standard Check to invoke a prompt when the Measure OPEN or SHORT button is pressed. The prompt will indicate which standard to connect to which port.

Method

Select the span of data points which will be used to determine correction values for phase and loss (optional). If a portion of the current frequency span does not have flat or linear response, you can eliminate this portion from the calculations by using a reduced User Span.

To calculate loss compensation, Current Span and User Span methods usually use frequencies at 1/4 and 3/4 through the frequency range as Freq1 and Freq2 values. See [Loss Compensation](#) to learn more about how loss is calculated.

Current Span Use the entire frequency span to determine phase and loss values.

Active Marker Use only the frequency at the active marker, and one data point higher in frequency, to calculate phase and loss values. If a marker is not present, one will be created in the center of the frequency span.

User Span Use the following User Span settings to determine phase and loss values.

User Span

Start Enter start frequency of the user span.

Stop Enter stop frequency of the user span.

Learn about [Port Extensions](#) (scroll up).

See also [Comparing Delay Functions](#)

Swap Adapters and Offset Delay Calibration Methods

The Swap Adapters or Offset Delay calibration method is used when you do NOT have calibration standards with the same connector type as your DUT. In this case, the Offset Delay is the preferred calibration method over the Swap Adapters method.

The Swap Adapters calibration method (also known as Swap Equal Adapters and Equal Length Adapters) was used in the past as a quick alternative to the more tedious **adapter removal** method. This method requires that the adapters be of equal electrical length. There are two adapters for each port. The swap equal adapter method implicitly assumes the adapters have identical return loss. The finite return loss of each adapter on each port degrades both the residual directivity and residual match terms. The offset delay calibration only has one adapter. The return loss of this one adapter will degrade the residual directivity and residual match error terms.

Note: For any other reason, these calibration methods are **NOT** recommended because the **Unknown Thru** method is more convenient AND more accurate.

The Offset Delay calibration method uses the available standards for calibration then adds offset delay to the measurement plane to account for each adapter used. This eliminates the need for adapters with equal electrical length and is preferred over the Swap Adapters method.

Swap Adapters Procedure

The following is an example procedure showing how to perform a Swap Adapters 2-port calibration for a non-insertable DUT. The DUT has 2.92 mm connectors. You do NOT have 2.92 mm calibration standards, but you DO have 2.4 mm standards and adapters that have the same electrical delay as the 2.92 mm adapters.

Adapters A1 and A2 = test port to 2.4 mm adapters

Adapters B1 and B2 = test port to 2.92 mm adapters

1. Start the Cal Wizard and select Guided (Smart) Cal. **Note:** The VNA will NOT prompt you to connect the adapters by name or when to swap the adapters.

2. Specify the connector type and gender and Cal Kit of the adapter that you will be using (2.4 mm) - NOT the connector type of the DUT (2.92 mm). By specifying the connector gender, you are also specifying the Thru method (flush thru for insertable and Unknown Thru for non-insertable.) For example, when both DUT ports have female connectors, we will perform an Unknown Thru cal.

3. When prompted for reflection standards on port 1, connect the Open, Short, and Load standards to Adapter A1.

4. When prompted for reflection standards on port 2, connect the Open, Short, and Load standards to Adapter A2.

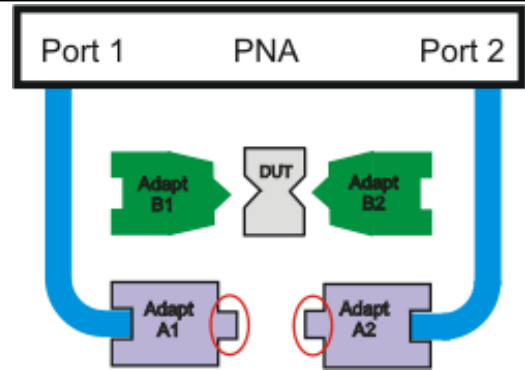

5. When prompted for a Thru connection, swap Adapter A1 and A2 for B1 and B2. Connect the Thru device. This could be any device that meets the requirements of the **Unknown Thru standard**. In the case of a non-insertable DUT, connect B1 and B2.

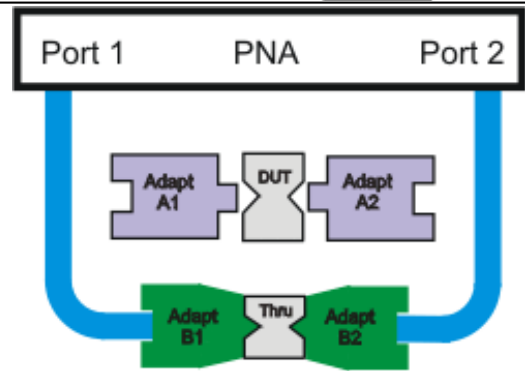

6. Make DUT measurements with Adapters B1 and B2 in place.

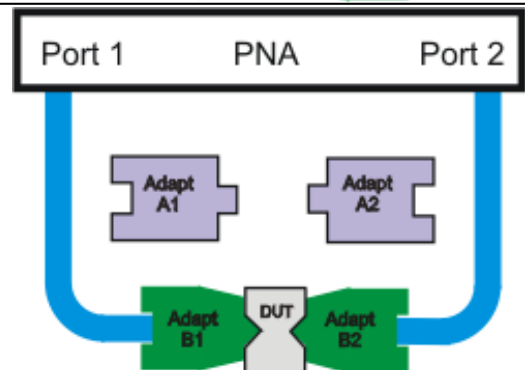

Offset Delay Procedure

The following is an example procedure showing how to perform a 2-port calibration for a non-insertable DUT using Offset Delay to account for the added delay of two adapters. The DUT has 2.92

mm connectors. You do NOT have 2.92 mm calibration standards, but you DO have 2.4 mm standards and adapters.

Adapters = test port to 2.4 mm (female)-to-2.92 mm (male) adapters

1. Start the Cal Wizard and select Guided (Smart) Cal.

2. Specify the connector type and gender and Cal Kit that you will be using (2.4 mm) - NOT the connector type of the DUT (2.92 mm). By specifying the connector gender, you are also specifying the Thru method (flush thru for insertable and Unknown Thru for non-insertable.) For example, when both DUT ports have female connectors, we will perform an Unknown Thru cal.

3. When prompted for reflection standards on port 1, connect the Open, Short, and Load standards.

4. When prompted for reflection standards on port 2, connect the Open, Short, and Load standards.

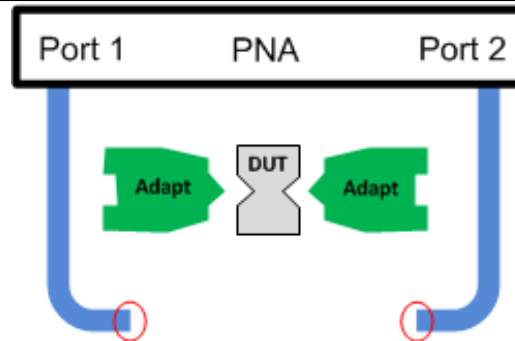

5. When prompted for a Thru connection, connect the Thru device between port 1 and port 2. This could be any device that meets the requirements of the **Unknown Thru standard**. In this example of a non-insertable DUT, a female-to-female 2.4 mm barrel adapter is used as the Thru device.

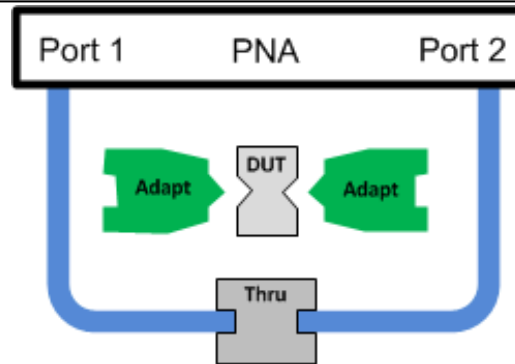

6. Click on **Response, Cal**, then select **Port Extension**. The Port Extension dialog is used to electrically move the measurement reference plane after you have performed a calibration to account for the two adapters. Learn more about **Port Extensions**.

7. Select Port 1 and enter the delay of the adapter connected to Port 1.

8. Select Port 2 and enter the delay of the adapter connected to Port 2.

9. Click **OK**.

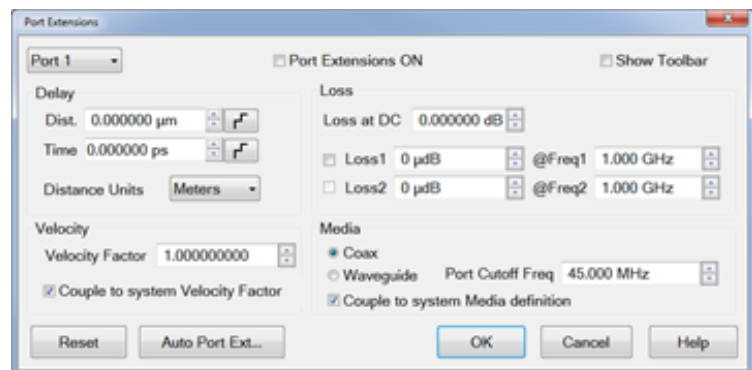

10. Make DUT measurements with Adapters and DUT in place.

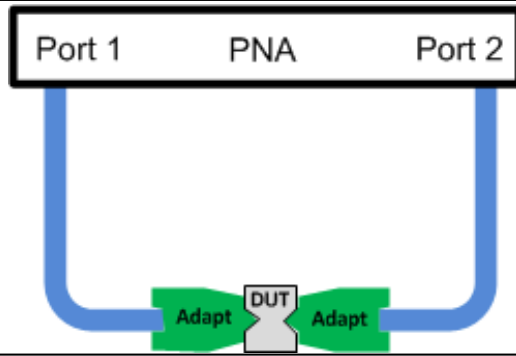

Calibration Overview

The following is discussed in this topic:

- [What Is Measurement Calibration?](#)
- [Why Is Calibration Necessary?](#)
- [Conditions Where Calibration Is Suggested](#)
- [What Is ECal?](#)

[See other Calibration Topics](#)

What Is Measurement Calibration?

Calibration removes one or more of the systematic errors using an equation called an error model. Measurement of high quality standards (for example, a short, open, load, and thru) allows the analyzer to solve for the error terms in the error model. See [Measurement Errors](#).

You can choose from different calibration types, depending on the measurement you are making and the level of accuracy you need for the measurement. See [Select a Calibration Type](#).

The accuracy of the calibrated measurements is dependent on the quality of the standards in the calibration kit and how accurately the standards are modeled (defined) in the calibration kit definition file. The calibration-kit definition file is stored in the analyzer. In order to make accurate measurements, the calibration-kit definition must match the actual calibration kit used. To learn more, see [Accurate Calibrations](#).

Calibration Wizard provides the different calibration methods used in the VNA. See [Calibration Wizard](#).

There are quick checks you can do to ensure your measurement calibration is accurate. To learn more see [Validity of a Measurement Calibration](#)

If you make your own custom-built calibration standards (for example, during in-fixture measurements), then you must characterize the calibration standards and enter the definitions into a user modified calibration-kit file. For more information on modifying calibration kit files, see [Calibration Standards](#).

Note: [Instrument Calibration](#) is ensuring the analyzer hardware is performing as specified. This is not the same as measurement calibration.

Why Is Calibration Necessary?

It is impossible to make perfect hardware that would not need any form of **error correction**. Even making the hardware good enough to eliminate the need for error correction for most devices would be extremely expensive.

The accuracy of network analysis is greatly influenced by factors external to the network analyzer. Components of the measurement setup, such as interconnecting cables and adapters, introduce variations in magnitude and **phase** that can mask the actual response of the device under test.

The best balance is to make the hardware as good as practically possible, balancing performance and cost. Calibration is then a very useful tool to improve measurement accuracy.

Conditions Where Calibration Is Suggested

Generally, you should calibrate for making a measurement under the following circumstances:

- You want the best accuracy possible.
- You are adapting to a different connector type or impedance.
- You are connecting a cable between the test device and an analyzer test port.
- You are measuring across a wide frequency span or an electrically long device.
- You are connecting an attenuator or other such device on the input or output of the test device.

If your test setup meets any of the conditions above, the following system characteristics may be affected:

- Amplitude at device input
- Frequency response accuracy
- Directivity
- Crosstalk (isolation)
- Source match
- Load match

What Is ECAL

ECal is a complete solid-state calibration solution. It makes one port (Reflection), full two and three-

port calibrations fast and easy. See [Using ECal](#).

- It is less prone to operator error.
- The various standards (located inside the calibration module) never wear out because they are switched with PIN-diode or FET switches.
- The calibration modules are characterized using a TRL-calibrated network analyzer.
- ECal is not as accurate as a good TRL calibration.

For information about ordering ECal modules, see [Analyzer Accessories](#) or contact your [Keysight Support Representative](#)

Measurement Errors

You can improve accuracy by knowing how errors occur and how to correct for them. This topic discusses the sources of measurement error and how to monitor error terms.

- [Drift Errors](#)
- [Random Errors](#)
- [Systematic Errors](#)
 - [3-Port Error Terms](#)
 - [4-Port Error Terms](#)
- [Monitoring Error Terms](#)

[See other Calibration Topics](#)

Drift Errors

Drift errors are due to the instrument or test-system performance changing after a calibration has been done.

Drift errors are primarily caused by thermal expansion characteristics of interconnecting cables within the test set and conversion stability of the microwave frequency converter and can be removed by re-calibrating.

The time frame over which a calibration remains accurate is dependent on the rate of drift that the test system undergoes in your test environment.

Providing a stable ambient temperature usually minimizes drift. For more information, see [Measurement Stability](#).

Random Errors

Random errors are not predictable and cannot be removed through error correction. However, there are things that can be done to minimize their impact on measurement accuracy. The following explains the three main sources of random errors.

Instrument Noise Errors

Noise is unwanted electrical disturbances generated in the components of the analyzer. These disturbances include:

- Low level noise due to the broadband noise floor of the receiver.
- High level noise or jitter of the trace data due to the noise floor and the phase noise of the LO source inside the test set.

You can reduce noise errors by doing one or more of the following:

- Increase the **source power** to the device being measured - ONLY reduces low-level noise.
- **Narrow the IF bandwidth.**
- Apply several measurement **sweep averages.**

Switch Repeatability Errors

Mechanical RF switches are used in the analyzer to switch the source attenuator settings.

Sometimes when mechanical RF switches are activated, the contacts close differently from when they were previously activated. When this occurs, it can adversely affect the accuracy of a measurement.

You can reduce the effects of switch repeatability errors by avoiding switching attenuator settings during a critical measurement.

Connector Repeatability Errors

Connector wear causes changes in electrical performance. You can reduce connector repeatability errors by practicing good connector care methods. See [Connector Care](#).

Systematic Errors

Systematic errors are caused by imperfections in the analyzer and test setup.

- They are repeatable (and therefore predictable), and are assumed to be time invariant.
- They can be characterized during the calibration process and mathematically reduced during measurements.
- They are never completely removed. There are always some residual errors due to limitations in the calibration process. The residual (after measurement calibration) systematic errors result from:
 - imperfections in the calibration standards
 - connector interface

- interconnecting cables
- instrumentation

Reflection measurements generate the following three systematic errors:

- Directivity
- Source Match
- Frequency Response Reflection Tracking

Transmission measurements generate the following three systematic errors:

- Isolation
- Load Match
- Frequency Response Transmission Tracking

Notes about the following Systematic Error descriptions:

- The figures for the following six systematic errors show the relevant hardware configured for a forward measurement. For reverse measurements, internal switching in the analyzer makes Port 2 the source and Port 1 the receiver. 'A' becomes the transmitted receiver, 'B' becomes the reflected receiver, and 'R2' becomes the reference receiver. These six systematic errors, times two directions, results in 12 systematic errors for a two port device.
- For simplicity, it may be stated that ONE standard is used to determine each systematic error. In reality, ALL standards are used to determine ALL of the systematic errors.
- The following describes an SOLT calibration. This does not apply to TRL or other types of calibration.

Directivity Error

All network analyzers make reflection measurements using directional couplers or bridges.

With an ideal coupler, only the reflected signal from the DUT appears at the 'A' receiver. In reality, a small amount of incident signal leaks through the forward path of the coupler and into the 'A' receiver. This leakage path, and any other path that allows energy to arrive at the 'A' receiver without reflecting off the DUT, contributes to directivity error.

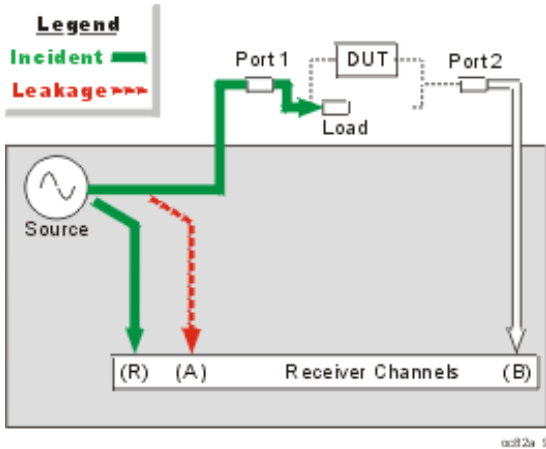

How the Analyzer Measures and Reduces Directivity Error.

1. During calibration, a load standard is connected to Port 1. We assume no reflections from the **load**.
2. The signal measured at the 'A' receiver results from the incident signal leakage through the coupler and other paths.
3. Directivity error is mathematically removed from subsequent reflection measurements.

Isolation Error

Ideally, only signal transmitted through the DUT is measured at the 'B' receiver.

In reality, a small amount of signal leaks into the 'B' receiver through various paths in the analyzer.

The signal leakage, also known as crosstalk, is isolation error which can be characterized and reduced by the analyzer.

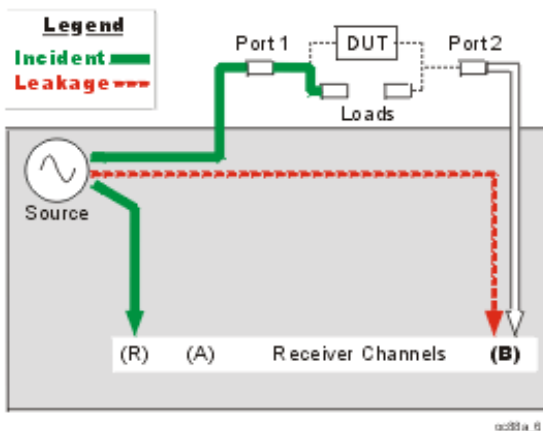

How the Analyzer Measures and Reduces Isolation Error

1. During calibration, load standards are connected to both Port 1 and Port 2.
2. The signal measured at the 'B' receiver is leakage through various paths in the analyzer.
3. This isolation error is mathematically removed from subsequent transmission measurements.

Source Match Error

Ideally in reflection measurements, all of the signal that is reflected off of the DUT is measured at the 'A' receiver.

In reality, some of the signal reflects off the DUT, and multiple internal reflections occur between the analyzer and the DUT. These reflections combine with the incident signal and are measured at the 'A' receiver, but not at the 'R' receiver.

This measurement error is called source match error which can be characterized and reduced by the analyzer.

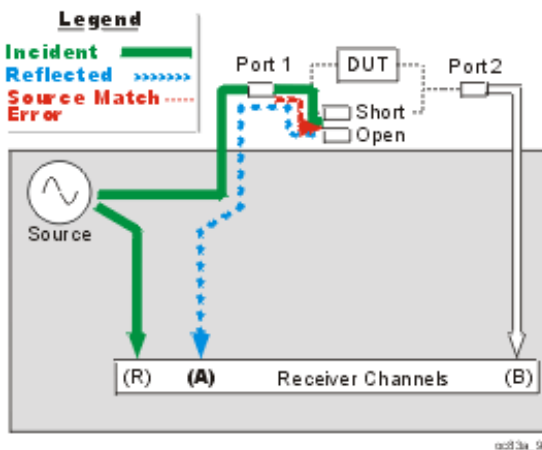

How the Analyzer Measures and Reduces Source Match Error

1. During calibration, all reflection standards are connected to Port 1. Known reflections from the standards are measured at the 'A' receiver.
2. Complex math is used to calculate source match error.
3. Source match error is mathematically removed from subsequent reflection and transmission measurements.

Load Match Error

Ideally in transmission measurements, an incident signal is transmitted through the DUT and is measured at the 'B' receiver.

In reality, some of the signal is reflected off of Port 2 and other components and is not measured at the

'B' receiver.

This measurement error is called load match error which can be characterized and reduced by the analyzer.

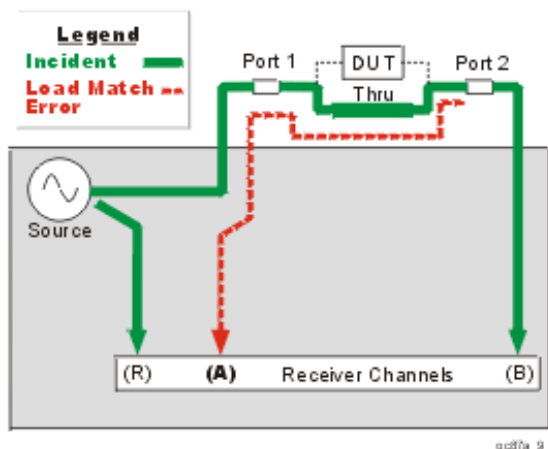

How the Analyzer Measures and Reduces Load Match Error

1. The Port 1 and Port 2 test connectors are mated together for a perfect zero-length thru connection. If this is not possible, a **characterized thru adapter** is inserted. This allows a known amount of incident signal at Port 2.
2. The signal measured at the 'A' receiver is reflection signal off of Port 2
3. The resulting load match error is mathematically removed from subsequent transmission and reflection measurements.

Frequency Response Reflection Tracking Error

Reflection measurements are made by comparing signal at the 'A' receiver to signal at the 'R1' receiver. This is called a ratio measurement or "A over R1" (A/R1).

For ideal reflection measurements, the frequency response of the 'A' and 'R1' receivers would be identical.

In reality, they are not, causing a frequency response reflection tracking error. This is the vector sum of all test variations in which magnitude and phase change as a function of frequency. This includes variations contributed by:

- signal-separation devices
- test cables
- adapters
- variations between the reference and test signal paths

Frequency response reflection tracking error can be characterized and reduced by the analyzer.

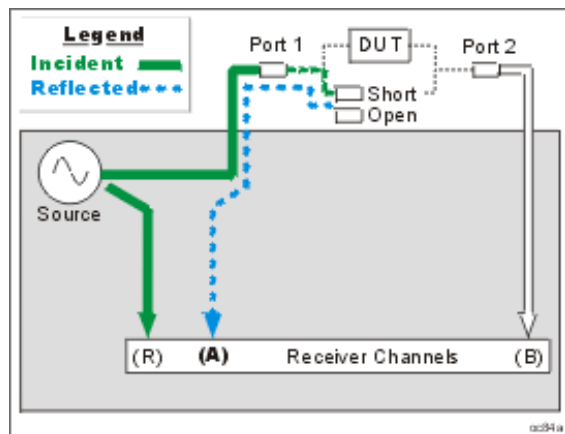

How the Analyzer Measures and Reduces Frequency Response Reflection Tracking Error.

1. During calibration, all reflection standards are used to determine reflection tracking.
2. The average 'A' receiver response is compared with the 'R1' receiver response.
3. Complex math is used to calculate Frequency Response Reflection Tracking Error (see the following diagram). This frequency response reflection tracking error is mathematically removed from subsequent DUT measurements.

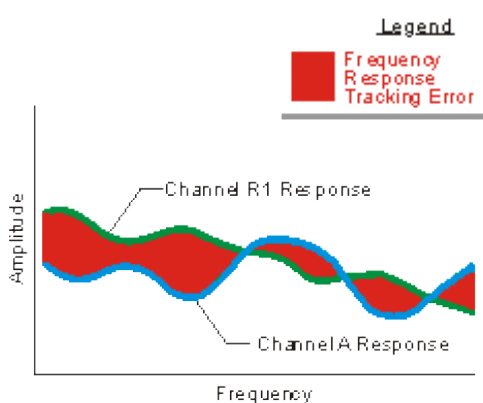

Note: In reflection response calibrations, only a single calibration standard is measured (open or short) and thus only its contribution to the error correction is used.

Frequency Response Transmission Tracking Error

Transmission measurements are made by comparing signal at the 'B' receiver to signal at the 'R1' receiver. This is called a ratio measurement or "B over R1" (B/R1).

For ideal transmission measurements, the frequency response of the 'B' and 'R1' receivers would be

identical.

In reality, they are not, causing a frequency response transmission tracking error. This is the vector sum of all test variations in which magnitude and phase change as a function of frequency. This includes variations contributed by:

- signal-separation devices
- test cables
- adapters
- variations between the reference and test signal paths

Frequency response transmission tracking error can be characterized and reduced by the analyzer.

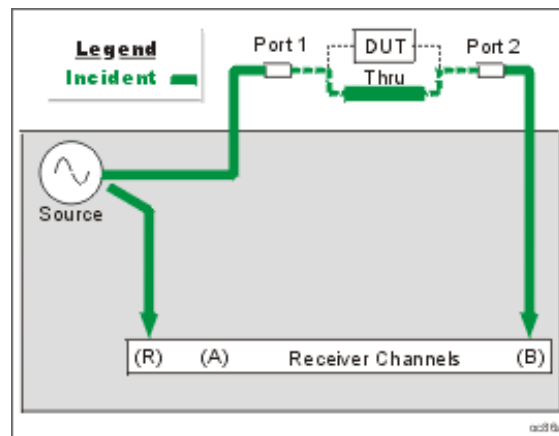

How the Analyzer Measures and Reduces Frequency Response Transmission Tracking Error.

1. During calibration, the Port 1 and Port 2 test connectors are mated together for a perfect zero-length thru connection. If this is not possible, a **characterized thru adapter** is inserted. This allows a known amount of incident signal to reach Port 2.
2. Measurements are made at the 'B' and 'R1' receivers.
3. Complex math is used to calculate Frequency Response Transmission Tracking Error (see the following diagram). This frequency response transmission tracking error is mathematically removed from subsequent **DUT** measurements.

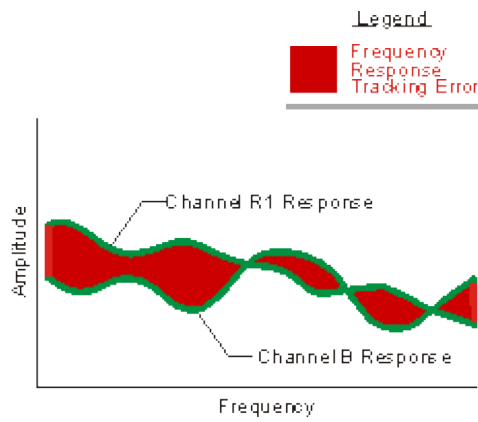

3-Port Error Terms

The following flow diagram displays the 3-port error term model:

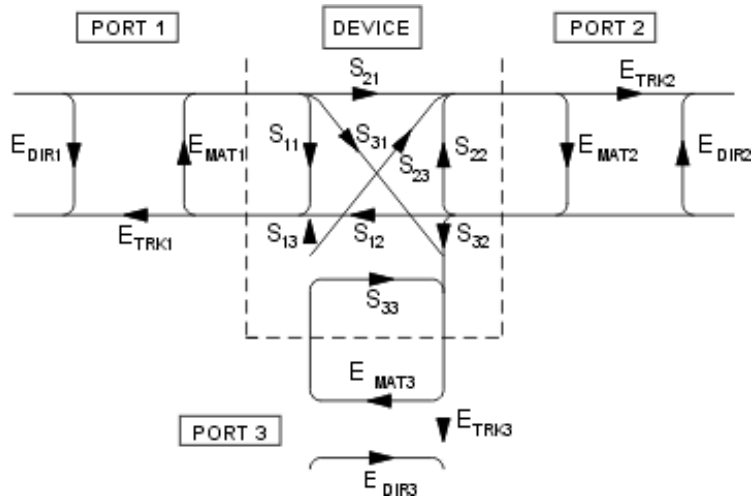

where:

E = error term

DIR = Directivity

MAT = Forward Source Match and Reverse Load Match

TRK = Forward Reflection Tracking and Reverse Transmission Tracking

4-Port error terms

A full 4-port calibration requires the following terms:

Learn about the [port numbering convention](#) for error terms.

		Source Port			
		1	2	3	4
R e c e i v e	1	DIR 1,1 RTRK 1,1 SRM 1,1	LDM 1,2 TTRK 1,2 XTLK 1,2	LDM 1,3 TTRK 1,3 XTLK 1,3	LDM 1,4 TTRK 1,4 XTLK 1,4
	2	LDM 2,1 TTRK 2,1 XTLK 2,1	DIR 2,2 RTRK 2,2 SRM 2,2	LDM 2,3 TTRK 2,3 XTLK 2,3	LDM 2,4 TTRK 2,4 XTLK 2,4
	3	LDM 3,1 TTRK 3,1 XTLK 3,1	LDM 3,2 TTRK 3,2 XTLK 3,2	DIR 3,3 RTRK 3,3 SRM 3,3	LDM 3,4 TTRK 3,4 XTLK 3,4
	4	LDM 4,1 TTRK 4,1 XTLK 4,1	LDM 4,2 TTRK 4,2 XTLK 4,2	LDM 4,3 TTRK 4,3 XTLK 4,3	DIR 4,4 RTRK 4,4 SRM 4,4

Reflection terms

- DIR: Directivity

- RTRK: Reflection Tracking
- SRM: Source Match

Transmission terms

- LDM: Load Match
- TTRK: Transmission Tracking
- XTLK: Cross Talk

How can we measure only 3 THRU connections?

On a 4-port VNA, a full 4-port cal can be performed while measuring only 3 THRU connections. Measuring more than 3 THRU connections on a VNA with four native ports can give higher accuracy under some conditions.

By measuring all of the reflection terms, and 3 transmission THRU connections, there is adequate information available to calculate the remaining transmission terms. The following is a high level explanation of the concept. The actual calculations are much more complex.

To simplify, let's substitute letters (A,B,C,D) for port numbers from the diagram above so that they can be combined without confusion. Also for simplicity, let's assume that the source match and directivity errors are zero.

	A	B	C	D
A	AA	AB	AC	AD
B	BA	BB	BC	BD
C	CA	CB	CC	CD
D	DA	DB	DC	DD

- The reflection errors are all measured (AA, BB, CC, DD).
- Lets assume we measure a THRU between ports AB, AC, AD. The reverse direction for these THRU's are also measured at the same time (BA, CA, DA).
- The terms left to calculate are BC, CB, BD, DB, CD, DC.

The following shows how the BC term is calculated from BA and AC:

$$\frac{BA * AC}{AA} = \frac{B * \cancel{AA} * C}{\cancel{AA}} = BC$$

Similarly:

- CB is calculated from CA and AB
- BD is calculated from BA and AD
- DB is calculated from AB and DA
- CD is calculated from CA and AD
- DC is calculated from DA and AC

Monitoring Error Terms using Cal Set Viewer

You can use **Cal Set Viewer** to monitor the measured data and the calculated error term. This will help to determine the health of your VNA and the accuracy of your measurements.

By printing or saving the error terms, you can periodically compare current error terms with previously recorded error terms that have been generated by the same VNA, measurement setup, and calibration kit. If previously generated values are not available, refer to Typical Error Term Data in Appendix A, "Error Terms", of the Service Guide.

Note: The service guide for your VNA is available at <http://www.Keysight.com/find/pna>

- A stable system should generate repeatable error terms over about six months.
- A sudden shift in error terms over the same frequency range, power, and receiver settings, may indicate the need for troubleshooting system components. For information on troubleshooting error terms, see Appendix A , "Error Terms", of the Service Guide.
- A subtle, long-term shift in error terms often reflects drift or connector and cable wear. The cure is often as simple as cleaning and gauging connectors or inspecting cables.

Viewing Cal Set Data

- Existing measurement traces are unaffected by the Cal Set Viewer.
- The Cal Set data trace is presented in the highest unused channel number (usually 32) in the active window.
- The Cal Set data trace is labeled as S11 in the status bar regardless of the type of error term or standard.
- Only one Cal Set error term or standard data can be viewed at a time. However, a data trace can be stored into memory and then compared to other data traces.

See the error terms equations.

How to access Cal Set Viewer

Using **Hardkey/SoftTab/Softkey**

1. Press **Cal** > **Cal Sets & Cal Kits** > **Cal Set Viewer ON|OFF**

Programming Commands

How to use Cal Set Viewer

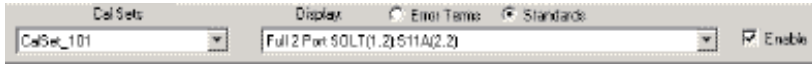

1. Use the down arrow to select a Cal Set. Then click either:
 - **Error Terms** - calculated data.
 - **Standards** - the raw measurement data of the Standard. **ONLY** available with Unguided Cal (not ECal or Guided Cal).
2. Use the down arrow to select an error term or standard to view.
3. Select the **Enable** check box to view the data on the VNA screen.

Port numbering convention for error terms is the same as for S-Parameters:

E Term (Receiver, Source) with the following exceptions:

- Load Match (2,1) - The match of port 2 which is measured by making an S11 measurement.
- Load Match (1,2) - The match of port 1 which is measured by making an S22 measurement.
- Transmission Tracking (2,1) - The port 2 receiver relative to the port 1 reference. (source=port 1).
- Transmission Tracking (1,2) - The port 1 receiver relative to the port 2 reference. (source=port 2).
- And so forth for multiport calibrations.

M980xA, P50xxA have the **receiver gain** setting capability. Each port has high/low setting and each setting has independent error term.

E Term (Receiver, Source) [receiver gain, source gain] (high:1, low:0 for gain) with the following exceptions:

- Transmission Tracking (2,1) - The port 2 receiver relative to the port 1 reference with low gain for both 1 and port. (source=port 1)

- Transmission Tracking (2,1) [1,0] - The port 2 receiver relative to the port 1 reference with high gain for port 2, low gain for port 1. (source=port 1)
 - Transmission Tracking (2,1) [0,1] - The port 2 receiver relative to the port 1 reference with low gain for port 2, high gain for port 1. (source=port 1)
 - Transmission Tracking (2,1) [1,1] - The port 2 receiver relative to the port 1 reference with high gain for both 1 and port. (source=port 1)
-

Accurate Measurement Calibrations

Calibration accuracy is affected by the type of calibration, quality of the calibration standards, and the care with which the calibration is performed. This section provides additional information about how to make accurate calibrations.

- [Measurement Reference Plane](#)
- [Effects of Using Wrong Calibration Standards](#)
- [Data-based versus Polynomial Calibration Kits](#)
- [Accuracy Level of Interpolated Measurement](#)
- [Effects of Power Level](#)
- [Using Port Extensions](#)
- [Isolation Portion of 2-Port Calibration](#)
- [Choosing a Thru Method](#)

Learn how to [determine the validity of your calibration](#).

[See other Calibration Topics](#)

Measurement Reference Plane

Most measurement setups will NOT allow you to connect a device under test (DUT) directly to the analyzer front panel test ports. More likely, you would connect your device to test fixtures, adapters, or cables that are connected to the analyzer.

A calibration takes place at the points where calibration standards are connected during the calibration process. This is called the measurement reference plane (see graphic). For the highest measurement accuracy, make the calibration reference plane the place where your DUT is connected. When this occurs, the errors associated with the test setup (cables, test fixtures, and adapters used between the analyzer ports and the reference plane) are measured and removed in the calibration process.

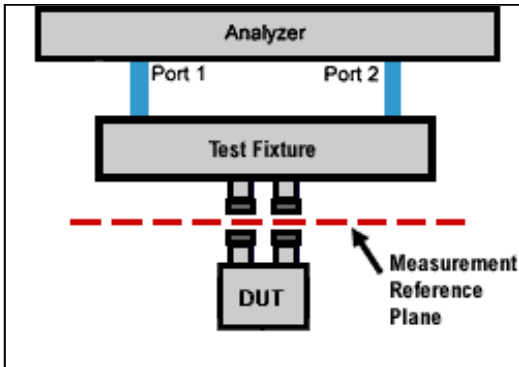

Effects of Using Wrong Calibration Standards

Normally, a calibration is performed using a calibration kit that contains standards with connectors of the same type and sex as your DUT.

However, your calibration kit may not always have the same connector type and gender as your device. For example, suppose your device has 3.5mm connectors, but you have a Type-N calibration kit. If you use an adapter to connect the Type-N standards to the 3.5mm test port, then the adapter becomes part of the calibration and NOT part of the test setup. This will result in significant errors in your reflection measurements.

Data-based versus Polynomial Calibration Kits

The [Select DUT Connectors and Cal Kits](#) dialog box offers a data-based model and a polynomial model for the newest high-frequency cal kits. See [Analyzer Accessories](#). The data-based models provide higher accuracy for describing calibration standards than the polynomial models. It is RECOMMENDED that the data-based model be used if the most accurate results are desired.

	Data-Based Model	Polynomial Model
How accurate is the model?	Provides highest calibration accuracy. Eliminates the errors that can be the result of polynomial model approximations.	Provides high calibration accuracy.
How does the model define calibration standards?	Uses S-Parameter measurements.	Uses traditional four-term polynomial calibration standard modeling parameters.
How do I manually edit the definitions of the calibration standards when using the model?	Use the Advanced Modify Cal Kit function.	Use the Advanced Modify Cal Kit function.

How do I use the Calibration Wizard with the model?	Use only the SmartCal (Guided) Calibration method.	Use the SmartCal (Guided) or the Unguided Mechanical Calibration methods.
--	--	---

Learn about the [“Expanded Math”](#) feature.

Effects of Power Level

To attain the most accurate error correction, do NOT change the power level after a calibration is performed. However, when changing power within the same attenuator range at which the measurement calibration was performed, S-parameter measurements can be made with only a small degradation of accuracy. If a different attenuator range is selected, the accuracy of error correction is further degraded.

To check the accuracy of a calibration, see [Validity of a Calibration](#).

Using Port Extensions

Use the port extensions feature after calibration to compensate for phase shift of an extended measurement reference plane due to additions such as cables, adapters, or fixtures.

Port extensions is the simplest method to compensate for phase shift, mismatch, and loss of the path between the calibration reference plane and the DUT.

Learn how to apply [port extensions](#).

Learn about [characterizing a test fixture](#).

Isolation Portion of 2-Port Calibration

The isolation portion of a calibration corrects for crosstalk, the signal leakage between test ports when no device is present. When performing an UNGUIDED 2-port calibration, you have the option of omitting the isolation portion of the calibration.

Note: Isolation can be performed on a Smart (Guided) Calibration ONLY

Note: Isolation is supported only when the [receiver gain](#) are set at LOW for both ports.

The uncorrected isolation between the test ports of the analyzer is exceptional (typically >100 dB). Therefore, you should only perform the Isolation portion of a 2-port calibration when you require isolation that is better than 100 dB. Perform an isolation calibration when you are testing a device with high insertion loss, such as some filter stopbands or a switch in the open position.

The isolation calibration can add noise to the error model when the measurement is very close to the noise floor of the analyzer. To improve measurement accuracy, set a narrow IF Bandwidth.

How to perform an Isolation Calibration

Isolation is measured when the Load standards are connected to the analyzer test ports. For best accuracy, connect Load standards to BOTH test ports each time you are prompted to connect a load standard. If two Loads are not available, connect the untested analyzer port to any device that will present a good match.

Important Notes:

1. For best results, the average factor should be increased while measuring the isolation standards. Doing an isolation without increasing averaging you are generally adding noise to the measurement rather than correcting for isolation. This PNA automatically increases the average factor by 8 during the isolation steps of a calibration to minimize the noise degradation that would otherwise be present.
2. SmartCal did not add the ability to do an isolation calibration from the GUI because it is usually only needed in special cases. The isolation calibration can be done using the following commands:
 - o `SENSe<ch>:CORRection:COLLect:GUIDed:ISOLation:AVERAge:INCRement` or `IsolationAveragingIncrement`
 - o `SENSe<ch>:CORRection:COLLect:GUIDed:ISOLation:PATHs` or `GetIsolationPaths` and `SetIsolationPaths`
3. Doing an isolation calibration is generally only useful when crosstalk is an issue-this may happen if the fixture added contributes significant crosstalk.

Choosing a Thru Method

When calibrating for a non-insertable device, you must choose a method to calibrate for the THRU error terms. This can have a significant effect on measurement accuracy. Learn more about [choosing a thru method](#).

Validity of a Calibration

This section helps you determine if your calibration is valid and how the analyzer displays correction level information for your measurement.

- [Frequency Response of Calibration Standards](#)
- [Validating a Calibration](#)
- [Quick Check](#)
- [ECal Confidence Check](#)
- [Determining Effects of Not Terminating Unused ECal Ports](#)
- [Verification Kit](#)

See other Calibration Topics

Frequency Response of Calibration Standards

In order for the response of a calibration standard to show as a dot on the [smith chart display format](#), it must have no phase delay with respect to frequency. The only standards that exhibit such "perfect" response are the following:

- 7-mm short (with no offset)
- Type-N male short (with no offset)

There are two reasons why other types of calibration standards show phase delay after calibration:

1. The reference plane of the standard is electrically offset from the mating plane of the test port. Such devices exhibit the properties of a small length of transmission line, including a certain amount of phase shift.
2. The standard is an open termination, which by definition exhibits a certain amount of fringe capacitance and therefore phase shift. Open terminations which are offset from the mating plane will exhibit a phase shift due to the offset in addition to the phase shift caused by the fringe capacitance.

The most important point to remember is that all standards are measured in order to remove [systematic errors](#) from subsequent device measurements. As a result, if calibration standards with

delay and fringe capacitance are measured as a device after a calibration, they will NOT appear to be "perfect". This is an indication that your analyzer is **calibrated accurately and working properly**.

Validating a Calibration

At the completion of a calibration or selection of a stored Cal Set, validation can accomplish the following:

Improve Measurement Accuracy – Once a measurement calibration has been performed, its performance should be checked before making device measurements. There are several sources of error that can invalidate a calibration: bad cables, dirty or worn calibration standards that no longer behave like the modeled standards, and operator error.

Verify Accuracy of Interpolation – You should validate the calibration if you are testing a device and the measurements are uncertain because of interpolation. For more information see [Interpolation Accuracy](#).

Verify Accuracy of Cal Standards – To check accuracy, a device with a known magnitude and phase response should be measured.

Quick Check

For this test, all you need are a few calibration standards. The device used should not be one of the calibration standards; a measurement of one of these standards is merely a measure of repeatability.

The following reflection and transmission Quick Check tests can be applied to all test ports.

To verify reflection measurements, perform the following steps:

1. Connect either an OPEN or SHORT standard to port 1. The magnitude of S11 should be close to 0 dB (within a few tenths of a dB).
2. Connect a load calibration standard to port 1. The magnitude of S11 should be less than the specified calibrated directivity of the analyzer (typically less than -30 dB).

To verify transmission measurements:

1. Connect a THRU cable (or known device representative of your measurement) from port 1 to port 2. Verify the loss characteristics are equivalent to the known performance of the cable or device.
2. To verify S21 isolation, connect two loads: one on port 1 and one on port 2. Measure the magnitude of S21 and verify that it is less than the specified isolation (typically less than -80 dB).

Note: To get a more accurate range of expected values for these measurements, consult the analyzer's specifications.

ECal Confidence Check

ECal Confidence Check is a method to check the accuracy of a calibration performed with mechanical standards or an ECal module. The confidence check allows you to measure an impedance state in the ECal module (called the confidence state), and compare it with factory measured data stored in the module.

In order for this test to be valid, the test ports of the ECal module must connect directly to the calibration reference plane (without adapters).

Note: In the **N469x** series of 2-port ECal modules, from the module minimum frequency up to approximately 2 GHz, the confidence state has a very high amount of transmission loss. In this frequency range, calibrated measurements of transmission S-parameters for the confidence state may vary much more than expected from the Keysight-characterized data in the measurement memory trace. When comparing the measurement trace and memory trace you, ignore the data for frequencies up to 2 GHz.

How to Perform ECal Confidence Check:

1. Connect ECal module to the analyzer with the USB cable. See [Connect ECal Module to the VNA](#). **Note:** Terminate any unused ECAL ports with a 50 ohm load. [See below](#).
2. Allow the module to warm up for 15 minutes or until the module indicates **READY**.
3. Do one of the following to start ECal Confidence Check

Using [Hardkey](#)/[SoftTab](#)/[Softkey](#)

1. Press [Cal](#) > [Cal Sets & Cal Kits](#) > [ECal](#) > [ECal Confidence Check...](#)

[Programming Commands](#)

On the following [ECal Confidence Check dialog box](#):

2. Click **Read Module Data**. The following occurs:
 - ECal module is set to "confidence state".
 - Analyzer reads and displays stored data.
 - Analyzer measures and displays "confidence state".

3. To view a different parameter, select **Change Measurement** and select the check box for the desired parameter. The default is the active channel parameter.
4. Select the viewing option in the Trace View Options block.
5. Compare the stored and measured data for each measurement parameter.

Notes:

- After exiting ECal Confidence Check, the ECal module remains in the same impedance state and the factory (or user-characterized) data is still stored in the memory trace. Therefore, you can save both the data and memory trace as a *.csv files and import them to a spreadsheet. [Learn how.](#)
- If the two traces show excessive difference, there may be a loose or dirty connection at the test ports or damage to the test cables. Carefully inspect the cables and connections. Then clean and gage each connector, and re-calibrate if needed.
- The User Characterization setting selects the user-characterization data instead of the factory characterization data (available when a User-Characterization is stored in the ECal module).

Determining Effects of Not Terminating Unused ECal Ports

The following procedure can be used to determine the calibration errors when unused ECal ports are not terminated.

1. Connect the ECal module to one VNA test port through an adapter (eliminates the possibility of cable movement errors being included) and leave the unconnected port(s) open.
2. Perform a 1-port cal (use 100 Hz IFBW) then save the calset.
3. Connect a load(s) to the unconnected port(s) of the ECal module.
4. Perform a 1-port cal then save the calset.
5. Compare the calset in step 2 with the calset in step 4 using [Calset Viewer](#) to evaluate the effect of leaving the unused ECal ports open.

ECal Confidence Check dialog box help

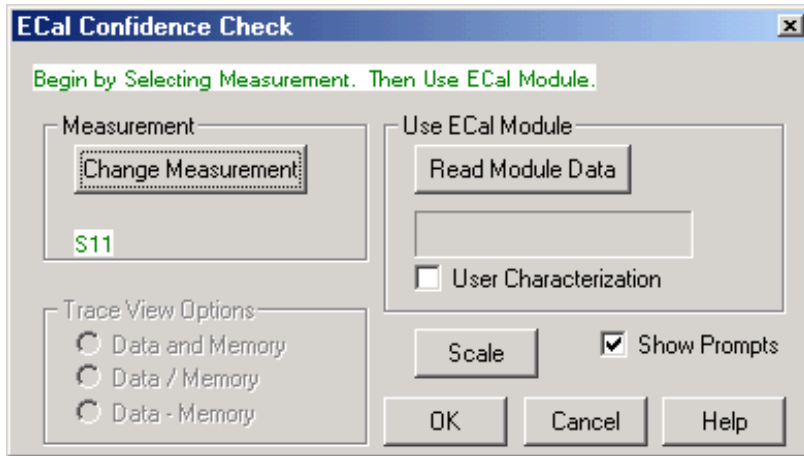

Compares the accuracy of corrected (calibrated) data with stored data in the ECal module. For the check to be valid, the module test ports must connect directly to the calibration reference plane (without an adapter). [Learn more about ECal Confidence Check.](#)

Measurement

Change Measurement Opens the Measure dialog box.

Use ECal Module

Read Module Data

- Copies stored data from the ECal module to Memory.
- Changes state of ECal module to confidence state.
- Measures and displays confidence state and Memory trace.
- Displays the factory and user characterizations data stored in the ECal module. [Learn more.](#)

Scale Opens the Scale dialog box.

Show Prompts Check to show a reminder for the connection (default).

Trace View Options

Data and Memory Trace Displays current measurement data and Memory trace.

Data / Memory Performs an operation where the current measurement data is divided by the data in memory.

Data + Memory Performs an operation where the current measurement data is added to the data in memory.

Verification Kit

Measuring known devices, other than calibration standards, is a straightforward way of verifying that the network analyzer system is operating properly. Verification kits use accurately known verification standards with well-defined magnitude and phase response. These kits include precision airlines, mismatch airlines, and precision fixed attenuators. Traceable measurement data is shipped with each kit on disk and verification kits may be re-certified by Keysight.

See [Analyzer Accessories](#) for a list of Keysight verification kits.

Calibration Standards

This following section explains the general principles and terms regarding calibration kit files. To learn **how** to modify calibration kit files, See [Modify Calibration Kits](#).

- [About Calibration Kits](#)
- [Calibration Standards](#)
- [Standard Type](#)
- [Standard Definitions](#)
- [Class Assignments](#)

[See other Calibration Topics](#)

About Calibration Kits

A calibration kit contains a set of physical devices called standards. Each standard has a precisely known or predictable magnitude and phase response as a function of frequency. All Keysight Cal Kits and their standard definitions are stored in the analyzer. For a list of Keysight calibration kits, see [Analyzer Accessories](#).

Calibration Standards

Calibration standards provide the reference for error-corrected measurements in the network analyzer. Each standard has a precisely known definition that includes electrical delay, impedance, and loss. The analyzer stores these definitions and uses them to calculate error correction terms.

During measurement calibration, the analyzer measures standards and mathematically compares the results with the definitions ("ideal models") of those standards. The differences are separated into error terms that are later removed from device measurements during error correction. See [Systematic Errors](#).

Standard Type

A standard type is one of four basic types that define the form or structure of the model to be used with that standard. The following are the four basic standard types:

Standard	Terminal Impedance
SHORT	zero ohms
OPEN	infinite ohms
LOAD	system impedance, Z_0
THRU/LINE	no terminal impedance

Learn about other Calibration Standards:

- [Data-Based Standard](#)
- [Sliding Load](#)
- [Offset Load](#)
- [Arbitrary Impedance Load](#)

Standard Definitions

Standard definitions describe the electrical characteristics of the standards and the frequencies they will be used. Standard definitions can be viewed from the [Advanced Modify Cal Kit](#) menu selection. Standard definitions include:

- **Minimum Frequency** Specifies the minimum frequency the standard is used for calibration.
- **Maximum Frequency** Specifies the maximum frequency the standard is used for calibration.
- **Z₀** Specifies the characteristic impedance of the standard (not the system characteristic impedance or the terminal impedance of the standard).
- **Delay** Specifies a uniform length of transmission line between the standard being defined and the actual calibration plane.
- **Type** Specifies type of standard (SHORT, OPEN, THRU/LINE, LOAD, ARBITRARY).
- **Loss** Specifies energy loss, due to skin effect, along a one-way length of coaxial cable.

Loss model equation:

- The value of loss is entered as ohms/second at 1 GHz.
- To compute the loss of the standard, measure the delay in seconds and the loss in dB at 1 GHz. Then use the following formula:

$$\text{Loss} \left(\frac{\Omega}{S} \right) = \frac{\text{loss (dB)} \times Z_0(\Omega)}{4.3429(\text{dB}) \times \text{delay(s)}}$$

Capacitance model equation:

C0, C1, C2, C3. Specifies the fringing capacitance for the open standard.

- $C = (C0) + (C1 \times F) + (C2 \times F^2) + (C3 \times F^3)$
- (F is the measurement frequency).
- The terms in the equation are defined when specifying the open as follows:
 - C0 term is the constant term of the third-order polynomial and is expressed in Farads.
 - C1 term is expressed in F/Hz (Farads/Hz).
 - C2 term is expressed in F/Hz².
 - C3 term is expressed in F/Hz³.

Inductance model equation:

L0, L1, L2, L3. Specifies the residual inductance for the short standard.

- $L = (L0) + (L1 \times F) + (L2 \times F^2) + (L3 \times F^3)$
- (F is the measurement frequency).
- The terms in the equation are defined when specifying the short as follows:
 - L0 term is the constant term of the third-order polynomial and is expressed in Henries.
 - L1 term is expressed in H/Hz (Henries/Hz)
 - L2 term is expressed in H/Hz².
 - L3 term is expressed in H/Hz³.

Class Assignments

Once a standard is characterized, it must be assigned to a standard "class". A standard class is a group of standards that are organized according to the calibration of the network analyzer error model.

The number of classes needed for a particular calibration type is equal to the number of error terms being corrected.

A class often consists of a single standard, but may be composed of multiple standards. These may be required for accuracy or to cover a wide frequency range.

Example: A response calibration requires only one class, and the standards for that class may include an OPEN, or SHORT, or THRU. A 1-port calibration requires three classes. A 2-port calibration requires 10 classes, not including two for isolation.

The number of standards assigned to a given class may vary from one to seven for unguided calibrations. Guided calibrations allow as many standards as needed.

Calibration Classes are assigned in the Advanced Modify Cal Kit menu, **SOLT** or **TRL** tab.

The different classes used in the analyzer

S11A, S11B, S11C (S22A, S22B, S22C and so forth)

These are the three classes for port 1-reflection calibrations (three classes also for S22 and S33). They are used in the one-port calibrations and the full two-port calibration. They are required in removing the directivity, source match, and reflection tracking errors. Typically, these classes might consist of an open, a short and a load standard for each port.

Transmission and Match (forward and reverse)

These classes are used to perform a full two-port calibration. The transmission class relates primarily to the transmission tracking, while the match class refers to load match. For both of these classes, the typical standard is a thru or delay.

Isolation

The isolation classes are used to perform a full two-port and the TRL two-port calibrations. The isolation classes apply to the forward and reverse crosstalk terms in the network analyzer error model.

TRL THRU

These are used to perform a TRL two-port calibration. The TRL thru class should contain a thru standard or a short line. If it contains a non-zero length thru standard, then the calibration type is called LRL or LRM.

TRL REFLECT

This class is used to perform a TRL two-port calibration. The TRL reflect class should contain a standard with a high reflection coefficient, typically an open or short. The actual reflection coefficient need not be known, but its phase angle should be specified approximately correctly (± 90 deg). The exact same reflection standard must be used on both ports in the TRL calibration process.

TRL LINE or MATCH

These are used to perform a TRL two-port calibration. The TRL line or match class should contain line standards, load standards, or both. If a line standard is used, its phase shift must differ from that of the TRL THRU standard by 20° to 160° . This limits the useable frequency range to about 8 to 1. Two or more line standards of different lengths may be specified to get broader frequency coverage. It is also common to include a load standard for covering low frequencies, where the line's length would be impractically long. When a load is used, the calibration type is called TRM or LRM.

Note: For more information, read [Specifying Calibration Standards and Kits for Keysight Vector Network Analyzers \(Application Note 1287-11\)](#)

Modify Calibration Kits

The following topics discuss Modifying Calibration Kits:

In this Topic

- [How to Modify Cal Kits](#)
- [Manage Cal Kits dialog](#)
- [Cal Kits and Firmware Upgrades](#)
- [Import Kit dialog](#)

Using VNA CalKit Editor

- [Connectors Tab](#)
- [Standards Tab](#)
- [SOLT Tab](#)
- [TRL Tab](#)

Concepts

- [Why Modify a Cal Kit](#)
- [VNA Cal Kit File Types](#)

Procedures

- [How to Create a New Cal Kit from an Existing Cal Kit](#)
- [Creating Custom Calibration Kits using a New Connector Family](#)
- [Noise Figure and TRL Cal \(separate topic\)](#)

How to Modify Cal Kits

The series of dialog boxes that follow allow you to modify the standard definitions or class assignments of calibration kit files.

Using **Hardkey/SoftTab/Softkey**

1. Press **Cal > Cal Sets & Cal Kits > Cal Kit...**

Using a mouse

1. Click **Response**
2. Select **Cal**
3. Select **Cal Sets & Cal Kits**
4. Select **Cal Kit...**

Programming Commands

Manage Cal Kits

Manage Cal Kits dialog box help

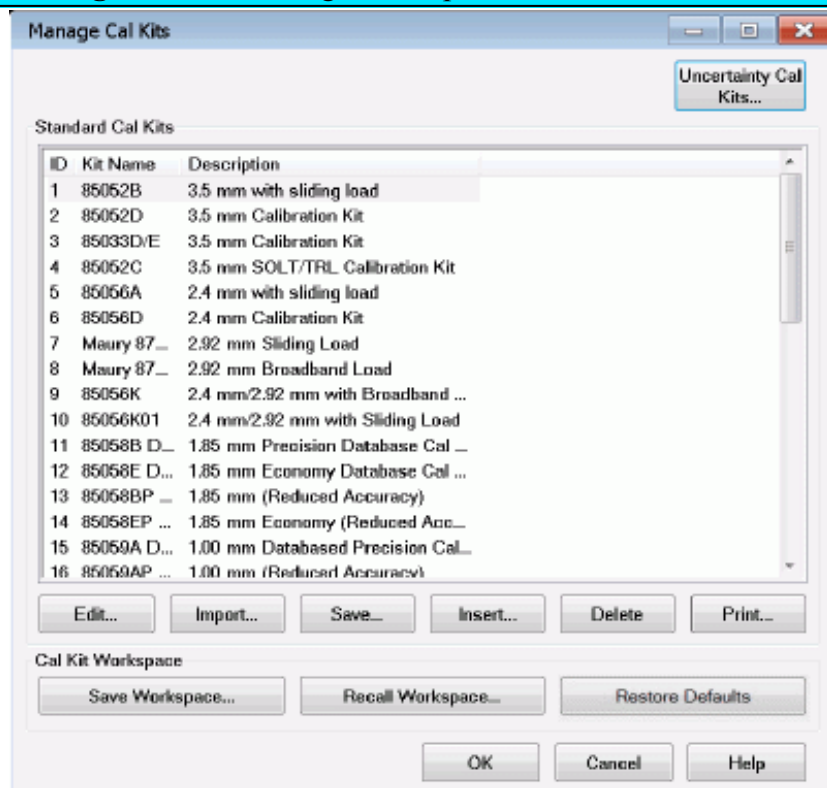

The Manage Cal Kits dialog allows you to define the cal kits in the active workspace. These cal kits may be edited, created, or saved to a cal kit file.

Cal Kits and Firmware Upgrades

- If the firmware upgrade includes factory cal kits that are formatted differently than the factory cal kit files in the instrument, then:
 - The factory cal kit files will be overwritten.
 - The custom cal kit files will not be changed.
 - A backup of the active workspace will be saved.
 - A new active workspace will be created and will contain only the new factory cal kit definitions.
- Under these conditions, if you want to use your custom cal kit definitions, you will need to import these files into the active workspace. [Learn how to import cal kit files.](#)

Uncertainty Cal Kits (Only for PNA)

Uncertainty Cal Kits... Opens the Uncertainty Cal Kit Manager (Option S93015A/B enabled). Learn more about Dynamic Uncertainty.

Standard Cal Kits

This group box lists all cal kits in the active workspace.

Edit... Starts the **Connectors tab** of the **Edit Kit dialog box** to modify selected calibration kit definitions.

Import... Starts the **Import Kit** dialog box to add a cal kit definition from a file into the active workspace.

Save... Saves the selected calibration kit definition into a cal kit file (using **.xkt**, **.ckt**, or **.prn** file type). See [VNA Cal Kit File Types](#).

Insert... Starts a blank **Edit Kit dialog box** to create a new calibration kit.

Delete Deletes selected calibration kit from the active workspace.

Print... Prints the contents of the selected cal kit to a **.prn** file.

Cal Kit Workspace

The active cal kit workspace is a collection of standard cal kits that are accessible by the VNA for calibrations.

Save Workspace... Saves the active workspace to a workspace file (*.xkw or *.wks).

Recall Workspace... Recalls a workspace file into the active workspace.

Restore Defaults Restores the active workspace and the factory cal kit files (*.xkt) to their factory default definitions.

For more information see [Creating Custom Calibration Kits using a New Connector Family](#).

Import Cal Kit dialog box help

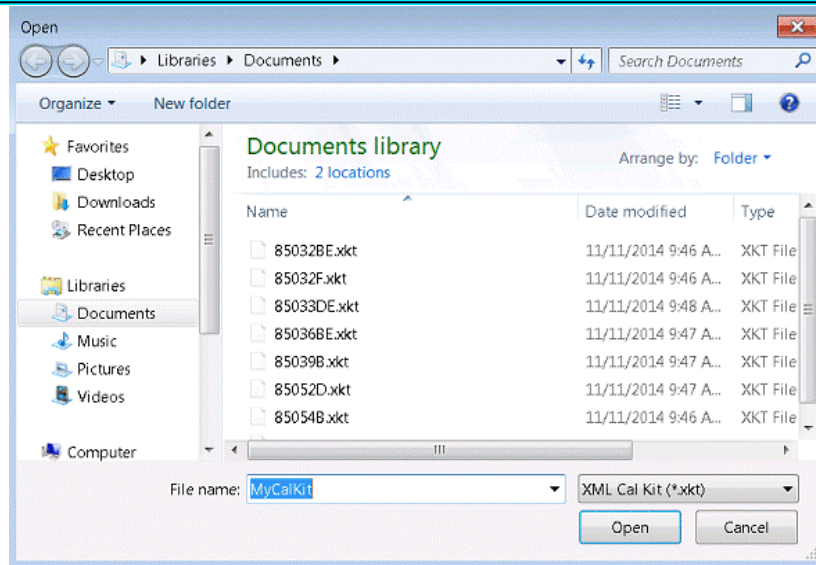

Note: There is no limit to the number of cal kits that can be imported. However, during an **Unguided cal**, you can access **ONLY** mechanical cal kits #1 through 95.

Imports a cal kit file into the active cal kit workspace.

Files of type Select the file type of your Cal Kit. Learn more about [VNA Cal Kit File Types](#)

File name Navigate and select your cal kit file name.

Open Loads the selected file into the active cal kit workspace.

Note: See [Cal Kits and Firmware Upgrades](#)

Importing Cal Kits from "legacy" network analyzers

Cal kit files from "legacy" network analyzers (such as the 8510 or 8753) may not contain

information that this VNA requires. Therefore, this VNA may modify the cal kit name, description, standards, and class assignments. You may need to correct these modifications after importing your legacy cal kit to meet your specific requirements.

- "Legacy" cal kit files are referenced to the VNA test port gender while modern cal kit files are referenced to the Device Under Test (DUT) connector gender. Therefore, when a legacy cal kit is imported, the genders of the standards in the legacy cal kit will be automatically reversed in the new cal kit.
- Legacy cal kits do not contain connector definitions. If a coaxial legacy kit is imported, then male and female coax connector definitions will be added to the kit. If a waveguide legacy kit is imported, then a genderless waveguide connector definition will be added to the kit.

Why Modify a Cal Kit

For most applications, the default calibration kit models provide sufficient accuracy for your calibration. However, several situations may exist that would require you to create a custom calibration kit:

- Using a connector interface different from those used in the predefined calibration kit models.
 - Using standards (or combinations of standards) that are different from the predefined calibration kits. For example, using three offset SHORTs instead of an OPEN, SHORT, and LOAD to perform a 1-port calibration.
 - Improving the accuracy of the models for predefined kits. When the model describes the actual performance of the standard, the calibration is more accurate. For example: A 7 mm LOAD is determined to be 50.4 Ω instead of 50.0 Ω .
 - Modifying the THRU definition when performing a calibration for a non-insertable device.
 - Performing a TRL calibration.
-

Creating a New Connector Family

To create a custom calibration kit that uses a new connector type, you must first define the connector family. The connector family is the name of the connector-type of the calibration kit, such as:

- APC7
- 2.4 mm
- Type-N (50Ω)

Although more than one connector family is allowed, it is best to limit each calibration kit to only one connector family.

If you are using a connector family that has male and female connectors, include definitions of both genders. If you are using a family with no gender, such as APC7, only one connector definition is required.

Use the following steps to create a custom calibration kit:

1. Press **Cal** > **Cal Sets & Cal Kits** > **Cal Kit...**
2. Click **Edit...**
3. In the **Connectors Tab**, click **Add** to name the new connector family.
4. Enter the Kit Description for the custom cal kit.
5. Click **Add** in the Connectors section of the dialog box.
6. Enter a Connector Family name.
7. Enter a Description of the connector.
8. Select the Gender of one of the connectors.
9. Enter the minimum and maximum Frequency Range.
10. Enter the Impedance.
11. Click the down-arrow to select the Media.
12. Enter the cut-off frequency
13. Click **Apply**.

14. Click **OK**.
15. If you need to add another connector gender, in the **Connectors Tab**, click **Add** in the Connectors section again for the next connector gender.
16. If you are adding another connector gender, repeat step 3.

Note: If you have male and female versions of the connector family, you probably do NOT also have a NO GENDER version.

Enter Standards

Now that the connector family is added to the custom cal kit, you are ready to add new calibration standards.

1. In the **Standards Tab**, under the list of standards, click **Add**.
 2. Select the type of standard (OPEN, SHORT, LOAD, or THRU), then click **OK**.
 3. Complete the information in the dialog box for the standard you selected. Note that for banded standards, the start and stop frequency may be different than the frequency range of the specified connector. Edit the start and stop frequencies as needed. Click **OK** when all the settings are correct.
 4. Repeat steps 2 - 3, as necessary, to add all standards and definitions to the new custom cal kit.
 5. Assign each of the standards to a calibration class. This is done through the **TRL Tab** or **SOLT Tab**
 6. Save the Cal Kit.
-

How to Create a New Cal Kit from an Existing Cal Kit

You can create a new custom Cal Kit using an existing Cal Kit as a starting point.

Here is how:

1. Press **Cal** > **Cal Sets & Cal Kits** > **Cal Kit...**
2. Immediately click **Save...** and change the file name. Select either *.**xkt** or *.**ckt**, *.**prn** file type. [Learn more about these file types.](#)
3. Make modifications to your new custom Cal Kit as required.
4. Routinely save your work by clicking **Save**.

See Also

[About VNA Cal Kits and Firmware Upgrades](#)

VNA Cal Kit File Types

The VNA Cal Kit editor can open the following types of Cal Kit files:

VNA Families	File Type
Cal Kits supported by current firmware of these VNA models: PNA Series, ENA Series, FieldFox, and PXI Series	*.xkt
Old PNA Series Cal Kits (PNA Firmware A.07.50 to A.09.90)	*.ckt
Old PNA Series Cal Kit (before A.07.50)	*.ck1
Previous FieldFox format Cal Kits	*.xml
Previous ENA format Cal Kits	*.ckx
8510 Cal Kit	.CK_*
8753, 8752, 8719, 8720, or 8722 Cal Kit	*.ck

The current revision of Cal Kit files can be downloaded at <http://na.support.keysight.com/pna/caldefs/stddefs.html>

File Save (As)

The VNA Cal Kit Editor can save Cal Kits in one of three file formats:

- ***.xkt** - Newer format that is based on xml and is shared among VNA families.
- ***.ckt** - VNA binary format, provided for backwards compatibility with older VNA firmware revisions and may not support future new cal kit capabilities, which is expected of the *.xkt format.
- ***.prn** - Cal kit print files. This is a text file format which can be read into spreadsheets, but the Cal Kit Editor does not read-in these files. These files are only produced as a form of documentation.

About Opening Legacy VNA Kits

Cal kit files from Keysight "legacy" network analyzers (listed above) may not contain information that the VNA requires. When loaded into the VNA Cal Kit Editor, the cal kit name and description, the cal standards, and the cal class assignments will be modified in a best effort manner. You may need to correct these modifications after importing your legacy cal kit to meet your specific requirements.

- "Legacy" cal kit files are based on the analyzer test port sex. Modern VNA cal kits are based on the Device

Under Test (DUT) connector sex. Therefore, when the kit is imported the standard's label and description are reversed and are noted as F- (female) and M- (male) .

- When a Coaxial standard is detected in the kit file, a pair of male/female connectors is typically created.
- Waveguide standards that are created as connector have no gender.

File Association

With the exception of *.xml, the above file types are automatically associated with the CalKit Editor if they are not already associated with a different program. That means, after running CalKit Editor, double-clicking any of the above file types (except *.xml) will open the file using CalKit Editor.

If you have already associated one of these file types with a different program and would like to change it to CalKit Editor, do the following:

1. Right-click the file, then click **Open With**
 2. Browse to the CalKitEditor install folder.
 - C:\Program Files (x86)\Agilent\VNA Cal Kit Editor
 3. Check **Always use the selected program to open this kind of file.**
 4. Select **CalKit Editor.**
-

Connectors Tab

Connectors Standards SOLT TRL

Connector Family: 3.5 mm Add Delete

Frequency Range
Min: 0 MHz
Max: 999000 MHz

Gender
 Gendered
 Genderless

Impedance
20 50 ohms

Transmission Media
Media: WAVEGUIDE
Cutoff Frequency: 0 MHz
Height/Width Ratio: 0

Cal Kit Name Allows you to change the Name of the selected calibration kit.

Cal Kit Description Allows you to change the description of the selected calibration kit.

Connector Family .Click the down arrow to select the connector family associated with the Cal Kit.

Add Starts the **Add Connector** dialog box which allows you to add new connector type to the calibration kit.

Delete Deletes - **WITHOUT WARNING** - the selected connector family.

Note: To modify a connector family or name, Add a new connector, then delete the old connector.

The following is the list of Factory-defined connector type strings:

	Type N (50) female	7-16 female	X-band waveguide
	Type N (50) male	7-16 male	P-band waveguide
APC 3.5 female	Type N (75) female	2.92 mm female	K-band waveguide
APC 3.5 male	Type N (75) male	2.92 mm male	Q-band waveguide
APC 2.4 female	Type F (75) female	1.85 mm female	R-band waveguide
APC 2.4 male	Type F (75) male	1.85 mm male	U-band waveguide
APC 7	Type A (50) female	1.0 mm female	V-band waveguide
	Type A (50) male	1.0 mm male	W-band waveguide
	Type B		

Frequency Range

Min Allows you to define the lowest frequency at which the standard is used for calibration.

Max Allows you to define the highest frequency at which the standard is used for calibration.

Gender

Gendered - The connector family contains both Male and Female connectors.

Genderless - The connector family does NOT contain Male and Female connectors. APC7 connectors are an example of this connector type.

Impedance

Specify the impedance of the standard.

Media

The medium (or 'geometry') of the connector (COAX or WAVEGUIDE).

Cutoff Frequency If Media is Waveguide, type the low-end cutoff frequency.

Height/Width Ratio Used to calculate waveguide loss. This value is usually on the data sheet for waveguide devices.

About Waveguide Cal Kits

If modifying or creating a waveguide cal kit, be sure to make the following settings. You can [create a](#)

custom waveguide cal kit using an existing factory waveguide Cal kit as a starting point. The factory cal kits already have these settings.

- Frequency Range: **Min. frequency = Cutoff frequency.**
- Gender: **No Gender**
- Impedance Z0: **1 ohm**
- Media: **Waveguide**

For waveguide, choose TRL (Thru-Reflect-Line) calibration type . These calibration types are more accurate and take fewer steps than SOLT.

Add Connector Family



Enter a name for the new connector family. Then click **OK**.

Available at the bottom of every tab

Save As - Allows you to save the cal kit to a new file name and type.

Save - Saves the cal kit to the same file name and type.

Close - Closes the cal kit editing session. The file is NOT saved automatically.

Standards Tab

ID	Standard	Description
1	9.26-32 Offset Load -F	9.26-32 GHz male offset load
2	5.26-9.26 Offset Load	5.26-9.26 GHz male offset load
3	3-5.26 Offset Load -M	3-5.26 GHz male offset load
4	ADPTR/LOAD -M-	Male load connected to M/F retractable
5	Broadband Load -M-	3.5 mm male broadband load
6	0-2 Load -M-	0-2 GHz male low band load
7	OPEN -M-	3.5 mm male open
8	SHORT -M-	3.5 mm male short
9	9.26-32 Offset Load -F	9.26-32 GHz female offset load
10	5.26-9.26 Offset Load	5.26-9.26 GHz female offset load
11	3-5.26 Offset Load -F-	3-5.26 GHz female offset load
12	Broadband Load -F-	3.5 mm female broadband load
13	0-2 Load -F-	0-2 GHz female low band load
14	OPEN -F-	3.5 mm female open
15	SHORT -F-	3.5 mm female short
16	THRU	Insertable thru standard
17	7-32 Line	7-32 TRL line standard
18	2-7 Line	2-7 TRL line standard

Allows you to Add, Edit or Delete cal standards in a cal kit.

Add Standard (Open, Short, Load, Thru, or Data-based)

Add Standard dialog box help

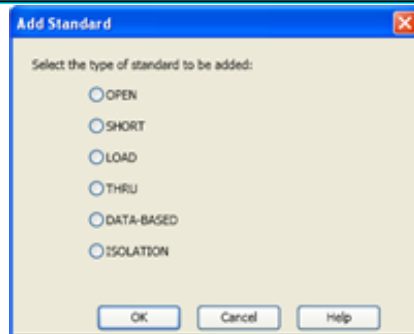

Allows you to add standards to the calibration kit file.

Choose from:

- OPEN
- SHORT
- LOAD
- THRU
- DATA-BASED
- ISOLATION

Standards dialog box help

The following fields apply to **ALL** standard types:

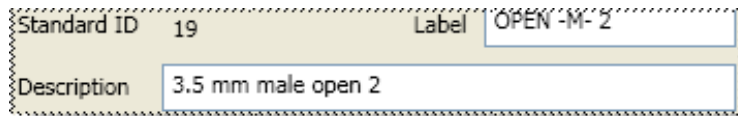

A screenshot of a dialog box with a light beige background and a dashed border. It contains three fields: 'Standard ID' with the value '19', 'Label' with the value 'OPEN -M- 2', and 'Description' with the value '3.5 mm male open 2'.

The other areas of the dialog change depending on the type of standard selected.

Identification

Standard ID Number in list of standards

Label Type of standard. This usually appears in prompts for standards.

Description Description of standard.

The following fields apply to **ALL** standard types **EXCEPT** the Isolation type:

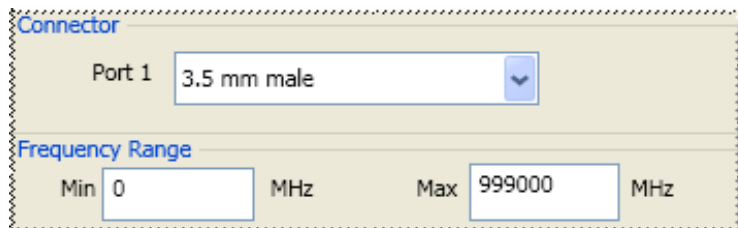

A screenshot of a dialog box with a light beige background and a dashed border. It is divided into two sections. The top section, titled 'Connector', has a 'Port 1' label and a dropdown menu showing '3.5 mm male'. The bottom section, titled 'Frequency Range', has 'Min' and 'Max' labels, each followed by a text input field and the unit 'MHz'. The 'Min' field contains '0' and the 'Max' field contains '999000'.

Connector

Indicates the type and gender (Male, Female, None) of the standard.

Thru and Isolation standards have two connectors.

Data-Based standards **MAY** have two connectors.

Frequency Range

Min Defines the lowest frequency at which the standard is used for calibration.

Max Defines the highest frequency at which the standard is used for calibration.

The Delay Characteristics fields apply to MOST standard types:

Delay Characteristics

Delay pSec Loss Gohms/s

Z0 ohms

Delay Characteristics

Delay Defines the one-way travel time from the calibration plane to the standard in seconds.

Z0 Defines the impedance of the standard.

Loss Defines energy loss in Gohms, due to skin effect, along a one-way length of coaxial cable.

Other fields are unique to standard type

Choose from:

- OPEN
- SHORT
- LOAD
- THRU
- DATA-BASED
- ISOLATION

Open Standard

C0, C1, C2, C3 Specifies the fringing capacitance.

Open Characteristics

C0 F(e-15) C2 F(e-36)/Hz²

C1 F(e-27)/Hz C3 F(e-45)/Hz³

These are the unique fields of the dialog. See the areas that are common to all standards.

Short Standard

L0, L1, L2, L3 Specifies the residual inductance.

Short Characteristics

L0	<input type="text" value="0"/>	H(e-12)	L2	<input type="text" value="0"/>	H(e-33)/Hz^2
L1	<input type="text" value="0"/>	H(e-24)/Hz	L3	<input type="text" value="0"/>	H(e-42)/Hz^3

Load Standard

Choose from the following

Load Type

- Fixed Load
- Sliding Load
- Offset Load
- Arbitrary Impedance

Fixed Load Specifies the load type as Fixed. The fixed load is assumed to be a perfect termination without reflection.

Sliding Load

A sliding load is defined by making multiple measurements of the device with the sliding load element positioned at various marked positions of a long transmission line. The transmission line is assumed to have zero reflections and the load element has a finite reflection that can be mathematically removed using a least squares circle fitting method.

A sliding load cal can be very accurate when performed perfectly. It can also be very inaccurate when not using proper technique. **For accurate results, closely follow the users manual instructions for the sliding load.**

Arbitrary Impedance

Arbitrary Impedance Parameters

Real	<input type="text" value="50.4"/>
Imag	<input type="text" value="-3"/>

Specifies the load type that has an impedance value different from system Z0. An arbitrary impedance device is similar to a fixed load except that the load impedance is NOT perfect. Early firmware releases of the VNA series used a fixed resistance value. A complex terminating impedance has been added to allow for more accurate modeling of circuit board or on-wafer devices.

The following Complex Impedance settings are available ONLY when Arbitrary Impedance is selected.

- **Real** The real portion of the impedance value.
- **Imaginary** The imaginary portion of the impedance value.

Offset Load

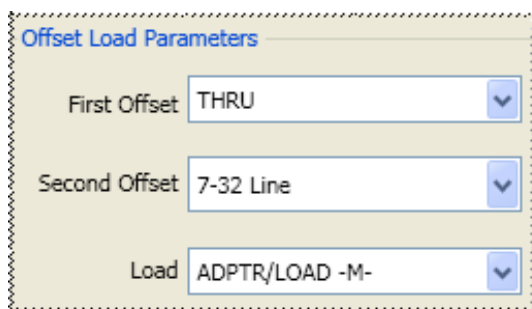

Using an Offset Load standard results in a more accurate calibration than with a Broadband Load. Therefore, when performing a calibration using one of the modified Cal Kit definitions, you may be prompted to connect more standards than before this change. To revert to using the Broadband Load Standard without offset, do the following:

1. Press **Cal > Cal Sets & Cal Kits > Cal Kit....**
2. At the **Manage Cal Kit** dialog box, click **Edit...**
3. Select the **SOLT** tab.
4. Under the Calibration Kit Classes, select **SC** (Loads)
5. Under Selected Standards, select **Broadband Load**, then click **Move Up** until the standard is at the top of the list. This will ensure that the Broadband Load is used first.

About Offset Load

An offset load is a compound standard consisting of a load element and two known offset elements (transmission lines) of different length. The shorter offset element can be a zero-length (Flush-thru) offset. The load element is defined as a 1-port reflection standard. An offset load standard is used

when the response of the offset elements are more precisely known than the response of the load element. This is the case with waveguide. Measurement of an offset load standard consists of two measurements, one with each of the two offset elements terminated by the load element. The frequency range of the offset load standard should be set so that there will be at least a 20 degree separation between the expected response of each measurement.

To specify more than two offset elements, define multiple offset load standards. In cases where more than two offsets are used, the frequency range may be extended as the internal algorithm at each frequency will search through all of the possible combinations of offsets to find the pair with the widest expected separation to use in determining the actual response of the load element.

The following Offset Load settings are available ONLY when Offset Load is selected.

- First Offset Standard
- Second Offset Standard
- Load Standard

Thru Standard

The screenshot shows a configuration dialog for a Thru Standard. It is divided into several sections:

- Connectors:** Port 1 is set to "3.5 mm female" and Port 2 is set to "3.5 mm male".
- Frequency Range:** Min is 0 MHz and Max is 38800 MHz.
- Delay Characteristics:** Delay is 0 pSec, Loss is 0 Gohms/s, and Z0 is 50 ohms.
- Virtual Device:** A checkbox labeled "Virtual Device" is checked.

Connectors - Defines connector type at both ends of the Thru standard.

Virtual Device

Most cal kits have only one Thru standard definition for SOLT calibrations. For these cases, use the default selections (checked for zero-length Thrus and cleared for non-zero-length Thrus).

This checkbox is used to make forward and reverse measurements of your Thru standard for the same pair of ports in two separate steps. This is NOT common for zero-length (Flush) Thru standards.

When **checked**, calibration prompts involving that Thru will **omit** the Description. For example “Connect port 1 to port 2”. This is the common prompt for Flush-Thru standards.

When **cleared**, calibration prompts for that Thru will **include** the Description. For example “Connect <standard description> between ports 1 and 2”.

To make forward and reverse measurements of your Thru standard for the same pair of ports as two separate steps, do the following:

1. Create separate definitions of the Thru standard(s) using the same settings, except for the Label and Description. **Clear** this checkbox for BOTH definitions.
2. For one Thru definition, in the label and description include the word 'FORWARD' to prompt the operator to use this standard for the forward measurement. Assign this standard to the SOLT “FWD TRANS” and “FWD MATCH” classes of the cal kit.
3. For the Thru definition, in the label and description include the word 'REVERSE' to prompt the operator to use this standard for the reverse measurement. Assign this standard to the SOLT “REV TRANS” and “REV MATCH” classes of the cal kit.
4. When you perform SOLT calibrations using this cal kit, the forward measurements of the Thru will be measured in one connection step, and the reverse measurements in another.

Data-Based Standard

Response Data Summary

Number of Response Data Variables = 4
index = 0: Number of Data Variable Values = 900
Data Variable Name = S11
index = 1: Number of Data Variable Values = 900
Data Variable Name = S21

Load Data File...

Accuracy Data Summary

Standard contains no accuracy data

Load Data File...

Virtual Device

Note: To learn how to modify data-based standard files, visit <http://na.support.keysight.com/pna/dbcal.html>

Learn about the relative accuracy of **Databased versus Polynomial Cal Kits**.

The modified file can then be uploaded into the VNA.

Upload Data From File

Click **Load Data File**, then navigate to the *.dat or *.dsd file which is provided with the data-based Cal Kit. Both Response data and Accuracy (Uncertainty) data is provided in a single *.dat or *.dsd file.

For Advanced Users

Response data can be loaded from a *.s2p or *.cti file.

Accuracy data can be loaded from a *.cti file.

Virtual Device

This checkbox is displayed for a Data-Based cal standard when the standard has been defined to have 2 ports.

- When Cleared (default) calibration prompts for that standard will include it's Description. For example "Connect <standard description> between ports 1 and 2".
- When Checked, calibration prompts for that standard will NOT include its Description, so the prompt will be worded as if the data-based standard is a zero-length Thru connection. For example "Connect port 1 to port 2".

Isolation Standard

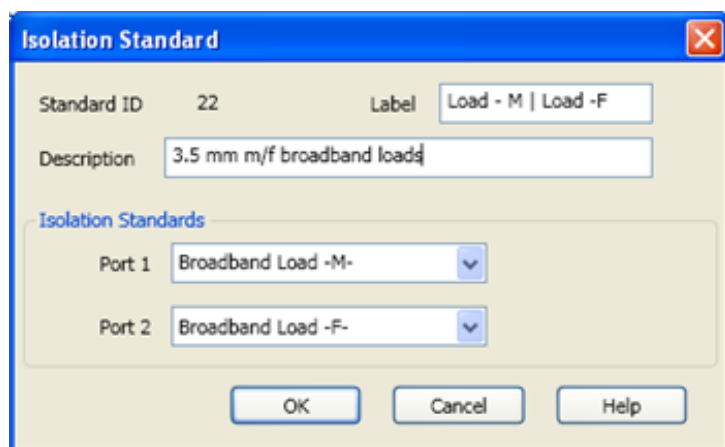

The pair of loads are considered one standard.

Both loads are connected to the VNA and measured with the same prompt.

Available at the bottom of every tab

Save As - Allows you to save the cal kit to a new file name and type.

Save - Saves the cal kit to the same file name and type.

Close - Closes the cal kit editing session. The file is NOT saved automatically.

SOLT Tab

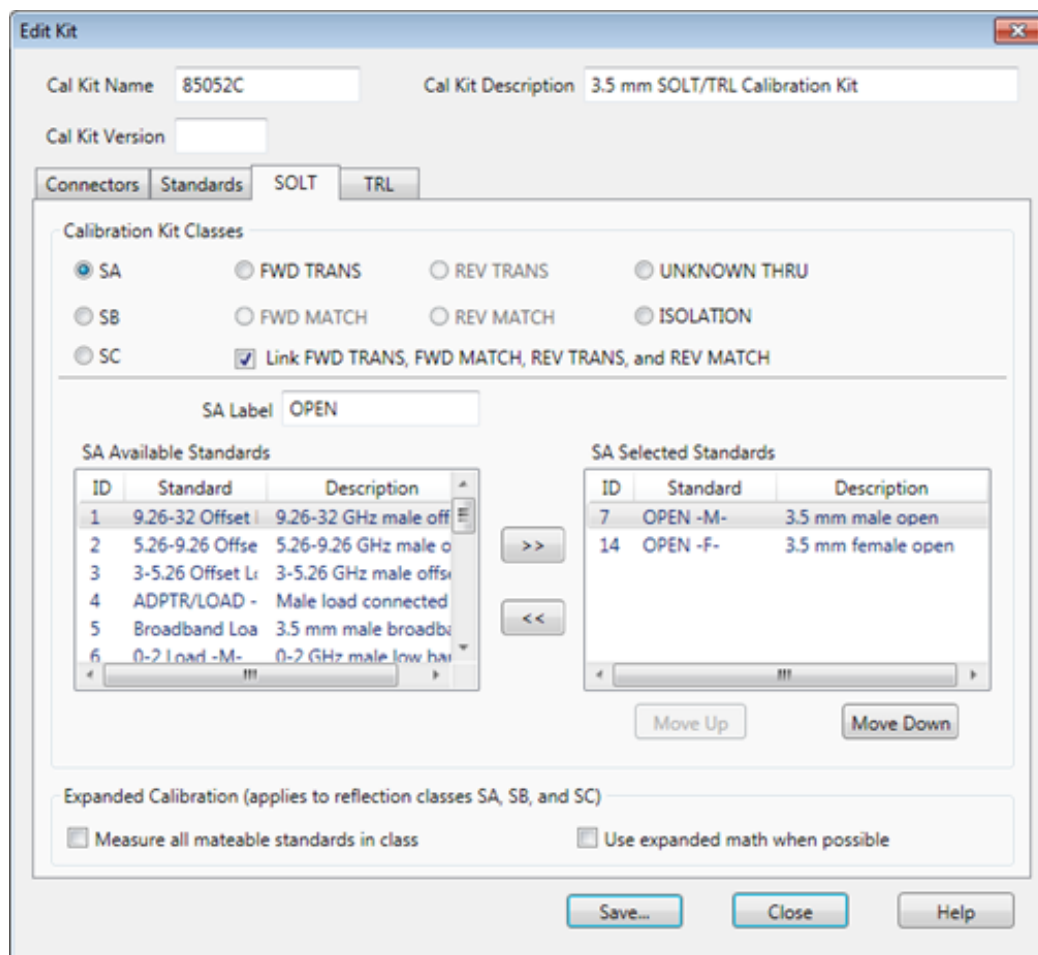

Note: This dialog looks similar to the dialog that appears after the [Cal Wizard View / Modify dialog](#). However, setting changes in that dialog affect **ONLY** the calibration that is in progress. These settings, accessed through Modify Cal Kit, changes the cal kit for all future calibrations that use this cal kit.

Allows you to assign single or multiple standards to **SOLT** Calibration Classes.

Click the **TRL** tab to assign standards to TRL Calibration Classes.

1. For each Cal Kit Class, select **Available Standards** from the left list, then click **>>** to copy the standard to the Cal Kit.
2. Use **MOVE UP** and **MOVE DOWN** to change the **ORDER** of the standards. The order is used in guided calibrations to determine which standards in that class will be used in calibrations that involve the frequency ranges over which the standards are defined. Guided cals will include standards in the order in which they appear in this class list, and in the case where standards in the class list have frequency ranges that overlap,

the order also determines which standard is used for frequencies in the overlap range. For example, let's assume that you define a broadband Short from Min Freq.= 0 Hz and Max Freq.= 999 GHz, and that standard is listed first in the SB or TRL REFLECT class. If you then list a frequency-banded Short with the same connector below the broadband short in those same classes, then guided calibrations would not use the frequency-banded Shorts because the broadband Shorts would always be given priority.

SOLT <cal class> Label

The cal standard category label that appears in the VNA's user interface during **unguided** SOLT calibrations.

Calibration Kit Classes

For each calibration class, select **Available Standards**, then click >> to move to the **Selected Standards** list.

- **SA** - OPEN Standards (standards in the SA class are not always Opens)
- **SB** - SHORT Standards
- **SC** - LOAD Standards
- **FWD / REV Trans and Match** - THRU Standards. Most Cal Kits do NOT include a physical THRU standard, but assume that an Insertable Thru will be used.
- **UNKNOWN THRU** - Unknown Thru Cal is the **preferred** THRU method of calibrating the analyzer to measure a non-insertable device. The Unknown Thru calibration is also known as **Short-Open-Load-Reciprocal Thru** (SOLR) calibration. [Learn more](#).
- **ISOLATION** - Isolation standard. For VNA analyzers, ISOLATION calibration is not usually recommended. It could be beneficial in some situations where custom user-supplied test set hardware is being used.

Link FWD TRANS, FWD MATCH, REV TRANS, and REV MATCH Check to automatically assign the standard definition for FWD TRANS to FWD MATCH, REV MATCH, and REV TRANS. Clear to separately assign FWD MATCH, REV MATCH and REV TRANS classes (SOLT calibrations only).

Expanded Calibration

The following two check boxes **apply ONLY during Guided Calibrations**. For Unguided Calibration, these check boxes are ignored, including the case where the multiple standards dialog box is presented.

Measure all mateable standards in class Check this box to attain the very highest accuracy possible. For example, if a cal kit contains several load standards, during the calibration process you

will be prompted to measure each of the standards. This could require a significant amount of calibration time. When checked, the "Use expanded math when possible" box is also checked automatically.

Use expanded math when possible Some kits contain multiple calibration standards of the same type that together cover a very wide frequency range. (For example: multiple shorts, or a lowband load and a sliding load.) If a calibration requires more than one standard to cover the calibration frequency range, there can be regions of overlapping measurements. When this checkbox is selected, the VNA automatically computes the most accurate measurement in the overlap regions using a "weighted least squares fit" algorithm. This function improves accuracy without slowing the calibration speed.

- Manually select this checkbox only when using a cal kit that contains multiple standards of the same type. (For example: multiple shorts, or a lowband load and a sliding load.)
- The checkbox is cleared by default when a polynomial model is selected from the cal kit menu.
- The checkbox is selected by default when the 85058B or 85058E data-based model is selected from the cal kit menu.

Available at the bottom of every tab

Save As - Allows you to save the cal kit to a new file name and type.

Save - Saves the cal kit to the same file name and type.

Close - Closes the cal kit editing session. The file is NOT saved automatically.

TRL Tab

On the image below, click a setting area to learn more.



Allows you to assign single or multiple standards to Calibration Classes.

1. For each Cal Kit Class, select **Available Standards** from the left list, then click **>>** to copy the standard to the Cal Kit.
2. Use **MOVE UP** and **MOVE DOWN** to change the **ORDER** of the standards. The order is used in guided calibrations to determine which standards in that class will be used in calibrations that involve the frequency ranges over which the standards are defined. Guided calcs will include standards in the order in which they appear in this class list, and in the case where standards in the class list have frequency ranges that overlap, the order also determines which standard is used for frequencies in the overlap range. For example, let's assume that you define a broadband Short from Min Freq.= 0 Hz and Max Freq.= 999 GHz, and that standard is listed first in the SB or TRL REFLECT class. If you then list a frequency-banded Short with the same connector below the broadband short in those same classes, then guided calibrations would not use the frequency-banded Shorts because the broadband Shorts would always be given priority.

Note: The TRL LINE/MATCH class has a slight exception to these prioritization behaviors. In general, Line standards are given a higher priority than Match standards. So if a Line standard and a Match standard are defined to have the same frequency range and the Match standard is listed above the Line standard in the class order, a guided TRL cal will still prefer to use the Line standard rather than the Match standard.

TRL <cal class> Label

The cal standard category label that appears in the VNA's user interface during **unguided** TRL calibrations.

Cal Kit Classes

- For VNA analyzers, ISOLATION calibration is not usually recommended. It could be beneficial in some situations where custom user-supplied test set hardware is being used.

TRL THRU

Note: All **THRU calibration methods** are supported in a TRL Cal **EXCEPT** Unknown Thru.

- The THRU standard can be either a zero-length or non-zero length. However, a zero-length THRU is more accurate because it has zero loss and no reflections, by definition.
- The THRU standard cannot be the same electrical length as the LINE standard.
- If the insertion phase and electrical length are well-defined, the THRU standard may be used to set the reference plane.
- The THRU standard and LINE standard have the same characteristic impedance and are perfectly matched. They define the reference impedance of the calibration.
- If a THRU standard with the correct connectors is NOT available, an adapter removal cal can be performed.

TRL REFLECT

- The REFLECT standard can be anything with a high reflection, as long as it is the same when connected to one or more VNA ports.
- The REFLECT standard on each port is identical.
- The actual magnitude of the reflection need not be known.
- The phase of the reflection standard must be known within 1/4 wavelength.
- If the magnitude and phase of the reflection standard are well-defined, the standard may be used to set the reference plane.

TRL LINE

The LINE and THRU standards establish the reference impedance for the measurement after the calibration is completed. TRL calibration is limited by the following restrictions of the LINE standard:

- Must be of the same impedance and propagation constant as the THRU standard.
- The electrical length need only be specified within 1/4 wavelength.

- Cannot be the same length as the THRU standard.
- A TRL cal with broad frequency coverage requires multiple LINE standards. For example, a span from 2 GHz to 26 GHz requires two line standards.
- Must be an appropriate electrical length for the frequency range: at each frequency, the phase difference between the THRU and the LINE should be greater than 20 degrees and less than 160 degrees. This means in practice that a single LINE standard is only usable over an 8:1 frequency range (Frequency Span / Start Frequency). Therefore, for broad frequency coverage, multiple lines are required.
- At low frequencies, the LINE standard can become too long for practical use. The optimal length of the LINE standard is 1/4 wavelength at the geometric mean of the frequency span (square root of $f_1 \times f_2$).

Note: The TRL LINE standard must have a delay that is greater than 0 (zero) ps. Otherwise, calibration correction calculations will contain unpredictable results.

TRL MATCH

If the LINE standard of appropriate length or loss cannot be fabricated, a MATCH standard may be used instead of the LINE.

- The MATCH standard is a low-reflection termination connected to both Port 1 and Port 2.
- The MATCH standard may be defined as an infinite length transmission line OR as a 1-port low reflect termination, such as a load.
- When defined as an infinite length transmission line, both test ports must be terminated by a MATCH standard at the same time. When defined as a 1-port load standard, the loads are measured separately. The loads are assumed to have the same characteristics.
- The impedance of the MATCH standard becomes the reference impedance for the measurement. For best results, use the same load on both ports. The load may be defined using the data-based definition, the arbitrary impedance definition, or the fixed load definition.

Calibration Reference Z0 (TRL only)

System Z0 The system impedance is used as the reference impedance. Choose when the desired test port impedance differs from the impedance of the LINE standard. Also, choose when skin effect impedance correction is desired for coax lines.

Line Z0 The impedance of the line standard is used as the reference impedance, or center of the Smith Chart. Any reflection from the line standard is assumed to be part of the directivity error.

Testport Reference Plane (TRL only)

Thru Standard The THRU standard definition is used to establish the measurement reference

plane. Select if the THRU standard is zero-length or very short.

Reflect Standard The REFLECT standard definition is used to establish the position of the measurement reference plane. Select if the THRU standard is not appropriate AND the delay of the REFLECT standard is well defined.

Also, select If a flush short is used for the REFLECT standard because a flush short provides a more accurate phase reference than a Thru standard.

LRL line auto characterization

Note: This setting ONLY applies if an LRL Cal Kit is being modified AND Testport Reference Plane is set to Thru Standard AND the TRL Thru class standard and the TRL Line/Match class standard both have the same values for Offset Z0 and Loss. Otherwise, this setting is ignored.

- Check the box to allow the VNA to automatically correct for line loss and dispersion characteristics.
- Clear the box if anomalies appear during a calibrated measurement which may indicate different loss and impedance values for the Line standards.

Available at the bottom of every tab

Save As - Allows you to save the cal kit to a new file name and type.

Save - Saves the cal kit to the same file name and type.

Close - Closes the cal kit editing session. The file is NOT saved automatically.

Markers

Markers provide a numerical readout of measured data, a search capability for specific values, and can change stimulus settings. There are 15 regular markers and one **Reference marker** (used with Delta markers) available per trace. This topic discusses all aspects of markers.

Note: Marker Readout can be turned ON/OFF and customized from the **Customize Display** dialog box. [Learn more.](#)

- **Number of General Purpose and Reference Markers**
- **Creating and Moving Markers**
- **Marker Setup**
 - **Coupling Method**
- **Searching with Markers**
 - **Maximum and Minimum Search**
 - **Peak Search**
 - **Multi Peak Search**
 - **Target Search**
 - **Multi Target Search**
 - **Bandwidth and Notch Search**
 - **Compression Search**
 - **PSAT Search**
 - **PNOP Search**
- **Search Domain**
- **Search Range Indicators**
- **Marker Functions** (Change Instrument Settings)
- **SA Analysis Markers** (Spectrum Analyzer channel markers)

- **SA Mrkr Function** (Modulation Distortion channel markers)
- **Marker Display**
- **Marker Table**

Note: Marker Readout can be turned ON / OFF and customized from the **View/Display** menu. [Learn more.](#)

Other Analyze Data topics

Creating and Moving Markers

How to Create Markers

Using **Hardkey/SoftTab/Softkey**

1. Press **Marker** > **Marker 1-7 / Marker 8-15 / Reference**.
2. Click left side **Marker N** or **Reference** small button.

Using a mouse

1. Move the cursor on a trace.
2. Right-click on the trace then select **Add Marker...**

◀ **Programming Commands** ▶

Moving a Marker

To move a marker, make the marker active by selecting its number in any of the previous 3 methods. The **active marker** appears on the analyzer display as ∇ . All of the other markers are inactive and are represented on the analyzer display as Δ . Then change the stimulus value using any of the following methods:

- Type a value.
- Scroll to a stimulus value using the up / down arrows. The resolution can not be changed.
- Click the stimulus box, then use the front-panel knob.
- Click and Drag Markers using a finger (touchscreen) or by left-clicking and holding a marker symbol. Then drag the marker to any point on the trace. This feature is NOT allowed in Smith Chart or Polar **display formats** or with a **Fixed Marker type**.

Marker Setup

How to set the Marker Setup.

Using **Hardkey/SoftTab/Softkey**

1. Press **Marker > Marker Setup**.
2. Set the value or select desired setting for each softkey.

Using a mouse

1. Move the cursor on a marker.
2. Right-click on the marker then select **Marker....**

Programming Commands

Marker dialog box help

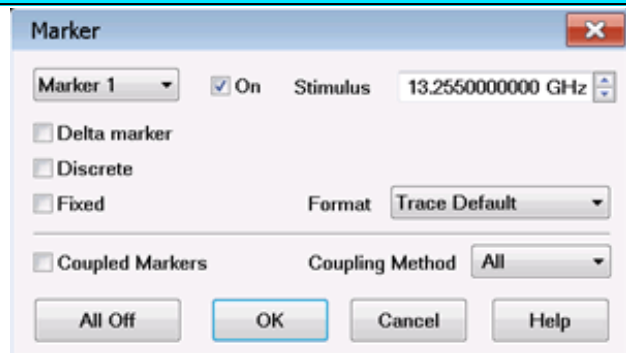

Marker Specifies the current (active) marker number that you are defining.

On Check to display the marker and corresponding data on the screen.

Stimulus Specifies the X-axis value of the active marker. To change stimulus value, type a value, use the up and down arrows, click in the text box and use the front-panel knob, or drag the marker on the screen.

Delta (and Reference) Markers Check to make the active marker display data that is relative to the reference (R) marker. There is only one reference marker per trace. All other markers can be regular markers or delta markers. When a delta marker is created, if not already displayed, the reference marker is displayed automatically. A delta marker can be activated from the **Marker dialog box** or the **Marker Toolbar**. **See Also:** [Number of General Purpose and Reference Markers](#).

Discrete Marker Check to display values at only the discrete points where data is measured. Clear to display values that are interpolated from the data points. The interpolated marker will report y-axis data from ANY frequency value between the start and stop frequency.

Fixed Check to cause the marker to have a fixed X-axis and **Y-axis** position based on its placement on the trace when it was set to fixed. It does NOT move with trace data amplitude. It can be scrolled left and right on the X-axis by changing the marker stimulus value. Use this marker type to quickly monitor "before and after" changes to your test device. For example, you could use fixed markers to record the difference of test results before and after tuning a filter.

Clear the box to create a **Normal** marker, which has a fixed stimulus position (X-axis) and responds to changes in data amplitude (Y-axis). It can be scrolled left and right on the X-axis by changing the marker stimulus value. Use this marker type with one of the marker search types to locate the desired data.

(Marker) Format Displays the marker data in a format that you choose. The Trace Default setting has the same marker and grid formats. Choose from the following:

Log/Phase	Log Mag	Real	Fahrenheit
Linear/Phase	Linear Mag	Imaginary	Celsius
Real/Imag R+jX (complex impedance)	Phase SWR	Phase Unwrapped Phase Positive	Noise
G+jB (complex admittance)	Delay	Kelvin	

Noise Marker Format (IMSpectrum and SA measurement classes only) - For comparison purposes, electronic noise measurements are often displayed as though the measurement was made in a 1 Hz Res BW. However, making an actual measurement at a 1 Hz Res BW is impossible, and at 10 Hz, extremely slow.

A Noise Marker mathematically calculates the noise measurement **at that single data point** as though it were made using a 1 Hz bandwidth.

To accurately measure noise, the Noise Marker should NOT be placed on, or too close to, a signal. The distance from a signal depends on several factors. To know if an accurate reading is being made, move the Noise Marker until consistent measurements are displayed in adjacent data points.

Noise Marker Format (Modulation Distortion measurement class only) - In a Modulation Distortion channel, the noise is calculated from the current power reading divided by the tone spacing of the modulation being used: $PIn(W/Hz) = PIn(W) / [Tone Spacing (Hz)]$.

All Off Switches OFF all markers on the active trace.

Coupled Markers

The coupled markers feature causes markers on different traces to line up with the markers on the selected trace. Markers are coupled by marker number, 1 to 1, 2 to 2, 3 to 3, and so forth. If the x-axis domain is the same (such as frequency or time), coupling occurs. Trace markers in a different

x-axis domain will not be coupled. If a trace marker has no marker to couple with on the selected trace, the marker remains independent.

Coupling Method - Determines the scope of coupling. Choose from the following:

- **All** - A marker on one trace is coupled to the same-numbered markers on all channels, all windows and all traces.
- **Channel** - A marker on one trace is coupled to the same numbered markers on traces which share the same channel number as the original trace.

Coupled Markers Model

This model simulates the use of coupled markers in the VNA:

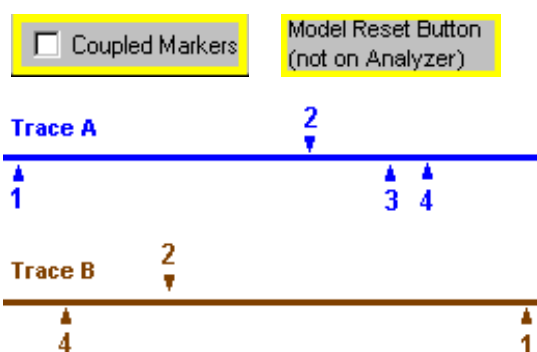

1. **Click Trace A or Trace B**
2. **Click Coupled Markers**
3. Notice the following:
 - Markers on the unselected trace move to the x-axis position of the selected trace.
 - If a marker number on the unselected trace has no corresponding marker on the selected trace, no movement occurs for that marker.
4. Click **Reset** to run the model again. There is no Reset for coupled markers on the VNA.

Searching with Markers

You can use markers to search and return data for the following trace criteria:

- **Max and Min:** find the highest or lowest points on the trace
- **Peak**, then move to other peaks (left, right, next highest)
- **Multi Peak**
- **Target Value:** find a specific Y-axis value
- **Multi Target:**
- **Bandwidth** (Filters)
- **Notch** (Filters)
- **Compression Point** (Amplifiers)
- **About PSAT and PNOP Markers**
 - **Power Saturation** (Amplifiers)
 - **Power Normal Operating Point** (Amplifiers)
- **Search Domain**
- **Search Range Indicators**

How to Search with Markers

Using **Hardkey/SoftTab/Softkey**

1. Press **Search** > **Main / Peak / Target / Multi Peak & Target / Bandwidth & Notch / Compression & Saturation / Normal Op Pt.**

Using a mouse

1. Move the cursor on a marker.
2. Right-click on the marker then select **Search...** to show the Marker Search Dialog box for define the search parameters.
3. From **Search Type** of Marker Search dialog box, select the desired search function.
4. Press **Execute** or check **Tracking**. [Learn more.](#)

◀ **Programming Commands** ▶

Marker Search dialog box help

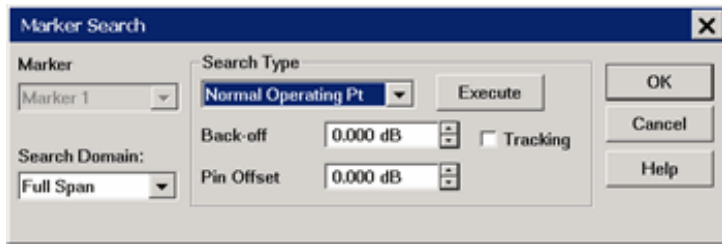

Marker Specifies the marker that you are defining. Not available for search types that deploy specific markers.

Search Domain Defines the area where the marker can move or search. For full span, the marker searches for specified values within the full measurement span. For user span, the marker searches for specified values within a measurement span that you define. [Learn more about Search Domain.](#)

Search Type

Note You must either press **Target Search** or check **Tracking** to initiate all search types. If there is no valid data match for the search type, the marker will not move from its current position.

- **Target Search** Click to cause the marker to search for the specified criteria.
- **Tracking** Check to cause the marker to search for the specified criteria with each new sweep. The searches begin with the first sweep after Tracking has been checked, based on the current search type and domain information. Therefore, make sure that the search criteria are in the desired state before using the data. You cannot manually change the stimulus setting for a marker if Tracking is selected for that marker.

Maximum Marker locates the maximum (highest) data value.

Minimum Marker locates the minimum (lowest) data value.

Peak - [See below.](#)

Next Peak - Marker locates the peak with the next lower amplitude value relative to its starting position.

Peak Right - The marker locates the **next valid peak to the right** of its starting position on the X-axis.

Peak Left - The marker locates the **next valid peak to the left** of its starting position on the X-axis.

Multi Peak - A function that search for peaks that match the multi-peak search excursion value and multi-peak polarity value. [Learn more about Multi Peak Search.](#)

- **Threshold** - Minimum amplitude (dB). To be considered valid, the peak must be **above** the threshold level. The valley on either side can be below the threshold level.
 - **Excursion** The vertical distance (dB) between the peak and the valleys on both sides. To be considered a peak, data values must "fall off" from the peak on both sides by the excursion value.
-

Target - A function that searches for a target that matches the pre-defined target value and transition types (positive, negative or both (positive and negative)) and then moves the marker to that target. [Learn more about Multi Target Search.](#)

Target Left - A function executes the search from the current marker position to the smaller stimulus values and moves the marker to first target encountered.

Target Right - A function executes the search from the current marker position to the larger stimulus values and moves the marker to first target encountered.

Multi Target - A function that search for targets that are of the multi-target value and multi target transition value. [Learn more about Multi Target Search.](#)

- Target - Value in dB.
-

Compression - A function used the active marker to find the specified gain **Compression Level**. [Learn more about Compression Search.](#)

- Compression - Value in dB.
-

Bandwidth and **Notch** searches are accessed by pressing **Search** > **Bandwidth & Notch** > **BW Ref to** or **Search** > **Bandwidth & Notch** > **Notch Ref to**.

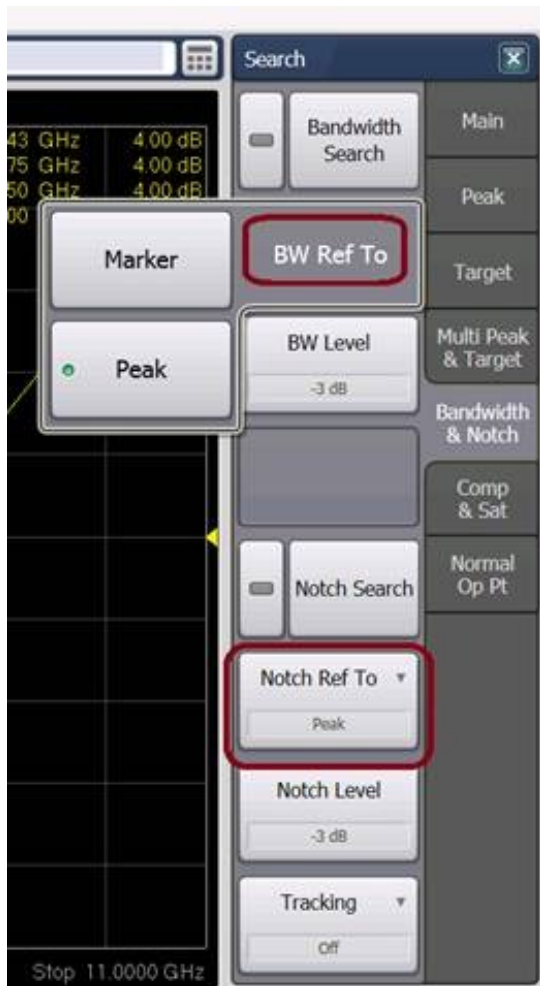

Bandwidth - A function for determining the bandwidth of the trace, center frequency, cut-off points (on the higher frequency and the lower frequency sides), Q and insertion loss based on the position of the active marker (if search mode set to Marker) or the peak marker (if search mode set to Peak). [Learn more about Bandwidth Search.](#)

- Bandwidth peak mode search
 - If level is negative, search is relative to the maximum peak.
 - If level is positive, search is relative to the minimum peak.
 - Bandwidth level in dB.

Notch - A function is used to obtain the bandwidth, center frequency, cutoff points (high-frequency side and low-frequency side), Q and insertion loss of a trace based on the position of the active marker (if search mode set to Marker) or the peak (if search mode set to Peak). [Learn more about Notch Search.](#)

- Notch peak mode search

- If level is negative, notch search is relative to the minimum peak.
- If level is positive, notch search is relative to the maximum peak.
- Notch level in dB.

The default behavior for searches based on the active marker or peak marker can be set using the **Marker: On Preset, set BW/Notch search reference to Peak** preference.

Power Saturation - [Learn more about PSAT Search.](#)

- PMax Back-off -Value in dB.

Normal Operating Pt - The output power where the input is offset from the back-off input power by the Pin Offset. [Learn more about PNOP Search.](#)

- Back-off - Value in dB.
- Pin Offset - X-axis value in dB.

Maximum and Minimum Search

How to create Maximum and Minimum Search

Using **Hardkey/SoftTab/Softkey**

1. Press **Search > Main**.
2. Click **Max Search** or **Min Search**.
3. Optionally click **Tracking** to search for the specified maximum or minimum level with each sweep. [Learn more.](#)

Using a mouse

1. Move a cursor on a marker.
2. Right-click on the marker and then select **Search....**
3. From **Search Type** of Marker Search dialog box, select **Maximum / Minimum**.
4. Press Execute or check Tracking. [Learn more.](#)

Programming Commands

You can search for the maximum or minimum measured value on the trace and move a marker to that point.

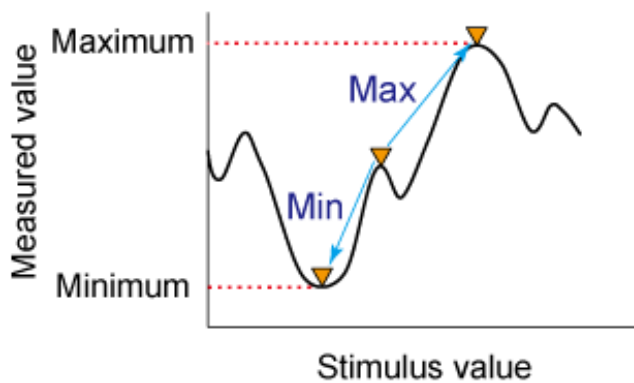

Search for maximum (Max Move active marker to point on trace where
Search) measured value is greatest.

Search for minimum (Min Move active marker to point on trace where
Search) measured value is lowest.

Note: When the data format is in Smith chart or polar format, execute the search only for the main response value.

Peak Search

How to create Peak Search

Using **Hardkey/SoftTab/Softkey**

1. Press **Search > Peak**.
2. Click **Peak Search** to show the markers on the peak.
3. Click **Peak Right >> Search**, **<< Peak Left Search** or **Next Peak Search** to move the marker to the peak.
4. Click **Threshold** to enter the value of peak threshold.
5. Click **Excursion** to enter the lower limit value of peak excursion.
6. Click **Peak Polarity** to select a **peak polarity**.
7. Optionally click **Tracking** to search for the specified peak level with each sweep. **Learn more**.

Using a mouse

1. Move a cursor on a marker.
2. Right-click on the marker and then select **Search....**
3. From Search Type of Marker Search dialog box, select **Peak / Peak Left / Peak Right / Next Peak**.
4. Enter the value of **Threshold** and **Excursion**.
5. Press **Execute** or check **Tracking**. **Learn more**.

A peak is a measurement point whose value is greater or smaller than the adjoining measurement points on its right and left sides. Peaks are classified into the following two types depending on the difference in magnitude from the measurement points on either side of it.

What Is a "Peak"?

You define what the analyzer considers a "peak" by selecting the following two peak criteria settings:

- **Threshold** - Minimum amplitude (dB). To be considered valid, the peak must be **above** the threshold level. The valley on either side can be below the threshold level.
- **Excursion** - The vertical distance (dB) between the peak and the valleys on both sides. To be considered a peak, data values must "fall off" from the peak on both sides by the excursion value.

Peak Polarity:	Definition:
Positive	A peak whose measured value is greater than those of the measurement points on either side of it. Detect positive peaks which are larger than Threshold.
Negative	A peak whose measured value is smaller than those of the measurement points on either side of it. Detect negative peaks which are smaller than Threshold.
Both	A peak whose measured value is smaller and greater than those of the measurement points on either side of it. Threshold value is not used when polarity is set to both.

About Peak Excursion Value

The peak excursion value is the smaller of the differences in measured values from the adjoining peaks of the opposite polarity.

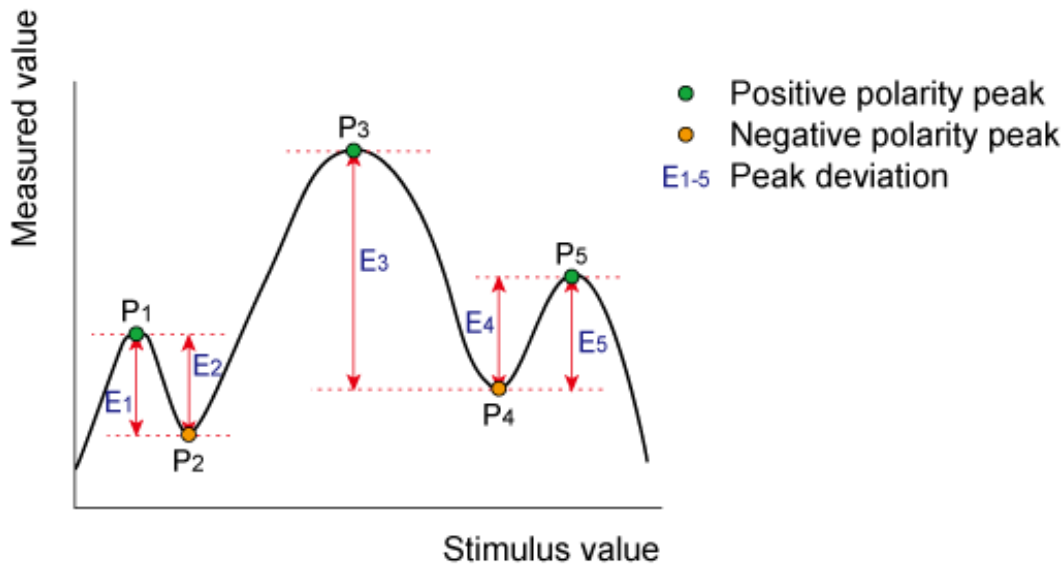

Executing a Peak Search

The following 3 methods are available for executing the peak search:

Next Peak Moves the marker to the maximum peak when peak polarity is Positive or Both.

Moves the marker to the minimum peak when peak polarity is Negative.

Peak Left Executes the search from current marker position to the **smaller** stimulus values and moves the marker to first peak encountered.

Peak Right Executes the search from current marker position to the **larger** stimulus values and moves the marker to first peak encountered.

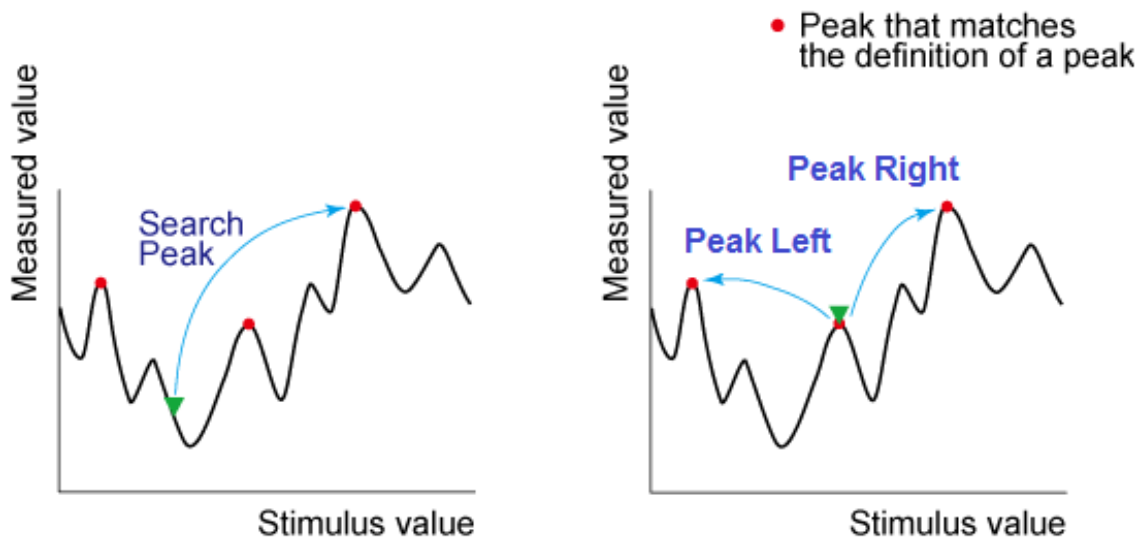

Note: Peak right, peak left and next peak may not be tracked. If these searches are selected and then tracking is turned on, the peak tracking is enabled.

When the data format is in Smith chart or polar format, execute the search for the main response value of the two marker response values.

Changing the settings of **peak excursion value** or **peak polarity** executes new search for multiple peak.

Example:

Threshold Setting: -10dB

Excursion Setting: 1dB

Scale = 1 dB / Division

Mouse over the graphic to find a valid peak.

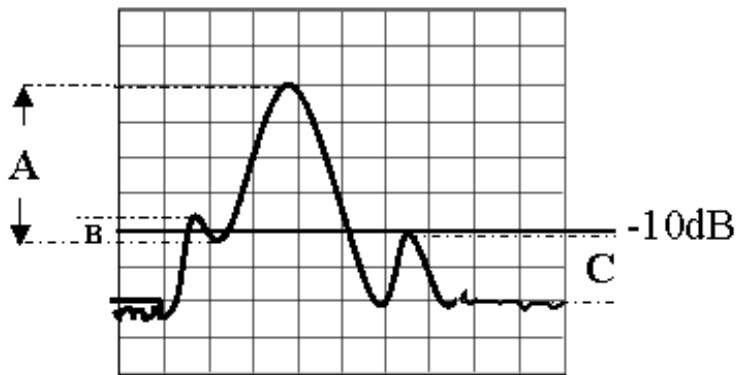

- **Peak A** = Valid Peak (Above Threshold and Excursion Settings)
- **Peak B** = Invalid Peak (Below Excursion Setting)
- **Peak C** = Invalid Peak (Below Threshold Setting)

Multi Peak Search

How to create Multi Peak Search

Using **Hardkey/SoftTab/Softkey**

1. Press **Search** > **Multi Peak & Target**.
2. Click **Multi Peak Search** to show the markers on the multi peaks.
3. Click **Peak Threshold** to enter the value of peak threshold.
4. Click **Peak Excursion** to enter the lower limit value of peak excursion.
5. Click **Peak Polarity** to select a **peak polarity**.
6. Optionally click **Tracking** to search for the specified multi peak level with each sweep.
[Learn more.](#)

Using a mouse

1. Move a cursor on a marker.
2. Right-click on the marker and then select **Search....**
3. From **Search Type** of Marker Search dialog box, select **Multi Peak**.
4. Enter the value of **Threshold** and **Excursion**.
5. Press Execute or check Tracking. [Learn more.](#)

Programming Commands

The multi peak search function enables you to display markers on multiple peaks on traces. Depending on the number of detected peaks, markers 1 through 15 are displayed from the start frequency. The reference marker is not affected.

Multiple peak search has **threshold**, **excursion** and **polarity** as user defined values. This search may have tracking enabled.

When the multiple peak search is executed, previous markers search and tracking are disabled and the settings for the multiple peak search are used.

Note: Do not use individual marker settings or marker domain.

Put markers on each valid peak, using up to 15 markers.

Target Search

How to create Target Search

Using **Hardkey/SoftTab/Softkey**

1. Press **Search > Target**.
2. Click **Target Search** to enable the target search.
3. Click **Target Right >> Search** or **<< Target Left Search** to move the marker to the target.
4. Click **Target Value** to input the value of target search.
5. Click **Transition** to select a transition type.
6. Optionally click **Tracking** to search for the specified target level with each sweep. [Learn more](#).

Using a mouse

1. Move a cursor on a marker.
2. Right-click on the marker and then select **Search....**
3. From **Search Type** of Marker Search dialog box, select **Target/Target Left/Target Right**.
4. Enter the value of the **Target**.
5. Press **Execute** or check **Tracking**. [Learn more](#).

Programming Commands

The target search is a function that searches for a target that matches the pre-defined target value and transition types (positive, negative or both positive and negative) and then moves the marker to that target.

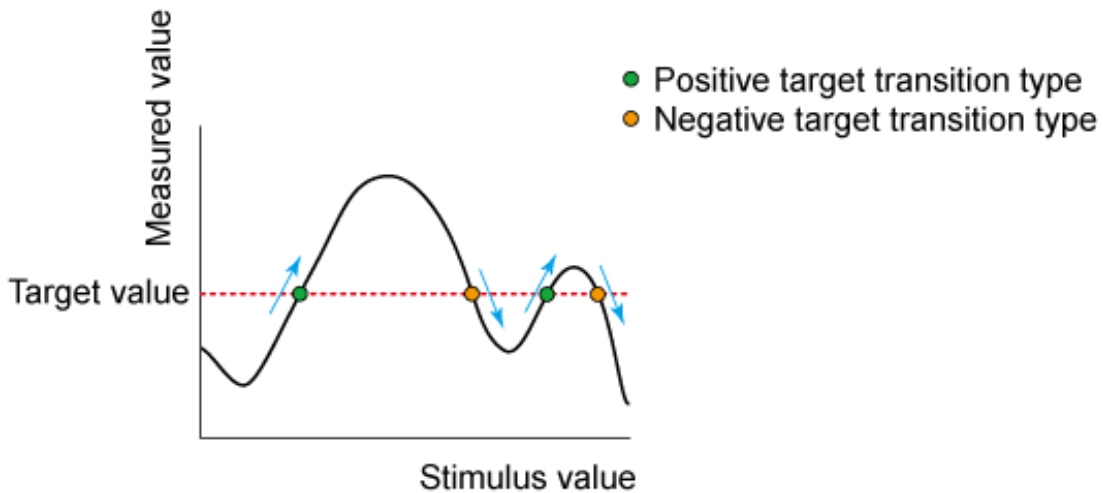

Target Transition Types

A target is a point that has a specific measured value on the trace. Targets can be divided into the 3 groups shown below depending on their transition type.

Transition Type:	Function:
Positive	The target value is larger than the measured value immediately preceding it.
Negative	The target value is smaller than the measured value immediately preceding it.
Both	The conditions for either Positive or Negative transition are satisfied.

Executing a Target Search

The following 3 methods are available for executing the target search:

Target Left	Executes the search from the current marker position to the smaller stimulus values and moves the marker to first target encountered.
Target Right	Executes the search from the current marker position to the larger stimulus values and moves the marker to first target encountered.
Multi Target	Executes the search for targets that are of the multi-target value and multi target transition value. See Multi Target Search .

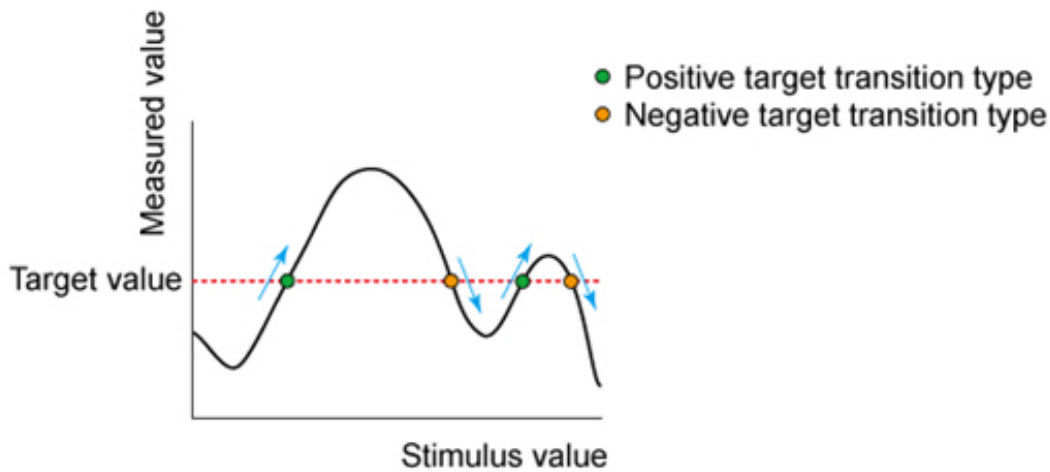
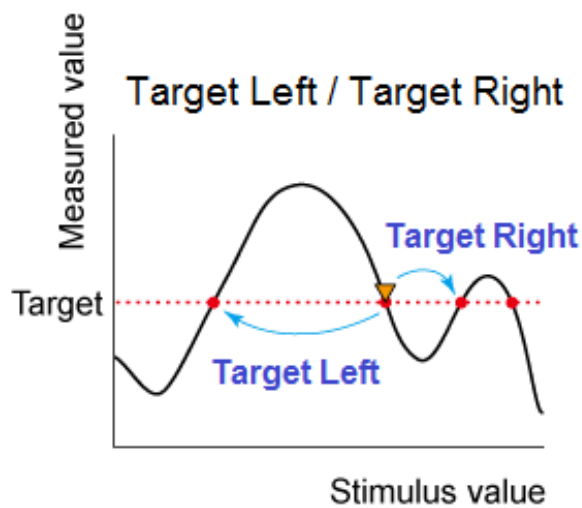
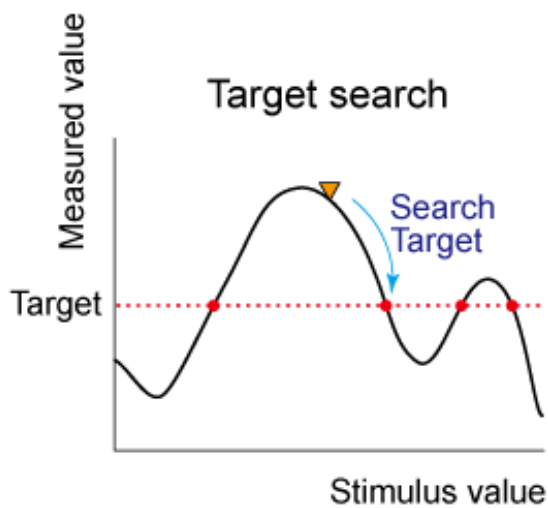

Note: Target right and target left cannot have tracking enabled. If target left or target right is the selected search and then tracking is enabled, target tracking is enabled.

When the data format is in Smith chart or polar format, execute the search for the main response value of the 2 marker response values.

Changing the settings of target value or transition type executes new search for multiple target.

The marker moves to the first occurrence of the Target value to the right of its current position. Subsequent presses of the **Target Search** softkey cause the marker to move to the next value to the right that meets the Target value. When the marker reaches the upper end of the stimulus range, it will "wrap around" and continue the search from the lower end of the stimulus range (left side of the window).

- If **Discrete Marker** is OFF, the marker locates the interpolated data point that equals the target value.
- If **Discrete Marker** is ON and there are two data points on either side of the target value, the marker locates the data point closest to the Target value

Multi Target Search

How to create Peak Search

Using **Hardkey/SoftTab/Softkey**

1. Press **Search** > **Multi Peak & Target**.
2. Click **Multi Target Search** to show the markers on the multi target.
3. Click **Target Value** to enter the value of target.
4. Click **Transition** to select a transition type.
5. Optionally click **Tracking** to search for the specified multi target level with each sweep.
[Learn more.](#)

Using a mouse

1. Move a cursor on a marker.
2. Right-click on the marker and then select **Search....**
3. From **Search Type** of Marker Search dialog box, select **Multi Target**.
4. Enter the value of the **Target**.
5. Press **Execute** or check **Tracking**. [Learn more.](#)

Programming Commands

The multi target search is a function that searches for targets that match to pre-defined target value and transition types (positive, negative or both of positive and negative) and displays markers on the targets being searched.

Depending on the number of detected targets, markers 1 through 15 are displayed from the start frequency. The reference marker is not affected.

When the multi target search is executed, search and tracking settings for markers 1 through 15 are ignored and the settings for the multi target search are used.

Note: Put markers on each found target value, using up to fifteen markers. Reference marker is not affected. Do not use individual marker settings or marker domain. Search range is applied.

Multiple target search has **target** and **transition types** as user defined values. This search may have tracking enabled. When this search is executing, previous marker searches are disabled.

Bandwidth and Notch Search

Bandwidth and notch search behavior depends on whether the preference called **Marker: Use single marker for marker search** is set or not. When set, only one marker is used for a marker search. Sub markers are displayed and used for Bandwidth and Notch searches. When cleared, multiple markers are used for a marker search. The default is cleared.

How to create Bandwidth and Notch Search

Using **Hardkey/SoftTab/Softkey**

1. Press **Search** > **Bandwidth & Notch**.
2. Click left side **Bandwidth Search** or **Notch Search** small button to turn it ON/OFF.
3. For Bandwidth search, click **BW Ref To** > **Marker** or **Peak**.
4. For Notch search, click **Notch Ref To** > **Marker** or **Peak**.
5. Specify the **BW Level** or **Notch Level** in dB from the peak or valley where bandwidth / notch is measured.
6. Optionally click **Tracking** to search for the specified bandwidth or notch level with each sweep. [Learn more](#).

Using a mouse

1. Move a cursor on a marker.
2. Right-click on the marker and then select **Search....**
3. From **Search Type** of Marker Search dialog, select **Bandwidth** or **Notch**.
4. Specify the **Level** in dB from the peak or valley where bandwidth / notch is measured.
5. Press **Execute** or check **Tracking**. [Learn more](#).

Programming Commands

Bandwidth Search

The bandwidth search is a function for determining the bandwidth of the trace, center frequency, cut-off points (on the higher frequency and the lower frequency sides), Q and insertion loss based on the position of the active marker or peak marker. The definitions of the parameters determined through the bandwidth search are shown in below.

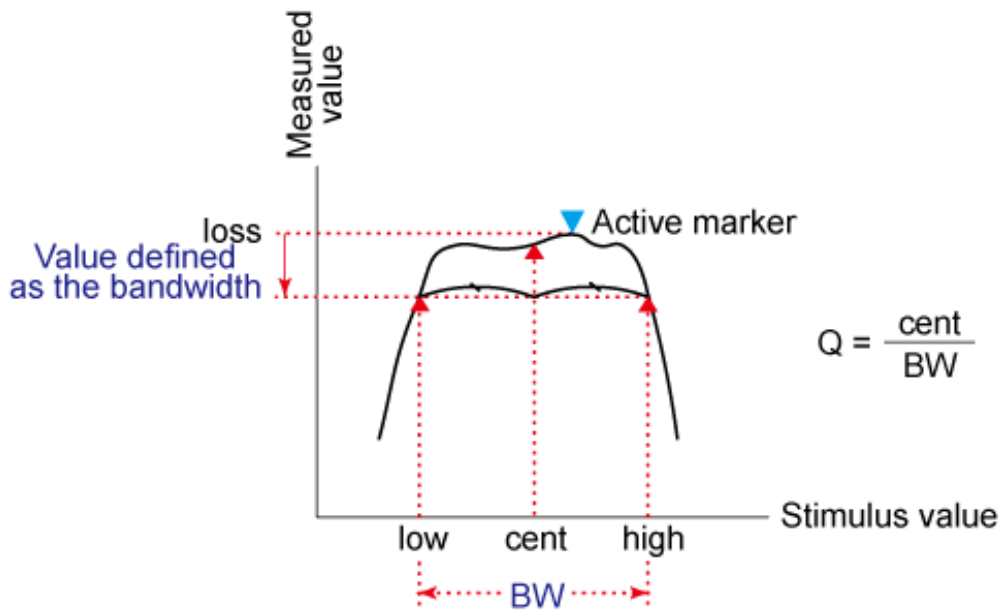

Notch Search

The notch search function is used to obtain the bandwidth, center frequency, cutoff points (high-frequency side and low-frequency side), Q and insertion loss of a trace based on the active marker or peak marker position. The notch search function starts from the left side of the active marker position and ends when points that meet the conditions are found.

The figure and the table below shows the definition of parameters obtained by notch search function. The notch value in figure below must be specified by the user.

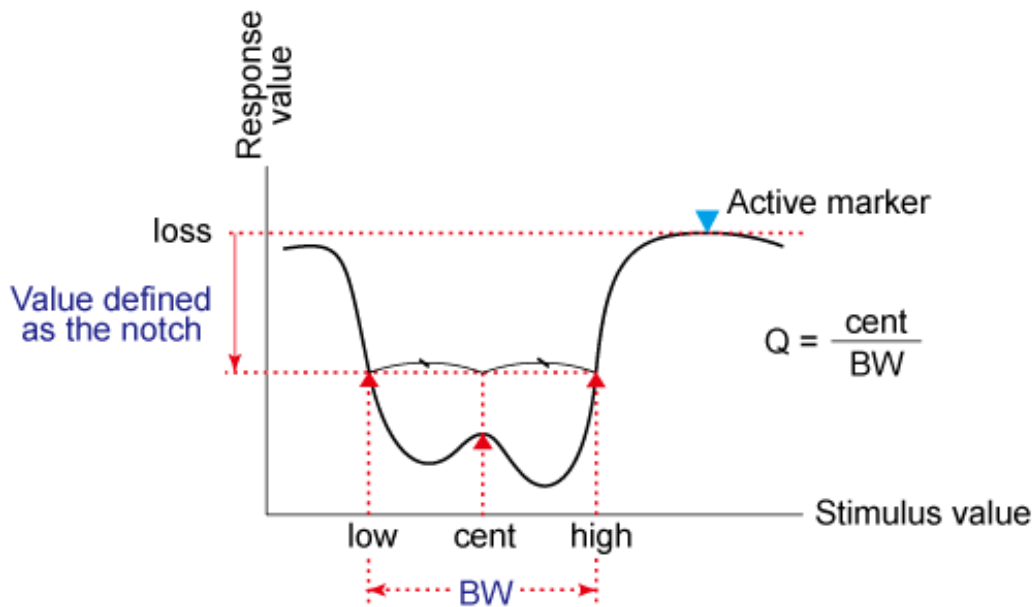

The following values are displayed for Bandwidth and Notch Search:

Bandwidth/Notch Parameter:	Definition:
Bandwidth (BW)	The difference in frequency between the higher frequency cut-off and lower frequency cut-off points (High - Low).
Center frequency (cent)	Frequency at the middle point between the lower frequency cut-off and higher frequency cut-off points. (High + Low)/2.
Lower frequency cut-off point (Low)	Lower frequency of 2 measurement points, both separated by the defined bandwidth / notch value from the active marker position.
Higher frequency cut-off point (High)	Higher frequency of 2 measurement points, both separated by the defined bandwidth / notch value from the active marker position.
Q	Ratio of Center Frequency to Bandwidth (Center Frequency / Bandwidth).
Insertion loss (loss)	The measured value of the position of the center frequency at the time the bandwidth/notch search is executed.

- Bandwidth / Notch Search can be used ONLY with **Log Mag display format**.

- To use Bandwidth Search on a peak or valley other than the maximum or minimum values, change the **Search Domain**.

Compression Search

Uses the active marker to find the specified gain **Compression Level**.

Note: Valid ONLY for S21 (Gain) measurements with a **Power Sweep**.

How to create Compression Search

Using **Hardkey/SoftTab/Softkey**

- Press **Search > Comp & Sat**.
- Click **Compression Search** to turn ON/OFF.
- Specify the **Comp Level** in dB.
- Optionally click **Tracking** to search for the specified compression level with each sweep.
[Learn more.](#)

Using a mouse

- Move a cursor on a marker.
- Right-click on the maker and then select **Search....**
- From **Search Type** of Marker Search dialog box, select **Compression**.
- Enter the Y-axis (Power OUT) difference between the first point and the compression marker.
[Learn more.](#)
- Press **Execute** or check **Tracking**. [Learn more.](#)

Programming Commands

Linear gain is defined as the Y-axis value (gain) of the first data point of the **Search Domain** (Full Span by default).

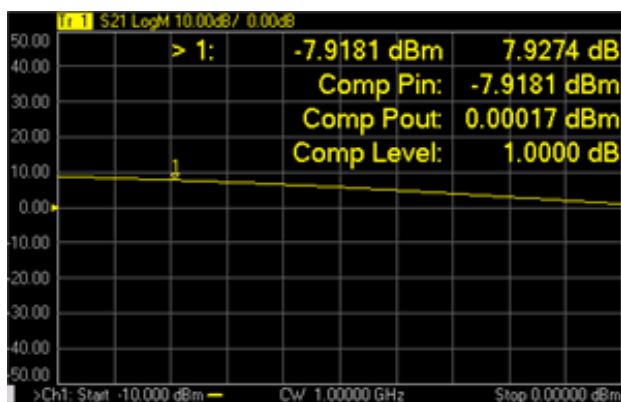

Marker > N - X-axis value and Y-axis value.

Comp Pin - Input power (marker X-axis value).

Comp Pout - Output power (Pin + gain).

Comp Level - Compression level found.

- When **Discrete** is **OFF** (default setting), the marker finds the exact specified compression, interpolated between the two closest data points and calculates the Comp Pin and Comp Pout value for that point.
- The marker can move from one actual measurement point to another. Because it is interpolated, it can also move in the space between measurement points.
- When **Discrete** is **ON** (not interpolated), the marker resides on the closest data point to the requested compression level.
- A marker moves only between actual measurement points. When a specific marker stimulus value is specified as a numerical value, the marker is placed at the measurement point closest to the specified value. A marker that is placed between interpolated points with the discrete mode off automatically moves to the nearest measurement point when the discrete mode is turned on.

Comp. Not Found - Displayed when the requested compression level is not found.

About PSAT and PNOP Search

Compression measurements based on the Pout vs Pin curves are common in the satellite test industry. In the case of Travelling Wave Tube (TWT) amplifiers, PSAT markers identify the normal operating point near saturation, and the amplifiers are operated with the power slightly backed-off approximately 0.03 to 0.1 dB. For TWT amplifiers, the saturation curve always "folds over" and produces a maximum power out.

For Solid State Power Amplifiers (SSPA), the saturation is not as well defined. A common reference is the Normal Operating Point, which is a power backed-off by 8 to 10 dB from the maximum power. In this case, the normal operating point marker replaces the Psat with the PNOP values. Also, because the backoff is important, the backoff output and input powers are displayed (PBO Out), (PBO in) as well as gain at back off (PBO Gain).

Power Saturation (PSAT) Search

If the **Marker: Use single marker for marker search** preference is cleared, this search uses Markers 1, 2, and 3 to quickly identify output power saturation parameters of an amplifier. If the **Marker: Use single marker for marker search** preference is set, then only one marker is used for the search and 2 notational markers are displayed. The notational markers may not be moved. These markers are for

display purposes only.

Back-off is a point at which the output power is sufficiently lower than the saturated output power so that the device under test behaves in a more linear fashion.

Note: Valid ONLY for Power IN vs Power OUT measurements.

How to make Power IN (X-axis) vs Power OUT (Y-axis) measurement

Using **Hardkey/SoftTab/Softkey**

1. Press **Preset**.
2. Press **Sweep > Main > Sweep Type**.
3. Select **Power Sweep**.
4. Press **Trace > Trace Setup > Measure...** and set **Trace Meas** to "B" Receiver
5. Connect DUT input to port 1.
6. Connect DUT output to port 2.

Programming Commands

How to create PSAT Search

Using **Hardkey/SoftTab/Softkey**

1. Press **Search > Comp & Sat**.
2. Click left side **Saturation Search** small button to turn ON/OFF.
3. For **PMax Back-Off**, enter the Y-axis (Power OUT) difference between the Max Power marker (3) and the Back-off marker (2).
4. Optionally click **Tracking** to search for the specified power saturation level with each sweep. [Learn more](#).

Using a mouse

1. Move a cursor on a marker.
2. Right-click on the marker and then select **Search > Search...**
3. From **Search Type** of Marker Search dialog box, select **Power Saturation**.
4. For **PMax Back-Off**, enter the Y-axis (Power OUT) difference between the Max Power marker (3) and the Back-off marker (2).
5. Press **Execute** or check **Tracking**. [Learn more](#).

Programming Commands

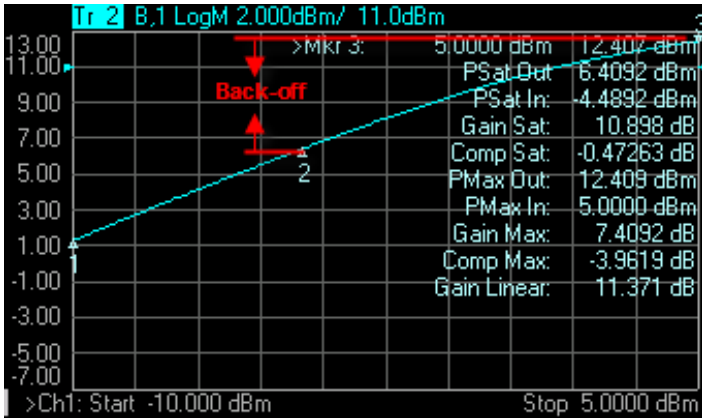

This setting uses **three** markers to calculate and display 10 values.

The three markers:

- Marker 1: Linear gain; the first data point in the sweep.
- Marker 2: Specified output power **Back-off** from max power.
- Marker 3: Max Power output; usually the last data point.

The 9 displayed values:

Param	Description	Calculated from...
PSat Out	Output power at the saturation point.	Marker 2 Y-axis value
PSat In	Input power at the saturation point.	Marker 2 X-axis value
Gain Sat	Gain at the saturation point.	Psat Out - Psat In
Comp Sat	Compression at the saturation point.	Gain Sat - Gain Linear
PMax Out	Maximum output power.	Marker 3 Y-axis value
PMax In	Input power at the maximum output power.	Marker 3 X-axis value
Gain Max	Gain at the maximum output power.	PMax Out - PMax In
Comp Max	Compression at the maximum output power.	Gain Max - Gain Linear
Gain Linear	Linear gain at the first data point.	Marker 1 - Y-axis value MINUS X-axis value

- **Comp. Not Found** is displayed when the requested Back-off point is not found.

- When **Discrete** marker is NOT selected (the default setting), the three markers find an interpolated value between the two closest data points.
- When **Discrete** marker is selected (NOT interpolated), the three markers reside on the closest data points.

Power Normal Operating Point (PNOP) Search

If the **Marker: Use single marker for marker search** preference is cleared, this search uses Markers 1, 2, 3, and 4 to quickly identify Normal Operating Point parameters of an amplifier. If the **Marker: Use single marker for marker search** preference is set, then only one marker is used for the search and 2 notational markers are displayed. The notational markers may not be moved. These markers are for display purposes only.

Back-off is a point at which the output power is sufficiently lower than the saturated output power so that the device under test behaves in a more linear fashion.

The power normal operating point is the output power where the input is offset from the back-off input power by the Pin Offset.

Note: Valid ONLY for Power IN vs Power OUT measurements.

See **Power Saturation** to learn how to make a Power IN (X-axis) vs Power OUT (Y-axis) measurement.

How to create PNOP Search

Using **Hardkey/SoftTab/Softkey**

1. Press **Search > Normal Op Pt.**
2. Click left side **Normal OP Search** small button to turn ON/OFF .
3. For **Back-Off**, enter the Y-axis (Power OUT) difference between the Max Power marker (3) and the Back-off marker (2).
4. For **Pin Offset**, enter the X-axis (Power IN) difference between Back-off marker (2) and PNOP marker (4).
5. Optionally click **Tracking** to search for the specified power normal operating point level with each sweep. [Learn more.](#)

Using a mouse

1. Move a cursor on a marker.
2. Right-click on the marker and then select **Search > Search....**
3. From **Search Type** of Marker Search dialog box, select **Normal Operating Pt.**
4. For **Back-Off**, enter the Y-axis (Power OUT) difference between the Max Power marker (3) and the Back-off marker (2).
5. For **Pin Offset**, enter the X-axis (Power IN) difference between Back-off marker (2) and PNOP marker (4).
6. Press **Execute** or check **Tracking**. [Learn more.](#)

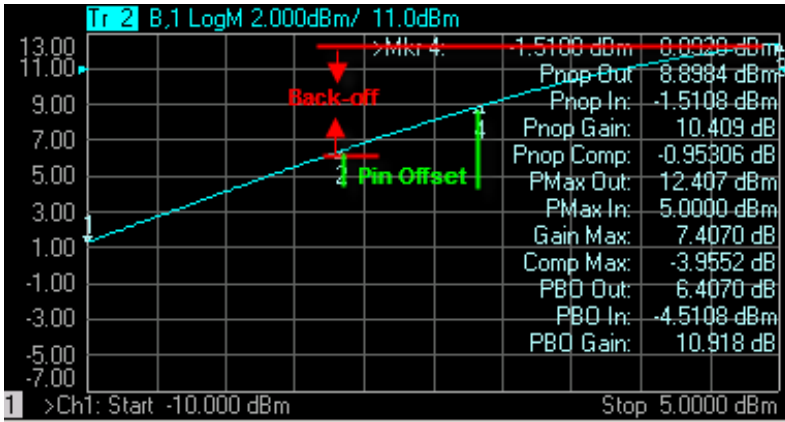

This setting uses **four** markers to calculate and display 12 values.

The **four** markers:

- Marker 1: Linear gain; the first data point in the sweep.
- Marker 2: Max Output Power MINUS the specified Output (Y-axis) **Back-off** value in dB.
- Marker 3: Max Output Power; usually the last data point in the sweep.
- Marker 4: X-axis value of Back-off (Marker 2) plus the **Pin Offset** (X-axis) value in dB.

The 11 displayed values:

Param	Description	Calculated from...
Pnop Out	Output power at the power normal operating point.	Marker 4 Y-axis value
Pnop In	Input power at the power normal operating point.	Marker 4 X-axis value
Pnop Gain	Gain at the power normal operating point.	Pnop Out - Pnop In
Pnop Comp	Compression at the power normal operating point.	Pnop Gain - Linear Gain*
PMax Out	Maximum output power.	Marker 3 Y-axis value
PMax In	Input power at the maximum output power.	Marker 3 X-axis value
Gain Max	Gain at the maximum output power.	PMax Out - PMax In
Comp Max	Compression at the maximum output power.	Gain Max - Linear Gain*
PBO Out	Output power at the back-off point.	Marker 2 Y-axis
PBO In	Input power at the back-off point.	Marker 2 X-axis
PBO Gain	Gain at the back-off point.	PBO Out - PBO In

***Linear Gain (not shown):** Marker 1 - Y-axis value MINUS X-axis value

- **PNOP Not Found** is displayed when the requested back-off level is not found.
- When **Discrete** marker is NOT selected (the default setting), the four markers each find an interpolated value between the two closest data points.
- When **Discrete** marker is selected (NOT interpolated), the four markers each reside on the closest data point.

Search Domain

Search domain settings restrict the stimulus values (X-axis for rectangular format) to a specified span. Set the Start and Stop stimulus settings of these **User** spans. If Start is greater than Stop, the marker will not move. [Learn how to set Search Domain.](#)

- The default domain of each new marker is "full span".
- There are 16 user-defined domains for every channel.
- The user-defined domains can overlap.
- More than one marker can use a defined domain.
- Search Domain settings are shared with [Trace Statistics User Ranges](#)

The graphic below shows examples of search domains.

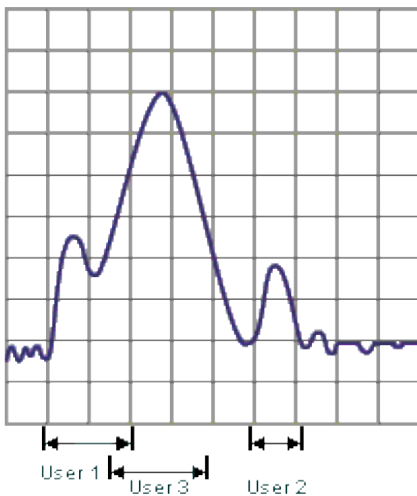

Search Range Indicators

A search range will be indicated with a pair of small, outlined triangles sitting on the X-axis. Although there can be multiple search ranges in use on various markers, only the current-selected search range for the active marker is displayed. This rule prevents the possibility of the X-axis being cluttered with many search range triangles. This rule applies even when there are multiple traces in a window.

Only one search range will be displayed on a grid at any time. The displayed search range will correspond to the active trace and active marker. The color of the range indicators will match that of the active trace.

Range indicators will appear automatically when appropriate and cannot be disabled. The mouse or touchscreen can't be used to “click-and-drag” the position of the range indicators which will alter the search range definition.

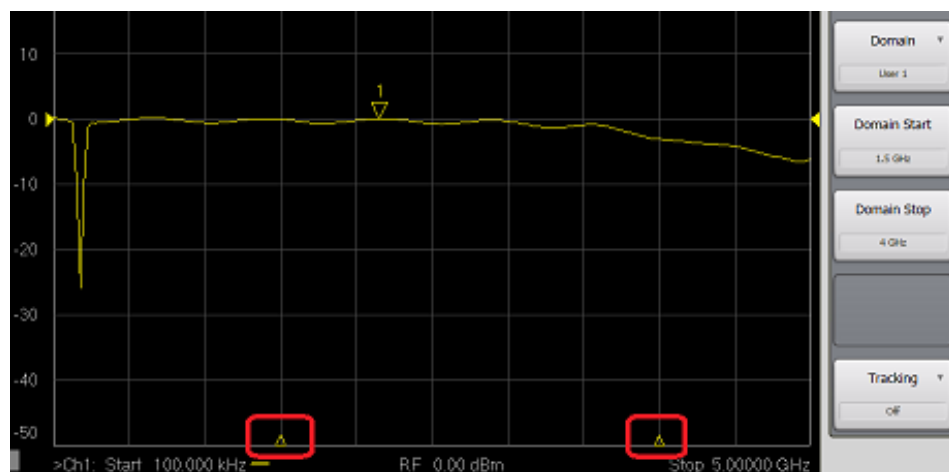

Search Within

The zoomed frequency range becomes the **User 16** Search Domain span.

A marker is created if not already present on the trace. If markers are already present on the trace, the lowest marker is moved to the found value.

1. Left-click the mouse or use a finger, then drag across a portion of a trace.
2. Release the mouse or lift the finger.
3. Select **Search Within**.
4. Then choose from the following:
 - **Max** - A marker moves to the HIGHEST value within the zoomed range.
 - **Min** - A marker moves to the LOWEST value within the zoomed range.

- **Target** - A marker moves to the first value within the zoomed range that is currently set in the **Marker Search 'Target' setting**. The same Discrete Marker rules apply as those for the standard Target Marker Search.

Marker Functions - Change Instrument Settings

The following settings change the relevant VNA settings to the position of the active maker.

How to change Instrument settings using markers

Using **Hardkey/SoftTab/Softkey**

1. Press **Marker > Marker->Functions**.

Using a mouse

1. Move a cursor on a marker.
2. Right-click on the marker and then select **Functions**.
3. Select the desired search function.
4. Click **Function...** to show the Marker Function Dialog box.

Programming Commands

Marker Function dialog box help

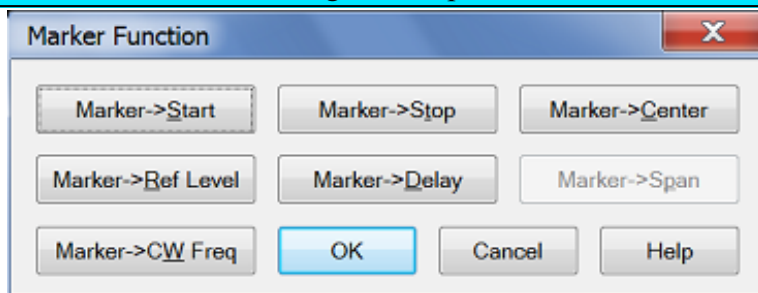

Note: Marker Functions do not work with channels that are in **CW** or **Segment Sweep** mode.

Marker =>Start Sets the start sweep setting to the value of the active marker.

Marker =>Stop Sets the stop sweep setting to the value of the active marker.

Marker =>Center Sets the center of the sweep to the value of the active marker.

Marker =>Ref Level Sets the screen **reference level** to the value of the active marker.

Marker =>Delay The phase slope at the **active marker** stimulus position is used to adjust the line length to the receiver input. This effectively flattens the phase trace around the active marker. Additional Electrical Delay adjustments are required on devices without constant group delay over

the measured frequency span. You can use this to measure the electrical length or deviation from linear phase.

This feature adds phase delay to a variation in phase versus frequency; therefore, it is only applicable for ratioed measurements. See [Measurement Parameters](#).

Marker =>Span Sets the sweep span to the span that is defined by the **delta marker** and the marker that it references. Unavailable if there is no delta marker.

Marker =>CW Freq Sets the CW frequency to the frequency of the active marker. NOT available when the channel is in CW or Power Sweep. Use this function to first set the CW Frequency to a value that is known to be within the current calibrated range, THEN set **Sweep Type** to Power or CW.

Note: Some Marker Functions do not work with channels that are in certain **Sweep Types**.

Marker Function	Sweep Type			
	Lin/Log Freq.	Segment	Power	CW Time
Start, Stop, Center	F		S	
Span	S		S	
RefLevel	F	S	S	S
Delay	F	S	S	S
CW Freq.	S	S		

F: Available in both Standard and SMC classes

S: Available in only Standard Class

Spectrum Analysis markers

Using **Hardkey/SoftTab/Softkey**

1. Press **Marker** > **SA Analysis**.

Using a mouse

1. Click **Response**.
2. Select **Marker**.
3. Select the desired marker.

Programming Commands

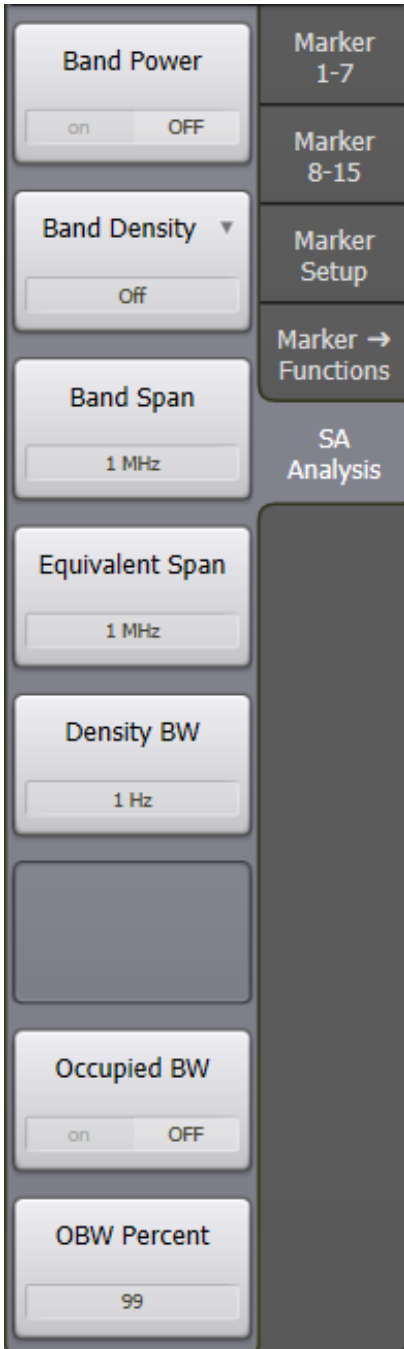

Marker Display

The marker display dialog allows you to change how markers and the associated readout is displayed on the VNA screen. Several marker display features also apply to **Statistics** display.

How to change Marker Display settings

Using **Hardkey/SoftTab/Softkey**

1. Press **Marker** > **Marker Setup** > **Marker Display....**

OR

1. Press **Display** > **Display Settings** > **Customize Display....**
2. Select **Markers** tab.

Using a mouse

1. Move a cursor to the marker data area on top right corner of grid box.
2. Right click on the marker data display area.
3. Select **Marker Display....**

OR

1. Right click on any window area.
2. Click **Customize Display....**
3. Select **Markers** tab.

Programming Commands

Customize Display dialog box help

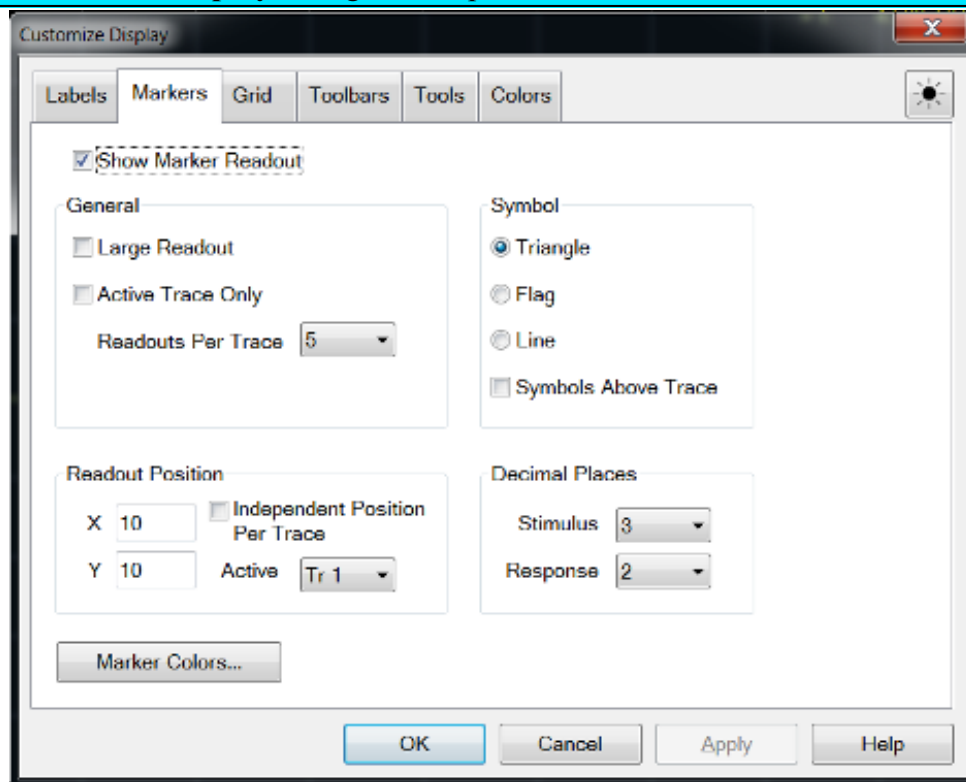

The following settings apply to readouts of ALL currently-displayed marker, bandwidth, and **trace statistics**.

These settings revert to their defaults on Preset but ARE stored with **Instrument State** and **User Preset**.

Marker Readout

Checked - Shows readout information.

Cleared - Shows NO readout information.

Large Readout

Checked - Shows the marker readout in large font size for easy reading. However, all readout lines may not be visible.

Cleared - Shows the marker readout in normal font size.

Active Trace Only

Checked - Shows the marker readout for the active trace only.

Cleared - Shows all marker readouts.

Readouts Per Trace

Choose the quantity of marker readouts to show in the window for each trace. Choose to display up to 16 readouts per trace, up to 20 readouts per window. When more markers are present than the specified quantity of readouts, the marker numbers for which readouts are displayed can change depending on the marker number that is active. Readouts Per Trace can be set independently for each window.

Symbol

Choose from the following marker symbols.

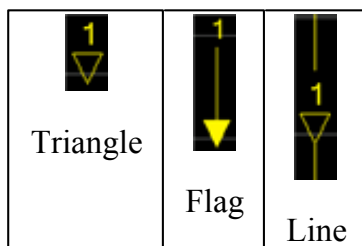

Line symbols are NOT used on Smith or Polar **display formats**.

Symbols can be set independently for each window.

Symbols Above Trace

Cleared - ONLY the active marker is displayed above the trace. Inactive markers are displayed below the trace.

Checked - ALL marker symbols are displayed above the trace. The active marker is always filled solid.

Decimal Places

Choose the marker readout resolution to display. These values also apply to the readouts that are displayed in the [marker table](#). Decimal Places can be set independently for each window.

Stimulus (X-axis) - Choose from **2** to **6** places after the decimal point. Default is 3.

Response (Y-axis) - choose from **1** to **4** places after the decimal point. Default is 2.

Readout Position

Choose where to place the marker readouts. Marker readouts are right-justified on the specified X-axis and Y-axis position. The default position (10.0, 10.0) is the upper-right corner of the grid. Position (1.0,1.0) is the lower-left corner. Readout position can also be set independently for each window.

Note: Readout Position can also be changed using a mouse by left-clicking on the top readout and dragging to the new position.

Marker Colors Starts the Display Colors dialog with only the marker colors available. [Learn more.](#)

Marker Table

You can display a table that provides a summary of marker data for the active trace. The marker data is displayed in the specified format for each marker.

How to view the Marker Table

Using [Hardkey](#)/[SoftTab](#)/[Softkey](#)

1. Press [Marker](#) > [Marker Setup](#) > [Marker Table](#).

[Programming Commands](#)

Using Math / Memory Operations

You can perform four types of math on the active trace versus a memory trace. In addition three statistics (Mean, Standard Deviation and Peak to Peak) can be calculated and displayed for the active data trace.

- [Trace Math](#)
- [Trace Statistics](#)

Note: Trace Math (described here) allows you to quickly apply one of four math operations using memory traces. [Equation Editor](#) allows you to build custom equations using several types of traces from the same, or different channels.

Other Analyze Data topics

Trace Math

To perform any of the math operations, you must first store a trace to memory. You can display the memory trace using the [View](#) options.

Trace math is performed on the complex data before it is formatted for display. See the [VNA data processing map](#).

Markers can be used while viewing a memory trace.

How to select Trace Math

Using [Hardkey](#)/[SoftTab](#)/[Softkey](#)

1. Press [Math](#) > [Memory](#).

Using a mouse

1. Right click on any trace status area above the grid box.
2. Select on [Memory....](#)

Normalize, available only from the Memory menu, (not on the Math / Memory dialog), performs the same function as **Data=>Memory**, then **Data / Memory**.

[Programming Commands](#)

[Math / Memory dialog box help](#)

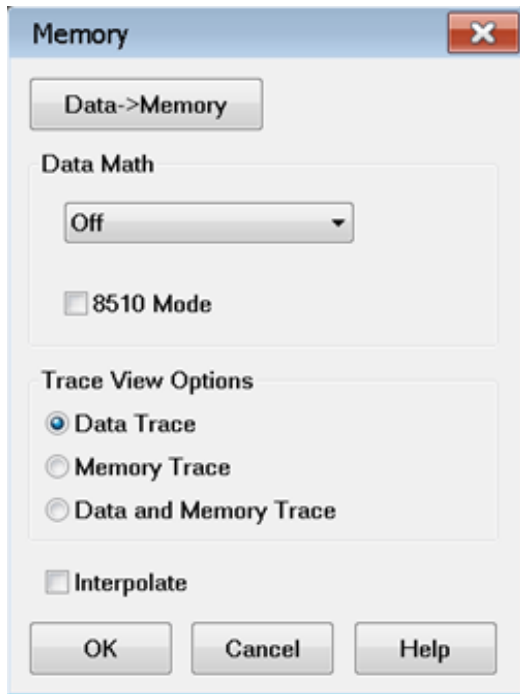

Normalize, available only from the Memory menu, (not on the Math / Memory dialog), performs the same function as **Data=>Memory**, then **Data / Memory**.

Data=>Memory Puts the active data trace into memory. You can store one memory trace for every displayed trace.

Note: Many VNA features are NOT allowed on Memory traces. For example, Memory traces can NOT be saved to any **file type** (PRN, SNP, CTI, CSV, MDF). However, you can restore a memory trace to a data trace using the **Memory-to-Data** utility at the <http://na.support.keysight.com/pna/apps/applications.htm> website.

Data Math

All math operations are performed on linear (real and imaginary) data before being formatted. See the [VNA Data flow](#).

Data (or OFF) Does no mathematical operation.

Data / Memory - Current measurement data is divided by the data in memory. Use for ratio comparison of two traces, such as measurements of gain or attenuation. [Learn more](#).

Data – Memory - Data in memory is subtracted from the current measurement data. For example, you can use this feature for storing a measured vector error, then subtracting this error from the DUT measurement. [Learn more](#).

Data + Memory - Current measurement data is added to the data in memory. [Learn more](#).

Data * Memory - Current measurement data is multiplied by the data in memory. [Learn more.](#)

8510 Mode - [Learn more.](#)

Trace View Options

Data Trace Displays ONLY the Data trace (with selected math operation applied).

Memory Trace Displays ONLY the trace that was put in memory.

Data and Memory Trace Displays BOTH the Data trace (with selected math operation applied), and the trace that was put in memory.

Interpolate

Note: The E5080A and M9485A do not support this function.

After performing a Data->Memory operation, memory interpolation controls whether the memory data is interpolated or not if the start frequency, stop frequency, or Number of Points is subsequently changed. Using the GUI control, interpolate applies to the currently active measurement. When using the remote interfaces ([SCPI](#) or [COM](#)), the commands apply to the specified measurement.

Note: Interpolate does not support the 8510 Mode.

The PNA will return to a default interpolation state after a Preset, creating a new trace, or closing the PNA application. The default interpolation state is set in the [Preferences](#) dialog by checking or unchecking the **Memory: Interpolate ON is the default condition** preference. The factory default is unchecked. The default can also be set using the remote interfaces ([SCPI](#) or [COM](#)).

- When unchecked, after a Data->Memory operation the memory trace's x-y positions will not change if the start or stop frequency is subsequently changed. In addition, if the Number of Points in the sweep is changed after a Data->Memory operation, the memory trace will be invalidated and disappear. If the Number of Points is changed while using Data Math, the Memory trace will be invalidated and Data Math will be forced to the "Off" condition.
- When checked, after a Data->Memory operation the memory trace's x-y positions will be interpolated if the start or stop frequency is subsequently changed. In addition, if the Number of Points in the sweep is changed after a Data->Memory operation, the memory trace will be interpolated.

Note: The PNA will not extrapolate to stimulus values beyond the range that was present at

the time of the Data->Memory operation. Instead, the Memory data will be invalidated if the stimulus values exceed the original range.

Note: If Interpolate is checked (ON) and stimulus conditions are different than they were at the time of Data->Memory operation, unchecking (OFF) Interpolate will cause the Memory trace to be either updated (using both original and current stimulus settings) or invalidated (if Number of Points changed since Data->Memory operation). The Memory trace will remain disabled until either Interpolate is checked (ON) or the stimulus settings corresponding to the Data->Memory operation are restored.

[Learn more about Trace Math](#) (scroll up)

(Data / Memory) and (Data - Memory)

(Data / Memory) and (Data - Memory) math operations are performed on linear data before it is formatted. Because data is often viewed in log format, it is not always clear which of the two math operations should be used. Remember: dividing linear data is the same as subtracting logarithmic data. The following illustrates, in general, when to use each operation.

Use **Data / Memory** for normalization purposes, such as when comparing S21 traces "before" and "after" a change is made or measurement of trace noise. In the following table, the Data/Mem values intuitively show the differences between traces. It is not obvious what Data-Mem is displaying.

S21 values to compare	Data/Mem	Data-Mem
0.5 dB and 0.6 dB	0.1 dB	-39 dB
0.5 dB and 0.7 dB	0.2 dB	-33 dB

Use **Data - Memory** to show the relative differences between two signals. Use for comparison of very small signals, such as the S11 match of two connectors.

In the following table, Data/Mem shows both pairs of connectors to have the same 2 dB difference. However, the second pair of connectors have much better S11 performance (-50 and -52) and the relative significance is shown in the Data-Mem values.

S11 values to compare	Data/Mem	Data-Mem
-10 dB and -12 dB	2 dB	-24 dB
-50 dB and -52 dB	2 dB	-64 dB

Data * Memory and Data + Memory

Use **Data * Memory and Data + Memory** to perform math on an active data trace using data from

your own formulas or algorithms rather than data from a measurement. For example, if you want to simulate the gain of a theoretical amplifier placed in series before the DUT, you could do the following:

1. Create an algorithm that would characterize the frequency response of the theoretical amplifier.
2. Enter complex data pairs that correspond to the number of data points for your data trace.
3. Load the data pairs into memory with SCPI or COM commands. The analyzer maps the complex pairs to correspond to the stimulus values at the actual measurement points.
4. Use the **data + memory** or **data * memory** function to add or multiply the frequency response data to the measured data from the active data trace.

Note: The data trace must be configured before you attempt to load the memory.

Trace Statistics

You can calculate and display statistics for the active data trace. These statistics are:

- Mean
- Standard deviation
- Peak-to-peak values

You can calculate statistics for the full stimulus span or for part of it by using User Ranges.

You can define up to 16 user ranges per channel. These user ranges are the same as the **Search Domain** specified for a marker search in that same channel. They use the same memory registers and thus share the same stimulus spans.

The user ranges for a channel can overlap each other.

A convenient use for trace statistics is to find the peak-to-peak value of passband ripple without searching separately for the minimum and maximum values.

The trace statistics are calculated based on the format used to display the data.

- **Rectangular data formats** are calculated from the scalar data represented in the display
- **Polar** or **Smith Chart** formats are calculated from the data as it would be displayed in **Log Mag** format

See how to make [Trace Statistics display settings](#).

How to activate Trace Statistics

Using **Hardkey/SoftTab/Softkey**

1. Press **Math** > **Analysis** > **Statistics...**

◀ **Programming Commands** ▶

Trace Statistics dialog box help

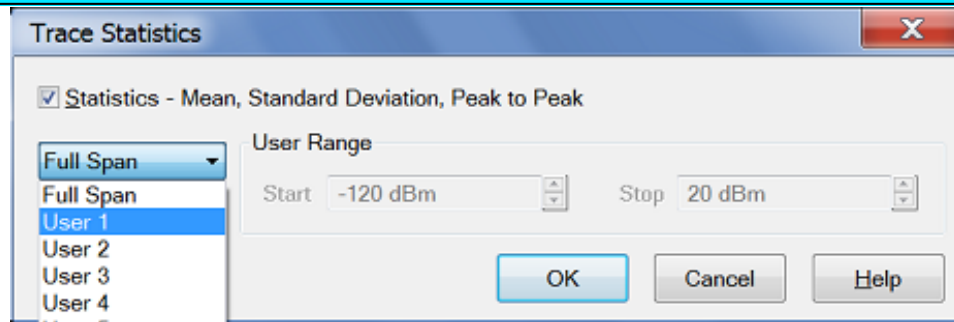

See how to make Trace Statistics display settings.

Statistics Check to display mean, standard deviation, and peak to peak values for the active trace.

Span Specifies the span of the active trace where data is collected for a math operation. You can select Full Span, or define up to 16 user spans per channel with Start and Stop. You can also define the user spans from the Search Domain selector on the **Marker Search dialog box**.

Start Defines the start of a user span.

Stop Defines the stop of a user span.

[Learn more about Trace Statistics](#) (scroll up)

8510 Mode

On the **Trace Math** dialog, check 8510 Mode to simulate the Keysight 8510 data processing chain as it pertains to Trace Math and Memory. This setting applies to all channels. When the box is checked or cleared, the analyzer performs an **Instrument Preset** and retains its setting through subsequent Instrument Presets.

This setting can be saved as part of an **instrument state**. However, when recalled, this setting is assumed only temporarily. When a subsequent analyzer Preset is performed, the analyzer reverts to the setting that was in effect before the state was recalled.

You can **set a preference** to always use 8510 mode.

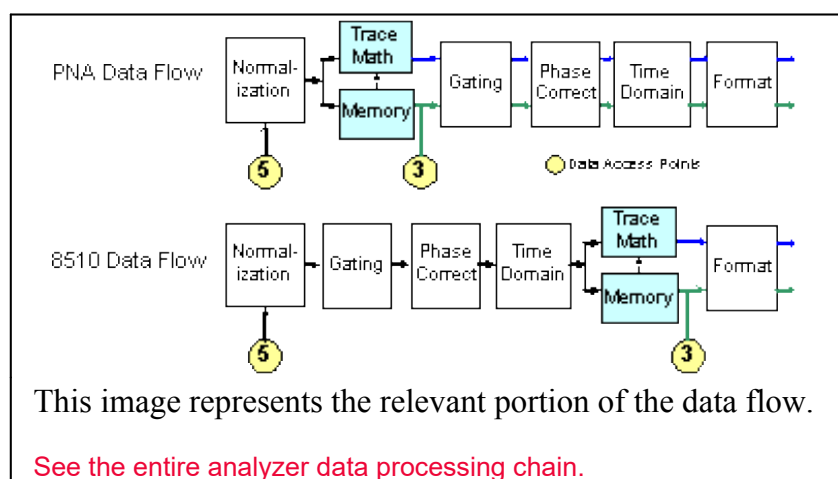

A settings change in any of the operations that occur after the Memory operation on the above analyzer **Data Flow** diagram changes both the Data trace and the Memory trace. For example, after storing a data trace to memory, when you change the format for the Data Trace, the format for the Memory Trace is also changed to the same setting.

How to turn ON/OFF 8510 mode

Using **Hardkey/SoftTab/Softkey**

1. Press **Math > Memory > 8510 Mode**.

No programming are available for this feature

Equation Editor

Equation Editor allows you to enter an algebraic equation that can mathematically manipulate measured data. The results are displayed as a data trace. Data that is used in the equation can be from the same or different channels.

- [Overview](#)
- [How to start Equation Editor](#)
- [Using Equation Editor](#)
- [Data that is used in Equation Editor](#)
- [Trace Settings, Error Correction, and an Example](#)
- [Functions and Constants](#)
- [Operators used in Equation Editor](#)
- [Example Equations](#)
- [Saving Equation Editor Data](#)

See Also

[Equation Editor and MATLAB](#)

[Equation Editor Import Functions](#)

[External DC Meter Data Conversion](#)

- [BestFit.dll](#)
- [EqnErrorTerms.dll](#)
- [Expansion.dll](#)

Other 'Analyze Data' topics

Overview

Equation Editor allows you to enter an algebraic equation of standard mathematical operators and functions, referencing data that is available in the analyzer. Once a valid equation is entered and

enabled, the display of the active trace is replaced with the results of the equation, and updated in real-time as new data is acquired. For equations that can be expressed with Equation Editor's supported functions, operators, and data, there is no need for off-line processing in a separate program.

For example, enter the equation $S_{21} / (1 - S_{11})$. The resulting trace is computed as each S_{21} data point divided by one minus the corresponding S_{11} data point. For a 201 point sweep setup, the computation is repeated 201 times, once for each point.

As another example, suppose you want the analyzer to make a directivity measurement of your 3-port DUT. This is not a native measurement, but can be achieved using the Equation Editor. The desired result is the sum and difference of LogMag formatted traces, expressed as: $S_{12} + S_{23} - S_{13}$.

Because Equation Editor operates on **unformatted complex data**, the required equation is:

```
DIR = S12 * S23 / S13
```

DIR becomes a display label to help you identify the computed data trace.

On the equation trace, set the format to LogMag.

How to start Equation Editor

Using **Hardkey/SoftTab/Softkey**

1. Press **Math** > **Analysis** > **Equation Editor**.

Programming Commands

Equation Editor dialog box help

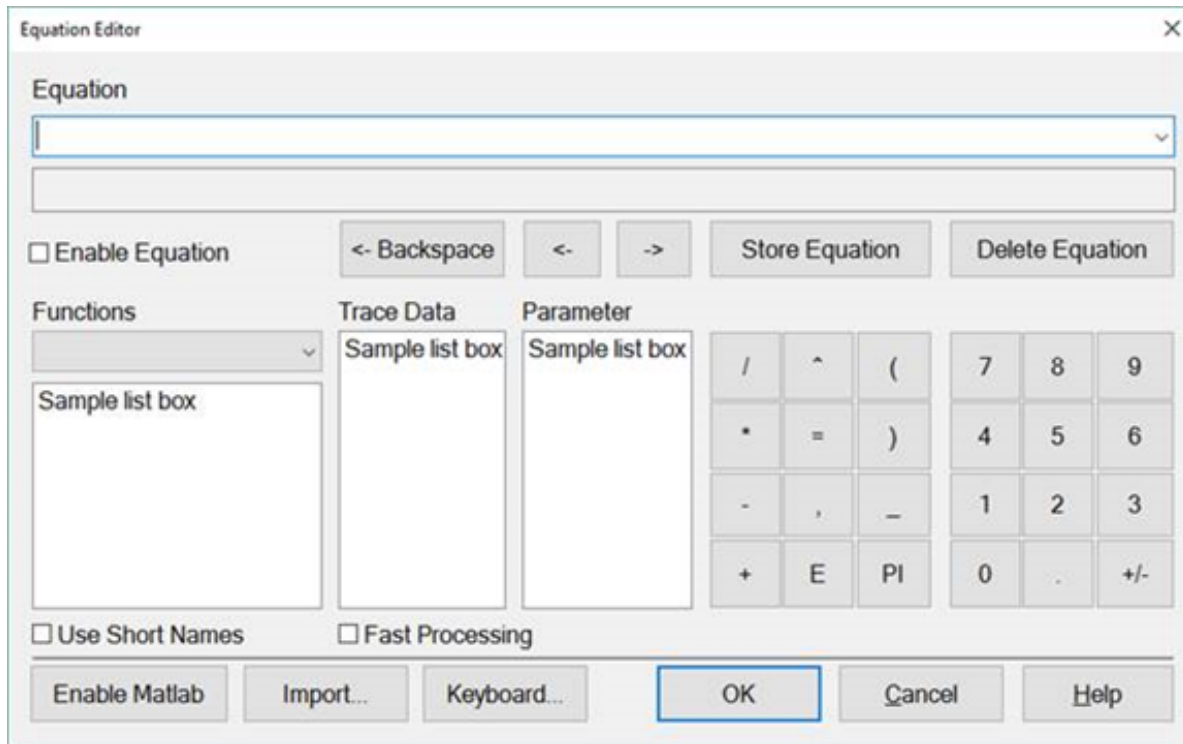

Notes

- **Double-click**, or type, the Functions, Operators, and Data to build an Equation.
- Scroll down to learn more about [Using Equation Editor](#)

Equation: The field in which equations are built. Click the down arrow to the right to use or modify equations that have been previously saved. This is where equations are saved when you press 'Store Equation'.

Enabled Check this box to enable the equation that is currently in the Equation field. If the Enabled box is not available, then the equation is not valid. If a data trace is used that is from a different channel than the Equation trace, the channels **MUST** have the same number of data points to be valid.

<-Backspace Moves the cursor to the left while erasing characters.

<- Moves the cursor to the left without erasing characters.

-> Moves the cursor to the right without erasing characters.

Store Equation Press to save the current equation. To later recall the equation, click the down arrow to the right of the equation.

Delete Equation Removes the current equation from the drop-down list.

Functions/Constants: See [descriptions of Functions](#).

Select the "library" of functions to view. The "built-in" library appears by default which includes the standard functions of equation editor. Other functions that can appear here are functions that you have written and imported. [Learn more](#).

Operators: See [descriptions of Operators](#).

Trace Data: Select from ALL of the currently **displayed** traces on ALL channels.

Parameter: Select from **undisplayed** data that is available ONLY from the active channel (same channel as the equation trace). See [Data that is used in Equations](#).

Note: With an external test set enabled, only parameters involving ports 1 through 4 are listed. However, all available parameters can be typed directly into the **Equation** field.

Use Short Names Some functions have shortened names that are entered automatically when checked. Both long and short names can be used interchangeably.

Fast Processing When checked, updates from trace references or marker references will occur once per sweep. The underlying trace will still update normally. Also, if there are no trace references or marker references in the equation, then there is no change in behavior.

A trace reference is when the equation uses another trace (for example, "eq = tr1 + tr2"). A marker reference is when the built-in marker functions mrkx() or mrky() are used.

Enable Matlab Available when a full MATLAB version is installed by you on the analyzer. [Learn more](#).

Import... Click to launch the [Import Functions](#) Dialog box.

Keyboard...: Provided to allow navigation of the entire dialog with a mouse.

Using Equation Editor

1. Pick a trace in which to enter the equation

- Equation Editor works on the active trace.
- Either create a new trace, or click the [Trace Status](#) button on an existing trace to make the trace active.

2. Enter an equation

Start Equation Editor [See how](#).

- The equation text can be in the form of an expression $(S21)/(1-S11)$ or an equation $(DIR = S12 * S23 / S13)$. This topic refers to both types as equations.
- Either type, or double-click the Functions, Operators, and Data to build an equation.
- Functions and Constants ARE case-sensitive; Data names are NOT case sensitive.
- [Learn more about referring to data traces](#).

3. Check for a valid equation

When a valid equation is entered, the Enabled checkbox becomes available for checking. When the Enabled box is checked:

- The Equation Trace becomes computed data.
- The equation is visible on the [Trace Status](#) (up to about 10 characters).
- The equation is visible in the trace [Title](#) area (up to about 45 characters) when the Equation trace is active.
- The equation is visible in the [Status Bar](#) at the bottom of the display. This is updated only after the equation is entered and the [Trace Status](#) button is clicked.
- If an equation is NOT valid, and a trace from a different channel is used, make sure the number of data points is the same for both channels.

Learn more about the [Functions](#), [Operators](#), and [Data](#) that are used in Equation Editor.

Data that is used in Equation Editor

Definitions

- **Equation trace** A trace in which an equation resides.
- **Referred trace** A trace that is used as data in an equation.

Example: $eq=Tr2+S11$ is entered into **Tr1**.

Tr1 becomes an equation trace.

Tr2 and **S11** are both referred traces because they are used in the equation trace.

Notes

- Referred traces are processed one data point at a time. For example, the expression S11/S21 means that for each data point in S11 and S21, divide point N of S11 by point N of S21.
- Once an equation is enabled, the trace is no longer identified by its original measurement parameter. It becomes an equation trace.
- An equation trace can NOT refer to itself. For example, an equation in Tr1 cannot refer to trace Tr1.
- Referred traces can be selected from S-Parameters, Receiver data, and **Memory traces**.
- **See note regarding External Test Sets.**
- See **Using Noise Power Traces in Equation Editor**

There are three ways to refer to traces:

The following distinction is important when discussing the three ways to refer to traces/data.

- **Trace** - a sequential collection of data points that are displayed on the screen.
- **Data** - analyzer measurements that are acquired but not displayed. When an equation trace refers to data that is not displayed, the analyzer will automatically acquire the data.

1. Using **TrX** Trace notation (for example, Tr2).

When a trace is created, check "**Show Tr Annotation**" to see the **Tr** number of that trace.

- **Simple** - ALWAYS refers to displayed traces.
- Must be used for referring to traces in a different channel as the equation trace.
- All **trace settings** are preserved in the equation trace. If you do NOT want a trace setting to be used in the equation trace, you must disable it in the referred trace.
- If the referred trace is error corrected, then that data is corrected in the equation trace.
- Used to refer to a memory trace (it must already be stored in memory). Append .MEM to the **TrX** trace identifier. For example, **Tr2.mem** refers to the memory trace that is stored for Tr2.

2. Using **S-parameter** notation (for example, S11/S21)

- **Convenient** - ALWAYS refers to data that is NOT displayed.
- Refers to data that resides in the same channel as the equation.

- NOT the same as referring to a displayed S11 trace using **TrX** notation. [See Example](#).
 - The referred data includes NO **trace settings**.
 - If correction is applied to the channel, equation editor traces in that channel will attempt to use corrected parameter data regardless if correction is on/off for the measurement. If there is no corrected data available, then raw data will be used. TrX notation always ignores the correction state.

3. Using **Receiver** notation (for example AB_2); NOT case sensitive.

At least one receiver is required, followed by an underscore and a number.

- The **letters** before the underscore refer to the receivers.
 - Letters alone refer to physical receivers.
 - Letters immediately followed by numbers refer to logical receivers. [Learn more](#).
 - If two receivers are referenced, they are ratioed.
- The **number** after the underscore refers to the source port for the measurement.

Examples

- AR1_2 = physical receiver A / physical receiver R1 with 2 as the source port.
- a3b4_1 = reference receiver for port 3 / test port receiver for port 4 with 1 as the source port.

[Learn more about ratioed and unratioed receiver measurements.](#)

Receiver notation is like S-parameter notation in that:

- Refers to data that is NOT displayed and resides in the same channel as the equation.
- The referred data includes NO trace settings.
- If correction is applied to the channel, equation editor traces in that channel will attempt to use corrected parameter data regardless if correction is on/off for the measurement. If there is no corrected data available, then raw data will be used. TrX notation always ignores the correction state.

Referring to Traces in a different channel

When the equation trace refers to a trace on a different channel:

- The trace must already be displayed.

- Must refer to the trace using **TrX** notation.
- The Equation trace and the referred trace **MUST** have the same number of data points or the Enable checkbox will not be available.
- The Equation trace is updated when the last referred data in the same channel is acquired. Therefore, to prevent 'stale' data from being used, the Equation trace must be on a higher numbered channel than the referred trace. This is because the analyzer acquires data in ascending channel number order - first channel 1, then channel 2, and so forth. If the Equation trace is on channel 1, and it refers to a trace on channel 2, the Equation trace will update after channel 1 is finished sweeping, using 'old' data for the channel 2 trace.

Port Extensions and Equation Editor

When using port extension with an equation, turn Fixturing ON to ensure that the underlying parameters have port extension properly applied. Learn more.

Trace Settings, Error Correction, and an Example

This discussion highlights the differences between using **S-parameter / Receiver** notation and **TrX** notation when referring to traces. The key to understanding the differences is realizing that **S-parameter / Receiver** notation **ALWAYS** refers to data that is **NOT** displayed.

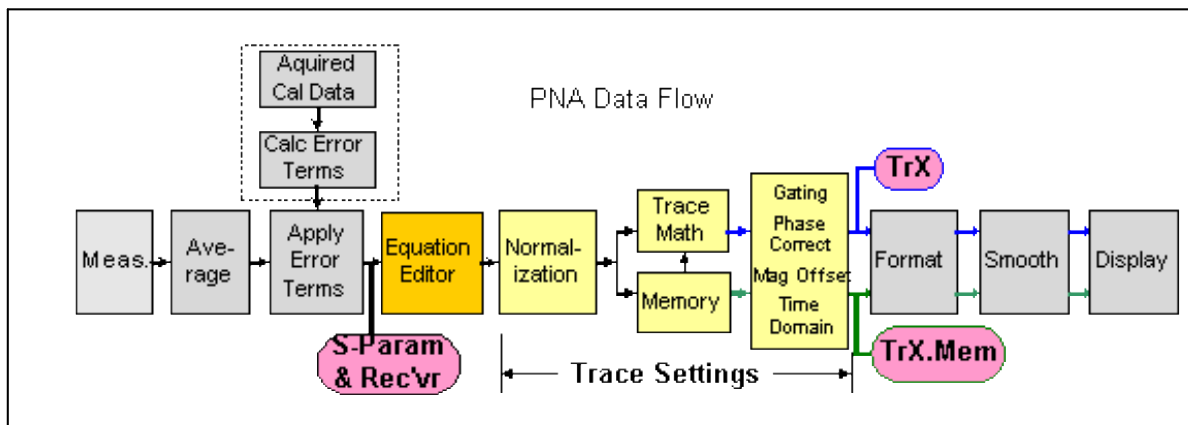

- **Trace Settings** Normalization, Trace Math, Gating, Phase and Mag Offset, Electrical Delay, Time Domain.
- **Equation Editor** processing occurs on the **equation trace** immediately after error correction.
- **Referred Data/Trace** (used in the equation) is taken from the following locations:
 - When using **TrX** notation, data is taken immediately before formatting . These traces are always displayed and include **Trace Settings**.
 - When using **S-parameter / Receiver** notation, data is taken immediately after error correction. This data is **NOT** displayed and includes **NO** trace settings (see example).

Error-correction and Equation Editor

Using **TrX** notation:

- The Trace Settings and Error-correction on the referred trace are used in the Equation trace.
- If error correction is NOT ON, then the raw, uncorrected data is used in the equation trace.
- To see if error correction is ON, make the trace active, then see the **Correction level in the status bar**.
- Turning error correction ON/OFF on the equation trace has no meaning. The referred data that is used in the equation is ALWAYS what determines its level of correction.

Using **S-parameter** and **Receiver** notation:

- Because the data is not displayed, NO trace settings are used in the Equation trace.
- If correction is applied to the channel, equation editor traces in that channel will attempt to use corrected parameter data regardless if correction is on/off for the measurement. If there is no corrected data available, then raw data will be used. TrX notation always ignores the correction state.
- When using S-parameter and Receiver notation to refer to a trace on a channel that has been calibrated with a **Response Cal** or Receiver Cal, correction can NOT be turned ON, even though the Status Bar indicates otherwise. For example: Tr1 is an S11 measurement with a Response Cal. Tr2 is an equation trace that refers to S11. The Tr2 equation trace is NOT corrected, even though the Status Bar may indicate that it is corrected. However, if Tr2 refers to Tr1 (not S11), the Tr2 equation trace is corrected.

Example

This example illustrates the differences when referring to a trace using **S-parameter** notation and **TrX** notation:

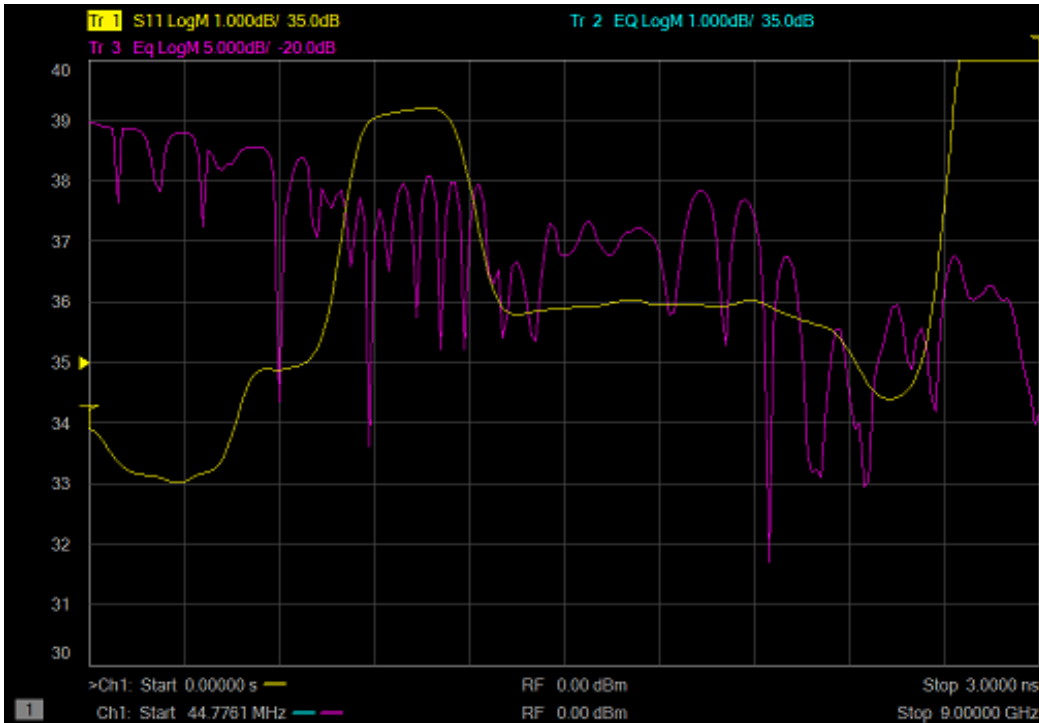

- **Tr1** is an S11 measurement with no equation, 2-port correction ON, and Time Domain transform ON.
- **Tr2** is an equation trace that refers to **Tr1**. Tr2 is corrected because Tr1 is corrected. Tr2 is transformed because Tr1 is transformed. If transform is turned ON for Tr2, the data will be transformed AGAIN, which results in "unusual" data.
- **Tr3** is an equation trace that refers to **S11**. This is NOT the same as referring to Tr1. The S11 trace that is referred to is a different instance of S11 that is NOT displayed, and has NO trace settings. Notice that Tr3 data is NOT transformed, although Tr1 is transformed. Correction for **Tr3** can be turned ON and OFF because a calibration was performed on the channel in which the S11 trace resides.
- **Note:** X- axis annotation of the Equation trace is completely independent of the data that is presented. ONLY the **data values** from a referred trace are used. For example, notice that the Equation trace **Tr2** has Frequency on the X-axis although the referred trace **Tr1** is presented in Time.

Functions and Constants used in Equation Editor

ALL trace data that is used in Equation Editor is unformatted, complex data.

When using a mouse with the analyzer, hover over a function in the dialog to learn how it is used.

In the following table,

- Function(scalar x) means that an automatic conversion from a complex number to its scalar magnitude is performed before passing the value to the function.
- Function(complex x) means that the entire complex value is used.
- **a, b, c, d** are arguments that are used in the function.

Function/Constant	Description
acos(scalar a)	returns the arc cosine of a in radians
asin(scalar a)	returns the arc sine of a in radians
atan(scalar a)	returns the arc tangent of a in radians
atan2	returns the phase of complex a = (re,im) in radians has the following two argument sets: <ul style="list-style-type: none"> • atan2(complex a) - returns the phase in radians • atan2(scalar a, scalar b)
conj(complex a)	takes a and returns the complex conjugate
cos(complex a)	takes a in radians and returns the cosine
cpx(scalar a, scalar b)	returns a complex value (a+ib) from two scalar values
e	returns the constant $\approx 2.71828\dots$
exp(complex a)	returns the exponential of a
getNumPoints()	returns the number of points for the current sweep
im(complex a)	returns the imag part of a as the scalar part of the result (zeroes the imag part)
kfac(complex a, complex b, complex c, complex d)	k-factor: $k = (1 - a ^2 - d ^2 + a*d-b*c ^2) / (2 * b*c)$
when entered in EE: kfac(S11,S21,S12,S22)	returns a scalar result - the imaginary part of the complex result is always 0
ln(complex a)	returns the natural logarithm of a

log10(complex a)	returns the base 10 logarithm of a
mag(complex a)	returns $\sqrt{a.re*a.re+a.im*a.im}$
max(complex a, complex b, ...)	returns the complex value that has the largest magnitude of a list of values.
max_hold(complex a)	holds the current maximums of the sweep. Disable the equation to reset. See example
median(complex a, complex b,...)	returns the median of a list of complex values <ul style="list-style-type: none"> • The median is determined by sorting the values by magnitude, and returning the middle one. • If an even number of values is passed, then the smaller of the two middle values is returned.
min(complex a, complex b, ...)	returns the complex value that has the smallest magnitude of a list of values.
min_hold(complex a)	holds the current minimums of the sweep. Disable the equation to reset. See example
mrkx(a,b)	returns the x-axis value of marker number b on trace number a .
mrky(a,b)	returns the y-axis value of marker number b on trace number a .
mu1(complex a, complex b, complex c, complex d) when entered in EE: mu1(S11,S21,S12,S22)	$\mu1 = (1 - a ^2) / (d - \text{conj}(a) * (a*d-b*c) + b*c)$
mu2(complex a, complex b, complex c, complex d) when entered in EE: mu1(S11,S21,S12,S22)	$\mu2 = (1 - d ^2) / (a - \text{conj}(d) * (a*d-b*c) + b*c)$
for both mu1 and mu2 (Usually written with the Greek character μ)	<ul style="list-style-type: none"> • conj is the complex conjugate. For scalars a and b, $\text{conj}(a+ib) = (a-ib)$ • returns a scalar result - the imaginary part of the complex result is always 0
phase(complex a)	returns atan2(a) in degrees
PI	returns the numeric constant pi (3.141592), which is the ratio of the circumference of a circle to its diameter
pow(complex a,complex b)	returns a to the power b
re(complex a)	returns the scalar part of a (zeroes the imag part)
sin(complex a)	takes a in radians and returns the sine

<code>sqrt(complex a)</code>	returns the square root of a , with phase angle in the half-open interval $(-\pi/2, \pi/2]$
<code>tan(complex a)</code>	takes a in radians and returns the tangent
<code>traceDataArray(complex a)</code>	returns the entire set of points from a sweep. Function is intended to be used as an argument in an custom function to allow access for data array processing.
<code>xAxisArray()</code> or <code>xAxisArray(integer a)</code>	returns the current value of the x-axis for this channel or from a specified channel.
<code>xAxisIndex()</code>	returns the current index in the sweep.
<code>xAxisValue()</code> or <code>xAxisValue(integer a)</code>	returns the current value of the x-axis index for this channel or from a specified channel.

Operators used in Equation Editor

Operator	Description
+	Addition
-	Subtraction
*	Multiplication
/	Division
(Open parenthesis
)	Close parenthesis
,	Comma - separator for arguments (as in S11, S22)
=	Equal (optional)
E	Exponent (as in 23.45E6)

Example Equations

The following examples may help you get started with Equation Editor.

Offset each data point in Tr2 from Tr1 by 2dB

Use the function: `pow(complex a, complex b)` -- returns **a** to the power **b**.

$$20\log(a) + 2 = 20\log(x)$$

$$\log(a) + 2/20 = \log(x) \text{ // divide all by 20.}$$

$$x = 10^{(\log(a) + 2/20)} \text{ // swap sides and take 10 to the power of both sides}$$

$$x = 10^{\log(a)} * 10^{(2/20)}$$

$$x = a * 10^{(2/20)}$$

The equation is entered into Tr2 as:

```
Offset=Tr1*pow(10, 2/20)
```

To offset by 5 dB

```
Offset=Tr1*pow(10, 5/20) .
```

Balanced Match using a 2-port analyzer

```
SDD11 = (S11-S21-S12+S22) / 2
```

Conversion loss

```
B_1/pow(10, -15/20)
```

- B_1 is a receiver measurement;
- -15 is the input power in dBm

Third-order intercept point (IP3 or TOI)

```
TR1*sqrt(Tr1/Tr3)
```

- Tr1 = input signal power
- Tr3 = intermodulation power (both traces measured with single receivers)

Harmonics in dBc

```
B_1/Tr2
```

- B_1 is tuned to a harmonic frequency
- Tr2 = power at fundamental frequency, measured with B_1 receiver

PAE (Power Added Efficiency)

$P_{out} - P_{in} / P_{dc}$

Type the following equation into a new trace with an unratioed measurement, such as A11. The data format is REAL:

```
PAE = 100 * (.001*pow(mag(Tr1), 2) - (.001*pow(mag(Tr1), 2) / pow(mag(Tr2), 2))) / (Tr3*Tr4)
```

Where:

- Tr1 - a trace that measures unratiod B receiver.
- Tr2 - a corrected S21 trace (amplifier gain)
- Tr3 - a trace that measures **voltage** (A11) across a sensing resistor.
- Tr4 = an equation trace containing $I_{supp} = (Tr3 / \text{value of sensing resistor})$.

Data is displayed in Real format with units actually being watts.

1-port Insertion Loss

When it is not possible to connect both ends of a cable to the analyzer, a 1-port insertion loss measurement can be made. However, the measured loss must be divided by 2 because the result includes the loss going down **and** coming back through the cable. This assumes that the device is terminated with a short or open to reflect all of the power. The 'divide by 2' operation (for dB) is performed as follows using Equation Editor:

- Tr1 - an S11 trace in log mag format.
- Tr2 - an equation trace containing **$\text{sqrt}(Tr1)$**

Max and Min Hold

These two functions allow you to capture and display either the Maximum or Minimum values for each data point over multiple sweeps.

Maxhold (S21) - displays the maximum value for each data point until reset. Reset by disabling, then enabling the equation. This example refers to an S21 trace that is not displayed.

Saving Equation Editor Data

Equation data can be saved to the analyzer hard drive in the following formats:

- **Citifile (.cti)** - Equation data is saved and recalled. The file header indicates the "underlying" s-parameter trace type.
- **PRN** - read by Spreadsheet software. Can NOT be recalled by the analyzer.
- **CSV** - read by Spreadsheet software. Can NOT be recalled by the analyzer.
- **MDIF** - compatible with Keysight ADS (Advanced Design System). Can NOT be recalled by the analyzer.
- **Print to File** (bmp, jpg, png) - saves an image of the screen.

Equation data can NOT be saved in **.SnP file format**. When attempting to save an Equation trace in .SnP format, the "underlying" S-parameter data is saved; not Equation data.

Import Functions

Several additional functions are provided with the VNA. In addition, you can create custom functions which are compiled into a DLL. Import these functions for use in the Equation Editor.

- How to Import Functions
- Supplied User Functions
 - BestFit.dll
 - EqnErrorTerms.dll
 - Expansion.dll

See Also

[Custom Equations In PNA.pdf](#) Detailed directions. (This link requires an internet connection.)

[Create custom functions for Equation Editor Template.](#) (This link requires an internet connection.)

[Equation Editor Main topic.](#)

How to Import Functions

From the main Equation Editor dialog, click **Import Functions**



Import Functions dialog box help

Imports and removes libraries that are used with Equation Editor. A library is a *.DLL file that contains one or more functions.

Although not all functions are applicable to all channels or data sets, they will still appear in the "Function/Constants" list.

Once imported, each library is automatically loaded when the VNA application starts. If a function is not found or if an error occurs while loading, the VNA will not attempt to reload the library when starting.

Import Library tab

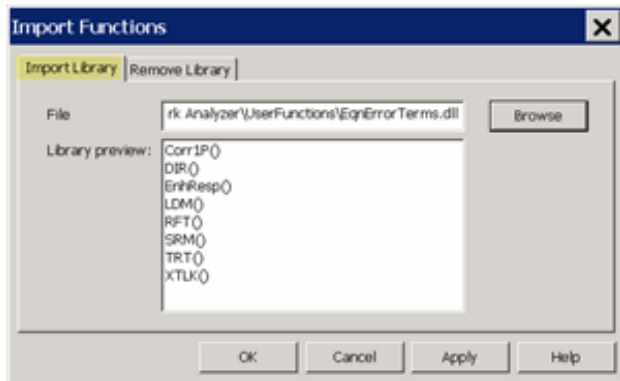

Browse Click to navigate to the .DLL file on the VNA. The recommended location for the custom equation DLLs is the “C:\Program Files (x86)\Keysight\Network Analyzer\UserFunctions” directory on the VNA.

Library Preview Lists the functions that are contained in the library.

Click **OK** or **Apply** to load the library.

Remove Library tab

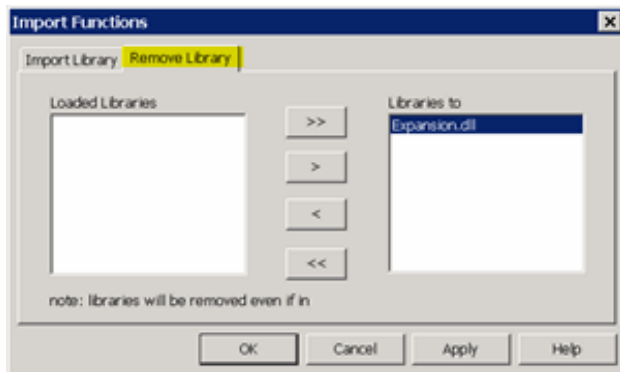

Left pane Lists the imported libraries. These also appear in the Equation Editor main dialog and remain until removed from the VNA.

Arrows Click the relevant arrows to move some (>) or all (>>) libraries from the VNA.

Right Pane Lists the libraries to remove.

Click **OK** or **Apply** to remove the library.

Supplied User Functions

The following functions are supplied with the VNA, but must be imported into Equation Editor. They are available on the VNA at: 'C:\Program Files (x86)\Keysight\Network Analyzer\UserFunctions'.

- BestFit.dll
- EqnErrorTerms.dll
- Expansion.dll

BestFit.dll

`d_best_fit_dB()` *`d_best_fit_dB(getNumPoints(),xAxisIndex(),xAxisArray(),traceDataAr`*

Draws the best fit linear regression line to data specified by PARAM. The sum-square) of the trace data in log-magnitude format. The phase of the r

`d_channelPower()` *`d_channelPower(FA,FB,CHANNELNUM,xAxisIndex(),TRACETYPE`*

Computes the channel power for the specified measurement on the given frequencies.

- FA and FB specify the frequency start/stop values in Hz.
- CHANNELNUM is the 1-based channel number to use.
- PARAM indicates the measurement to compute channel power for.
- TRACETYPE indicates how to display the computed result.
 - If TRACETYPE= 0, the display is a flat line with value equal to the channel power.
 - if TRACETYPE= 1 (default), the display is set to the trace minimum for the channel power. **See examples below .**

- If CHANNELNUM is hosting an IM Spectrum measurement, the channel power is computed as:

`channelPower = 10Log10((area under PARAM trace between`

- For all other measurement types, the formula is:

`channelPower = 10Log10((area under PARAM trace between`

TraceType Example 1 : FA=7.75 GHz, FB=8.5 GHz, CHANNELNUM=1. The channel power is displayed over the entire frequency range.

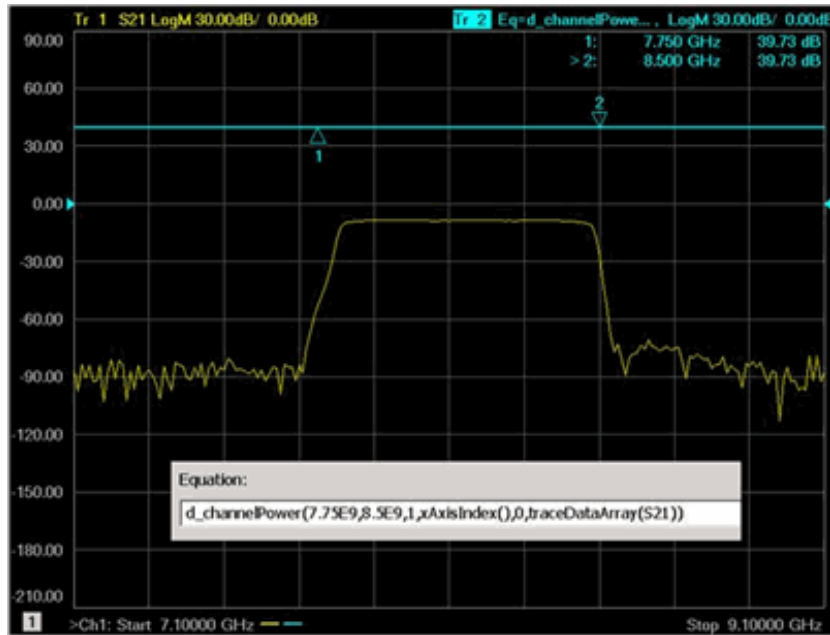

TraceType Example 2 : As above, but TRACETYPE is 1 (the default). 1 outside of specified range.

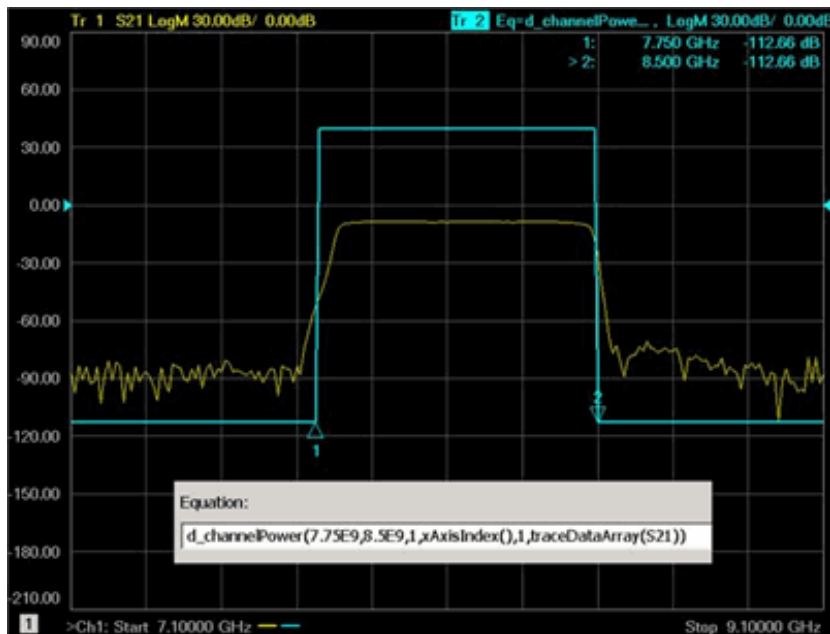

`d_DFLP()`

`d_DFLP(FreqStart, FreqStop, xAxisIndex(), getNumPoints(), xAxisAr`

Computes the deviation from linear phase data of the specified trace, PAI displayed in Phase format, the displayed data will be residual phase resp slope has been removed. The FreqStart and FreqStop arguments allow the span for this computation. To cover the channel's entire span, set the Freq number such as 1E100.

<code>d_flatness_dB()</code>	<i>d_flatness_dB(getNumPoints(),xAxisIndex(),xAxisArray(),traceDataAr</i>
	Computes the magnitude flatness of the trace data in PARAM, by first re-normalizing the results to 0 dB.
<code>d_mean()</code>	<i>d_mean(traceNum)</i>
	Computes the mean of the specified trace and creates a resulting trace wh point. The traceNum argument should be replaced by an integer number the trace for which you want to compute the mean. This function does not S11) or trace names (such as Tr1). The result of this function is the same analysis function.
<code>d_min_max_dev()</code>	<i>d_min_max_dev(getNumPoints(),xAxisIndex(),xAxisArray(),traceData</i>
	Computes the slope and intercept of the line which minimizes that maxim and the data specified by PARAM. This is done in two phases. First, the magnitude, and a minimum-deviation line is fitted to it. Second, the phase another minimum-deviation line is fitted to that. The magnitude and phase complex-valued trace. The displayed traces represent the deltas between the best-fit data. This function is typically used when you wish to measure w
<code>d_min_max_dev_d2()</code>	<i>d_min_max_dev_d2(getNumPoints(),xAxisIndex(),xAxisArray(),traceL</i>
	Computes the parameters of the parabola which minimizes that maximum data specified by PARAM. This is done in two phases. First, the trace data magnitude, and a minimum-deviation quadratic is fitted to it. Second, the another minimum-deviation quadratic is fitted to that. The magnitude and complex-valued trace. The displayed traces represent the deltas between the best-fit data. This function is typically used when you wish to measure w behavior.
<code>d_min_max_dev_range()</code>	<i>d_min_max_dev_range(FSTART,FSTOP,xAxisIndex(),getNumPoints(</i>
	Identical to the function <code>d_min_max_dev()</code> , but only operates on data in the FSTART-FSTOP.
<code>d_min_sum_dev()</code>	<i>d_min_sum_dev(getNumPoints(),xAxisIndex(),xAxisArray(),traceData</i>
	Computes the slope and intercept of the line which minimizes that sum of and the data specified by PARAM. This is done in two phases. First, the magnitude, and a minimum-deviation line is fitted to it. Second, the phase another minimum-deviation line is fitted to that. The magnitude and phase complex-valued trace. The displayed trace represents the sum of the deviation outliers than <code>d_min_max_dev()</code> .
<code>d_tilt_dB()</code>	<i>d_tilt_dB(getNumPoints(),xAxisIndex(),xAxisArray(),traceDataArray(1</i>
	when displayed in LogMag format is the total deltaY of the best fit line f

d_unwrap() *d_unwrap(getNumPoints(),xAxisIndex(),traceDataArray(PARAM))*

The result of the unwrap() function when displayed in Real format is the trace or Parameter in degrees.

EqnErrorTerms.dll

d_Corr1P() *d_Corr1P(chan, xAxisIndex(),rcvr, src, RAWDATA)*

Computes and displays 1 port corrected data for the trace data supplied in the RAWDATA placeholder.

chan - the channel of interest.

xAxisIndex() - the bucket (data point) number.

rcvr - the port number of the receiver used to acquire the data.

src - the port being driven. The rcvr and src arguments are needed to select the appropriate error terms used in the correction process.

RAWDATA - Select the data to be corrected by substituting in a trace number or parameter name.

d_DIR() *d_DIR(chanNum, xAxisIndex(), rcvr, src)*

Displays the directivity term from the cal set used by the channel <chanNum>.

Set chanNum to the desired channel.

Set rcvr and src to the port number for the desired directivity term.

d_EnhResp() *d_EnhResp(chan,xAxisIndex(),rcvr, src,RAWMATCH,RAWGAIN)*

Computes the corrected gain using enhanced response correction techniques.

This technique is useful in cases where you want to ignore the output match of a device or the output match cannot be accurately measured. In this the raw input match and gain are supplied to equation (via RAWMATCH and RAWGAIN placeholders). To use this equation select a trace (TR n) or parameter to use in place of the raw match and gain terms.

chan - the channel number

xAxisIndex() - the bucket number (do not modify)

rcv - The port where the data is acquired.

Sr - The port being driven. The src and rcvr ports are required so that the appropriate error terms are used to calculate the result.

d_LDM() *d_LDM(chanNum, xAxisIndex(), rcvr, src)*

Displays the loadmatch term from the calset used by the channel <chanNum>.

Set chanNum to the desired channel.

Set rcvr to the load port, and src to the source port for the desired load match term.

LDM(ch, xAxisIndex(), 2,1) gives you the match presented by port 2 while driving port 1.

d_RFT() *d_RFT(chanNum, xAxisIndex(), rcvr, src)*

Displays the reflection tracking term from the calset used by the channel <chanNum>.

Set chanNum to the desired channel.

Set rcvr and src to the port number for the desired reflection tracking term.

d_SRM() *d_SRM(chanNum, xAxisIndex(), rcvr, src)*

Displays the sourcematch term from the calset used by the channel <chanNum>.

Set chanNum to the desired channel.

Set rcvr and src to the port number for the desired source match term.

d_TRT() *d_TRT(chanNum, xAxisIndex(), rcvr, src)*

Displays the transmission tracking term from the calset used by the channel <chanNum>.

Set chanNum to the desired channel.

Set rcvr to the receive port and src to the source port such that TRT(ch, xAxisIndex(), 2, 1) gives you the transmission tracking term for the port 2 input receiver driven by port 1, or in other words, the raw S21 tracking term.

d_XTLK() *d_XTLK(chanNum, xAxisIndex(), rcvr, src)*

Displays the isolation term from the calset used by the channel <chanNum>.

Set chanNum to the desired channel.

Set rcvr to the receive port and src to the source port such that XTLK(ch, xAxisIndex(), 2, 1) gives you the isolation term for the port 2 input receiver while port 1 is on.

Expansion.dll

admittance(x) Admittance(x) = 1/x

Calculate the admittance

max_hold(x) **(KEY, getNumPoints(), xAxisIndex(), PARAM)**

Shows maximum value of each point

min_hold(x) **(KEY, getNumPoints(), xAxisIndex(), PARAM)**

Shows minimum value of each point.

PAE(B,S21,AI1,AI2,R,SCALE) **.001 * (B - (B/S21)) / (SCALE^2*AI1(AI1 - AI2)/R)**

Power Added Efficiency.

- B - power out
- S21 - corrected amplifier gain
- AI1 - DC power supply
- AI2 - DC power amp
- R - resistance
- SCALE - scale

reset(x) x - a number.

Resets the max_hold() or min_hold() function.

To reset a given max_hold() or min_hold() function, call reset with the same key.

SDD11(S11,S21,S12,S22) **(S11 - S21 - S12 + S22)/2**

Differential mode reflection

SDC11(S11,S21,S12,S22) **(S11 - S21 + S12 - S22)/2**

C to D mode conversion reflection

SCD11(S11,S21,S12,S22) **(S11 + S21 - S12 - S22)/2**

D to C mode conversion reflection

$$\text{SCC11}(S11,S21,S12,S22) \quad (S21 + S12 + S11 + S22)/2$$

Common mode reflection

Use the following two equations to display impedance versus frequency.

Replace 'LOAD' with the value for Z0 (usually 50).

Note: You can read out impedance versus time (not using this function) by creating a marker on a Time Domain trace, then changing the marker format to R+jX. Learn how .

$$\text{zReflect}(S11,\text{LOAD}) \quad \text{LOAD} * (1 + S11) / (1 - S11)$$

$$\text{zTransfer}(S21,\text{LOAD}) \quad 2 * \text{LOAD} * (1 - S21) / S21$$

External DC Meter Data Conversion

When creating equations using values from an external DC meter, it is important to understand how these values are stored in the VNA's data buffers and the conversion that occurs when used in an equation. For example, when a voltage is read from an external DC meter, the value is displayed on the VNA as you would expect. That is, if you are reading a voltage level of 2 V from the DC meter in a trace, the VNA will display a level of 2 V. However, the value stored in the VNA data buffers is not a voltage but is a unit-less value. Voltage, Amperes, dBm, and Watts values from an external DC meter are converted so that the format matches that of the data in the VNA internal receivers. In this way, all of the formats within the VNA are the same. This information is important when performing analysis using the Equation Editor because the trace data is the converted value.

See Also

Equation Editor

Configure a DC Device

The following table shows the formats (which are selected from the Type setting on the External DC Meter Properties dialog) and corresponding equations that convert between external DC meter readings and the VNA representation when using the trace data in an equation.

Note: Z0 is the characteristic impedance (typically 50 Ohms), dcMeter is the value from the external DC meter, and pnaVal is the value stored in the VNA data buffers. All data types are REAL.

Formats	DC Meter to VNA Data Conversion	VNA to DC Meter Data Conversion
V (volts - default)	$\pm\sqrt{(\text{dcMeter} \cdot \text{dcMeter} / Z_0) \cdot 1000}$	$\pm\sqrt{(\text{pnaVal} \cdot \text{pnaVal} / 1000) \cdot Z_0}$
A (amperes)	$\pm\sqrt{(\text{dcMeter} \cdot \text{dcMeter} \cdot Z_0) \cdot 1000}$	$\pm\sqrt{(\text{pnaVal} \cdot \text{pnaVal} / Z_0) / 1000}$
dBm	$\text{pow}(10, \text{dcMeter} / 20)$	$20 \cdot \log(\text{pnaVal})$
W (watts)	$\text{sqrt}(\text{dcMeter} \cdot 1000)$	$\text{pnaVal} \cdot \text{pnaVal} / 1000$
K (kelvin)	N/A	N/A
F (degrees)	N/A	N/A
C (degrees)	N/A	N/A

External DC Meter Voltage Example

The following example shows how trace data is converted when used in an equation. In this example, a

level of 2 V is read from an external DC meter.

1. Configure the external DC meter as described in Configure a DC Device .
2. In the **External DC Meter** dialog, ensure that **Type** is set to **V** .
3. Press **Trace** > **Trace Setup** > **Add Trace** > **New Trace...** .
4. In the **New Trace** dialog, select the **Receivers** tab, check **Activate** , click on the corresponding down arrow in the **Numerator** column, select the external DC meter from the drop down list, then click **OK** .

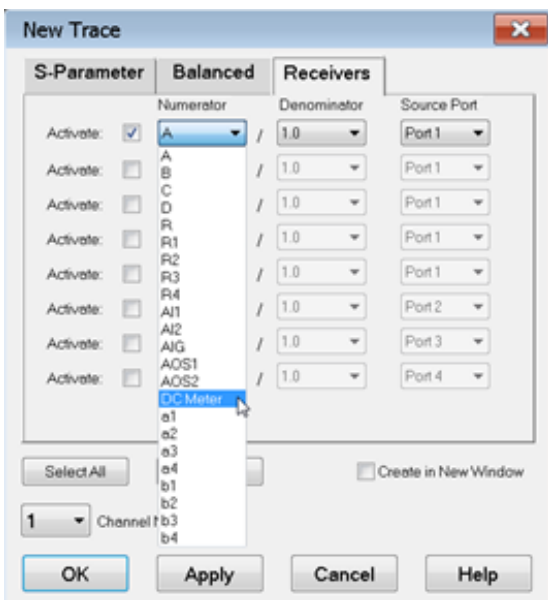

Note: If the external DC meter is not displayed in the list, ensure that **Active - Show in UI** is checked in the **External Device Configuration** dialog.

5. Trace 1 and Trace 2 should now be displayed on the VNA. Add markers to both traces. The Trace 2 marker should read 2.00 V from the external DC meter.
6. Select Trace 1, then select **Response** , **Format** , **Lin Mag** .
7. Select **Response** , **Math** , then **Equation Editor...** .
8. Enter the following Trace 1 equation to add a value of 2 to the Trace 2 data.

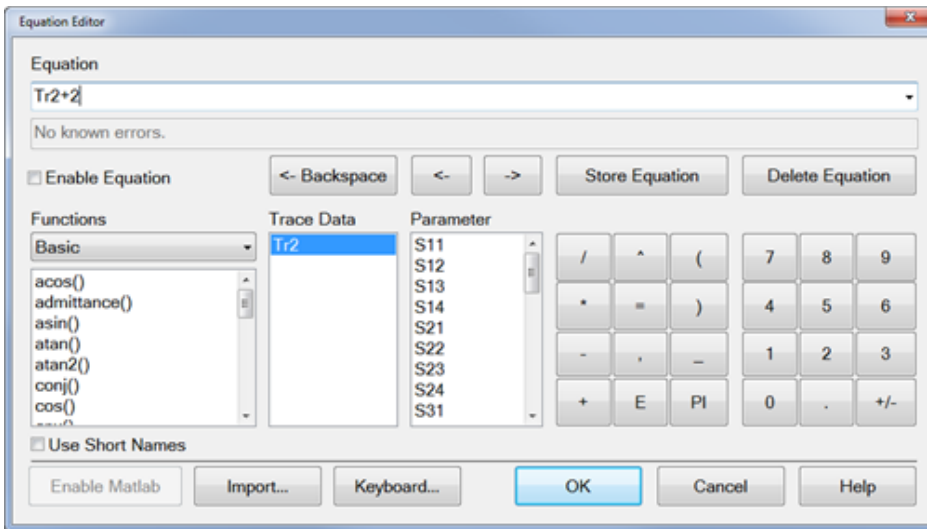

9. Check **Enable Equation**, then click **OK**.
10. Note that instead of a voltage level of 4.00 V, the Trace 1 marker reads 10.94 U (unit-less value).

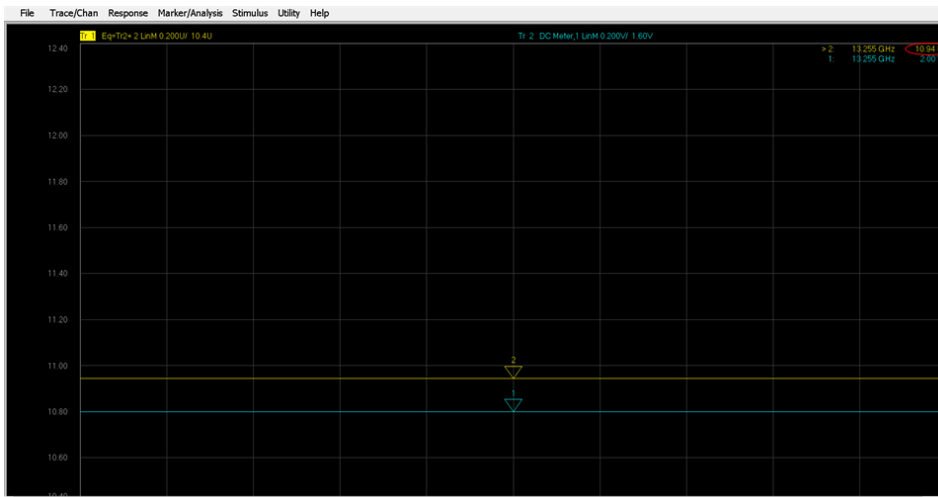

As shown in the table above, a voltage from an external DC meter is converted using $\text{sqrt}((\text{dcMeter} * \text{dcMeter} / \text{Z0}) * 1000)$. Therefore, substituting 2 for dcMeter in the equation and using 50 as Z0 results in a value of 8.94. Adding a value of 2 to the Trace 2 data, as defined in the Trace 1 equation, results in the displayed marker value of 10.94.

10. To ensure that the displayed value is 4 instead of 10.94, which is not useful, use the equation from the **VNA to DC Meter Data Conversion** column of the table above as follows:

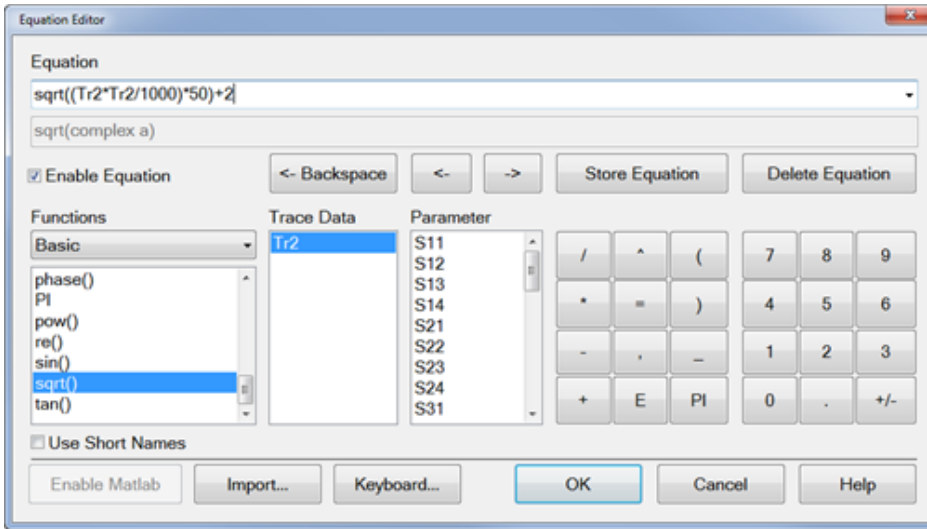

11. The Trace 1 marker now displays a value of 4.00 U.

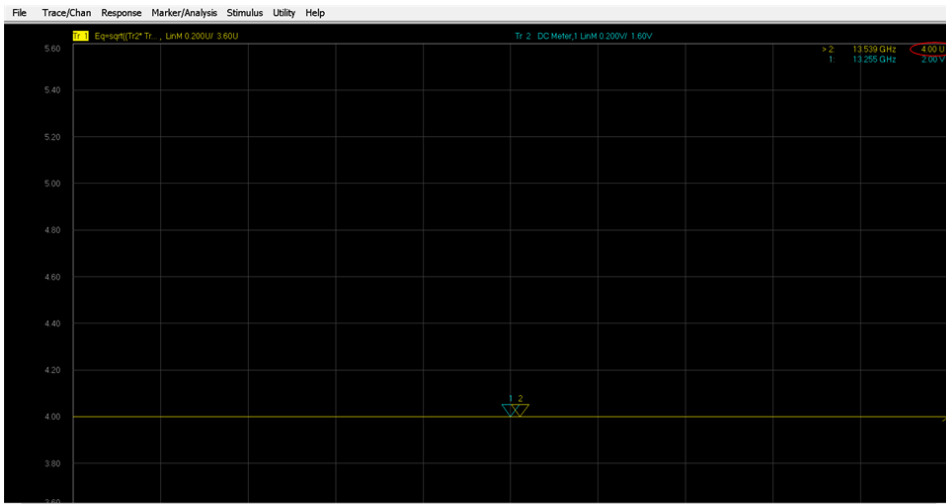

Performing Parameter Conversion of Measurement Results

- [Overview](#)
- [Selecting Conversion Target Parameter](#)

Other 'Analyze Data' topics

Overview

You can use the parameter conversion function to convert the measurement results of the S-parameter (S_{ab}) to the following parameters.

- Equivalent impedance (Z_r) and equivalent admittance (Y_r) in reflection measurement

$$Z_r = Z_{0a} \times \frac{1 + S_{aa}}{1 - S_{aa}}, Y_r = \frac{1}{Z_r}$$

- Equivalent impedance (Z_t) and equivalent admittance (Y_t) in transmission measurement

$$Z_t = \frac{2 \times \sqrt{Z_{0a} \times Z_{0b}}}{S_{ab}} - (Z_{0a} + Z_{0b}), Y_t = \frac{1}{Z_t}$$

- Inverse S-parameter ($1/S_{ab}$)

where:

Z_{0a} : Characteristic impedance of port a

Z_{0b} : Characteristic impedance of port b

- Z/Y Transmission Shunt

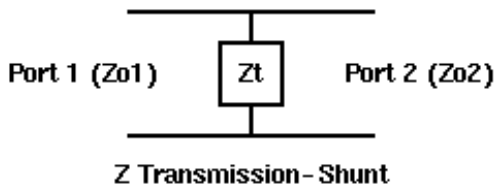

$$Z_t = \frac{1}{Y_t}$$

$$Y_t = \frac{2\sqrt{Y_{o1} \cdot Y_{o2}}}{S} - (Y_{o1} + Y_{o2})$$

$$Y_{o1} = \frac{1}{Z_{o1}} \quad Y_{o2} = \frac{1}{Z_{o2}}$$

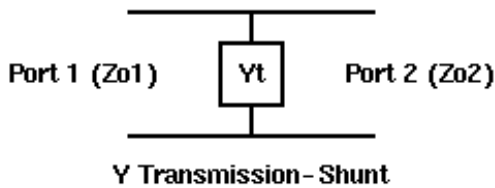

- Conjugation

Conjugation converts the measurement value to complex conjugate number.

When the fixture simulator function is ON and the port impedance function is ON, the value set in the port impedance conversion is used. In other cases, the system Z_0 (preset value: 50 Ω) is used.

Selecting Conversion Target Parameter

1. Press **Meas** > **Meas Setup** > **Conversions**
2. Select function.

Softkey	Function
Off	Off
Z-Reflection	Impedance (Z_T) in reflection measurement
Z-Transmit	Impedance (Z_t) in transmission measurement
Z-Trans-Shunt	Impedance (Z_t) Transmission Shunt
Y-Reflection	Admittance (Y_T) in reflection measurement

Y-Transmit	Admittance (Y_t) in transmission measurement
Y-Trans-Shunt	Admittance (Y_t) Transmission Shunt
1/S	Inverse S-paramete
Conjugation	Complex conjugate number

Using Limit Lines

Limit lines allow you to compare measurement data to performance constraints that you define.

- [Overview](#)
- [Create and Edit Limit Lines](#)
- [Display and Test with Limit Lines](#)
- [Limit Test Setup](#)
- [Point Limit Test](#)
- [Saving/Recalling Limit Table](#)
- [Displaying Judgement Result of Limit Test](#)
- [Testing with Sufficient Data Points](#)

Other Analyze Data topics

Overview

Limit lines are visual representations on the VNA screen of the specified limits for a measurement. You can use limit lines to do the following:

- Give the operator **visual guides** when tuning devices.
- Provide **standard criteria** for meeting device specification.
- Show the **comparison** of data versus specifications.

Limit testing compares the measured data with defined limits, and provides optional **Pass or Fail** information for each measured data point.

You can have up to **100** discrete lines for each measurement trace allowing you to test all aspects of your DUT response.

Limit lines and limit testing are NOT available with **Smith Chart** or **Polar** display format. If limit lines are ON and you change to Smith Chart or Polar format, the analyzer will automatically disable the limit lines and limit testing.

By default, limit lines are drawn in the same color as the trace on which they are created. However, all limit lines can be drawn in Red by setting a preference. [Learn more](#).

Create and Edit Limit Lines

You can create limit lines for all measurement traces. The limit lines are the same color as the measurement trace.

Limit lines are made up of discrete lines with four coordinates:

- BEGIN and END stimulus - X-axis values.
- BEGIN and END response - Y-axis values.

Limit Table

How to turn Limit Table ON/OFF

Using **Hardkey/SoftTab/Softkey**

1. Press **Math** > **Analysis**.
2. Click **Limit Table** > **Limit** to turn ON/OFF the Limit Table.

Programming Commands

	TYPE	BEGIN STIMULUS	END STIMULUS	BEGIN RESPONSE	END RESPONSE
1	MIN	1.930000 GHz	1.990000 GHz	-5.000000 dB	-5.000000 dB
2	MAX	1.000000 GHz	1.500000 GHz	-60.000000 dB	-50.000000 dB
3	MAX	2.050000 GHz	3.000000 GHz	-50.000000 dB	-60.000000 dB
4	OFF	0.000000 Hz	0.000000 Hz	0.000000 dB	0.000000 dB

Note: To ADD a limit line to the table, change the last limit line to either MAX or MIN

1. In the **Type** area of the Limit Table, select **MIN** or **MAX** for Limit Line 1.
 - The MIN value will fail measurements BELOW this limit.
 - The MAX value will fail measurements ABOVE this limit.
2. Click **BEGIN STIMULUS** for Limit Segment 1. Enter the desired value.
3. Click **END STIMULUS** for Limit Segment 1. Enter the desired value.
4. Click **BEGIN RESPONSE** for Limit Segment 1. Enter the desired value.

5. Click **END RESPONSE** for Limit Segment 1. Enter the desired value.
6. Repeat Steps 1-5 for each desired limit line.

Displaying and Testing with Limit Lines

After creating limit lines, you can then choose to **display** or **hide** them for each trace. The specified limits remain valid even if limit lines are not displayed.

Limit testing cannot be performed on memory traces.

You can choose to provide a visual and / or audible PASS / FAIL indication.

With limit testing turned ON:

- Any portion of the measurement trace that **fails** is **displayed in red**.
- Any portion of the measurement trace that does **NOT fail** remains unchanged and silent.

Display failed trace points or trace segments

You can display the data points that fail limit line testing as red dots or as a red trace segment. The default behavior (red trace) can be changed with a Preference setting. [Learn how.](#)

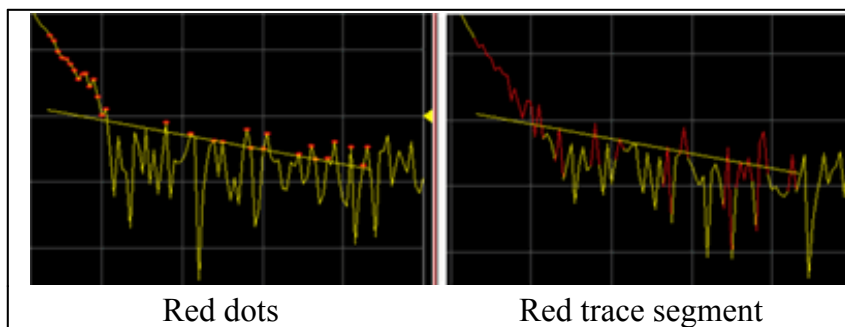

PASS is the default mode of Pass / Fail testing.

A data point will FAIL only if a measured point falls outside of the limits.

- If the limit line is set to OFF, the entire trace will PASS.
- If there is no measured data point at a limit line stimulus setting, that point will PASS.

Limit Test Setup

How to set Limit Test Setup

Using **Hardkey/SoftTab/Softkey**

1. Press **Math** > **Analysis**.
2. Click **Limits...** and then select **Limit** tab on the dialog box.

Programming Commands

Limit Test dialog box help

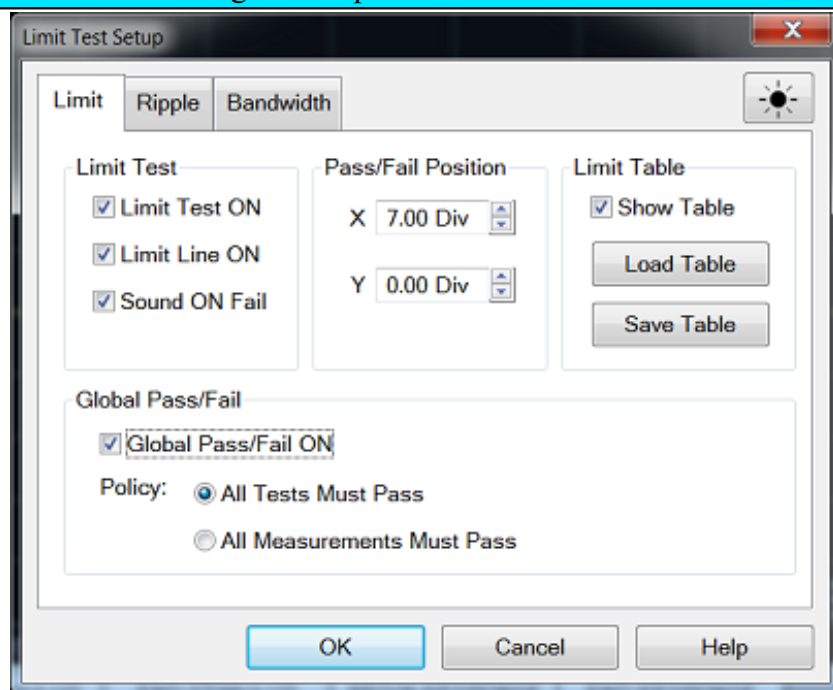

Limit Test

Limit Test ON Check the box to compare the data trace to the limits and display PASS or FAIL.

Limit Line ON Check the box to make the limits visible on the screen. (Testing still occurs if the limits are not visible.)

Sound ON Fail Check the box to make the VNA beep when a point on the data trace fails the limit test.

Pass/Fail Position

Sets the position of the Limit Line Pass/Fail status indicator on the VNA screen.

X - X-axis position. 0 is far left; 10 is far right.

Y - X-axis position. 0 is bottom; 10 is top.

Show Table Shows the table that allows you to create and edit limits.

Load Table - Recall the saved limit table. [Learn more.](#)

Save Table - Save the limit table. [Learn more.](#)

Note: To ADD a limit line to the table, change the last limit line to either MAX or MIN.

Global Pass/Fail

The Pass/Fail indicator provides an easy way to monitor the status of ALL measurements.

Global Pass/Fail ON Check to display the Global Pass/Fail status.

Policy: Choose which of the following must occur for the Global Pass/Fail status to display PASS:

- **All Tests (with Limit Test ON) Must Pass** - This setting reads the results from the Limit Tests. If all tests (with **Limit Test ON**) PASS, then the Global Pass/Fail status will PASS.
- **All Measurements Must Pass** - This more critical setting shows FAIL unless all measured data points fall within established test limits **and** Limit Test is ON. **Note:** In this mode, if one measurement does NOT have **Limit Test ON**, Global Pass/Fail will show FAIL.

Note: In this mode, if one measurement does NOT have **Limit Test ON**, Global Pass/Fail will show FAIL.

[Learn more about displaying and testing with Limits \(scroll up\)](#)

Saving/Recalling Limit Test Table

The limit test table can be saved in a file and recalled later for use on the screen. The file is saved in the csv format (with the extension *.csv), and values are saved as a character string with the unit. The csv formatted file can also be reused in spreadsheet software made for PCs.

How to turn Save or Load Limit Test Table

Using **Hardkey/SoftTab/Softkey**

1. Press **Math** > **Analysis**.
2. Click **Limits...** and then select **Limit** tab on the dialog box.
3. Click **Load Table** to recall the saved Limit Table.
4. Click **Save Table** to save the Limit Table.

No Programming are available for this feature

Load Table

1. To recall the saved limit table, click **Load Table** from the Limit Test Setup dialog and a Recall dialog box is open. At this time, CSV Files (with the extension *.csv) is selected as the file type.
2. Specify the folder that contains the file and then select the file. Click Recall to recall the saved limit table on the screen.

Note: You can recall a limit table from a trace on any channel independently of the channel and trace that were active when the limit table was saved to the file.

Save Table

1. To save the limit table, click **Save Table** from the Limit Test Setup dialog and a Save As dialog box is open. At this time, CSV Files (with the extension *.csv) is selected as the file type.
2. Specify any folder in which you want to save the file and enter the file name. Click **Save** to save the limit table displayed on the screen to a file.

The limit table is saved in the following format:

- First line indicates the type of limit test of the instrument.
- Second line indicates the revision of the limit test.
- Third line indicates a header for the segment items that are output from the fourth line onward.

- From the fourth line onward, the segment data are output.

Sample Limit table saved format:

"# E5080 Limit Test"

"# Revision: 1.00"

TYPE, BEGIN STIMULUS, END STIMULUS, BEGIN RESPONSE, END RESPONSE

MIN, 5.600000 GHz, 7.500000 GHz, -30.000000dB, -30.000000dB

MAX, 4.700000 GHz, 5.800000 GHz, -10.000000dB, -10.000000dB

MAX, 6.200000 GHz, 8.000000 GHz, -10.000000dB, -10.000000dB

OFF, 0.000000 Hz, 0.000000 Hz, 0.00dB

Displaying Judgement Result of Limit Test

Judgment result of measurement points and trace

Measurement points that fail are displayed in red on the screen. The judgment result of the trace is indicated by Pass or Fail displayed at the right bottom of screen by default and its position can be edited.

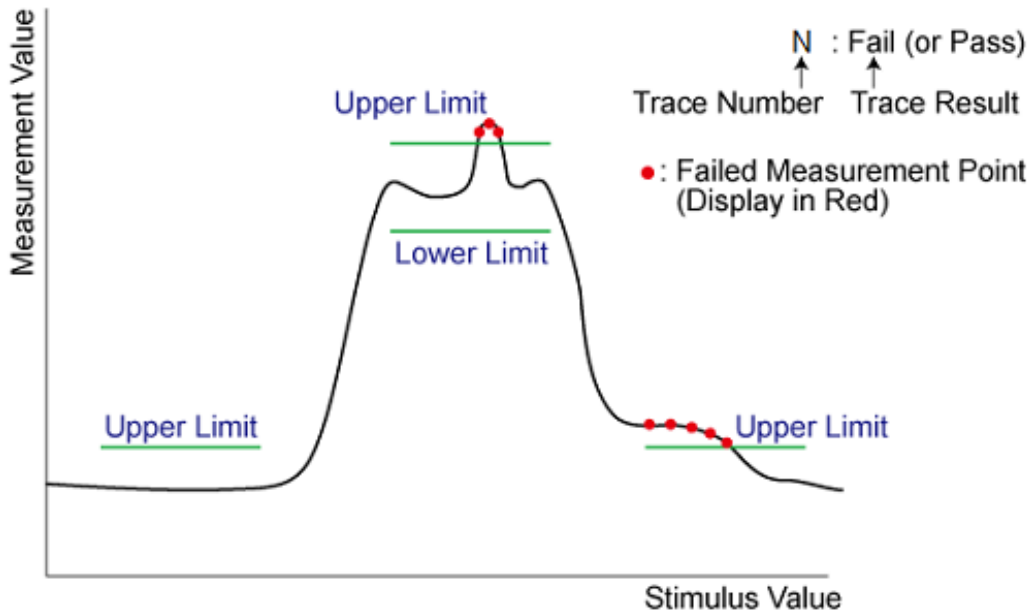

Judgment Result of Channels

If a channel has a judgment result of fail, the result is displayed at Global Pass/Fail dialog box when the

Global Pass/Fail ON is checked (ON). It will be judged as failed if one or more unsatisfactory trace exists in any of the limit test within the channel.



How to turn ON/OFF Global Pass/Fail

Using **Hardkey**/**SoftTab**/**Softkey**

1. Press **Math** > **Analysis**.
2. Click **Limits...** and then select **Limit** tab on the dialog box.
3. Checked the box to turn ON the Global Pass/Fail.
4. Clear the box to turn OFF the Global Pass/Fail.

◀ **Programming Commands** ▶

Testing with Sufficient Data Points

When **System** > **System Setup** > **Preferences**, **Limit: Test the nearest measurement point** is NOT checked, limits are checked only at the actual measured data points. Therefore, It is possible for a device to be out of specification without a limit test failure indication if the data point density is insufficient.

The following image is a data trace of an actual filter using 11 data points (approximately one every vertical graticule). The filter is being tested with a minimum limit line (any data point under the limit line fails).

Although the data trace is clearly below the limit line on both sides of the filter skirts, there is a PASS indication because there is no data point being measured at these frequencies.

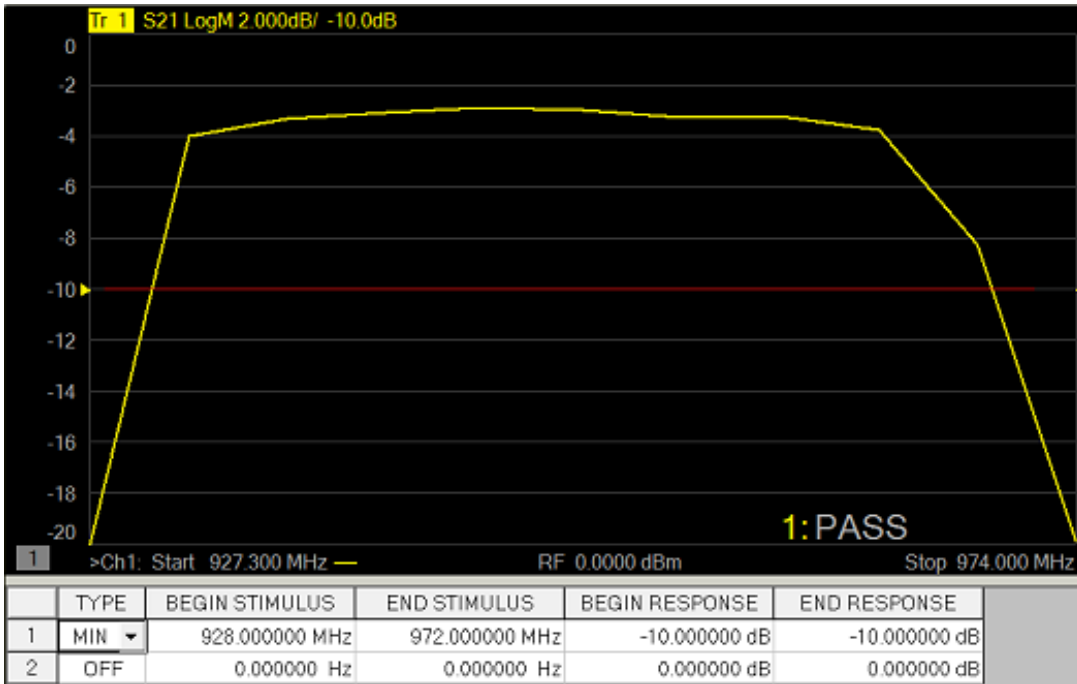

The following image shows the exact same conditions, except the number of data points is increased to 1601. The filter now fails the minimum limit test indicated by the red data trace.

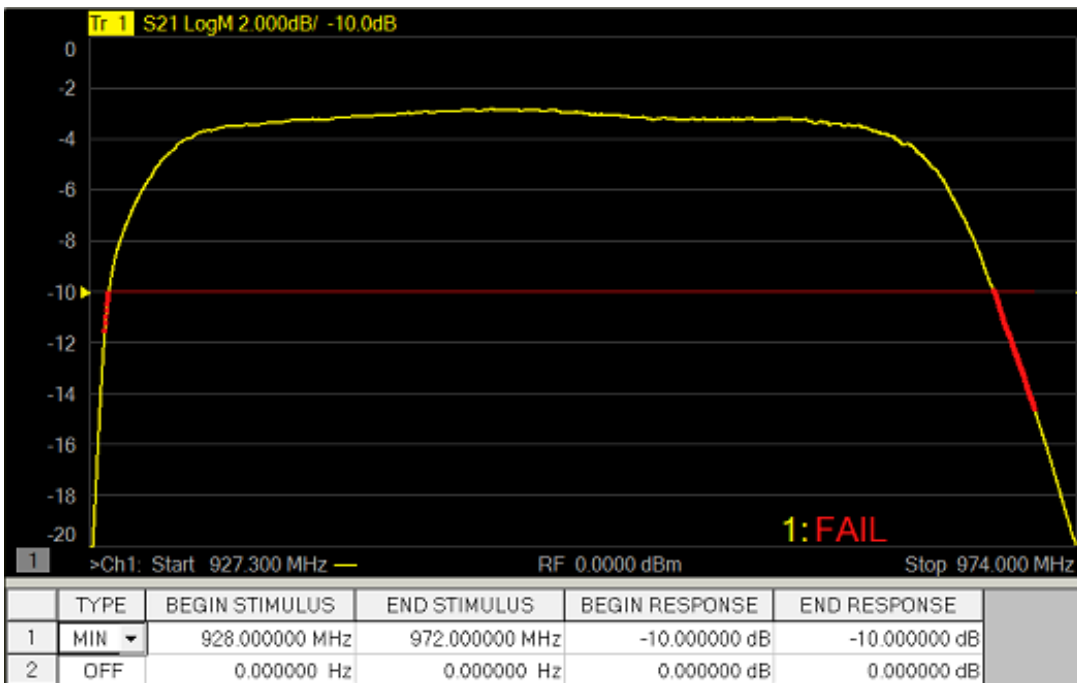

When **System** > **System Setup** > **Preferences**, **Limit: Test the nearest measurement point** is checked, the limit is compared with the nearest measurement point.

Limit Test at certain point

The limit test at a certain frequency point is available. This function is the similar with one in the E5071C. When (Begin Stimulus = End Stimulus) and (Begin Response = End Response) in the limit test table, the point is defined as point limit test and v (for max) or ^ (for min) symbol is displayed.

When you use the point limit test, confirm if **System > System Setup > Preferences, Limit: Test the nearest measurement point** is checked. In this setting, even if the test point (= Begin Stimulus = End Stimulus) is not located at measurement point, the result is determined using the nearest measurement point.

Use Ripple Limit Test

- [Overview](#)
- [Concept of Ripple Limit Test](#)
- [Create and Edit Ripple Limit Lines](#)
- [Displaying Ripple Limit Test Results](#)
- [Ripple Limit Test Setup](#)
- [Saving/Recalling Ripple Limit Table](#)

Other 'Analyze Data' topics

Overview

The ripple limit function can be executed independently of limit test function. Independently of the limit test, you can evaluate the measurement results on a PASS/FAIL basis by setting a limit for the ripple. This function is called the Ripple Limit Test.

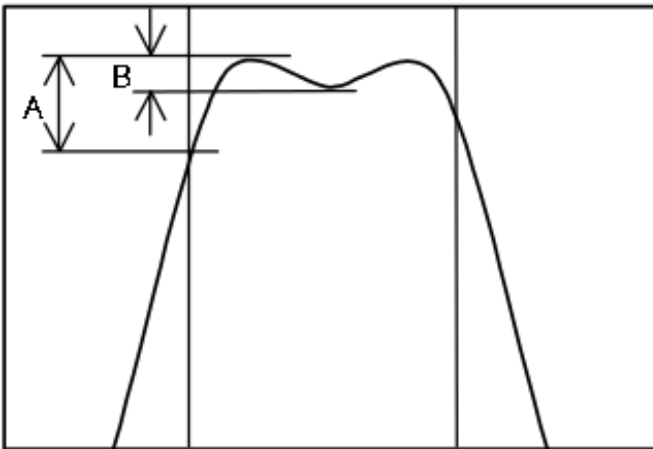

In this picture, A is greater than B. Therefore, A is considered as the ripple of the specified stimulus range.

The ripple limit function evaluates the measurement point values only. Interpolated values are not used.

Concept of Ripple Limit Test

The ripple limit test is a function for evaluating the results on a Pass/Fail basis based on the ripple

limit, which is set using the ripple limit table. Ripple is defined as the difference between the largest and smallest value within a specified stimulus range. You can specify up to 12 frequency bands, which permits a test for each frequency band.

The ripple limit test judges the measurement as "Pass" when the ripple value specified with the ripple limit is not exceeded by any of the measurement points on the trace; Otherwise, it judges the measurement as "Fail." For the measurement points in a stimulus range without a specified ripple limit, the test judges the measurement as "Pass."

Note: The measurement point alone is the target of evaluation for pass/fail. The interpolated part between measurement points is not evaluated.

The ripple limit is defined with the start point stimulus value, end point stimulus value, ripple limit value and type (on/off). For detailed information, see [Ripple Limit Table](#).

While the ripple limit test function is turned on, the measurement points corresponding to a "FAIL" judgment will be indicated in red on the screen and the trace's test results based on the results of each measurement point will be displayed (judged as "Fail" if one or more red measurement point exist on the trace). For information on how to display the results, see [Ripple Limit Setup](#). You can also confirm the channel test results on the screen (judged as "Fail" if one or more failed traces appear in the limit test, ripple limit test or bandwidth limit test within the channel).

Create and Edit Ripple Limit Lines

You can create ripple limit lines for all measurement traces. The ripple limit lines are the same color as the measurement trace.

Ripple limit lines are made up of discrete lines with three coordinates:

- Begin Stimulus and End Stimulus - X-axis values.
- Max Ripple - Y-axis values.

Ripple Limit Table

You must configure the ripple limit before you can use the ripple limit test function. You can specify a ripple limit table for each trace, where up to 12 ripple limit bands (frequency bands) can be configured.

How to turn ON/OFF Ripple Limit Table

Using **Hardkey/SoftTab/Softkey**

1. Press **Math** > **Analysis**.
2. Click **Limit Table** > **Ripple** to turn ON/OFF the Ripple Table.

Programming Commands

Note: To ADD a frequency band to the ripple limit table, change the last ripple limit line to either ON or OFF.

Note: No frequency band is provided in the ripple limit table by default.

1. In the **Type** area of the Ripple Limit Table, select **ON** or **OFF** for Ripple Limit Line 1.
 - ON - Band used for the ripple limit test.
 - OFF - Band not used for the ripple limit test.
2. Click **Begin Stimulus** for Ripple Limit Segment 1. Enter the desired value.
3. Click **End Stimulus** for Ripple Limit Segment 1. Enter the desired value.
4. Click **Max Ripple** for Ripple Limit Segment 1. Enter the desired value.
5. Repeat Steps 1-4 for each desired ripple limit line.

How to turn ON/OFF the Ripple Limit Table

Note: Acceptable range for the stimulus value: -500G to +500G. If any out ranging value is specified, it will be reset to fall within the range.

Note: Even if the VNA's sweep range is changed after the stimulus value has been set, the stimulus value is not susceptible.

Example of ripple limit configuration

- The individual frequency bands for the ripple limit test can overlap each other; in this case, the ripple limit test is performed for each frequency band.

- Even if the VNA's span value is set to zero, you must enter a parameter for both Begin Stimulus and End Stimulus.
- If the data format is Smith chart or polar, the limit test is performed for the main response value among the two marker response values.

Displaying Ripple Limit Test Results

Test result for trace

The test result for the trace will be indicated as Pass or Fail in the upper-left area of the graph. You can also display the ripple value at the selected frequency band. If a trace is unsatisfactory, test results and ripple lines are displayed by red color.

The result will be displayed as Ripln: Pass (or Fail) for each trace. n denotes the trace number. Bn will be followed by the ripple value (if the ripple display is turned off, only Bn will be displayed without the ripple value).

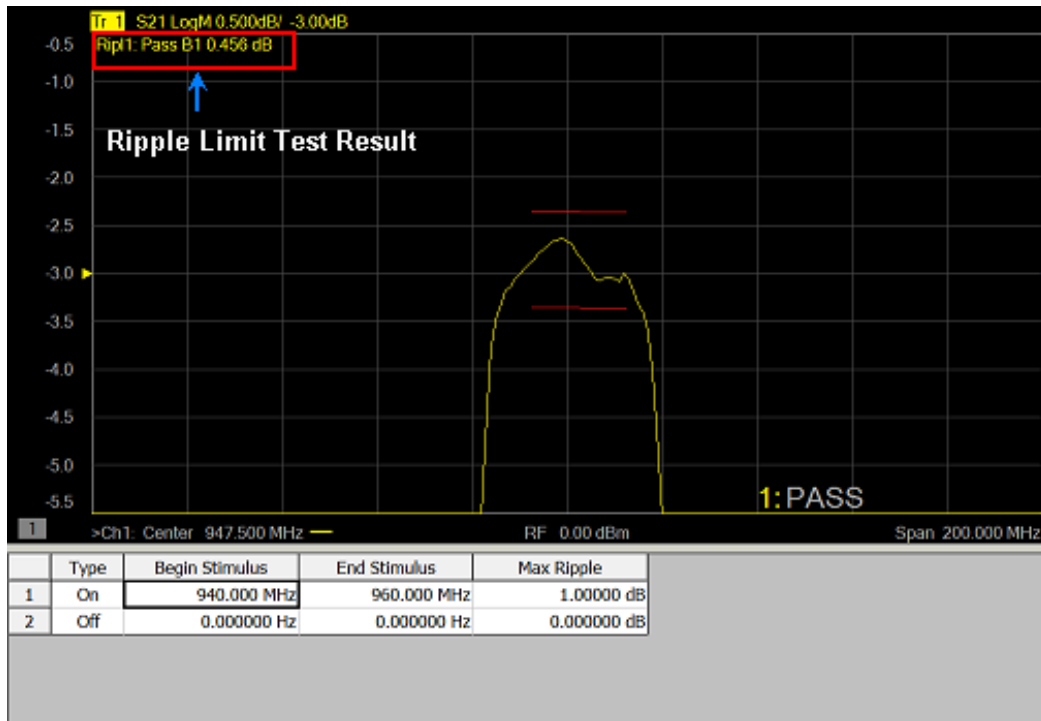

Global Pass/Fail

The Global Pass/Fail setting in the limit tab is applied to ripple limit test. It will be judged as failed if one or more unsatisfactory trace exists in any of the ripple limit test within the channel).

Ripple Limit Test Setup

How to set Ripple Limit Test Setup

Using **Hardkey/SoftTab/Softkey**

1. Press Channel or Trace to select the trace on which you want to apply the ripple limit test function.
2. Press **Math > Analysis**.
3. Click **Limits...** and then select **Ripple** tab on the dialog box.

Programming Commands

(Ripple) Limit Test Setup Dialog Box Help

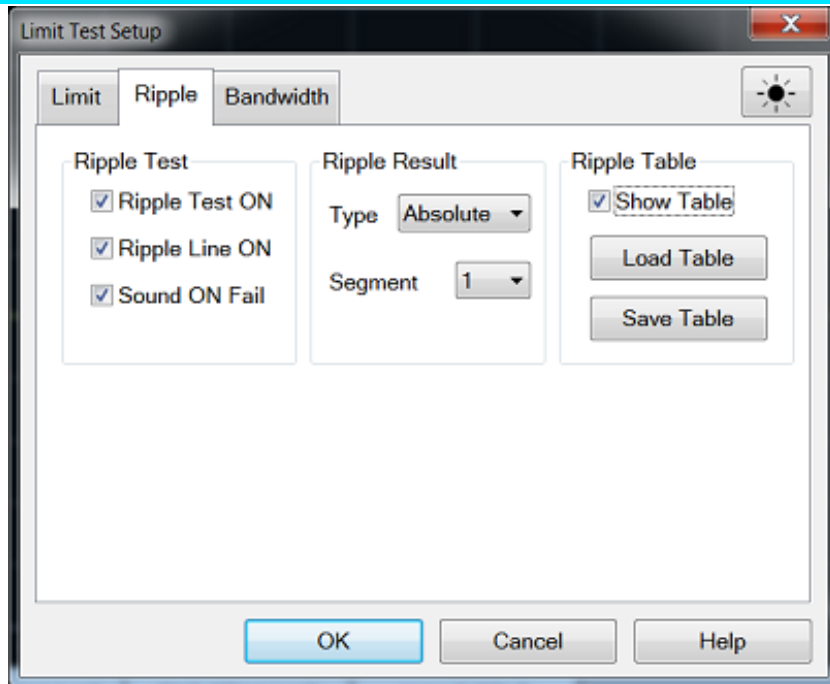

Ripple Test

Ripple Test ON - Check the box to set the ripple test ON or OFF and also display PASS or FAIL.

Ripple Line ON - Check the box to make the ripple limit line visible on the screen (Test still runs even though the ripple line does not turn on).

Ripple Result

Type - Sets how the ripple values are displayed. Available settings are **Off**, **Absolute** value (difference between maximum and minimum values within the band) display and **Margin** (difference between absolute value of ripple and ripple limit) display.

Segment - Enable to specify a ripple limit table up to 12 stimulus segment for each trace.

Ripple Table

Show Table - Check the box to show the table that allows you to create and edit limits.

Load Table - Recall the saved ripple limit table. [Learn more.](#)

Save Table - Save the ripple limit table. [Learn more.](#)

Saving/Recalling Ripple Limit Table

The ripple limit table can be saved in a file and recalled later for use on the screen. The file is saved in the csv format (with the extension *.csv), and values are saved as a character string with the unit. The csv formatted file can also be reused in spreadsheet software made for PCs.

How to set Ripple Limit Setup

Using **Hardkey/SoftTab/Softkey**

1. Press **Math > Analysis**.
2. Click **Limits...** and then select **Ripple** tab on the dialog box.
3. Click **Load Table** to recall the saved Ripple Limit Table.
4. Click **Save Table** to save the Ripple Limit Table.

No Programming are available for this feature

Load Table

1. To recall the saved ripple limit table, click **Load Table** from the Ripple Limit Test Setup dialog and a Recall dialog box is open. At this time, CSV Files (with the extension *.csv) is selected as the file type.
2. Specify the folder that contains the file and then select the file. Click Recall to recall the saved ripple limit table on the screen.

Note: You can recall a ripple limit table from a trace on any channel independently of the channel and trace that were active when the ripple limit table was saved to the file.

Save Table

1. To save the ripple limit table, click **Save Table** from the Ripple Limit Test Setup dialog and a Save As dialog box is open. At this time, CSV Files (with the extension *.csv) is selected as the file type.
2. Specify any folder in which you want to save the file and enter the file name. Click **Save** to save the ripple limit table displayed on the screen to a file.

The ripple limit table is saved in the following format:

- First line indicates the type of limit test of the instrument.
- Second line indicates the revision of the limit test.
- Third line indicates a header for the segment items that are output from the fourth line onward.
- From the fourth line onward, the segment data are output.

Sample Ripple Limit table saved format:

```
"# E5080 Ripple Limit Test"
```

```
"# Revision: 1.00"
```

```
TYPE, BEGIN STIMULUS, END STIMULUS, MAX RIPPLE
```

```
ON, 933.0000000 MHz, 964.0000000 MHz, 1.5 dB
```

```
ON, 938.0000000 MHz, 953.0000000 MHz, 500 mdB
```

Use Bandwidth Limit Test

- [Overview](#)
- [Displaying Bandwidth Limit Test Results](#)
- [Bandwidth Limit Test Setup](#)

Other 'Analyze Data' topics

Overview

The bandwidth limit test function can be used for testing bandwidth for the band-pass filters.

The bandwidth test find the peak of a signal in the passband and locates a point on each side of the passband at an amplitude below the peak specified in test setup. The frequency between these two points is the bandwidth of the filter. Then, the obtained bandwidth is compared to minimum and maximum allowable bandwidth that you specify beforehand.

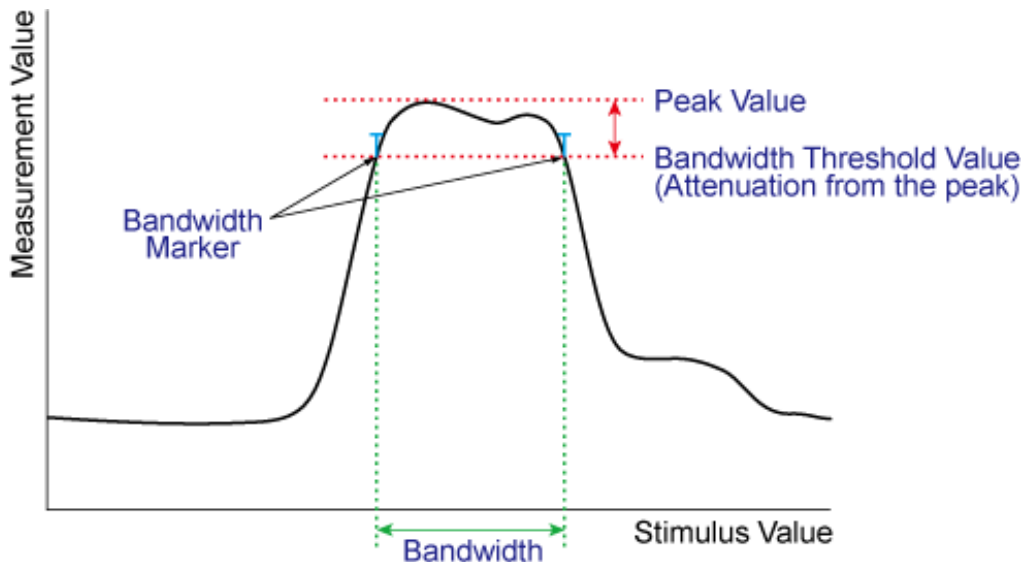

Displaying Bandwidth Limit Test Results

Test Result for Trace

The test result for the trace will be indicated as Pass, Wide or Narrow in the upper-left area of the graph by following BWn. "n" denotes the trace number. You can also display the bandwidth value. If a trace is unsatisfactory, test results and bandwidth markers are displayed by red color.



Global Pass/Fail

The Global Pass/Fail setting in the limit tab is applied to bandwidth limit test. It will be judged as failed if one or more unsatisfactory trace exists in any of the bandwidth test within the channel.

Bandwidth Limit Test Setup

You must set up the bandwidth threshold and the upper and lower limits before you can use the bandwidth limit test function. You can specify the threshold, upper limit and lower limit for each trace.

How to set Bandwidth Limit Setup

Using **Hardkey/SoftTab/Softkey**

1. Press Channel or Trace to select the trace on which you want to apply the bandwidth limit test function.
2. Press **Math > Analysis**.
3. Click **Limits...** and then select **Bandwidth** tab on the dialog box.

Programming Commands

Bandwidth Test Setup Dialog Box Help

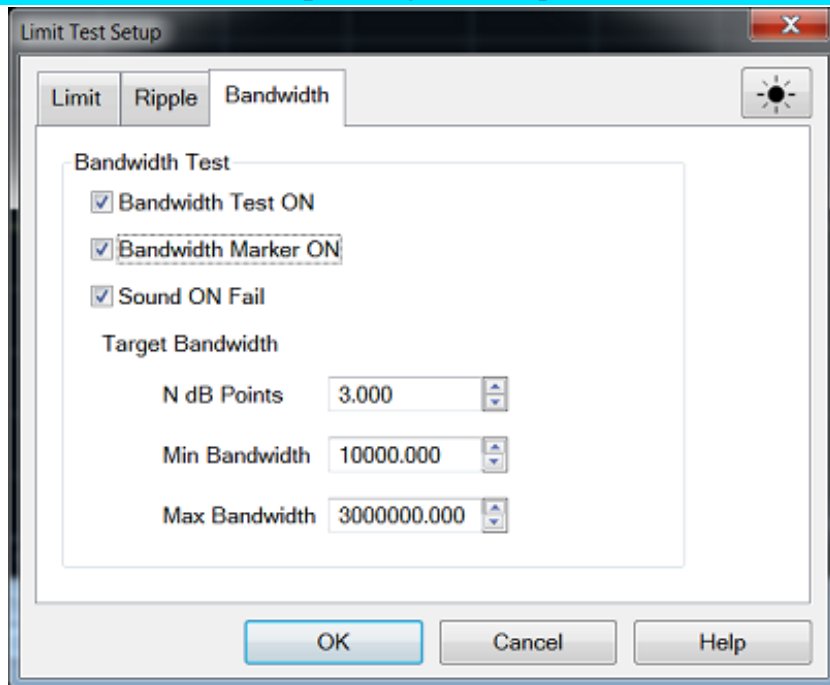

Bandwidth Test

Bandwidth Test ON - Check the box to set the bandwidth limit test ON or OFF.

Bandwidth Marker ON - Check the box to make the bandwidth marker visible on the screen (Test still runs even though the bandwidth marker does not turn on).

Sound ON Fail - Check the box to turn ON when the bandwidth limit test is FAIL.

Target Bandwidth

N dB Points - Specify the bandwidth threshold in dB unit.

Min Bandwidth - Enter the lower limit for the bandwidth in Hz unit.

Max Bandwidth - Enter the upper limit for the bandwidth in Hz unit.

Note: If the data format is Smith chart or polar, the test is skipped.

Save and Recall a File

You can save and recall files to and from an internal or external storage device in a variety of file formats.

- [How to Save Instrument State](#)
- [How to Save Measurement Data](#)
- [How to Recall a File](#)
- [About Instrument State and Calibration Data](#) (.csa, .cst, .sta, .cal)
- [About Measurement Data Files](#) (.prn, .snp, .cti, .csv, .mdf)
- [Define Data Saves](#)
- [Managing Files without a Mouse](#)

Other Data Outputting topics

How to Save Instrument State and Calibration Files

Using **Hardkey/SoftTab/Softkey**

1. Press **Save Recall** > **Save State** or **Save Other**.

◀ **Programming Commands** ▶

Save State Softtab help

[Learn all about VNA Instrument State files.](#)

Save State - Immediately saves the VNA state, possibly calibration data and link to the selected filename by depends on the **Save Type**. The selected filename is automatically generate in the storage when you performed a save.

Auto Save - Saves state, calibration data and link to the storage. Saves state and calibration data to the internal storage in the D: folder. A filename is generated automatically using the syntax "atxxx"; where xxx is a number that is increment by one when a new file is Auto Saved. The filename is depends on the **Save Type** to save it in ".sta", ".csa" or ".cst".

Save State As... - Starts the **Save As** dialog box. (Not available on M948xA and E5080A.)

Save Register - Immediately saves the specified register (Register 1 to 8) to the selected filename by depends on the **Save Type**. The selected filename is automatically generate in the storage when you performed a save on selected register.

Save Type

State - Save VNA state in .sta filename.

State + Cal Data - Save VNA state and calibration data in .csa filename.

State + Cal Link - Save VNA state and calibration link in .cst filename.

Save Other Softtab help

Save Calset... & Save Screen... - Starts the **Save As** dialog box.

Save Data... - Starts the **Save Data As** dialog box.

Save User Preset... - Start the **User Preset** dialog box.

Save As dialog box help

Save Allows you to navigate to the directory where you want to save the file.

File name Displays the filename that you either typed in or clicked on in the directory contents box.

Note: Filenames (not including the path name) **MUST** be limited to 64 characters.

Save as type

The following file types save **Instrument states and Calibration data**. You can save, and later recall, instrument settings and calibration data for **all channels** currently in use on the analyzer. These file types are only recognized by Keysight VNA analyzers.

[Learn more about these file types.](#)

- ***.csa** - save Instrument state and actual Cal Set data (cal/state archive) **Default selection**.
- ***.cst** - save Instrument state and a link to the Cal Set data.
- ***.sta** - save Instrument state **ONLY** (**no** calibration data)
- ***.cal** - save actual Calibration data **ONLY** (**no** Instrument state)

Note: To save the screen as .bmp, .jpg, or .png graphics file types, click **File / Print to File**. [Learn more.](#)

Save Saves the file to the specified file name and directory.

Save VNA Measurement Data

How to Save Measurement Data

Using **Hardkey/SoftTab/Softkey**

1. Press **Save Recall** > **Save Other** > **Save Data...**

Save Data As Saves the current trace(s) to the specified type of file.

Note: This dialog now contains the settings previously selected from the old **Define Data Save** dialog.

◀ Programming Commands ▶

Save Data As dialog box help

Note: Before saving measurement data, always **trigger a single** measurement, and then allow the channel to go into Hold. This ensures that the entire measurement trace is saved.

Note: **Memory traces** can NOT be saved to any file type (PRN, SNP, CTI, CSV, MDF).

Save in Allows you to navigate to the directory where you want to save the file.

File name Displays the filename that you either typed in or clicked on in the directory contents box.

Note: Filenames (not including the path name) **MUST** be limited to 64 characters.

Save as type Choose from: (click each to learn more about each file type): ***.prn**, ***.SNP**, ***.SNPX**, ***.cti** (citifile), ***.csv**, ***.mdf**.

- FCA, GCA data can be saved to a special csv format. Learn how (**FCA**, **GCA**)
- **Trace and Noise Parameters (*.snp)** - Save the noise figure parameters and S-parameters. [Learn more.](#)
- To save the screen as .bmp, .jpg, or .png graphics file types, click **File / Print / Print to File**. [Learn more.](#)

Data Scope

Determines what traces are saved to a file. Available **ONLY** with ***.cti**, ***.csv**, and ***.mdf**.

- **Auto**
 - When correction is OFF, saves the specified trace.

- When correction is ON, saves all corrected parameters associated with the calibrated ports in the Cal Set.
- For GCA channels, saves the active trace only.
- **Single Trace** - Saves the active trace.
- **Displayed Traces** - Saves all displayed traces for all channels.
- **Channel Traces** - Saves all displayed traces for active channels.

Format

Determines the format of the data. Available with (CTI Formatted, CSV, SNP, MDIF)

- **Auto** - Data is saved in LogMag or LinMag if one of these is the currently selected display format. If format is other than these, then data is saved in Real/Imag.
- **LogMag/Angle (dB/deg), LinMag/Angle (unit/deg), Real/Imaginary** - Select output format.
- The imaginary portion for all **LogMag** and **LinMag** data is saved in degrees (dB/deg).
- **Real/Imaginary data is never smoothed.**
- **Displayed Format (CSV and MDIF only)** - Data is saved in the format of the displayed trace.

Note: .prn files can only save the active trace in the displayed format.

Save Saves the file to the specified file name and directory.

Cancel - Closes the dialog.

Help - Displays **Save Data As** dialog box help.

Recall a file

How to Recall (open) a file

Using **Hardkey/SoftTab/Softkey**

1. Press **Save Recall > Recall**.

Using a mouse

1. Click on **File**
2. Select **Recall Data...**

Programming Commands

Save Recall > Recall Softtab Help

Recall State - Recall the specified filename.

Recall State - Select from a list of files shown on softkeys. The list can be sorted by 'most recently used' or alphabetically depending on a preference. The preference setting appears at the bottom of the second page of softkeys listing files to be recalled or on the [Preference dialog](#).

Recall State... - Starts the [Recall](#) dialog box.

Recall Register - Recall the register (Register 1 to 8) which is saved in the D:\ drive (Only the saved register will enable to recall).

Recall Calset... - Starts the [Recall](#) dialog box.

Recall Data... - Starts the [Recall](#) dialog box.

Recall Order - A list of files for recall can arrange according to NAME or RECENT files.

Recall dialog box help

Look in Allows you to select the directory that contains the file that you want to recall.

Filename Displays the filename that you either typed in or clicked on in the directory contents box.

Files of type Allows you view and select files that are listed in categories of a file type. The following types of files can be recalled into the analyzer: All [State files](#), Citi files, SNP files.

Recalling instrument state files

When an Instrument State file is recalled, the current state of the instrument is overwritten with the recalled state. A *.cal file does not contain an instrument state, but only calibration data. [Learn more about Instrument States](#).

See also [Power ON and OFF during Save / Recall, User Preset, and Preset](#).

Recalling Data files

Citi files and SNP files can be recalled and viewed in the analyzer.

1. Click **File** then **Recall**.
2. Select **Citifile Data** or **Snp**.
3. Select the file to recall
4. Click **Recall**.

Note: Citi files that were saved in **CW Time sweep** can NOT be recalled into the VNA.

Note: Filenames (not including the path name) that are longer than 64 characters will NOT be recalled.

Recalled data is ALWAYS displayed using **LogMag format**, regardless of how the file was stored.

The channel is placed in Trigger Hold. If triggering is resumed, the data will be overwritten.

SNP files are recalled as traces into a single window and channel, beginning at the **highest available channel number allowed on the analyzer**. For multi-port SNP files (greater than 4 ports), if the number of S parameters in the file is beyond the **maximum number of traces in a window**, then new windows will be created.

Citi files are recalled into the same window and channel configuration as when they were saved. However, the new recalled channel numbers begin with the **highest channel number allowed on the analyzer** and decrement for each additional channel.

For example, when a citi file is saved, two traces are in window 1, channel 1 and two additional traces are in window 2, channel 2. When recalled into a factory preset condition (1 trace in window 1, channel 1), the first two recalled traces appear in window 2, highest channel number, and the second two traces appear in window 3, (highest channel number -1). See also **Traces, Channels, and Windows**.

Recall Recalls the file displayed in the file name box.

Instrument State / Calibration Files

You can save, and later recall, instrument settings and calibration data **for all channels** currently in use on the analyzer.

An **Instrument State** contains almost every analyzer setting. The following settings are NOT saved and recalled with Instrument State:

- **GPIB address**

- **RF power ON/OFF** (depends on current setting)

The following file types are used to save and recall instrument states and Cal Set information:

File Types		Information that is stored for each channel
.csa	.cst	<p>Instrument State Information</p> <p>Channels/Traces Averaging</p> <p> Windows Markers</p> <p> Triggering Math/memory</p> <p> Format Limits</p> <p> Scale More...</p> <p> Stimulus Information:</p> <p> Frequency range Alternate sweep</p> <p> Number of points Port powers</p> <p> IF bandwidth Source attenuators</p> <p> Sweep type Receiver attenuators</p> <p> Sweep mode Test Set port map</p>
		<p>Cal Set Information</p> <p>GUID (Globally Unique Identifier) provides link to Cal Set</p> <p>Name, Description, Modify date</p> <p>Stimulus Information:</p> <p> Frequency range Alternate sweep</p> <p> Number of points Port powers</p> <p> IF bandwidth Source attenuators</p> <p> Sweep type Receiver attenuators</p> <p> Sweep mode Test Set port map</p> <p>Error Terms: Directivity, Crosstalk, Source match, Load match, Reflection tracking, Transmission tracking</p>
	.sta	
		.cal

File Type Descriptions and Recall

The following describes each file type, and what occurs when the file type is recalled.

Instrument states can have the following suffixes: .sta, .cst, and .csa.

Common to all of the instrument state files is the state of the instrument including the quantity and content of channels, traces, windows, markers, limit lines, etc.

What is different about the instrument state files is the way they handle the calset - a calset is the set of

data that results from having executed a calibration on a channel.

*.sta files

- Contain ONLY instrument state information - NOT Cal data.
- When recalled, they always replace the current instrument state immediately.

This instrument state file is saved without any calset data. You might choose to use this type of save file if you are concerned about disk space or specifically do not want to store calibration data that tends to have a shelf life. That is, calibrations become less accurate as cables move and temperature changes. Perhaps you want to force a new calibration when the instrument state is used.

Compatibility of Files

- There is no compatibility among the VNA family products. For example, M937xA/P937xA cannot recall the state file which is saved by M980xA/P50xxA
- Files between M980xA and P50xxA are compatible.
- Files between M937xA and P937xA are compatible.
- The analyzers cannot recall file saved by that with the smaller number of port. For example, 2 port VNAs cannot recall the files saved by 4 port VNAs.
- When the installed option is different, recalling the file may fail.

*.cst files

- Contain BOTH instrument state and a LINK to the Cal Sets. [Learn more about Cal Sets.](#)
- The **quickest and most flexible** method of saving and recalling a calibrated instrument state.
- Channels need not have cal data to save as .cst file.
- When recalled, the state information is loaded first. Then the analyzer attempts to apply a Cal Set as you would do manually. If the stimulus settings are different between the instrument state and the linked Cal Set, the usual choice is presented ([see Cal Sets](#)). If the linked Cal Set has been deleted, a message is displayed, but the state information remains in place.
- Because only a link to the Cal Set is saved, the Cal Set can be shared with other measurements.

- If you perform a calibration and save the result to a calset called “MyCalSet”, then save a .cst file (for example, MyState.cst), then that file will have a reference to the name of the calset (“MyCalSet”).
 - If you redo the calibration and store the data again in MyCalset, then the next time you recall MyState.cst, your instrument state will use the new calibration data.
 - If you subsequently delete MyCalset, and then recall the MyState.cst, the resulting instrument state will not be calibrated as the calset no longer exists.

Note: Before saving a .cst file, be sure that a User Cal Set (NOT a Cal Register) is being used for the calibration. Cal Registers are overwritten with new data whenever a calibration is performed, and may not be accurate cal data when the .cst file is recalled. [Learn more about Cal Sets.](#)

*.cal files

- Contain ONLY Cal Set information.
- When recalled, the Cal Set is NOT automatically applied. Apply the calibration data to a channel as you would [apply any Cal Set](#).

*.csa files

- Contain ALL instrument state and the actual Cal Set; not a link to the Cal Set.
- The **safest** method of saving and recalling a calibrated instrument state. However, the file size is larger than a *.cst file, and the save and recall times are longer.
- Channels need not be calibrated to save as .cst file.
- The Cal Set that is saved could be a [Cal Register or a User Cal Set](#).

A .csa file is an instrument state and a collection of calset data. Every channel that has an active calibration (that is, has a calset selected and applied to the channel) stores its calibration data into the .csa file. For example, let's say you have a calset called “mycalset” and you are using that calset on channel 1. You save a .csa file called MyState. If you then perform another calibration and save that calibration to “mycalset”, the data in “mycalset” will not be the same as the calibration data in the MyState file. Consequently, when you recall MyState the old calset called “mycalset” will overwrite the new calset “mycalset”. When this is about to occur, you are given a warning. If this is a problem for you, you might prefer to use a .cst file.

Note: *.pcs files are the internal file format used for storing cal sets. These files should never be accessed or copied by the user.

Measurement Data Files

Measurement data is saved as ASCII file types for use in a spreadsheet or CAE programs.

Note: Before saving measurement data, always **trigger a single** measurement, and then allow the channel to go into Hold. This ensures that the entire measurement trace is saved.

Note: **Memory traces** can NOT be saved to any file type (PRN, SNP, CTI, CSV, MDF).

The following file types can be saved by the analyzer:

- *.prn files
- *.SNP (Touchstone)
- *.cti (Citifile)
- *.csv
- *.mdf (MDIF)

*.prn Files

Prn files have the following attributes:

- Comma-separated data which can be read into rows and columns by spreadsheet software, such as Microsoft Excel. To avoid the "delimiting" dialog boxes, change the filename extension from .prn to .csv. Then open directly into Microsoft Excel.
- Contain formatted and corrected stimulus and response data for the current active trace ONLY.
- Are Output only - they cannot be read by the analyzer.
- **Cal Set Viewer** data can be saved to *.prn files

How to Save PRN Trace Data (*.prn)

Using **Hardkey/SoftTab/Softkey**

1. Press **Save Recall** > **Save Other** > **Save Data...**
2. Under **Save as type**, select **PRN Trace Data (*.prn)**.

Programming Commands

Example:

"S₁₁ Log Mag"

"Frequency (Hz)",	"dB"
3.000000e+005 ,	-3.528682e+001 ,
4.529850e+007 ,	-2.817913e+001 ,
9.029700e+007 ,	-3.216808e+001 ,
1.352955e+008 ,	-3.101017e+001 ,

.SNP Format (*.s1p, *.s2p, *.s3p, *.s4p, and so forth)

- *.SNP file format, also known as Touchstone format, is specified by IBIS. [See the Touchstone specification.](#)
- *.SNP file format is used by CAE programs such as Keysight's Microwave Design System (MDS) and Advanced Design System (ADS).
- *.SNP data is saved using the **File, Save Data As** dialog.

Before saving measurement data, always **trigger a single** measurement, and then allow the channel to go into Hold. This ensures that the entire measurement trace is saved.

*.SNP files and other analyzer settings

- .SNP data can be **recalled** and viewed on the analyzer, or read by the **embed/de-embed** functions.
- To save SNP data with an external test set enabled, at the File, **Save As** dialog, select **SNP File(*.s*p)**, then complete the **"Choose Ports "** dialog.
- When **Fixturing** is enabled, all of the enabled data transforms (De-embedding, Port Z Conversion, and so forth) are applied to saved SNP files.

- When **Smoothing** is applied to a trace, the smoothing is NOT saved when the format is Real, Imaginary (RI). Select a different format to save the smoothed data.
- Segmented FCA data is saved to *.S2PX files. Scroll down or [click here](#) to learn more.
- Learn about [FCA parameters that are saved to an S2P file](#).
- Noise Figure parameters and S-parameters can be saved to an *.s2p file. [Learn more](#).
- Balanced parameters can be saved to *.SNP files. See the "[Choose Ports](#) " dialog.
- **IMPORTANT** - ALL valid data is saved using the same format and settings (trace math, offset, delay, and so forth) as the active measurement. This can cause the data that is saved for the non-active measurements to be dramatically different from the data that is displayed. For example, when saving an S2P file, if the active S11 measurement is set to Data/Mem (data divided by memory), then ALL 4 S-parameters are saved using Data/Mem. The memory trace that is used in the Data/Mem operation is the same as that used in the active (S11) measurement.

What is Saved

*.SNP data is generally used to gather all S-parameters for a fully corrected measurement.

The analyzer saves the data that is available on the channel of the active measurement.

File Type	# of Ports	# of S-parameters saved
*.s1p	1	1 S-parameter
*.s2p	2	4 S-parameters
*.s3p	3	9 S-parameters
*.s4p	4	16 S-parameters
...
*.SNP	N	N^2 S-parameters

- If correction for a **Full N-port cal** is applied, then valid data is returned for all corrected s-parameters. Response calcs will save uncorrected data.
- If requesting **less** data than is available, the [Choose ports for SNP data](#) dialog appears.
- If correction is NOT applied, the analyzer returns as much applicable raw data as possible using S-parameter measurements on the selected channel. Data that is not available is zero-filled. For example, if correction is NOT applied and the active measurement is S11, and an S21 measurement also exists on the channel, then data is returned for the S11 and S21 measurements. Data for S12 and S22 is not available and therefore returned as zeros in Real/Imaginary format. In Log Mag/Phase format, this appears as -200 dB and 45 degrees.

How to Save .SNP Format (*.s1p, *.s2p, *.s3p, *.s4p)

Using **Hardkey/SoftTab/Softkey**

1. Press **Save Recall** > **Save Other** > **Save Data...**
2. Under **Save as type**, select **Trace (*.s1p, *.s2p, *.s3p or *.s4p)**.

◀ Programming Commands ▶

.SNP Data Output

.SNP files contain header information, stimulus data, a response data pair for EACH S-parameter measurement. The only difference between .s1p, s2p, and so forth, is the number of S-parameters that are saved.

The following is a sample of **Header information**:

```
!Keysight Technologies,E8362B,US42340026,Q.03.54
!Keysight E8362B: Q.03.54
!Date: Friday, April 25, 2003 13:46:41
!Correction: S11(Full 2 Port SOLT,1,2) S21(Full 2 Port SOLT,1,2) S12(Full 2 Port
SOLT,1,2) S22(Full 2 Port SOLT,1,2)
!S2P File: Measurements:S11,S21,S12,S22:
# Hz S RI R 50
```

Note: Although the following shows Real / Imag pairs, the format could also be LogMag / Phase or LinMag / Phase

*.s1p Files

Each record contains 1 stimulus value and 1 S-parameter (total of 3 values)

Stim Real (Sxx) Imag(Sxx)

Example:

```
!Keysight Technologies,E5080A,MY55100056,A.10.99.02
!Date: Tuesday, November 25, 2014 13:15:03
!Correction: S11(Off)
!S1P File: Measurement: S11:
# Hz S dB R 50
100000 0.10494874 -0.30662519
45099500 -0.039064661 -0.64403939
90099000 -0.038124748 -1.0683264
135098500 -0.0094892867 -1.5759366
180098000 0.014229189 -2.3191988
225097500 -0.020684797 -2.8619499
270097000 -0.014656636 -3.4809942
```

*.s2p Files

Each record contains 1 stimulus value and 4 S-parameters (total of 9 values)

Stim Real (S11) Imag(S11) Real(S21) Imag(S21) Real(S12) Imag(S12) Real(S22) Imag(S22)

Example:

```
!Keysight Technologies,E5080A,MY55100056,A.10.99.02
!Date: Tuesday, November 25, 2014 13:23:10
!Correction: S11(off)
!S21(off)
!S12(off)
!S22(off)
!S2P File: Measurements: S11, S21, S12, S22:
# Hz S dB R 50
100000 -200 45 -53.193119 44.821617 -200 45 -200 45
45099500 -200 45 -85.316757 83.057785 -200 45 -200 45
90099000 -200 45 -86.266129 117.26331 -200 45 -200 45
135098500 -200 45 -97.65741 -75.884865 -200 45 -200 45
180098000 -200 45 -83.678986 -38.655216 -200 45 -200 45
225097500 -200 45 -100.30289 110.7329 -200 45 -200 45
270097000 -200 45 -90.416489 -95.377228 -200 45 -200 45
```

*.s3p Files

Each record contains 1 stimulus value and 9 S-parameters (total of 19 values)

Stim Real (S11) Imag(S11) Real(S12) Imag(S12) Real(S13) Imag(S13)
Real (S21) Imag(S21) Real(S22) Imag(S22) Real(S23) Imag(S23)
Real (S31) Imag(S31) Real(S32) Imag(S32) Real(S33) Imag(S33)

Example:

```
!Keysight Technologies,E5080A,MY55100056,A.10.99.02
!Date: Tuesday, November 25, 2014 13:46:11
!Correction: S11(off)
!S12(off)
!S13(off)
!S21(off)
!S22(off)
!S23(off)
!S31(off)
!S32(off)
!S33(off)
!S3P File: Measurements: <S11,S12,S13>,
!<S21,S22,S23>,
!<S31,S32,S33>:|
# Hz S dB R 50
100000 -200 45 -200 45 -200 45
-53.0299 39.06152 -200 45 -200 45
-200 45 -200 45 -200 45
45099500 -200 45 -200 45 -200 45
-86.416527 -148.5036 -200 45 -200 45
-200 45 -200 45 -200 45
```

*.s4p Files (and so forth...)

Each record contains 1 stimulus value and 16 S-parameters (total of 33 values)

Stim Real (S11) Imag(S11) Real(S12) Imag(S12) Real(S13) Imag(S13) Real(S14) Imag(S14)
Real (S21) Imag(S21) Real(S22) Imag(S22) Real(S23) Imag(S23) Real(S24) Imag(S24)
Real (S31) Imag(S31) Real(S32) Imag(S32) Real(S33) Imag(S33) Real(S34) Imag(S34)
Real (S41) Imag(S41) Real(S42) Imag(S42) Real(S43) Imag(S43) Real(S44) Imag(S44)

Example:

```

!Keysight Technologies,E5080A,MY55100056,A.10.99.02
!Date: Tuesday, November 25, 2014 13:49:39
!Correction: S11(off)
!S12(off)
!S13(off)
!S14(off)
!S21(off)
!S22(off)
!S23(off)
!S24(off)
!S31(off)
!S32(off)
!S33(off)
!S34(off)
!S41(off)
!S42(off)
!S43(off)
!S44(off)
!S4P File: Measurements: <S11,S12,S13,S14>,
!<S21,S22,S23,S24>,
!<S31,S32,S33,S34>,
!<S41,S42,S43,S44>:
# Hz S dB R 50
100000 -200 45 -200 45 -200 45 -200 45
-53.203884 42.648342 -200 45 -200 45 -200 45
-200 45 -200 45 -200 45 -200 45
-200 45 -200 45 -200 45 -200 45

```

.S2PX Data Output

*.S2PX files are used for Segmented Mixer Data. [Learn more.](#)

The following ADDITIONAL columns precede parameter data:

SegIndex,InputFreq,OutputFreq,LO1Freq,InputPower,LO1Power, <parameter data>

Choose ports for SNP File dialog box help

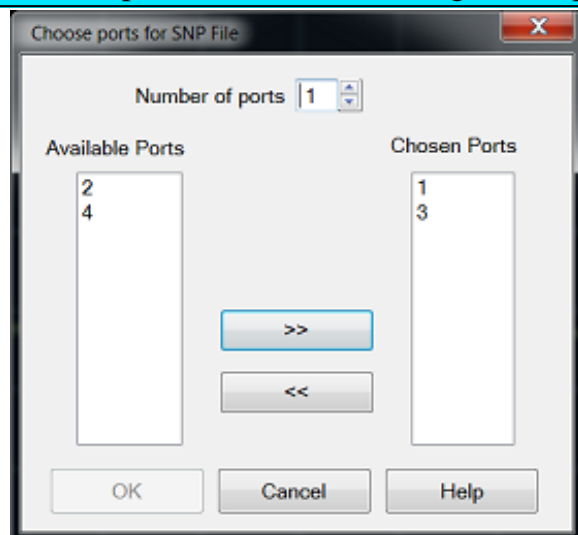

This dialog appears when any of the following conditions exist while attempting to save data to an *.snp file:

- you request less data than is available
- you want data for more than 4 ports
- a balanced measurement is active

Number of ports Select the number of ports for which data will be saved.

The following buttons appear ONLY when a **Balanced measurement** is displayed.

Normal Click to save normal (single-ended) port data.

Mixed Mode Click to save balanced (logical) port data. Choices are based on the **topology selection** for current active parameter:

- **SE-Bal:** Choose from S1, D2, C2 (Single-ended port 1, Differential port 2, Common port 2)
- **SE, SE, Bal:** Choose from S1, S2, D3, C3 (Single-ended port 1, Single-ended port 2, Differential port 3, Common port 3)
- **Bal-Bal:** Choose from D1, C1, D2, C2 (Differential port 1, Common port 1, Differential port 2, Common port 2)

For example, with SE-Bal topology, choose 2 ports, S1 for first, and D2 for second. The following 4 parameters are saved: Sss11, Ssd12, Sds21, Sdd22.

Arrow buttons Click to Add or Remove ports from or to the following columns:

Available Ports All test set ports are listed. There may NOT be valid data available for all of these ports. [Learn more.](#)

Chosen Ports When **OK** is clicked, SNP data is saved for these ports.

OK Becomes available when the number of **Chosen ports** = the **Number of ports** to save. Click to save to SNP file.

With **Number of ports** = 2, .s2p data is saved; with **Number of ports** = 3, .s3p data is saved, and so forth. [Learn more about SNP files](#)

.cti CitiFiles

Citifile format is compatible with the Keysight 8510 Network Analyzer and Keysight's Microwave Design System (MDS).

You can do the following using citifiles :

- save the active trace, or all traces.
- save formatted or unformatted citifile data

How to Save Citifile Formatted Data (*.cti)

Using **Hardkey/SoftTab/Softkey**

1. Press **Save Recall** > **Save Other** > **Save Data....**
2. Under **Save as type**, select **Citifile Formatted Data (*.cti)**.

Programming Commands

*.csv files contain:

- Header information
- Stimulus data
- Data pairs for EACH S-parameter measurement

```

CITIFILE A.01.01
!Keysight Technologies,E5080A,MY55100056,A.10.99.02
!Format: LogMag/Angle
!Date: Tuesday, November 25, 2014 13:55:21
NAME CH1_DATA
VAR Freq MAG 201
DATA S[1,1] DBANGLE
VAR_LIST_BEGIN
100000
45099500
90099000
135098500
180098000
225097500
270097000

```

The above image is a Citifile opened in Notepad. There are two traces in separate channels - one is an FCA trace. Each trace has 3 data points. The save settings = **Displayed Traces Content**, and **Auto Format**.

Format is identified by DBANGLE (log mag), MAGANGLE (Lin Mag), or RI (real, imaginary - NOT shown)

On the **data access map**, Formatted data is taken from location 2 or 4.

How to Save Citifile Unformatted Data (*.cti)

Using **Hardkey/SoftTab/Softkey**

1. Press **Save Recall** > **Save Other** > **Save Data...**
2. Under **Save as type**, select **Citifile Data Data (Real,imag) (*.cti)**.

Programming Commands

On the **data access map**, Unformatted data is taken from the block just before Format.

Citifiles can be recalled and viewed in the analyzer. [Learn more.](#)

*.csv Files

CSV files are read by spreadsheet programs such as Microsoft Excel.

How to Save CSV Formatted Data (*.csv)

Using **Hardkey/SoftTab/Softkey**

1. Press **Save Recall** > **Save Other** > **Save Data...**
2. Under **Save as type**, select **CSV Formatted Data (.csv)**.

Programming Commands

*.csv files contain: header information and the following Comma-Separated Values.

- Stimulus data
- Data pairs for EACH S-parameter

```
!CSV A.01.01
!Keysight Technologies,E5080A,MY55100056,A.10.99.02
!Date: Tuesday, November 25, 2014 13:59:46
!Source: Standard

BEGIN CHI_DATA
Freq(Hz),S12(DB),S12(DEG)
100000,-52.485683,48.510338
45099500,-88.645714,8.0142174
90099000,-91.439514,151.57732
135098500,-97.596909,161.57434
180098000,-89.367058,-8.4136505
225097500,-90.176117,-28.1868
270097000,-92.614517,39.603615
```

*.mdf Files

MDIF files are compatible with Keysight ADS (Advanced Design System). [Learn more at the Keysight website.](#)

How to Save MDIF Data (*.mdif)

Using **Hardkey/SoftTab/Softkey**

1. Press **Save Recall** > **Save Other** > **Save Data....**
2. Under **Save as type**, select **MDIF Data (*.mdif)**.

Programming Commands

*.mdf files contain: header information and space-separated data:

- Stimulus data
- Real and Imaginary data pair for EACH S-parameter measurement

```
!MDF A.01.01
!Keysight Technologies,E5080A,MY55100056,A.10.99.02
!Date: Tuesday, November 25, 2014 14:03:06

BEGIN CHI_DATA
% Freq(real) S1_2(complex)
100000 0.0019314616 0.0013986562
45099500 3.1364398e-005 -4.5943485e-005]
90099000 -1.8545568e-005 4.4789402e-005
135098500 1.3526749e-005 -1.0504767e-005
180098000 -3.9172905e-005 -4.4675748e-005
225097500 -2.7127206e-005 -1.5924486e-005
```

Define Data Saves

Note: Although these settings are still supported, they are no longer necessary to save data files. The **Save Data As** dialog box contains these settings.

How to select Define Data Saves

Using **Hardkey/SoftTab/Softkey**

1. Press **System** > **System Setup** > **Preferences....**
2. Click the **Data Saves...** button on the Preferences dialog box.

Programming Commands

Define Data Saves dialog box help

Note: Although these settings are still supported, they are no longer necessary to save data files. The **Save Data As** dialog box contains these settings.

The following settings survive an Instrument Preset and Shutdown.

CitiFile, CSV, and MDIF Contents

Determines what is saved to a .cti file.

Auto - Saves the active trace. Additional traces are saved if correction is ON. For Full 2-port calibration, 4 traces are saved; for Full 3-port calibration, 9 traces are saved, and so forth.

Single Trace - Saves the active trace.

Displayed Traces - Saves all displayed traces for all channels.

Citifile and CSV Format

Auto - Data is saved in LogMag or LinMag if one of these is the currently selected display format. If format is other than these, then data is saved in Real/Imag.

LogMag, LinMag, Real/Imag - Select output format.

- The imaginary portion for all LogMag and LinMag data is saved in degrees.
- Real/ Imag data is never smoothed.

SnP Format (.s1p, .s2p, .s3p)

[Learn more about SnP files.](#)

Auto - Data is saved in LogMag or LinMag if one of these is the currently selected format. If format is other than these, then data is saved in Real/Imag.

LogMag, LinMag, Real/Imag - Select output format. The imaginary portion for all LogMag and LinMag data is output is in degrees.

Manage Files without a Mouse

How to Manage Files without a Mouse

Using **Hardkey/SoftTab/Softkey**

1. Press **Save Recall** > **Save Other**.
2. Click **Manage Files...** and then **D:\ drive folder** dialog box appears.

OR

1. Press **System** > **Main**.
2. Click **Manage Files...** and then **D:\ drive folder** dialog box appears.

◀ **Programming Commands** ▶

Manage Files dialog box help

The Manage Files dialog box is designed to be used from the front panel. It performs the same function as Windows Explorer, but can be used without the use of a mouse or keyboard.

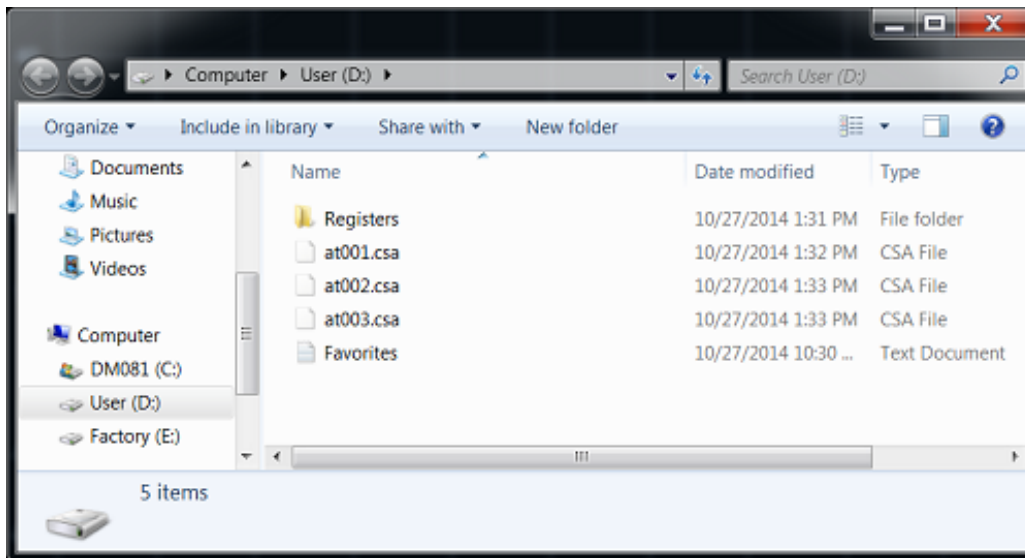

Print a Displayed Measurement

The analyzer allows you to print a displayed measurement to a printer or to a file. The printer can be either networked or local.

- [Connecting a Printer](#)
- [Printing](#)

Other Outputting Data topics

Connecting a Printer

You can connect a printer to one of the VNA USB ports or to the LAN connector.

To Add a Printer

Note: If you try to print from the VNA application and the **Add Printer Wizard** appears, click **Cancel** and add the printer using the following procedure.

1. From the VNA application, press **System > Main > Minimize Application**.
2. On the Windows taskbar, click **Devices and Printers**.
3. Double-click **Add Printer**.
4. Follow the instructions in the **Add Printer** Wizard.

For more information, refer to Microsoft Windows Help or your printer documentation.

Printing

- [Print a Hardcopy](#)
- [Page Setup](#)
- [Print to File](#)

The measurement information on the screen can be printed to any local or networked printer that is connected to the VNA. The graphic below shows an example of how a screen-capture image appears

when printed. The **Page Setup** settings allows you to customize the printed form of the measurement information.

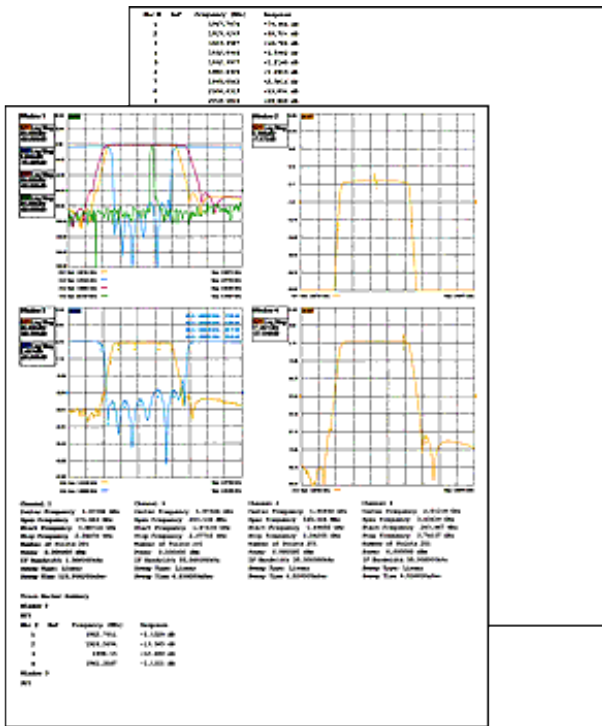

How to Print a Hardcopy

Using **Hardkey/SoftTab/Softkey**

1. Press **System** > **Print**.
2. Click **Print...**

No programming commands are available for this feature.

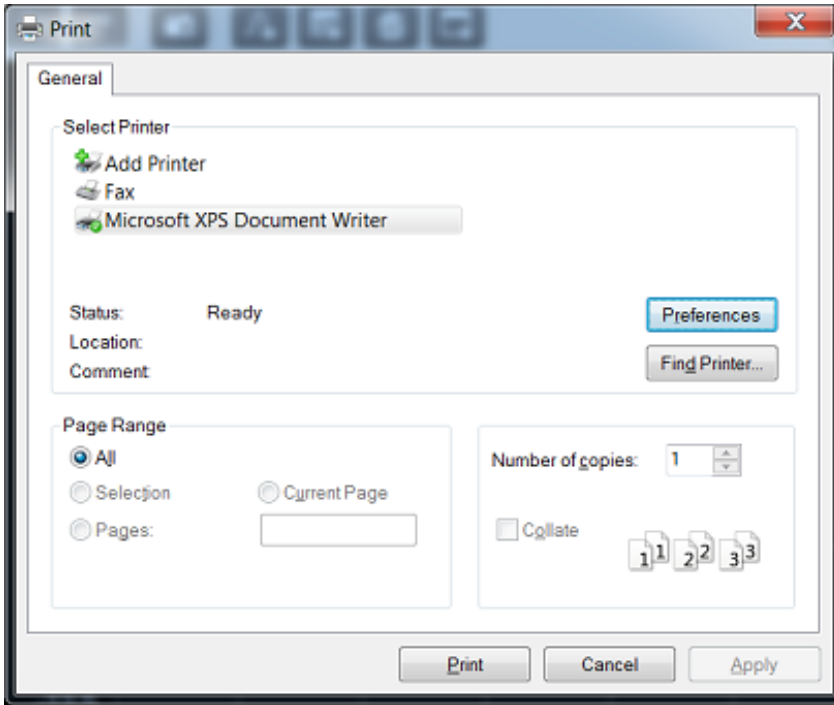

Note: For information on the choices in the Print dialog box, see Windows Help.

Page Setup

The Page Setup dialog allows flexibility in the appearance that measurement data is printed. After setting up the page, click **File**, then **Print...** to obtain a hard-copy.

How to select Page Setup

Using **Hardkey/SoftTab/Softkey**

1. Press **System** > **Print** > **Page Setup....**

OR

1. Press **System** > **System Setup** > **Preferences.....**
2. Click the **Page Setup...** button on Preferences dialog box.

◀ **Programming Commands** ▶

Page Setup dialog box help

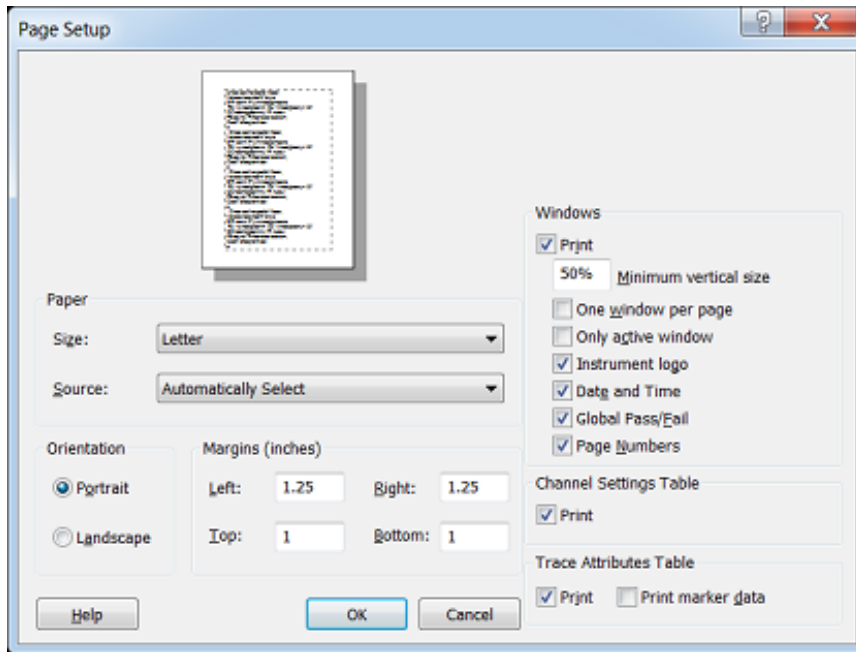

Paper, Orientation, and Margins

These settings do NOT survive a VNA shutdown.

See Windows Help for information on these settings.

Windows

The following VNA-specific settings DO survive a VNA shutdown:

Minimum vertical size Adjust to change the amount of a page that the measurement window fills. The adjustment range is from 40 to 100%.

One window per page Check to print one window per page. Clear to print all selected windows without a forced page break.

Only active window Check to print only the active window. Clear to print all windows.

Instrument logo Check to print the Keysight logo to the header.

Data and Time Check to add the current date and time to the header.

Global Pass/Fail Check to add the Global Pass/Fail status to the header.

Page Numbers Check to add page numbers (1 of n) to the header.

Channel Settings Table

Print Check to print the channel settings table.

Segment data can no longer be printed.

Trace Attributes Table

Print Check to print the Trace Attributes Table. The Trace Attributes are measurement type, correction factors ON or OFF, smoothing, options, and marker details. The Trace Attributes are listed by Trace ID# for each window.

Each Trace ID# can have multiple entries depending on the number of markers associated with the trace. The marker details are marker number, position and response. If there are multiple markers on a trace, the trace attributes are only shown for the first marker. However, the trace attributes for the first marker apply to all other markers on that trace.

The options column can have one or more options. **D** for Delay, **M** for Marker, **G** for Gating. Multiple options selected would appear as follows: DMG.

Print marker data Check to print all marker data. The amount of data depends on how many markers are created.

Print to a File

The analyzer can save a screen-capture image in any of the following formats:

- **.png** (preferred format)
- **.bmp** (bitmap)
- **.jpg**

The analyzer automatically saves the file to the current path. If not previously defined, the analyzer automatically selects the default path D:\.

A .bmp file, like a .prn file, can be imported into software applications such as Microsoft Excel, Word, or Paint to display a screen-capture image.

See [Save and Recall files](#) for more information.

How to Print to a File

Using **Hardkey/SoftTab/Softkey**

1. Press **System > Print > Print to File...**

◀ **Programming Commands** ▶

Finding Programming Commands

Three ways to find programming commands:

1. From simulated User Interface: **Hardkeys** , **SoftTabs** , and **Softkeys** .

Click on **Command Finder** to display the screen below. Clicking on one of the **Hardkeys** shown in the online help screen opens the corresponding **SoftTab** and **Softkey** menus and corresponding SCPI/COM commands.

The screenshot displays the 'VNA Series Network Analyzer Help' window. On the left is a 'Contents' sidebar with a tree view. The main area is titled 'Trace Commands' and contains three tabs: 'Trace 1-7', 'Trace 8-15', and 'Trace Setup'. Below these is a table of 'Trace 1 - 7 Tab Commands' with columns for Softkey, Sub-item, SCPI, and COM. A 'Trace 8 - 15 Tab Commands' section is partially visible at the bottom. On the right is a 'Hardkeys' panel with various function buttons. Annotations include a blue arrow labeled 'Softkeys' pointing to the 'Trace 1-7' tab, a green arrow labeled 'SoftTabs' pointing to the 'Trace 1-7' and 'Trace 8-15' tabs, and a blue bracket labeled 'Hardkeys' pointing to the right-hand panel.

Softkey	Sub-item	SCPI	COM
Trace 1	On/Off	DISPlay:WINDow:TRACe[:STATe]	View
Trace 2	On/Off	DISPlay:WINDow:TRACe[:STATe]	View
Trace 3	On/Off	DISPlay:WINDow:TRACe[:STATe]	View
Trace 4	On/Off	DISPlay:WINDow:TRACe[:STATe]	View
Trace 5	On/Off	DISPlay:WINDow:TRACe[:STATe]	View
Trace 6	On/Off	DISPlay:WINDow:TRACe[:STATe]	View
Trace 7	On/Off	DISPlay:WINDow:TRACe[:STATe]	View
New Traces...		CALCulate:MEASure:PARAMeter	CreateSPParameterEx

2. From a simulated User Interface of the drop-down menus:

File | Instrument | Response | Stimulus | Utility | Cal | Apps | Remote ONLY

	GPIB / SCPI
3.	Command Tree
See Also	Example Programs Learning about GPIB

See Also

- **Important Programming the PXI VNA**
- New PXI Programming Commands
- Remotely Specifying a Source Port
- Your Programs on Windows
- Using Macros
- Data Access Map

SCPI Command Tree

See Also

- [Example Programs](#)
- [Find commands using a simulated VNA UI](#)
- [See list of all SCPI Errors.](#)
- [See Calibrating the VNA Using SCPI](#)
- [Synchronizing the Analyzer and Controller](#)
- [IEEE- 488.2 Common Commands](#)
- [Local Lockout](#)

ABORt	Stops all sweeps
AFR	Automatic Fixture Removal
+ CALCulate	Click to hide and show CALC branches
CORRection	Electrical Delay and Phase Offset
CUSTom	Custom measurements
DATA	Sends and queries data
DIQ	Differential IQ measurement
DTOPology	Defines topology for a balanced measurement
EQUation	Equation Editor
FILTer	Time domain gating
FORMat	Display format
FSIMulator	Balanced measurements and Fixturing
FUNction	Trace Statistics
GCData	Read Gain compression data
GCMeas	Gain Compression Analysis
GDElay	Group Delay Aperture setting
HOLD	Trace Hold
LIMit	Limit lines for pass / fail testing
MARKer	Marker settings
MATH	Math / Memory
MEASure	Measurement settings specific to a measurement number
BLIMit	Bandwidth threshold settings
CONVersion	Conversion parameter setting

CORRection	Electrical delay settings
DATA	Sends and queries data
FILTer	Gate filter settings
FUNcTion	Trace Statistics
GCData	Read Gain compression data
GCMeas	Gain Compression Analysis
GDELaY	Group Delay Aperture settings
LIMit	Limit line settings
MARKer	Marker settings
OFFSet	Mag and Phase offset
PARAmeter	Balanced measurement parameter settings
RLIMit	Ripple limit settings
SA:MARKer	Spectrum Analyzer markers
SMOothing	Smoothing settings
TRANSform	Time domain transform settings
UNCertainty	Uncertainty trace properties
X	X-Axis settings
MIXer	X-axis display for FCA measurements
NORMalize	Receiver power cal (Obsolete)
OFFSet	Mag and Phase offset
PARAmeter	Create and delete measurements
RDATA?	Queries receiver data
SMOothing	Point-to-point smoothing
TDR	Enhanced Time Domain Analysis
TRANSform	Time domain transform
UNCertainty	Uncertainty Trace Properties
X:AXIS	X-Axis Domain

CALPod	Controls CalPod units
CONTRol	Interface control, ECal module state control, and Rear-panel connector control.
CONTRol:MULTiplexer	Control the E5092A Configurable Multiport Test Set.
CSET	Work with a Cal Set without having to select it into that channel.
DISPlay	Display settings
FORMat	Format for data transfer
HCOPY	Hardcopy printing
INITiate	Continuous or manual triggering
LXI	LXI communications
MMEMory	Saves and recalls instrument states
OUTPut	Turns RF power ON and OFF
+ SENSE Click to hide and show SENSE branches	
AMPLifier	Control the M9379A
AVERage	Sweep Averaging
BANDwidth	IF Bandwidth
CLASs	Returns measurement class name
CORRection	Calibration and other correction settings
CKIT	Manage Cal Kits and ECal modules
COLL:CKIT	Edit Cal Kit definitions
COLL:GUIDed	Perform Guided Cals
COLL:SESSion	Perform SMC and VMC calibrations
CSET	Manage Cal Sets
EXTension	Port Extensions
IMD	Controls IMD and IMDx calibration
TDR	Enhanced Time Domain Analysis
COUPle	Chopped or Alternate sweep
DUTControl	Control M9341B
ECAL:CHARacterize	Ecal user characterization
FOM	Frequency Offset (opt 080)
FOM Segment	Construct a segment table
FREQuency	Frequency sweep settings
GCSetup	Gain Compression App (opt 086)
MIXer	FCA measurements (opts S93082A/B and S93083A/B)
MIXer Embed LO	Allows measurements of mixers with embedded LO

MIXer Segment	Configures mixer segments
MULTiplexer	Controls external test sets
NOISe	Noise Figure (opt 028 / 029)
PATH	Provides access to hardware configuration
POWer	Receiver attenuation and overpower protection
PULSe	Configure internal pulse generators
ROLE	Assign sources to roles
ROSCillator	Returns the source of the reference oscillator
SOURce	Receiver gain settings
SEGMENT	Segment sweep settings
SWEep	Sweep types
SWEep Pulse	Pulse measurements
SWITCh	Control the M9191D switch module
TDR	Enhanced Time Domain Analysis
TEMPerature	Returns the temperature on the receiver board
X:VALues	Returns X-axis values for channel
SOURce	Source power to the DUT
DC	DC Source control
MODulation	Control external source to set up and calibrate I/Q modulation.
Multi-Dimensional Sweep	Multi-dimensional sweep control on a Spectrum Analyzer channel
PHASe	Phase control (Opt S93088A/B)
POWER:CORR	Source power calibration
ALC:MODE:REC	Receiver Leveling
PULSe	Enable pulse state control using external pulse source
STATus	Reads the VNA status registers
TDR	Enhanced Time Domain Analysis
+ SYSTem	Click to hide and show SYSTem branches

SYSTem	VNA system setting commands
ACTive	Manage active channel/measurement
CAL:All	Calibrate All Channels
CAPability	Reads various capabilities of the analyzer
CAP:HARD:MODule	PXI module capabilities
CHANnels	Perform channel operations
COMMunicate	Controls and queries PNA settings
CONF:EDEV	Configure external devices
CONF:EDEV:DC	Configures external SMU, DC Meter, and DC Source properties
CONF:EDEV:PMAR	Configures external Power Meter as Receiver
CORR:INTerpolate:LINear	Linear interpolation
DATA:MEMory	Shared memory commands
FIFO	Controls data in and out of FIFO data buffer
PREFerences	VNA Preferences
SERV:PVER	Instrument Cal dates
TDR	Enhanced Time Domain Analysis
UNCertainty	Dynamic Uncertainty

TRIGger Trigger measurements

IEEE 488.2 Common Commands

***CLS** - Clear Status

***ESE** - Event Status Enable

***ESE?** - Event Status Enable Query

***ESR?** - Event Status Enable Register - See [*ESR? programming example](#)

***IDN?** - Identify

***OPC** - Operation complete command

***OPC?** - Operation complete query

***OPT?** - Identify Options Query

***RST** - Reset

***SRE** - Service Request Enable

***SRE?** - Service Request Enable Query

***STB?** - Status Byte Query

***TST?** - Result of Self-test Query

***WAI** - Wait

See Also

- [Example Programs](#)
 - [Synchronizing the Analyzer and Controller](#)
 - [SCPI Command Tree](#)
-

***CLS - Clear Status**

Clears the instrument status byte by emptying the error queue and clearing all event registers. Also cancels any preceding ***OPC** command or query. See [Status Commands](#) and [Reading the Analyzer's Status Registers](#).

***ESE - Event Status Enable**

Sets bits in the standard event status enable register. See [Status Commands](#) and [Reading the Analyzer's Status Registers](#).

***ESE? - Event Status Enable Query**

Returns the results of the standard event enable register. The register is cleared after reading it. See [Status Commands](#) and [Reading the Analyzer's Status Registers](#).

***ESR - Event Status Enable Register**

Reads and clears event status enable register. See [Status Commands](#) and [Reading the Analyzer's Status Registers](#).

***IDN? - Identify**

Returns a string that uniquely identifies the analyzer. The string is of the form "Keysight Technologies", <model number>, <serial "number">, <software revision>" .

Note: Beginning with Rev 6.01, this command now returns the software revision with 6 digits instead of 4. For example, A.06.01.02.

For 4 state CALPod support the following is required.

- CCT (configurable command table) version 1.4
 - Controller FPGA version 8.4
-

***OPC - Operation complete command**

Generates the OPC message in the standard event status register when all pending overlapped operations have been completed (for example, a sweep, or a Default). See [Understanding Command Synchronization](#).

***OPC? - Operation complete query**

Returns an ASCII "+1" when all pending overlapped operations have been completed. See [Understanding Command Synchronization](#)

***OPT? - Identify Options Query**

Returns a comma-separated string identifying the analyzer option configuration. [See a list of VNA options](#). Refer also to the [option number differences](#) between the common option numbers and those returned using this command.

See also [SYST:CAP:LIC:CAT?](#) for the installed software product license and [SYST:CAP:HARD:MOD:OPT?](#) for hardware options in PXIe/USB VNAs. *OPT? does not return the hardware options for M980xA/P50xxA.

***RST - Reset**

Executes a device reset and cancels any pending *OPC command or query, exactly the same as a [SYSTem:PRESet](#) with one exception: Syst:PreSet does NOT reset [Calc:FORMAT](#) to ASCII. The contents of the analyzer's non-volatile memory are not affected by this command.

*SRE - Service Request Enable

Before reading a status register, bits must be enabled. This command enables bits in the service request register. The current setting is saved in non-volatile memory. See [Status Commands](#) and [Reading the Analyzer's Status Registers](#).

*SRE? - Service Request Enable Query

Reads the current state of the service request enable register. The register is cleared after reading it. The return value can be decoded using the table in [Status Commands](#). See also [Reading the Analyzer's Status Registers](#).

*STB? - Status Byte Query

Reads the value of the instrument status byte. The register is cleared only when the registers feeding it are cleared. See [Status Commands](#) and [Reading the Analyzer's Status Registers](#).

*TST? - Result of Self-test Query

Returns the result of a query of the analyzer hardware status. An **0** indicates no failures found. Any other value indicates one or more of the following conditions exist. The value returned is the Weight (or sum of the Weights) of the existing conditions. For example:

- If **4** is returned from *TST?, an **Overpower** condition exists.
- If **6** is returned, both **Unleveled** and **Overpower** conditions exist.

Bit	Weight	Description	Bit is set to 1 when the following conditions exist:
0	1	Phase Unlock	The source has lost phaselock. This could be caused by a reference channel open or a hardware failure.
1	2	Unleveled	The source power is unleveled. This could be a source is set for more power than it can deliver at the tuned frequency. Or it could be caused by a hardware failure.
2	4	Not used	
3	8	EE Write Failed	An attempted write to the EEPROM has failed. This is possibly caused by a hardware failure.
4	16	YIG Cal Failed	The analyzer was unable to calibrate the YIG. Either the phaselock has been lost or there has been a hardware failure.
5	32	Ramp Cal Failed	The analyzer was unable to calibrate the analog ramp generator due to a possible hardware failure.
6	64	Not used	

***WAI - Wait**

Prohibits the instrument from executing any new commands until all pending overlapped commands have been completed. See [Understanding Command Synchronization](#)

About Triggering

Abort Command

ABORt

Applicable Models: All

(Write-only) Stops all sweeps - then resume per current trigger settings. This command is the same as **INITtiate:IMMediate** (restart) except if a channel is performing a single sweep, ABORt will stop the sweep, but not initiate another sweep.

Learn about [Synchronizing the Analyzer and Controller](#)

Examples	ABOR abort
Query Syntax	Not applicable
Default	Not applicable

Automatic Fixture Removal (AFR)

These commands are used to control the Automatic Fixture Removal (AFR) capabilities in the VNA.

AFR:

FIXTure:

- | **BLIMited[:STATe]**
- | **CDUT[:STATe]**
- | **CLENgth[:STATe]**
- | **CMATch[:STATe]**
- | **INPutS**
- | **MEASurement**
- | **PREView**
- | **DATA**
 - | **[:IMPedance]?**
 - | **MARKer:Y?**
- | **REFZ**

INITialize

SAVE:

- | **FILEname**
- | **PORTs**
- | **TYPE**

STANdard:

- | **ALLOpen[:STATe]**
- | **ALLShort[:STATe]**
- | **DATA**

```
|[:IMPedance]?  
| MARKer:Y?  
| EDIT:  
| FLENgth  
| GATE  
| IMPedance:  
| METHod  
| LOAD  
| THRU  
| USE
```

Click on a keyword to view the command details.

See Also

- [Example Programs](#)
- [Synchronizing the Analyzer and Controller](#)
- [SCPI Command Tree](#)

AFR:FIXTure:BLIMited[:STATe] <bool>

Applicable Models: All with Automatic Fixture Removal Option (S9x007A/B, 007)

(Read-Write) This command selects whether the fixture is band limited or not.

Parameters

<bool> Band limited or not. Choose from:

ON (or 1) - Band limited.

OFF (or 0) - Not band limited.

Examples `AFR:FIXTure:BLIMited ON`

Query Syntax `AFR:FIXTure:BLIMited?`

Return Type Boolean

Default OFF

`AFR:FIXTure:CDUT[:STATe] <bool>`

Applicable Models: All with Automatic Fixture Removal Option (S9x007A/B, 007)

(Read-Write) This command selects whether to use DUT correction or not when the characterization fixture is not equal to the DUT measurement fixture.

Parameters

<bool> DUT correction state. Choose from:

ON (or 1) - Use DUT correction.

OFF (or 0) - Do not use DUT correction.

Examples `AFR:FIXTure:CDUT ON`

Query Syntax `AFR:FIXTure:CDUT?`

Return Type Boolean

Default OFF

`AFR:FIXTure:CLENght[:STATe] <bool>`

Applicable Models: All with Automatic Fixture Removal Option (S9x007A/B, 007)

(Read-Write) This command selects Fixture Length A not equal to B correction.

Parameters

<bool> Correction match state. Choose from:

ON (or 1) - Correct.

OFF (or 0) - Do not correct.

Examples

```
AFR:FIXTure:CLENgth ON
```

Query Syntax AFR:FIXTure:CLENgth?

Return Type Boolean

Default ON

AFR:FIXTure:CMATch[:STATe] <bool>

Applicable Models: All with Automatic Fixture Removal Option (S9x007A/B, 007)

(Read-Write) This command selects Fixture Match A not equal to B correction.

Parameters

<bool> Correction match state. Choose from:

ON (or 1) - Correct.

OFF (or 0) - Do not correct.

Examples

```
AFR:FIXTure:CMATch ON
```

Query Syntax AFR:FIXTure:CMATch?

Return Type Boolean

Default ON

AFR:FIXTure:INPutS <char>

Applicable Models: All with Automatic Fixture Removal Option (S9x007A/B, 007)

(Read-Write) This command describes the fixture inputs (single ended or differential).

Parameters

<char> Choose from:

SENDED - Single ended fixture inputs.

DIFFERENTIAL - Differential fixture inputs.

Examples

```
AFR:FIXTure:INPutS SENDED
```

Query Syntax AFR:FIXTure:INPutS?

Return Type String

Default SEND

AFR:FIXTure:MEASurement <num>

Applicable Models: All with Automatic Fixture Removal Option (S9x007A/B, 007)

(Read-Write) This command selects the number of fixtures to be characterized.

Parameters

<num> Choose from 1, 2, or 4.

Examples

```
AFR:FIXTure:MEASurement 2
```

Query Syntax AFR:FIXTure:MEASurement?

Return Type Numeric

Default 2

AFR:FIXTure:PREView

Applicable Models: All with Automatic Fixture Removal Option (S9x007A/B, 007)

(Write-only) This command refreshes preview data. It is required that this command be sent before a query gate, fixture length, and impedance data.

Parameters None

Examples

```
AFR:STANdard:EDIT:GATE AFIX,0.485
AFR:FIXTure:PREView
AFR:STANdard:EDIT:GATE? AFIX
```

Query Syntax Not Applicable

Default Not Applicable

AFR:FIXTure:PREView:DATA[:IMPedance]? <char_param>

Applicable Models: All with Automatic Fixture Removal Option (S9x007A/B, 007)

(Read-only) This command reads the impedance profile of the calculated fixture model.

Parameters

<char_param> Selected impedance term. Choose from:

ASENded - Single-Ended ZA

BSEnDed - Single-Ended ZB

ADIFf - Differential ZA

BDIFf - Differential ZB

ACOMm - Common mode ZA

BCOMm - Common mode ZB

Examples

```
AFR:FIXTure:PREView:DATA:IMPedance? ADIF
```

Return Type Block Data

Default Not Applicable

AFR:FIXTure:PREView:DATA[:IMPedance]:MARKer:Y? <char_param>,<num_x>

Applicable Models: All with Automatic Fixture Removal Option (S9x007A/B, 007)

(Read-only) This command reads the impedance profile of the calculated fixture model at a specified position.

Parameters

<char_param> Selected impedance term. Choose from:

ASENded - Single-Ended ZA

BSENded - Single-Ended ZB

ADIFf - Differential ZA

BDIFf - Differential ZB

ACOMm - Common mode ZA

BCOMm - Common mode ZB

<num_x> The X-axis position (ns), where the Y-axis value will be returned.

Examples

```
AFR:FIXTure:PREView:DATA:IMPedance:MARKer:Y? ADIF,0.5
```

Return Type Numeric

Default Not Applicable

AFR:FIXTure:REFZ <char>[,<num>]

Applicable Models: All with Automatic Fixture Removal Option (S9x007A/B, 007)

(Read-Write) This command chooses the calibration reference Z0 after fixture removal.

Parameters

<char> Choose from:

SYSZ- System Z0.

MEAZ - Measured fixture Z0.

CUSTom - User input.

<num> Optional argument. If <char> is set to CUST, this is the user input vale for Z0.

Examples

```
AFR:FIXTure:REFZ SYSZ
```

```
AFR:FIXTure:REFZ CUST,52.0
```

Query Syntax	AFR:FIXTure:REFZ?
Return Type	String (SYSZ, MEAZ, or CUST)
Default	SYSZ

AFR:INITialize

Applicable Models: All with Automatic Fixture Removal Option (S9x007A/B, 007)

(Write-only) Restores the default AFR settings.

Parameters None

Examples `AFR:INIT`

Query Syntax Not Applicable

Default Not Applicable

AFR:SAVE:FILEname <string>[,<string>]

Applicable Models: All with Automatic Fixture Removal Option (S9x007A/B, 007)

(Read-Write) This command specifies the file paths of saved fixture data.

Parameters

<string> Fixture A path.

<string> Fixture B path.

Examples `AFR:SAVE:FILEname 'C:\fixA.s2p','C:\fixB.s2p'`

Query Syntax AFR:SAVE:FILEname?

Return Type String

Default "C:\fixA.s2p,C:\fixB.s2p"

AFR:SAVE:PORTs <char>

Applicable Models: All with Automatic Fixture Removal Option (S9x007A/B, 007)

(Read-Write) This command assigns the ports for saved fixture data in several formats.

Parameters

<char> Port assignment. Choose from:

PLTS - PLTS format.

VNA - VNA format.

ADS - ADS format.

Examples

```
AFR:SAVE:PORTs VNA
```

Query Syntax AFR:SAVE:PORTs?

Return Type String

Default VNA

AFR:SAVE:TYPE <char>

Applicable Models: All with Automatic Fixture Removal Option (S9x007A/B, 007)

(Read-Write) This command sets the file type to save fixture data.

Parameters

<char> Impedance method. Choose from:

TSONE - Touchstone file type.

TSTW0 - Touchstone 2 file type.

CITifile - Citifile file type.

Examples

```
AFR:SAVE:TYPE TSONE
```

Query Syntax AFR:SAVE:TYPE?

Return Type String

Default TSONE

AFR:STANdard:ALLOpen[:STATe] <bool>

Applicable Models: All with Automatic Fixture Removal Option (S9x007A/B, 007)

(Read-Write) This command selects all OPEN standards.

Parameters

<bool> Select all OPEN standards or not. Choose from:

ON (or 1) - Use all OPEN standards.

OFF (or 0) - Do not use all OPEN standards.

Examples

```
AFR:STANdard:ALLOpen ON
```

Query Syntax AFR:STANdard:ALLOpen?

Return Type Boolean

Default OFF

AFR:STANdard:ALLShort[:STATe] <bool>

Applicable Models: All with Automatic Fixture Removal Option (S9x007A/B, 007)

(Read-Write) This command selects all SHORT standards.

Parameters

<bool> Select all SHORT standards or not. Choose from:

ON (or 1) - Use all SHORT standards.

OFF (or 0) - Do not use all SHORT standards.

Examples

```
AFR:STANdard:ALLShort ON
```

Query Syntax AFR:STANdard:ALLShort?

Return Type Boolean

Default OFF

AFR:STANdard:DATA[:IMPedance]? <char_std>,<char_param>

Applicable Models: All with Automatic Fixture Removal Option (S9x007A/B, 007)

(Read-only) This command reads the impedance profile of the measured standard.

Parameters

<char_std> Selected standard. Choose from:

THRU - 2X Thru

STHRu - Second 2X Thru

FDUT - Fixtured DUT

AOPen - Fixture A Open

BOPen - Fixture B Open

AShort - Fixture A Short

BShort - Fixture B Short

<char_param> Selected impedance term. Choose from:

ASENded - Single-Ended ZA

BSENded - Single-Ended ZB

ADIFf - Differential ZA

BDIFf - Differential ZB

ACOMm - Common mode ZA

BCOMm - Common mode ZB

Examples

```
AFR:STANdard:DATA:IMPedance? AOP,ADIF
```

Return Type Block Data

Default Not Applicable

AFR:STANdard:DATA[:IMPedance]:MARKer:Y? <char_std>,<char_param>,<num_x>

Applicable Models: All with Automatic Fixture Removal Option (S9x007A/B, 007)

(Read-only) This command reads the impedance of the measured standard at a specified position.

Parameters

<char_std> Selected standard. Choose from:

THRU - 2X Thru

STHRu - Second 2X Thru

FDUT - Fixtured DUT

AOPen - Fixture A Open

BOPen - Fixture B Open

ASHort - Fixture A Short

BShort - Fixture B Short

<char_param> Selected impedance term. Choose from:

ASENded - Single-Ended ZA

BSENded - Single-Ended ZB

ADIFf - Differential ZA

BDIFf - Differential ZB

ACOMm - Common mode ZA

BCOMm - Common mode ZB

<num_x> The X-axis position (ns), where the Y-axis value will be returned.

Examples

```
AFR:STANdard:DATA:IMPedance:MARKer:Y? AOP,ADIF,0.5
```

Return Type Numeric

Default Not Applicable

AFR:STANdard:EDIT:FLENgth <char>,<num>

Applicable Models: All with Automatic Fixture Removal Option (S9x007A/B, 007)

(Read-Write) For the selected fixture, this command reads the fixture length for both 1X or 2X AFR, or sets the fixture length for 1X AFR.

Note: After setting fixture length to a new value, the preview command must be sent to apply the value.

Parameters

<char> Selected fixture. Choose from:

AFIXture - Fixture A.

BFIXture - Fixture B.

<num> Fixture length value. Unit is ns.

Examples

```
AFR:STANdard:EDIT:FLENgth AFIX,0.3273
AFR:FIXTure:PREView
```

Query Syntax AFR:STANdard:EDIT:FLENgth? AFIX

Return Type Numeric

Default Not Applicable

AFR:STANdard:EDIT:GATE <char>,<num>

Applicable Models: All with Automatic Fixture Removal Option (S9x007A/B, 007)

(Read-Write) This command sets or reads the gate position for the selected fixture.

Note: After setting a new gate position, the preview command must be sent to apply the new position.

Parameters

<char> Selected fixture. Choose from:

AFIXture - Fixture A.

BFIXture - Fixture B.

<num> Gate position value. Unit is ns.

Examples

```
AFR:STANdard:EDIT:GATE AFIX,0.485
AFR:FIXTure:PREView
```

Query Syntax AFR:STANdard:EDIT:GATE? AFIX

Return Type Numeric

Default Not Applicable

AFR:STANdard:EDIT:IMPedance <char>,<num>

Applicable Models: All with Automatic Fixture Removal Option (S9x007A/B, 007)

(Write-only) This command sets the impedance for the selected term.

Parameters

<char> Impedance term. Choose from:

ASENded - Single-Ended ZA.

BSEnDed - Single-Ended ZB.

ADIFf - Differential ZA.

BDIFf - Differential ZB.

ACOMm - Common mode ZA.

BCOMm - Common mode ZB.

<num> Impedance value. Unit is Ohms.

Examples `AFR:STANdard:EDIT:IMPedance ASEN,52.5`

Default Not Applicable

AFR:STANdard:EDIT:IMPedance:METHod <char>

Applicable Models: All with Automatic Fixture Removal Option (S9x007A/B, 007)

(Read-Write) This command sets the impedance method.

Parameters

<char> Impedance method. Choose from:

DEFault

AUTO

USER

Examples `AFR:STANdard:EDIT:IMPedance:METHod AUTO`

Query Syntax `AFR:STANdard:EDIT:IMPedance:METHod?`

Return Type Character

Default DEFault

AFR:STANdard:LOAD <char>,<string>

Applicable Models: All with Automatic Fixture Removal Option (S9x007A/B, 007)

(Read-Write) This command loads the calibration standards data from a file.

Parameters

<char> Standards type. Choose from:

THRU- 2X Thru.

STHRu - Second 2X Thru.

FDUT - Fixtured DUT.

AOPen - Fixture A Open.

BOPen - Fixture B Open.

ASHort - Fixture A Short.

BShort - Fixture B Short.

<string> File path of existing measurement data (touchstone 1.0, touchstone 2.0, or citifile).

Examples

```
AFR:STANdard:LOAD AOPen, 'C:\open.s1p'
```

Query Syntax AFR:STANdard:LOAD? AOPen

Return Type String

Default Not Applicable

AFR:STANdard:THRU <char>[,<num>]

Applicable Models: All with Automatic Fixture Removal Option (S9x007A/B, 007)

(Read-Write) This command specifies fixture thru settings.

Parameters

<char> Thru type. Choose from:

KNOWn - Known thru, flush thru, or user input length.

UNKNown - Unknown thru length computed using reflects.

<num> User input thru length. Default is 0.

Examples `AFR:STANdard:THRU KNOW,0`

Query Syntax `AFR:STANdard:THRU?`

Return Type String

Default "KNOW,0"

AFR:STANdard:USE <char>[,<bool>]

Applicable Models: All with Automatic Fixture Removal Option (S9x007A/B, 007)

(Read-Write) This command chooses the calibration standards.

Parameters

<char> Choose from:

THRU- 2X Thru.

STHRu - Second 2X Thru.

FDUT - Fixtured DUT.

AOPen - Fixture A Open.

BOPen - Fixture B Open.

ASHort - Fixture A Short.

BShort - Fixture B Short.

<bool> Use calibration standards or not. Choose from:

ON (or 1) - Use calibration standards.

OFF (or 0) - Do not use calibration standards.

Examples `AFR:STANdard:USE AOPen,ON`

Query Syntax `AFR:STANdard:USE?`

Return Type String of used standards, separated by commas.

For example, use AOPen and BOPen returns:

"AOPen,BOPen"

Default All standards - OFF

Calculate:Correction Commands

Controls error correction functions.

These commands are **Superseded** by the `CALCulate:MEASure:CORRection` commands.

CALCulate:CORRection
EDELay
DISTance
TIME
MEDium
UNIT
WGCutoff
ERRor
[:STATe]
TYPE
[STATe]
INDicator?
TYPE
OFFSet
[MAGNitude]
PHASe

Click on a keyword to view the command details.

Blue keywords are superseded.

See Also

- [Example Programs](#)
- [Calibrating with SCPI](#)
- [Synchronizing the Analyzer and Controller](#)

- [SCPI Command Tree](#)

Critical Note: CALCulate commands act on the selected measurement. You can select one measurement for each channel using [Calc:Par:MNUM](#) or [Calc:Par:Select](#). [Learn more](#).

CALCulate<cnum>:CORRection:EDELay:DIStance <num>

Applicable Models: N522xB, N523xB, N524xB, M937xA, P937xA

(Read-Write) Sets the electrical delay in physical length (distance) for the selected measurement.

[See Critical Note](#)

Parameters

<cnum> Channel number of the measurement. There must be a selected measurement on that channel. If unspecified, <cnum> is set to 1.

<num> Electrical delay in distance.

First Specify units using [CALC:CORR:EDEL:UNIT](#)

Use [SENS:CORR:RVEL:COAX](#) <num> to set Velocity factor.

This parameter supports MIN and MAX as arguments. [Learn more](#).

Examples

```
CALC1:CORR:EDEL:DIST 5
```

```
calculate2:correction:distance .003
```

Query Syntax CALCulate:CORRection:EDELay:DIStance?

Return Type Numeric

Default 0

CALCulate<cnum>:CORRection:EDELay:MEDIum <char>

Applicable Models: N522xB, N523xB, N524xB, M937xA, P937xA

(Read-Write) Sets the media used when calculating the electrical delay.

Parameters

- <num> Any existing channel number. If unspecified, value is set to 1.
- <num> Choose from: **COAX** for coaxial medium, **WAVEguide** for waveguide medium.

Examples

```
CALC:CORR:EDEL:MED COAX
calc3:corr:edelay:medium waveguide
```

Query Syntax CALCulate<num>:CORRection:EDELay:MEDium?

Return Type Character

Default COAX

CALCulate<num>:CORRection:EDELay:UNIT <char>

Applicable Models: N522xB, N523xB, N524xB, M937xA, P937xA

(Read-Write) Sets and returns the units for specifying electrical delay in physical length (distance).

Parameters

- <num> Any existing channel number. If unspecified, value is set to 1.
- <char> Units for delay in distance. Choose from:

- METer
- FEET
- INCH

Examples

```
CALC:CORR:EDEL:UNIT MET
calc3:corr:edelay:unit inch
```

Query Syntax CALCulate<num>:CORRection:EDELay:UNIT?

Return Type Character

Default METer

CALCulate<num>:CORRection:EDELay[:TIME] <num>

Applicable Models: N522xB, N523xB, N524xB, M937xA, P937xA

(Read-Write) Sets the electrical delay for the selected measurement.

See [Critical Note](#)

Parameters

<cnum> Channel number of the measurement. There must be a selected measurement on that channel. If unspecified, <cnum> is set to 1.

<num> Electrical delay in seconds. Choose any number between:
-10.00 and 10.00
Use **SENS:CORR:RVEL:COAX** <num> to set Velocity factor.

This parameter supports MIN and MAX as arguments. [Learn more.](#)

Examples

```
CALC1:CORR:EDEL:TIME 1NS  
calculate2:correction:time 0.5e-12
```

Query Syntax CALCulate:CORRection:EDELay[:TIME]?

Return Type Numeric

Default 0 seconds

CALCulate<cnum>:CORRection:EDELay:WGCutoff <num>

Applicable Models: N522xB, N523xB, N524xB, M937xA, P937xA

(Read-Write) Sets the waveguide cutoff frequency used when the electrical delay media is set to WAVEguide. (See **CALCulate:CORRection:EDELay:MEDium** <char>.)

Parameters

<cnum> Any existing channel number. If unspecified, value is set to 1.

<num> Waveguide cutoff frequency used with the electrical delay calculation.

This parameter supports MIN and MAX as arguments. [Learn more.](#)

Examples

```
CALC:CORR:EDEL:WGC 18.067 GHz  
calculate3:correction:edelay:wgcutoff 14.047 ghz
```

Query Syntax CALCulate<cnum>:CORRection:EDELay:WGCutoff?

Return Type Numeric

Default 45 MHz

CALCulate<cnum>:CORRection:ERRor[:STATe] <bool>

Applicable Models: N522xB, N523xB, N524xB, M937xA, P937xA

(Read-Write) Turns error correction ON or OFF on the specified channel.

To turn error correction ON or OFF for a channel, use **SENS:CORR:STATe**.

See [Critical Note](#)

Parameters

<cnum> Any existing channel number. If unspecified, value is set to 1

<bool> Correction state. Choose from:

0 - Correction OFF

1 - Correction ON

Examples

```
CALC:CORR:ERR ON
```

```
calculate:correction:error:state off
```

Query Syntax CALCulate<cnum>:CORRection:ERRor:STATe?

Return Type Boolean

Default Not Applicable

CALCulate<cnum>:CORRection:ERRor:TYPE <string>

Applicable Models: N522xB, N523xB, N524xB, M937xA, P937xA

(Read-Write) Sets the Cal Type on the specified channel. This is used when a Cal Set is applied. [Learn more about applying Cal Types.](#)

- Use **SENS:CORR:TYPE:CAT?** to list the Cal Types in the VNA.
- Use **SENS:CORR:CSET:TYPE:CAT?** to list the Cal Types contained in the active Cal Set for the channel.
- Use **SENS:CORR:COLL:METH** to set the Cal type to perform a new Unguided calibration,

See [Critical Note](#)

Parameters

<cnum> Any existing channel number. If unspecified, value is set to 1

<string> **(String)** Cal type. Case sensitive. Use one of the following:

For Full Calibrations (NO Power Cal included):

This command does not distinguish between TRL and SOLT. The same number of error terms is applied for both Cal Types.

```
"Full <n> Port(x,y,z...)"
```

where

<n> = the number of ports to calibrate

x,y,z = the port numbers to calibrate

For example:

```
"Full 4 Port(1,2,3,4)"
```

For Full Calibrations (including Power Cal):

After the Full <n> port, include the string, "with power"

For example:

```
"Full 4 Port with power(1,2,3,4)"
```

For Response Calibrations:

```
"Response(param)" OR
```

```
"ResponseAndIsolation(param)"
```

Where param =

- S-parameter. For example"
 - ```
"Response (S21) "
```
  - ```
"ResponseAndIsolation (A/R) "
```
- Single or ratioed receivers using either **logical receiver notation** or physical receiver notation. For example:
 - ```
"Response (A) "
```
  - ```
"ResponseAndIsolation (a3/b4) "
```

For Enhanced Response Calibrations:

```
"EnhancedResp(sourcePort, recPort)
```

Where:

- sourcePort = stimulus port number
- recPort = receiver port number

For FCA Calibrations:

[Learn more about this setting.](#)

- **"SMC_2P"** (Response + Input + Output) All four sweeps required. Most accurate.
- **"SMCRsp+IN"** No Output match. All four sweeps required.
- **"SMCRsp+OUT"** No Input match. All four sweeps required.
- **"SMCRsp"** No Input or Output match. Saves two sweeps.

For VMC, multiple Cal types are not available.

For Gain Compression Cal

where r = receive port; s = source port

- "GCA 2P (r,s)" - full 2-port cal
- "GCA Enh Resp (r,s)" - Enhanced Response Cal

Examples

```
CALC:CORR:ERR:TYPE "Scalar Mixer Cal"
```

Query Syntax CALCulate<cnum>:CORRection:ERRor:TYPE?

Return Type String

Default Not Applicable

CALCulate<cnum>:CORRection[:STATe] <bool>

Applicable Models: N522xB, N523xB, N524xB, M937xA, P937xA

(Read-Write) Turns error correction ON or OFF for the selected measurement on the specified channel.

To turn error correction ON or OFF for a channel, use **SENS:CORR:STATe**.

See Critical Note

Parameters

<num> Any existing channel number. If unspecified, value is set to 1

<bool> Correction state. Choose from:

0 - Correction OFF

1 - Correction ON

Examples

```
CALC:CORR ON
```

```
calculate:correction:state off
```

Query Syntax CALCulate<num>:CORRection:STATe?

Return Type Boolean

Default Not Applicable

CALCulate<num>:CORRection[:STATe]:INDicator?

Applicable Models: N522xB, N523xB, N524xB, M937xA, P937xA

(Read-only) Returns the error correction state for the selected measurement on the specified channel.

To turn error correction ON or OFF for a channel, use **SENS:CORR:STATe**.

See Critical Note

Parameters

<num> Any existing channel number. If unspecified, value is set to 1

Examples

```
CALC:CORR:IND?
```

```
calculate2:correction:state:indicator?
```

Return Type Character

NONE - No error correction

MAST (Master) - Original error correction terms

INT - Error terms are interpolated. [Learn more.](#)

DELT - Delta Match calibration terms. [Learn more.](#)

INV - Error terms are not valid

Default NONE

CALCulate<cnum>:CORRection:TYPE <string>

Applicable Models: N522xB, N523xB, N524xB, M937xA, P937xA

(Read-Write) Sets the Cal Type for the selected measurement on the specified channel. This is used when a Cal Set is applied. [Learn more about applying Cal Types.](#)

- Use **SENS:CORR:TYPE:CAT?** to list the Cal Types in the VNA.
- Use **SENS:CORR:CSET:TYPE:CAT?** to list the Cal Types contained in the active Cal Set for the channel.
- Use **SENS:CORR:COLL:METH** to set the Cal type to perform a new Unguided calibration,

See Critical Note

Parameters

<cnum> Any existing channel number. If unspecified, value is set to 1

<string> **(String)** Cal type. Case sensitive. Use one of the following:

For Full Calibrations (NO Power Cal included):

This command does not distinguish between TRL and SOLT. The same number of error terms is applied for both Cal Types.

"Full <n> Port(x,y,z...)"

where

<n> = the number of ports to calibrate

x,y,z = the port numbers to calibrate

For example:

```
"Full 4 Port(1,2,3,4)"
```

For Full Calibrations (including Power Cal):

After the Full <n> port, include the string, "with power"

For example:

```
"Full 4 Port with power(1,2,3,4)"
```

For Response Calibrations:

"Response(param)" OR

"ResponseAndIsolation(param)"

Where param =

- S-parameter. For example"
 - "Response (S21) "
 - "ResponseAndIsolation (A/R) "
- Single or ratioed receivers using either **logical receiver notation** or physical receiver notation. For example:
 - "Response (A) "
 - "ResponseAndIsolation (a3/b4) "

For Enhanced Response Calibrations:

"EnhancedResp(recPort, sourcePort)

Where:

- recPort = receiver port number
- sourcePort = stimulus port number

For FCA Calibrations:

[Learn more about this setting.](#)

- **"SMC_2P"** (Response + Input + Output) All four sweeps required. Most accurate.
- **"SMCRsp+IN"** No Output match. All four sweeps required.
- **"SMCRsp+OUT"** No Output match. All four sweeps required.
- **"SMCRsp"** No Input or Output match. Saves two sweeps.

For VMC, multiple Cal types are not available.

For Gain Compression Cal

where r = receive port; s = source port

- "GCA 2P (r,s)" - full 2-port cal
- "GCA Enh Resp (r,s)" - Enhanced Response Cal

Examples `CALC:CORR:TYPE "Scalar Mixer Cal"`

Query Syntax `CALCulate<cnum>:CORRection:TYPE?`

Return Type String

Default Not Applicable

`CALCulate<cnum>:CORRection:OFFSet[:MAGNitude] <num>` **Superseded**

Applicable Models: N522xB, N523xB, N524xB, M937xA, P937xA

Note: This command is replaced with `SENS:CORR:RPOWer:OFFSet[:AMPLitude]`.
To set data trace magnitude offset, use `CALC:OFFS:MAGN`
This command does NOT function for FCA measurements.

See an example of a Receiver Power Calibration.

(Read-Write)

For Receiver Power Calibration, specifies the power level to which the selected (unratioed) measurement data is to be adjusted. This command applies only when the selected measurement is of unratioed power.

Parameters

- <cnum> Channel number of the measurement. There must be a selected measurement on that channel. If unspecified, <cnum> is set to 1.
- <num> Cal power level in dBm. No limits are enforced on this value, but the VNA receivers themselves have maximum and minimum power specifications (that may differ between VNA models) which this value must comply with for a valid receiver power cal.

Examples `CALC:CORR:OFFS 10DBM`
`calculatel:correction:offset:magnitude maximum`

Query Syntax `CALCulate<cnum>:CORRection:OFFSet[:MAGNitude]?`

Return Type Numeric

Default 0dBm

CALCulate<cnum>:CORRection:OFFSet:PHASe <num>[<char>] **Superseded**

Applicable Models: N522xB, N523xB, N524xB, M937xA, P937xA

Note: This command is replaced with **CALC:OFFS:PHASe**

(Read-Write) Sets the phase offset for the selected measurement.

Parameters

- <cnum> Channel number of the measurement. There must be a selected measurement on that channel. If unspecified, <cnum> is set to 1.
- <num> Offset phase value. Choose any number between: **-360** and **360**
- <char> Units for phase. OPTIONAL. Choose either:
DEG - Degrees (default)
RAD - Radians

Examples

```
CALC:CORR:OFFS:PHAS 10  
calculate:correction:offset:phase 20rad
```

Query Syntax CALCulate:CORRection:OFFSet:PHASe?

Return Type Numeric, returned value always in degrees

Default 0 degrees

Calculate:Custom Commands

Creates and modifies application measurements.

These commands are **Superseded** by the [CALCulate:MEASure:DEFine](#) and [CALCulate:MEASure:PARAmeter](#) commands.

CALCulate:CUSTom:

DEFine

MODify

See Also

- [Example Programs](#)
 - [Synchronizing the Analyzer and Controller](#)
 - [SCPI Command Tree](#)
-

CALCulate<cnum>:CUSTom:DEFine <Mname>, <type> [,param]

Applicable Models: All

(Write-only) Creates a custom measurement depending on the [configurations and options](#). The custom measurement is not automatically displayed. You must also do the following:

- Use [DISP:WIND:STATe](#) to create a window if it doesn't already exist.
- Use [DISP:WIND:TRAC:FEED](#) to display the measurement
- Select the measurement ([CALC:PAR:SEL](#)) before making additional settings.

Parameters

<cnum> Any existing channel number. If unspecified, value is set to 1.

<Mname> Name of the measurement. Any non-empty, unique string, enclosed in quotes.

<type> **(string)** - Choose from the following (click or scroll down to view valid <params> for each type)

- "Standard"

- "Scalar Mixer/Converter"
- "Gain Compression"
- "Noise Figure Cold Source"

[param] (variant) Measurement names to create:

Meas Class	Measurement Name	Description
"Standard"	"S11", "S21", and so forth "A_1", "A_2", and so forth	S-parameter name Unratioed parameter names with notation: "receiver_source port" See Balanced S-parameter measurement names
"Scalar Mixer/Converter"	For input port X and output port Y: "SCXY" "SCYX" "SXX" "SYY" "Ipwr" "RevIPwr" "Opwr" "RevOPwr"	Learn about SMC parameters Note: Input and output ports are set up using the Mixer Setup dialog. If the ports are not set up using the Mixer Setup dialog, then ports 1 and 2 are the default input and output ports and the only ports that can be used.
"Gain Compression" Learn more	GCA : "CompIn21" "CompOut21" "CompGain21" "CompS11" "RefS21" "DeltaGain21"	Input power at the compression point. Output power at the compression point. Gain at the compression point. Input Match at the compression point Linear Gain CompGain21 -Linear Gain

	"S11", "S21", "S12", "S22"	Standard S-parameters; measured at port 1 and port 2
<p>"Noise Figure Cold Source"</p> <p>Learn more</p>	Noise Figure :	
	"NF"	Noise figure
	"ENR"	Validate noise source measurements.
	"T-Eff"	Effective noise temperature.
	"DUTRNP" "DUTRNPI"	DUT noise power ratio. (Noise power expressed in Kelvin divided by 290).
	"SYSRNP" "SYSRNPI"	System noise power ratio
	"DUTNPD" "DUTNPDI"	DUT noise power density. (Noise power expressed in dBm/Hz).
	"SYSNPD" "SYSNPDI"	System noise power density.
	"OvrRng" (Opt 029 Only)	Indication that the noise receiver is being over powered.
	"T-Rcvr" (Opt 029 Only)	Temperature reading (in Kelvin) of the noise receiver board.
	"S11", "S21", "S12", "S22"	Standard S-parameters; measured with the port1 and port2 noise switches set for noise mode.
	"A_1", "A_2" ...and so forth. "GammaOpt" "Rn"	Unratioed parameters; with notation: "receiver, source port" Optimum Complex Reflection Coefficient Noise Resistance

	"NFMin"	Minimum noise figure that occurs at GammaOpt
--	----------------	--

Examples `CALC:CUST:DEF 'My VC21', 'Vector Mixer/Converter', 'S22'`
`calculate2:custom:define 'MyNF', 'NoiseFigure', 'NF'`

Query Syntax Not applicable
Overlapped? No
Default Not applicable

CALCulate<cnum>:CUSTom:MODify <param>

Applicable Models: All

(Write-only) Changes the selected custom measurement to a different parameter. This is dependent upon the **configurations and options**.

See an example using this command for a **VMC** and **SMC** measurement

Parameters

- <cnum> Channel of the custom measurement to be changed. First, select the measurement using **CALC:PAR:SEL**.
- <param> Parameter to change the custom measurement to. Select a parameter that is valid for the type of measurement. Choose from the same arguments as **Calc:Cust:Def**.

Examples `SYST:PRES`
`CALC2:CUST:DEF 'My VC21', 'Vector Mixer/Converter'`
`CALC:PAR:SEL 'My VC21'`
`CALC2:CUST:MOD 'S22'`

Query Syntax Not applicable
Overlapped? No
Default Not applicable

Calculate:Data Commands

Controls writing and reading VNA measurement data.

These commands are **Superseded** by the `CALCulate:MEASure:DATA` commands.

CALCulate:DATA
CUSTom
CATalog?
MFDData?
MSData?
SNP?
PORTs?
SAVE

Click on a **red** keyword to view the command details.

Red is a superseded command.

See Also

- [Example Programs](#)
- [Data Access Map](#)
- [Synchronizing the Analyzer and Controller](#)
- To read receiver data, use `CALC:RDATA?`
- To read error terms, use `SENS:CORR:CSET:DATA`
- To read SnP measurement data, use `CALC:DATA:SNP?`
- [SCPI Command Tree](#)

Critical Note: `CALCulate` commands act on the selected measurement. You can select one measurement for each channel using `Calc:Par:MNUM` or `Calc:Par>Select`. [Learn more](#).

(Write) `CALCulate<cnum>:DATA <char>,<data>`

(Read) `CALCulate<cnum>:DATA? <char>`

Applicable Models: N522xB, N523xB, N524xB, M937xA, P937xA

Reads or writes Measurement data, Memory data, or Normalization Divisor data from the **Data Access Map** location.

- For Measurement data, use FDATA, RDATA, or SDATA
- For Memory data, use FMEM or SMEM. When querying memory, you must first store a trace into memory using **CALC:MATH:MEMorize**.
- For Normalization Divisor (Receiver Power Cal error term) data, use SDIV
- Use **FORMat:DATA** to change the data type (<REAL,32>, <REAL,64> or <ASCii,0>).
- Use **FORMat:BORDer** to change the byte order. Use "NORMal" when transferring a binary block from LabView or Vee. For other programming languages, you may need to "SWAP" the byte order.

Equation Editor Notes:

- When equation editor is active on a trace in a standard S-parameter channel, Calc:Data returns the data from the parameter on the trace that was measured last. For example, for the equation "S22 + S33 + S11", then S33 is the last measured parameter because it uses source port 3.
- In **applications**, if equation editor is active and the original parameter for the trace is not requested anywhere in the channel, then zeros are returned. If the original parameter is being measured within the channel, then data for the original parameter is returned.
- In general, if an equation contains no measurement parameters, then data for the original parameter is returned.

Note: The Calc:Data SCORR command to read / write error terms is **Superseded** with **SENS:CORR:CSET:DATA**. SCORR commands do NOT accommodate greater than 12 error terms.

See **Critical Note**

Parameters

- <num>** Channel number of the measurement. There must be a selected measurement on that channel. If unspecified, <num> is set to 1.
- <char>** **FDATA** Formatted **measurement** data to or from **Data Access Map** location **Display** (access point 2).

Note: When querying FDATA, data is received in degrees. When setting phase using FDATA, the command expects the data in radians.

- Corrected data is returned when correction is ON.
- Uncorrected data is returned when correction is OFF.
- Returns TWO numbers per data point for Polar and Smith Chart format.

- Returns one number per data point for all other formats.
 - Format of the read data is same as the displayed format.
- RDATA** Complex measurement data.
- Writes** data to **Data Access Map** location **Raw Measurement** (access point 0).
- When writing corrected data, and correction is ON, it will be corrected again, resulting in meaningless data (Same behavior as SDATA).
- Reads** data from **Data Access Map** location **Raw Measurement** (access point 0).
- Returns TWO numbers per data point.
 - Returned numbers are uncorrected (regardless of correction state)
- SDATA** Complex measurement data.
- Writes** data to **Data Access Map** location **Raw Measurement** (access point 0).
- When writing corrected data, and correction is ON, it will be corrected again, resulting in meaningless data.
- Reads** data from **Apply Error Terms** (access point 1).
- Returns TWO numbers per data point.
 - Corrected data is returned when correction is ON.
 - Uncorrected data is returned when correction is OFF.
- FMEM** Formatted memory data to or from **Data Access Map** location **Memory result** (access point 4).
- Returns TWO numbers per data point for Polar and Smith Chart format.
 - Returns one number per data point for all other formats.
 - Format of the read data is same as the displayed format.
 - Returned data reflects the correction level (On|OFF) when the data was stored into memory.
- SMEM** Complex measurement data to or from **Data Access Map** location **Memory** (access point 3).

- Returns TWO numbers per data point.
- Returned data reflects the correction level (On|OFF) when the data was stored into memory.
- Returned data reflects the correction level (On|OFF) when the data was stored into memory.

SDIV Complex data from **Data Access Map** location **Normalization (5)**.

- Returns TWO numbers per data point.
- If normalization interpolation is ON and the number of points changes after the initial normalization, the divisor data will then be interpolated.
- When querying the normalization divisor, you must first store a divisor trace using **CALC:NORMAlize[:IMMediate]**.

The following Calc:Data SCORR command to read / write error terms is **Superseded** with **SENS:CORR:CSET:DATA**. These SCORR commands do NOT accommodate greater than 12 error terms.

For 2-Port SOLT and TRL calibrations	Specify this <char>	to get or put this Error Term...
	SCORR1	Forward Directivity
	SCORR2	Forward Source Match
	SCORR3	Forward Reflection Tracking
	SCORR4	Forward Isolation
	SCORR5	Forward Load Match
	SCORR6	Forward Transmission Tracking
	SCORR7	Reverse Directivity
	SCORR8	Reverse Source Match
	SCORR9	Reverse Reflection Tracking
	SCORR10	Reverse Isolation
	SCORR11	Reverse Load Match
	SCORR12	Reverse Transmission Tracking

EXAMPLE

```
CALC:DATA FDATA,Data(x)  
calculate2:data sdata,data(r,i)
```

See another [example](#) using this command.

Return Type: Block data

Default - Not Applicable

CALCulate<cnum>:DATA:CUSTom <name>,<data> **Superseded**

Applicable Models: N522xB, N523xB, N524xB, M937xA, P937xA

Note: This command has been replaced by **CALC:DATA:** which can now be used with all VNA applications.

(Read-Write) Reads or writes data from a custom-named measurement buffer.

See [Critical Note](#)

Parameters

- <cnum> Channel number of the measurement. There must be a selected measurement on that channel. If unspecified, <cnum> is set to 1.
- <name> Name of the buffer to be read or written
- <data> Data to be read or written to the custom buffer. Format as one number per data point.

Examples

```
CALC:DATA:CUST 'VectorResult0',0,1,2,3,4,5 'Write'  
CALC:DATA:CUST? 'VectorResult0' 'Read'
```

Query Syntax CALCulate:DATA:CUSTom? <name>

Return Type Depends on **Form:Data**

Default Not Applicable

CALCulate<cnum>:DATA:CUSTom:CATalog? **Superseded**

Applicable Models: N522xB, N523xB, N524xB, M937xA, P937xA

Note: This command has been replaced by **CALC:DATA:CAT** which can now be used with all VNA applications.

(Read-only) Reads the list of buffer names (comma separated list of string values) available from the selected parameter. Specify the measurement using **CALCulate:PARAmeter:SElect**.

See [Critical Note](#)

Parameters

<cnm> Channel number of the measurement. There must be a selected measurement on that channel. If unspecified, <cnm> is set to 1.

Examples

```
CALC:DATA:CUST:CAT?
```

```
calculate:data:custom:catalog?
```

Return Type

String

Default

Not Applicable

CALCulate<cnm>:DATA:MFDData? <measList>

Applicable Models: N522xB, N523xB, N524xB, E5080A, M948xA, P937xA

(Read-only) Gets the formatted data array of multiple traces (traces-n, m, to l) of the selected channel.

This command gets multiple trace data with one command, while **CALC:MEAS:DATA:FDAT** returns only one trace with one command.

Note: If valid data is not calculated because of the invalid measurement, "1.#QNB" is read out.

Parameters

<cnm> Channel number of the measurement. There must be a selected measurement on that channel. If unspecified, <cnm> is set to 1.

<measList> Trace number. "n, m, l, ..." where n, m, l are 1 to the maximum trace number.

Note: Use comma for separator of trace number.

Examples

```
CALC:DATA:MFD? "1,2"
```

Return Data Block

Type

Default

Not Applicable

CALCulate<cnum>:DATA<data>:MSData? <measList>

Applicable Models: N522xB, N523xB, N524xB, E5080A, M948xA, P937xA

(Read-only) Gets the corrected data array of multiple traces (traces-n, m, to l) of the selected channel.

This command is allows to get several corrected data with one command, while **CALC:MEAS:DATA:SDAT** returns only one corrected data with one command.

Note: If valid data is not calculated because of the invalid measurement, "1.#QNB" is read out.

Parameters

- <cnum> Channel number of the measurement. There must be a selected measurement on that channel. If unspecified, <cnum> is set to 1.
- <measList> Trace number. "n, m, l, ..." where n, m, l are 1 to the maximum trace number.

Note: Use comma for separator of trace number.

Examples

```
CALC:DATA:MSD? "1,2"
```

Return Type Data Block

Default Not Applicable

CALCulate<cnum>:DATA:SNP? <n> **Superseded**

Applicable Models: N522xB, N523xB, N524xB, M937xA, P937xA

Note: This command has been replaced by **CALC:DATA:SNP:PORTs?**

(Read-only) Reads SnP data from the selected measurement. [Learn more about SnP data.](#)

This command is valid **ONLY** with standard S-parameter measurements.

Notes

- This command returns SNP data without header information, and in columns, not in rows as .SnP files. This means that the data returned from this command sends all frequency data, then all Sx1 magnitude or real data, then all Sx1 phase or imaginary data, and so forth.
- To avoid frequency rounding errors, specify **FORM:DATA** <Real,64> or <ASCIi, 0>

See [Critical Note](#)

Parameters

- <cnum> Channel number of the measurement. There must be a selected measurement on that channel. If unspecified, <cnum> is set to 1.
- <n> Amount of data to return. If unspecified, <n> is set to 2. The number you specify must be less than or equal to the number of available ports on the VNA.

Choose from:

1 (S1P) returns 1-Port data for the active measurement if the active measurement is a reflection parameter such as S11 or S22. The behavior is UNDEFINED if the active measurement is a transmission parameter such as an S21.

2 (S2P) returns data for the four 2 port parameters associated with the current measurement. Default. Data that is not available is zero-filled.

3 (S3P) returns data for the nine 3 port parameters associated with the current measurement. Data that is not available is zero-filled.

4 (S4P) returns data for the sixteen 4 port parameters associated with the current measurement. Data that is not available is zero-filled.

SnP data can be output using several data formatting options. See [MMEM:STORe:TRACe:FORMat:SNP](#).

See also [MMEM:STOR <file>.<snp>](#)

Examples

```
CALC:PAR:DEF MyMeasurement, S11
CALC:PAR:SEL MyMeasurement
CALC:DATA:SNP? 1
```

Return Type Depends on [FORMat:DATA](#).

Default Not Applicable

CALCulate<cnum>:DATA:SNP:PORTs? <"x,y,z">[, FAST]

Applicable Models: N522xB, N523xB, N524xB, M937xA, P937xA

Note: This command replaces [CALC:DATA:SNP?](#). This command is more explicit regarding the data to be returned, and works for VNAs with multiport test sets.

(Read-only) Reads SNP data from the selected measurement for the specified ports. [Learn more about SNP data.](#)

This command is valid **ONLY** with standard S-parameter measurements.

Notes

- This command returns SNP data without header information, and in columns, not in rows as .SnP files. This means that the data returned from this command sends all frequency data, then all Sx1 magnitude or real data, then all Sx1 phase or imaginary data, and so forth.
- To avoid frequency rounding errors, specify **FORM:DATA** <Real,64> or <ASCIi, 0>
- Data that is not available is zero-filled.
- For sweeps with a large number of data points, always follow this command with *OPC? [Learn more](#).

See Critical Note

Parameters

<cnum> Channel number of the measurement. There must be a selected measurement on that channel. If unspecified, <cnum> is set to 1.

<"x,y,z"> Comma or space delimited port numbers for which data is requested, enclosed in quotes.

SNP data can be output using several data formatting options. See **MMEM:STORe:TRACe:FORMat:SNP**.

[, FAST] Reduce the saving time

:SENS:CORR:CACH:MODE should be set at ON.

The correction must cover all the ports of the SNP port list.

The active measurement must be a corrected S Parameter defined by the port list for the SNP requests. EG: "S33" is not a proper selected measurement with **CALC:DATA:SNP:PORTS? <1,2>**

Examples

```
CALC:DATA:SNP:PORTS? "1,2,4,5,7" 'read data for these ports
```

Return Type Depends on **FORMat:DATA**

Default Not Applicable

CALCulate<cnum>:DATA:SNP:PORTs:SAVE <"x,y,z">,<"filename">[, FAST]

Applicable Models: N522xB, N523xB, N524xB, M937xA, P937xA

Note: This command replaces **MMEM:STOR sNp**. This command is more explicit regarding the data to be saved, and works for VNAs with multiport test sets.

(Write-only) Saves SNP data from the selected measurement for the specified ports. [Learn more about SNP data.](#)

- The Normal vs Mixed Mode selection is NOT used as it is in the [Choose Ports dialog](#). Instead, data is returned as it is displayed on the trace. If the selected measurement is Mixed Mode (balanced), then balanced data is returned. If the selected measurement is an S-parameter, then S-parameter data is returned.
- This command is valid **ONLY** with the Standard measurement class (NOT applications).
- Data that is not available is zero-filled.
- For sweeps with a large number of data points, always follow this command with *OPC? [Learn more.](#)

See [Critical Note](#)

Parameters

- <cnum> Channel number of the measurement. There must be a selected measurement on that channel. If unspecified, <cnum> is set to 1.
- <"x,y,z"> **String** Comma or space delimited port numbers for which data is requested, enclosed in quotes.
- <filename> **String** Path, filename, and suffix of location to store the SNP data, enclosed in quotes. The suffix is not checked for accuracy. If saving 2 ports, specify "filename.s2p"; If saving 4 ports, specify "filename.s4p.", and so forth.

SNP data can be output using several data formatting options. See [MME:STORe:TRACe:FORMat:SNP](#).

[, FAST] Reduce the saving time

[:SENS:CORR:CACH:MODE](#) should be set at ON.

The correction must cover all the ports of the SNP port list.

The active measurement must be a corrected S Parameter defined by the port list for the SNP requests. EG: "S33" is not a proper selected measurement with [CALC:DATA:SNP:PORTS? <1,2>](#)

Examples

```
CALC:DATA:SNP:PORTs:Save '1,2,4', 'D:\MyData.s3p';*OPC?
```

Return Type

Depends on [FORMat:DATA](#)

Default

Not Applicable

CALCulate<cnum>:MEASure<mnum>:RDATA? <char>

(Read-only) Returns receiver data for the selected measurement. To query measurement data, see [CALC:DATA?](#)

Critical Note: CALCulate commands act on the selected measurement. You can select one measurement for each channel using [Calc:Par:MNUM](#) or [Calc:Par:Select](#). [Learn more.](#)

Parameters

- <cnnum>** Channel number of the measurement. There must be a selected measurement on that channel. If unspecified, <cnnum> is set to 1.
- <mnum>** Measurement number for each measurement. There must be a selected measurement on the trace. If unspecified, <mnum> is set to 1.
- <char>** Choose from any physical receiver in the VNA.

For example: "A"

Also, **REF** - returns data for either R1 or R2 data depending on the source port of the selected measurement.

See the [block diagram](#) showing the receivers in VNA.

Note: Logical receiver notation is NOT allowed with this command. [Learn more.](#)

Example

```
INITiate:CONTinuous OFF
INITiate:IMMediate;*wai
CALC:MEAS:RDATA? A

CALCulate:RDATA? REF
```

Return Type Depends on [FORM:DATA](#) command - Two numbers per data point

Default Not Applicable

Notes:

Generally when you query the analyzer for data, you expect that the number of data values returned will be consistent with the number of points in the sweep.

However, if you query **receiver** data while the instrument is sweeping, the returned values may contain zeros. For example, if your request for receiver data is handled on the 45th point of a 201 point sweep, the first 45 values will be valid data, and the remainder will contain complex zero.

This can be avoided by synchronizing this request with the end of a sweep or putting the channel in hold mode.

[Learn about Unratioed Measurements](#)

CALCulate<cnum>:DTOPology <device>,<topology>

Applicable Models: Multi-port systems with > 4 ports

(Read-Write) Maps the physical VNA ports to a device of balanced and single-ended logical ports for multi-port systems with greater than 4 ports. The device type is selected using

CALCulate:FSIMulator:BALun:DEVice.

See Also:

CALC:FSIM:BAL:PAR:CAT? - returns the list of measurement parameters available for the currently selected topology.

CALC:FSIM:BAL:PAR:CUST:DEFine and **CALC:MEAS:PAR** - defines measurement parameter corresponding to a custom topology for systems where the port count is expandable beyond 4 ports.

Parameters

- <cnum>** Channel number of the measurement. There must be a selected measurement on that channel. If unspecified, <cnum> is set to 1.
- <device>** (String) Device type for the balanced measurement. 'B' means the Balanced port; 'S' means the Single-ended port. Choose from:
- B – 1 port balanced device (2 ports)
 - BB – Balanced - Balanced device (4 ports)
 - BS – Balanced - Single-ended device (3 ports)
 - SB – Single-ended - Balanced device (3 ports)
 - SSB – Single-ended - Single-ended - Balanced device (4 ports)
- <topology>** (Int array) Physical port numbers mapped to the logical ports, separated by ','.
- 'B' (Balanced) requires 2 physical port numbers: <nPos>, <nNeg>.
- 'S' (Single-ended) requires 1 physical port number.

Examples

```
'The following example sets up 6 physical ports into 5 logical ports:  
'Logical port 1 is a single ended port mapped to physical port 1  
'Logical port 2 is a single ended port mapped to physical port 2  
'Logical port 3 is a balanced port mapped to physical ports 4  
and 5  
'Logical port 4 is a single ended port mapped to physical port 3  
'Logical port 5 is a single ended port mapped to physical port 6
```

Example 1

```
CALC:FSIM:BAL:DEV CUST  
CALC:DTOP "SSBSS",1,2,4,5,3,6  
CALC:MEAS:PAR "SDD33"
```

Example 2

```
CALC:PAR:COUN 1  
CALC:FSIM:BAL:DEV CUST  
CALC:FSIM:BAL:PAR:STATE ON  
CALC:DTOPology "SSBSS",1,2,4,5,3,6  
CALC:FSIM:BAL:PAR:CUST:DEF "SDD33"
```

Query Syntax CALCulate<cnun>:DTOPology<device>,<topology>?

Return Type Int array

Default Not Applicable

Calculate:Equation Commands

Controls Equation Editor capabilities.

CALCulate:EQUation:

LIBRARY

| [FUNCTIONS](#)

| [IMPORT?](#)

| [REMOVE](#)

STATE

TEXT

VALID?

Click on a keyword to view the command details.

see Also

- [Example Programs](#)
- [Learn about Equation Editor](#)
- [Synchronizing the Analyzer and Controller](#)
- [SCPI Command Tree](#)

Critical Note: CALCulate commands act on the selected measurement. You can select one measurement for each channel using [Calc:Par:MNUM](#) or [Calc:Par:Select](#). [Learn more.](#)

CALCulate:EQUation:LIBRARY:FUNCTIONS <string>

Applicable Models: All

(Read-only) Returns the functions in the specified DLL.

Parameters

<string> Full path and filename of the *.dll to be read.

Examples

```
functions = CALC:EQU:LIBR:FUNC "C:/Program
Files/Keysight/Network Analyzer/UserFunctions/Expansion.dll"
```

Query Syntax CALCulate:EQUation:LIBRary:FUNCTions?

Return Type Comma delimited string of function names.

Default Not Applicable

CALCulate:EQUation:LIBRary:IMPort <string>

Applicable Models: All

(Read-Write) Imports the functions in the specified DLL and returns whether the functions have been imported into the VNA.

Parameters

<string> Full path and filename of the *.dll.

Examples

```
'Write - Imports functions
CALC:EQU:LIBR:IMPort "C:/Program Files/Keysight/Network
Analyzer/UserFunctions/Expansion.dll"

'Read if Imported

functions = CALC:EQU:LIBR:IMPort "C:/Program
Files/Keysight/Network Analyzer/UserFunctions/Expansion.dll"
```

Query Syntax CALCulate:EQUation:LIBRary:IMPort?

Returns the following:

1 - Imported

0 - NOT imported

Return Type Boolean

Default Not Applicable

CALCulate:EQUation:LIBRARY:REMove <string>

Applicable Models: All

(Write-only) Removes an imported an Equation Editor DLL from the VNA.

Parameters

<string> Full path and filename of the *.dll.

Examples

```
CALC:EQU:LIBR:REM "C:/Program Files/Keysight/Network Analyzer/UserFunctions/Expansion.dll"
```

Query Syntax Not Applicable

Default Not Applicable

CALCulate<cnum>:EQUation[:STATe] <bool>

Applicable Models: All

(Read-Write) Turns ON and OFF the equation on selected measurement for the specified channel. If the equation is not valid, then processing is not performed. Use **CALC:EQUation:VALid?** to ensure that the equation is valid.

See [Critical Note](#)

Parameters

<cnum> Channel number of the measurement. There must be a selected measurement on that channel. If unspecified, <cnum> is set to 1.

<bool> **ON** (or 1) - turns equation ON.

OFF (or 0) - turns equation OFF.

Examples

```
CALC:EQU 1  
calculate2:equation:state 0
```

Query Syntax CALCulate<cnum>:EQUation[:STATe]?

Return Type Boolean

Default OFF (0)

CALCulate<cnum>:EQUation:TEXT <string>

Applicable Models: All

(Read-Write) Specifies an equation or expression to be used on the selected measurement for the specified channel.

See Critical Note

Parameters

<num> Channel number of the measurement. There must be a selected measurement on that channel. If unspecified, <num> is set to 1.

<string> Any valid equation or expression. See Equation Editor.

Examples

```
'Equation (includes '=')
CALC:EQU:TEXT "foo=S11/S21"

'Expression
calculate2:equation:text "S11/S21"
```

Query Syntax CALCulate<num>:EQUation:TEXT?

Return Type String

Default Not Applicable

CALCulate<num>:EQUation:VALid?

Applicable Models: All

(Read-Only) Returns a boolean value to indicate if the current equation on the selected measurement for the specified channel is valid. For equation processing to occur, the equation must be valid and ON (CALC:EQU:STAT 1).

See Critical Note

Parameters

<num> Channel number of the measurement. There must be a selected measurement on that channel. If unspecified, <num> is set to 1.

Examples

```
CALC:EQU:VAL?
calculate2:equation:valid?
```

Return Type Boolean
1 - equation is valid
0 - equation is NOT valid
Default Not Applicable

Calculate:Filter Commands

Controls the gating function used in time domain measurements. The gated range is specified with either (start / stop) or (center / span) commands.

These commands are **Superseded** by the `CALCulate:MEASure:FILTer` commands.

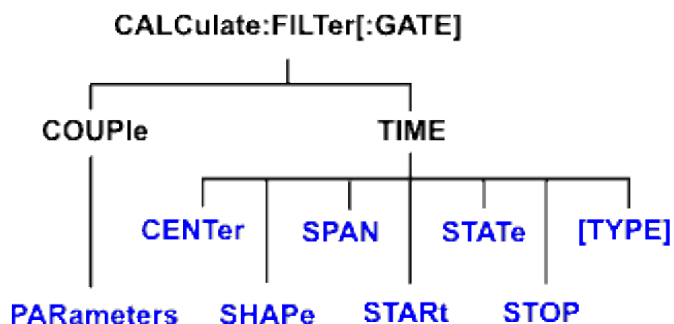

Click on a keyword to view the command details.

see Also

- [Example Programs](#)
- [Learn about Gating](#)
- [Synchronizing the Analyzer and Controller](#)
- [SCPI Command Tree](#)

Critical Note: `CALCulate` commands act on the selected measurement. You can select one measurement for each channel using `Calc:Par:MNUM` or `Calc:Par>Select`. [Learn more](#).

`CALCulate<cnum>:FILTer[:GATE]:COUPlE:PARAmeters <num>`

Applicable Models: N522xB, N523xB, N524xB, M937xA, P937xA

(Read-Write) Specifies the time domain gating parameters to be coupled. The settings for those parameters will be copied from the selected measurement to all other measurements on the channel.

- To enable Trace Coupling, use **SENS:COUP:PAR**
- To specify Transform parameters to couple, use **CALC:TRAN:COUP:PAR**

Learn more about [Time Domain Trace Coupling](#)

See [Critical Note](#)

Parameters

- <num> Channel number of the measurement. There must be a selected measurement on that channel. If unspecified, <num> is set to 1.
- <num> (Numeric) Parameters to couple. To specify more than one parameter, add the numbers.
- 1 - Gating Stimulus (Start, Stop, Center, and Span TIME settings.)
 - 2 - Gating State (ON / OFF)
 - 4 - Gating Shape (Minimum, Normal, Wide, and Maximum)
 - 8 - Gating Type (Bandpass and Notch)

Examples

```
'To couple all parameters:  
CALC:FILT:COUP:PAR 15  
  
'To couple Stimulus and Type:  
calculate2:filter:gate:couple:parameters 9
```

Query Syntax CALCulate<num>:FILTer:GATE:COUPlE:PARAmeters?

Return Type Numeric

Default 13 (All parameters except 2 - Gating State)

CALCulate<num>:FILTer[:GATE]:TIME:CENTer <num>

Applicable Models: N522xB, N523xB, N524xB, M937xA, P937xA

(Read-Write) Sets the gate filter center time.

See Critical Note

Parameters

- <num> Channel number of the measurement. There must be a selected measurement on that channel. If unspecified, <num> is set to 1.
- <num> Center time in seconds; Choose any number between:
 $\pm (\text{number of points}-1) / \text{frequency span}$

Note: This command will accept **MIN** or **MAX** instead of a numeric parameter. See **SCPI Syntax** for more information.

Examples

```
CALC:FILT:GATE:TIME:CENT -5 ns  
calculate2:filter:time:center maximum
```

Query Syntax CALCulate<num>:FILTer[:GATE]:TIME:CENTer?

Return Type Numeric

Default 0

CALCulate<num>:FILTer[:GATE]:TIME:SHAPE <char>

Applicable Models: N522xB, N523xB, N524xB, M937xA, P937xA

(Read-Write) Sets the gating filter shape when in time domain.

See Critical Note

Parameters

- <num> Channel number of the measurement. There must be a selected measurement on that channel. If unspecified, <num> is set to 1.
- <char> Choose from
MAXimum - the widest gate filter available
WIDE -
NORMal -
MINimum - the narrowest gate filter available

Examples

```
CALC:FILT:GATE:TIME:SHAP MAX  
calculate2:filter:time:shape normal
```

Query Syntax CALCulate<num>:FILTer[:GATE]:TIME:SHAPE?

Return Type Character

Default NORMAl

CALCulate<cnum>:FILTer[:GATE]:TIME:SPAN <num>

Applicable Models: N522xB, N523xB, N524xB, M937xA, P937xA

(Read-Write) Sets the gate filter span time.

See Critical Note

Parameters

- <cnum> Channel number of the measurement. There must be a selected measurement on that channel. If unspecified, <cnum> is set to 1.
- <num> Time span in seconds; Choose any number between:
0 and $2 * [(number\ of\ points - 1) / frequency\ span]$

Note: This command will accept **MIN** or **MAX** instead of a numeric parameter. See **SCPI Syntax** for more information.

Examples

```
CALC:FILT:GATE:TIME:SPAN 5 ns  
calculate2:filter:time:span maximum
```

Query Syntax CALCulate<cnum>:FILTer[:GATE]:TIME:SPAN?

Return Type Numeric

Default 20 ns

CALCulate<cnum>:FILTer[:GATE]:TIME:STATe <boolean>

Applicable Models: N522xB, N523xB, N524xB, M937xA, P937xA

(Read-Write) Turns gating state ON or OFF.

See Critical Note

Note: Sweep type must be set to LInear Frequency in order to use Transform Gating.

Parameters

- <cnum> Channel number of the measurement. There must be a selected measurement on that channel. If unspecified, <cnum> is set to 1.
- <boolean> **ON** (or 1) - turns gating ON.
OFF (or 0) - turns gating OFF.

Examples

```
CALC:FILT:TIME:STAT ON  
calculate2:filter:gate:time:state off
```

Query Syntax CALCulate<cnum>:FILTer[:GATE]:TIME:STATe?
Return Type Boolean (1 = ON, 0 = OFF)
Default OFF

CALCulate<cnum>:FILTer[:GATE]:TIME:STARt <num>

Applicable Models: N522xB, N523xB, N524xB, M937xA, P937xA

(Read-Write) Sets the gate filter start time.

See [Critical Note](#)

Parameters

- <cnum> Channel number of the measurement. There must be a selected measurement on that channel. If unspecified, <cnum> is set to 1.
- <num> Start time in seconds; any number between:
 $\pm (\text{number of points}-1) / \text{frequency span}$

Note: This command will accept **MIN** or **MAX** instead of a numeric parameter. See [SCPI Syntax](#) for more information.

Examples

```
CALC:FILT:TIME:STAR 1e-8  
calculate2:filter:gate:time:start minimum
```

Query Syntax CALCulate<cnum>:FILTer[:GATE]:TIME:STARt?
Return Type Numeric
Default 10 ns

CALCulate<cnum>:FILTer[:GATE]:TIME:STOP <num>

Applicable Models: N522xB, N523xB, N524xB, M937xA, P937xA

(Read-Write) Sets the gate filter stop time.

See Critical Note

Parameters

- <num> Channel number of the measurement. There must be a selected measurement on that channel. If unspecified, <num> is set to 1.
- <num> Stop time in seconds; any number between:
 $\pm (\text{number of points}-1) / \text{frequency span}$

Note: This command will accept **MIN** or **MAX** instead of a numeric parameter. See **SCPI Syntax** for more information.

Examples

```
CALC:FILT:TIME:STOP -1 ns  
calculate2:filter:gate:time:stop maximum
```

Query Syntax CALCulate<num>:FILTer[:GATE]:TIME:STOP?

Return Type Numeric

Default 10 ns

CALCulate<num>:FILTer[:GATE]:TIME[:TYPE] <char>

Applicable Models: N522xB, N523xB, N524xB, M937xA, P937xA

(Read-Write) Sets the type of gate filter used.

See Critical Note

Parameters

- <num> Channel number of the measurement. There must be a selected measurement on that channel. If unspecified, <num> is set to 1.
- <char> Choose from:
BPASs - Includes (passes) the range between the start and stop times.
NOTCh - Excludes (attenuates) the range between the start and stop times.

Examples

```
CALC:FILT:TIME BPAS  
calculate2:filter:gate:time:type notch
```

Query Syntax CALCulate<num>:FILTer[:GATE]:TIME[:TYPE]?

Return Type Character

Default BPAS

Calculate:Format Commands

These commands are **Superseded** by the `CALCulate:MEASure:FORMat` commands.

CALCulate:
FORMat
UNIT

Critical Note: CALCulate commands act on the selected measurement. You can select one measurement for each channel using `Calc:Par:MNUM` or `Calc:Par:Select`. [Learn more.](#)

See Also

- [Example](#) using this command.
- [Learn About Data Format](#)
- [Synchronizing the Analyzer and Controller](#)

`CALCulate<num>:FORMat <char>`

Applicable Models: N522xB, N523xB, N524xB, M937xA, P937xA

(Read-Write) Sets the display format for the measurement.

[See Critical Note](#)

Parameters

`<num>` Channel number of the measurement. There must be a selected measurement on that channel. If unspecified, `<num>` is set to 1.

`<char>` Choose from:

- MLINear
- MLOGarithmic
- PHASe
- UPHase 'Unwrapped phase'

- IMAGinary
- REAL
- POLar
- SMITh
- SADMittance 'Smith Admittance
- SWR
- GDElay 'Group Delay
- KELVin
- FAHRenheit
- CELSius
- PPHase 'Positive Phase

Examples

```
CALC:FORM MLIN
calculate2:format polar
```

Query Syntax CALCulate<cnum>:FORMat?

Return Type Character

Default MLINear

CALCulate<cnum>:FORMat:UNIT <dataFormat>, <units>

Applicable Models: N522xB, N523xB, N524xB, M937xA, P937xA

(Read-Write) Sets and returns the units for the specified data format. Measurements with display formats other than those specified are not affected.

See Critical Note

Parameters

<cnum> Channel number of the measurement. There must be a selected measurement on that channel. If unspecified, <cnum> is set to 1.

<dataFormat> Choose from:

- **MLOG** - Log magnitude
- **MLIN** - Linear magnitude

<units> For unratioed MLOG measurements, choose from:

- **DBM** Units are displayed in dBm. 0 dBm = 0.001 watt
- **DBMV** Units are displayed in dBmV. 0 dBmV = 0.001 volt
dBmV value depends on the reference impedance: $\text{dBmV} = \text{dBm} + 30 + 10 \cdot \log_{10}(Z_0)$
- **DBMA** Units are displayed in dBmA. 0 dBmA = 0.001 Ampere
- **DBUV** Units are displayed in dBuV. 0 dBuV = 1 uV
DBuV value depends on the reference impedance: $\text{dBuV} = \text{dBm} + 90 + 10 \cdot \log_{10}(Z_0)$

For unratioed MLIN measurements, choose from:

- **W** -Units are displayed in Watts
- **V** -Units are displayed in Volts
- **A** -Units are displayed in Amperes

Examples

```
CALC:FORM MLOG, DBM  
calculate2:format mlog,dbmv
```

Query Syntax CALCulate<cnum>:FORMat:UNIT? <dataFormat>

Return Type Character

Default MLOG, DBM

Calculate:FSimulator Commands

Specifies settings and fixturing for Balanced Measurements.

CALCulate:FSIMulator

BALun [More commands](#)

EMBed [More commands](#)

GLOop [More commands](#)

SENDEd [More commands](#)

SNP:EXTRapolate

STATE

Click a [keyword](#) to view the command details.

See Also

- [Example Programs](#)
 - [SCPI Command Tree](#)
-

CALCulate<cnum>:FSIMulator:SNP:EXTRapolate <bool>

Applicable Models: All

(Read-Write) Turns ON and OFF SNP file extrapolation for both 2-port and 4-port embedding/de-embedding. [Learn more.](#)

Note: This command affects ALL measurements on the specified channel.

Parameters

<cnum> Channel number of the measurement. There must be a selected measurement on that channel. If unspecified, <cnum> is set to 1.

<bool> Choose from:

ON or 1 - Turns Extrapolation ON

OFF or 0 - Turns Extrapolation OFF

Examples `CALC:FSIM:SNP:EXTR 1`
`calculate2:fsimulator:snp:extrapolate 0`

Query Syntax `CALCulate<cnum>:FSIMulator:SNP:EXTRapolate?`

Return Type Boolean

Default OFF

CALCulate<cnum>:FSIMulator:STATe <bool>

Applicable Models: All

(Read-Write) Turns all three fixturing functions (de-embedding, port matching, impedance conversion) ON or OFF for all ports on the specified channel. Does not affect port extensions.

Note: This command affects ALL measurements on the specified channel.

Parameters

<cnum> Channel number of the measurement. There must be a selected measurement on that channel. If unspecified, <cnum> is set to 1.

<bool> Choose from:

ON or 1 - Turns Fixturing ON

OFF or 0 - Turns Fixturing OFF

Examples `CALC:FSIM:STAT 1`
`calculate2:fsimulator:state 0`

Query Syntax `CALCulate<cnum>:FSIMulator:STATe?`

Return Type Boolean

Default OFF

CALCulate<cnum>:DTOPology <device>, <topology>

Applicable Models: E5080A, M9485A

(Write-only) Defines the device type and the topology for a balanced measurement.

This command will replace the following commands:

`CALC:FSIM:BAL:TOP:SBAL[:PPOR]`

`CALC:FSIM:BAL:TOP:SSB[:PPOR]`

`CALC:FSIM:BAL:TOP:BBAL[:PPOR]`

`CALC:FSIM:BAL:TOP:BALS[:PPOR]`

Parameters

<num> Channel number of the measurement. There must be a selected measurement on that channel. If unspecified, <num> is set to 1.

<device> (String) Device type for the balanced measurement. 'B' means the Balanced port; 'S' means the Single-ended port. Choose from:

B – 1 port balanced device (2 ports)

BB – Balanced - Balanced device (4 ports)

BS – Balanced - Single-ended device (3 ports)

SB – Single-ended - Balanced device (3 ports)

SSB – Single-ended - Single-ended - Balanced device (4 ports)

<topology> (Int array) Physical port numbers mapped to the logical ports, separated by ','.

'B' (Balanced) requires 2 physical port numbers: <nPos>, <nNeg>.

'S' (Single-ended) requires 1 physical port number.

Examples

```
CALC:DTOP "SB", 2, 1, 4
```

```
calculate:dtopology "SB", 2, 1, 4
```

Query Syntax CALCulate<num>:DTOPology <device>, <topology>?

Return Type Not Applicable

Default Not Applicable

Calculate:Function Commands

These commands are **Superseded** by the `CALCulate:MEASure:FUNCtion` commands.

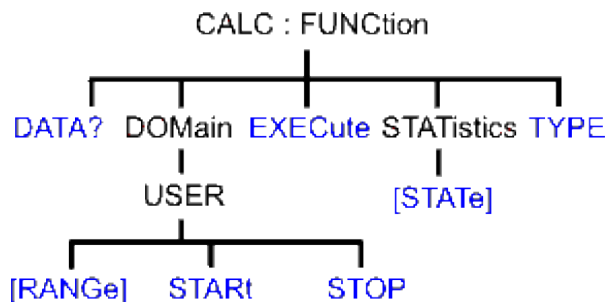

Click on a keyword to view the command details.

see Also

- [Example Programs](#)
- [Learn about Trace Statistics](#)
- [Synchronizing the Analyzer and Controller](#)
- [SCPI Command Tree](#)

Critical Note: `CALCulate` commands act on the selected measurement. You can select one measurement for each channel using `Calc:Par:MNUM` or `Calc:Par:Select`. [Learn more](#).

`CALCulate<cnum>:FUNCtion:DATA?`

Applicable Models: N522xB, N523xB, N524xB, M937xA, P937xA

(Read-only) Returns the trace statistic data for the selected statistic type for the specified channel. Select the type of statistic with **CALC:FUNC:TYPE**.

See Critical Note

Parameters

<num> Channel number of the measurement. There must be a selected measurement on that channel. If unspecified, <num> is set to 1.

Return Type Depends on **FORM:DATA**

Example

```
CALCulate2:FUNCTION:DATA?
```

Default Not applicable

CALCulate<num>:FUNCTION:DOMAIN:USER[:RANGE] <range>

Applicable Models: N522xB, N523xB, N524xB, M937xA, P937xA

(Read-Write) Sets the range used to calculate trace statistics. Each channel has 16 user ranges. The x-axis range is specified with the **CALC:FUNC:DOM:USER:START** and **STOP** commands.

See Critical Note

Parameters

<num> Channel number of the measurement. There must be a selected measurement on that channel. If unspecified, <num> is set to 1.

<range> Range number. Choose from: **0** to **16**

0 is Full Span of the current x-axis range

1 to 16 are user-specified ranges

Examples

```
CALC:FUNC:DOM:USER 4  
calculate2:function:domain:user:range 0
```

Query Syntax CALCulate<num>:FUNCTION:DOMAIN:USER[:RANGE]?

Return Type Numeric

Default 0 - Full Span

CALCulate<num>:FUNCTION:DOMAIN:USER:START <range>, <start>

Applicable Models: N522xB, N523xB, N524xB, M937xA, P937xA

(Read-Write) Sets the start of the specified user-domain range.

To apply this range, use **CALC:FUNC:DOM:USER**

To set the stop of the range, use **CALC:FUNC:DOM:USER:STOP**.

See Critical Note

Note: This command does the same as **CALC:MARK:FUNC:DOM:USER:STAR**

Parameters

- <cnum> Channel number of the measurement. There must be a selected measurement on that channel. If unspecified, <cnum> is set to 1.
- <range> Range number that will receive the start value. Choose an integer between **1** and **16**
- <start> Start value of the specified range. Choose a real number between: the analyzer's **Minimum** and **Maximum** x-axis value.

Examples

```
CALC:FUNC:DOM:USER:STAR 1,1e9  
calculate2:function:domain:user:start 2,2e9
```

Query Syntax CALCulate<cnum>:FUNCTION:DOMAIN:USER:STAR? <range>

Return Type Numeric

Default The analyzer's **Minimum** x-axis value

CALCulate<cnum>:FUNCTION:DOMAIN:USER:STOP <range>, <stop>

Applicable Models: N522xB, N523xB, N524xB, M937xA, P937xA

(Read-Write) Sets the stop value of the specified user-domain range.

To apply this range, use **CALC:FUNC:DOM:USER**.

To set the start of the range, use **CALC:FUNC:DOM:USER:START**

See Critical Note

Note: This command does the same as **CALC:MARK:FUNC:DOM:USER:STOP**

Parameters

- <cnum> Channel number of the measurement. There must be a selected measurement on that channel. If unspecified, <cnum> is set to 1.

<range> Range number that will receive the stop value. Choose an integer between **1** and **16**

<stop> Stop value of the specified range. Choose a real number between: the analyzer's **Minimum** and **Maximum** x-axis value.

Examples

```
CALC:FUNC:DOM:USER:STOP 4,5e9  
calculate2:function:domain:user:stop 3,8e9
```

Query Syntax CALCulate<cnum>:FUNCTION:DOMAIN:USER:STOP? <range>

Return Type Numeric

Default The analyzer's **Maximum** x-axis value

CALCulate<cnum>:FUNCTION:EXECute

Applicable Models: N522xB, N523xB, N524xB, M937xA, P937xA

(Write-only) For the active trace of specified channel, executes the statistical analysis specified by the **CALC:FUNC:TYPE** command.

See [Critical Note](#)

Parameters

<cnum> Channel number of the measurement. There must be a selected measurement on that channel. If unspecified, <cnum> is set to 1.

Examples

```
CALC:FUNC:EXEC  
calculate2:function:execute
```

Query Syntax Not Applicable

Default Not Applicable

CALCulate<cnum>:FUNCTION:STATistics[:STATe] <ON|OFF>

Applicable Models: N522xB, N523xB, N524xB, M937xA, P937xA

(Read-Write) Displays and hides the trace statistics (peak-to-peak, mean, standard deviation) on the screen.

The analyzer will display either measurement statistics or Filter Bandwidth statistics; not both.

See Critical Note

Parameters

<num> Channel number of the measurement. There must be a selected measurement on that channel. If unspecified, <num> is set to 1.

<ON|OFF> ON - Displays trace statistics

OFF - Hides trace statistics

Examples

```
CALC:FUNC:STAT ON  
calculate2:function:statistics:state off
```

Query Syntax CALCulate<num>:FUNCTION:STATistics[:STATE]?

Return Type Boolean (1 = ON, 0 = OFF)

Default OFF (0)

CALCulate<num>:FUNCTION:TYPE <char>

Applicable Models: N522xB, N523xB, N524xB, M937xA, P937xA

(Read-Write) Sets statistic TYPE that you can then query using CALC:FUNCTION:DATA?.

Note: This command affects only the selected measurement on the specified channel.

See Critical Note

Parameters

<num> Channel number of the measurement. There must be a selected measurement on that channel. If unspecified, <num> is set to 1.

<char> Choose from:

PTPeak - the difference between the max and min data points on the trace.

STDEV - standard deviation of all data points on the trace

MEAN - mean (average) of all data points on the trace

MIN - lowest data point on the trace

MAX - highest data point on the trace

Examples

```
CALC:FUNC:TYPE PTP  
calculate2:function:type stdev
```

Query Syntax CALCulate<num>:FUNCTION:TYPE?

Return Type Character

Default PTPeak

Calc:GCData Commands

Reads Gain Compression data from the current Gain Compression acquisition.

These commands are **Superseded** by the [CALCulate:MEASure:GCData](#) commands.

CALCulate:GCData:

[DATA?](#)

[IMAG?](#)

[ITERations?](#)

[REAL?](#)

Click on a keyword to view the command details.

Other Gain Compression commands

The calibration commands listed in this topic are supplemental to the Guided Cal commands.

- [CALC:CUSTom:DEFine](#) - creates a gain compression measurement.
- [SENS:GCSetup](#) - Most Gain Compression settings.
- [CALC:GCMeas:ANAL](#) - Gain Compression Analysis settings
- Gain compression data can also be saved to a *.csv file. [Learn how.](#)

See Also

- [Example Programs](#)
- [Learn about Gain Compression Application](#)
- [Synchronizing the Analyzer and Controller](#)
- [SCPI Command Tree](#)

CALCulate<ch>:GCData:DATA? <param>

Applicable Models: N522xB, N524xB, M9485A, E5080A

(Read-Only) Returns measurement data at all frequency and power data points for GCA SMART sweeps and 2D sweeps.

- When using SMART sweep, ALL data is returned including ALL background iteration sweeps. Use [CALC:GCD:ITER](#) to determine the number of iteration sweeps. The number of data points that are returned is always going to be number of frequency points times the number of iteration sweeps.
- When using 2D sweeps, ALL data is returned. The number of data points returned / freq may vary. [Learn more.](#)

Use [Calc:Data?](#) to return just the displayed data results (not the background sweeps).

A compression parameter must be present. [Learn more.](#)

The format of the data is the same as the format of the measurement that you select using [Calc:Par:Select](#). If the measurement is scalar, than one number is returned per sweep per data point. If complex (such as Smith Chart format) than both real and imaginary numbers are returned.

If correction is on, corrected data are returned. Otherwise, raw data are returned.

Parameters

- <ch> Any existing channel number. If unspecified, value is set to 1
- <param> (String) Parameter to read. NOT Case-sensitive. The specified parameter need NOT be displayed or selected. However, a compression parameter must be present. [Learn more.](#)

Choose from:

- **"pin"** - (CompIn21) Input power at the compression point.
- **"pout"** - (CompOut21) Output power at the compression point.
- **"gain"** - (CompGain21) Device gain (S21) at the compression point.
- **"inputmatch"** - (CompS11) Input match at the compression point.
- **"DeltaGain"** - (DeltaGain21) Measured Gain (watts) / Ref Gain (watts). [Learn more.](#)
- **"AI1"** and **"AI2"** - ADC measurements at the specified compression level. [Learn more.](#)

[Learn more about GCA parameters.](#)

Examples

```
data = CALC:GCD:DATA? "pin"
data = calculate:gcddata:data? "pout"
```

Return Type Array of data

Default Not Applicable

CALCulate<ch>:GCDData:IMAG? <char>, <dpoint>, <param>

Applicable Models: N522xB, N524xB, M9485A, E5080A

(Read-Only) For a specified data point, returns the imaginary part of the specified Gain Compression data. If correction is on, corrected data are returned. Otherwise, raw data are returned. Can be used with Smart and 2D sweeps.

- For SMART sweep, the number of data points that are returned is always going to be the number of iteration sweeps. Use **CALC:GCD:ITER** to determine the number of iteration sweeps.
- For 2D sweeps, the number of data points returned / freq may vary. [Learn more.](#)

Parameters

- <ch> Any existing channel number. If unspecified, value is set to 1
- <char> Choose from:
- **FREQUENCY** - for the specified frequency data point, returns all of the measured data for each power stimulus.
 - **POWer** - for the specified power data point, returns all of the measured data for each frequency stimulus.
- <dPoint> Data point (FREQ or POWer) for which data is returned.
- <param> (String) Parameter to read. NOT Case-sensitive. The specified parameter need NOT be displayed. However, a compression parameter must be present. [Learn more.](#)
- **"pin"** - (CompIn21) Input power at the compression point.
 - **"pout"** - (CompOut21) Output power at the compression point.
 - **"gain"** - (CompGain21) Device gain (S21) at the compression point.
 - **"inputmatch"** - (CompS11) Input match at the compression point.
 - **"DeltaGain"** - (DeltaGain21) Measured Gain (watts) / Ref Gain (watts). [Learn more.](#)
 - **"AI1"** and **"AI2"** - ADC measurements at the specified compression level. [Learn more.](#)

Examples

For the fifth frequency data point, returns 'Power Output' imaginary (phase) data from all power stimulus values.

For SmartSweep, if there are 30 power sweep points, 30 values are returned.

For 2D sweeps, 30 or 31 power sweep points may be returned. [Learn more.](#)

```
data = CALC:GCD:IMAG? FREQ,5,"pout"
```

Return Type Array of data

Default Not Applicable

CALCulate<cnum>:GCDData:ITERations?

Applicable Models: N522xB, N524xB, M9485A, E5080A

(Read-only) In a SMART sweep, returns the max number of iterations that it took for ALL frequencies to converge. Use this number to determine the size of the block data that is returned from Gain Compression SMART sweep data queries.

For a 2D sweep, returns the number of power points.

Parameters

<cnum> Channel number of the measurement. There must be a selected measurement on that channel. If unspecified, <cnum> is set to 1.

Examples

```
data = CALC:GCD:ITER?
```

Return Type Numeric

Default Not Applicable

CALCulate<ch>:GCDData:REAL? <char>, <dpoint>, <param>

Applicable Models: N522xB, N524xB, M9485A, E5080A

(Read-Only) For a specified data point, returns the real part of the Gain Compression data. If correction is on, corrected data are returned. Otherwise, raw data are returned. Can be used with Smart and 2D sweeps.

- For SMART sweep, the number of data points that are returned is always going to be the number of iteration sweeps. Use **CALC:GCD:ITER** to determine the number of iteration sweeps.
- For 2D sweeps, the number of data points returned / freq may vary. [Learn more.](#)

Parameters

<ch> Any existing channel number. If unspecified, value is set to 1
<char> Choose from:

- **FREQuency** - for the specified frequency data point, returns all of the measured

data for each power stimulus.

- **POWer** - for the specified power data point, returns all of the measured data for each frequency stimulus.

<dPoint> Data point (FREQ or POWer) for which data is returned.

<param> (String) Parameter to read. NOT Case-sensitive. The specified parameter need NOT be displayed. However, a compression parameter must be present. [Learn more](#).

- **"pin"** - (CompIn21) Input power at the compression point.
- **"pout"** - (CompOut21) Output power at the compression point.
- **"gain"** - (CompGain21) Device gain (S21) at the compression point.
- **"inputmatch"** - (CompS11) Input match at the compression point.
- **"DeltaGain"** - (DeltaGain21) Measured Gain (watts) / Ref Gain (watts). [Learn more](#).
- **"AI1"** and **"AI2"** - ADC measurements at the specified compression level. [Learn more](#).

Examples For the fifth frequency data point, returns 'Power Output' real data from all power stimulus values.

For SmartSweep, if there are 30 power sweep points, 30 values are returned.

For 2D sweeps, 30 or 31 power sweep points may be returned. [Learn more](#).

```
data = CALC:GCD:REAL? FREQ,5,"pout"
```

Return Type Array of data

Default Not Applicable

Gain Compression Analysis Commands

Sets and reads Gain Compression Analysis controls.

These commands are **Superseded** by the `CALCulate:MEASure:GCMeas` commands.

`CALCulate:GCMeas:ANALysis`

[CWFRequency](#)

[ENABle](#)

[ISDisfreq](#)

[XAXis](#)

Click on a keyword to view the command details.

Other Gain Compression commands

The calibration commands listed in this topic are supplemental to the Guided Cal commands.

- [CALC:CUSTom:DEFine](#) - creates a gain compression measurement.
- [SENS:GCSetup](#) - Most Gain Compression settings.
- [GC:DATA](#) - Gain Compression data commands
- Gain compression data can also be saved to a *.csv file. [Learn how.](#)

See Also

- [Example Programs](#)
- [Learn about Compression Analysis](#)
- [Synchronizing the Analyzer and Controller](#)
- [SCPI Command Tree](#)

`CALCulate<cnum>:GCMeas:ANALysis:ENABle <bool>`

Applicable Models: N522xB, N524xB, M9485A, E5080A

(Read-Write) Enables and disables a compression analysis trace.

Parameters

- <cnm> Channel number of the GCA measurement. There must be a selected measurement on that channel using **Calc:Par:Sel**. If unspecified, <cnm> is set to 1.
- <bool> **ON** (or 1) - Enable compression analysis.
OFF (or 0) - Disable compression analysis.

Examples

```
CALC:GCM:ANAL:ENAB ON  
calculate2:gcmeas:analysis:enable off
```

Query Syntax CALCulate<cnm>:GCMeas:ANALysis:ENABLE?

Return Type Boolean (1 = ON, 0 = OFF)

Default OFF

CALCulate<cnm>:GCMeas:ANALysis:CWFRequency <num>

Applicable Models: N522xB, N524xB, M9485A, E5080A

(Read-Write) Set and return the CW frequency for a compression analysis trace.

Parameters

- <cnm> Channel number of the GCA measurement. There must be a selected measurement on that channel using **Calc:Par:Sel**. If unspecified, <cnm> is set to 1.
- <num> CW frequency in Hz. Choose a frequency within the range of the gain compression channel.

Examples

```
CALC:GCM:ANAL:CWFR 1e9  
calculate2:gcmeas:analysis:cwfrequency 1e10
```

Query Syntax CALCulate<cnm>:GCMeas:ANALysis:CWFRequency?

Return Type Numeric

Default Not Applicable

CALCulate<cnm>:GCMeas:ANALysis:DISCcrete | ISD[:STATe] <bool>

Applicable Models: N522xB, N524xB, M9485A, E5080A

(Read-Write) Sets and returns whether the CW frequency for the compression analysis trace can be set to only the discrete frequencies or provides interpolation.

Parameters

- <cnum> Channel number of the GCA measurement. There must be a selected measurement on that channel using **Calc:Par:Sel**. If unspecified, <cnum> is set to 1.
- <bool> **ON** (or 1) - Discrete data points only.
OFF (or 0) - Interpolated data points.

Examples

```
CALC:GCM:ANAL:ISD ON  
calculate2:gcmeas:analysis:isdisfrequency off
```

Query Syntax CALCulate<cnum>:GCMeas:ANALysis:ISDisfrequency?

Return Type Boolean (1 = ON, 0 = OFF)

Default OFF

CALCulate<cnum>:GCMeas:ANALysis:XAXis <char>

Applicable Models: N522xB, N524xB, M9485A, E5080A

(Read-Write) Sets and returns the type of data to display on the x-axis of a compression analysis trace.

Parameters

- <cnum> Channel number of the GCA measurement. There must be a selected measurement on that channel using **Calc:Par:Sel**. If unspecified, <cnum> is set to 1.
- <bool> Data to display on X-axis. Choose from:
 - **PIN** - Input power to the DUT.
 - **PSource** - power from the source.

Examples

```
CALC:GCM:ANAL:XAX PIN  
calculate2:gcmeas:analysis:xaxis psource
```

Query Syntax CALCulate<cnum>:GCMeas:ANALysis:XAXis?

Return Type Character

Default PIN



Group Delay Aperture Commands

Controls the Aperture setting used to make Group Delay measurements.

These commands are **Superseded** by the `CALCulate:MEASure:GDELay` commands.

CALCulate:GDELay
FREQuency
PERCent
POINts

Click on a keyword to view the command details.

see Also

- [Learn about Group Delay Aperture](#)
- [Example Programs](#)
- [Synchronizing the Analyzer and Controller](#)
- [SCPI Command Tree](#)

Critical Note: CALCulate commands act on the selected measurement. You can select one measurement for each channel using `Calc:Par:MNUM` or `Calc:Par>Select`. [Learn more](#).

`CALCulate<cnum>:GDELay:FREQuency <value>`

Applicable Models: N522xB, N523xB, N524xB, M937xA, P937xA

(Read-Write) Sets group delay aperture using a fixed frequency range.

[See Critical Note](#)

Parameters

- `<cnum>` Channel number of the measurement. There must be a selected measurement on that channel. If unspecified, `<cnum>` is set to 1.
- `<value>` Frequency range (in Hz) to use for the aperture setting. Choose between the equivalent of two data points and the channel frequency span.

Examples

```
CALC:GDEL:FREQ 1E6
```

Query Syntax `CALCulate<cnum>:GDELay:FREQuency?`

Return Type Numeric

Default Frequency range that equates to 11 points. This can be changed to two points with a [preference setting](#).

CALCulate<cnum>:GDElay:PERCent <value>

Applicable Models: N522xB, N523xB, N524xB, M937xA, P937xA

(Read-Write) Sets group delay aperture using a percent of the channel frequency span.

See [Critical Note](#)

Parameters

<cnum> Channel number of the measurement. There must be a selected measurement on that channel. If unspecified, <cnum> is set to 1.

<value> Percent of frequency span to use for the aperture setting. Choose between the equivalent of two data points and 100 percent of the channel frequency span.

Examples

```
'set to 25 percent of the channel frequency span
```

```
CALC:GDEL:PERC 25
```

Query Syntax CALCulate<cnum>:GDElay:PERCent?

Return Type Numeric

Default Percent of frequency span that equates to 11 points. This can be changed to two points with a [preference setting](#).

CALCulate<cnum>:GDElay:POINts <value>

Applicable Models: N522xB, N523xB, N524xB, M937xA, P937xA

(Read-Write) Sets group delay aperture using a fixed number of data points.

See Critical Note

Parameters

<num> Channel number of the measurement. There must be a selected measurement on that channel. If unspecified, <num> is set to 1.

<value> Number of data points to use for the aperture setting. Choose between two points and the number of points in the channel.

Examples

```
'set to 25 data points
```

```
CALC:GDEL:POIN 25
```

Query Syntax CALCulate<num>:GDElay:POINTs?

Return Type Numeric

Default 11 points. This can be changed to two points with a [preference setting](#).

Calc:Limit Commands

Controls the limit segments used for pass / fail testing.

These commands are **Superseded** by the `CALCulate:MEASure:LIMit` commands.

CALCulate:LIMit:

- DATA**
 - | **DELeTe**
- DISPlay**
 - | **[STATe]**
- FAIL?**
- REPort**
 - | **ALL?**
 - | **DATA?**
 - | **POINTs?**
- SEGment**
 - | **AMPLitude**
 - | **START**
 - | **STOP**
 - | **COUNT?**
 - | **STIMulus**
 - | **START**
 - | **STOP**
 - | **TYPE**
- SOUNd**
 - | **[STATe]**

[STATe]

Click on a keyword to view the command details.

see Also

- [Example Programs](#)
- [Learn about Limit Lines](#)
- [Synchronizing the Analyzer and Controller](#)
- [SCPI Command Tree](#)

Critical Note: CALCulate commands act on the selected measurement. You can select one measurement for each channel using [Calc:Par:MNUM](#) or [Calc:Par:Select](#). [Learn more.](#)

CALCulate<cnum>:LIMit:DATA <block>

Applicable Models: N522xB, N523xB, N524xB, M937xA, P937xA

(Read-Write) Sets data for limit segments.

[See Critical Note](#)

Parameters

<cnum> Channel number of the measurement for which limit lines are to be set. There must be a selected measurement on that channel. If unspecified, <cnum> is set to 1.

<block> Data for all limit segments in REAL,64 format. The following is the data format for 1 segment:

Type,BegStim, EndStim, BegResp,EndResp

Type Type of limit segment. Choose from
0 - Off
1 - Max
2 - Min

BegStim Start of X-axis value (freq, power, time)

EndStim End of X-axis value

BegResp Y-axis value that corresponds with Start of X-axis value

EndResp Y-axis value that corresponds with End of X-axis value

Examples

The following writes three max limit segments for a bandpass filter.

```
CALC:LIM:DATA 1,3e5,4e9,-60,0,1,4e9,7.5e9,0,0,1,7.5e9,9e9,0,-30
```

Query Syntax CALCulate<cnum>:LIMit:DATA?

Return Type Depends on **FORM:DATA** - All 100 predefined limit segments are returned.

Default 100 limit segments - all values set to 0

CALCulate<cnum>:LIMit:DATA:DELeTe

Applicable Models: N522xB, N523xB, N524xB, M937xA, P937xA

(Write-only) Deletes all limit line data for the selected measurement on the specified channel.

See Critical Note

Parameters

<cnum> Channel number of the measurement. There must be a selected measurement on that channel. If unspecified, <cnum> is set to 1.

Examples

```
CALC2:LIM:DATA:DEL
```

Query Syntax Not Applicable

Default Not Applicable

CALCulate<cnum>:LIMit:DISPlay[:STATe] <ON | OFF>

Applicable Models: N522xB, N523xB, N524xB, M937xA, P937xA

(Read-Write) Turns the display of limit segments ON or OFF (if the data trace is turned ON).

See Critical Note

Parameters

<cnum> Channel number of the measurement. There must be a selected measurement on that channel. If unspecified, <cnum> is set to 1.

<ON | OFF> **ON** (or 1) - turns the display of limit segments ON.
OFF (or 0) - turns the display of limit segments OFF.

Examples

```
CALC:LIM:DISP:STAT ON  
calculate2:limit:display:state off
```

Query Syntax CALCulate<cnum>:LIMit:DISPlay[:STATe]?

Return Type Boolean (1 = ON, 0 = OFF)

Default ON

CALCulate<cnum>:LIMit:FAIL?

Applicable Models: N522xB, N523xB, N524xB, M937xA, P937xA

(Read-only) Returns the Pass / Fail status of the limit line test. Returns 1 (Fail) if any data point fails for any limit segment.

Limit display (CALC:LIM:DISP) does NOT have to be ON.

See Critical Note

Parameters

<cnun> Channel number of the measurement. There must be a selected measurement on that channel. If unspecified, <cnun> is set to 1.

Examples

CALC:LIM:FAIL?

Return Type Boolean

- 0 is returned when **Pass**
- 1 is returned when **Fail**

Default Not Applicable

CALCulate<cnun>:LIMit:REPort:ALL? <block>

Applicable Models: N522xB, N523xB, N524xB

(Read-only) Reads the bandwidth test results (stimulus value, limit test result, upper limit value and lower limit value of all measurement points), for the active trace of selected channel.

See Critical Note

Parameters

<cnun> Channel number of the measurement. There must be a selected measurement on that channel. If unspecified, <cnun> is set to 1.

<block> Depends on **FORM:DATA**

If the number of the measurement points is N,

<Block> = <first stimulus>,<test result>,<upper limit>,<lower limit>, ..., <Nth stimulus>,<test result>,<upper limit>,<lower limit>

Where <test result>= -1: No limit, 0:Fail, 1:Pass

Examples

CALC:LIM:REP:ALL?

Return Type Variant

Default Depend on the preset status

CALCulate<cnum>:LIMit:REPort[:DATA]? <block>

Applicable Models: N522xB, N523xB, N524xB

(Read-only) Reads the stimulus values (frequency, power level or time) at all the measurement points that failed the limit test, for the active trace of selected channel.

See Critical Note

Parameters

<cnum> Channel number of the measurement. There must be a selected measurement on that channel. If unspecified, <cnum> is set to 1.

<block> Depends on FORM:DATA

If the number of the measurement points that failed the limit test is N, <block>=<First failed stimulus>, ..., <Nth failed stimulus>.

Examples **CALC:LIM:REP:DATA?**

Return Type Numeric

Default 9.91E37

CALCulate<cnum>:LIMit:REPort:POINTs?

Applicable Models: N522xB, N523xB, N524xB

(Read-only) Reads the number of the measurement points that failed the limit test, for the active trace of selected channel.

See Critical Note

Parameters

<cnum> Channel number of the measurement. There must be a selected measurement on that channel. If unspecified, <cnum> is set to 1.

Examples **CALC:LIM:REP:POIN?**

Query Numeric

Syntax

Default 0

CALCulate<cnum>:LIMit:SEGMENT<snum>:AMPLitude:START <num>

Applicable Models: N522xB, N523xB, N524xB, M937xA, P937xA

(Read-Write) Sets the start (beginning) of the Y-axis amplitude (response) value.

See Critical Note

Parameters

- <num> Channel number of the measurement. There must be a selected measurement on that channel. If unspecified, <num> is set to 1.
- <snum> Segment number; if unspecified, value is set to 1.
- <num> Choose any number between: **-500** and **500**

Display value is limited to the Maximum and Minimum displayed Y-axis values.

Examples

```
CALC:LIM:SEGM1:AMPL:STAR 10  
calculate2:limit:segment2:amplitude:start 10
```

Query Syntax CALCulate<cnum>:LIMit:SEGment<snum>AMPLitude:STARt?

Return Type Numeric

Default 0

CALCulate<cnum>:LIMit:SEGment<snum>:AMPLitude:STOP <num>

Applicable Models: N522xB, N523xB, N524xB, M937xA, P937xA

(Read-Write) Sets the stop (end) of the Y-axis amplitude (response) value.

See Critical Note

Parameters

- <num> Channel number of the measurement. There must be a selected measurement on that channel. If unspecified, <num> is set to 1.
- <snum> Segment number; if unspecified, value is set to 1.
- <num> Choose any number between: **-500** and **500**

Display value is limited to the Maximum and Minimum displayed Y-axis values.

Examples

```
CALC:LIM:SEGM1:AMPL:STOP 10  
calculate2:limit:segment2:amplitude:stop 10
```

Query Syntax CALCulate<cnum>:LIMit:SEGment<snum>AMPLitude:STOP?

Return Type Numeric

Default 0

CALCulate<cnum>:LIMit:SEGMENT:COUNT?

Applicable Models: N522xB, N523xB, N524xB, M937xA, P937xA

(Read-only) Returns the number of segments used in a limit test. All segments are counted, whether they are on or not.

Parameters Not Applicable

<cnum> Channel number of the measurement. There must be a selected measurement on that channel. If unspecified, <cnum> is set to 1.

Examples `CALC:LIM:SEGM:COUN?`

Return Type Numeric

Default Not Applicable

CALCulate<cnum>:LIMit:SEGMENT<snum>:STIMulus:STARt <num>

Applicable Models: N522xB, N523xB, N524xB, M937xA, P937xA

(Read-Write) Sets the start (beginning) of the X-axis stimulus value.

See Critical Note

Parameters

<cnum> Channel number of the measurement. There must be a selected measurement on that channel. If unspecified, <cnum> is set to 1.

<snum> Segment number; if unspecified, value is set to 1.

<num> Choose any number within the X-axis span of the analyzer.

Examples `CALC:LIM:SEGM1:STIM:STAR 10`
`calculate2:limit:segment2:stimulus:start 10`

Query Syntax CALCulate<cnum>:LIMit:SEGMENT<snum>STIMulus:STARt?

Return Type Numeric

Default 0

CALCulate<cnum>:LIMit:SEGMENT<snum>:STIMulus:STOP <num>

Applicable Models: N522xB, N523xB, N524xB, M937xA, P937xA

(Read-Write) Sets the stop (end) of the X-axis stimulus value.

See Critical Note

Parameters

- <num> Channel number of the measurement. There must be a selected measurement on that channel. If unspecified, <num> is set to 1.
- <snum> Segment number; if unspecified, value is set to 1.
- <num> Choose any number within the X-axis span of the analyzer.

Examples

```
CALC:LIM:SEGM1:AMPL:STOP 10  
calculate2:limit:segment2:stimulus:stop 10
```

Query Syntax CALCulate<num>:LIMit:SEGMent<snum>STIMulus:STOP?

Return Type Numeric

Default 0

CALCulate<num>:LIMit:SEGMent<snum>:TYPE <char>

Applicable Models: N522xB, N523xB, N524xB, M937xA, P937xA

(Read-Write) Sets the type of limit segment.

See Critical Note

Parameters

- <num> Channel number of the measurement. There must be a selected measurement on that channel. If unspecified, <num> is set to 1.
- <snum> Segment number. Choose any number between:
1 and **100**
If unspecified, value is set to 1.
- <char> Choose from:
LMAX - a MAX limit segment. Any response data exceeding the MAX value will fail.
LMIN - a MIN limit segment. Any response data below the MIN value will fail.
OFF - the limit segment (display and testing) is turned OFF.

Examples

```
CALC:LIM:SEGM:TYPE LMIN
calculate2:limit:segment3:type lmax
```

Query Syntax CALCulate<cnum>:LIMit:SEGMent<snum>:TYPE?

Return Type Character

Default OFF

CALCulate<cnum>:LIMit:SOUNd[:STATe] <ON | OFF>

Applicable Models: N522xB, N523xB, N524xB, M937xA, P937xA

(Read-Write) Turns limit testing fail sound ON or OFF.

See Critical Note

Parameters

<cnum> Channel number of the measurement. There must be a selected measurement on that channel. If unspecified, <cnum> is set to 1.

<ON | OFF> **ON** (or 1) - turns sound ON.
OFF (or 0) - turns sound OFF.

Examples

```
CALC:LIM:SOUN ON
calculate2:limit:sound:state off
```

Query Syntax CALCulate<cnum>:LIMit:SOUNd[:STATe]?

Return Type Boolean (1 = ON, 0 = OFF)

Default OFF

CALCulate<cnum>:LIMit[:STATe] <ON | OFF>

Applicable Models: N522xB, N523xB, N524xB, M937xA, P937xA

(Read-Write) Turns limit segment **testing** ON or OFF.

- Use **CALC:LIM:DISP** to turn ON and OFF the **display** of limit segments.
- If using **Global Pass/Fail** status, trigger the VNA AFTER turning Limit testing ON.

See Critical Note

Parameters

<num> Channel number of the measurement. There must be a selected measurement on that channel. If unspecified, <num> is set to 1.

<ON | OFF> **ON** (or 1) - turns limit testing ON.
OFF (or 0) - turns limit testing OFF.

Examples

```
CALC:LIM:STAT ON  
calculate2:limit:state off
```

Query Syntax CALCulate<num>:LIMit:STATe?

Return Type Boolean (1 = ON, 0 = OFF)

Default OFF

Calculate:Marker Commands

Controls the marker settings used to remotely output specific data to the computer.

These commands are **Superseded** by the `CALCulate:MEASure:MARKer` commands.

CALCulate:MARKer:

AOFF

BUCKet

BWIDTH

COMPression

| **LEVel**

| **PIN?**

| **POUT?**

COUPling

| **METHod**

| **[STATe]**

DELTA

DIScrete

DISTance

FORMat

FUNction

| **APEak**

| **EXCursion**

| **THReshold**

| **DOMain**

| **USER**

| **STARt**

| **STOP**

| **EXECute**

| **[SElect]**

| **TRACking**

PNOP more commands

PSATuration more commands

REFerence

| **[STATe]**

| **X**

| **Y?**

SET

[STATe]

TARGet

TYPE

X

Y?

Click on a keyword to view the command details.

See Also

- [Marker example program](#)
- Marker Readout [number](#) and [size](#) commands.
- [Learn about Markers](#)
- [Synchronizing the Analyzer and Controller](#)
- [SCPI Command Tree](#)

Critical Note: CALCulate commands act on the selected measurement. You can select one measurement for each channel using [Calc:Par:MNUM](#) or [Calc:Par:Select](#). [Learn more.](#)

Important: Learn about [programming the reference marker](#).

CALCulate<cnum>:MARKer:AOff

Applicable Models: N522xB, N523xB, N524xB, M937xA, P937xA

(Write-only) Turns all markers off for selected measurement.

See [Critical Note](#)

Parameters

<cnum> Channel number of the measurement. There must be a selected measurement on that channel. If unspecified, <cnum> is set to 1.

Examples

```
CALC:MARK:AOff  
calculate2:marker:aoff
```

Query Syntax Not applicable

Default Not applicable

CALCulate<cnum>:MARKer<n>:BUCKet <num>

Applicable Models: N522xB, N523xB, N524xB, M937xA, P937xA

(Read-Write) Sets and reads the data point (bucket) number of the trace on which the marker resides. When the markers are [interpolated \(non-discrete\)](#), the returned value is the nearest marker bucket position.

See [Critical Note](#)

Parameters

<cnum> Channel number of the measurement. There must be a selected measurement on that channel. If unspecified, <cnum> is set to 1.

<n> Marker number to move or query. The marker must already exist. If unspecified, <n> is set to 1.

<num> Data point (bucket) number. Choose any data point between: 0 and the number of data points minus 1.

Examples

```
CALC:MARK:BUCK 5  
calculate2:marker2:bucket 200
```

Query Syntax CALCulate<cnum>:MARKer<n>:BUCKet?

Return Type Integer

Default The first marker is set to the middle of the span. Subsequent markers are set to the bucket number of the previously active marker.

CALCulate<cnum>:MARKer:BWIDth <num>

Applicable Models: N522xB, N523xB, N524xB, M937xA, P937xA

(Read-Write) Turns on and sets markers 1 through 4 to calculate filter bandwidth. The <num> parameter sets the value below the maximum bandwidth peak that establishes the bandwidth of a filter. For example, if you want to determine the filter bandwidth 3 db below the bandpass peak value, set <num> to -3.

To turn off the Bandwidth markers, either turn them off individually or turn them **All Off**.

The analyzer screen will show either Bandwidth statistics OR Trace statistics; not both.

To search a User Range with the bandwidth search, first activate marker 1 and set the desired **User Range**. Then send the CALC:MARK:BWID command. The user range used with bandwidth search only applies to marker 1 searching for the max value. The other markers may fall outside the user range.

See Critical Note

Parameters

- <cnum> Channel number of the measurement. There must be a selected measurement on that channel. If unspecified, <cnum> is set to 1.
- <num> Target value below filter peak. Choose any number between **-500** and **500**

Examples

```
CALC:MARK:BWID -3  
calculate2:marker:bandwidth -2.513
```

Query Syntax CALCulate<cnum>:MARKer:BWIDth?
Returns the results of bandwidth search:

Return Type Numeric - Four Character values separated by commas: bandwidth, center Frequency, Q, loss.

Default -3

CALCulate<cnum>:MARKer<mkr>:COMPression:LEVel <num>

Applicable Models: N522xB, N523xB, N524xB, M937xA, P937xA

(Read-Write) Set and read the marker compression level. A compression marker must already exist. Use **CALC:MARK ON** and **CALC:MARK:FUNC COMP** to create compression markers.

See Critical Note

Parameters

<num> Channel number of the measurement. There must be a selected measurement on that channel. If unspecified, <num> is set to 1.

<mkr> Any existing marker number from 1 to 10; if unspecified, value is set to 1.

<lev> Compression level. Choose any number between: -500 dB to 500 dB

Standard gain compression values are positive.

Examples

```
CALC:MARK:COMP:LEV 1  
calculate2:marker:compression:level 1.5
```

Query Syntax CALCulate<num>:MARKer:COMPression:LEVEL?

Return Type Numeric

Default +1

CALCulate<num>:MARKer<mkr>:COMPression:PIN?

Applicable Models: N522xB, N523xB, N524xB, M937xA, P937xA

(Read-only) Reads the input power at the marker compression level. First send **CALC:MARK:FUNC:EXEC COMP** or **CALC:MARK:FUNC:TRAC ON**

See Critical Note

Parameters

<num> Channel number of the measurement. There must be a selected measurement on that channel. If unspecified, <num> is set to 1.

<mkr> Any existing marker number from 1 to 10; if unspecified, value is set to 1.

Examples

```
CALC:MARK:COMP:PIN?  
calculate2:marker:compression:pin?
```

Return Type Numeric

Default Not applicable

CALCulate<num>:MARKer<mkr>:COMPression:POUT?

Applicable Models: N522xB, N523xB, N524xB, M937xA, P937xA

(Read-only) Reads the output power at the marker compression level. First send **CALC:MARK:FUNC:EXEC COMP** or **CALC:MARK:FUNC:TRAC ON**

See Critical Note

Parameters

- <num> Channel number of the measurement. There must be a selected measurement on that channel. If unspecified, <num> is set to 1.
- <mr> Any existing marker number from 1 to 10; if unspecified, value is set to 1.

Examples

```
CALC:MARK:COMP:POUT?  
calculate2:marker2:compression:pout?
```

Return Type Numeric

Default Not applicable

CALCulate<num>:MARKer<mr>:COUPling:METHod <char>

Applicable Models: N522xB, N523xB, N524xB, M937xA, P937xA

(Read-Write) Sets and reads the scope of Coupled Markers. This is a global setting that affects all markers. [Learn more](#).

Note: This command will not take effect until Coupled Markers is turned on using **CALC:MARK:COUP:STATe ON**.

Note: The preset behavior of Coupled Markers depends on the setting of **SYSTEM:PREferences:ITEM:MControl**, **SYSTEM:PREferences:ITEM:MMethod**, and **SYSTEM:PREferences:ITEM:MCPrest**.

Parameters

- <num> Channel number of the measurement. There must be a selected measurement on that channel. If unspecified, <num> is set to 1.
- <mr> Any existing marker number from 1 to 10; if unspecified, value is set to 1.
- <char> **CHANnel** - Coupling is limited to traces in the same channel.
ALL - Coupling occurs across all channels.

Examples

```
CALC:MARK:COUP:METH CHAN  
calculat1:marker1:coupling all
```

Query Syntax CALCulate:MARKer:COUPling:METHod?

Return Type Character

Default ALL

CALCulate<cnum>:MARKer<mkr>:COUPling[:STATe]<ON|OFF>

Applicable Models: N522xB, N523xB, N524xB, M937xA, P937xA

(Read-Write) Sets and reads the state of Coupled Markers (ON and OFF). The scope of coupled markers can be changed with **CALC:MARK:COUP:METH**.

See Critical Note

Parameters

<cnum> Channel number of the measurement. There must be a selected measurement on that channel. If unspecified, <cnum> is set to 1.

<mkr> Any existing marker number from 1 to 10; if unspecified, value is set to 1.

<ON|OFF> **OFF (0)** - Turns Coupled Markers OFF

ON (1) - Turns Coupled Markers ON

Examples

```
CALC:MARK:COUP ON  
calculat1:marker1:coupling off
```

Query Syntax CALCulate:MARKer:COUPling:[STATe]?

Return Type Boolean (1 = ON, 0 = OFF)

Default OFF

CALCulate<cnum>:MARKer<mkr>:DELTA <ON|OFF>

Applicable Models: N522xB, N523xB, N524xB, M937xA, P937xA

(Read-Write) Specifies whether marker is relative to the Reference marker or absolute.

Note: The reference marker must already be turned ON with **CALC:MARK:REF:STATE**.

See Critical Note

Parameters

- <num> Channel number of the measurement. There must be a selected measurement on that channel. If unspecified, <num> is set to 1.
- <mr> Any existing marker number from 1 to 10; if unspecified, value is set to 1.
- <ON|OFF> **ON** (or 1) - Specified marker is a Delta marker
OFF (or 0) - Specified marker is an ABSOLUTE marker

Examples

```
CALC:MARK:DELT ON  
calculate2:marker8:delta off
```

Query Syntax CALCulate<num>:MARKer<mr>:DELTA?

Return Type Boolean (1 = ON, 0 = OFF)

Default OFF

CALCulate<num>:MARKer<mr>:DIScrete <ON|OFF>

Applicable Models: N522xB, N523xB, N524xB, M937xA, P937xA

(Read-Write) Makes the specified marker display either a calculated value between data points (interpolated data) or the actual data points (discrete data).

See Critical Note

Parameters

- <num> Channel number of the measurement. There must be a selected measurement on that channel. If unspecified, <num> is set to 1.
- <mr> Any existing marker number from 1 to 10; if unspecified, value is set to 1.
- <ON|OFF> **ON** (or 1) - Specified marker displays the actual data points
OFF (or 0) - Specified marker displays calculated data between the actual data points.

Examples

```
CALC:MARK:DISC ON  
calculate2:marker8:discrete off
```

Query Syntax CALCulate<cnum>:MARKer<mkr>:DISCcrete?

Return Type Boolean (1 = ON, 0 = OFF)

Default OFF

CALCulate<cnum>:MARKer<mkr>:DISTance <num>

Applicable Models: N522xB, N523xB, N524xB, M937xA, P937xA

(Read-Write) Set or query marker distance on a time domain trace.

The Write command moves the marker to the specified distance value. Once moved, you can **read the Y axis** value or **read the X-axis time** value. (Distance is calculated from the X-axis time value.)

The Read command reads the distance of the marker.

If the marker is set as delta, the WRITE and READ data is relative to the reference marker.

See Critical Note

Parameters

<cnum> Channel number of the measurement. There must be a selected measurement on that channel. If unspecified, <cnum> is set to 1.

<mkr> Any existing marker number from 1 to 10; if unspecified, value is set to 1.

<num> Marker distance in the unit of measure specified with
CALC:TRAN:TIME:MARK:UNIT

Examples

```
CALC:MARK:DIST .1  
calculate2:marker8:distance 5
```

Query Syntax CALCulate<cnum>:MARKer<mkr>:DISTance?

Return Type Numeric

Default Not Applicable

CALCulate<cnum>:MARKer<mkr>:FORMat <char>

Applicable Models: N522xB, N523xB, N524xB, M937xA, P937xA

(Read-Write) Sets the format of the data that will be returned in a marker data query CALC:MARK:Y? and the displayed value of the marker readout. The selection does not have to be the same as the measurement's display format.

See Critical Note

Parameters

- <num> Channel number of the measurement. There must be a selected measurement on that channel. If unspecified, <num> is set to 1.
- <mr> Any marker number from 1 to 15; if unspecified, value is set to 1
- <chr> Choose from:
- DEFault** - The format of the selected measurement
 - MLINear** - Linear magnitude
 - MLOGarithmic** - Logarithmic magnitude
 - IMPedance** - (R+jX)
 - ADMittance** - (G+jB)
 - PHASe** - Phase
 - IMAGinary** - Imaginary part (Im)
 - REAL** - Real part (Re)
 - POLar** - (Re, Im)
 - GDELay** - Group Delay
 - LINPhase** - Linear Magnitude and Phase
 - LOGPhase** - Log Magnitude and Phase
 - KELVin** - temperature
 - FAHRenheit** - temperature
 - CELSius** - - temperature
 - NOISe** - Noise (available ONLY in IM Spectrum measurement class).

Examples

```
CALC:MARK:FORMat MLIN  
calculate2:marker8:format Character
```

Query Syntax CALCulate<num>:MARKer<mr>:FORMat?

Return Type Character

Default DEFault

CALCulate<cnum>:MARKer<mkr>:FUNCtion:APEak:EXCursion <num>

Applicable Models: N522xB, N523xB, N524xB, M937xA, P937xA

(Read-Write) Sets amplitude peak excursion for the specified marker. The Excursion value determines what is considered a "peak". This command applies to marker peak searches (Next peak, Peak Right, Peak Left).

See Critical Note

Parameters

- <cnum> Channel number of the measurement. There must be a selected measurement on that channel. If unspecified, <cnum> is set to 1.
- <mkr> Any existing marker number from 1 to 10; if unspecified, value is set to 1.
- <num> Excursion value. Choose any number between **-500** and **500**.

Note: This command will accept **MIN** or **MAX** instead of a numeric parameter. See [SCPI Syntax](#) for more information.

Examples

```
CALC:MARK:FUNC:APE:EXC 10  
calculate2:marker8:function:apeak:excursion maximum
```

Query Syntax CALCulate<cnum>:MARKer<mkr>:FUNCtion:APEak:EXCursion?

Return Type Numeric

Default 3

CALCulate<cnum>:MARKer<mkr>:FUNCtion:APEak:THReshold <num>

Applicable Models: N522xB, N523xB, N524xB, M937xA, P937xA

(Read-Write) Sets peak threshold for the specified marker. If a peak (using the criteria set with :EXCursion) is below this reference value, it will not be considered when searching for peaks. This command applies to marker peak searches (Next peak, Peak Right, Peak Left).

See Critical Note

Parameters

- <cnum> Channel number of the measurement. There must be a selected measurement on that channel. If unspecified, <cnum> is set to 1.
- <mkr> Any marker number from 1 to 15; if unspecified, value is set to 1

<num> Threshold value. Choose any number between **-500** and **500**.

Note: This command will accept **MIN** or **MAX** instead of a numeric parameter. See **SCPI Syntax** for more information.

Examples

```
CALC:MARK:FUNC:APE:THR -40  
calculate2:marker8:function:apeak:threshold -55
```

Query Syntax CALCulate<cnum>:MARKer<mkr>:FUNCTion:APEak:THReshold?

Return Type Numeric

Default -100

CALCulate<cnum>:MARKer<mkr>:FUNCTion:DOMain:USER[:RANGe] <range>

Applicable Models: N522xB, N523xB, N524xB, M937xA, P937xA

(Read-Write) Assigns the specified marker to a range number. The x-axis travel of the marker is constrained to the range's span. The span is specified with the **CALC:MARK:FUNC:DOM:USER:START** and **STOP** commands, unless range 0 is specified which is the full span of the analyzer.

Each channel has **16** user ranges. (Trace statistics use the same ranges.) More than one marker can use a domain range.

See **Critical Note**

Parameters

<cnum> Channel number of the measurement. There must be a selected measurement on that channel. If unspecified, <cnum> is set to 1.

<mkr> Any marker number from 1 to 15; if unspecified, value is set to 1

 User span. Choose any Integer from **0 to 16**

0 is Full Span of the analyzer

1 to 16 are available for user-defined x-axis span

Examples

```
CALC:MARK:FUNC:DOM:USER 1  
calculate2:marker8:function:domain:user:range 1
```

Query Syntax CALCulate<cnum>:MARKer<mkr>:FUNCTion:DOMain:USER[:RANGe]?

Returns the user span number that the specified marker is assigned to.

Return Type Numeric

Default 0 - Full Span

CALCulate<cnum>:MARKer<mkr>:FUNCTion:DOMain:USER:START <start>

Applicable Models: N522xB, N523xB, N524xB, M937xA, P937xA

(Read-Write) Sets the start of the span that the specified marker's x-axis span will be constrained to.

Use **CALC:MARK:FUNC:DOM:USER<range>** to set range number

Use **CALC:MARK:FUNC:DOM:USER:STOP** to set the stop value.

Note: If the marker is assigned to range 0 (full span), the USER:START and STOP commands generate an error. You cannot set the START and STOP values for "Full Span".

Note: This command does the same as **CALC:FUNC:DOM:USER:STAR**

See Critical Note

Parameters

- <cnum> Channel number of the measurement. There must be a selected measurement on that channel. If unspecified, <cnum> is set to 1.
- <mkr> Any marker number from 1 to 15; if unspecified, value is set to 1
- <start> The analyzer's **Minimum** x-axis value

Examples

```
CALC:MARK:FUNC:DOM:USER:START 500E6  
calculate2:marker8:function:domain:user:start 1e12
```

Query Syntax CALCulate<cnum>:MARKer<mkr>:FUNCTion:DOMain:USER:START?

Return Type Numeric

Default The analyzer's **Minimum** x-axis value

CALCulate<cnum>:MARKer<mkr>:FUNCTion:DOMain:USER:STOP <stop>

Applicable Models: N522xB, N523xB, N524xB, M937xA, P937xA

(Read-Write) Sets the stop of the span that the marker's x-axis travel will be constrained to.

Use `CALC:MARK:FUNC:DOM:USER<range>` to set range number

Use `CALC:MARK:FUNC:DOM:USER:START` to set the stop value.

Note: If the marker is assigned to range 0 (full span), the `USER:START` and `STOP` commands generate an error. You cannot set the `START` and `STOP` values for "Full Span".

Note: This command does the same as `CALC:FUNC:DOM:USER:STOP`

See Critical Note

Parameters

- `<cnm>` Channel number of the measurement. There must be a selected measurement on that channel. If unspecified, `<cnm>` is set to 1.
- `<mkr>` Any marker number from 1 to 15; if unspecified, value is set to 1.
- `<stop>` Stop value of x-axis span; Choose any number between the analyzer's **MINimum** and **MAXimum** x-axis value.

Examples

```
CALC:MARK:FUNC:DOM:USER:STOP 500e6  
calculate2:marker8:function:domain1:user:stop 1e12
```

Query `CALCulate<cnm>:MARKer<mkr>:FUNCTion:DOMain:USER:STOP?`

Syntax

Return Type Numeric

Default The analyzer's **MAXimum** x-axis value.

`CALCulate<cnm>:MARKer<mkr>:FUNCTion:EXECute <func>`

Applicable Models: N522xB, N523xB, N524xB, M937xA, P937xA

(Write-only) Immediately executes (performs) the specified search function.

[Learn more about Marker Search](#)

[See Critical Note](#)

Parameters

- <cnum> Channel number of the measurement. There must be a selected measurement on that channel. If unspecified, <cnum> is set to 1.
- <mkr> Any marker number from 1 to 15; if unspecified, value is set to 1.
- <func> The function to be performed. Choose from:
- **MAXimum** - finds the highest value
 - **MINimum** - finds the lowest value
 - **RPEak** - finds the next valid peak to the right
 - **LPEak** - finds the next valid peak to the left
 - **NPEak** - finds the next highest value among the valid peaks
 - **TARGET** - finds the target value to the right, wraps around to the left
 - **LTARGET** - finds the next target value to the left of the marker
 - **RTARGET** - finds the next target value to the right of the marker
 - **COMPression** - finds the compression level on a Power Swept S21 trace.

Examples

```
CALC:MARK:FUNC:EXEC MAX  
calculate2:marker2:function:execute maximum
```

Query Syntax Not applicable

Default Not applicable

CALCulate<cnum>:MARKer<mkr>:FUNCtion[:SElect] <char>

Applicable Models: N522xB, N523xB, N524xB, M937xA, P937xA

(Read-Write) Sets the search function that the specified marker will perform when executed. Use **CALC:MARK:FUNC:TRAC ON** to automatically execute the search every sweep.

[Learn more about Marker Search](#)

[See Critical Note](#)

Parameters

- <cnm> Channel number of the measurement. There must be a selected measurement on that channel. If unspecified, <cnm> is set to 1.
- <mkr> Any marker number from 1 to 15; if unspecified, value is set to 1.
- <char> Marker function. Choose from:
- **MAXimum** - finds the highest value
 - **MINimum** - finds the lowest value
 - **RPEak** - finds the next valid peak to the right
 - **LPEak** - finds the next valid peak to the left
 - **NPEak** - finds the next highest value among the valid peaks
 - **TARGET** - finds the target value to the right, wraps around to the left
 - **LTARGET** - finds the next target value to the left of the marker
 - **RTARGET** - finds the next target value to the right of the marker
 - **COMPression** - finds the compression level on a power-swept S21 trace.

Examples

```
CALC:MARK:FUNC MAX  
calculate2:marker8:function:select 1target
```

Query Syntax CALCulate<cnm>:MARKer<mkr>:FUNCTion[:SElect]?

Return Type Character

Default MAX

CALCulate<cnm>:MARKer<mkr>:TARGet[:VALue] <num>

Applicable Models: N522xB, N523xB, N524xB, M937xA, P937xA

(Read-Write) Sets the target value for the specified marker when doing Target Searches with **CALC:MARK:FUNC:SEL** <TARGet | RTARget | LTARget>

See Critical Note

Parameters

- <num> Channel number of the measurement. There must be a selected measurement on that channel. If unspecified, <num> is set to 1.
- <mkr> Any marker number from 1 to 15; if unspecified, value is set to 1.
- <num> Target value to search for; Units are NOT allowed.

Examples

```
CALC:MARK:TARG 2.5  
calculate2:marker8:target:value -10.3
```

Query Syntax CALCulate<num>:MARKer<mkr>:TARGet[:VALue]?

Return Type Numeric

Default 0

CALCulate<num>:MARKer<mkr>:FUNCtion:TRACking <ON | OFF>

Applicable Models: N522xB, N523xB, N524xB, M937xA, P937xA

(Read-Write) Sets the tracking capability for the specified marker. The tracking function finds the selected search function every sweep. In effect, turning Tracking ON is the same as doing a **CALC:MARK:FUNC:EXECute** command every sweep.

[Learn more about Marker Search](#)

See Critical Note

Parameters

- <num> Channel number of the measurement. There must be a selected measurement on that channel. If unspecified, <num> is set to 1.
- <mkr> Any marker number from 1 to 15; if unspecified, value is set to 1.
- <ON | OFF> **ON** (or 1) - The specified marker will "Track" (find) the selected function every sweep.
OFF (or 0) - The specified marker will find the selected function **only** when the **CALC:MARK:FUNC:EXECute** command is sent.

Examples

```
CALC:MARK:FUNC:TRAC ON
calculate2:marker8:function:tracking off
```

Query Syntax CALCulate<cnum>:MARKer<mkr>:FUNCTion:TRACking?**Return Type** Boolean (1 = ON, 0 = OFF)**Default** OFF**CALCulate<cnum>:MARKer:REFerence[:STATe] <ON | OFF>****Applicable Models:** N522xB, N523xB, N524xB, M937xA, P937xA**(Read-Write)** Turns the reference marker ON or OFF. When turned OFF, existing Delta markers revert to general-purpose markers.**Important:** Learn about [programming the reference marker](#).

See Critical Note

Parameters

<cnum> Channel number of the measurement. There must be a selected measurement on that channel. If unspecified, <cnum> is set to 1.

<ON | OFF> **ON** (or 1) - turns reference marker ON**OFF** (or 0) - turns reference marker ON**Examples**

```
CALC:MARK:REF ON
calculate2:marker:reference:state OFF
```

Query Syntax CALCulate<cnum>:MARKer:REFerence[:STATe]?**Return Type** Boolean (1 = ON, 0 = OFF)**Default** OFF**CALCulate<cnum>:MARKer:REFerence:X <num>**

Applicable Models: N522xB, N523xB, N524xB, M937xA, P937xA

(Read-Write) Sets and returns the absolute x-axis value of the reference marker.

Important: Learn about [programming the reference marker](#).

See Critical Note

<cnun> Channel number of the measurement. There must be a selected measurement on that channel. If unspecified, <cnun> is set to 1.

<num> X-axis value. Choose any number within the operating domain of the reference marker.

Examples

```
CALC:MARK:REF:X 1e9
```

```
calculate2:marker:reference:x 1e6
```

Query Syntax CALCulate<cnun>:MARKer:REFerence:X?

Return Type Numeric

Default If the first Marker, turns ON in the middle of the X-axis span. If not, turns ON at the position of the active marker.

CALCulate<cnun>:MARKer:REFerence:Y?

Applicable Models: N522xB, N523xB, N524xB, M937xA, P937xA

(Read-only) Returns the absolute Y-axis value of the reference marker.

Important: Learn about [programming the reference marker](#).

See Critical Note

Parameters

<cnun> Channel number of the measurement. There must be a selected measurement on that channel. If unspecified, <cnun> is set to 1.

Examples

```
CALC:MARK:REF:Y?
```

```
calculate2:marker:reference:y?
```

Return Type Character

Default Not applicable

CALCulate<cnun>:MARKer<mkr>:SET <char>

Applicable Models: N522xB, N523xB, N524xB, M937xA, P937xA

(Write-only) Sets the selected instrument setting to assume the value of the specified marker.

Marker Functions CENT, SPAN, START, and STOP do not work with channels that are in **CW** or **Segment Sweep** mode.

See **Critical Note**

Parameters

- <num> Channel number of the measurement. There must be a selected measurement on that channel. If unspecified, <num> is set to 1.
- <mkr> Any marker number from 1 to 15; if unspecified, value is set to 1
- <char> Choose from:
- **CENTer** - changes center frequency to the value of the marker
 - **SPAN** - changes the sweep span to the span that is defined by the delta marker and the marker that it references. Unavailable if there is no delta marker.
 - **START** - changes the start frequency to the value of the marker
 - **STOP** - changes the stop frequency to the value of the marker
 - **RLEVel** - changes the reference level to the value of the marker
 - **DELay** - changes the line length at the receiver input to the phase slope at the active marker stimulus position.
 - **CWFReq** - Sets the CW frequency to the frequency of the active marker. Does NOT change sweep type. NOT available in CW or Power Sweep. Use this argument to first set the CW Frequency to a value that is known to be within the current calibrated range, THEN set **Sweep:Type** to POWER or CW.

Examples

```
CALC:MARK:SET CENT  
calculate2:marker8:set span
```

Query Syntax Not Applicable

Default Not Applicable

CALCulate<num>:MARKer<mkr>[:STATe] <ON|OFF>

Applicable Models: N522xB, N523xB, N524xB, M937xA, P937xA

(Read-Write) Turns the specified marker ON or OFF. To turn all markers off, use CALC:MARK:AOFF.

See Critical Note

Parameters

- <cnum> Channel number of the measurement. There must be a selected measurement on that channel. If unspecified, <cnum> is set to 1.
- <mkr> Any marker number from 1 to 15; if unspecified, value is set to 1.
- <ON|OFF> **ON** (or 1) - turns marker ON.
OFF (or 0) - turns marker OFF.

Examples

```
CALC:MARK ON  
calculate2:marker8 on
```

Query Syntax CALCulate<cnum>:MARKer<mkr>:STATe?

Return Type Boolean (1 = ON, 0 = OFF)

Default Off

CALCulate<cnum>:MARKer<mkr>:TYPE <char>

Applicable Models: N522xB, N523xB, N524xB, M937xA, P937xA

(Read-Write) Sets the type of the specified marker.

See Critical Note

Parameters

- <cnum> Channel number of the measurement. There must be a selected measurement on that channel. If unspecified, <cnum> is set to 1.
- <mkr> Any marker number from 1 to 15; if unspecified, value is set to 1
- <char> Choose from:
- **NORMal** - a marker that stays on the assigned X-axis position unless moved or searching.
 - **FIXed** - a marker that will not leave the assigned X or current Y-axis position.

Examples

```
CALC:MARK:TYPE NORM  
calculate2:marker2:type fixed
```

Query Syntax CALCulate<cnum>:MARKer<mkr>:TYPE?

Return Type Character

Default NORMal

CALCulate<cnum>:MARKer<mkr>:X <num>

Applicable Models: N522xB, N523xB, N524xB, M937xA, P937xA

(Read-Write) Sets the marker's X-axis value (frequency, power, or time). If the marker is set as delta, the SET and QUERY data is relative to the reference marker.

See [Critical Note](#)

Parameters

<cnum> Channel number of the measurement. There must be a selected measurement on that channel. If unspecified, <cnum> is set to 1.

<mkr> Any marker number from 1 to 15; if unspecified, value is set to 1.

<num> Any X-axis position within the measurement span of the marker.

Note: This command will accept **MIN** or **MAX** instead of a numeric parameter. See [SCPI Syntax](#) for more information.

Examples

```
CALC:MARK:X 100Mhz  
calculate2:marker8:x maximum
```

Query Syntax CALCulate<cnum>:MARKer<mkr>:X?

Return Type Numeric

Default First Marker turns ON in the middle of the X-axis span. Subsequent markers turn ON at the position of the active marker.

CALCulate<cnum>:MARKer<mkr>:Y?

Applicable Models: N522xB, N523xB, N524xB, M937xA, P937xA

(Read-only) Reads the marker's Y-axis value. The format of the value depends on the current CALC:MARKER:FORMAT setting. If the marker is set as delta, the data is relative to the reference marker. The query always returns two numbers:

- Smith and Polar formats - (Real, Imaginary)
- LINPhase and LOGPhase - (Real, Imaginary)
- All other formats - (Value,0)

Note: To accurately read the marker Y-axis value with **trace smoothing** applied, the requested format must match the **displayed format**. Otherwise, the returned value is un-smoothed data. For example, to read the smoothed marker value when measuring group delay, both the display format and the marker format must be set to (Group) Delay.

See Critical Note

Parameters

<cnum> Channel number of the measurement. There must be a selected measurement on that channel. If unspecified, <cnum> is set to 1.

<mk> Any marker number from 1 to 15; if unspecified, value is set to 1.

Examples

```
CALC:MARK:Y?  
calculate2:marker3:y?
```

Query Syntax CALCulate<cnum>:MARKer<mk>:Y?

Return Type Numeric

Default Not applicable

Calculate:Math Commands

Controls math operations on the currently selected measurement and memory.

These commands are **Superseded** by the `CALCulate:MEASure:MATH` commands.

CALCulate:MATH:

FUNCtion

INTerpolate

MEMorize

Click on a keyword to view the command details.

See Also

- [Example Programs](#)
- [Learn about Math Operations](#)
- [Synchronizing the Analyzer and Controller](#)
- [SCPI Command Tree](#)

Critical Note: CALCulate commands act on the selected measurement. You can select one measurement for each channel using `Calc:Par:MNUM` or `Calc:Par>Select`. [Learn more](#).

CALCulate<cnum>:MATH:FUNCtion <char>

Applicable Models: N522xB, N523xB, N524xB, M937xA, P937xA

(Read-Write) Sets math operations on the currently selected measurement and the trace stored in memory. (There MUST be a trace stored in Memory. See `CALC:MATH MEM`)

[See Critical Note](#)

Parameters

- <cnum> Channel number of the measurement. There must be a selected measurement on that channel. If unspecified, <cnum> is set to 1.
- <char> The math operation to be applied. Choose from the following:

NORMAL	Trace data only
ADD	Data + Memory
SUBTRACT	Data - Memory
MULTIPLY	Data * Memory
DIVIDE	Data / Memory

Examples

```
CALC:MATH:FUNC NORM
calculate2:math:function subtract
```

Query Syntax CALCulate<cnum>:MATH:FUNCTION?

Return Type Character

Default NORMAL

CALCulate<cnum>:MATH:INTERpolate <bool>

Applicable Models: N522xB, N523xB, N524xB

(Read-Write) Sets and reads the state of the memory data interpolation. [Learn more.](#)

See Critical Note

Parameters

- <ch> Channel number of the measurement. There must be a selected measurement on that channel. If unspecified, <ch> is set to 1.
- <bool> Choose from:
 - 0 - OFF** - Turn memory data interpolation OFF.
 - 1 - ON** - Turn memory data interpolation ON.

Examples

```
CALC2:MATH:INT 1
```

Query Syntax CALCulate<ch>:MATH:INTERpolate?

Return Type Boolean

Default 0

CALCulate<cnum>:MATH:MEMorize

Applicable Models: N522xB, N523xB, N524xB, M937xA, P937xA

(Write-only) Puts the currently selected measurement trace into memory. (Data-> Memory).

See Critical Note

Parameters

<num> Channel number of the measurement. There must be a selected measurement on that channel. If unspecified, <num> is set to 1.

Examples

```
CALC:MATH:MEM  
calculate2:math:memorize
```

Query Syntax Not applicable

Default Not applicable

Measure

These commands are for setting up measurements.

CALCulate:MEASure

**BLIMit More
commands**

CONVersion

| **FUNction**

**CORRection More
commands**

**DATA More
commands**

DEFine

DELete

| **ALL**

EQUation

| **FAST**

| **[:STATe]**

| **TEXT**

| **VALid?**

**FILTer More
commands**

FORMat

| **UNIT**

**FUNction More
commands**

**GCData More
commands**

**GCMeas More
commands**

**GDELay More
commands**

HOLD

| [CLEar](#)

| [\[TYPE\]](#)

[LIMit More commands](#)

[MARKer More commands](#)

MATH

| [FUNCTion](#)

| [INTerpolate\[:STATe\]](#)

| [MEMorize](#)

MIXer

| [XAXis](#)

[OFFSet More commands](#)

[PARAmeter More commands](#)

[RDATa?](#)

[RLIMit More commands](#)

[SMOothing More commands](#)

[TRANSform More commands](#)

[X More commands](#)

Click a [keyword](#) to view the command details.

See Also

- [Calibrating with SCPI](#)
- [Synchronizing the Analyzer and Controller](#)
- [SCPI Command Tree](#)

CALCulate<cnum>:MEASure<mnum>:CONVersion:FUNCTion <char>

Applicable Models: All

(Read-Write) Sets or gets the parameter after conversion using the parameter conversion function, for the active trace of selected channel.

Parameters

- <cnum> Channel number of the measurement. There must be a selected measurement on that channel. If unspecified, <cnum> is set to 1.
- <mnum> Measurement number for each measurement. There must be a selected measurement on the trace. If unspecified, <mnum> is set to 1.
- <char> Select from the following parameters after conversion:
- "OFF"
 - "ZREflection" - Specifies the equivalent impedance in reflection measurement.
 - "ZTRansmit" - Specifies the equivalent impedance (series) in transmission measurement.
 - "ZTSHunt" - Specifies the equivalent impedance (shunt) in transmission measurement.
 - "YREflection" - Specifies the equivalent admittance in reflection measurement.
 - "YTRansmit" - Specifies the equivalent admittance (series) in transmission measurement.
 - "YTSHunt" - Specifies the equivalent admittance (shunt) in transmission measurement.
 - "INVersion" - Specifies the inverse S-parameter (1/S).
 - "CONJugation" - Specifies the conjugate.

Examples

```
CALC:MEAS1:CONV:FUNC ZTSH
calculate2:measure1:conversion:function conjugation
```

Query Syntax	CALCulate<cnum>:MEASure<mnum>:CONVersion:FUNCTion?
Return Type	Character
Default	"OFF"

CALCulate<cnum>:MEASure<mnum>:DEFine <string>

Applicable Models: All

(Write-only) Creates a measurement but does NOT display it, on an existing or new channel. When a

new channel is created, any licensed measurement class can be used. Up to 580 (2000 for M980xA/P50xxA and E5080B) measurements can be created.

Note that each display window can only display a limited number of traces. See [Traces, Channels, and Windows on the VNA](#).

- Use `DISP:WIND:STATe` to create a window if it doesn't already exist.
- Use `DISP:MEAS<mnum>:FEED<wnum>` to display the measurement in window <wnum>.

This command replaces the following commands:

`CALCulate:PARAmeter[:DEFine]`

`CALCulate:PARAmeter[:DEFine]:EXTended`

`CALCulate:CUSTom:DEFine`

Parameters

<num> Channel number of the new measurement. If unspecified, value is set to 1.

If the specified channel does not exist, then a channel of the specified type will be created. If no type of channel is specified, then a standard channel will be created.

If the specified channel exists, then the parameter will be added to the channel provided the existing channel supports the parameter (otherwise, an error will be generated).

<mnum> Measurement number for the new measurement. There must be a selected measurement on the trace. If unspecified, <mnum> is set to 1.

If the specified measurement number is already in use, an error will be generated.

<string> **(String)** Measurement Parameter and optional measurement class name separated by a ":" (colon). For example, "S21:Gain Compression" creates an S21 measurement and selects the Gain Compression measurement class for the channel.

Note: If a measurement class of a channel does not support the defined measurement parameter, an error is generated.

Case sensitive.

For S-parameters:

Any S-parameter available in the VNA

Single-digit port numbers CAN be separated by "_" (underscore). For example: "S21" or "S2_1"

Double-digit port numbers MUST be separated by underscore. For example: "S10_1"

For ratioed measurements:

Any two VNA physical receivers separated by forward slash "/" followed by comma and source port.

For example: "A/R1, 3"

[Learn more about ratioed measurements](#)

See a [block diagram](#) showing the receivers in YOUR VNA.

For non-ratioed measurements:

Any VNA physical receiver followed by comma and source port.

For example: "A, 4"

[Learn more about unratioed measurements.](#)

See the [block diagram](#) showing the receivers in YOUR VNA.

Ratioed and Unratioed measurements can also use **logical receiver notation** to refer to receivers. This notation makes it easy to refer to receivers with an external test set connected to the VNA. You do not need to know which physical receiver is used for each test port. [Learn more.](#)

For ADC measurements:

Any ADC receiver in the VNA followed by a comma, then the source port.

For example: "AI1,2" indicates the Analog Input1 with source port of 2.

[Learn more about ADC receiver measurements.](#)

(string) - The following are the existing valid measurement parameters for each measurement class (click a link or scroll down to view). The Measurement Class must be installed and registered on the VNA.

- "Standard"
- "Scalar Mixer/Converter"
- "Gain Compression"
- "Noise Figure Cold Source"

(variant) Measurement names to create:

Meas Class	Measurement Name	Description
"Standard"	"S11", "S21", and so forth "A_1", "A_2", and so forth	S-parameter name Unratioed parameter names with notation: "receiver_source port" See balanced parameter names
"Scalar Mixer/Converter"	For input port X and output port Y: "SCXY" "SCYX" "SXX" "SYY" "Ipwr" "RevIPwr" "Opwr" "RevOPwr"	Learn about SMC parameters Note: Input and output ports are set up using the Mixer Setup dialog. If the ports are not set up using the Mixer Setup dialog, then ports 1 and 2 are the default input and output ports and the only ports that can be used.
"Gain Compression" Learn more	GCA: "Compln21" "CompOut21" "CompGain21" "CompS11"	Input power at the compression point. Output power at the compression point. Gain at the compression point. Input Match at the compression point

	<p>"RefS21" Linear Gain</p> <p>"DeltaGain21" CompGain21 -Linear Gain</p> <p>"S11", "S21", "S12", "S22" Standard S-parameters; measured at port 1 and port 2</p>
<p>"Noise Figure Cold Source"</p> <p>Learn more</p>	<p>Noise Figure :</p>
	<p>"NF" Noise figure</p>
	<p>"ENR" Validate noise source measurements.</p>
	<p>"T-Eff" Effective noise temperature.</p>
	<p>"DUTRNP" DUT noise power ratio. (Noise power expressed in Kelvin divided by 290).</p>
	<p>"DUTRNPDI"</p>
	<p>"SYSRNP" System noise power ratio</p>
	<p>"SYSRNPDI"</p>
	<p>"DUTNPD" DUT noise power density. (Noise power expressed in dBm/Hz).</p>
	<p>"DUTNPDI"</p>
	<p>"SYSNPD" System noise power density.</p>
	<p>"SYSNPDI"</p>
	<p>"OvrRng" Indication that the noise receiver is being over powered. (Opt 029 Only)</p>
<p>"T-Rcvr" Temperature reading (in Kelvin) of the noise receiver board. (Opt 029 Only)</p>	
<p>"S11", "S21", "S12", "S22" Standard S-parameters; measured with the port1 and port2 noise switches set for noise mode.</p>	
<p>"A_1", "A_2" ...and so forth. Unratioed parameters; with notation: "receiver, source port"</p> <p>"GammaOpt" Optimum Complex Reflection Coefficient</p>	

	"Rn"	Noise Resistance
	"NFMin"	Minimum noise figure that occurs at GammaOpt

Examples `CALC1:MEAS2:DEF "S11" 'Defines an S11 measurement for channel 1, measurement number 2.'`

`CALC4:MEAS3:DEF "S21:Gain Compression" 'Defines an S21 measurement for channel 4, measurement number 3, and creates a GCA channel.'`

`CALC2:MEAS:DEF "R1,1:Standard" 'Defines an R1,1 measurement for channel 2, measurement number 1 (default), and creates a Standard channel.'`

Query Syntax Not Applicable
Default Not Applicable

CALCulate<cnum>:MEASure<mnum>:DELeTe <Mname>

Applicable Models: All

(Write-only) Deletes the specified measurement.

Parameters

<cnum> Channel number of the measurement. There must be a selected measurement on that channel. If unspecified, <cnum> is set to 1.

<mnum> Measurement number for each measurement. There must be a selected measurement on the trace. If unspecified, <mnum> is set to 1.

<Mname> String - Name of the measurement

Examples `CALC:MEAS:DEL 'TEST'`
`calculate2:measure2:delete 'test'`

Query Syntax Not Applicable
Default Not Applicable

CALCulate:MEASure:DELeTe:ALL

Applicable Models: All

(Write-only) Deletes all measurements on the VNA.

Parameters

Examples `CALC:MEAS:DEL:ALL`

Query Syntax Not Applicable

Default Not Applicable

CALCulate<cnum>:MEASure<mnum>:EQUation:FAST <bool>

Applicable Models: All

(Read-Write) Set and return equation editor trace update delay. This command delays updating the equation editor trace until all trace references have finished updating to ensure that all data is present.

Note: This command does not work in application channels. In addition, this command does not work with the standard channel when the channel is in HOLD and then SINGLE sweeps are sent.

Parameters

<cnum> Channel number of the measurement. There must be a selected measurement on that channel. If unspecified, <cnum> is set to 1.

<mnum> Measurement number for each measurement. There must be a selected measurement on the trace. If unspecified, <mnum> is set to 1.

<bool> Choose from:

OFF (0) Do not delay equation editor trace update.

ON (1) Delay equation editor trace update.

Examples `CALC:MEAS:EQU:FAST 1`

`calculate2:measure1:equation:fast OFF`

Query Syntax `CALCulate<cnum>:MEASure<mnum>:EQUation:FAST?`

Return Type Boolean

Default **OFF** or **0**

CALCulate<cnum>:MEASure<mnum>:EQUation[:STATe] <bool>

Applicable Models: All

(Read-Write) Turns ON and OFF the equation on selected measurement for the specified channel. If the equation is not valid, then processing is not performed. Use **CALC:EQUation:VALid?** to ensure that the equation is valid.

Parameters

- <cnun> Channel number of the measurement. There must be a selected measurement on that channel. If unspecified, <cnun> is set to 1.
- <mnum> Measurement number for each measurement. There must be a selected measurement on the trace. If unspecified, <mnum> is set to 1.
- <bool> **ON** (or 1) - turns equation ON.
OFF (or 0) - turns equation OFF.

Examples

```
CALC:MEAS:EQU 1
calculate2:measure1:equation:state 0
```

Query Syntax CALCulate<cnun>:MEASure<mnum>:EQUation[:STATe]?

Return Type Boolean

Default OFF (0)

CALCulate<cnun>:MEASure<mnum>:EQUation:TEXT <string>

Applicable Models: All

(Read-Write) Specifies an equation or expression to be used on the selected measurement for the specified channel.

Parameters

- <cnun> Channel number of the measurement. There must be a selected measurement on that channel. If unspecified, <cnun> is set to 1.
- <mnum> Measurement number for each measurement. There must be a selected measurement on the trace. If unspecified, <mnum> is set to 1.
- <string> Any valid equation or expression. **See Equation Editor.**

Examples

```
'Equation (includes '=')
CALC:MEAS:EQU:TEXT "foo=S11/S21"

'Expression
calculate2:measure1:equation:text "S11/S21"
```

Query Syntax CALCulate<cnum>:MEASure<mnum>:EQUation:TEXT?**Return Type** String**Default** Not Applicable**CALCulate<cnum>:MEASure<mnum>:EQUation:VALid?****Applicable Models:** All

(Read-Only) Returns a boolean value to indicate if the current equation on the selected measurement for the specified channel is valid. For equation processing to occur, the equation must be valid and ON (CALC:EQU:STAT 1).

Parameters

- <cnum> Channel number of the measurement. There must be a selected measurement on that channel. If unspecified, <cnum> is set to 1.
- <mnum> Measurement number for each measurement. There must be a selected measurement on the trace. If unspecified, <mnum> is set to 1.

Examples

```
CALC:MEAS:EQU:VAL?
calculate2:measure1:equation:valid?
```

Return Type Boolean

- 1 - equation is valid
- 0 - equation is NOT valid

Default Not Applicable**CALCulate<cnum>:MEASure<mnum>:FORMat <char>**

Applicable Models: All

(Read-Write) Sets the display format for the measurement.

Parameters

<num> Channel number of the measurement. There must be a selected measurement on that channel. If unspecified, <num> is set to 1.

<mnum> Measurement number for each measurement. There must be a selected measurement on the trace. If unspecified, <mnum> is set to 1.

<char> Choose from:

- MLINear
- MLOGarithmic
- PHASe
- UPHase 'Unwrapped phase
- IMAGinary
- REAL
- POLar
- SMITH
- SADMittance 'Smith Admittance
- SWR
- GDELay 'Group Delay
- KELVin
- FAHRenheit
- CELSius
- PPHase 'Positive Phase

Examples

```
CALC:MEAS:FORM MLIN  
calculate2:measure1:format polar
```

Query Syntax CALCulate<num>:MEASure<mnum>:FORMat?

Return Type Character

Default MLINear

CALCulate<cnum>:MEASure<mnum>:FORMat:UNIT <dataFormat>, <units>

Applicable Models: All

(Read-Write) Sets and returns the units for the specified data format. Measurements with display formats other than those specified are not affected.

Parameters

- <cnum> Channel number of the measurement. There must be a selected measurement on that channel. If unspecified, <cnum> is set to 1.
- <mnum> Measurement number for each measurement. There must be a selected measurement on the trace. If unspecified, <mnum> is set to 1.
- <dataFormat> Choose from:
 - **MLOG** - Log magnitude
 - **MLIN** - Linear magnitude
- <units> For unratioed MLOG measurements, choose from:
 - **DBM** Units are displayed in dBm. 0 dBm = 0.001 watt
 - **DBMV** Units are displayed in dBmV. 0 dBmV = 0.001 volt
DBmV value depends on the reference impedance: $\text{dBmV} = \text{dBm} + 30 + 10 \cdot \log_{10}(Z_0)$
 - **DBMA** Units are displayed in dBmA. 0 dBmA = 0.001 Ampere
 - **DBUV** Units are displayed in dBuV. 0 dBuV = 1 uV
DBuV value depends on the reference impedance: $\text{dBuV} = \text{dBm} + 90 + 10 \cdot \log_{10}(Z_0)$

For unratioed MLIN measurements, choose from:

- **W** -Units are displayed in Watts
- **V** -Units are displayed in Volts
- **A** -Units are displayed in Amperes

Examples

```
CALC:MEAS:FORM MLOG, DBM  
calculate2:measure1:format mlog,dbmv
```

Query Syntax CALCulate<cnum>:MEASure<mnum>:FORMat:UNIT? <dataFormat>

Return Type Character

Default MLOG, DBM

CALCulate<ch>:MEASure<mnum>:HOLD:CLEAr

Applicable Models: All

(Write-only) Resets the currently-stored data points to the live data trace and restarts the currently-selected Trace Hold type.

Parameters

- <ch> Channel number of the measurement. There must be a selected measurement on that channel. If unspecified, <cnum> is set to 1.
- <mnum> Measurement number for each measurement. There must be a selected measurement on the trace. If unspecified, <mnum> is set to 1.

Examples

```
CALC:MEAS:HOLD:CLE  
calculate2:measure1:hold:clear
```

Query Syntax Not Applicable

Default Not Applicable

CALCulate<ch>:MEASure<mnum>:HOLD:TYPE <value>

Applicable Models: All

(Read-Write) Sets the type of trace hold to perform.

Parameters

- <ch> Channel number of the measurement. There must be a selected measurement on that channel. If unspecified, <cnum> is set to 1.
- <mnum> Measurement number for each measurement. There must be a selected measurement on the trace. If unspecified, <mnum> is set to 1.
- <value> Trace Hold type. Choose from:

OFF - Disables the Trace Hold feature.

MINimum - Sets Trace Hold to store the lowest measured data points.

MAXimum - Sets Trace Hold to store the highest measured data points.

Examples

```
CALC:MEAS:HOLD:TYPE MAX  
calculate2:measure1:hold:type minimum
```

Query Syntax CALCulate<ch>:MEASure<mnum>:HOLD:TYPE?

Return Type Character

Default OFF

CALCulate<cnum>:MEASure<mnum>:MATH:FUNCTion <char>

Applicable Models: All

(Read-Write) Sets math operations on the currently selected measurement and the trace stored in memory. (There MUST be a trace stored in Memory. See [CALC:MEAS:MATH MEM](#))

Parameters

- <cnum> Channel number of the measurement. There must be a selected measurement on that channel. If unspecified, <cnum> is set to 1.
- <mnum> Measurement number for each measurement. There must be a selected measurement on the trace. If unspecified, <mnum> is set to 1.
- <char> The math operation to be applied. Choose from the following:
 - NORMal** Trace data only
 - ADD** Data + Memory
 - SUBTract** Data - Memory
 - MULTiPLY** Data * Memory
 - DIVide** Data / Memory

Examples

```
CALC:MEAS:MATH:FUNC NORM  
calculate2:measure1:math:function subtract
```

Query Syntax CALCulate<cnum>:MEASure<mnum>:MATH:FUNCTion?

Return Type Character

Default NORMal

CALCulate<cnum>:MEASure<mnum>:MATH:INTerpolate[:STATe]

Applicable Models: N522xB, N523xB, N524xB

(Read-Write) Sets and reads the state of the memory data interpolation. [Learn more.](#)

Parameters

- <cnum> Channel number of the measurement. There must be a selected measurement on that channel. If unspecified, <ch> is set to 1.
- <mnum> Measurement number for each measurement. There must be a selected measurement on the trace. If unspecified, <mnum> is set to 1.
- <bool> Choose from:
 - 0 - OFF** - Turn memory data interpolation OFF.
 - 1 - ON** - Turn memory data interpolation ON.

Examples `CALC2:MEAS:MATH:INT 1`

Query Syntax `CALCulate<ch>:MEASure<mnum>:MATH:INTerpolate?`

Return Type `Boolean`

Default `0`

CALCulate<cnum>:MEASure<mnum>:MATH:MEMorize

Applicable Models: All

(Write-only) Puts the currently selected measurement trace into memory. (Data-> Memory).

Parameters

- <cnum> Channel number of the measurement. There must be a selected measurement on that channel. If unspecified, <cnum> is set to 1.
- <mnum> Measurement number for each measurement. There must be a selected measurement on the trace. If unspecified, <mnum> is set to 1.

Examples

```
CALC:MEAS:MATH:MEM
calculate2:measure1:math:memorize
```

Query Syntax Not applicable

Default Not applicable

CALCulate<ch>:MEASure<mnum>:MIXer:XAXis <char>

Applicable Models: All

(Read-Write) Sets or returns the swept parameter to display on the X-axis for the selected **FCA** and GCX measurement.

Parameters

- <ch> Any existing channel number. If unspecified, value is set to 1.
- <mnum> Measurement number for each measurement. There must be a selected measurement on the trace. If unspecified, <mnum> is set to 1.
- <char> Parameter to display on the X-axis. Choose from:

INPUT - Input frequency span

OUTPUT - Output frequency span

LO_1 - First LO frequency span

LO_2 - Second LO frequency span

Examples

```
CALC:MEAS:MIX:XAX INPUT  
calculate2:measure1:mixer:xaxis output
```

See an example that creates, selects, and calibrates an **SMC** and **VMC** measurement using SCPI.

Query Syntax CALCulate<ch>:MEASure<mnum>:MIXer:XAXis?

Return Type Character

Default OUTPUT

CALCulate<cnum>:MEASure<mnum>:RDATA? <char>

Applicable Models: All

(Read-only) Returns receiver data for the selected measurement.

Parameters

- <cnum> Channel number of the measurement. There must be a selected measurement on that channel. If unspecified, <cnum> is set to 1.
- <mnum> Measurement number for each measurement. There must be a selected measurement on the trace. If unspecified, <mnum> is set to 1.
- <char> Choose from any physical receiver in the VNA.

For example: "A"

Also, **REF** - returns data for either R1 or R2 data depending on the source port of the selected measurement.

See the [block diagram](#) showing the receivers in YOUR VNA.

Note: Logical receiver notation is NOT allowed with this command. [Learn more.](#)

Example

```
GPIB.Write "INITiate:CONTinuous OFF"  
GPIB.Write "INITiate:IMMediate;*wai"  
GPIB.Write "CALCulate:MEASure2:RDATA? A"
```

```
GPIB.Write "CALCulate:MEASure2:RDATA? REF"
```

Return Type Depends on **FORM:DATA** - Two numbers per data point

Default Not Applicable

CALCulate:MEASure:BLIMit Commands

These commands are for setting up bandwidth tests.

CALCulate:MEASure:BLIMit
BWIDth
THReshold
DISPlay
MARKEr
STATe
FAIL?
MAXimum
MINimum
REPort
[:DATA]?
[:STATe]

Click a [keyword](#) to view the command details.

See Also

- [Calibrating with SCPI](#)
- [Synchronizing the Analyzer and Controller](#)
- [SCPI Command Tree](#)

CALCulate<cnum>:MEASure<mnum>:BLIMit:BWIDth:THReshold <value>

Applicable Models: All

(Read-Write) Sets bandwidth threshold value (attenuation from the peak) of the bandwidth test.

Parameters

- <cnum> Channel number of the measurement. There must be a selected measurement on that channel. If unspecified, <cnum> is set to 1.
- <mnum> Measurement number for each measurement. There must be a selected measurement on the trace. If unspecified, <mnum> is set to 1.
- <value> Bandwidth N dB points

Examples

```
CALC:MEAS:BLIM:BWID:THR 5
calculate2:measure2:blimit:display:bwid:threshold 5
```

Query Syntax

CALCulate<cnum>:MEASure<mnum>:BLIMit:BWIDth:THReshold?

Return Type

Numeric

Default 3

CALCulate<cnum>:MEASure<mnum>:BLIMit:DISPlay:MARKer:STATe <bool>

Applicable Models: All

(Read-Write) Turns ON/OFF the bandwidth value display of the bandwidth test, for the active trace of selected channel.

Parameters

- <cnum> Channel number of the measurement. There must be a selected measurement on that channel. If unspecified, <cnum> is set to 1.
- <mnum> Measurement number for each measurement. There must be a selected measurement on the trace. If unspecified, <mnum> is set to 1.
- <bool> ON or 1 - Turns limit testing ON.
OFF or 0 - Turns limit testing OFF.

Examples

```
CALC:MEAS:BLIM:DISP:MARK:STAT ON
calculate2:measure2:blimit:display:marker:state off
```

Query Syntax

CALCulate<cnum>:MEASure<mnum>:BLIMit:DISPlay:BWIDth:STATe?

Return Type

Boolean

Default OFF

CALCulate<cnum>:MEASure<mnum>:BLIMit:FAIL?

Applicable Models: All

(Read-only) Get the bandwidth limit test results, for the active trace of selected channel.

Parameters

- <cnum> Channel number of the measurement. There must be a selected measurement on that channel. If unspecified, <cnum> is set to 1.
- <mnum> Measurement number for each measurement. There must be a selected measurement on the trace. If unspecified, <mnum> is set to 1.
- <bool> Boolean
 - 0 is returned when Pass
 - 1 is returned when Fail

Examples

```
CALC:MEAS:BLIM:FAIL?  
calculate2:measure2:blimit:fail?
```

Query Syntax

CALCulate<cnum>:MEASure<mnum>:BLIMit:FAIL?

Return Type

Boolean

Default

Not Applicable

CALCulate<cnum>:MEASure<mnum>:BLIMit:MAXimum <max>

Applicable Models: All

(Read-Write) Sets/gets the upper limit value of the bandwidth test, for the selected channel.

Parameters

- <cnum> Channel number of the measurement. There must be a selected measurement on that channel. If unspecified, <cnum> is set to 1.
- <mnum> Measurement number for each measurement. There must be a selected measurement on the trace. If unspecified, <mnum> is set to 1.
- <max> Maximum bandwidth

Examples

```
CALC:MEAS:BLIM:MAX 1E6  
calculate2:measure2:blimit:maximum 1E6
```

Query Syntax

CALCulate<cnum>:MEASure<mnum>:BLIMit:MAXimum?

Return Type

Numeric

Default

CALCulate<cnum>:MEASure<mnum>:BLIMit:MINimum <min>

Applicable Models: All

(Read-Write) Sets or returns the lower limit value of the bandwidth test, for the selected channel.

Parameters

- <cnun> Channel number of the measurement. There must be a selected measurement on that channel. If unspecified, <cnun> is set to 1.
- <mnum> Measurement number for each measurement. There must be a selected measurement on the trace. If unspecified, <mnum> is set to 1.
- <min> Minimum bandwidth

Examples

```
CALC:MEAS:BLIM:MIN 1E6  
calculate2:measure2:blimit:minimum 1E6
```

Query Syntax CALCulate<cnun>:MEASure<mnum>:BLIMit:MINimum?

Return Type Numeric

Default

CALCulate<cnun>:MEASure<mnum>:BLIMit:REPort[:DATA]?

Applicable Models: All

(Read-only) Read the bandwidth value of the bandwidth test, for the active trace of selected channel.

Parameters

- <cnun> Channel number of the measurement. There must be a selected measurement on that channel. If unspecified, <cnun> is set to 1.
- <mnum> Measurement number for each measurement. There must be a selected measurement on the trace. If unspecified, <mnum> is set to 1.

Examples

```
CALC:MEAS:BLIM:REP:DATA?  
calculate2:measure2:blimit:report:data?
```

Query Syntax CALCulate<cnun>:MEASure<mnum>:BLIMit:REPort:DATA?

Return Type Variant

Default OFF

CALCulate<cnun>:MEASure<mnum>:BLIMit[:STATe]

Applicable Models: All

(Read-Write) Turns ON/OFF the bandwidth test function, for the active trace of selected channel.

Parameters

- <cnm> Channel number of the measurement. There must be a selected measurement on that channel. If unspecified, <cnm> is set to 1.
- <mnm> Measurement number for each measurement. There must be a selected measurement on the trace. If unspecified, <mnm> is set to 1.
- <bool> ON or 1 - Turns limit testing ON.
OFF or 0 - Turns limit testing OFF.

Examples

```
CALC:MEAS:LIM:STAT ON  
calculate2:measure2:limit:state off
```

Query Syntax CALCulate<cnm>:MEASure<mnm>:BLIMit:DIPLay:MARKer:STATe?

Return Type Boolean

Default OFF

CALCulate:MEASure:Correction Commands

Controls error correction functions.

CALCulate:MEASure:CORRection
EDELay
DISTance
MEDium
[:TIME]
UNIT
WGCutoff
[:STATe]
INDicator?
TYPE

Click a [keyword](#) to view the command details.

See Also

- [Calibrating with SCPI](#)
- [Synchronizing the Analyzer and Controller](#)
- [SCPI Command Tree](#)

CALCulate<cnum>:MEASure<mnum>:CORRection:EDELay:DISTance <num>

Applicable Models: All

(Read-Write) Sets the electrical delay in physical length (distance) for the selected measurement.

Parameters

- <num> Channel number of the measurement. There must be a selected measurement on that channel. If unspecified, <num> is set to 1.
- <mnum> Measurement number for each measurement. There must be a selected measurement on the trace. If unspecified, <mnum> is set to 1.
- <num> Electrical delay in distance.

First Specify units using **CALC:MEAS:CORR:EDEL:UNIT**

Use **SENS:CORR:RVEL:COAX** <num> to set Velocity factor.

This parameter supports MIN and MAX as arguments. [Learn more.](#)

Examples

```
CALC1:MEAS2:CORR:EDEL:DIST 5  
calculate2:measure2:correction:edelay:distance .003
```

Query Syntax CALCulate<num>:MEASure<mnum>:CORRection:EDELay:DIStance?

Return Type Numeric

Default 0

CALCulate<num>:MEASure<mnum>:CORRection:EDELay:MEDEium <char>

Applicable Models: All

(Read-Write) Sets the media used when calculating the electrical delay.

Parameters

- <num> Any existing channel number. There must be a selected measurement on that channel. If unspecified, value is set to 1.
- <mnum> Measurement number for each measurement. There must be a selected measurement on the trace. If unspecified, <mnum> is set to 1.
- <num> Choose from: **COAX** for coaxial medium, **WAVEguide** for waveguide medium.

Examples

```
CALC:MEAS2:CORR:EDEL:MED COAX  
calc3:measure2:correction:edelay:medium waveguide
```

Query Syntax CALCulate<num>:MEASure<mnum>:CORRection:EDELay:MEDEium?

Return Type Character

Default COAX

CALCulate<cnum>:MEASure<mnum>:CORRection:EDELay[:TIME] <num>

Applicable Models: All

(Read-Write) Sets the electrical delay for the selected measurement.

Parameters

<cnum> Channel number of the measurement. There must be a selected measurement on that channel. If unspecified, <cnum> is set to 1.

<mnum> Measurement number for each measurement. There must be a selected measurement on the trace. If unspecified, <mnum> is set to 1.

<num> Electrical delay in seconds. Choose any number between:

-10.00 and 10.00

Use **SENS:CORR:RVEL:COAX <num>** to set Velocity factor.

This parameter supports MIN and MAX as arguments. [Learn more.](#)

Examples

```
CALC1:MEAS2:CORR:EDEL:TIME 1NS  
calculate2:measure2:correction:time 0.5e-12
```

Query Syntax CALCulate<cnum>:MEASure<mnum>:CORRection:EDELay[:TIME]?

Return Type Numeric

Default 0 seconds

CALCulate<cnum>:MEASure<mnum>:CORRection:EDELay:UNIT <char>

Applicable Models: All

(Read-Write) Sets and returns the units for specifying electrical delay in physical length (distance).

Parameters

- <num> Any existing channel number. There must be a selected measurement on that channel. If unspecified, value is set to 1.
- <mnum> Measurement number for each measurement. There must be a selected measurement on the trace. If unspecified, <mnum> is set to 1.
- <char> Units for delay in distance. Choose from:
 - METer
 - FEET
 - INCH

Examples

```
CALC:MEAS2:CORR:EDEL:UNIT MET  
calc3:meas2:corr:edelay:unit inch
```

Query Syntax CALCulate<num>:MEASure<mnum>:CORRection:EDELay:UNIT?

Return Type Character

Default METer

CALCulate<num>:MEASure<mnum>:CORRection:EDELay:WGCutoff <num>

Applicable Models: All

(Read-Write) Sets the waveguide cutoff frequency used when the electrical delay media is set to WAVEguide. (See **CALCulate:MEAS:CORRection:EDELay:MEDIum <char>**.)

Parameters

- <num> Any existing channel number. There must be a selected measurement on that channel. If unspecified, value is set to 1.
- <mnum> Measurement number for each measurement. There must be a selected measurement on the trace. If unspecified, <mnum> is set to 1.
- <num> Waveguide cutoff frequency used with the electrical delay calculation.

This parameter supports MIN and MAX as arguments. [Learn more.](#)

Examples

```
CALC:MEAS2:CORR:EDEL:WGC 18.067 GHz
```

```
calculate3:measure2:correction:edelay:wgcutoff 14.047 ghz
```

Query Syntax CALCulate<cnum>:MEASure<mnum>:CORRection:EDELay:WGCutoff?

Return Type Numeric

Default 45 MHz

CALCulate<cnum>:MEASure<mnum>:CORRection[:STATe] <bool>

Applicable Models: All

(Read-Write) Turns error correction ON or OFF for the selected measurement on the specified channel.

To turn error correction ON or OFF for a channel, use **SENS:CORR:STATe**.

Parameters

<cnum> Any existing channel number. There must be a selected measurement on that channel. If unspecified, value is set to 1

<mnum> Measurement number for each measurement. There must be a selected measurement on the trace. If unspecified, <mnum> is set to 1.

<bool> Correction state. Choose from:

0 - Correction OFF

1 - Correction ON

Examples

```
CALC:MEAS2:CORR ON
```

```
calculate:measure2:correction:state off
```

Query Syntax CALCulate<cnum>:MEASure<mnum>:CORRection:STATe?

Return Type Boolean

Default Not Applicable

CALCulate<cnum>:MEASure<mnum>:CORRection[:STATe]:INDicator?

Applicable Models: All

(Read-only) Returns the error correction state for the selected measurement on the specified channel.

To turn error correction ON or OFF for a channel, use **SENS:CORR:STATe**.

Parameters

- <cnum> Any existing channel number. There must be a selected measurement on that channel. If unspecified, value is set to 1
- <mnum> Measurement number for each measurement. There must be a selected measurement on the trace. If unspecified, <mnum> is set to 1.

Examples

```
CALC:MEAS2:CORR:IND?
calculate2:measure2:correction:state:indicator?
```

Return Type Character

- NONE** - No error correction
- MAST** (Master) - Original error correction terms
- INT** - Error terms are interpolated. [Learn more.](#)
- DELT** - Delta Match calibration terms. [Learn more.](#)
- INV** - Error terms are not valid

Default NONE

CALCulate<cnum>:MEASure<mnum>:CORRection:TYPE <string>

Applicable Models: All

(Read-Write) Sets the Cal Type for the selected measurement on the specified channel. This is used when a Cal Set is applied. [Learn more about applying Cal Types.](#)

- Use **SENS:CORR:TYPE:CAT?** to list the Cal Types in the VNA.
- Use **SENS:CORR:CSET:TYPE:CAT?** to list the Cal Types contained in the active Cal Set for the channel.
- Use **SENS:CORR:COLL:METH** to set the Cal type to perform a new Unguided calibration,

Parameters

- <cnum> Any existing channel number. There must be a selected measurement on that channel. If unspecified, value is set to 1

<num> Measurement number for each measurement. There must be a selected measurement on the trace. If unspecified, <num> is set to 1.

<string> **(String)** Cal type. Case sensitive. Use one of the following:

For Full Calibrations (NO Power Cal included):

This command does not distinguish between TRL and SOLT. The same number of error terms is applied for both Cal Types.

"Full <n> Port(x,y,z...)"

where

<n> = the number of ports to calibrate

x,y,z = the port numbers to calibrate

For example:

```
"Full 4 Port (1,2,3,4) "
```

For Full Calibrations (including Power Cal):

After the Full <n> port, include the string, "with power"

For example:

```
"Full 4 Port with power (1,2,3,4) "
```

For Response Calibrations:

"Response(param)" OR

"ResponseAndIsolation(param)"

Where param =

- S-parameter. For example"

- "Response (S21) "

- "ResponseAndIsolation (A/R) "

- Single or ratioed receivers using either **logical receiver notation** or physical receiver notation. For example:

- "Response (A) "

- **"ResponseAndIsolation (a3/b4) "**

For Enhanced Response Calibrations:

"EnhancedResp(sourcePort, recPort)

Where:

- sourcePort = stimulus port number
- recPort = receiver port number

For FCA Calibrations:

[Learn more about this setting.](#)

- **"SMC_2P"** (Response + Input + Output) All four sweeps required. Most accurate.
- **"SMCRsp+IN"** No Output match. All four sweeps required.
- **"SMCRsp+OUT"** No Output match. All four sweeps required.
- **"SMCRsp"** No Input or Output match. Saves two sweeps.

For VMC, multiple Cal types are not available.

For Gain Compression Cal

where r = receive port; s = source port

- "GCA 2P (r,s)" - full 2-port cal
- "GCA Enh Resp (r,s)" - Enhanced Response Cal

Examples

CALC:MEAS2:CORR:TYPE "Scalar Mixer Cal"

Query Syntax

CALCulate<cnum>:MEASure<mnum>:CORRection:TYPE?

Return Type

String

Default

Not Applicable

CALCulate:MEASure:DATA Commands

Controls writing and reading VNA measurement data.

CALCulate:MEASure:
DATA
FDATa
FMEMory
SDATa
SMEMory
SNP?
PORTs?
SAVE

Click a [keyword](#) to view the command details.

See Also

- [Calibrating with SCPI](#)
- [Synchronizing the Analyzer and Controller](#)
- [SCPI Command Tree](#)
- See [CALCulate:MEASure:X:VALues](#) for stimulus point data.

(Write) CALCulate<cnum>:MEASure<mnum>:DATA:<char>,<data>

(Read) CALCulate<cnum>:MEASure<mnum>:DATA:<char>?

Applicable Models: All

Reads or writes Measurement data, Memory data, or Normalization Divisor data from the [Data Access Map](#) location.

- For Measurement data, use FDATa or SDATa
- For Memory data, use FMEM or SMEM. When querying memory, you must first store a trace into memory using [CALC:MEAS:MATH:MEMorize](#).

- For Normalization Divisor (Receiver Power Cal error term) data, use SDIV.
- Use **FORMat:DATA** to change the data type (<REAL,32>, <REAL,64> or <ASCii,0>).
- Use **FORMat:BORDER** to change the byte order. Use "NORMal" when transferring a binary block from LabView or VEE. For other programming languages, you may need to "SWAP" the byte order.

Equation Editor Notes:

- When equation editor is active on a trace in a standard S-parameter channel, Calc:Data returns the data from the parameter on the trace that was measured last. For example, for the equation "S22 + S33 + S11", then S33 is the last measured parameter because it uses source port 3.
- In **applications**, if equation editor is active and the original parameter for the trace is not requested anywhere in the channel, then zeros are returned. If the original parameter is being measured within the channel, then data for the original parameter is returned.
- In general, if an equation contains no measurement parameters, then data for the original parameter is returned.

Note: The Calc:Data SCORR command to read/write error terms is **Superseded** with **SENS:CORR:CSET:DATA**. SCORR commands do NOT accommodate greater than 12 error terms.

Parameters

<cnun> Channel number of the measurement. There must be a selected measurement on that channel. If unspecified, <cnun> is set to 1.

<mnum> Measurement number for each measurement. There must be a selected measurement on the trace. If unspecified, <mnum> is set to 1.

<char>

FDATA

Formatted **measurement** data to or from **Data Access Map** location. **Display** (access point 2).

Note: When querying FDATA, data is received in degrees. When setting phase using FDATA, the command expects the data in radians.

- Corrected data is returned when correction is ON.
- Uncorrected data is

returned when correction is OFF.

- Returns TWO numbers per data point for Polar and Smith Chart format.
- Returns one number per data point for all other formats.
- Format of the read data is same as the displayed format.

SDATA Complex measurement data.

Writes data to **Data Access Map** location. **Raw Measurement** (access point 0).

- When writing corrected data, and correction is ON, it will be corrected again, resulting in meaningless data.

Reads data from **Apply Error Terms** (access point 1).

- Returns TWO numbers per data point.
- Corrected data is returned when correction is ON.
- Uncorrected data is returned when correction is OFF.

FMEM Formatted memory data to or from **Data**

Access Map location.
Memory result (access point 4).

- Returns TWO numbers per data point for Polar and Smith Chart format.
- Returns one number per data point for all other formats.
- Format of the read data is same as the displayed format.
- Returned data reflects the correction level (ON|OFF) when the data was stored into memory.

SMEM

Complex memory data to or from **Data Access Map** location. **Memory** (access point 3).

- Returns TWO numbers per data point.
- Returned data reflects the correction level (ON|OFF) when the data was stored into memory.
- Returned data reflects the correction level (ON|OFF) when the data was stored into memory.

Examples

```
CALC:MEAS:DATA:FDATA Data(x)  
calculate2:measure2:data:sdata data(r,i)
```

See another [example](#) using this command.

Return Type

Block data
Not Applicable

CALCulate<cnum>:MEASure<mnum>:DATA:SNP? <n>

Applicable Models: All

(Read-only) Reads SnP data from the selected measurement. [Learn more about SnP data.](#)

This command is valid **ONLY** with standard S-parameter measurements.

Notes

- This command returns SNP data without header information, and in columns, not in rows as .SnP files. This means that the data returned from this command sends all frequency data, then all Sx1 magnitude or real data, then all Sx1 phase or imaginary data, and so forth.
- To avoid frequency rounding errors, specify **FORMat:DATA** <Real,64> or <ASCIi, 0>

Parameters

- <cnum> Channel number of the measurement. There must be a selected measurement on that channel. If unspecified, <cnum> is set to 1.
- <mnum> Measurement number for each measurement. There must be a selected measurement on the trace. If unspecified, <mnum> is set to 1.
- <n> Amount of data to return. If unspecified, <n> is set to 2. The number you specify must be less than or equal to the number of available ports on the VNA.

Choose from:

1 (S1P) returns 1-Port data for the active measurement if the active measurement is a reflection parameter such as S11 or S22. The behavior is UNDEFINED if the active measurement is a transmission parameter such as an S21.

2 (S2P) returns data for the four 2 port parameters associated with the current measurement. Default. Data that is not available is zero-filled.

3 (S3P) returns data for the nine 3 port parameters associated with the current measurement. Data that is not available is zero-filled.

4 (S4P) returns data for the sixteen 4 port parameters associated with the current measurement. Data that is not available is zero-filled.

SnP data can be output using several data formatting options. See [MMEM:STORe:TRACe:FORMat:SNP](#).

See also [MMEM:STOR <file>.<snp>](#)

Examples `CALC:MEAS1:DATA:SNP? 1`

Return Type Depends on [FORMat:DATA](#).

Not Applicable

CALCulate<cnum>:MEASure<mnum>:DATA:SNP:PORTs? <"x,y,z">

Applicable Models: All

(Read-only) Reads SNP data from the selected measurement for the specified ports. [Learn more about SNP data.](#)

This command is valid **ONLY** with standard S-parameter measurements.

Notes

- This command returns SNP data without header information, and in columns, not in rows as .SnP files. This means that the data returned from this command sends all frequency data, then all Sx1 magnitude or real data, then all Sx1 phase or imaginary data, and so forth.
- To avoid frequency rounding errors, specify [FORM:DATA <Real,64>](#) or [<ASCIi, 0>](#)
- Data that is not available is zero-filled.
- For sweeps with a large number of data points, always follow this command with [*OPC?](#) [Learn more.](#)

Parameters

- <cnum>** Channel number of the measurement. There must be a selected measurement on that channel. If unspecified, <cnum> is set to 1.
- <mnum>** Measurement number for each measurement. There must be a selected measurement on the trace. If unspecified, <mnum> is set to 1.
- <"x,y,z">** Comma or space delimited port numbers for which data is requested, enclosed in quotes.

SNP data can be output using several data formatting options. See [MMEM:STORe:TRACe:FORMat:SNP](#).

Examples `CALC:MEAS2:DATA:SNP:PORTS? "1,2,4,5,7" 'read data for these ports`

Return Type Depends on `FORMat:DATA`
Not Applicable

CALCulate<cnum>:MEASure<mnum>:DATA:SNP:PORTs:SAVE <"x,y,z">,<filename>[, FAST]

Applicable Models: All

(Write-only) Saves SNP data from the selected measurement for the specified ports. [Learn more about SNP data.](#)

- The Normal vs Mixed Mode selection is NOT used as it is in the [Choose Ports dialog](#). Instead, data is returned as it is displayed on the trace. If the selected measurement is Mixed Mode (balanced), then balanced data is returned. If the selected measurement is an S-parameter, then S-parameter data is returned.
- This command is valid **ONLY** with the Standard measurement class (NOT applications).
- Data that is not available is zero-filled.
- For sweeps with a large number of data points, always follow this command with *OPC? [Learn more.](#)

Parameters

- <cnum> Channel number of the measurement. There must be a selected measurement on that channel. If unspecified, <cnum> is set to 1.
- <"x,y,z"> **String** Comma or space delimited port numbers for which data is requested, enclosed in quotes.
- <filename> **String** Path, filename, and suffix of location to store the SNP data, enclosed in quotes. The suffix is not checked for accuracy. If saving 2 ports, specify "filename.s2p"; If saving 4 ports, specify "filename.s4p.", and so forth.

SNP data can be output using several data formatting options. See [MMEM:STORe:TRACe:FORMat:SNP](#).

[, FAST] Reduce the saving time

[:SENS:CORR:CACH:MODE](#) should be set at ON.

The correction must cover all the ports of the SNP port list.

The active measurement must be a corrected S Parameter defined by the port list for the SNP requests. EG: "S33" is not a proper selected measurement with `CALC:DATA:SNP:PORTS? <1,2>`

Examples

```
CALC:MEAS2:DATA:SNP:PORTs:Save '1,2,4','D:\MyData.s3p';*OPC?
```

Return Type

Depends on **FORMat:DATA**

Not Applicable

CALCulate:MEASure:FILter Commands

Controls the gating function used in time domain measurements. The gated range is specified with either (start / stop) or (center / span) commands.

CALCulate:MEASure:FILter
[:GATE]
COUPlE
PARAmeters
TIME
CENTer
SHAPe
SPAN
STARt
STATe
STOP
[:TYPE]

Click a [keyword](#) to view the command details.

see Also

- [Learn about Gating](#)
- [Synchronizing the Analyzer and Controller](#)
- [SCPI Command Tree](#)

CALCulate<cnum>:MEASure<mnum>:FILTer[:GATE]:COUPlE:PARAmeters <num>

Applicable Models: All

(Read-Write) Specifies the time domain gating parameters to be coupled. The settings for those parameters will be copied from the selected measurement to all other measurements on the channel.

- To enable Trace Coupling, use **SENS:COUP:PAR**
- To specify Transform parameters to couple, use **CALC:MEAS:TRAN:COUP:PAR**

Learn more about [Time Domain Trace Coupling](#)

Parameters

- <num> Channel number of the measurement. There must be a selected measurement on that channel. If unspecified, <num> is set to 1.
- <mnum> Measurement number for each measurement. There must be a selected measurement on the trace. If unspecified, <mnum> is set to 1.
- <num> (Numeric) Parameters to couple. To specify more than one parameter, add the numbers.
- 1 - Gating Stimulus (Start, Stop, Center, and Span TIME settings.)
 - 2 - Gating State (ON / OFF)
 - 4 - Gating Shape (Minimum, Normal, Wide, and Maximum)
 - 8 - Gating Type (Bandpass and Notch)

Examples

```
'To couple all parameters:  
CALC:MEAS2:FILT:COUP:PAR 15  
  
'To couple Stimulus and Type:  
calculate2:measure2:filter:gate:couple:parameters 9
```

Query Syntax CALCulate<num>:MEASure<mnum>:FILTer:GATE:COUPle:PARAmeters?

Return Type Numeric

Default 13 (All parameters except 2 - Gating State)

CALCulate<num>:MEASure<mnum>:FILTer[:GATE]:TIME:CENTer <num>

Applicable Models: All

(Read-Write) Sets the gate filter center time.

Parameters

- <num> Channel number of the measurement. There must be a selected measurement on that channel. If unspecified, <num> is set to 1.
- <mnum> Measurement number for each measurement. There must be a selected measurement on the trace. If unspecified, <mnum> is set to 1.
- <num> Center time in seconds; Choose any number between:
± (number of points-1) / frequency span

Note: This command will accept **MIN** or **MAX** instead of a numeric parameter. See **SCPI Syntax** for more information.

Examples

```
CALC:MEAS2:FILT:GATE:TIME:CENT -5 ns
calculate2:measure2:filter:time:center maximum
```

Query Syntax CALCulate<num>:MEASure<mnum>:FILTer[:GATE]:TIME:CENTer?

Return Type Numeric

Default 0

CALCulate<num>:MEASure<mnum>:FILTer[:GATE]:TIME:SHAPE <char>

Applicable Models: All

(Read-Write) Sets the gating filter shape when in time domain.

Parameters

- <num> Channel number of the measurement. There must be a selected measurement on that channel. If unspecified, <num> is set to 1.
- <mnum> Measurement number for each measurement. There must be a selected measurement on the trace. If unspecified, <mnum> is set to 1.
- <char> Choose from
MAXimum - the widest gate filter available
WIDE -
NORMal -
MINimum - the narrowest gate filter available

Examples

```
CALC:MEAS2:FILT:GATE:TIME:SHAP MAX
calculate2:measure2:filter:time:shape normal
```

Query Syntax	CALCulate<cnum>:MEASure<mnum>:FILTer[:GATE]:TIME:SHAPE?
Return Type	Character
Default	NORMAL

CALCulate<cnum>:MEASure<mnum>:FILTer[:GATE]:TIME:SPAN <num>

Applicable Models: All

(Read-Write) Sets the gate filter span time.

Parameters

- <cnum> Channel number of the measurement. There must be a selected measurement on that channel. If unspecified, <cnum> is set to 1.
- <mnum> Measurement number for each measurement. There must be a selected measurement on the trace. If unspecified, <mnum> is set to 1.
- <num> Time span in seconds; Choose any number between:
0 and $2 * [(number\ of\ points - 1) / frequency\ span]$

Note: This command will accept **MIN** or **MAX** instead of a numeric parameter. See **SCPI Syntax** for more information.

Examples

```
CALC:MEAS2:FILT:GATE:TIME:SPAN 5 ns
calculate2:measure2:filter:time:span maximum
```

Query Syntax	CALCulate<cnum>:MEASure<mnum>:FILTer[:GATE]:TIME:SPAN?
Return Type	Numeric
Default	20 ns

CALCulate<cnum>:MEASure<mnum>:FILTer[:GATE]:TIME:START <num>

Applicable Models: All

(Read-Write) Sets the gate filter start time.

Parameters

- <cnum> Channel number of the measurement. There must be a selected measurement on that channel. If unspecified, <cnum> is set to 1.
- <mnum> Measurement number for each measurement. There must be a selected measurement on the trace. If unspecified, <mnum> is set to 1.
- <num> Start time in seconds; any number between:
± (number of points-1) / frequency span

Note: This command will accept **MIN** or **MAX** instead of a numeric parameter. See **SCPI Syntax** for more information.

Examples

```
CALC:MEAS2:FILT:TIME:STAR 1e-8
calculate2:measure2:filter:gate:time:start minimum
```

Query Syntax CALCulate<cnum>:MEASure<mnum>:FILTer[:GATE]:TIME:STARt?

Return Type Numeric

Default 10 ns

CALCulate<cnum>:MEASure<mnum>:FILTer[:GATE]:TIME:STATe <boolean>

Applicable Models: All

(Read-Write) Turns gating state ON or OFF.

Note: Sweep type must be set to LInear Frequency in order to use Transform Gating.

Parameters

- <cnum> Channel number of the measurement. There must be a selected measurement on that channel. If unspecified, <cnum> is set to 1.
- <mnum> Measurement number for each measurement. There must be a selected measurement on the trace. If unspecified, <mnum> is set to 1.
- <boolean> **ON** (or 1) - turns gating ON.
OFF (or 0) - turns gating OFF.

Examples

```
CALC:MEAS2:FILT:TIME:STAT ON
calculate2:measure2:filter:gate:time:state off
```

Query Syntax CALCulate<cnum>:MEASure<mnum>:FILTer[:GATE]:TIME:STATe?

Return Type Boolean (1 = ON, 0 = OFF)

Default OFF

CALCulate<cnum>:MEASure<mnum>:FILTer[:GATE]:TIME:STOP <num>

Applicable Models: All

(Read-Write) Sets the gate filter stop time.

Parameters

- <cnum> Channel number of the measurement. There must be a selected measurement on that channel. If unspecified, <cnum> is set to 1.
- <mnum> Measurement number for each measurement. There must be a selected measurement on the trace. If unspecified, <mnum> is set to 1.
- <num> Stop time in seconds; any number between:
 $\pm (\text{number of points}-1) / \text{frequency span}$

Note: This command will accept **MIN** or **MAX** instead of a numeric parameter. See [SCPI Syntax](#) for more information.

Examples

```
CALC:MEAS2:FILT:TIME:STOP -1 ns  
calculate2:measure2:filter:gate:time:stop maximum
```

Query Syntax CALCulate<cnum>:MEASure<mnum>:FILTer[:GATE]:TIME:STOP?

Return Type Numeric

Default 10 ns

CALCulate<cnum>:MEASure<mnum>:FILTer[:GATE]:TIME[:TYPE] <char>

Applicable Models: All

(Read-Write) Sets the type of gate filter used.

Parameters

- <cnum> Channel number of the measurement. There must be a selected measurement on that channel. If unspecified, <cnum> is set to 1.
- <mnum> Measurement number for each measurement. There must be a selected measurement on the trace. If unspecified, <mnum> is set to 1.
- <char> Choose from:
 - BPASs** - Includes (passes) the range between the start and stop times.
 - NOTCh** - Excludes (attenuates) the range between the start and stop times.

Examples

```
CALC:MEAS2:FILT:TIME BPAS  
calculate2:measure2:filter:gate:time:type notch
```

Query Syntax CALCulate<cnum>:MEASure<mnum>:FILTer[:GATE]:TIME[:TYPE]?

Return Type Character

Default BPAS

CALCulate:MEASure:FUNction

DATA?

DOMain

| **USER**

| **[:RANGe]**

| **START**

| **STOP**

EXECute

STATistics

| **[:STATe]**

TYPE

Click a [keyword](#) to view the command details.

see Also

- [Learn about Trace Statistics](#)
- [Synchronizing the Analyzer and Controller](#)
- [SCPI Command Tree](#)

CALCulate<cnum>:MEASure<mnum>:FUNction:DATA?

Applicable Models: All

(Read-only) Returns the trace statistic data for the selected statistic type for the specified channel. Select the type of statistic with **CALC:MEAS:FUNC:TYPE**.

Parameters

- <num> Channel number of the measurement. There must be a selected measurement on that channel. If unspecified, <num> is set to 1.
- <mnum> Measurement number for each measurement. There must be a selected measurement on the trace. If unspecified, <mnum> is set to 1.

Return Type Depends on **FORM:DATA**

Example

```
CALCulate2:MEASure2:FUNction:DATA?
```

Default Not applicable

CALCulate<num>:MEASure<mnum>:FUNction:DOMain:USER[:RANGe] <range>

Applicable Models: All

(Read-Write) Sets the range used to calculate trace statistics. Each channel has 16 user ranges. The x-axis range is specified with the **CALC:MEAS:FUNC:DOM:USER:START** and **STOP** commands.

Parameters

- <num> Channel number of the measurement. There must be a selected measurement on that channel. If unspecified, <num> is set to 1.
- <mnum> Measurement number for each measurement. There must be a selected measurement on the trace. If unspecified, <mnum> is set to 1.
- <range> Range number. Choose from: **0** to **16**

0 is Full Span of the current x-axis range

1 to 16 are user-specified ranges

Examples

```
CALC:MEAS2:FUNC:DOM:USER 4
calculate2:measure2:function:domain:user:range 0
```

Query Syntax CALCulate<num>:MEASure<mnum>:FUNction:DOMain:USER[:RANGe]?

Return Type Numeric

Default 0 - Full Span

CALCulate<cnum>:MEASure<mnum>:FUNCTion:DOMain:USER:START <range>, <start>

Applicable Models: All

(Read-Write) Sets the start of the specified user-domain range.

To apply this range, use **CALC:MEAS:FUNC:DOM:USER**

To set the stop of the range, use **CALC:MEAS:FUNC:DOM:USER:STOP**.

Note: This command does the same as **CALC:MEAS:MARK:FUNC:DOM:USER:STAR**

Parameters

- <cnum> Channel number of the measurement. There must be a selected measurement on that channel. If unspecified, <cnum> is set to 1.
- <mnum> Measurement number for each measurement. There must be a selected measurement on the trace. If unspecified, <mnum> is set to 1.
- <range> Range number that will receive the start value. Choose an integer between **1** and **16**
- <start> Start value of the specified range. Choose a real number between: the analyzer's **Minimum** and **Maximum** x-axis value.

Examples

```
CALC:MEAS2:FUNC:DOM:USER:STAR 1,1e9  
calculate2:measure2:function:domain:user:start 2,2e9
```

Query Syntax CALCulate<cnum>:MEASure<mnum>:FUNCTion:DOMain:USER:START? <range>

Return Type Numeric

Default The analyzer's **Minimum** x-axis value

CALCulate<cnum>:MEASure<mnum>:FUNCTion:DOMain:USER:STOP <range>, <stop>

Applicable Models: All

(Read-Write) Sets the stop value of the specified user-domain range.

To apply this range, use **CALC:MEAS:FUNC:DOM:USER**.

To set the start of the range, use **CALC:MEAS:MARK:FUNC:DOM:USER:STAR**

Note: This command does the same as **CALC:MEAS:MARK:FUNC:DOM:USER:STOP**

Parameters

- <cnum> Channel number of the measurement. There must be a selected measurement on that channel. If unspecified, <cnum> is set to 1.
- <mnum> Measurement number for each measurement. There must be a selected measurement on the trace. If unspecified, <mnum> is set to 1.
- <range> Range number that will receive the stop value. Choose an integer between **1** and **16**
- <stop> Stop value of the specified range. Choose a real number between: the analyzer's **Minimum** and **Maximum** x-axis value.

Examples

```
CALC:MEAS2:FUNC:DOM:USER:STOP 4,5e9  
calculate2:measure2:function:domain:user:stop 3,8e9
```

Query Syntax CALCulate<cnum>:MEASure<mnum>:FUNCtion:DOMain:USER:STOP?<range>

Return Type Numeric

Default The analyzer's **Maximum** x-axis value

CALCulate<cnum>:MEASure<mnum>:FUNCtion:EXECute

Applicable Models: All

(Write-only) For the active trace of specified channel, executes the statistical analysis specified by the **CALC:MEAS:FUNC:TYPE** command.

Parameters

- <cnm> Channel number of the measurement. There must be a selected measurement on that channel. If unspecified, <cnm> is set to 1.
- <mnm> Measurement number for each measurement. There must be a selected measurement on the trace. If unspecified, <mnm> is set to 1.

Examples

```
CALC:MEAS2:FUNC:EXEC  
calculate2:measure2:function:execute
```

Query Syntax Not Applicable

Default Not Applicable

CALCulate<cnm>:MEASure<mnm>:FUNCtion:STATistics[:STATe] <ON|OFF>

Applicable Models: All

(Read-Write) Displays and hides the trace statistics (peak-to-peak, mean, standard deviation) on the screen.

The analyzer will display either measurement statistics or Filter Bandwidth statistics; not both.

Parameters

- <cnm> Channel number of the measurement. There must be a selected measurement on that channel. If unspecified, <cnm> is set to 1.
- <mnm> Measurement number for each measurement. There must be a selected measurement on the trace. If unspecified, <mnm> is set to 1.
- <ON|OFF> ON - Displays trace statistics
OFF - Hides trace statistics

Examples

```
CALC:MEAS2:FUNC:STAT ON  
calculate2:measure2:function:statistics:state off
```

Query Syntax CALCulate<cnm>:MEASure<mnm>:FUNCtion:STATistics[:STATe]?

Return Type Boolean (1 = ON, 0 = OFF)

Default OFF (0)

CALCulate<cnum>:MEASure<mnum>:FUNCTion:TYPE <char>

Applicable Models: All

(Read-Write) Sets statistic TYPE that you can then query using `CALC:MEAS:FUNCTION:DATA?`.

Note: This command affects only the selected measurement on the specified channel.

Parameters

<cnum> Channel number of the measurement. There must be a selected measurement on that channel. If unspecified, <cnum> is set to 1.

<mnum> Measurement number for each measurement. There must be a selected measurement on the trace. If unspecified, <mnum> is set to 1.

<char> Choose from:

PTPeak - the difference between the max and min data points on the trace.

STDEV - standard deviation of all data points on the trace

MEAN - mean (average) of all data points on the trace

MIN - lowest data point on the trace

MAX - highest data point on the trace

Examples

```
CALC:MEAS2:FUNC:TYPE PTP  
calculate2:measure2:function:type stdev
```

Query Syntax CALCulate<cnum>:MEASure<mnum>:FUNCTion:TYPE?

Return Type Character

Default PTPeak

CALCulate:MEASure:GCData Commands

Reads Gain Compression data from the current Gain Compression acquisition.

CALCulate:MEASure:GCData
DATA
IMAG
ITERations
REAL

Click a [keyword](#) to view the command details.

Other Gain Compression commands

The calibration commands listed in this topic are supplemental to the Guided Cal commands.

- [CALC:MEAS:DEFine](#) - creates a gain compression measurement.
- [SENS:GCSetup](#) - Most Gain Compression settings.
- [CALC:MEAS:GCMeas:ANAL](#) - Gain Compression Analysis settings
- Gain compression data can also be saved to a *.csv file. [Learn how.](#)

See Also

- [Learn about Gain Compression Application](#)
- [Synchronizing the Analyzer and Controller](#)
- [SCPI Command Tree](#)

CALCulate<ch>:MEASure<mnum>:GCData:DATA? <param>

Applicable Models: N522xB, N524xB, M9485A

(Read-Only) Returns measurement data at all frequency and power data points for GCA SMART sweeps and 2D sweeps.

- When using SMART sweep, ALL data is returned including ALL background iteration sweeps. Use [CALC:MEAS:GCD:ITER](#) to determine the number of iteration sweeps. The number of data points that are returned is always going to be number of frequency points times the number of iteration sweeps.
- When using 2D sweeps, ALL data is returned. The number of data points returned / freq may vary. [Learn](#)

[more.](#)

Use `CALC:MEAS:DATA?` to return just the displayed data results (not the background sweeps).

A compression parameter must be present. [Learn more.](#)

The format of the data is the same as the format of the measurement that you select using `CALC:MEAS:PAR`. If the measurement is scalar, than one number is returned per sweep per data point. If complex (such as Smith Chart format) than both real and imaginary numbers are returned.

If correction is on, corrected data are returned. Otherwise, raw data are returned.

Parameters

- `<ch>` Any existing channel number. There must be a selected measurement on that channel. If unspecified, value is set to 1
- `<mnum>` Measurement number for each measurement. There must be a selected measurement on the trace. If unspecified, `<mnum>` is set to 1.
- `<param>` (String) Parameter to read. NOT Case-sensitive. The specified parameter need NOT be displayed or selected. However, a compression parameter must be present. [Learn more.](#)

Choose from:

- **"pin"** - (CompIn21) Input power at the compression point.
- **"pout"** - (CompOut21) Output power at the compression point.
- **"gain"** - (CompGain21) Device gain (S21) at the compression point.
- **"inputmatch"** - (CompS11) Input match at the compression point.
- **"DeltaGain"** - (DeltaGain21) Measured Gain (watts) / Ref Gain (watts). [Learn more.](#)
- **"AI1"** and **"AI2"** - ADC measurements at the specified compression level. [Learn more.](#)

[Learn more about GCA parameters.](#)

Examples

```
data = CALC:MEAS2:GCD:DATA? "pin"  
data = calculate:measure2:gcddata:data? "pout"
```

Return Type Array of data

Default Not Applicable

CALCulate<ch>:MEASure<mnum>:GCData:IMAG? <char>, <dpoint>, <param>

Applicable Models: N522xB, N524xB, M9485A

(Read-Only) For a specified data point, returns the imaginary part of the specified Gain Compression data. If correction is on, corrected data are returned. Otherwise, raw data are returned. Can be used with Smart and 2D sweeps.

- For SMART sweep, the number of data points that are returned is always going to be the number of iteration sweeps. Use **CALC:MEAS:GCD:ITER** to determine the number of iteration sweeps.
- For 2D sweeps, the number of data points returned / freq may vary. [Learn more.](#)

Parameters

- <ch> Any existing channel number. There must be a selected measurement on that channel. If unspecified, value is set to 1
- <mnum> Measurement number for each measurement. There must be a selected measurement on the trace. If unspecified, <mnum> is set to 1.
- <char> Choose from:
 - **FREQuency** - for the specified frequency data point, returns all of the measured data for each power stimulus.
 - **POWer** - for the specified power data point, returns all of the measured data for each frequency stimulus.
- <dPoint> Data point (FREQ or POWer) for which data is returned.
- <param> (String) Parameter to read. NOT Case-sensitive. The specified parameter need NOT be displayed. However, a compression parameter must be present. [Learn more.](#)
 - **"pin"** - (CompIn21) Input power at the compression point.
 - **"pout"** - (CompOut21) Output power at the compression point.
 - **"gain"** - (CompGain21) Device gain (S21) at the compression point.
 - **"inputmatch"** - (CompS11) Input match at the compression point.
 - **"DeltaGain"** - (DeltaGain21) Measured Gain (watts) / Ref Gain (watts). [Learn more.](#)
 - **"AI1"** and **"AI2"** - ADC measurements at the specified compression level. [Learn more.](#)

Examples For the fifth frequency data point, returns 'Power Output' imaginary (phase) data from all power stimulus values.

For SmartSweep, if there are 30 power sweep points, 30 values are returned.

For 2D sweeps, 30 or 31 power sweep points may be returned. [Learn more.](#)

```
data = CALC:MEAS2:GCD:IMAG? FREQ,5,"pout"
```

Return Type Array of data

Default Not Applicable

CALCulate<cnum>:MEASure<mnum>:GCData:ITERations?

Applicable Models: N522xB, N524xB, M9485A

(Read-only) In a SMART sweep, returns the max number of iterations that it took for ALL frequencies to converge. Use this number to determine the size of the block data that is returned from Gain Compression SMART sweep data queries.

For a 2D sweep, returns the number of power points.

Parameters

<cnum> Channel number of the measurement. There must be a selected measurement on that channel. If unspecified, <cnum> is set to 1.

<mnum> Measurement number for each measurement. There must be a selected measurement on the trace. If unspecified, <mnum> is set to 1.

Examples

```
data = CALC:MEAS2:GCD:ITER?
```

Return Type Numeric

Default Not Applicable

CALCulate<ch>:MEASure<mnum>:GCData:REAL? <char>, <dpoint>, <param>

Applicable Models: N522xB, N524xB, M9485A

(Read-Only) For a specified data point, returns the real part of the Gain Compression data. If correction is on, corrected data are returned. Otherwise, raw data are returned. Can be used with Smart and 2D sweeps.

- For SMART sweep, the number of data points that are returned is always going to be the number of iteration sweeps. Use `CALC:MEAS:GCD:ITER` to determine the number of iteration sweeps.
- For 2D sweeps, the number of data points returned / freq may vary. [Learn more.](#)

Parameters

- <ch> Any existing channel number. There must be a selected measurement on that channel. If unspecified, value is set to 1
- <mnum> Measurement number for each measurement. There must be a selected measurement on the trace. If unspecified, <mnum> is set to 1.
- <char> Choose from:
- **FREQuency** - for the specified frequency data point, returns all of the measured data for each power stimulus.
 - **POWer** - for the specified power data point, returns all of the measured data for each frequency stimulus.
- <dPoint> Data point (FREQ or POWer) for which data is returned.
- <param> (String) Parameter to read. NOT Case-sensitive. The specified parameter need NOT be displayed. However, a compression parameter must be present. [Learn more](#).
- **"pin"** - (CompIn21) Input power at the compression point.
 - **"pout"** - (CompOut21) Output power at the compression point.
 - **"gain"** - (CompGain21) Device gain (S21) at the compression point.
 - **"inputmatch"** - (CompS11) Input match at the compression point.
 - **"DeltaGain"** - (DeltaGain21) Measured Gain (watts) / Ref Gain (watts). [Learn more](#).
 - **"AI1"** and **"AI2"** - ADC measurements at the specified compression level. [Learn more](#).

Examples

For the fifth frequency data point, returns 'Power Output' real data from all power stimulus values.

For SmartSweep, if there are 30 power sweep points, 30 values are returned.

For 2D sweeps, 30 or 31 power sweep points may be returned. [Learn more](#).

```
data = CALC:MEAS2:GCD:REAL? FREQ,5,"pout"
```

Return Type Array of data

Default Not Applicable

CALCulate:MEASure:GCMeas Commands

Sets and reads Gain Compression Analysis controls.

CALCulate:MEASure:GCMeas
ANALysis
CWFRequency
DISCcrete
[:STATe]
ENABle
XAXis

Click a [keyword](#) to view the command details.

Other Gain Compression commands

The calibration commands listed in this topic are supplemental to the Guided Cal commands.

- [CALC:MEAS:DEFine](#) - creates a gain compression measurement.
- [SENS:GCSetup](#) - Most Gain Compression settings.
- [CALC:MEAS:GCData](#) - Gain Compression data commands
- Gain compression data can also be saved to a *.csv file. [Learn how.](#)

See Also

- [Learn about Gain Compression Application](#)
- [Synchronizing the Analyzer and Controller](#)
- [SCPI Command Tree](#)

CALCulate<cnum>:MEASure<mnum>:GCMeas:ANALysis:CWFRequency <num>

Applicable Models: N522xB, N524xB, M9485A

(Read-Write) Set and return the CW frequency for a compression analysis trace.

Parameters

- <cnum> Channel number of the GCA measurement. There must be a selected measurement on that channel. If unspecified, <cnum> is set to 1.
- <mnum> Measurement number for each measurement. There must be a selected measurement on the trace. If unspecified, <mnum> is set to 1.
- <num> CW frequency in Hz. Choose a frequency within the range of the gain compression channel.

Examples

```
CALC:MEAS2:GCM:ANAL:CWFR 1e9  
calculate2:measure2:gcmeas:analysis:cwfrequency 1e10
```

Query Syntax CALCulate<cnum>:MEASure<mnum>:GCMeas:ANALysis:CWFRequency?

Return Type Numeric

Default Not Applicable

CALCulate<cnum>:MEASure<mnum>:GCMeas:ANALysis:DISCcrete[:STATe] <bool>

Applicable Models: N522xB, N524xB, M9485A

(Read-Write) Sets and returns whether the CW frequency for the compression analysis trace can be set to only the discrete frequencies or provides interpolation.

Parameters

- <cnum> Channel number of the GCA measurement. There must be a selected measurement on that channel. If unspecified, <cnum> is set to 1.
- <mnum> Measurement number for each measurement. There must be a selected measurement on the trace. If unspecified, <mnum> is set to 1.
- <bool> **ON** (or 1) - Discrete data points only.
OFF (or 0) - Interpolated data points.

Examples

```
CALC:MEAS2:GCM:ANAL:ISD ON  
calculate2:measure2:gcmeas:analysis:isdisfrequency off
```

Query Syntax CALCulate<cnum>:MEASure<mnum>:GCMeas:ANALysis:ISDisfrequency?

Return Type Boolean (1 = ON, 0 = OFF)

Default OFF

CALCulate<cnum>:MEASure<mnum>:GCMeas:ANALysis:ENABLE <bool>

Applicable Models: N522xB, N524xB, M9485A

(Read-Write) Enables and disables a compression analysis trace.

Parameters

- <cnum> Channel number of the GCA measurement. There must be a selected measurement on that channel. If unspecified, <cnum> is set to 1.
- <mnum> Measurement number for each measurement. There must be a selected measurement on the trace. If unspecified, <mnum> is set to 1.
- <bool> **ON** (or 1) - Enable compression analysis.
OFF (or 0) - Disable compression analysis.

Examples

```
CALC:MEAS2:GCM:ANAL:ENAB ON  
calculate2:measure2:gcm:analysis:enable off
```

Query Syntax CALCulate<cnum>:MEASure<mnum>:GCMeas:ANALysis:ENABLE?

Return Type Boolean (1 = ON, 0 = OFF)

Default OFF

CALCulate<cnum>:MEASure<mnum>:GCMeas:ANALysis:XAXis <char>

Applicable Models: N522xB, N524xB, M9485A

(Read-Write) Sets and returns the type of data to display on the x-axis of a compression analysis trace.

Parameters

- <cnum> Channel number of the GCA measurement. There must be a selected measurement on that channel. If unspecified, <cnum> is set to 1.
- <mnum> Measurement number for each measurement. There must be a selected measurement on the trace. If unspecified, <mnum> is set to 1.
- <bool> Data to display on X-axis. Choose from:
- **PIN** - Input power to the DUT.
 - **PSource** - power from the source.

Examples

```
CALC:MEAS2:GCM:ANAL:XAX PIN  
calculate2:measure2:gcm:analysis:xaxis psource
```

Query Syntax CALCulate<cnum>:MEASure<mnum>.GCMeas:ANALysis:XAXis?
Return Type Character
Default PIN

CALCulate:MEASure:GDElay Commands

Controls the Aperture setting used to make Group Delay measurements.

CALCulate:MEASure:GDElay
FREQuency
PERCent
POINts

Click a [keyword](#) to view the command details.

see Also

- [Learn about Group Delay Aperture](#)
- [Synchronizing the Analyzer and Controller](#)
- [SCPI Command Tree](#)

CALCulate<cnum>:MEASure<mnum>:GDElay:FREQuency <value>

Applicable Models: All

(Read-Write) Sets group delay aperture using a fixed frequency range.

Parameters

- <cnum> Channel number of the measurement. There must be a selected measurement on that channel. If unspecified, <cnum> is set to 1.
- <mnum> Measurement number for each measurement. There must be a selected measurement on the trace. If unspecified, <mnum> is set to 1.
- <value> Frequency range (in Hz) to use for the aperture setting. Choose between the equivalent of two data points and the channel frequency span.

Examples

```
CALC:MEAS2:GDEL:FREQ 1E6
```

Query Syntax CALCulate<cnum>:MEASure<mnum>:GDElay:FREQuency?

Return Type Numeric

Default Frequency range that equates to 11 points. This can be changed to two points with a [preference setting](#).

CALCulate<cnum>:MEASure<mnum>:GDElay:PERCent <value>

Applicable Models: All

(Read-Write) Sets group delay aperture using a percent of the channel frequency span.

Parameters

- <cnum> Channel number of the measurement. There must be a selected measurement on that channel. If unspecified, <cnum> is set to 1.
- <mnum> Measurement number for each measurement. There must be a selected measurement on the trace. If unspecified, <mnum> is set to 1.
- <value> Percent of frequency span to use for the aperture setting. Choose between the equivalent of two data points and 100 percent of the channel frequency span.

Examples

```
'set to 25 percent of the channel frequency span
```

```
CALC:MEAS2:GDEL:PERC 25
```

Query Syntax CALCulate<cnum>:MEASure<mnum>:GDElay:PERCent?

Return Type Numeric

Default Percent of frequency span that equates to 11 points. This can be changed to two points with a [preference setting](#).

CALCulate<cnum>:MEASure<mnum>:GDElay:POINts <value>

Applicable Models: All

(Read-Write) Sets group delay aperture using a fixed number of data points.

Parameters

- <cnum> Channel number of the measurement. There must be a selected measurement on that channel. If unspecified, <cnum> is set to 1.
- <mnum> Measurement number for each measurement. There must be a selected measurement on the trace. If unspecified, <mnum> is set to 1.
- <value> Number of data points to use for the aperture setting. Choose between two points and the number of points in the channel.

Examples

```
'set to 25 data points
```

```
CALC:MEAS2:GDEL:POIN 25
```

Query Syntax CALCulate<cnum>:MEASure<mnum>:GDElay:POINts?

Return Type Numeric

Default 11 points. This can be changed to two points with a [preference setting](#).

CALCulate:MEASure:LIMit Commands

Controls the limit segments used for pass / fail testing.

CALCulate:MEASure:LIMit
DATA
DELeTe
DISPlay
[[:STATe]
FAIL?
REPort
ALL?
[[:DATA]?
POINts?
SEGment
AMPLitude
STARt
STOP
COUNt?
STIMulus
STARt
STOP
TYPE
SOUNd
[[:STATe]
[[:STATe]

Click a [keyword](#) to view the command details.

see Also

- [Learn about Limit Lines](#)
- [Synchronizing the Analyzer and Controller](#)
- [SCPI Command Tree](#)

CALCulate<cnum>:MEASure<mnum>:LIMit:DATA <block>

Applicable Models: All

(Read-Write) Sets data for limit segments.

Parameters

- <cnum> Channel number of the measurement for which limit lines are to be set. There must be a selected measurement on that channel. If unspecified, <cnum> is set to 1.
- <mnum> Measurement number for each measurement. There must be a selected measurement on the trace. If unspecified, <mnum> is set to 1.
- <block> Data for all limit segments in REAL,64 format. The following is the data format for 1 segment:

Type,BegStim, EndStim, BegResp,EndResp

Type Type of limit segment. Choose from
 0 - Off
 1 - Max
 2 - Min

BegStim Start of X-axis value (freq, power, time)

EndStim End of X-axis value

BegResp Y-axis value that corresponds with Start of X-axis value

EndResp Y-axis value that corresponds with End of X-axis value

Examples

The following writes three max limit segments for a bandpass filter.

```
CALC:MEAS2:LIM:DATA 1,3e5,4e9,-
60,0,1,4e9,7.5e9,0,0,1,7.5e9,9e9,0,-30
```

Query Syntax CALCulate<cnum>:MEASure<mnum>:LIMit:DATA?

Return Type Depends on **FORM:DATA** - All 100 predefined limit segments are returned.

Default 100 limit segments - all values set to 0

CALCulate<cnum>:MEASure<mnum>:LIMit:DATA:DELeTe

Applicable Models: All

(Write-only) Deletes all limit line data for the selected measurement on the specified channel.

Parameters

<cnum> Channel number of the measurement. There must be a selected measurement on that channel. If unspecified, <cnum> is set to 1.

<mnum> Measurement number for each measurement. There must be a selected measurement on the trace. If unspecified, <mnum> is set to 1.

Examples

```
CALC2:MEAS2:LIM:DATA:DEL
```

Query Syntax Not Applicable

Default Not Applicable

CALCulate<cnum>:MEASure<mnum>:LIMit:DISPlay[:STATe] <ON | OFF>

Applicable Models: All

(Read-Write) Turns the display of limit segments ON or OFF (if the data trace is turned ON).

Parameters

<cnum> Channel number of the measurement. There must be a selected measurement on that channel. If unspecified, <cnum> is set to 1.

<mnum> Measurement number for each measurement. There must be a selected measurement on the trace. If unspecified, <mnum> is set to 1.

<ON | OFF> **ON** (or 1) - turns the display of limit segments ON.
OFF (or 0) - turns the display of limit segments OFF.

Examples

```
CALC:MEAS2:LIM:DISP:STAT ON  
calculate2:limit:display:state off
```

Query Syntax CALCulate<cnum>:MEASure<mnum>:LIMit:DISPlay[:STATe]?

Return Type Boolean (1 = ON, 0 = OFF)

Default ON

CALCulate<cnum>:MEASure<mnum>:LIMit:FAIL?

Applicable Models: All

(Read-only) Returns the Pass / Fail status of the limit line test. Returns 1 (Fail) if any data point fails for any limit segment.

Limit display (CALC:LIM:DISP) does NOT have to be ON.

Parameters

<cnum> Channel number of the measurement. There must be a selected measurement on that channel. If unspecified, <cnum> is set to 1.

<mnum> Measurement number for each measurement. There must be a selected measurement on the trace. If unspecified, <mnum> is set to 1.

Examples `CALC:MEAS2LIM:FAIL?`

Return Type Boolean

- **0** is returned when **Pass**
- **1** is returned when **Fail**

Default Not Applicable

CALCulate<cnum>:MEASure<mnum>:LIMit:REPort:ALL? <block>

Applicable Models: All

(Read-only) Reads the bandwidth test results (stimulus value, limit test result, upper limit value and lower limit value of all measurement points), for the active trace of selected channel.

Parameters

<cnum> Channel number of the measurement. There must be a selected measurement on that channel. If unspecified, <cnum> is set to 1.

<mnum> Measurement number for each measurement. There must be a selected measurement on the trace. If unspecified, <mnum> is set to 1.

<block> Depends on **FORM:DATA**

If the number of the measurement points is N,

<Block> = <first stimulus>,<test result>,<upper limit>,<lower limit>, ..., <Nth stimulus>,<test result>,<upper limit>,<lower limit>

Where <test result>= -1: No limit, 0:Fail, 1:Pass

Examples `CALC:MEAS:LIM:REP:ALL?`

Return Type Variant

Default Depend on the preset status

CALCulate<cnum>:MEASure<mnum>:LIMit:REPort[:DATA]? <block>

Applicable Models: All

(Read-only) Reads the stimulus values (frequency, power level or time) at all the measurement points that failed the limit test, for the active trace of selected channel.

Parameters

<cnum> Channel number of the measurement. There must be a selected measurement on that channel. If unspecified, <cnum> is set to 1.

<mnum> Measurement number for each measurement. There must be a selected measurement on the trace. If unspecified, <mnum> is set to 1.

<block> Depends on **FORM:DATA**

If the number of the measurement points that failed the limit test is N, <block>=<First failed stimulus>, ..., <Nth failed stimulus>.

Examples

```
CALC:MEAS:LIM:REP:DATA?
```

Return Type Numeric

Default 9.91E37

CALCulate<cnum>:MEASure<mnum>:LIMit:REPort:POINts?

Applicable Models: All

(Read-only) Reads the number of the measurement points that failed the limit test, for the active trace of selected channel.

Parameters

<cnum> Channel number of the measurement. There must be a selected measurement on that channel. If unspecified, <cnum> is set to 1.

<mnum> Measurement number for each measurement. There must be a selected measurement on the trace. If unspecified, <mnum> is set to 1.

Examples

```
CALC:MEAS:LIM:REP:POIN?
```

Query Syntax Numeric

Default 0

CALCulate<cnum>:MEASure<mnum>:LIMit:SEGment<snum>:AMPLitude:STARt <num>

Applicable Models: All

(Read-Write) Sets the start (beginning) of the Y-axis amplitude (response) value.

Parameters

- <num> Channel number of the measurement. There must be a selected measurement on that channel. If unspecified, <num> is set to 1.
- <mnum> Measurement number for each measurement. There must be a selected measurement on the trace. If unspecified, <mnum> is set to 1.
- <snum> Segment number; if unspecified, value is set to 1.
- <num> Choose any number between: **-500** and **500**

Display value is limited to the Maximum and Minimum displayed Y-axis values.

Examples

```
CALC:MEAS2LIM:SEGM1:AMPL:STAR 10  
calculate2:measure2:limit:segment2:amplitude:start 10
```

Query Syntax CALCulate<num>:MEASure<mnum>:LIMit:SEGment<snum>AMPLitude:STARt?

Return Type Numeric

Default 0

CALCulate<num>:MEASure<mnum>:LIMit:SEGment<snum>:AMPLitude:STOP <num>

Applicable Models: All

(Read-Write) Sets the stop (end) of the Y-axis amplitude (response) value.

Parameters

- <num> Channel number of the measurement. There must be a selected measurement on that channel. If unspecified, <num> is set to 1.
- <mnum> Measurement number for each measurement. There must be a selected measurement on the trace. If unspecified, <mnum> is set to 1.
- <snum> Segment number; if unspecified, value is set to 1.
- <num> Choose any number between: **-500** and **500**

Display value is limited to the Maximum and Minimum displayed Y-axis values.

Examples

```
CALC:MEAS:LIM:SEGM1:AMPL:STOP 10  
calculate2:measure2:limit:segment2:amplitude:stop 10
```

Query Syntax CALCulate<cnum>:MEASure<mnum>:LIMit:SEGMent<snum>AMPLitude:STOP?

Return Type Numeric

Default 0

CALCulate:MEASure<mnum>:LIMit:SEGMent:COUNT?

Applicable Models: All

(Read-only) Returns the number of segments used in a limit test. All segments are counted, whether they are on or not.

Parameters Not Applicable

<mnum> Measurement number for each measurement. There must be a selected measurement on the trace. If unspecified, <mnum> is set to 1.

Examples `CALC:MEAS2:LIM:SEGM:COUN?`

Return Type Numeric

Default Not Applicable

CALCulate<cnum>:MEASure<mnum>:LIMit:SEGMent<snum>:STIMulus:STARt <num>

Applicable Models: All

(Read-Write) Sets the start (beginning) of the X-axis stimulus value.

Parameters

<cnum> Channel number of the measurement. There must be a selected measurement on that channel. If unspecified, <cnum> is set to 1.

<mnum> Measurement number for each measurement. There must be a selected measurement on the trace. If unspecified, <mnum> is set to 1.

<snum> Segment number; if unspecified, value is set to 1.

<num> Choose any number within the X-axis span of the analyzer.

Examples `CALC:MEAS:LIM:SEGM1:STIM:STAR 10`
`calculate2:measure:limit:segment2:stimulus:start 10`

Query Syntax CALCulate<cnum>:MEASure<mnum>:LIMit:SEGMent<snum>STIMulus:STARt?

Return Type Numeric

Default 0

CALCulate<cnum>:MEASure<mnum>:LIMit:SEGment<snum>:STIMulus:STOP <num>

Applicable Models: All

(Read-Write) Sets the stop (end) of the X-axis stimulus value.

Parameters

- <cnum> Channel number of the measurement. There must be a selected measurement on that channel. If unspecified, <cnum> is set to 1.
- <mnum> Measurement number for each measurement. There must be a selected measurement on the trace. If unspecified, <mnum> is set to 1.
- <snum> Segment number; if unspecified, value is set to 1.
- <num> Choose any number within the X-axis span of the analyzer.

Examples

```
CALC:MEAS2:LIM:SEG1:AMPL:STOP 10  
calculate2:measure2:limit:segment2:stimulus:stop 10
```

Query Syntax CALCulate<cnum>:MEASure<mnum>:LIMit:SEGment<snum>STIMulus:STOP?

Return Type Numeric

Default 0

CALCulate<cnum>:MEASure<mnum>:LIMit:SEGment<snum>:TYPE <char>

Applicable Models: All

(Read-Write) Sets the type of limit segment.

Parameters

- <cnum> Channel number of the measurement. There must be a selected measurement on that channel. If unspecified, <cnum> is set to 1.
- <mnum> Measurement number for each measurement. There must be a selected measurement on the trace. If unspecified, <mnum> is set to 1.
- <snum> Segment number. Choose any number between:
1 and 100
If unspecified, value is set to 1.
- <char> Choose from:
LMAX - a MAX limit segment. Any response data exceeding the MAX value will fail.
LMIN - a MIN limit segment. Any response data below the MIN value will

fail.

OFF - the limit segment (display and testing) is turned OFF.

Examples

```
CALC:MEAS2:LIM:SEGM:TYPE LMIN  
calculate2:measure2:limit:segment3:type lmax
```

Query Syntax CALCulate<cnum>:MEASure<mnum>:LIMit:SEGMent<snum>:TYPE?

Return Type Character

Default OFF

CALCulate<cnum>:MEASure<mnum>:LIMit:SOUNd[:STATe] <ON | OFF>

Applicable Models: All

(Read-Write) Turns limit testing fail sound ON or OFF.

Parameters

<cnum> Channel number of the measurement. There must be a selected measurement on that channel. If unspecified, <cnum> is set to 1.

<mnum> Measurement number for each measurement. There must be a selected measurement on the trace. If unspecified, <mnum> is set to 1.

<ON | OFF> **ON** (or 1) - turns sound ON.
OFF (or 0) - turns sound OFF.

Examples

```
CALC:MEAS2:LIM:SOUN ON  
calculate2:measure2:limit:sound:state off
```

Query Syntax CALCulate<cnum>:MEASure<mnum>:LIMit:SOUNd[:STATe]?

Return Type Boolean (1 = ON, 0 = OFF)

Default OFF

CALCulate<cnum>:MEASure<mnum>:LIMit[:STATe] <ON | OFF>

Applicable Models: All

(Read-Write) Turns limit segment **testing** ON or OFF.

- Use **CALCulate:MEASure:LIMit:DISPlay** to turn ON and OFF the **display** of limit segments.
- If using **Global Pass/Fail** status, trigger the VNA AFTER turning Limit testing ON.

Parameters

- <cnm> Channel number of the measurement. There must be a selected measurement on that channel. If unspecified, <cnm> is set to 1.
- <mnum> Measurement number for each measurement. There must be a selected measurement on the trace. If unspecified, <mnum> is set to 1.
- <ON | OFF> **ON** (or 1) - turns limit testing ON.
OFF (or 0) - turns limit testing OFF.

Examples

```
CALC:MEAS:LIM:STAT ON  
calculate2:measure:limit:state off
```

Query Syntax CALCulate<cnm>:MEASure<mnum>:LIMit:STATe?

Return Type Boolean (1 = ON, 0 = OFF)

Default OFF

CALCulate:MEASure:MARKer Commands

Controls the marker settings used to remotely output specific data to the computer.

CALCulate:MEASure:MARKer:

AOFF

BUCKet

BWIDth

| **DATA?**

| **REF**

| **[:STATe]**

| **THReshold**

COUPling

| **METHod**

| **[:STATe]**

DELTA

DISCcrete

DISTance

FORMat

FUNction

| **APEak:POLarity**

| **COMPression**

| **LEVel**

| **PIN?**

| **POUT?**

| **[:STATe]**

| **DOMain**

| **USER**

| **[:RANGe]**

| **START**

| **STOP**

| **EXECute**

| **MULTI**

| **EXECute**

| **PEAK**

| **EXCursion**

| **POLarity**

| **THReshold**

| **SElect**

| **TARGet**

| **TRANSition**

| **[:VALue]**

| **TRACking**

| **PEAK**

| **EXCursion**

| **POLarity**

| **THReshold**

| **[:SElect]**

| **TARGet**

| **TRANSition**

| **[:VALue]**

| **TRACking**

NOTCh

| **DATA?**

| **REF**

| **[:STATe]**

| **THReshold**

PNOP

| **BACKoff**

 | **GAIN**

 | **PIN**

 | **POUT**

| **COMPression**

 | **MAXimum**

| **GAIN**

 | **MAXimum**

| **PIN**

 | **MAXimum**

| **POFFset**

| **POUT**

 | **MAXimum**

| **[:STATe]**

PSATuration

| **BACKoff**

| **COMPression**

 | **MAXimum**

 | **SATuration**

| **GAIN**

 | **LINear**

 | **MAXimum**

| **PIN**

 | **MAXimum**

| **POUT**

 | **MAXimum**

| **[:STATe]**

REFerence
[:STATe]
X
Y
SET
[:STATe]
TYPE
X
Y

Click a [k](#)eyword to view the command details.

See Also

- Marker Readout number and size commands.
- Learn about Markers
- Synchronizing the Analyzer and Controller
- SCPI Command Tree

CALCulate<cnum>:MEASure<mnum>:MARKer:AOff

Applicable Models: All

(Write-only) Turns all markers off for selected measurement.

Parameters

- <cnum> Channel number of the measurement. There must be a selected measurement on that channel. If unspecified, <cnum> is set to 1.
- <mnum> Measurement number for each measurement. There must be a selected measurement on the trace. If unspecified, <mnum> is set to 1.

Examples

```
CALC:MEAS2:MARK:AOff
calculate2:measure2:marker:aoff
```

Query Syntax Not applicable

Default Not applicable

CALCulate<cnum>:MEASure<mnum>:MARKer<n>:BUCKet <num>

Applicable Models: All

(Read-Write) Sets and reads the data point (bucket) number of the trace on which the marker resides. When the markers are interpolated (non-discrete), the returned value is the nearest marker bucket position.

Parameters

- <cnum> Channel number of the measurement. There must be a selected measurement on that channel. If unspecified, <cnum> is set to 1.
- <mnum> Measurement number for each measurement. There must be a selected measurement on the trace. If unspecified, <mnum> is set to 1.
- <n> Marker number to move or query. The marker must already exist. If unspecified, <n> is set to 1.
- <num> Data point (bucket) number. Choose any data point between: 0 and the number of data points minus 1.

Examples

```
CALC:MEAS:MARK:BUCK 5
```

```
calculate2:measure2:marker2:bucket 200
```

Query Syntax CALCulate<cnum>:MEASure<mnum>:MARKer<n>:BUCKet?

Return Type Integer

Default The first marker is set to the middle of the span. Subsequent markers are set to the bucket number of the previously active marker.

CALCulate<cnum>:MEASure<mnum>:MARKer<mkr>:BWIDth:DATA?

Applicable Models: All

(Read-only) Read the bandwidth search result of marker 1 to 15 and reference marker (Mkr :16), for the active trace of selected channel.

If the bandwidth search is impossible, an error occurs when executed and the object is ignored.

Parameters

- <cnum> Channel number of the measurement. There must be a selected measurement on that channel. If unspecified, <cnum> is set to 1.
- <mnum> Measurement number for each measurement. There must be a selected measurement on the trace. If unspecified, <mnum> is set to 1.
- <mkr> Any marker number from 1 to 15; If unspecified, value is set to 1.
Four Character values separated by commas => {numeric 1}, {numeric 2}, {numeric 3}, {numeric 4}
- {numeric 1} : Bandwidth
 - {numeric 2} : Center point frequency of the 2 cutoff frequency points
 - {numeric 3} : Q value
 - {numeric 4} : Insertion loss

Examples

```
CALC:MEAS:MARK:BWID:DATA?  
calculate2:measure1:marker:bandwidth:data?
```

Query Syntax

CALCulate<cnum>:MEASure<mnum>:MARKer<mkr>:BWIDth:DATA?

Return Type

Numeric

Default

Not Applicable

CALCulate<cnum>:MEASure<mnum>:MARKer<mkr>:BWIDth:REF <string>

Applicable Models: All

(Read-Write) Set the bandwidth marker function reference to either MARKer or PEAK.

If the reference is set to MARKer, the active marker is not moved; the bandwidth search is computed at the marker's current location.

If the reference is PEAK, the active marker is moved to the maximum or minimum peak on the trace and then bandwidth search is computed.

- If the bandwidth level is negative, the active marker is moved to the maximum peak.
- If the bandwidth level is positive, the active marker is moved to the minimum peak.

Parameters

- <cnum> Channel number of the measurement. There must be a selected measurement on that channel. If unspecified, <cnum> is set to 1.
- <mnum> Measurement number for each measurement. There must be a selected measurement on the trace. If unspecified, <mnum> is set to 1.
- <mkr> Any marker number from 1 to 15; if unspecified, value is set to 1.
- <string> PEAK

MARKer

Examples

```
CALC:MEAS:MARK:BWID:REF MARK
calculate2:measure1:marker:bwid:ref peak
```

Query Syntax

CALCulate<cnum>:MEASure<mnum>:MARKer:BWIDth:REF?

Return Type

String

Default

MARKer

CALCulate<cnum>:MEASure<mnum>:MARKer<mkr>:BWIDth[:STATe] <bool>

Applicable Models: All

(Read-Write) Turns ON or OFF the bandwidth search result display, for the active trace of selected channel .

Parameters

- <cnum> Channel number of the measurement. There must be a selected measurement on that channel. If unspecified, <cnum> is set to 1.
- <mnum> Measurement number for each measurement. There must be a selected measurement on the trace. If unspecified, <mnum> is set to 1.
- <mkr> Any marker number from 1 to 15; if unspecified, value is set to 1.
- <bool> Bandwidth search result display:

ON or 1 - Turns ON the bandwidth search result display.

OFF or 0 - Turns OFF the bandwidth search result display.

Examples

```
CALC:MEAS:MARK:BWID ON  
calculate2:measure1:marker:bwid:state off
```

Query Syntax

CALCulate<cnum>:MEASure<mnum>:MARKer:BWIDth[:STATe]?

Return Type

Boolean

Default

OFF or 0

CALCulate<cnum>:MEASure<mnum>:MARKer<mkr>:BWIDth:THReshold <value><unit>

Applicable Models: All

(Read-Write) Sets or returns the bandwidth definition value (the value to define the pass-band of the filter) of marker 1 to 15 and reference marker (Mk :16), for the active trace of selected channel.

Parameters

- <cnum> Channel number of the measurement. There must be a selected measurement on that channel. If unspecified, <cnum> is set to 1.
- <mnum> Measurement number for each measurement. There must be a selected measurement on the trace. If unspecified, <mnum> is set to 1.
- <mkr> Any marker number from 1 to 15; if unspecified, value is set to 1.
- <value> Bandwidth definition value (the value to define the pass band of the filter) is between -5E8 to 5E8.
- <unit> Varies depending on the data format.

- Log magnitude (MLOG): dB (decibel)

- Phase (PHAS), Expanded phase (UPH) or Positive phase (PPH): ° (degree)
- Group delay (GDEL): s (second)
- Others: No unit

Examples

```
CALC:MEAS:MARK:BWID:THR -3
calculate2:measure1:marker:bandwidth:threshold -3
```

Query Syntax

CALCulate<cnum>:MEASure<mnum>:MARKer<mkr>:BWIDth:THReshold?

Return Type

Numeric

Default -3

CALCulate<cnum>:MEASure<mnum>:MARKer<mkr>:COUPling:METHod <char>

Applicable Models: All

(Read-Write) Sets and reads the scope of Coupled Markers. This is a global setting that affects all markers. Learn more.

Note: This command will not take effect until Coupled Markers is turned on using CALC:MEAS:MARK:COUP:STATe ON .

Note: The preset behavior of Coupled Markers depends on the setting of SYSTem:PREFerences:ITEM:MCControl , SYSTem:PREFerences:ITEM:MCMethod , and SYSTem:PREFerences:ITEM:MCPRest .

Note: If any or all <cnum>, <mnum>, or <mkr> arguments are omitted, they are assumed to have the value 1.

Parameters

- <cnum> Must be a valid channel number (unless a measurement number is provided), but marker coupling is not set per channel.
- <mnum> Must be a valid measurement number and must be displayed on the screen. Marker coupling is not set per measurement.
- <mkr> Not used. The marker number must still be in the range of 1-16, but marker coupling is not set per marker.
- <char> **CHANnel** - Coupling is limited to traces in the same channel.

ALL - Coupling occurs across all channels.

Examples

```
CALC:MEAS:MARK:COUP:METH CHAN
calculate:measure:marker:coupling all
```

Query Syntax	CALCulate<cnum>:MEASure<mnum>:MARKer:COUPling:METhod?
Return Type	Character
Default	ALL

CALCulate:MEASure<mnum>:MARKer<mkr>:COUPling[:STATe]<ON|OFF>

Applicable Models: All

(Read-Write) Sets and reads the state of Coupled Markers (ON and OFF). The scope of coupled markers can be changed with CALC:MEAS:MARK:COUP:METH .

Note: If the <mnum> or <mkr> argument is omitted, they are assumed to have the value 1.

Parameters

- <mnum> Must be a valid measurement number and must be displayed on the screen.
- <mkr> Not used. The marker number must still be in the range of 1-16.
- <ON|OFF> **OFF (0)** - Turns Coupled Markers OFF
- ON (1)** - Turns Coupled Markers ON

Examples

```
CALC:MEAS:MARK:COUP ON
calculate:measure1:marker:coupling off
```

Query Syntax	CALCulate<cnum>:MEASure<mnum>:MARKer:COUPling:[STATe]?
Return Type	Boolean (1 = ON, 0 = OFF)
Default	OFF

CALCulate<cnum>:MEASure<mnum>:MARKer<mkr>:DELTA <ON|OFF>

Applicable Models: All

(Read-Write) Specifies whether marker is relative to the Reference marker or absolute.

Note: The reference marker must already be turned ON with CALC:MARK:REF:STATE .

Parameters

- <cnm> Channel number of the measurement. There must be a selected measurement on that channel. If unspecified, <cnm> is set to 1.
- <mnum> Measurement number for each measurement. There must be a selected measurement on the trace. If unspecified, <mnum> is set to 1.
- <mkr> Any existing marker number from 1 to 10; if unspecified, value is set to 1.
- <ON|OFF> **ON** (or 1) - Specified marker is a Delta marker
OFF (or 0) - Specified marker is an ABSOLUTE marker

Examples

```
CALC:MEAS:MARK:DELT ON  
calculate2:measure1:marker8:delta off
```

Query Syntax CALCulate<cnm>:MEASure<mnum>:MARKer<mkr>:DELTA?

Return Type Boolean (1 = ON, 0 = OFF)

Default OFF

CALCulate<cnm>:MEASure<mnum>:MARKer<mkr>:DIScrete <ON|OFF>

Applicable Models: All

(Read-Write) Makes the specified marker display either a calculated value between data points (interpolated data) or the actual data points (discrete data).

Parameters

- <cnm> Channel number of the measurement. There must be a selected measurement on that channel. If unspecified, <cnm> is set to 1.
- <mnum> Measurement number for each measurement. There must be a selected measurement on the trace. If unspecified, <mnum> is set to 1.
- <mkr> Any existing marker number from 1 to 10; if unspecified, value is set to 1.
- <ON|OFF> **ON** (or 1) - Specified marker displays the actual data points
OFF (or 0) - Specified marker displays calculated data between the actual data points.

Examples

```
CALC:MEAS:MARK:DISC ON
calculate2:measure2:marker8:discrete off
```

Query Syntax CALCulate<cnum>:MEASure<mnum>:MARKer<mkr>:DIScrete?

Return Type Boolean (1 = ON, 0 = OFF)

Default OFF

CALCulate<cnum>:MEASure<mnum>:MARKer<mkr>:DISTance <num>

Applicable Models: All

(Read-Write) Set or query marker distance on a time domain trace.

The Write command moves the marker to the specified distance value. Once moved, you can read the Y axis value or read the X-axis time value. (Distance is calculated from the X-axis time value.)

The Read command reads the distance of the marker.

If the marker is set as delta, the WRITE and READ data is relative to the reference marker.

Parameters

<cnum> Channel number of the measurement. There must be a selected measurement on that channel. If unspecified, <cnum> is set to 1.

<mnum> Measurement number for each measurement. There must be a selected measurement on the trace. If unspecified, <mnum> is set to 1.

<mkr> Any existing marker number from 1 to 10; if unspecified, value is set to 1.

<num> Marker distance in the unit of measure specified with
CALC:TRAN:TIME:MARK:UNIT

Examples

```
CALC:MEAS:MARK:DIST .1
calculate2:measure1:marker8:distance 5
```

Query Syntax CALCulate<cnum>:MEASure<mnum>:MARKer<mkr>:DISTance?

Return Type Numeric

Default Not Applicable

CALCulate<cnum>:MEASure<mnum>:MARKer<mkr>:FORMat <char>

Applicable Models: All

(Read-Write) Sets the format of the data that will be returned in a marker data query

CALC:MARK:Y? and the displayed value of the marker readout. The selection does not have to be

the same as the measurement's display format.

Parameters

- <cnum> Channel number of the measurement. There must be a selected measurement on that channel. If unspecified, <cnum> is set to 1.
- <mnum> Measurement number for each measurement. There must be a selected measurement on the trace. If unspecified, <mnum> is set to 1.
- <mkr> Any marker number from 1 to 15; if unspecified, value is set to 1
- <char> Choose from:
 - DEFault** - The format of the selected measurement
 - MLINear** - Linear magnitude
 - MLOGarithmic** - Logarithmic magnitude
 - IMPedance** - (R+jX)
 - ADMittance** - (G+jB)
 - PHASe** - Phase
 - IMAGinary** - Imaginary part (Im)
 - REAL** - Real part (Re)
 - POLar** - (Re, Im)
 - GDELay** - Group Delay
 - LINPhase** - Linear Magnitude and Phase
 - LOGPhase** - Log Magnitude and Phase
 - KELVin** - temperature
 - FAHRenheit** - temperature
 - CELSius** - - temperature
 - NOISe** - Noise (available ONLY in IM Spectrum and SA measurement classes).

Examples

```
CALC:MEAS:MARK:FORMat MLIN  
calculate2:measure:marker8:format Character
```

Query Syntax CALCulate<cnum>:MEASure<mnum>:MARKer<mkr>:FORMat?

Return Type Character

Default DEFault

CALCulate<cnum>:MEASure<mnum>:MARKer<mkr>:FUNCTion:APEak:POLarity <char>

Applicable Models: All

(Read-Write) Sets or returns polarity of the peak search with marker 1 to 15 and reference marker (Mk:16), for the active trace of selected channel.

Learn more about Marker Search

Parameters

- <cnum> Channel number of the measurement. There must be a selected measurement on that channel. If unspecified, <cnum> is set to 1.
- <mnum> Measurement number for each measurement. There must be a selected measurement on the trace. If unspecified, <mnum> is set to 1.
- <mkr> Any marker number from 1 to 15; if unspecified, value is set to 1.
- <char> Polarity for peak search function to be performed. Choose from:
 - **"NEGative"** : Specifies the negative peak.
 - **"POSitive"** : Specifies the positive peak.
 - **"BOTH"** : Specifies both the positive peak and the negative peak.

Examples

```
CALC:MEAS:MARK:FUNC:APE:POL NEG
calculate2:measure1:marker6:function:apeak:polarity both
```

Query Syntax CALCulate<cnum>:MEASure<mnum>:MARKer<mkr>:FUNCTion:APEak:POLarity?

Return Type Character

Default "POSitive"

CALCulate<cnum>:MEASure<mnum>:MARKer<mkr>:FUNCTion:COMPression:LEVel <num>

Applicable Models: All

(Read-Write) Sets and read the marker compression level. A compression marker must already exist. Use CALC:MARK ON and CALC:MEAS:MARK:FUNC COMP to create compression markers.

Parameters

- <cnum> Channel number of the measurement. There must be a selected measurement on that channel. If unspecified, <cnum> is set to 1.
- <mnum> Measurement number for each measurement. There must be a selected measurement on the trace. If unspecified, <mnum> is set to 1.
- <mkr> Any existing marker number from 1 to 15; if unspecified, value is set to 1.
- <num> Compression level. Choose any number between: -500 dB to 500 dB

Standard gain compression values are positive.

Examples

```
CALC:MEAS:MARK:FUNC:COMP:LEV 1
calculate2:measure1:marker:function:compression:level 1.5
```

Query Syntax

CALCulate<cnum>:MEASure<mnum>:MARKer<mkr>:FUNCTion:COMPression:LEVel?

Return Type

Numeric

Default

+1 dB

CALCulate<cnum>:MEASure<mnum>:MARKer<mkr>:FUNCTion:COMPression:PIN?

Applicable Models: All

(Read-only) Read the input power at the marker compression level. First send CALC:MEAS:MARK:FUNC:EXEC COMP or CALC:MEAS:MARK:FUNC:TRAC ON .

Parameters

- <cnum> Channel number of the measurement. There must be a selected measurement on that channel. If unspecified, <cnum> is set to 1.
- <mnum> Measurement number for each measurement. There must be a selected measurement on the trace. If unspecified, <mnum> is set to 1.
- <mkr> Any existing marker number from 1 to 15; if unspecified, value is set to 1.

Examples

```
CALC:MEAS:MARK:FUNC:COMP:PIN?
calculate2:measure1:marker:function:compression:pin?
```

Return Type

Numeric

Default

Not Applicable

CALCulate<cnum>:MEASure<mnum>:MARKer<mkr>:FUNCTion:COMPression:POUT?

Applicable Models: All

(Read-only) Read the output power at the marker compression level. First send CALC:MEAS:MARK:FUNC:EXEC COMP or CALC:MEAS:MARK:FUNC:TRAC ON

Parameters

- <cnm> Channel number of the measurement. There must be a selected measurement on that channel. If unspecified, <cnm> is set to 1.
- <mnm> Measurement number for each measurement. There must be a selected measurement on the trace. If unspecified, <mnm> is set to 1.
- <mkr> Any existing marker number from 1 to 15; if unspecified, value is set to 1.

Examples

```
CALC:MEAS:MARK:FUNC:COMP:POUT?  
calculate2:measure1:marker:function:compression:pout?
```

Return Type

Numeric

Default

Not Applicable

CALCulate<cnm>:MEASure<mnm>:MARKer<mkr>:FUNCTion:COMPression[:STATe]
<bool>

Applicable Models: All

(Read-Write) Turns ON or OFF the compression state.

Parameters

- <cnm> Channel number of the measurement. There must be a selected measurement on that channel. If unspecified, <cnm> is set to 1.
- <mnm> Measurement number for each measurement. There must be a selected measurement on the trace. If unspecified, <mnm> is set to 1.
- <mkr> Any marker number from 1 to 15; if unspecified, value is set to 1.
- <bool> Bandwidth search result display:

ON or 1 - Turns ON the compression.

OFF or 0 - Turns OFF the compression.

Examples

```
CALC:MEAS:MARK:FUNC:COMP:STAT ON  
calculate2:measure1:marker:function:compression:state off
```

Query Syntax

CALCulate<cnm>:MEASure<mnm>:MARKer:FUNCTion:COMPression[:STATe]?

Return Type

Boolean

Default

OFF or 0

**CALCulate<cnum>:MEASure<mnum>:MARKer<mkr>:FUNCtion:DOMain:USER[:RANGe]
<range>**

Applicable Models: All

(Read-Write) Assigns the specified marker to a range number. The x-axis travel of the marker is constrained to the range's span. The span is specified with the CALC:MEAS:MARK:FUNC:DOM:USER:START and STOP commands, unless range 0 is specified which is the full span of the analyzer.

Each channel has 16 user ranges. (Trace statistics use the same ranges.) More than one marker can use a domain range.

Parameters

- <cnum> Channel number of the measurement. There must be a selected measurement on that channel. If unspecified, <cnum> is set to 1.
- <mnum> Measurement number for each measurement. There must be a selected measurement on the trace. If unspecified, <mnum> is set to 1.
- <mkr> Any marker number from 1 to 15; if unspecified, value is set to 1.
- <range> User span. Choose any Integer from 0 to 16.

0 is Full Span of the analyzer.

1 to 16 are available for user-defined x-axis span.

Examples

```
CALC:MEAS:MARK:FUNC:DOM:USER:RANG 1  
calculate2:measure1:marker8:function:domain:user:range 1
```

**Query
Syntax**

CALCulate<cnum>:MEASure<mnum>:MARKer<mkr>:FUNCtion:DOMain:USER:RANG

**Return
Type**

Numeric

Default 0 - Full Span

**CALCulate<cnum>:MEASure<mnum>:MARKer<mkr>:FUNCtion:DOMain:USER:START
<start>**

Applicable Models: All

(Read-Write) Sets the start of the span that the specified marker's x-axis span will be constrained to.

Use CALC:MEAS:MARK:FUNC:DOM:USER<range> to set range number.

Use CALC:MEAS:MARK:FUNC:DOM:USER:STOP to set the stop value.

Note: If the marker is assigned to range 0 (full span), the USER:START and STOP commands generate an error. You cannot set the START and STOP values for "Full Span".

Note: This command does the same as CALC:FUNC:DOM:USER:STAR

Parameters

- <cnum> Channel number of the measurement. There must be a selected measurement on that channel. If unspecified, <cnum> is set to 1.
- <mnum> Measurement number for each measurement. There must be a selected measurement on the trace. If unspecified, <mnum> is set to 1.
- <mkr> Any marker number from 1 to 15; if unspecified, value is set to 1.
- <start> The analyzer's Minimum x-axis value

Examples

```
CALC:MEAS:MARK:FUNC:DOM:USER:START 500E6
calculate2:measure1:marker8:function:domain:user:start 1e12
```

Query Syntax

CALCulate<cnum>:MEASure<mnum>:MARKer<mkr>:FUNCtion:DOMain:USER:STAR

Return Type

Numeric

Default

The analyzer's Minimum x-axis value

CALCulate<cnum>:MEASure<mnum>:MARKer<mkr>:FUNCtion:DOMain:USER:STOP <stop>

Applicable Models: All

(Read-Write) Sets the stop of the span that the marker's x-axis travel will be constrained to.

Use `CALC:MEAS:MARK:FUNC:DOM:USER<range>` to set range number.

Use `CALC:MEAS:MARK:FUNC:DOM:USER:START` to set the stop value.

Note: If the marker is assigned to range 0 (full span), the `USER:START` and `STOP` commands generate an error. You cannot set the `START` and `STOP` values for "Full Span".

Note: This command does the same as `CALC:FUNC:DOM:USER:STOP`

Parameters

- `<cnum>` Channel number of the measurement. There must be a selected measurement on that channel. If unspecified, `<cnum>` is set to 1.
- `<mnum>` Measurement number for each measurement. There must be a selected measurement on the trace. If unspecified, `<mnum>` is set to 1.
- `<mkr>` Any marker number from 1 to 15; if unspecified, value is set to 1.
- `<stop>` Stop value of x-axis span; Choose any number between the analyzer's MINimum and MAXimum x-axis value.

Examples

```
CALC:MEAS:MARK:FUNC:DOM:USER:STOP 500e6  
calculate2:measure1:marker8:function:domain1:user:stop 1e12
```

Query Syntax

`CALCulate<cnum>:MEASure<mnum>:MARKer<mkr>:FUNCtion:DOMain:USER:STOP'`

Return Type

Numeric

Default

The analyzer's MAXimum x-axis value.

`CALCulate<cnum>:MEASure<mnum>:MARKer<mkr>:FUNCtion:EXECute <func>`

Applicable Models: All

(Write-only) Immediately executes (performs) the specified search function.

Learn more about Marker Search

Parameters

- <cnum> Channel number of the measurement. There must be a selected measurement on that channel. If unspecified, <cnum> is set to 1.
- <mnum> Measurement number for each measurement. There must be a selected measurement on the trace. If unspecified, <mnum> is set to 1.
- <mkr> Any marker number from 1 to 15; if unspecified, value is set to 1.
- <func> The function to be performed. Choose from:
 - MAXimum - finds the highest value.
 - MINimum - finds the lowest value.
 - RPEak - finds the next valid peak to the right.
 - LPEak - finds the next valid peak to the left.
 - NPEak - finds the next highest value among the valid peaks.
 - TARGet - finds the target value to the right, wraps around to the left.
 - LTARget - finds the next target value to the left of the marker.
 - RTARget - finds the next target value to the right of the marker.
 - COMPression - finds the compression level on a Power Swept S21 trace.

Examples

```
CALC:MEAS:MARK:FUNC:EXEC MAX  
calculate2:measure1:marker2:function:execute maximum
```

Query Not Applicable
Syntax Not Applicable
Default Not Applicable

CALCulate<cnum>:MEASure<mnum>:MARKer<mkr>:FUNCtion:MULTi:EXECute <func>

Applicable Models: All

(Write-only) Immediately executes (performs) the specified multi search function.

Parameters

- <num> Channel number of the measurement. There must be a selected measurement on that channel. If unspecified, <num> is set to 1.
- <mnum> Measurement number for each measurement. There must be a selected measurement on the trace. If unspecified, <mnum> is set to 1.
- <mkr> Any marker number from 1 to 15; if unspecified, value is set to 1.
- <func> The function to be performed. Choose from:
 - **OFF** - function is disabled.
 - **PEAK** - finds the peak value of a multi-peak search.
 - **TARGET** - finds the target value to the right, wraps around to the left.

Examples

```
CALC:MEAS:MARK:FUNC:MULT:EXEC PEAK  
calculate2:measure1:marker2:function:multi:execute target
```

Query Not Applicable
Syntax
Default OFF

CALCulate<num>:MEASure<num>:MARKer<num>:FUNCtion:MULTi:PEAK:EXCursion
<num><unit>

Applicable Models: All

(Read-Write) Sets or returns the lower limit of peak excursion value of multi peak search, for the selected channel and selected trace.

Learn more about Marker Search

Parameters

- <num> Channel number of the measurement. There must be a selected measurement on that channel. If unspecified, <num> is set to 1.
- <mnum> Measurement number for each measurement. There must be a selected measurement on the trace. If unspecified, <mnum> is set to 1.
- <mkr> Any marker number from 1 to 15; if unspecified, value is set to 1.
- <num> Excursion value. Choose any number between -500 and 500.

Notes: If the specified variable is out of the allowable setup range, the minimum value (if the lower limit of the range is not reached) or the maximum value (if the upper limit of the range is exceeded) is set.

This command will accept MIN or MAX instead of a numeric parameter. See SCPI Syntax more information.

<unit> Varies depending on the data format.

- Log magnitude (MLOG): dB (decibel)
- Phase (PHAS), Expanded phase (UPH) or Positive phase (PPH): ° (degree)
- Group delay (GDEL): s (second)
- Others: No unit

Examples

```
CALC:MEAS:MARK:FUNC:MULT:PEAK:EXC 10  
calculate2:measure2:marker8:function:multi:peak:excursion maximum
```

Query Syntax

CALCulate<cnum>:MEASure<mnum>:MARKer<mkr>:FUNCTion:MULTi:PEAK:EXCursion

Return Type

Numeric

Default

3

CALCulate<cnum>:MEASure<mnum>:MARKer<mkr>:FUNCTion:MULTi:PEAK:POLarity <func>

Applicable Models: All

(Read-Write) Sets or returns the peak polarity of the multi peak search, for the selected channel and selected trace.

Learn more about Marker Search

Parameters

- <cnum> Channel number of the measurement. There must be a selected measurement on that channel. If unspecified, <cnum> is set to 1.
- <mnum> Measurement number for each measurement. There must be a selected measurement on the trace. If unspecified, <mnum> is set to 1.
- <mkr> Any marker number from 1 to 15; if unspecified, value is set to 1.
- <func> Polarity for multi peak search function to be performed. Choose from:
 - "NEGative" : Specifies the negative peak.
 - "POSitive" : Specifies the positive peak.
 - "BOTH" : Specifies both the positive peak and the negative peak.

Examples

```
CALC:MEAS:MARK:FUNC:MULT:PEAK:POL NEG  
calculate2:measure1:marker6:function:multi:peak:polarity both
```

Query Syntax CALCulate<cnum>:MEASure<mnum>:MARKer<mkr>:FUNCTion:MULTi:PEAK:POLarit
Return Type Character
Default "POSitive"

CALCulate<cnum>:MEASure<mnum>:MARKer<mkr>:FUNCTion:MULTi:PEAK:THReshold <num>

Applicable Models: All

(Read-Write) Sets peak threshold for the specified marker. If a peak (using the criteria set with :EXCursion below this reference value, it will not be considered when searching for peaks. This command applies to marker peak searches (Next peak, Peak Right, Peak Left).

Parameters

- <cnum> Channel number of the measurement. There must be a selected measurement on that channel unspecified, <cnum> is set to 1.
- <mnum> Measurement number for each measurement. There must be a selected measurement on the trace. If unspecified, <mnum> is set to 1.
- <mkr> Any marker number from 1 to 15; if unspecified, value is set to 1.
- <num> Threshold value. Choose any number between -500 and 500.

Note : This command will accept MIN or MAX instead of a numeric parameter. See SCPI Syntax for more information.

Examples

```
CALC:MEAS:MARK:FUNC:MULT:PEAK:THR -40  
calculate2:measure1:marker8:function:multi:peak:threshold -55
```

Query Syntax CALCulate<cnum>:MEASure<mnum>:MARKer<mkr>:FUNCTion:MULTi:PEAK:THReshold
Return Type Numeric
Default -100

CALCulate<cnum>:MEASure<mnum>:MARKer<mkr>:FUNCTion:MULTi:SElect<char>

Applicable Models: All

(Read-Write) Sets or returns the search type of the multi search, for the selected channel and selected trace.

Learn more about Marker Search

Parameters

- <cnum> Channel number of the measurement. There must be a selected measurement on that channel. If unspecified, <cnum> is set to 1.
- <mnum> Measurement number for each measurement. There must be a selected measurement on the trace. If unspecified, <mnum> is set to 1.
- <mkr> Any marker number from 1 to 15; if unspecified, value is set to 1.
- <char> Select from the following:
 - "OFF ": Turn OFF the multi search function.
 - "PEAK ": Sets the search type to the multi peak search.
 - "TARGet ": Sets the search type to the multi target search.

Examples

```
CALC:MEAS:MARK:FUNC:MULT:SEL BOTH  
calculate2:measure1:marker6:function:multi:select both
```

Query Syntax

CALCulate<cnum>:MEASure<mnum>:MARKer<mkr>:FUNCTion:MULTi:SElect?

Return Type Character

Default "OFF"

CALCulate<cnum>:MEASure<mnum>:MARKer<mkr>:FUNCTion:MULTi:TARGet:TRANSition
<char>

Applicable Models: All

(Read-Write) Sets the transition type of the multi target search.

Learn more about Marker Search

Parameters

- <cnum> Channel number of the measurement. There must be a selected measurement on that channel. If unspecified, <cnum> is set to 1.
- <mnum> Measurement number for each measurement. There must be a selected measurement on the channel. If unspecified, <mnum> is set to 1.
- <mkr> Any marker number from 1 to 15; if unspecified, value is set to 1.
- <char> Transition type of multi target search function to be performed. Choose from:
 - "NEGative" : Specifies the negative transition.
 - "POSitive" : Specifies the positive transition.
 - "BOTH" : Specifies both the positive transition and the negative transition.

Examples

```
CALC:MEAS:MARK:FUNC:MULT:TARG:TRAN BOTH  
calculate2:measure1:marker6:function:multi:target:transition both
```

Query Syntax

CALCulate<cnum>:MEASure<mnum>:MARKer<mkr>:FUNCtion:MULTi:TARGet:TRAN

Return Type

Character

Default

"BOTH"

CALCulate<cnum>:MEASure<mnum>:MARKer<mkr>:FUNCtion:MULTi:TARGet[:VALue]
<num><unit>

Applicable Models: All

(Read-Write) Sets or returns the target value for the specified marker when doing Multi Target Search, for selected channel and selected trace.

Learn more about Marker Search

Parameters

- <cnm> Channel number of the measurement. There must be a selected measurement on that channel. If unspecified, <cnm> is set to 1.
- <mnum> Measurement number for each measurement. There must be a selected measurement on the trace. If unspecified, <mnum> is set to 1.
- <mkr> Any marker number from 1 to 15; if unspecified, value is set to 1.
- <num> Target value for multi target search to search for.

The range of target value is -5E8 to 5E8.

Notes: If the specified variable is out of the allowable setup range, the minimum value (if the lower limit of the range is not reached) or the maximum value (if the upper limit of the range exceeded) is set.

<unit> Varies depending on the data format.

- Log magnitude (MLOG): dB (decibel)
- Phase (PHAS), Expanded phase (UPH) or Positive phase (PPH): ° (degree)
- Group delay (GDEL): s (second)
- Others: No unit

Examples

```
CALC:MEAS:MARK:FUNC:MULT:TARG 2.5  
calculate2:measure2:marker5:function:multi:target:value -10.3
```

Query Syntax

CALCulate<cnm>:MEASure<mnum>:MARKer<mkr>:FUNCCtion:MULTi:TARGet[:VAL

Return Type

Numeric

Default 0

CALCulate<cnm>:MEASure<mnum>:MARKer<mkr>:FUNCCtion:MULTi:TRACking <bool>

Applicable Models: All

(Read-Write) Turns ON or OFF the search tracking capability (function to repeat search for each sweep) of the multi search, for the selected channel and selected trace.

Learn more about Marker Search

Parameters

- <cnum> Channel number of the measurement. There must be a selected measurement on that channel. If unspecified, <cnum> is set to 1.
- <mnum> Measurement number for each measurement. There must be a selected measurement on the trace. If unspecified, <mnum> is set to 1.
- <mkr> Any marker number from 1 to 15; if unspecified, value is set to 1.
- <bool> **ON or 1** - Turns ON the marker search tracking. The specified multi marker will "Track" (find) the selected function every sweep.

OFF or 0 - Turns OFF the marker search tracking. The specified multi marker will find the selected function **only** when the CALC:MEAS:MARK:FUNC:EXECute command is sent.

Examples

```
CALC:MEAS:MARK:FUNC:MULT:TRAC ON
calculate2:measure2:marker8:function:multi:tracking off
```

Query Syntax

CALCulate<cnum>:MEASure<mnum>:MARKer<mkr>:FUNCtion:MULTi:TRACking?

Return Type

Boolean

Default

OFF or 0

CALCulate<cnum>:MEASure<mnum>:MARKer<mkr>:FUNCtion:PEAK:EXCursion <num>

Applicable Models: All

(Read-Write) Sets amplitude peak excursion for the specified marker. The Excursion value determines what is considered a "peak". This command applies to marker peak searches (Next peak, Peak Right, Peak Left).

Parameters

- <cnum> Channel number of the measurement. There must be a selected measurement on that channel. If unspecified, <cnum> is set to 1.
- <mnum> Measurement number for each measurement. There must be a selected measurement on the trace. If unspecified, <mnum> is set to 1.
- <mkr> Any existing marker number from 1 to 10; if unspecified, value is set to 1.

<num> Excursion value. Choose any number between **-500** and **500**.

Note : This command will accept **MIN** or **MAX** instead of a numeric parameter. See SCPI Syntax for more information.

Examples

```
CALC:MEAS:MARK:FUNC:PEAK:EXC 10  
calculate2:measure2:marker8:function:peak:excursion maximum
```

Query Syntax CALCulate<cnum>:MARKer<mkr>:FUNCtion:PEAK:EXCursion?

Return Type Numeric

Default 3

CALCulate<cnum>:MEASure<mnum>:MARKer<mkr>:FUNCtion:PEAK:POLarity <char>

Applicable Models: All

(Read-Write) Sets or returns polarity of the peak search with marker 1 to 15 and reference marker (Mk :16), for the active trace of selected channel.

Learn more about Marker Search

Parameters

- <cnum> Channel number of the measurement. There must be a selected measurement on that channel. If unspecified, <cnum> is set to 1.
- <mnum> Measurement number for each measurement. There must be a selected measurement on the trace. If unspecified, <mnum> is set to 1.
- <mkr> Any marker number from 1 to 15; if unspecified, value is set to 1.
- <char> Polarity for peak search function to be performed. Choose from:
 - "NEGative" : Specifies the negative peak.
 - "POSitive" : Specifies the positive peak.
 - "BOTH" : Specifies both the positive peak and the negative peak.

Examples

```
CALC:MEAS:MARK:FUNC:APE:POL NEG  
calculate2:measure1:marker6:function:apeak:polarity both
```

Query Syntax

CALCulate<cnum>:MEASure<mnum>:MARKer<mkr>:FUNCtion:APEak:POLarity?

Return Type

Character

Default "POSitive"

CALCulate<cnum>:MEASure<mnum>:MARKer<mkr>:FUNCtion:PEAK:THReshold <num>

Applicable Models: All

(Read-Write) Sets peak threshold for the specified marker. If a peak (using the criteria set with :EXCursion) is below this reference value, it will not be considered when searching for peaks. This command applies to marker peak searches (Next peak, Peak Right, Peak Left).

Parameters

- <num> Channel number of the measurement. There must be a selected measurement on that channel. If unspecified, <num> is set to 1.
- <mnum> Measurement number for each measurement. There must be a selected measurement on the trace. If unspecified, <mnum> is set to 1.
- <mkr> Any marker number from 1 to 15; if unspecified, value is set to 1
- <num> Threshold value. Choose any number between **-500** and **500**.

Note : This command will accept **MIN** or **MAX** instead of a numeric parameter. See SCPI Syntax for more information.

Examples

```
CALC:MEAS:MARK:FUNC:APE:THR -40  
calculate2:measure:marker8:function:apeak:threshold -55
```

Query Syntax CALCulate<num>:MARKer<mkr>:FUNCtion:APEak:THReshold?

Return Type Numeric

Default -100

CALCulate<num>:MEASure<mnum>:MARKer<mkr>:FUNCtion[:SElect] <char>

Applicable Models: All

(Read-Write) Sets the search function that the specified marker will perform when executed. Use CALC:MEAS:MARK:FUNC:TRAC ON to automatically execute the search every sweep.

Learn more about Marker Search

Parameters

- <num> Channel number of the measurement. There must be a selected measurement on that channel. If unspecified, <num> is set to 1.
- <mnum> Measurement number for each measurement. There must be a selected measurement on the trace. If unspecified, <mnum> is set to 1.
- <mkr> Any marker number from 1 to 15; if unspecified, value is set to 1.
- <char> Marker function. Choose from:

- **MAXimum** - finds the highest value

- MINimum - finds the lowest value
- RPEak - finds the next valid peak to the right
- LPEak - finds the next valid peak to the left
- NPEak - finds the next highest value among the valid peaks
- TARGet - finds the target value to the right, wraps around to the left
- LTARget - finds the next target value to the left of the marker
- RTARget - finds the next target value to the right of the marker
- COMPression - finds the compression level on a power-swept S21 trace.

Examples

```
CALC:MEAS:MARK:FUNC MAX
calculate2:measure1:marker8:function:select 1target
```

Query Syntax

CALCulate<cnum>:MEASure<mnum>:MARKer<mkr>:FUNCTion[:SElect]?

Return Type

Character

Default

MAXimum

CALCulate<cnum>:MEASure<mnum>:MARKer<mkr>:FUNCTion:TARGet[:VALue]:TRANSition <char>

Applicable Models: All

(Read-Write) Selects the transition type of the target search for specified marker (marker 1 to 15 and referer marker (Mk :16)) of the active trace of selected channel.

Parameters

<cnum> Channel number of the measurement. There must be a selected measurement on that channel unspecified, <cnum> is set to 1.

<mnum> Measurement number for each measurement. There must be a selected measurement on the unspecified, <mnum> is set to 1.

<mkr> Any marker number from 1 to 15; if unspecified, value is set to 1.

<char> Transition type for search function to be performed. Choose from:

- "NEGative " : Specifies the negative transition.
- "POSitive " : Specifies the positive transition.
- "BOTH " : Specifies both the positive transition and the negative transition.

Examples

```
CALC:MEAS:MARK:FUNC:TARG:TRAN POS
calculate2:measure1:marker8:function:target:value:transition both
```

Query Syntax	CALCulate<cnum>:MEASure<mnum>:MARKer<mkr>:FUNcTion:TARGet[:VALue]:TR.
Return Type	Character
Default	"BOTH"

CALCulate<cnum>:MEASure<mnum>:MARKer<mkr>:FUNcTion:TARGet[:VALue] <num>

Applicable Models: All

(Read-Write) Sets the target value for the specified marker when doing Target Searches with CALC:MEAS:MARK:FUNC:SEL <TARGet | RTARget | LTARget>

Parameters

- <cnum> Channel number of the measurement. There must be a selected measurement on that channel. If unspecified, <cnum> is set to 1.
- <mnum> Measurement number for each measurement. There must be a selected measurement on the trace. If unspecified, <mnum> is set to 1.
- <mkr> Any marker number from 1 to 15; if unspecified, value is set to 1.
- <num> Target value to search for.

The range of value is between -5E8 to 5E8.

Notes: If the specified variable is out of the allowable setup range, the minimum value (if the lower limit of the range is not reached) or the maximum value (if the upper limit of the range is exceeded) is set.

- <unit> Varies depending on the data format.
 - Log magnitude (MLOG): dB (decibel)
 - Phase (PHAS), Expanded phase (UPH) or Positive phase (PPH): ° (degree)
 - Group delay (GDEL): s (second)
 - Others: No unit

Examples

```
CALC:MEAS:MARK:FUNC:TARG 2.5
calculate2:measure1:marker8:function:target:value -10.3
```

Query Syntax	CALCulate<cnum>:MEASure<mnum>:MARKer<mkr>:TARGet[:VALue]?
Return Type	Numeric
Default	0

CALCulate<cnum>:MEASure<mnum>:MARKer<mkr>:FUNCtion:TRACking <bool>

Applicable Models: All

(Read-Write) Turns ON or OFF the tracking search capability for the specified marker. The tracking function finds the selected search function every sweep. In effect, turning Tracking ON is the same as doing a CALC:MEAS:MARK:FUNC:EXECute command every sweep.

Learn more about Marker Search

Parameters

- <cnum> Channel number of the measurement. There must be a selected measurement on that channel. If unspecified, <cnum> is set to 1.
- <mnum> Measurement number for each measurement. There must be a selected measurement on the trace. If unspecified, <mnum> is set to 1.
- <mkr> Any marker number from 1 to 15; if unspecified, value is set to 1.
- <bool> ON or 1 - Turns ON the search tracking. The specified marker will "Track" (find) the selected function every sweep.

OFF or 0 - Turns OFF the search tracking. The specified marker will find the selected function only when the CALC:MEAS:MARK:FUNC:EXECute command is sent.

Examples

```
CALC:MEAS:MARK:FUNC:TRAC ON  
calculate2:measure1:marker8:function:tracking off
```

Query Syntax

CALCulate<cnum>:MEASure<mnum>:MARKer<mkr>:FUNCtion:TRACking?

Return Type

Boolean

Default

OFF or 0

CALCulate<cnum>:MEASure<mnum>:MARKer<mkr>:NOTCh:DATA?

Applicable Models: All

(Read-only) Reads the notch search result of marker 1 to 15 and reference marker (Mk :16), for the active trace of selected channel.

If the notch search is impossible, an error occurs and the command is ignored. In this case, no query response is obtained.

Parameters

- <num> Channel number of the measurement. There must be a selected measurement on that channel. If unspecified, <num> is set to 1.
- <mnum> Measurement number for each measurement. There must be a selected measurement on the trace. If unspecified, <mnum> is set to 1.
- <mkr> Any marker number from 1 to 15; if unspecified, value is set to 1.
- Indicates 4-element array data (notch bandwidth search result). Four Character values separated by commas => {Data 1}, {Data 2}, {Data 3}, {Data 4}
- Data(0) :The bandwidth.
 - Data(1) :Center point frequency of the 2 cutoff frequency points.
 - Data(2) :The Q value.
 - Data(3) :Insertion loss

The index of the array starts from 0.

Examples

```
CALC:MEAS:MARK:NOTC:DATA?  
calculate2:measure1:marker:notch:data?
```

Query Syntax

CALCulate<num>:MEASure<mnum>:MARKer<mkr>:NOTCh:DATA?

Return Type

Variant

Default

Not Applicable

CALCulate<num>:MEASure<mnum>:MARKer<mkr>:NOTCh:REF <string>

Applicable Models: All

(Read-Write) Set the notch marker reference to either MARKer or PEAK.

If the reference is set to MARKer, the active marker is not moved; the notch search is computed at the marker's current location.

If the reference is set to PEAK, the active marker is moved to the maximum or minimum peak on the trace and then notch search is computed.

- If the notch level is negative, the active marker is moved to the maximum peak.
- If the notch level is positive, the active marker is moved to minimum peak.

Parameters

- <num> Channel number of the measurement. There must be a selected measurement on that channel. If unspecified, <num> is set to 1.
- <mnum> Measurement number for each measurement. There must be a selected measurement on the trace. If unspecified, <mnum> is set to 1.
- <mkr> Any marker number from 1 to 15; if unspecified, value is set to 1.
- <string> PEAK

MARKer

Examples

```
CALC:MEAS:MARK:NOTCh:REF  
calculate2:measure1:marker:notch:ref
```

Query

Syntax

CALCulate<num>:MEASure<mnum>:MARKer<mkr>:NOTCh:REF?

Return

Type

String

Default

MARKer

CALCulate<num>:MEASure<mnum>:MARKer<mkr>:NOTCh[:STATe] <bool>

Applicable Models: All

(Read-Write) Turns ON or OFF the notch search result display, for the active trace of selected channel.

Parameters

- <cnun> Channel number of the measurement. There must be a selected measurement on that channel. If unspecified, <cnun> is set to 1.
- <mnum> Measurement number for each measurement. There must be a selected measurement on the trace. If unspecified, <mnum> is set to 1.
- <mkr> Any marker number from 1 to 15; if unspecified, value is set to 1.
- <bool> Notch search result display. Choose from:

ON or 1 - Turns ON the notch search result display.

OFF or 0 - Turns OFF the notch search result display.

Examples

```
CALC:MEAS:MARK:NOTC ON
calculate2:measure1:marker:notch:state off
```

Query Syntax

CALCulate<cnun>:MEASure<mnum>:MARKer<mkr>:NOTCh[:STATe]?

Return Type

Boolean

Default

OFF or 0

CALCulate<cnun>:MEASure<mnum>:MARKer<mkr>:NOTCh:THReshold <num>

Applicable Models: All

(Read-Write) Sets or returns the notch definition value of marker 1 to 15 and reference marker (Mk :16), for the active trace of selected channel.

Parameters

- <cnun> Channel number of the measurement. There must be a selected measurement on that channel. If unspecified, <cnun> is set to 1.
- <mnum> Measurement number for each measurement. There must be a selected measurement on the trace. If unspecified, <mnum> is set to 1.
- <mkr> Any marker number from 1 to 15; if unspecified, value is set to 1.
- <num> The notch definition value range is between -5E8 to 5E8.

Notes: If the specified parameter is out of the allowable setup range, the minimum value (if the lower limit of the range is not reached) or the maximum value (if the upper limit of the range is exceeded) is set.

<unit> Varies depending on the data format as follows:

- Amplitude (MLOG):dB (decibel)
- Phase (PHAS), Expanded phase (UPH),Positive phase (PPH): ° (degree)
- Group delay (GDEL): s (second)
- Others: No unit

Examples

```
CALC:MEAS:MARK:NOTC:THR -3
calculate2:measure1:marker:notch:threshold -3
```

Query Syntax

CALCulate<cnum>:MEASure<mnum>:MARKer<mkr>:NOTCh:THReshold?

Return Type

Numeric

Default

-3

CALCulate<cnum>:MEASure<mnum>:MARKer:PNOP:BACKoff <num>

Applicable Models: All

(Read-Write) Turns on and sets markers 1, 2, 3, and 4 to calculate various PNOP parameters.

Either this command, or the PNOFFset command, will initiate the PNOP search markers.

To turn off the PNOP markers, either turn them off individually or turn them All Off.

To search a User Range with the PNOP search, first activate marker 1 and set the desired User Range. Then send CALC:MARK:PNOP:BACK. The user range used with the PNOP search only applies to marker 1 searching for the linear gain value. The other markers may fall outside the user range.

Parameters

- <cnum> Channel number of the measurement. There must be a selected measurement on that channel. If unspecified, <cnum> is set to 1.
- <mnum> Measurement number for each measurement. There must be a selected measurement on the trace. If unspecified, <mnum> is set to 1.
- <num> Backoff value. Choose any number between **-500** and **500**

Examples

```
CALC:MEAS:MARK:PNOP:BACK?
calculate2:measure1:marker:pnop:backoff 10
```

Query Syntax

CALCulate<cnum>:MEASure<mnum>:MARKer:PNOP:BACKoff?

Return Type

Numeric

Default

0

CALCulate<cnum>:MEASure<mnum>:MARKer:PNOP:BACKoff:GAIN?

Applicable Models: All

(Read-only) Reads the power backoff gain value from a PNOP marker search.

PBO Gain = PBO Out - PBO In

Use CALC:MARK:PNOP:BACK or CALC:MARK:PNOP:POFF to initiate a PNOP search.

Parameters

<cnum> Channel number of the measurement. There must be a selected measurement on that channel. If unspecified, <cnum> is set to 1.

<mnum> Measurement number for each measurement. There must be a selected measurement on the trace. If unspecified, <mnum> is set to 1.

Examples

```
CALC:MEAS1:MARK:PNOP:BACK:GAIN?
```

Default Not applicable

CALCulate<cnum>:MEASure<mnum>:MARKer:PNOP:BACKoff:PIN?

Applicable Models: All

(Read-only) Reads the power backoff input value from a PNOP marker search.

PBO In = Marker 2 X-axis

Use CALC:MARK:PNOP:BACK or CALC:MARK:PNOP:POFF to initiate a PNOP search.

Parameters

<cnum> Channel number of the measurement. There must be a selected measurement on that channel. If unspecified, <cnum> is set to 1.

<mnum> Measurement number for each measurement. There must be a selected measurement on the trace. If unspecified, <mnum> is set to 1.

Examples

```
CALC:MEAS1:MARK:PNOP:BACK:PIN?
```

Default Not applicable

CALCulate<cnum>:MEASure<mnum>:MARKer:PNOP:BACKoff:POUT?

Applicable Models: All

(Read-only) Reads the power backoff output value from a PNOP marker search.

PBO Out = Marker 2 Y-axis

Use CALC:MARK:PNOP:BACK or CALC:MARK:PNOP:POFF to initiate a PNOP search.

Parameters

<num> Channel number of the measurement. There must be a selected measurement on that channel. If unspecified, <num> is set to 1.

<mnum> Measurement number for each measurement. There must be a selected measurement on the trace. If unspecified, <mnum> is set to 1.

Examples CALC:MEAS1:MARK:PNOP:BACK:POUT?

Default Not applicable

CALCulate<num>:MEASure<mnum>:MARKer:PNOP:COMPression?

Applicable Models: All

(Read-only) Reads the PNOP compression value from a PNOP marker search.

Pnop Comp = Pnop Gain - Linear Gain (not shown on marker readout).

Use CALC:MARK:PNOP:BACK or CALC:MARK:PNOP:POFF to initiate a PNOP search.

Parameters

<num> Channel number of the measurement. There must be a selected measurement on that channel. If unspecified, <num> is set to 1.

<mnum> Measurement number for each measurement. There must be a selected measurement on the trace. If unspecified, <mnum> is set to 1.

Examples CALC:MEAS1:MARK:PNOP:COMP?

Default Not applicable

CALCulate<num>:MEASure<mnum>:MARKer:PNOP:COMPression:MAXimum?

Applicable Models: All

(Read-only) Reads the max compression value from a PNOP marker search.

Comp Max = Gain Max - Linear Gain (not shown on marker readout).

Use CALC:MARK:PNOP:BACK or CALC:MARK:PNOP:POFF to initiate a PNOP search.

Parameters

<cnm> Channel number of the measurement. There must be a selected measurement on that channel. If unspecified, <cnm> is set to 1.

<mnm> Measurement number for each measurement. There must be a selected measurement on the trace. If unspecified, <mnm> is set to 1.

Examples CALC:MEAS1:MARK:PNOP:COMP:MAX?

Default Not applicable

CALCulate<cnm>:MEASure<mnm>:MARKer:PNOP:GAIN?

Applicable Models: All

(Read-only) Reads the PNOP gain value from a PNOP marker search.

Pnop Gain = Pnop Out - Pnop In.

Use CALC:MARK:PNOP:BACK or CALC:MARK:PNOP:POFF to initiate a PNOP search.

Parameters

<cnm> Channel number of the measurement. There must be a selected measurement on that channel. If unspecified, <cnm> is set to 1.

<mnm> Measurement number for each measurement. There must be a selected measurement on the trace. If unspecified, <mnm> is set to 1.

Examples CALC:MEAS:MARK:PNOP:GAIN?

Default Not applicable

CALCulate<cnm>:MEASure<mnm>:MARKer:PNOP:GAIN:MAXimum?

Applicable Models: All

(Read-only) Reads the max gain from a PNOP marker search.

$$\text{Gain Max} = \text{PMax Out} - \text{PMax In}$$

Use CALC:MARK:PNOP:BACK or CALC:MARK:PNOP:POFF to initiate a PNOP search.

Parameters

<cnm> Channel number of the measurement. There must be a selected measurement on that channel. If unspecified, <cnm> is set to 1.

<mnm> Measurement number for each measurement. There must be a selected measurement on the trace. If unspecified, <mnm> is set to 1.

Examples CALC:MEAS:MARK:PNOP:GAIN:MAX?

Default Not applicable

CALCulate<cnm>:MEASure<mnm>:MARKer:PNOP:PIN?

Applicable Models: All

(Read-only) Reads the PNOP input value from a PNOP marker search.

$$\text{Pnop In} = \text{Marker 4 X-axis value}$$

Use CALC:MARK:PNOP:BACK or CALC:MARK:PNOP:POFF to initiate a PNOP search.

Parameters

<cnm> Channel number of the measurement. There must be a selected measurement on that channel. If unspecified, <cnm> is set to 1.

<mnm> Measurement number for each measurement. There must be a selected measurement on the trace. If unspecified, <mnm> is set to 1.

Examples CALC:MEAS:MARK:PNOP:PIN?

Default Not applicable

CALCulate<cnm>:MEASure<mnm>:MARKer:PNOP:PIN:MAXimum?

Applicable Models: All

(Read-only) Reads the max input power from a PNOP marker search.

PMax In = Marker 3 X-axis value

Use CALC:MARK:PNOP:BACK or CALC:MARK:PNOP:POFF to initiate a PNOP search.

Parameters

<cnum> Channel number of the measurement. There must be a selected measurement on that channel. If unspecified, <cnum> is set to 1.

<mnum> Measurement number for each measurement. There must be a selected measurement on the trace. If unspecified, <mnum> is set to 1.

Examples

```
CALC:MEAS:MARK:PNOP:PIN:MAX?
```

Default Not applicable

CALCulate<cnum>:MEASure<mnum>:MARKer:PNOP:POFFset <num>

Applicable Models: All

(Read-Write) Turns on and sets markers 1, 2, 3, and 4 to calculate various PNOP parameters.

Either this command, or the Backoff command, will initiate the PNOP search markers.

To turn off the PNOP markers, either turn them off individually or turn them All Off .

To search a User Range with the PNOP search, first activate marker 1 and set the desired User Range . Then send the CALC:MARK:PNOP:POFF command. The user range used with the PNOP search only applies to marker 1 searching for the linear gain value. The other markers may fall outside the user range.

Parameters

<cnum> Channel number of the measurement. There must be a selected measurement on that channel. If unspecified, <cnum> is set to 1.

<mnum> Measurement number for each measurement. There must be a selected measurement on the trace. If unspecified, <mnum> is set to 1.

<num> Power Offset value in dB. Choose any number between **-500** and **500**

Examples

```
CALC:MEAS1:MARK:PNOP:POFF 3
```

```
calculate2:measure2:marker:pnop:poffset 10
```

Query Syntax CALCulate<cnum>:MEASure<mnum>:MARKer:PNOP:POFFset?

Return Type Numeric

Default 0

CALCulate<cnum>:MEASure<mnum>:MARKer:PNOP:POUT?

Applicable Models: All

(Read-only) Reads the output power value of the offset marker from a PNOP marker search.

Pnop Out = Marker 4 Y-axis value

Use CALC:MARK:PNOP:BACK or CALC:MARK:PNOP:POFF to initiate a PNOP search.

Parameters

<cnum> Channel number of the measurement. There must be a selected measurement on that channel. If unspecified, <cnum> is set to 1.

<mnum> Measurement number for each measurement. There must be a selected measurement on the trace. If unspecified, <mnum> is set to 1.

Examples CALC:MEAS2:MARK:PNOP:POUT?

Default Not applicable

CALCulate<cnum>:MEASure<mnum>:MARKer:PNOP:POUT:MAXimum?

Applicable Models: All

(Read-only) Reads the max output power from a PNOP marker search.

PMax Out = Marker 3 Y-axis value

Use CALC:MARK:PNOP:BACK or CALC:MARK:PNOP:POFF to initiate a PNOP search.

Parameters

<cnum> Channel number of the measurement. There must be a selected measurement on that channel. If unspecified, <cnum> is set to 1.

<mnum> Measurement number for each measurement. There must be a selected measurement on the trace. If unspecified, <mnum> is set to 1.

Examples CALC:MEAS2:MARK:PNOP:POUT:MAX?

Default Not applicable

CALCulate<cnum>:MEASure<mnum>:MARKer<mkr>:PNOP[:STATe] <ON|OFF>

Applicable Models: All

(Read-Write) Turns the PNOP marker search ON and OFF.

Parameters

- <cnum> Channel number of the measurement. There must be a selected measurement on that channel. If unspecified, <cnum> is set to 1.
- <mnum> Measurement number for each measurement. There must be a selected measurement on the trace. If unspecified, <mnum> is set to 1.
- <mkr> Any marker number from 1 to 15; if unspecified, value is set to 1.
- <ON|OFF> **ON** (or 1) - turns marker ON.
- OFF** (or 0) - turns marker OFF.

Examples

```
CALC:MEAS1:MARK:PNOP ON
calculate2:measure2:marker8:pnop on
```

Query Syntax CALCulate<cnum>:MEASure<mnum>:MARKer<mkr>:PNOP:STATe?

Return Type Boolean (1 = ON, 0 = OFF)

Default Off

CALCulate<cnum>:MEASure<mnum>:MARKer:PSATuration:BACKoff <num>

Applicable Models: All

(Read-Write) Turns on and sets markers 1, 2, and 3 to calculate various Power Saturation parameters.

The <num> parameter sets and reads the back-off value for a Power Saturation marker search.

To turn off the Power Saturation markers, either turn them off individually or turn them All Off .

To search a User Range with the PSAT search, first activate marker 1 and set the desired User Range . Then send the CALC:MARK:PSAT:BACK command. The user range used with the PSAT search only applies to marker 1 searching for the linear gain value. The other markers may fall outside the user range.

Parameters

- <cnum> Channel number of the measurement. There must be a selected measurement on that channel. If unspecified, <cnum> is set to 1.
- <mnum> Measurement number for each measurement. There must be a selected measurement on the trace. If unspecified, <mnum> is set to 1.

<num> Backoff value. Choose any number between **-500** and **500**

Examples

```
CALC:MEAS2:MARK:PSAT:BACK 3  
calculate2:measure2:marker:psaturation:backoff 10
```

Query Syntax CALCulate<cnum>:MEASure<mnum>:MARKer:PSATuration:BACKoff?

Return Type Numeric

Default 0

CALCulate<cnum>:MEASure<mnum>:MARKer:PSATuration:COMPression:MAXimum?

Applicable Models: All

(Read-only) Reads the compression maximum value from a PSAT marker search.

Comp Max = Gain Max - Gain Linear

Use CALC:MARK:PSAT:BACK to initiate a PSAT search.

Parameters

<cnum> Channel number of the measurement. There must be a selected measurement on that channel. If unspecified, <cnum> is set to 1.

<mnum> Measurement number for each measurement. There must be a selected measurement on the trace. If unspecified, <mnum> is set to 1.

Examples

```
CALC:MEAS2:MARK:PSAT:COMP:MAX?
```

Default Not applicable

CALCulate<cnum>:MEASure<mnum>:MARKer:PSATuration:COMPression:SATuration?

Applicable Models: All

(Read-only) Reads the compression saturation value from a PSAT marker search.

$$\text{Comp Sat} = \text{Gain Sat} - \text{Gain Linear}$$

Use CALC:MARK:PSAT:BACK to initiate a PSAT search.

Parameters

<num> Channel number of the measurement. There must be a selected measurement on that channel. If unspecified, <num> is set to 1.

<mnum> Measurement number for each measurement. There must be a selected measurement on the trace. If unspecified, <mnum> is set to 1.

Examples CALC:MEAS2:MARK:PSAT:COMP:SAT?

Default Not applicable

CALCulate<num>:MEASure<mnum>:MARKer:PSATuration:GAIN?

Applicable Models: All

(Read-only) Reads the saturation gain value from a PSAT marker search.

$$\text{Gain Sat} = \text{Psat Out} - \text{Psat In}$$

Use CALC:MARK:PSAT:BACK to initiate a PSAT search.

Parameters

<num> Channel number of the measurement. There must be a selected measurement on that channel. If unspecified, <num> is set to 1.

<mnum> Measurement number for each measurement. There must be a selected measurement on the trace. If unspecified, <mnum> is set to 1.

Examples CALC:MEAS2:MARK:PSAT:GAIN?

Default Not applicable

CALCulate<num>:MEASure<mnum>:MARKer:PSATuration:GAIN:LINEar?

Applicable Models: All

(Read-only) Reads the linear gain value from a PSAT marker search.

Gain Linear = Marker 1 - Y-axis value MINUS X-axis value.

Use CALC:MARK:PSAT:BACK to initiate a PSAT search.

Parameters

<cnm> Channel number of the measurement. There must be a selected measurement on that channel. If unspecified, <cnm> is set to 1.

<mnum> Measurement number for each measurement. There must be a selected measurement on the trace. If unspecified, <mnum> is set to 1.

Examples CALC:MEAS2:MARK:PSAT:GAIN:LIN?

Default Not applicable

CALCulate<cnm>:MEASure<mnum>:MARKer:PSATuration:GAIN:MAXimum?

Applicable Models: All

(Read-only) Reads the maximum gain value from a PSAT marker search.

Gain Max = PMax Out - PMax In

Use CALC:MARK:PSAT:BACK to initiate a PSAT search.

Parameters

<cnm> Channel number of the measurement. There must be a selected measurement on that channel. If unspecified, <cnm> is set to 1.

<mnum> Measurement number for each measurement. There must be a selected measurement on the trace. If unspecified, <mnum> is set to 1.

Examples CALC:MEAS2:MARK:PSAT:GAIN:MAX?

Default Not applicable

CALCulate<cnm>:MEASure<mnum>:MARKer:PSATuration:PIN?

Applicable Models: All

(Read-only) Reads the power saturation input value from a PSAT marker search.

Psat In = Marker 2 X-axis value

Use CALC:MARK:PSAT:BACK to initiate a PSAT search.

Parameters

<num> Channel number of the measurement. There must be a selected measurement on that channel. If unspecified, <num> is set to 1.

<mnum> Measurement number for each measurement. There must be a selected measurement on the trace. If unspecified, <mnum> is set to 1.

Examples CALC:MEAS2:MARK:PSAT:PIN?

Default Not applicable

CALCulate<num>:MEASure<mnum>:MARKer:PSATuration:PIN:MAXimum?

Applicable Models: All

(Read-only) Reads the maximum input power from a PSAT marker search.

PMax In = Marker 3 X-axis value

Use CALC:MARK:PSAT:BACK to initiate a PSAT search.

Parameters

<num> Channel number of the measurement. There must be a selected measurement on that channel. If unspecified, <num> is set to 1.

<mnum> Measurement number for each measurement. There must be a selected measurement on the trace. If unspecified, <mnum> is set to 1.

Examples CALC:MEAS2:MARK:PSAT:PIN:MAX?

Default Not applicable

CALCulate<num>:MEASure<mnum>:MARKer:PSATuration:POUT?

Applicable Models: All

(Read-only) Reads the back-off output power from a PSAT marker search.

PSat Out = Marker 2 Y-axis value

Use CALC:MARK:PSAT:BACK to initiate a PSAT search.

Parameters

<cnm> Channel number of the measurement. There must be a selected measurement on that channel. If unspecified, <cnm> is set to 1.

<mnum> Measurement number for each measurement. There must be a selected measurement on the trace. If unspecified, <mnum> is set to 1.

Examples CALC:MEAS2:MARK:PSAT:POUT?

Default Not applicable

CALCulate<cnm>:MEASure<mnum>:MARKer:PSATuration:POUT:MAXimum?

Applicable Models: All

(Read-only) Reads the back-off output power from a PSAT marker search.

PMaxOut = Marker 3 Y-axis value

Use CALC:MARK:PSAT:BACK to initiate a PSAT search.

Parameters

<cnm> Channel number of the measurement. There must be a selected measurement on that channel. If unspecified, <cnm> is set to 1.

<mnum> Measurement number for each measurement. There must be a selected measurement on the trace. If unspecified, <mnum> is set to 1.

Examples CALC:MEAS2:MARK:PSAT:POUT:MAX?

Default Not applicable

CALCulate<cnm>:MEASure<mnum>:MARKer<mkr>:PSATuration[:STATe] <ON|OFF>

Applicable Models: All

(Read-Write) Turns the PSAT marker search ON and OFF.

Parameters

- <cnum> Channel number of the measurement. There must be a selected measurement on that channel. If unspecified, <cnum> is set to 1.
- <mnum> Measurement number for each measurement. There must be a selected measurement on the trace. If unspecified, <mnum> is set to 1.
- <mkr> Any marker number from 1 to 15; if unspecified, value is set to 1.
- <ON|OFF> **ON** (or 1) - turns marker ON.
OFF (or 0) - turns marker OFF.

Examples

```
CALC:MEAS1:MARK:PSAT ON  
calculate2:measure2:marker8:psaturation on
```

Query Syntax CALCulate<cnum>:MEASure<mnum>:MARKer<mkr>:PSATuration:STATE?

Return Type Boolean (1 = ON, 0 = OFF)

Default Off

CALCulate<cnum>:MEASure<mnum>:MARKer<mkr>:REFerence[:STATE] <bool>

Applicable Models: All

(Read-Write) Turns ON or OFF the reference marker mode, for the active trace of selected channel. When turned OFF, existing Delta markers revert to absolute markers.

Parameters

- <cnum> Channel number of the measurement. There must be a selected measurement on that channel. If unspecified, <cnum> is set to 1.
- <mnum> Measurement number for each measurement. There must be a selected measurement on the trace. If unspecified, <mnum> is set to 1.
- <mkr> Any marker number from 1 to 15; if unspecified, value is set to 1.
- <bool> **ON** or 1 - Turns reference marker mode ON.
OFF or 0 - Turns reference marker mode OFF.

Examples

```
CALC:MEAS:MARK:REF ON  
calculate2:measure1:marker:reference:state OFF
```

Query Syntax CALCulate<cnum>:MEASure<mnum>:MARKer<mkr>:REFerence[:STATE]?

Return Type Boolean

CALCulate<cnum>:MEASure<mnum>:MARKer<mkr>:REFerence:X <num>

Applicable Models: All

(Read-Write) Sets and returns the absolute x-axis value of the reference marker.

Parameters

- <cnum> Channel number of the measurement. There must be a selected measurement on that channel. If unspecified, <cnum> is set to 1.
- <mnum> Measurement number for each measurement. There must be a selected measurement on the trace. If unspecified, <mnum> is set to 1.
- <mkr> Any marker number from 1 to 15; if unspecified, value is set to 1.
- <num> X-axis value. Choose any number within the operating domain of the reference marker.

Examples

```
CALC:MEAS:MARK:REF:X 1e9  
calculate2:measure1:marker:reference:x 1e6
```

Query Syntax

CALCulate<cnum>:MEASure<mnum>:MARKer<mkr>:REFerence:X?

Return Type

Numeric

Default

If the first Marker, turns ON in the middle of the X-axis span. If not, turns ON at the position of the active marker.

CALCulate<cnum>:MEASure<mnum>:MARKer<mkr>:REFerence:Y <num>

Applicable Models: All

(Read-Write) Sets and returns the absolute Y-axis value of the reference marker (Set the reference marker Y position only when the marker is a fixed marker type).

Parameters

- <cnum> Channel number of the measurement. There must be a selected measurement on that channel. If unspecified, <cnum> is set to 1.
- <mnum> Measurement number for each measurement. There must be a selected measurement on the trace. If unspecified, <mnum> is set to 1.
- <mkr> Any marker number from 1 to 15; if unspecified, value is set to 1.
- <num> Y-axis value. Choose any number within the operating domain of the reference marker.

Examples

```
CALC:MEAS:MARK:REF:Y 1e6  
calculate2:measure1:marker:reference:y 1e9
```

Return Type	Numeric
Default	Not Applicable

CALCulate<cnum>:MEASure<mnum>:MARKer<mkr>:SET <char>

Applicable Models: All

(Write-only) Sets the selected instrument setting to assume the value of the specified marker.

Marker Functions CENT, SPAN, START, and STOP do not work with channels that are in CW or Segment Sweep mode.

Parameters

- <cnum> Channel number of the measurement. There must be a selected measurement on that channel. If unspecified, <cnum> is set to 1.
- <mnum> Measurement number for each measurement. There must be a selected measurement on the trace. If unspecified, <mnum> is set to 1.
- <mkr> Any marker number from 1 to 15; if unspecified, value is set to 1
- <char> Choose from:

- **CENTer** - changes center frequency to the value of the marker.
- **SPAN** - changes the sweep span to the span that is defined by the delta marker and the marker that it references. Unavailable if there is no delta marker.
- **START** - changes the start frequency to the value of the marker.
- **STOP** - changes the stop frequency to the value of the marker.
- **RLEVel** - changes the reference level to the value of the marker.
- **DELay** - changes the line length at the receiver input to the phase slope at the active marker stimulus position.
- **CWFReq** - Sets the CW frequency to the frequency of the active marker. Does NOT change sweep type. NOT available in CW or Power Sweep. Use this argument to first set the CW Frequency to a value that is known to be within the current calibrated range, THEN set Sweep:Type to POWER or CW.

Examples

```
CALC:MEAS:MARK:SET CENT
calculate2:measure1:marker8:set span
```

Query Syntax	Not Applicable
Default	Not Applicable

CALCulate<cnum>:MEASure<mnum>:MARKer<mkr>[:STATe] <bool>

Applicable Models: All

(Read-Write) Turns ON or OFF the specified marker. Marker 16 is the Reference Marker. To turn all markers OFF, use CALC:MEAS:MARK:AOFF .

Parameters

- <cnum> Channel number of the measurement. There must be a selected measurement on that channel. If unspecified, <cnum> is set to 1.
- <mnum> Measurement number for each measurement. There must be a selected measurement on the trace. If unspecified, <mnum> is set to 1.
- <mkr> Any marker number from 1 to 15; if unspecified, value is set to 1.
- <bool> ON or 1 - Turns marker ON.
OFF or 0 - Turns marker OFF.

Examples

```
CALC:MEAS:MARK ON  
calculate2:measure1:marker8 off
```

Query Syntax

CALCulate<cnum>:MEASure<mnum>:MARKer<mkr>:STATe?

Return Type

Boolean

Default

OFF or 0

CALCulate<cnum>:MEASure<mnum>:MARKer<mkr>:TYPE <char>

Applicable Models: All

(Read-Write) Sets the type of the specified marker.

Parameters

- <cnum> Channel number of the measurement. There must be a selected measurement on that channel. If unspecified, <cnum> is set to 1.
- <mnum> Measurement number for each measurement. There must be a selected measurement on the trace. If unspecified, <mnum> is set to 1.
- <mkr> Any marker number from 1 to 15; if unspecified, value is set to 1
- <char> Choose from:

- NORMAL - a marker that stays on the assigned X-axis position unless moved or searching.
- FIXEd - a marker that will not leave the assigned X or current Y-axis position.

Examples

```
CALC:MEAS:MARK:TYPE NORM  
calculate2:measure1:marker2:type fixed
```

Query Syntax

CALCulate<cnum>:MEASure<mnum>:MARKer<mkr>:TYPE?

Return Type Character
Default NORMal

CALCulate<cnum>:MEASure<mnum>:MARKer<mkr>:X <num>

Applicable Models: All

(Read-Write) Sets the marker's X-axis value (frequency, power, or time). If the marker is set as delta, the SET and QUERY data is relative to the reference marker.

Parameters

- <cnum> Channel number of the measurement. There must be a selected measurement on that channel. If unspecified, <cnum> is set to 1.
- <mnum> Measurement number for each measurement. There must be a selected measurement on the trace. If unspecified, <mnum> is set to 1.
- <mkr> Any marker number from 1 to 15; if unspecified, value is set to 1.
- <num> Any X-axis position within the measurement span of the marker.

(When the span value of the sweep range is 0, the range is from 0 to sweep time value.)

Notes: If the specified variable is out of the allowable setup range, the minimum value (if the lower limit of the range is not reached) or the maximum value (if the upper limit of the range is exceeded) is set.

This command will accept MIN or MAX instead of a numeric parameter. See SCPI Syntax for more information.

<unit> Hz (hertz), dBm or s (second)

Examples

```
CALC:MEAS:MARK:X 100Mhz  
calculate2:measure1:marker8:x maximum
```

Query Syntax

CALCulate<cnum>:MEASure<mnum>:MARKer<mkr>:X?

Return Type

Numeric

Default

First Marker turns ON in the middle of the X-axis span. Subsequent markers turn ON at the position of the active marker.

(When the span value of the sweep range is 0, the preset value is 0.)

CALCulate<cnum>:MEASure<mnum>:MARKer<mkr>:Y?

Applicable Models: All

(Read-only) Reads the marker's Y-axis value. The format of the value depends on the current CALC:MEAS:MARK:FORMAT setting. If the marker is set as delta, the data is relative to the reference marker. The query always returns two numbers:

- Smith and Polar formats - (Real, Imaginary)
- LINPhase and LOGPhase - (Real, Imaginary)
- All other formats - (Value,0)

Note: To accurately read the marker Y-axis value with trace smoothing applied, the requested format must match the displayed format. Otherwise, the returned value is un-smoothed data. For example, to read the smoothed marker value when measuring group delay, both the display format and the marker format must be set to (Group) Delay.

Parameters

- <num> Channel number of the measurement. There must be a selected measurement on that channel. If unspecified, <num> is set to 1.
- <mnum> Measurement number for each measurement. There must be a selected measurement on the trace. If unspecified, <mnum> is set to 1.
- <mkr> Any marker number from 1 to 15; if unspecified, value is set to 1.

Examples

```
CALC:MEAS:MARK:Y?  
calculate2:measure1:marker3:y?
```

Query Syntax CALCulate<num>:MEASure<mnum>:MARKer<mkr>:Y?

Return Type Numeric

Default Not Applicable

CALCulate:MEASure:OFFSet Commands

Allows the data trace magnitude and phase to be offset.

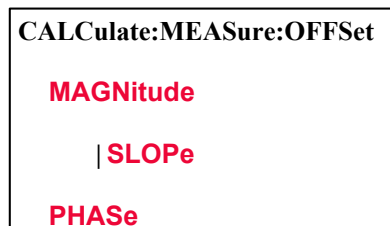

Click a [keyword](#) to view the command details.

See Also

- [Learn about Magnitude Offset](#)
- [Learn about Phase Offset](#)
- [Synchronizing the Analyzer and Controller](#)
- [SCPI Command Tree](#)

CALCulate<cnum>:MEASure<mnum>:OFFSet:MAGNitude <num>

Applicable Models: All

(Read-Write) Offsets the data trace magnitude by the specified value.

To offset the data trace magnitude to a slope value that changes with frequency, use

CALC:MEAS:OFFS:MAGN:SLOP

Parameters

- <cnum> Channel number of the measurement. There must be a selected measurement on that channel. If unspecified, <cnum> is set to 1.
- <mnum> Measurement number for each measurement. There must be a selected measurement on the trace. If unspecified, <mnum> is set to 1.
- <num> Offset value in dB.

Examples

```
CALC:MEAS:OFFS:MAGN:4  
calculate1:measure2:offset:magnitude -2
```

Query Syntax

CALCulate<cnum>:MEASure<mnum>:OFFSet:MAGNitude?

Return Type

Numeric

Default 0

CALCulate<cnum>:MEASure<mnum>:OFFSet:MAGNitude:SLOPe <num>

Applicable Models: All

(Read-Write) Offsets the data trace magnitude to a value that changes linearly with frequency. The offset slope begins at 0 Hz.

Parameters

- <cnum> Channel number of the measurement. There must be a selected measurement on that channel. If unspecified, <cnum> is set to 1.
- <mnum> Measurement number for each measurement. There must be a selected measurement on the trace. If unspecified, <mnum> is set to 1.
- <num> Offset slope value in dB/ 1GHz.

Examples

```
CALC:MEAS:OFFS:MAGN:SLOP 1 'Offset slope set to 1dB/GHz  
calculate1:measure2:offset:magnitude:slope -2 'Offset slope set to -  
2dB/GHz
```

Query Syntax

CALCulate<cnum>:MEASure<mnum>:OFFSet:MAGNitude:SLOPe?

Return Type

Numeric

Default 0

CALCulate<cnum>:MEASure<mnum>:OFFSet:PHASe <num>[<char>]

Applicable Models: All

(Read-Write) Sets the phase offset for the selected measurement.

Parameters

- <cnum> Channel number of the measurement. There must be a selected measurement on that channel. If unspecified, <cnum> is set to 1.
- <mnum> Measurement number for each measurement. There must be a selected measurement on the trace. If unspecified, <mnum> is set to 1.
- <num> Offset phase value. Choose any number between:
-360 and 360
- Units for phase. OPTIONAL. Choose either:
 - <char> DEG - Degrees (default)
 - RAD - Radians

Examples

```
CALC:MEAS:OFFS:PHAS 10  
calculate3:measure2:offset:phase 20rad
```

Query Syntax

CALCulate<cnum>:MEASure<mnum>:OFFSet:PHASe?

Return Type Numeric, returned value always in degrees
Default 0 degrees

CALCulate:MEASure:PARAmeter Commands

Selects a measurement parameter.

CALCulate:MEASure

PARAmeter

Click a [keyword](#) to view the command details.

See Also

- [Learn about Measurement Parameters](#)
- [Synchronizing the Analyzer and Controller](#)
- [SCPI Command Tree](#)

CALCulate<cnum>:MEASure<mnum>:PARAmeter <string>

Applicable Models: All

(Read-Write) Set/get a measurement parameter for the specified (cnum/mnum) measurement.

This command replaces the following commands:

CALC:CUST:MOD

CALC:PAR:MOD:EXT

CALC:FSIM:BAL:PAR:SBAL[:DEF]

CALC:FSIM:BAL:PAR:SSB[:DEF]

CALC:FSIM:BAL:PAR:BBAL[:DEF]

CALC:FSIM:BAL:PAR:BALS[:DEF]

CALC:FSIM:BAL:PAR:BAL[:DEF]

Note: For Application Measurements see [CALCulate:MEASure:DEFine](#)

Parameters	
<cnum>	Channel number of the measurements to be listed. There must be a selected measurement on that channel. If unspecified, <cnum> is set to 1.

<mnum>	<p>Measurement number for each measurement. There must be a selected measurement on the trace. If unspecified, <mnum> is set to 1.</p>
<string>	<p>(String) Measurement Parameter to create. Case sensitive.</p> <p>For S-parameters:</p> <p>Any S-parameter available in the VNA</p> <p>Single-digit port numbers CAN be separated by "_" (underscore). For example: "S21" or "S2_1"</p> <p>Double-digit port numbers MUST be separated by underscore. For example: "S10_1"</p> <p>For ratioed measurements:</p> <p>Any two VNA physical receivers separated by forward slash "/" followed by comma and source port.</p> <p>For example: "A/R1, 3"</p> <p>Learn more about ratioed measurements</p> <p>See a block diagram showing the receivers in YOUR VNA.</p> <p>For non-ratioed measurements:</p> <p>Any VNA physical receiver followed by comma and source port.</p> <p>For example: "A, 4"</p> <p>Learn more about unratioed measurements.</p> <p>See the block diagram showing the receivers in YOUR VNA.</p> <p>Ratioed and Unratioed measurements can also use logical receiver notation to refer to receivers. This notation makes it easy to refer to receivers with an external test set connected to the VNA. You do not need to know which physical receiver is used for each test port. Learn more.</p> <p>For ADC measurements:</p> <p>Any ADC receiver in the VNA followed by a comma, then the source port.</p> <p>For example: "AI1,2" indicates the Analog Input1 with source port of 2.</p> <p>Learn more about ADC receiver measurements.</p>

For Balanced Measurements:

For 1 port balanced measurement, choose from:

Sdd11, Scd11, Sdc11, Scc11

For Balanced - Single-ended measurement, choose from:

Sdd11, Scd11, Sdc11, Scc11, Ssd21, Ssc21, Sds12, Scs12, Sss22, Imb, CMMR1, CMMR2

- $Imb = - S_{1pos_2}/S_{1neg_2}$
- $CMMR1 = Ssd21/Ssc21$
- $CMMR2 = Sds12/Scs12$

For Single-ended - Balanced measurement, choose from:

Sss11, Sds21, Scs21, Ssd12, Ssc12, Sdd22, Scd22, Sdc22, Scc22, Imb, CMMR1, CMMR2

- $Imb = - S_{2pos_1}/S_{2neg_1}$
- $CMMR1 = Sds21/Scs21$
- $CMMR2 = Ssd12/Ssc12$

For Balanced - Balanced measurement, choose from:

Sdd11, Sdd21, Sdd12, Sdd22, Scd11, Scd21, Scd12, Scd22, Sdc11, Sdc21, Sdc12, Sdc22,

Scc11, Scc21, Scc12, Scc22, Imb1, Imb2, CMMR

- $Imb1 = - (S_{1pos_2pos} - S_{1pos_2neg}) / (S_{1neg_2pos} - S_{1neg_2neg})$
- $Imb2 = - (S_{2pos_1pos} - S_{2pos_1neg}) / (S_{2neg_1pos} - S_{2neg_1neg})$
- $CMMR = - Sdd21/Scc21$

For Single-ended - Single-ended - Balanced measurement, choose from:

Sss11, Sss21, Sss12, Sss22, Sds31, Scs31, Sds32, Scs32, Ssd13, Ssd23, Ssc13, Ssc23,

Sdd33, Scd33, Sdc33, Scc33, Imb1, Imb2, CMMR1, CMMR2

- $Imb1 = - (S_{1pos_2pos} - S_{1pos_2neg}) / (S_{1neg_2pos} - S_{1neg_2neg})$
- $Imb2 = - (S_{2pos_1pos} - S_{2pos_1neg}) / (S_{2neg_1pos} - S_{2neg_1neg})$
- $Imb3 = - S_{3pos_1} / S_{3neg_1}$
- $Imb4 = - S_{3pos_2} / S_{3neg_2}$
- $CMMR1 = Sds31 / Scs31$
- $CMMR2 = Sds32 / Scs32$

Note: The right definition for SSB imbalance is added as Imb3, 4. The definition for SSB Imb1, 2 seem a mistake, but keep it remained for backward compatibility.

Choose from the following (click or scroll down to view valid measurement parameters for each measurement class)

- "Standard"
- "Scalar Mixer/Converter"
- "Gain Compression"
- "Noise Figure Cold Source"

(variant) Measurement names to create:

Meas Class	Measurement Name	Description
"Standard"	"S11", "S21", and so forth "A_1", "A_2", and so forth	S-parameter name Unratioed parameter names with notation: "receiver_source port" See balanced parameter names
	For input port X and output port Y: "SCXY" "SCYX"	Learn about SMC parameters Note: Input and output ports are set up using the Mixer Setup dialog. If

<p>"Scalar Mixer/Converter"</p>	<p>"SXX" "SYY" "Ipwr" "RevIPwr" "Opwr" "RevOPwr"</p> <p>the ports are not set up using the Mixer Setup dialog, then ports 1 and 2 are the default input and output ports and the only ports that can be used.</p>
<p>"Gain Compression"</p> <p>Learn more</p>	<p>GCA:</p> <p>"CompIn21" Input power at the compression point. "CompOut21" Output power at the compression point. "CompGain21" Gain at the compression point. "CompS11" Input Match at the compression point "RefS21" Linear Gain "DeltaGain21" CompGain21 -Linear Gain "S11", "S21", "S12", "S22" Standard S-parameters; measured at port 1 and port 2</p>
	<p>Noise Figure :</p> <p>"NF" Noise figure "ENR" Validate noise source measurements. "T-Eff" Effective noise temperature. "DUTRNP" DUT noise power ratio. (Noise power expressed in Kelvin divided by 290). "DUTRNPI" "SYSRNP" System noise power ratio "SYSRNPI" "DUTNPD" DUT noise power density. (Noise power expressed in dBm/Hz). "DUTNPDI"</p>

<p>"Noise Figure Cold Source"</p> <p>Learn more</p>	<p>"SYSNPD"</p>	System noise power density.
	<p>"SYSNPDI"</p>	
	<p>"OvrRng" (Opt 029 Only)</p>	Indication that the noise receiver is being over powered.
	<p>"T-Rcvr" (Opt 029 Only)</p>	Temperature reading (in Kelvin) of the noise receiver board.
	<p>"S11", "S21", "S12", "S22"</p>	Standard S-parameters; measured with the port1 and port2 noise switches set for noise mode.
<p>"A_1", "A_2" ...and so forth.</p> <p>"GammaOpt"</p> <p>"Rn"</p> <p>"NFMin"</p>	<p>Unratioed parameters; with notation: "receiver, source port"</p> <p>Optimum Complex Reflection Coefficient</p> <p>Noise Resistance</p> <p>Minimum noise figure that occurs at GammaOpt</p>	

Examples	<pre>CALC:MEAS:PAR "Sdd11"</pre> <pre>calculate2:measure2:parameter "Sdd11"</pre>
Query Syntax	CALCulate<cnun>:MEASure<mnum>:PARAmeter?
Return Type	String
Default	"S11"

CALCulate:MEASure:RLIMit Commands

These commands are for setting up ripple tests.

CALCulate:MEASure:RLIMit
DATA
DISPlay
LINE
STATe
SElect
TYPe
FAIL
REPort
DATA
STATe

Click a [keyword](#) to view the command details.

see Also

- Learn about Ripple tests
- [Synchronizing the Analyzer and Controller](#)
- [SCPI Command Tree](#)

CALCulate<cnum>:MEASure<mnum>:RLIMit:DATA <data>

Applicable Models: All

(Read-Write) Sets or returns the ripple limit table for the active trace of selected channel.

Parameters

- <cnum> Channel number of the measurement. There must be a selected measurement on that channel. If unspecified, <cnum> is set to 1.
- <mnum> Measurement number for each measurement. There must be a selected measurement on the trace. If unspecified, <mnum> is set to 1.
- <data> Indicates the array data (for ripple line) of $1 + \text{Num} (\text{number of limit lines}) * 4$. Where n is an integer between 1 and Num.

- Data(0) :The number of limit lines you want to set. Specify an integer ranging 0 to 12. When the number of limit lines is set to 0 (clears the limit table), the variable Data is only required with Data(0).
- Data(nx4-3) :The type of the n-th line.

Specify an integer 0 to 1 as follows.

0: OFF

1: ON

- Data(nx4-2) :The value on the horizontal axis (frequency/power/time) of the start point of the n-th line.
- Data(nx4-1) :The value on the horizontal axis (frequency/power/time) of the end point of the n-th line.
- Data(nx4) :The ripple line value (dB) of the n-th line.

The index of the array starts from 0.

Examples

```
CALC:MEAS:RLIM:DATA  
calculate2:measure2:rlimit:data
```

Query CALCulate<cnum>:MEASure<mnum>:RLIMit:DATA?

Syntax

Return Variant type Array

Type

Default OFF

CALCulate<cnum>:MEASure<mnum>:RLIMit:DISPlay:LINE:STATe <bool>

Applicable Models: All

(Read-Write) Turns ON/OFF the ripple limit line display, for the active trace of selected channel.

Parameters

- <cnun> Channel number of the measurement. There must be a selected measurement on that channel. If unspecified, <cnun> is set to 1.
- <mnum> Measurement number for each measurement. There must be a selected measurement on the trace. If unspecified, <mnum> is set to 1.
- <bool> ON or 1 - Turns limit testing ON.
OFF or 0 - Turns limit testing OFF.

Examples

```
CALC:MEAS:RLIM:DISP:LINE:STAT ON  
calculate2:measure2:rlimit:display:line:state off
```

Query CALCulate<cnun>:MEASure<mnum>:RLIMit:DISPLay:LINE:STATe?

Syntax

Return Boolean

Type

Default OFF

CALCulate<cnun>:MEASure<mnum>:RLIMit:DISPLay:SElect <band>

Applicable Models: All

(Read-Write) Sets or gets the ripple limit band for ripple value display for selected channel.

Parameters

- <cnun> Channel number of the measurement. There must be a selected measurement on that channel. If unspecified, <cnun> is set to 1.
- <mnum> Measurement number for each measurement. There must be a selected measurement on the trace. If unspecified, <mnum> is set to 1.
- <band> 1 to 12

Examples

```
CALC:MEAS:RLIM:DISP:RIPP:SEL  
calculate2:measure2:rlimit:display:ripple:select
```

Query CALCulate<cnun>:MEASure<mnum>:RLIMit:DISPLay:SElect?

Syntax

Return Numeric

Type

Default 1

CALCulate<cnun>:MEASure<mnum>:RLIMit:DISPLay:TYPE <typ>

Applicable Models: All

(Read-Write) Sets/gets the display type of ripple value for the active trace of selected channel.

Parameters

- <cnun> Channel number of the measurement. There must be a selected measurement on that channel. If unspecified, <cnun> is set to 1.
- <mnum> Measurement number for each measurement. There must be a selected measurement on the trace. If unspecified, <mnum> is set to 1.
- <typ> Select from the following:
- "OFF": Specifies the display OFF.
 - "ABSolute": Specifies the absolute value for display type.
 - "MARgin": Specifies the margin for display type.

Examples

```
CALC:MEAS:RLIM:DISP:TYPE  
calculate2:measure2:rlimit:display:type
```

Query Syntax CALCulate<cnun>:MEASure<mnum>:RLIMit:DISPLay:TYPE?

Return Type Boolean

Default OFF

CALCulate<cnun>:MEASure<mnum>:RLIMit:FAIL

Applicable Models: All

(Read-only) Read the ripple test result for the active trace.

Parameters

- <cnun> Channel number of the measurement. There must be a selected measurement on that channel. If unspecified, <cnun> is set to 1.
- <mnum> Measurement number for each measurement. There must be a selected measurement on the trace. If unspecified, <mnum> is set to 1.
- <bool> Boolean
- 0 is returned when Pass
 - 1 is returned when Fail

Examples

```
CALC:MEAS:RLIM:FAIL?  
calculate2:measure2:rlimit:FAIL?
```

Query Syntax CALCulate<cnun>:MEASure<mnum>:RLIMit:FAIL?

Return Type Boolean
Default Not Applicable

CALCulate<cnum>:MEASure<mnum>:RLIMit:REPort:DATA

Applicable Models: All

(Read-only) Reads the ripple value of the ripple test for the active trace.

Parameters

- <cnum> Channel number of the measurement. There must be a selected measurement on that channel. If unspecified, <cnum> is set to 1.
- <mnum> Measurement number for each measurement. There must be a selected measurement on the trace. If unspecified, <mnum> is set to 1.
- <data> {numeric 1} ... {numeric NOP×3+1}<newline><^END>

NOP is the number of measurement points.

- {numeric 1}: Number of ripple limit line
- {numeric n×3-1} : Number of ripple limit bands.
- {numeric n×3} : Ripple value.
- {numeric n×3+1} : Ripple test result (1: Fail, 0: Pass)

Examples

```
CALC:MEAS:RLIM:REP:DATA?
```

```
calculate2:measure2:rlimit:report:data?
```

Query CALCulate<cnum>:MEASure<mnum>:RLIMit:REPort:DATA?

Syntax

Return Type Variant

Default

OFF

CALCulate<cnum>:MEASure<mnum>:RLIMit:STATe <bool>

Applicable Models: All

(Read-Write) Turns ON/OFF the ripple test function for the active trace of selected channel.

Parameters

- <cnm> Channel number of the measurement. There must be a selected measurement on that channel. If unspecified, <cnm> is set to 1.
- <mnm> Measurement number for each measurement. There must be a selected measurement on the trace. If unspecified, <mnm> is set to 1.
- <bool> ON (or 1) - turns limit testing ON.
OFF (or 0) - turns limit testing OFF.

Examples

```
CALC:MEAS:RLIM:STAT ON  
calculate2:measure2:rlimit:state off
```

Query Syntax CALCulate<cnm>:MEASure<mnm>:RLIMit:STATe?

Return Type Boolean

Default OFF

CALCulate:MEASure:SA Commands

Controls the marker settings used in the SA application.

CALCulate:MEASure:SA:MARKer:

BDENsity

| **BW**

| **DATA?**

| **EQSPan**

| **NOISe**

| **[:STATe]**

| **POWer**

| **BW**

| **[:STATe]**

| **TONE**

| **BW**

| **[:STATe]**

| **TSPacing**

BPOWer

| **DATA?**

| **SPAN**

| **[:STATe]**

OCCBand

| **CENTER?**

| **PERCent**

| **POWer?**

| **SPAN?**

| **[[:STATe]**

Click on a keyword to view the command details.

See Also

- Marker Readout **number** and **size** commands.
- [Learn about Markers](#)
- [Synchronizing the Analyzer and Controller](#)
- [SCPI Command Tree](#)

Important: Learn about [programming the reference marker](#).

CALCulate<ch>:MEASure<mnum>:SA:MARKer<n>:BDENsity:BW <num>

Applicable Models: All with Spectrum Analysis Options (S9x09xxA/B, S9x090A/B)

(Read-Write) Sets and reads the bandwidth of the band density marker.

Parameters

- <ch> Channel number of the measurement. There must be a selected measurement on that channel. If unspecified, <ch> is set to 1.
- <mnum> Measurement number for each measurement. There must be a selected measurement on the trace. If unspecified, <mnum> is set to 1.
- <n> Marker number. If unspecified, <n> is set to 1.
- <num> Choose a bandwidth.

Examples

```
CALC:MEAS2:SA:MARK:BDEN:BW 1e6
```

Query Syntax CALCulate<ch>:MEASure<mnum>:SA:MARKer<n>:BDENsity:BW?

Return Type Numeric

Default 1 MHz

CALCulate<ch>:MEASure<mnum>:SA:MARKer<n>:BDENsity:DATA?

Applicable Models: All with Spectrum Analysis Options (S9x09xxA/B, S9x090A/B)

(Read-only) Returns the band density level in dBm/Hz from the band density marker.

Parameters

- <ch> Channel number of the measurement. There must be a selected measurement on that SA channel. If unspecified, <ch> is set to 1.
- <mnum> Measurement number for each measurement. There must be a selected measurement on the trace. If unspecified, <mnum> is set to 1.
- <n> Band density marker number. If unspecified, <n> is set to 1.

Examples

```
CALC:MEAS2:SA:MARK:BDEN:DATA?  
calculate2:measure2:sa:marker2:bdensity:data?
```

Return Type Numeric

Default Not applicable

CALCulate<ch>:MEASure<mnum>:SA:MARKer<n>:BDENsity:EQSPan <num>

Applicable Models: All with Spectrum Analysis Options (S9x09xxA/B, S9x090A/B)

(Read-Write) Sets and reads the frequency span used by Power Density to normalize the power.

Parameters

- <ch> Channel number of the measurement. There must be a selected measurement on that channel. If unspecified, <ch> is set to 1.
- <mnum> Measurement number for each measurement. There must be a selected measurement on the trace. If unspecified, <mnum> is set to 1.
- <n> Marker number. If unspecified, <n> is set to 1.
- <num> Choose a span.

Examples

```
CALC:MEAS:SA:MARK:BDEN:EQSPan 1e6
```

Query Syntax CALCulate<ch>:MEASure<mnum>:SA:MARKer<n>:BDENsity:EQSPan?

Return Type Numeric

Default 1 MHz

CALCulate<ch>:MEASure<mnum>:SA:MARKer<n>:BDENsity:NOISe[:STATe] <bool>

Applicable Models: All with Spectrum Analysis Options (S9x09xxA/B, S9x090A/B)

(Read-Write) Sets and reads the state of the band density noise marker.

Parameters

- <ch> Channel number of the measurement. There must be a selected measurement on that channel. If unspecified, <ch> is set to 1.
- <mnum> Measurement number for each measurement. There must be a selected measurement on the trace. If unspecified, <mnum> is set to 1.
- <n> Marker number. If unspecified, <n> is set to 1.
- <bool> Choose from:
 - 0 - OFF** - Turn band density noise marker OFF.
 - 1 - ON** - Turn band density noise marker ON.

Examples

```
'Select the measurement
CALC2:PAR:SEL "M2SA_CH2_A"

'Create marker3 on that measurement
CALC2:MARK3 ON

'Make it a band density noise marker
CALC:MEAS:SA:MARK:BDEN:NOIS:STAT 1
```

Query Syntax CALCulate<ch>:MEASure<mnum>:SA:MARKer<n>:BDENsity:NOISe?

Return Type Boolean

Default 0

CALCulate<ch>:MEASure<mnum>:SA:MARKer<n>:BDENsity:POWER[:STATe] <bool>

Applicable Models: All with Spectrum Analysis Options (S9x09xxA/B, S9x090A/B)

(Read-Write) Sets and reads the state of the band power density marker.

Parameters

- <ch> Channel number of the measurement. There must be a selected measurement on that channel. If unspecified, <ch> is set to 1.
- <mnum> Measurement number for each measurement. There must be a selected measurement on the trace. If unspecified, <mnum> is set to 1.
- <n> Marker number. If unspecified, <n> is set to 1.
- <bool> Choose from:
 - 0 - OFF** - Turn band power density marker OFF.
 - 1 - ON** - Turn band power density marker ON.

Examples

```
'Select the measurement
CALC2:PAR:SEL "M2SA_CH2_A"

'Create marker3 on that measurement
CALC2:MARK3 ON

'Make it a band density noise marker
CALC:MEAS:SA:MARK:BDEN:POW:STAT 1
```

Query Syntax CALCulate<ch>:MEASure<mnum>:SA:MARKer<n>:BDENsity:POWer?

Return Type Boolean

Default 0

CALCulate<ch>:MEASure<mnum>:SA:MARKer<n>:BDENsity:POWer:BW <num>

Applicable Models: All with Spectrum Analysis Options (S9x09xxA/B, S9x090A/B)

(Read-Write) Sets and reads the bandwidth of the band power density marker.

Parameters

- <ch> Channel number of the measurement. There must be a selected measurement on that channel. If unspecified, <ch> is set to 1.
- <mnum> Measurement number for each measurement. There must be a selected measurement on the trace. If unspecified, <mnum> is set to 1.
- <n> Marker number. If unspecified, <n> is set to 1.
- <num> Choose a bandwidth.

Examples

```
CALC:MEAS:SA:MARK:BDEN:POW:BW 1e6
```

Query Syntax CALCulate<ch>:MEASure<mnum>:SA:MARKer<n>:BDENsity:POWer:BW?

Return Type Numeric

Default 1 MHz

CALCulate<ch>:MEASure<mnum>:SA:MARKer<n>:BDENsity:TONE:BW <num>

Applicable Models: All with Spectrum Analysis Options (S9x09xxA/B, S9x090A/B)

(Read-Write) Sets and reads the bandwidth of the band tone density marker.

Parameters

- <ch> Channel number of the measurement. There must be a selected measurement on that channel. If unspecified, <ch> is set to 1.
- <mnum> Measurement number for each measurement. There must be a selected measurement on the trace. If unspecified, <mnum> is set to 1.
- <n> Marker number. If unspecified, <n> is set to 1.
- <num> Choose a bandwidth.

Examples

```
CALC:MEAS:SA:MARK:BDEN:TONE:BW 1e6
```

Query Syntax CALCulate<ch>:MEASure<mnum>:SA:MARKer<n>:BDENsity:TONE:BW?

Return Type Numeric

Default 1 MHz

CALCulate<ch>:MEASure<mnum>:SA:MARKer<n>:BDENsity:TONE[:STATe] <bool>

Applicable Models: All with Spectrum Analysis Options (S9x09xxA/B, S9x090A/B)

(Read-Write) Sets and reads the state of the band tone density marker.

Parameters

- <ch> Channel number of the measurement. There must be a selected measurement on that channel. If unspecified, <ch> is set to 1.
- <mnum> Measurement number for each measurement. There must be a selected measurement on the trace. If unspecified, <mnum> is set to 1.
- <n> Marker number. If unspecified, <n> is set to 1.
- <bool> Choose from:
 - 0 - OFF** - Turn band tone density marker OFF.
 - 1 - ON** - Turn band tone density marker ON.

Examples

```
'Select the measurement
CALC2:PAR:SEL "M2SA_CH2_A"

'Create marker3 on that measurement
CALC2:MARK3 ON

'Make it a band density noise marker
CALC:MEAS:SA:MARK:BDEN:TONE:STAT 1
```

Query Syntax CALCulate<ch>:MEASure<mnum>:SA:MARKer<n>:BDENsity:TONE?

Return Type Boolean

Default 0

CALCulate<ch>:MEASure<mnum>:SA:MARKer<n>:BDENsity:TONE:TSPacing <num>

Applicable Models: All with Spectrum Analysis Options (S9x09xxA/B, S9x090A/B)

(Read-Write) Sets and reads the spacing of the band tone density marker.

Parameters

- <ch> Channel number of the measurement. There must be a selected measurement on that channel. If unspecified, <ch> is set to 1.
- <mnum> Measurement number for each measurement. There must be a selected measurement on the trace. If unspecified, <mnum> is set to 1.
- <n> Marker number. If unspecified, <n> is set to 1.
- <num> Choose a spacing value.

Examples

```
CALC:MEAS:SA:MARK:BDEN:TONE:TSP 100e6
```

Query Syntax CALCulate<ch>:MEASure<mnum>:SA:MARKer<n>:BDENsity:TONE:TSPacing?

Return Type Numeric

Default 100 MHz

CALCulate<ch>:MEASure<mnum>:SA:MARKer<n>:BPOWER:DATA?

Applicable Models: All with Spectrum Analysis Options (S9x09xxA/B, S9x090A/B)

(Read-only) Returns the band power level from the band power marker.

Parameters

- <ch> Channel number of the measurement. There must be a selected measurement on that channel. If unspecified, <ch> is set to 1.
- <mnum> Measurement number for each measurement. There must be a selected measurement on the trace. If unspecified, <mnum> is set to 1.
- <n> Band power marker number.

Examples

```
CALC:MEAS2:SA:MARK:BPOW:DATA?
```

```
calculate2:measure2:sa:marker2:bpower:data?
```

Default Not applicable

CALCulate<ch>:MEASure<mnum>:SA:MARKer<n>:BPOWER:SPAN <num>

Applicable Models: All with Spectrum Analysis Options (S9x09xxA/B, S9x090A/B)

(Read-Write) Sets and reads the frequency span of the band power marker. This area is marked by two vertical dotted lines on the screen and the marker's y-axis value is set to the measured power value. Noise and power on the same marker share the same span.

Parameters

- <ch> Channel number of the measurement. There must be a selected measurement on that channel. If unspecified, <ch> is set to 1.
- <mnum> Measurement number for each measurement. There must be a selected measurement on the trace. If unspecified, <mnum> is set to 1.
- <n> Marker number.
- <num> Choose a frequency span within the frequency range of the analyzer.

Examples

```
CALC:MEAS2:SA:MARK:BPOW:SPAN 1e6
```

Query Syntax CALCulate<ch>:MEASure<mnum>:SA:MARKer<n>:BPOWER:SPAN?

Return Type Numeric

Default 1 MHz

CALCulate<ch>:MEASure<mnum>:SA:MARKer<n>:BPOWER[:STATe] <bool>

Applicable Models: All with Spectrum Analysis Options (S9x09xxA/B, S9x090A/B)

(Read-Write) Sets and reads the state of the band power marker. This command makes a band power marker from a generic marker. The generic marker must first be created using:

CALC:MEAS:MARK:STATe

Parameters

- <ch> Channel number of the measurement. There must be a selected measurement on that channel. If unspecified, <ch> is set to 1.
- <mnum> Measurement number for each measurement. There must be a selected measurement on the trace. If unspecified, <mnum> is set to 1.
- <n> Marker number.
- <bool> Choose from:

0 - OFF - Turn band power marker OFF.

1 - ON - Turn band power marker ON.

Examples

```
'Create marker3 on the specified measurement
```

```
CALC2:MEAS2:MARK3 ON
```

```
'Make it a band power marker
```

```
CALC:MEAS2:SA:MARK:BPOW:STAT 1
```

Query Syntax CALCulate<ch>:MEASure<mnum>:SA:MARKer<n>:BPOWER?

Return Type Boolean

Default 0

CALCulate<ch>:MEASure<mnum>:SA:MARKer<n>:OCCBand:CENTer?

Applicable Models: All with Spectrum Analysis Options (S9x09xxA/B, S9x090A/B)

(Read-only) Returns the occupied bandwidth center frequency.

Parameters

- <ch> Channel number of the measurement. There must be a selected measurement on that SA channel. If unspecified, <ch> is set to 1.
- <mnum> Measurement number for each measurement. There must be a selected measurement on the trace. If unspecified, <mnum> is set to 1.
- <n> Marker number.

Examples

```
CALC:SA:MARK:OCCB:CENT?
```

```
calculate2:sa:marker2:occband:center?
```

Default Not applicable

CALCulate<ch>:MEASure<mnum>:SA:MARKer<n>:OCCBand:PERCent <num>

Applicable Models: All with Spectrum Analysis Options (S9x09xxA/B, S9x090A/B)

(Read-Write) Sets and returns the percentage of the band power to search for.

Parameters

- <ch> Channel number of the measurement. There must be a selected measurement on that channel. If unspecified, <ch> is set to 1.
- <mnum> Measurement number for each measurement. There must be a selected measurement on the trace. If unspecified, <mnum> is set to 1.
- <n> Marker number.
- <num> Percentage value.

Examples

```
CALC:SA:MARK:OCCB:PERC 99  
calculate2:sa:marker2:occband:percent 99
```

Query Syntax CALCulate<ch>:SA:MARKer<n>:OCCBand:PERCent?

Return Type Numeric

Default 99.0

CALCulate<ch>:MEASure<mnum>:SA:MARKer<n>:OCCBand:POWER?

Applicable Models: All with Spectrum Analysis Options (S9x09xxA/B, S9x090A/B)

(Read-only) Returns the occupied bandwidth power.

Parameters

- <ch> Channel number of the measurement. There must be a selected measurement on that SA channel. If unspecified, <ch> is set to 1.
- <mnum> Measurement number for each measurement. There must be a selected measurement on the trace. If unspecified, <mnum> is set to 1.
- <n> Marker number.

Examples

```
CALC:SA:MARK:OCCB:POW?  
calculate2:sa:marker2:occband:power?
```

Default Not applicable

CALCulate<ch>:MEASure<mnum>:SA:MARKer<n>:OCCBand:SPAN?

Applicable Models: All with Spectrum Analysis Options (S9x09xxA/B, S9x090A/B)

(Read-only) Returns the occupied bandwidth span.

Parameters

- <ch> Channel number of the measurement. There must be a selected measurement on that SA channel. If unspecified, <ch> is set to 1.
- <mnum> Measurement number for each measurement. There must be a selected measurement on the trace. If unspecified, <mnum> is set to 1.
- <n> Marker number.

Examples

```
CALC:SA:MARK:OCCB:SPAN?  
calculate2:sa:marker2:occband:span?
```

Default Not applicable

CALCulate<ch>:MEASure<mnum>:SA:MARKer<n>:OCCBand[:STATe] <bool>

Applicable Models: All with Spectrum Analysis Options (S9x09xxA/B, S9x090A/B)

(Read-Write) Sets and returns the occupied bandwidth on/off state.

Parameters

- <ch> Channel number of the measurement. There must be a selected measurement on that channel. If unspecified, <ch> is set to 1.
- <mnum> Measurement number for each measurement. There must be a selected measurement on the trace. If unspecified, <mnum> is set to 1.
- <n> Marker number.
- <bool> Choose from:

0 - OFF - Turns occupied bandwidth OFF.

1 - ON - Turns occupied bandwidth ON.

Examples

```
CALC:SA:MARK:OCCB:STAT 1  
calculate2:sa:marker2:occband:state 1
```

Query Syntax CALCulate<ch>:SA:MARKer<n>:OCCBand[:STATe]?

Return Type Boolean

Default 0

Note: If occupied band state is turned ON, then Band Power or Band Noise is turned OFF.

CALCulate:MEASure:SMOothing Commands

Controls point-to-point smoothing. Smoothing is a noise reduction technique that averages adjacent data points in a measurement trace. Choose the amount of smoothing by specifying either the number of points or the aperture. Smoothing is not the same as CALC:AVERage which averages each data point over a number of sweeps.

```
CALCulate:MEASure:SMOothing
  APERture
  POINts
  [:STATe]
```

Click a [keyword](#) to view the command details.

See Also

- [Learn about Smoothing](#)
- [Synchronizing the Analyzer and Controller](#)
- [SCPI Command Tree](#)

CALCulate<cnum>:MEASure<mnum>:SMOothing:APERture <num>

Applicable Models: All

(Read-Write) Sets the amount of smoothing as a percentage of the number of data points in the channel.

Parameters

- <cnum> Channel number of the measurement. There must be a selected measurement on that channel. If unspecified, <cnum> is set to 1.
- <mnum> Measurement number for each measurement. There must be a selected measurement on the trace. If unspecified, <mnum> is set to 1.
- <num> Percentage value. Choose any number between: 1 and 25

Examples

```
CALC:MEAS:SMO:APER 2
calculate2:measure2:smoothing:aperture 20.7
```

Query Syntax

CALCulate<cnum>:MEASure<mnum>:SMOothing:APERture?

Return Type

Numeric

CALCulate<cnum>:MEASure<mnum>:SMOothing:POINts <num>**Applicable Models:** All**(Read-Write)** Sets the number of adjacent data points to average.**Parameters**

- <cnum> Channel number of the measurement. There must be a selected measurement on that channel. If unspecified, <cnum> is set to 1.
- <mnum> Measurement number for each measurement. There must be a selected measurement on the trace. If unspecified, <mnum> is set to 1.
- <num> Number of points from 1 point to maximum of 25% of data points in the channel. For example: if number of points in a data trace = 401, the maximum value for points = 100. The points value is always rounded to the closest odd number.

Examples

```
CALC:MEAS:SMO:POIN 50
calculate2:measure2:smoothing:points 21
```

Query Syntax

CALCulate<cnum>:MEASure<mnum>:SMOothing:POINts?

Return Type

Numeric

Default

3

CALCulate<cnum>:MEASure<mnum>:SMOothing[:STATe] <bool>**Applicable Models:** All**(Read-Write)** Turns data smoothing ON or OFF.**Parameters**

- <cnum> Channel number of the measurement. There must be a selected measurement on that channel. If unspecified, <cnum> is set to 1.
- <mnum> Measurement number for each measurement. There must be a selected measurement on the trace. If unspecified, <mnum> is set to 1.
- <bool> ON or 1 - Turns smoothing ON.
OFF or 0 - Turns smoothing OFF.

Examples

```
CALC:MEAS:SMO ON
calculate2:measure2:smoothing:state off
```

Query Syntax

CALCulate<cnum>:MEASure<mnum>:SMOothing[:STATe]

Return Type

Boolean (1 = ON, 0 = OFF)

Default OFF

CALCulate:MEASure:TRANSform Commands

Specifies the settings for time domain transform.

CALCulate:MEASure:TRANSform
COUPle
PARameters
TIME
ALIGnment
CENTer
IMPulse
WIDTHh
KBESsel
LPFRequency
MARKer
MODE
UNIT
SPAN
START
STATe
STEP
RTIME
STOP
[:TYPE]

Click a [keyword](#) to view the command details.

See Also

- [Learn about Time Domain](#)
- [Synchronizing the Analyzer and Controller](#)
- [SCPI Command Tree](#)

CALCulate<cnum>:MEASure<mnum>:TRANSform:COUPle:PARAmeters <num>

Applicable Models: All

(Read-Write) Specifies the time domain transform parameters to be coupled. The settings for those parameters will be copied from the selected measurement to all other measurements on the channel.

- To turn coupling ON and OFF, use **SENS:COUP:PAR**
- To specify Gating parameters to couple, use **CALC:MEAS:FILT:COUP:PAR**

Learn more about [Time Domain Trace Coupling](#)

Parameters

- <cnum> Channel number of the measurement. There must be a selected measurement on that channel. If unspecified, <cnum> is set to 1.
- <mnum> Measurement number for each measurement. There must be a selected measurement on the trace. If unspecified, <mnum> is set to 1.
- <num> (Numeric) Parameters to couple. To specify more than one parameter, add the numbers.
- 1 - Transform Stimulus (Start, Stop, Center, and Span TIME settings.)
 - 2 - Transform State (ON / OFF)
 - 4 - Transform Window (Kaiser Beta / Impulse Width)
 - 8 - Transform Mode (Low Pass Impulse, Low Pass Step, Band Pass)
 - 16 - Transform Distance Marker Units

Examples

```
'To couple all parameters:  
CALC:MEAS:TRAN:COUP:PAR 31  
  
'To couple Stimulus and Mode:  
calculate2:measure2:transform:couple:parameters 9
```

Query Syntax CALCulate<cnum>:MEASure<mnum>:TRANSform:COUPle:PARAmeters?

Return Type Numeric

Default 29 (All parameters except 2 - Transform State)

CALCulate<cnum>:MEASure<mnum>:TRANSform:TIME:ALIGNment <enum>

Applicable Models: All

(Read-Write) Sets the way the PNA computes the DC value of the frequency-domain measurement. The correct DC value is required for inverse-FFT accuracy, and if not estimated properly, can cause distortions in the time-domain measurement in the form of an undesired slope in the waveform.

Parameters

- <cnum> Channel number of the measurements to be listed. If unspecified, <cnum> is set to 1.
- <mnum> Measurement number for each measurement. There must be a selected measurement on the trace. If unspecified, <mnum> is set to 1.
- <enum> Choose from:

LEGacy - The DC value is extrapolated using three data points. The transform offset is calculated using the delay of the first frequency point. This is the same algorithm used in the HP 8510 network analyzer.

NORMalize - The DC value is extrapolated using three data points. The transform offset is set to zero at t=0 minus six rise-times. This mode requires that a good S-parameter calibration has been performed, which can be verified by observing a flat time-domain response at t=0 when measuring a load located at the physical point corresponding to t=0. Normalize mode is principally used to help stabilize the time-domain trace at time t=0 to 50 ohms, to remove bouncing of the response at t=0. This method is similar to that used with PLTS, and is very useful in determining the time-domain-transform response of transmission lines and printed-circuit-board characteristics.

Examples

```
CALC:MEAS:TRAN:TIME:ALIG NORM  
calculate2:measure2:transform:time:alignment?
```

Return Type Enumeration

Default LEGacy

CALCulate<cnum>:MEASure<mnum>:TRANSform:TIME:CENTer <num>

Applicable Models: All

(Read-Write) Sets the center time for time domain measurements.

Parameters

- <cnm> Channel number of the measurement. There must be a selected measurement on that channel. If unspecified, <cnm> is set to 1.
- <mnm> Measurement number for each measurement. There must be a selected measurement on the trace. If unspecified, <mnm> is set to 1.
- <num> Center time in seconds; any number between:
 $\pm (\text{number of points}-1) / \text{frequency span}$

Note: This command will accept MIN or MAX instead of a numeric parameter. See [SCPI Syntax](#) for more information.

Examples

```
CALC:MEAS:TRAN:TIME:CENT 1e-8  
calculate2:measure2:transform:time:center 15 ps
```

Query
Syntax

CALCulate<cnm>:MEASure<mnm>:TRANSform:TIME:CENTer?

Return
Type

Numeric

Default 0

CALCulate<cnm>:MEASure<mnm>:TRANSform:TIME:IMPulse:WIDTh <num>

Applicable Models: All

(Read-Write) Sets the impulse width for the transform window.

Parameters

- <cnm> Channel number of the measurement. There must be a selected measurement on that channel. If unspecified, <cnm> is set to 1.
- <mnm> Measurement number for each measurement. There must be a selected measurement on the trace. If unspecified, <mnm> is set to 1.
- <num> Impulse width in seconds; Choose any number between:
 $.6 / \text{frequency span}$ and $1.39 / \text{frequency span}$

Examples

```
CALC:MEAS:TRAN:TIME:IMP:WIDTh 10  
calculate2:measure2:transform:time:impulse:width 13
```

Query
Syntax

CALCulate<cnm>:MEASure<mnm>:TRANSform:TIME:IMPulse:WIDTh?

Return
Type

Numeric

Default .98 / Default Span

CALCulate<cnum>:MEASure<mnum>:TRANSform:TIME:KBESsel <num>

Applicable Models: All

(Read-Write) Sets the parametric window for the Kaiser Bessel window.

Parameters

- <cnum> Channel number of the measurement. There must be a selected measurement on that channel. If unspecified, <cnum> is set to 1.
- <mnum> Measurement number for each measurement. There must be a selected measurement on the trace. If unspecified, <mnum> is set to 1.
- <num> Window width for Kaiser Bessel in seconds; Choose any number between: 0.0 and 13.0

Examples

```
CALC:MEAS:TRAN:TIME:KBES 10  
calculate2:measure2:transform:time:kbessel 13
```

Query Syntax
CALCulate<cnum>:MEASure<mnum>:TRANSform:TIME:KBESsel?
Return Type
Numeric
Default 6

CALCulate<cnum>:MEASure<mnum>:TRANSform:TIME:LPFREQuency

Applicable Models: All

(Write-only) Sets the start frequencies in LowPass Mode.

Parameters

- <cnum> Channel number of the measurement. There must be a selected measurement on that channel. If unspecified, <cnum> is set to 1.
- <mnum> Measurement number for each measurement. There must be a selected measurement on the trace. If unspecified, <mnum> is set to 1.

Examples

```
CALC:MEAS:TRAN:TIME:LPFR  
calculate2:measure2:transform:time:lpfrequency
```

Query Syntax
Not Applicable
Default Not Applicable

CALCulate<cnum>:MEASure<mnum>:TRANSform:TIME:MARKer:MODE <char>

Applicable Models: All

(Read-Write) Specifies the measurement type in order to determine the correct marker distance.

- Select Auto for S-Parameter measurements.
- Select Reflection or Transmission for arbitrary ratio or unratiod measurements.

This setting affects the display of ALL markers for only the ACTIVE measurement.

Learn more about [Distance Markers](#).

Parameters

<cnum> Channel number of the measurement. There must be a selected measurement on that channel. If unspecified, <cnum> is set to 1.

<mnum> Measurement number for each measurement. There must be a selected measurement on the trace. If unspecified, <mnum> is set to 1.

<char> Choose from:

AUTO - If the active measurement is an S-Parameter, automatically chooses reflection or transmission. If non S-Parameter measurements, reflection is chosen.

REFlection - Displays the distance from the source to the receiver divided by two (to compensate for the return trip.)

TRANsmission - Displays the distance from the source to the receiver.

Examples

```
CALC:MEAS:TRAN:TIME:MARK:MODE REFL  
calculate2:measure2:transform:time:marker:mode auto
```

Query
Syntax

CALCulate<cnum>:MEASure<mnum>:TRANSform:TIME:MARKer:MODE?

Return
Type

Character

Default

AUTO

CALCulate<cnum>:MEASure<mnum>:TRANSform:TIME:MARKer:UNIT <char>

Applicable Models: All

(Read-Write) Specifies the unit of measure for the display of marker distance values. This settings affects the display of ALL markers for only the ACTIVE measurement (unless Distance Maker Units are coupled using `CALC:MEAS:TRAN:COUP:PAR`).

Learn more about [Distance Markers](#).

Parameters

- <cnum> Channel number of the measurement. There must be a selected measurement on that channel. If unspecified, <cnum> is set to 1.
- <mnum> Measurement number for each measurement. There must be a selected measurement on the trace. If unspecified, <mnum> is set to 1.
- <char> Choose from:

METRs

FEET

INCHes

Examples

```
CALC:MEAS:TRAN:TIME:MARK:UNIT INCH  
calculate2:measure2:transform:time:marker:unit feet
```

Query Syntax	CALCulate<cnum>:MEASure<mnum>:TRANSform:TIME:MARKer:UNIT?
Return Type	Character
Default	METRs

CALCulate<cnum>:MEASure<mnum>:TRANSform:TIME:SPAN <num>

Applicable Models: All

(Read-Write) Sets the span time for time domain measurements.

Parameters

- <cnm> Channel number of the measurement. There must be a selected measurement on that channel. If unspecified, <cnm> is set to 1.
- <mnm> Measurement number for each measurement. There must be a selected measurement on the trace. If unspecified, <mnm> is set to 1.
- <num> Span time in seconds; any number between:
0 and $2 * [(number\ of\ points - 1) / frequency\ span]$

Note: This command will accept MIN or MAX instead of a numeric parameter. See [SCPI Syntax](#) for more information.

Examples

```
CALC:MEAS:TRAN:TIME:SPAN 1e-8
calculate2:measure2:transform:time:span maximum
```

Query Syntax

CALCulate<cnm>:MEASure<mnm>:TRANSform:TIME:SPAN?

Return Type

Numeric

Default 20 ns

CALCulate<cnm>:MEASure<mnm>:TRANSform:TIME:STARt <num>

Applicable Models: All

(Read-Write) Sets the start time for time domain measurements.

Parameters

- <cnm> Channel number of the measurement. There must be a selected measurement on that channel. If unspecified, <cnm> is set to 1.
- <mnm> Measurement number for each measurement. There must be a selected measurement on the trace. If unspecified, <mnm> is set to 1.
- <num> Start time in seconds; any number between:
 $\pm (number\ of\ points - 1) / frequency\ span$

Note: This command will accept MIN or MAX instead of a numeric parameter. See [SCPI Syntax](#) for more information.

Examples

```
CALC:MEAS:TRAN:TIME:STAR 1e-8
calculate2:measure2:transform:time:start minimum
```

Query Syntax

CALCulate<cnm>:MEASure<mnm>:TRANSform:TIME:STARt?

Return Type

Numeric

Default -10 ns

CALCulate<cnum>:MEASure<mnum>:TRANSform:TIME:STATe <bool>

Applicable Models: All

(Read-Write) Turns the time domain transform capability ON or OFF.

Note: **Sweep type** must be set to Linear Frequency in order to use Time Domain Transform.

Parameters

- <cnum> Channel number of the measurement. There must be a selected measurement on that channel. If unspecified, <cnum> is set to 1.
- <mnum> Measurement number for each measurement. There must be a selected measurement on the trace. If unspecified, <mnum> is set to 1.
- <bool> ON (or 1) - turns time domain ON.
OFF (or 0) - turns time domain OFF.

Examples

```
CALC:MEAS:TRAN:TIME:STAT ON  
calculate2:measure2:transform:time:state off
```

Query
Syntax

CALCulate<cnum>:MEASure<mnum>:TRANSform:TIME:STATe?

Return
Type

Boolean (1 = ON, 0 = OFF)

Default

OFF

CALCulate<cnum>:MEASure<mnum>:TRANSform:TIME:STEP:RTIME <num>

Applicable Models: All

(Read-Write) Sets the step rise time for the transform window.

Parameters

- <cnum> Channel number of the measurement. There must be a selected measurement on that channel. If unspecified, <cnum> is set to 1.
- <mnum> Measurement number for each measurement. There must be a selected measurement on the trace. If unspecified, <mnum> is set to 1.
- <num> Rise time in seconds; Choose any number between:
.45 / frequency span and 1.48 / frequency span

Examples

```
CALC:MEAS:TRAN:TIME:STEP:RTIM 1e-8  
calculate2:measure2:transform:time:step:rtime 15 ps
```

Query
Syntax

CALCulate<cnum>:MEASure<mnum>:TRANSform:TIME:STEP:RTIME?

Return Type Numeric
Default .99 / Default Span

CALCulate<cnum>:MEASure<mnum>:TRANSform:TIME:STOP <num>

Applicable Models: All

(Read-Write) Sets the stop time for time domain measurements.

Parameters

- <cnum> Channel number of the measurement. There must be a selected measurement on that channel. If unspecified, <cnum> is set to 1.
- <mnum> Measurement number for each measurement. There must be a selected measurement on the trace. If unspecified, <mnum> is set to 1.
- <num> Stop time in seconds; any number between:
 $\pm (\text{number of points}-1) / \text{frequency span}$

Note: This command will accept MIN or MAX instead of a numeric parameter. See [SCPI Syntax](#) for more information.

Examples

```
CALC:MEAS:TRAN:TIME:STOP 1e-8  
calculate2:measure2:transform:time:stop maximum
```

Query Syntax CALCulate<cnum>:MEASure<mnum>:TRANSform:TIME:STOP?
Return Type Numeric
Default 10 ns

CALCulate<cnum>:MEASure<mnum>:TRANSform:TIME[:TYPE] <char>

Applicable Models: All

(Read-Write) Sets the type of time domain measurement.

Parameters

- <cnm> Channel number of the measurement. There must be a selected measurement on that channel. If unspecified, <cnm> is set to 1.
- <mnm> Measurement number for each measurement. There must be a selected measurement on the trace. If unspecified, <mnm> is set to 1.
- <chr> Type of measurement. Choose from:
 - BPASs** - Set transform mode to band pass.
 - LPSTep** - Set transform mode to low pass step.
 - LPIMPulse** - Set transform mode to low pass impulse.

[Learn about these settings.](#)

Examples

```
CALC:MEAS:TRAN:TIME BPAS  
calculate2:measure2:transform:time:type bpas
```

- Query Syntax CALCulate<cnm>:MEASure<mnm>:TRANSform:TIME[:TYPE]?
 - Return Type Character
 - Default BPAS
-

CALCulate:MEASure:X Commands

Controls the display of X-axis for various measurements.

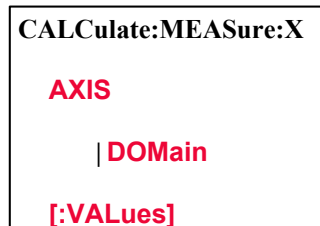

Click a [keyword](#) to view the command details.

See Also

- [Synchronizing the Analyzer and Controller](#)
- [SCPI Command Tree](#)

CALCulate<ch>:MEASure<mnum>:X:AXIS <string>

Applicable Models: All

(Write-Read) Sets the X-axis of the selected measurement to a DC Source. This command does not change the default setting for new traces.

Parameters

- <ch> Channel number of the selected measurement. There must be a selected measurement on that channel. If unspecified, value is set to 1.
- <mnum> Measurement number for each measurement. There must be a selected measurement on the trace. If unspecified, <mnum> is set to 1.
- <string> String - (Not case-sensitive) For all channels EXCEPT DIQ, choose from the following:
 - "Default" - The default X-axis setting for the selected measurement. For Application measurements, the X-Axis domain is set with specific commands.
 - "AO1" - Internal DC source #1
 - "AO2" - Internal DC source #2

Note: For DIQ channels, see [CALC:MEAS:X:AXIS:DOMain](#)

Examples `CALC:MEAS2:X:AXIS 'Default'`

`calculate:measure2:x:axis "AO1"`

Query Syntax `CALCulate<ch>:MEASure<mnum>:X:AXIS?`

Return Type String

Default "Default"

CALCulate<ch>:MEASure<mnum>:X:AXIS:DOMain <string>

Applicable Models: All

(Write-Read) Sets and returns the X-Axis domain of the selected DIQ measurement.

Parameters

<ch> The Differential IQ channel number. There must be a selected measurement on that channel. If unspecified, value is set to 1.

<mnum> Measurement number for each measurement. There must be a selected measurement on the trace. If unspecified, <mnum> is set to 1.

Choose one of these:	Then set X-Axis Source (CALC:MEAS:X:AXIS) using one of these as the argument.
"Frequency"	"F1", "F2", etc.
"Power"	Source port: "Port 1", "Port 2", etc.
"Phase"	Source port: "Port 1", "Port 2", etc.
"DC"	DC Source:"AO1", "AO2"
"Points"	"Points"

Example 1. `CALC:MEAS2:X:AXIS:DOM "Power"`

2. `CALC:MEAS2:X:AXIS "Port 1"`

Query Syntax `CALCulate<ch>:MEASure<mnum>:X:AXIS:DOMain?`

Return Type String

Default `CALC:MEAS:X:AXIS:DOMain: "Frequency"`

`CALC:MEAS:X:AXIS: "F1"`

CALCulate<cnum>:MEASure<mnum>:X[:VALues]?

Applicable Models: All

(Read-only) Returns the stimulus values for the selected measurement in the current units.

This command can be used for all Measurement Classes.

Note: To avoid frequency rounding errors, specify **FORM:DATA** <Real,64> or <ASCIi, 0>

Parameters

<cnum> Any existing channel number; There must be a selected measurement on that channel. if unspecified, value is set to 1.

<mnum> Measurement number for each measurement. There must be a selected measurement on the trace. If unspecified, <mnum> is set to 1.

Examples

```
1. Calc:MEAS2:Par:Sel "MyGCATrace"  
2. CALC:MEAS2:X?
```

Return Type Depends on **FORM:DATA** command

Default Not applicable

Calculate:Mixer Command

This command is **Superseded** by the `CALCulate:MEASure:MIXer:XAXis` command.

`CALCulate<ch>:MIXer:XAXis <char>`

Applicable Models: N522xB, N523xB, N524xB, M937xA, P937xA

(Read-Write) Sets or returns the swept parameter to display on the X-axis for the selected **FCA** and **GCX** measurement.

Critical Note: `CALCulate` commands act on the selected measurement. You can select one measurement for each channel using `Calc:Par:MNUM` or `Calc:Par:Select`. [Learn more.](#)

Parameters

- <ch> Any existing channel number. If unspecified, value is set to 1.
- <char> Parameter to display on the X-axis. Choose from:
 - INPUT** - Input frequency span
 - OUTPUT** - Output frequency span
 - LO_1** - First LO frequency span
 - LO_2** - Second LO frequency span

Examples

```
CALC:MIX:XAX INPUT  
calc2:mixer:xaxis output
```

See an example that creates, selects, and calibrates an **SMC** and **VMC** measurement using SCPI.

Query Syntax `CALCulate<ch>:MIXer:XAXis?`

Return Type Character

Default OUTPUT

Calculate:Normalize Commands

Specifies the normalization features used for a receiver power calibration.

These commands are Superseded (Sept 2004).

See the replacement commands in a new Receiver Power Cal example.

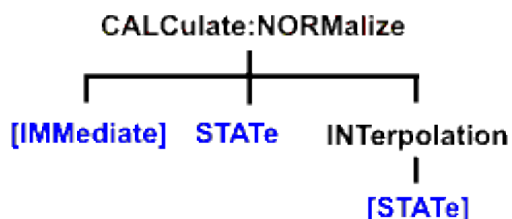

Click on a keyword to view the command details.

See Also

- [Example Programs](#)
- [Learn about Receiver Cal](#)
- [SCPI Command Tree](#)

Save and recall your receiver power calibration (which use .CST file commands):

- [SENS:CORR:CSET:SAVE](#)
- [SENS:CORR:CSET\[:SEL\]](#)

Or use these two commands and specify either .STA or .CST file extensions:

- [MMEM:LOAD](#)
- [MMEM:STOR](#)

Critical Note: CALCulate commands act on the selected measurement. You can select one measurement for each channel using [Calc:Par:Select](#)

CALCulate<cnum>:NORMalize[:IMMEDIATE] Superseded

Applicable Models: N522xB, N523xB, N524xB, M937xA, P937xA

Note: This command is replaced with **SENS:CORR:COLL:METH RPOWer** and **SENS:CORR:COLL[:ACQ] POWer**

See an example of a Receiver Power Calibration.

(Write only) Stores the selected measurement's data to that measurement's "divisor" buffer for use by the Normalization data processing algorithm. This command is not compatible with ratioed measurements such as S-parameters. It is intended for receiver power calibration when the selected measurement is of an unratioed power type.

See Critical Note

Parameters

<cnm> Channel number of the measurement. There must be a selected measurement on that channel. If unspecified, <cnm> is set to 1.

Examples

```
CALC:NORM  
calculate1:normalize:immediate
```

Query Syntax Not Applicable

Default Not Applicable

CALCulate<cnm>:NORMalize:STATe <ON | OFF> **Superseded**

Applicable Models: N522xB, N523xB, N524xB, M937xA, P937xA

Note: This command is replaced with **SENS:CORR[:STATe] ON/OFF**

(Read-Write) Specifies whether or not normalization is applied to the measurement. Normalization is enabled only for measurements of unratioed power where it serves as a receiver power calibration.

See Critical Note

Parameters

<cnm> Channel number of the measurement. There must be a selected measurement on that channel. If unspecified, <cnm> is set to 1.

<ON | OFF> **ON (or 1)** - normalization is applied to the measurement.

OFF (or 0) – normalization is NOT applied to the measurement.

Examples

```
CALC:NORM:STAT ON  
calculate2:normalize:state off
```

Query Syntax CALCulate<cnm>:NORMalize:STATe?

Return Type Boolean (1 = ON, 0 = OFF)

Default OFF

CALCulate<cnum>:NORMalize:INTerpolate[:STATe] <ON | OFF> **Superseded**

Applicable Models: N522xB, N523xB, N524xB, M937xA, P937xA

Note: This command is replaced with **SENS:CORR:INT[:STATe] ON|OFF**

(Read-Write) Turns normalization interpolation ON or OFF. Normalization is enabled only for measurements of unratiod power, where it serves as a receiver power calibration.

See Critical Note

Parameters

<cnum> Channel number of the measurement. There must be a selected measurement on that channel. If unspecified, <cnum> is set to 1.

<ON | OFF> **ON (or 1)** – turns interpolation ON.

OFF (or 0) – turns interpolation OFF.

Examples

```
CALC:NORM:INT ON  
calculate2:normalize:interpolate:state off
```

Query Syntax CALCulate<cnum>:NORMalize:INTerpolate[:STATe]?

Return Type Boolean (1 = ON, 0 = OFF)

Default ON

Calculate:Offset Commands

Allows the data trace magnitude and phase to be offset.

These commands are **Superseded** by the `CALCulate:MEASure:OFFSet` commands.

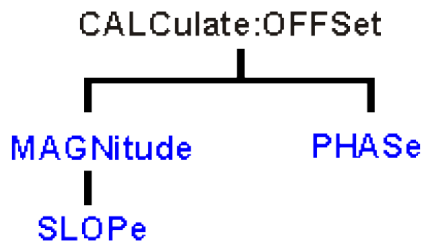

Click on a keyword to view the command details.

See Also

- [Example Programs](#)
- [Learn about Magnitude Offset](#)
- [Learn about Phase Offset](#)
- [Synchronizing the Analyzer and Controller](#)
- [SCPI Command Tree](#)

Critical Note: CALCulate commands act on the selected measurement. You can select one measurement for each channel using `Calc:Par:MNUM` or `Calc:Par>Select`. [Learn more](#).

`CALCulate<cnum>:OFFSet:MAGNitude <num>`

Applicable Models: All

(Read-Write) Offsets the data trace magnitude by the specified value.

To offset the data trace magnitude to a slope value that changes with frequency, use

CALC:OFFS:MAGN:SLOP

See Critical Note

Parameters

<num> Channel number of the measurement. There must be a selected measurement on that channel. If unspecified, <num> is set to 1.

<num> Offset value in dB.

Examples

```
CALC:OFFS:MAGN:4  
calculat1:offset:magnitude -2
```

Query Syntax CALCulate<num>:OFFSet:MAGNitude?

Return Type Numeric

Default 0

CALCulate<num>:OFFSet:MAGNitude:SLOPe <num>

Applicable Models: All

(Read-Write) Offsets the data trace magnitude to a value that changes linearly with frequency. The offset slope begins at 0 Hz.

See Critical Note

Parameters

<num> Channel number of the measurement. There must be a selected measurement on that channel. If unspecified, <num> is set to 1.

<num> Offset slope value in dB/ 1GHz.

Examples

```
CALC:OFFS:MAGN:SLOP 1 'Offset slope set to 1dB/GHz  
calculat1:offset:magnitude:slope -2 'Offset slope set to -  
2dB/GHz
```

Query Syntax CALCulate<num>:OFFSet:MAGNitude:SLOPe?

Return Type Numeric

Default 0

CALCulate<num>:OFFSet:PHASe <num>[<char>]

Applicable Models: All

(Read-Write) Sets the phase offset for the selected measurement.

See Critical Note

Parameters

- <num> Channel number of the measurement. There must be a selected measurement on that channel. If unspecified, <num> is set to 1.
- <num> Offset phase value. Choose any number between:
-360 and **360**
- <char> Units for phase. OPTIONAL. Choose either:
DEG - Degrees (default)
RAD - Radians

Examples

```
CALC:OFFS:PHAS 10  
calculate:offset:phase 20rad
```

Query Syntax CALCulate:OFFSet:PHASe?

Return Type Numeric, returned value always in degrees

Default 0 degrees

Calculate:Parameter Commands

Lists, creates, selects, and deletes measurements.

For application measurements, use [Calc:Custom commands](#).

CALCulate:PARAmeter:
CATalog
EXTended
COUNT
DEFine
EXTended
DELete
ALL
MNUMber
[SELEct]
MODify
EXTended
SELEct
TAG
NEXT?
TNUMber?
WNUMber?

Click on a keyword to view the command details.

[Blue](#) commands are superseded.

See Also

- [Example Programs](#)
- [Learn about Measurement Parameters](#)
- [Synchronizing the Analyzer and Controller](#)

- [SCPI Command Tree](#)

Critical Note: CALCulate commands act on the selected measurement. You can select one measurement for each channel using [Calc:Par:MNUM](#) or [Calc:Par:Select](#). [Learn more](#).

CALCulate<cnum>:PARAmeter:CATalog? <enum> **Superseded**

Applicable Models: All

Note: This command is replaced with [CALC:PAR:CAT:EXTended?](#) which lists parameters with "_" instead of "," allowing the list to be parsed easily. This command will continue to work.

(Read-only) Returns the names and parameters of existing measurements for the specified channel.

Note: For Balanced Measurements: CALC:PAR:CAT? may have an unexpected behavior. [Learn more](#).

See [Critical Note](#)

Parameters

<cnum> Channel number of the measurements to be listed. If unspecified, <cnum> is set to 1.

<enum> Choose from:

NORMAL - This is the default if no parameter is specified. If a trace title is defined in a standard channel, then the "name" returned is the same as the trace title. For non standard channels, the "name" returned is the underlying parameter name, regardless of whether the user has turned on a trace title or not.

DISPlay - If a trace title is defined, then the "name" returned is the same as the trace title.

DEFine - The "name" returned is always the same as the underlying parameter name, regardless of whether the trace title is turned on or not.

Examples

```
CALC:PAR:CAT? DISP
calculate2:parameter:catalog?
```

Return Type String - "<measurement name>,<parameter>,[<measurement name>,<parameter>...]"

Default "CH1_S11_1,S11"

CALCulate<cnum>:PARAmeter:CATalog:EXTended? <enum>

Applicable Models: All

(Read-only) Returns the names and parameters of existing measurements for the specified channel. This command lists receiver parameters with "_" such that R1,1 is reported as R1_1. This makes the returned string a true "comma-delimited" list all the time.

The returned string of this command is easily parsed and used to create measurements using the **CALC:PAR:EXT** command.

Parameters

<num> Channel number of the measurements to be listed. If unspecified, <num> is set to 1.

<enum> Choose from:

NORMAL - This is the default if no parameter is specified. If a trace title is defined in a standard channel, then the "name" returned is the same as the trace title. For non standard channels, the "name" returned is the underlying parameter name, regardless of whether the user has turned on a trace title or not.

DISPLAY - If a trace title is defined, then the "name" returned is the same as the trace title.

DEFINE - The "name" returned is always the same as the underlying parameter name, regardless of whether the trace title is turned on or not.

Examples

```
CALC:PAR:CAT:EXT? DEF
```

```
calculate2:parameter:catalog:extended?
```

Return Type String - "<measurement name>,<parameter>,[<measurement name>,<parameter>...]"

Default "CH1_S11_1,S11"

CALCulate<num>:PARAmeter:COUNT <value>

Applicable Models: N522xB, N523xB, N524xB, E5080A, M948xA

(Write-only) Sets or gets the number of traces of selected channel.

Parameters

- <num> Channel number of the measurements to be listed. There must be a selected measurement on that channel. If unspecified, <num> is set to 1.
- <value> Number of traces that should be present on the selected channel. Varies depending on the upper limit setting for the channel/trace number.

Note: This command will delete measurements if the specified value is less than the current value.

Examples `CALC:PAR:COUN 1`

Query Numeric
Syntax
Default 1

CALCulate<num>:PARAMeter[:DEFine] <Mname>,<param>[,port] **Superseded**

Applicable Models: N522xB, N523xB, N524xB, M937xA, P937xA

Note: This command is replaced with `CALC:PAR:DEFine:EXTended`. This command will continue to work for up to 4-port parameters.

(Write-only) Creates a measurement but does NOT display it.

There is no limit to the number of measurements that can be created. However, there is a limit to the number of measurements that can be displayed. See [Traces, Channels, and Windows on the VNA](#).

- Use `DISP:WIND:STATe` to create a window if it doesn't already exist.
- Use `DISP:WIND<wnum>:TRAC<tnum>:FEED <Mname>` to display the measurement.

For Application Measurements see `CALC:CUST:DEF`

You must select the measurement (`CALC<num>:PAR:SEL <mname>`) before making additional settings.

See [Critical Note](#)

Parameters

- <num> Channel number of the new measurement. If unspecified, value is set to 1.
- <Mname> Name of the measurement. Any non-empty, unique string, enclosed in quotes.
- <param> Parameter to be measured. Quotes are optional.

For S-parameters:

Any S-parameter available in the VNA

For ratioed measurements:

Any two receivers that are available in the VNA. (See the [block diagram](#) showing the receivers in YOUR VNA.)

For example: AR1 (this means A/R1)

For non-ratioed measurements:

Any receiver that is available in the VNA. (See the [block diagram](#) showing the receivers in YOUR VNA.)

For example: A

For Balanced Measurements:

First create an S-parameter measurement, then change the measurement using [CALC:FSIM:BAL](#) commands. [See an example.](#)

For Applications see [CALC:CUST:DEF](#).

[port] Optional argument;

For multi-port reflection S-parameter measurements: specifies the VNA port which will provide the load for the calibration. This argument is ignored if a transmission S-parameter is specified.

For all non S-parameter measurements: specifies the source port for the measurement.

Examples

```
CALC4:PAR 'ch4_S33',S33,2 'Defines an S33 measurement with a load on port2 of the analyzer.'
```

```
calculate2:parameter:define 'ch1_a', a, 1 'unratioed meas'
```

```
calculate2:parameter:define 'ch1_a', ar1,1 'ratioed meas'
```

Query Syntax Not Applicable; see [Calc:Par:Cat?](#)

Default Not Applicable

CALCulate<cnum>:PARAmeter[:DEFine]:EXTended <Mname>,<param>

Applicable Models: N522xB, N523xB, N524xB, M937xA, P937xA

Note: This command replaces **CALC:PAR:DEF** as it allows the creating of measurements using external multiport testsets.

(Write-only) Creates a measurement but does NOT display it.

There is no limit to the number of measurements that can be created. However, there is a limit to the number of measurements that can be displayed. See [Traces, Channels, and Windows on the VNA](#).

- Use **DISP:WIND:STATe** to create a window if it doesn't already exist.
- Use **DISP:WIND<wnum>:TRAC<tnum>:FEED <Mname>** to display the measurement.

Note: For Application Measurements see **CALC:CUST:DEF**

You must select the measurement using **CALC:PAR:SElect** before making additional settings.

See [Critical Note](#)

Parameters

- <num> Channel number of the new measurement. If unspecified, value is set to 1.
- <Mname> **(String)** Name of the measurement. Any non-empty, unique string, enclosed in quotes.
- <param> **(String)** Measurement Parameter to create. Case sensitive.

For S-parameters:

Any S-parameter available in the VNA

Single-digit port numbers CAN be separated by "_" (underscore). For example: **"S21" or "S2_1"**

Double-digit port numbers MUST be separated by underscore. For example: **"S10_1"**

For ratioed measurements:

Any two VNA physical receivers separated by forward slash "/" followed by comma and source port.

For example: **"A/R1, 3"**

[Learn more about ratioed measurements](#)

See a [block diagram](#) showing the receivers in YOUR VNA.

For non-ratioed measurements:

Any VNA physical receiver followed by comma and source port.

For example: "A, 4"

[Learn more about unratiod measurements.](#)

See the [block diagram](#) showing the receivers in YOUR VNA.

Ratiod and **Unratiod** measurements can also use **logical receiver notation** to refer to receivers. This notation makes it easy to refer to receivers with an external test set connected to the VNA. You do not need to know which physical receiver is used for each test port. [Learn more.](#)

For ADC measurements:

Any ADC receiver in the VNA followed by a comma, then the source port.

For example: "AI1,2" indicates the Analog Input1 with source port of 2.

[Learn more about ADC receiver measurements.](#)

For Balanced Measurements:

First create an S-parameter measurement, then change the measurement using **CALC:FSIM:BAL** "define" commands. [See an example.](#)

Note: For Application Measurements see **CALC:CUST:DEF**

Examples

```
CALC4:PAR:EXT 'ch4_S33', 'S33' 'Defines an S33 measurement'
```

```
calculate2:parameter:define:extended 'ch1_a', 'b9, 1' 'logical receiver notation for unratiod meas of test port 9 receiver with source port 1.'
```

```
calculate2:parameter:define:extended 'ch1_a', 'b9/a10,1' 'logical receiver notation for ratiod meas of test port 9 receiver divided by the reference receiver for port 10 using source port 1'
```

Query Syntax Not Applicable; see [Calc:Par:Cat?](#)

Default Not Applicable

CALCulate<cnum>:PARAmeter:DELeTe[:NAME] <Mname>

Applicable Models: All

(Write-only) Deletes the specified measurement.

See Critical Note

Parameters

<cnum> Channel number of the measurement. There must be a selected measurement on that channel. If unspecified, <cnum> is set to 1.

<Mname> String - Name of the measurement

Examples

```
CALC:PAR:DEL 'TEST'  
calculate2:parameter:delete 'test'
```

Query Syntax Not Applicable

Default Not Applicable

CALCulate:PARAmeter:DELeTe:ALL

Applicable Models: All

(Write-only) Deletes all measurements on the VNA.

See Critical Note

Parameters

Examples

```
CALC:PAR:DEL:ALL
```

Query Syntax Not Applicable

Default Not Applicable

CALCulate<cnum>:PARAmeter:MNUMber[:SELeCt] <n>[,fast]

Applicable Models: N522xB, N523xB, N524xB, M937xA, P937xA

(Read-Write) Sets and returns the selected measurement for the channel using the **Tr#**. Most **CALC:** commands require that this, or **CALC:PAR:SEL**, be sent before a setting change is made to that measurement. Each channel can have one selected measurement.

Parameters

- <cnum> Channel number of the measurement to be selected. If unspecified, <cnum> is set to 1.
- <n> Numeric - Measurement number. These are the same numbers you see in the “Tr1”, “Tr2” annotation next to the parameter name on the VNA screen.
- [fast] Optional. The VNA display is NOT updated. Therefore, do not use this argument when an operator is using the VNA display. Otherwise, sending this argument results in much faster sweep speeds. There is NO other reason to NOT send this argument.

Examples

```
CALC:PAR:MNUM 2  
  
calculate2:parameter:mnumber:select 3,fast
```

Query Syntax CALCulate<cnum>:PARAmeter:MNUMber[:SElect]?

There is NO query available to determine if the FAST argument has been set.

Return Type Numeric

Default 1 (Trace number when factory preset is performed)

CALCulate<cnum>:PARAmeter:MODify <param> **Superseded**

Applicable Models: N522xB, N523xB, N524xB, M937xA, P937xA

Note: This command is replaced with **CALC:PAR:MOD:EXT**. This command will continue to work for up to 4 port parameters.

(Write-only) Modifies a standard measurement using the same arguments as **CALC:PAR:DEF**. To modify an FCA measurement, use **CALC:CUST:MOD**.

See Critical Note

Parameters

- <cnum> Channel number of the measurement. The selected measurement on that channel will be changed. If unspecified, <cnum> is set to 1.

<param> Measurement parameter to change to. Use the same <param> arguments as **CALC:PAR:DEF**.

Examples

```
SYST:PRESET
CALC:PAR:DEF "MyMeas", S11
CALC:PAR:SEL "MyMeas"
CALC:PAR:MOD AR1 'changes the selected S11 measurement to an A/R1 measurement'
```

Query Syntax Not Applicable

Default Not Applicable

CALCulate<cnum>:PARAmeter:MODify:EXTended <param>

Applicable Models: N522xB, N523xB, N524xB, M937xA, P937xA

Note: This command replaces **CALC:PAR:MOD** as it allows modification of measurements using external multiport testsets.

(Write-only) Modifies a standard measurement using the same arguments as **CALC:PAR:DEF:EXT**.

To modify an Application measurement, use **CALC:CUST:MOD**.

See **Critical Note**

Parameters

<cnum> Channel number of the measurement. The selected measurement on that channel will be changed. If unspecified, <cnum> is set to 1.

<param> **(String)** New measurement parameter. Use the same <param> arguments as **CALC:PAR:DEF:EXT**.

Examples

```
SYST:PRESET
CALC:PAR:DEF:EXT "MyMeas", "S10_1"
CALC:PAR:SEL "MyMeas"
CALC:PAR:MOD:EXT "a4b4,1" 'changes the selected S10_1 measurement to an a4/b4 measurement with source port 1'
```

Query Syntax Not Applicable

Default Not Applicable

CALCulate<cnum>:PARAmeter:TAG:NEXT?

Applicable Models: E5080A, M9485A

(Read-only)

Parameters

<cnum> Channel number of the measurement. The selected measurement on that channel will be changed. If unspecified, <cnum> is set to 1.

Examples `CALC:PAR:TAG:NEXT`

Query Not Applicable

Syntax

Default Not Applicable

CALCulate<cnum>:PARAmeter:SELEct <Mname>[,fast]

Applicable Models: N522xB, N523xB, N524xB, M937xA, P937xA

(Read-Write) Sets the selected measurement. Most CALC: commands require that this command be sent before a setting change is made. One measurement on each channel can be selected at the same time.

- Use `CALC:PAR:MNUM` to select a measurement by **Tr#** number. [Learn more](#).
- To obtain a list of currently named measurements, use `CALC:PAR:CAT?`

Parameters

<cnum> Channel number of the measurement to be selected. If unspecified, <cnum> is set to 1.

<Mname> String - Name of the measurement. CASE-SENSITIVE. Do NOT include the parameter name that is returned with `Calc:Par:Cat?`

[fast] Optional. The VNA display is NOT updated. Therefore, do not use this argument when an operator is using the VNA display. Otherwise, sending this argument results in much faster sweep speeds. There is NO other reason to NOT send this argument.

Examples `CALC:PAR:SEL 'TEST'`
`calculate2:parameter:select 'test',fast`

Query Syntax `CALCulate:PARAmeter:SELEct?`

There is NO query available to determine if the FAST argument has been set.

Return Type String

Default "CH1_S11_1" (Trace name when factory preset is performed)

CALCulate<cnum>:PARAmeter:TAg:NEXT?

Applicable Models: N522xB, N523xB, N524xB, M937xA, P937xA

(Read-only) Returns a string that is guaranteed to be unique and valid for use with **CALC:PAR:DEF**.

Parameters

<cnum> Channel number of the trace. If unspecified, <cnum> is set to 1.

Examples

```
CALC:PAR:TAg:NEXT?  
calculate2:parameter:tag:next?
```

Return Type String

Default Not Applicable

CALCulate<cnum>:PARAmeter:TNUMBER?

Applicable Models: N522xB, N523xB, N524xB, M937xA, P937xA

(Read-only) Returns the trace number of the selected trace. Select a trace using **Calc:Par:Select**.

Parameters

<cnum> Channel number of the trace. If unspecified, <cnum> is set to 1.

Examples

```
CALC:PAR:TNUM?  
calculate2:parameter:tnumber?
```

Return Type Numeric

Default Not Applicable

CALCulate<cnum>:PARAmeter:WNUMBER?

Applicable Models: N522xB, N523xB, N524xB, M937xA, P937xA

(Read-only) Returns the window number of the selected trace. Select a trace using **Calc:Par:Select**.

Parameters

<cnm> Channel number of the selected trace. If unspecified, <cnm> is set to 1.

Examples

```
CALC:PAR:WNUM?  
calculate2:parameter:wnumber?
```

Return Type Numeric

Default Not Applicable

Calculate:RData? Command

This command is **Superseded** by the `CALCulate:MEASure:RDATa` command.

Critical Note: CALCulate commands act on the selected measurement. You can select one measurement for each channel using `Calc:Par:MNUM` or `Calc:Par:Select`. [Learn more.](#)

CALCulate<cnum>:RDATA? <char>

Applicable Models: N522xB, N523xB, N524xB, M937xA, P937xA

(Read-only) Returns receiver data for the selected measurement. To query measurement data, see `CALC:DATA?`

Parameters

<cnum> Channel number of the measurement. There must be a selected measurement on that channel. If unspecified, <cnum> is set to 1.

<char> Choose from any physical receiver in the VNA.

For example: "A"

Also, **REF** - returns data for either R1 or R2 data depending on the source port of the selected measurement.

See the [block diagram](#) showing the receivers in YOUR VNA.

Note: Logical receiver notation is NOT allowed with this command. [Learn more.](#)

Example

```
GPIB.Write "INITiate:CONTinuous OFF"  
GPIB.Write "INITiate:IMMediate;*wai"  
GPIB.Write "CALCulate:RDATA? A"
```

```
GPIB.Write "CALCulate:RDATA? REF"
```

Return Type Depends on `FORM:DATA` - Two numbers per data point

Default Not Applicable

Notes:

Generally when you query the analyzer for data, you expect that the number of data values returned will be consistent with the number of points in the sweep.

However, if you query **receiver** data while the instrument is sweeping, the returned values may contain

zeros. For example, if your request for receiver data is handled on the 45th point of a 201 point sweep, the first 45 values will be valid data, and the remainder will contain complex zero.

This can be avoided by synchronizing this request with the end of a sweep or putting the channel in hold mode.

[Learn about Unratioed Measurements](#)

CALCulate:SA:MARKer commands

Controls the marker settings used in the SA application.

These commands are **Superseded** by the CALCulate:MEASure:SA commands.

CALCulate:SA:MARKer:

BDENsity

| **BW**

| **DATA?**

| **EQSPan**

| **NOISe**

| **[:STATe]**

| **POWer**

| **BW**

| **[:STATe]**

| **TONE**

| **BW**

| **[:STATe]**

| **TSPacing**

BPOWer

| **DATA?**

| **SPAN**

| **[:STATe]**

OCCBand

| **CENTer?**

| **PERCent**
| **POWer?**
| **SPAN?**
| **[[:STATe]**

Click on a keyword to view the command details.

See Also

- Marker Readout **number** and **size** commands.
- [Learn about Markers](#)
- [Synchronizing the Analyzer and Controller](#)
- [SCPI Command Tree](#)

Critical Note: CALCulate commands act on the selected measurement. You can select one measurement for each channel using **Calc:Par:MNUM** or **Calc:Par:Select**. [Learn more](#).

If you use **Calc:Par:Cat?** to return the list of current measurements, the returned string will be similar to 'CH1_B_1,B'.

To select this measurement as a parameter for SA, you need to send **Calc:Par:Sel** 'CH1_B_1'.

Moreover, most of the following commands will return '+202, "Parameter not valid" if they are called with marker number n, and marker number n is not currently turned ON.

Important: Learn about [programming the reference marker](#).

Note: For all band power marker family (this includes BNOise, BPOWer, OCCBand markers) and when measuring wideband repetitive modulated signals, there is basically 2 approaches to get good measurements:

- Either run the coherent mode of SA if the modulated test signal repetition period or tone spacing is known and a frequency reference connection is made between the signal source and the PNA (usually the 10 MHz ref signal BNC). See SA Setup Coherence.

- Or make use of a RBW that is equal or smaller than 1/20 of the modulated test signal tone spacing (rule of thumb). The test signal tone spacing is 1/ the test signal duration. For example, if the ARB file that generates the test signal replays each 100 microseconds, it means the tone spacing is 10 kHz. So, we recommend to set the RBW to 500 Hz or below.

CALCulate<ch>:SA:MARKer<n>:BDENsity:BW <num>

Applicable Models: All with Spectrum Analysis Options (S9x09xxA/B, S9x090A/B)

(Read-Write) Sets and reads the bandwidth of the band density marker.

See Critical Note

Parameters

- <ch> Channel number of the measurement. There must be a selected measurement on that channel. If unspecified, <ch> is set to 1.
- <n> Marker number. If unspecified, <n> is set to 1.
- <num> Choose a bandwidth.

Examples

```
CALC:SA:MARK:BDEN:BW 1e6
```

Query Syntax CALCulate<ch>:SA:MARKer<n>:BDENsity:BW?

Return Type Numeric

Default 1 MHz

CALCulate<ch>:SA:MARKer<n>:BDENsity:DATA?

Applicable Models: All with Spectrum Analysis Options (S9x09xxA/B, S9x090A/B)

(Read-only) Returns the band density level in dBm/Hz from the band density marker.

See Critical Note

Parameters

- <ch> Channel number of the measurement. There must be a selected measurement on that SA channel. If unspecified, <ch> is set to 1.
- <n> Band density marker number. If unspecified, <n> is set to 1.

Examples

```
CALC:SA:MARK:BDEN:DATA?
```

```
calculate2:sa:marker2:bdensity:data?
```

Return Type Numeric

Default Not applicable

CALCulate<ch>:SA:MARKer<n>:BDENsity:EQSPan <num>

Applicable Models: All with Spectrum Analysis Options (S9x09xxA/B, S9x090A/B)

(Read-Write) Sets and reads the frequency span used by Power Density to normalize the power.

See Critical Note

Parameters

- <ch> Channel number of the measurement. There must be a selected measurement on that channel. If unspecified, <ch> is set to 1.
- <n> Marker number. If unspecified, <n> is set to 1.
- <num> Choose a span.

Examples

```
CALC:SA:MARK:BDEN:EQSPan 1e6
```

Query Syntax

```
CALCulate<ch>:SA:MARKer<n>:BDENsity:EQSPan?
```

Return Type

Numeric

Default

1 MHz

CALCulate<ch>:SA:MARKer<n>:BDENsity:NOISe[:STATE] <bool>

Applicable Models: All with Spectrum Analysis Options (S9x09xxA/B, S9x090A/B)

(Read-Write) Sets and reads the state of the band density noise marker.

See Critical Note

Parameters

- <ch> Channel number of the measurement. There must be a selected measurement on that channel. If unspecified, <ch> is set to 1.
- <n> Marker number. If unspecified, <n> is set to 1.
- <bool> Choose from:
 - 0 - OFF** - Turn band density noise marker OFF.
 - 1 - ON** - Turn band density noise marker ON.

Examples

```
'Select the measurement
```



```

CALC2:PAR:SEL "M2SA_CH2_A"

'Create marker3 on that measurement

CALC2:MARK3 ON

'Make it a band density noise marker

CALC:SA:MARK:BDEN:NOIS:STAT 1

```

Query Syntax CALCulate<ch>:SA:MARKer<n>:BDENsity:NOISe?

Return Type Boolean

Default 0

CALCulate<ch>:SA:MARKer<n>:BDENsity:POWer:BW <num>

Applicable Models: All with Spectrum Analysis Options (S9x09xxA/B, S9x090A/B)

(Read-Write) Sets and reads the bandwidth of the band power density marker.

See Critical Note

Parameters

- <ch> Channel number of the measurement. There must be a selected measurement on that channel. If unspecified, <ch> is set to 1.
- <n> Marker number. If unspecified, <n> is set to 1.
- <num> Choose a bandwidth.

Examples

```
CALC:SA:MARK:BDEN:POW:BW 1e6
```

Query Syntax CALCulate<ch>:SA:MARKer<n>:BDENsity:POWer:BW?

Return Type Numeric

Default 1 MHz

CALCulate<ch>:SA:MARKer<n>:BDENsity:POWer[:STATe] <bool>

Applicable Models: All with Spectrum Analysis Options (S9x09xxA/B, S9x090A/B)

(Read-Write) Sets and reads the state of the band power density marker.

See Critical Note

Parameters

- <ch> Channel number of the measurement. There must be a selected measurement on that channel. If unspecified, <ch> is set to 1.
- <n> Marker number. If unspecified, <n> is set to 1.
- <bool> Choose from:
- 0 - OFF** - Turn band power density marker OFF.
 - 1 - ON** - Turn band power density marker ON.

Examples

```
'Select the measurement
CALC2:PAR:SEL "M2SA_CH2_A"

'Create marker3 on that measurement
CALC2:MARK3 ON

'Make it a band density noise marker
CALC:SA:MARK:BDEN:POW:STAT 1
```

Query Syntax CALCulate<ch>:SA:MARKer<n>:BDENsity:POWer?

Return Type Boolean

Default 0

CALCulate<ch>:SA:MARKer<n>:BDENsity:TONE:BW <num>

Applicable Models: All with Spectrum Analysis Options (S9x09xxA/B, S9x090A/B)

(Read-Write) Sets and reads the bandwidth of the band tone density marker.

See Critical Note

Parameters

- <ch> Channel number of the measurement. There must be a selected measurement on that channel. If unspecified, <ch> is set to 1.
- <n> Marker number. If unspecified, <n> is set to 1.
- <num> Choose a bandwidth.

Examples

```
CALC:SA:MARK:BDEN:TONE:BW 1e6
```

Query Syntax

```
CALCulate<ch>:SA:MARKer<n>:BDENsity:TONE:BW?
```

Return Type

Numeric

Default

1 MHz

```
CALCulate<ch>:SA:MARKer<n>:BDENsity:TONE[:STATe] <bool>
```

Applicable Models: All with Spectrum Analysis Options (S9x09xxA/B, S9x090A/B)

(Read-Write) Sets and reads the state of the band tone density marker.

See Critical Note

Parameters

- <ch> Channel number of the measurement. There must be a selected measurement on that channel. If unspecified, <ch> is set to 1.
- <n> Marker number. If unspecified, <n> is set to 1.
- <bool> Choose from:

0 - OFF - Turn band tone density marker OFF.

1 - ON - Turn band tone density marker ON.

Examples

```
'Select the measurement  
CALC2:PAR:SEL "M2SA_CH2_A"  
  
'Create marker3 on that measurement  
CALC2:MARK3 ON
```

```
'Make it a band density noise marker
```

```
CALC:SA:MARK:BDEN:TONE:STAT 1
```

Query Syntax CALCulate<ch>:SA:MARKer<n>:BDENsity:TONE?

Return Type Boolean

Default 0

```
CALCulate<ch>:SA:MARKer<n>:BDENsity:TONE:TSPacing <num>
```

Applicable Models: All with Spectrum Analysis Options (S9x09xxA/B, S9x090A/B)

(Read-Write) Sets and reads the spacing of the band tone density marker.

See [Critical Note](#)

Parameters

- <ch> Channel number of the measurement. There must be a selected measurement on that channel. If unspecified, <ch> is set to 1.
- <n> Marker number. If unspecified, <n> is set to 1.
- <num> Choose a spacing value.

Examples

```
CALC:SA:MARK:BDEN:TONE:TSP 100e6
```

Query Syntax CALCulate<ch>:SA:MARKer<n>:BDENsity:TONE:TSPacing?

Return Type Numeric

Default 100 MHz

```
CALCulate<ch>:SA:MARKer<n>:BPOWer:DATA?
```

Applicable Models: All with Spectrum Analysis Options (S9x09xxA/B, S9x090A/B)

(Read-only) Returns the band power level from the band power marker.

See Critical Note

Parameters

- <ch> Channel number of the measurement. There must be a selected measurement on that SA channel. If unspecified, <ch> is set to 1.
- <n> Band power marker number. If unspecified, <n> is set to 1.

Examples

```
CALC:SA:MARK:BPOW:DATA?  
calculate2:sa:marker2:bpower:data?
```

Default Not applicable

CALCulate<ch>:SA:MARKer<n>:BPOWer:SPAN <num>

Applicable Models: All with Spectrum Analysis Options (S9x09xxA/B, S9x090A/B)

(Read-Write) Sets and reads the frequency span of the band power marker. This area is marked by two vertical dotted lines on the screen and the marker's y-axis value is set to the measured power value. Noise and power on the same marker share the same span.

See Critical Note

Parameters

- <ch> Channel number of the measurement. There must be a selected measurement on that channel. If unspecified, <ch> is set to 1.
- <n> Marker number. If unspecified, <n> is set to 1.
- <num> Choose a frequency span within the frequency range of the analyzer.

Examples

```
CALC:SA:MARK:BPOW:SPAN 1e6
```

Query Syntax CALCulate<ch>:SA:MARKer<n>:BPOWer:SPAN?

Return Type Numeric

Default 1 MHz

CALCulate<ch>:SA:MARKer<n>:BPOWer[:STATe] <bool>

Applicable Models: All with Spectrum Analysis Options (S9x09xxA/B, S9x090A/B)

(Read-Write) Sets and reads the state of the band power marker. This command makes a band power marker from a generic marker. The generic marker must first be created using: **CALC:MARK:STATe**

See Critical Note

Parameters

- <ch> Channel number of the measurement. There must be a selected measurement on that channel. If unspecified, <ch> is set to 1.
- <n> Marker number. If unspecified, <n> is set to 1.
- <bool> Choose from:
 - 0 - OFF** - Turn band power marker OFF.
 - 1 - ON** - Turn band power marker ON.

Examples

```
'Select the measurement
CALC2:PAR:SEL "M2SA_CH2_A"

'Create marker3 on that measurement
CALC2:MARK3 ON

'Make it a band power marker
CALC:SA:MARK:BPOW:STAT 1
```

Query Syntax CALCulate<ch>:SA:MARKer<n>:BPOWer?

Return Type Boolean

Default 0

CALCulate<ch>:SA:MARKer<n>:OCCBand:CENTer?

Applicable Models: All with Spectrum Analysis Options (S9x09xxA/B, S9x090A/B)

(Read-only) Returns the occupied bandwidth center frequency.

See Critical Note

Parameters

- <ch> Channel number of the measurement. There must be a selected measurement on that SA channel. If unspecified, <ch> is set to 1.
- <n> Marker number. If unspecified, <n> is set to 1.

Examples

```
CALC:SA:MARK:OCCB:CENT?  
calculate2:sa:marker2:occband:center?
```

Default Not applicable

CALCulate<ch>:SA:MARKer<n>:OCCBand:PERCent <num>

Applicable Models: All with Spectrum Analysis Options (S9x09xxA/B, S9x090A/B)

(Read-Write) Sets and returns the percentage of the band power to search for.

See Critical Note

Parameters

- <ch> Channel number of the measurement. There must be a selected measurement on that channel. If unspecified, <ch> is set to 1.
- <n> Marker number. If unspecified, <n> is set to 1.
- <num> Percentage value.

Examples

```
CALC:SA:MARK:OCCB:PERC 99  
calculate2:sa:marker2:occband:percent 99
```

Query Syntax CALCulate<ch>:SA:MARKer<n>:OCCBand:PERCent?

Return Type Numeric

Default 99.0

CALCulate<ch>:SA:MARKer<n>:OCCBand:POWER?

Applicable Models: All with Spectrum Analysis Options (S9x09xxA/B, S9x090A/B)

(Read-only) Returns the occupied bandwidth power.

See Critical Note

Parameters

<ch> Channel number of the measurement. There must be a selected measurement on that SA channel. If unspecified, <ch> is set to 1.

<n> Marker number. If unspecified, <n> is set to 1.

Examples

```
CALC:SA:MARK:OCCB:POW?
```

```
calculate2:sa:marker2:occband:power?
```

Default Not applicable

```
CALCulate<ch>:SA:MARKer<n>:OCCBand:SPAN?
```

Applicable Models: All with Spectrum Analysis Options (S9x09xxA/B, S9x090A/B)

(Read-only) Returns the occupied bandwidth span.

See Critical Note

Parameters

<ch> Channel number of the measurement. There must be a selected measurement on that SA channel. If unspecified, <ch> is set to 1.

<n> Marker number. If unspecified, <n> is set to 1.

Examples

```
CALC:SA:MARK:OCCB:SPAN?
```

```
calculate2:sa:marker2:occband:span?
```

Default Not applicable

```
CALCulate<ch>:SA:MARKer<n>:OCCBand[:STATe] <bool>
```

Applicable Models: All with Spectrum Analysis Options (S9x09xxA/B, S9x090A/B)

(Read-Write) Sets and returns the occupied bandwidth on/off state.

See Critical Note

Parameters

- <ch> Channel number of the measurement. There must be a selected measurement on that channel. If unspecified, <ch> is set to 1.
- <n> Marker number. If unspecified, <n> is set to 1.
- <bool> Choose from:
 - 0 - OFF** - Turns occupied bandwidth OFF.
 - 1 - ON** - Turns occupied bandwidth ON.

Examples

```
CALC:SA:MARK:OCCB:STAT 1  
calculate2:sa:marker2:occband:state 1
```

Query Syntax CALCulate<ch>:SA:MARKer<n>:OCCBand[:STATe]?

Return Type Boolean

Default 0

Note: If occupied band state is turned ON, then Band Power or Band Noise is turned OFF.

Calculate:Smoothing Commands

Controls point-to-point smoothing. Smoothing is a noise reduction technique that averages adjacent data points in a measurement trace. Choose the amount of smoothing by specifying either the number of points or the aperture. Smoothing is not the same as CALC:AVERage which averages each data point over a number of sweeps.

These commands are **Superseded** by the CALCulate:MEASure:SMOothing commands.



Click on a keyword to view the command details.

See Also

- [Example Programs](#)
- [Learn about Smoothing](#)
- [Synchronizing the Analyzer and Controller](#)
- [SCPI Command Tree](#)

Critical Note: CALCulate commands act on the selected measurement. You can select one measurement for each channel using [Calc:Par:MNUM](#) or [Calc:Par>Select](#). [Learn more](#).

CALCulate<cnum>:SMOothing:APERture <num>

Applicable Models: N522xB, N523xB, N524xB, M937xA, P937xA

(Read-Write) Sets the amount of smoothing as a percentage of the number of data points in the channel.

See Critical Note

Parameters

- <cnum>** Channel number of the measurement. There must be a selected measurement on that channel. If unspecified, <cnum> is set to 1.
- <num>** Percentage value. Choose any number between: **1** and **25**

Examples

```
CALC:SMO:APER 2  
calculate2:smoothing:aperture 20.7
```

Query Syntax CALCulate<cnum>:SMOothing:APERture?

Return Type Numeric

Default 1.5

CALCulate<cnum>:SMOothing:POINTs <num>

Applicable Models: N522xB, N523xB, N524xB, M937xA, P937xA

(Read-Write) Sets the number of adjacent data points to average.

See Critical Note

Parameters

- <cnum>** Channel number of the measurement. There must be a selected measurement on that channel. If unspecified, <cnum> is set to 1.
- <num>** Number of points from 1 point to maximum of 25% of data points in the channel. For example: if number of points in a data trace = 401, the maximum value for points = 100. The points value is always rounded to the closest odd number.

Examples

```
CALC:SMO:POIN 50  
calculate2:smoothing:points 21
```

Query Syntax CALCulate<cnum>:SMOothing:POINTs?

Return Type Numeric

Default 3

CALCulate<cnum>:SMOothing[:STATe] <ON | OFF>

Applicable Models: N522xB, N523xB, N524xB, M937xA, P937xA

(Read-Write) Turns data smoothing ON or OFF.

See [Critical Note](#)

Parameters

<cnum> Channel number of the measurement. There must be a selected measurement on that channel. If unspecified, <cnum> is set to 1.

<ON | OFF> **ON** (or 1) - turns smoothing ON.
OFF (or 0) - turns smoothing OFF.

Examples

```
CALC:SMO ON
```

```
calculate2:smoothing:state off
```

Query Syntax CALCulate<cnum>:SMOothing[:STATe]?

Return Type Boolean (1 = ON, 0 = OFF)

Default OFF

CALulate:TDR Commands

These commands control the setup and execution of TDR measurements.

CALCulate:TDR

ALLocate

DEVice

EMPHasis

| CURSor

| **POST1**

| **POST2**

| **PRE1**

| **STATe**

EQUalization

| CTLE

| **DC**

| **POLE1**

| **POLE2**

| **ZERO1**

| **FILEname**

| **STATe**

| **TYPE**

EYE

| **EXECute**

| **INPut**

| **BPATtern**

| **LENGth**

| **TYPE**

| **DRATe**

| **JITTer**

| **DLIMit**

| **PERiodic**

| **FREQuency**

| **MAGNitude**

| **RANDom**

| **MAGNitude**

| **STATe**

| **TYPE**

| **OLEVel**

| **RTIMe**

| **DATA**

| **THReshold**

| **ZLEVel**

| **MASK**

| **FAIL?**

| **STATe**

| **RESults**

| **DATA?**

| **DISPlay**

| **STATe**

| **THReshold**

| **STATe**

MEASure

| **ACTive**

| **MARKer**

| **DTIMe**

| **DATA?**

| **POSiTion**

| **STATe**

| **TARGet**

| **FORMat**

| **MARKer**

| **REFerence**

| **STATe**

| **STATe**

| **PARAmeter**

| **PEELing**

| **STATe**

| **SMOothing**

| **STATe**

| **TIME**

| **IMPulse**

| **WIDTH**

| **STEP**

| **RTIME**

| **THReshold**

| **TYPE**

| **TTIME**

| **DATA**

| **STATe**

| **THReshold**

TIME

| **COUPlE**

| **STEP**

| **AMPLitude**



Click on a [red](#) keyword to view the command details.

See Also

- [Synchronizing the Analyzer and Controller](#)
 - [SCPI Command Tree](#)
-

CALCulate<num>:TDR:ALLocate <enum>

Applicable Models: All with TDR Options (S9x011A/B)

(Read-Write) This command sets the type of parameter and format allocation for each trace.

Parameters

<num> Channel number of the measurement. If unspecified, <num> is set to 1.

<enum> Parameters to display. Choose from:

SPARameters - Display all S-parameter data.

TPARameters - Display all Time domain data.

MIXed - Display a mix of commonly measured time-domain and S-parameter data.

Examples

```
CALC:TDR:ALL SPAR  
calculate2:tdr:allocate sparameters
```

Query Syntax CALCulate<num>:TDR:ALLocate?

Return Type String

Default MIXed

CALCulate<num>:TDR:DEVice <enum>

Applicable Models: All with TDR Options (S9x011A/B)

(Read-Write) This command sets the DUT topology.

Parameters

<num> Channel number of the measurement. If unspecified, <num> is set to 1.

<enum> Topology. Choose from:

SEND1 - Single-ended, 1-port.

SEND2 - Single-ended, 2-port.

DIF1 - Differential, 1-port.

SEND4 - Single-ended, 4-port.

DIF2 - Differential, 2-port.

Examples

```
CALC:TDR:DEV SEND2  
calculate2:tdr:device:send2
```

Query Syntax CALCulate<num>:TDR:DEVice?

Return Type String

Default SEND1

CALCulate<num>:TDR:EMPHasis:CURSor:POST1 <value>

Applicable Models: All with TDR Options (S9x011A/B)

(Read-Write) This command sets the emphasis post1 level.

Parameters

<num> Channel number of the measurement. If unspecified, <num> is set to 1.

<value> Post1 level value. The range is -20 dB to +20 dB.

Examples

```
CALC:TDR:EMPH:CURS:POST1 3  
calculate2:tdr:emphasis:cursor:post1 3
```

Query Syntax CALCulate<num>:TDR:EMPHasis:CURSor:POST1?

Return Type Double

Default 0

CALCulate<num>:TDR:EMPHasis:CURSor:POST2 <value>

Applicable Models: All with TDR Options (S9x011A/B)

(Read-Write) This command sets the emphasis post2 level.

Parameters

- <num>** Channel number of the measurement. If unspecified, <num> is set to 1.
- <value>** Post2 level value. The range is -20 dB to +20 dB.

Examples

```
CALC:TDR:EMPH:CURSOR:POST2 3  
calculate2:tdr:emphasis:cursor:post2 3
```

Query Syntax CALCulate<num>:TDR:EMPHasis:CURSor:POST2?

Return Type Double

Default 0

CALCulate<num>:TDR:EMPHasis:CURSor:PRE1 <value>

Applicable Models: All with TDR Options (S9x011A/B)

(Read-Write) This command sets the emphasis pre1 level.

Parameters

- <num>** Channel number of the measurement. If unspecified, <num> is set to 1.
- <value>** Pre1 level value. The range is -20 dB to +20 dB.

Examples

```
CALC:TDR:EMPH:CURSOR:PRE1 2  
calculate2:tdr:emphasis:cursor:pre1 2
```

Query Syntax CALCulate<num>:TDR:EMPHasis:CURSor:PRE1?

Return Type Double

Default 0

CALCulate<num>:TDR:EMPHasis:STATE <bool>

Applicable Models: All with TDR Options (S9x011A/B)

(Read-Write) Turns the emphasis function state ON or OFF.

Parameters

- <num>** Channel number of the measurement. If unspecified, <num> is set to 1.
- <bool>** ON or 1 - Turns emphasis ON.
OFF or 0 - Turns emphasis OFF.

Examples

```
CALC:TDR:EMPH:STAT ON  
calculate2:tdr:emphasis:state off
```

Query Syntax CALCulate<num>:TDR:EMPHasis:STATE?

Return Type Boolean

Default OFF

CALCulate<cnum>:TDR:EQUalization:CTLE:DC <value>

Applicable Models: All with TDR Options (S9x011A/B)

(Read-Write) This command sets the equalization CTLE (Continuous Time Linear Equalization) DC gain parameter.

Parameters

<cnum> Channel number of the measurement. If unspecified, <cnum> is set to 1.
<value> CTLE value. The range is 0 to 10.

Examples

```
CALC:TDR:EQU:CTLE:DC 0.077  
calculate2:tdr:equalization:ctle:dc 0.077
```

Query Syntax CALCulate<cnum>:TDR:EQUalization:CTLE:DC?

Return Type Double

Default 0.667

CALCulate<cnum>:TDR:EQUalization:CTLE:POLE1 <value>

Applicable Models: All with TDR Options (S9x011A/B)

(Read-Write) This command sets the equalization CTLE (Continuous Time Linear Equalization) Pole1 parameter.

Parameters

<cnum> Channel number of the measurement. If unspecified, <cnum> is set to 1.
<value> CTLE value. The range is 0 to 76E9 in Hz.

Examples

```
CALC:TDR:EQU:CTLE:POLE1 2E9  
calculate2:tdr:equalization:ctle:pole1 2e9
```

Query Syntax CALCulate<cnum>:TDR:EQUalization:CTLE:POLE1?

Return Type Double

Default 1.95E9

CALCulate<cnum>:TDR:EQUalization:CTLE:POLE2 <value>

Applicable Models: All with TDR Options (S9x011A/B)

(Read-Write) This command sets the equalization CTLE (Continuous Time Linear Equalization) Pole2 parameter.

Parameters	
<cnum>	Channel number of the measurement. If unspecified, <cnum> is set to 1.
<value>	CTLE value. The range is 0 to 76E9 in Hz.
Examples	<pre>CALC:TDR:EQU:CTLE:POLE2 2E9 calculate2:tdr:equalization:ctle:pole2 2e9</pre>
Query Syntax	CALCulate<cnum>:TDR:EQUalization:CTLE:POLE2?
Return Type	Double
Default	5E9

CALCulate<cnum>:TDR:EQUalization:CTLE:ZERO1 <value>

Applicable Models: All with TDR Options (S9x011A/B)

(Read-Write) This command sets the equalization CTLE (Continuous Time Linear Equalization) zero parameter.

Parameters	
<cnum>	Channel number of the measurement. If unspecified, <cnum> is set to 1.
<value>	CTLE value. The range is 0 to 76E9 in Hz.
Examples	<pre>CALC:TDR:EQU:CTLE:ZERO1 650E6 calculate2:tdr:equalization:ctle:zero1 650e6</pre>
Query Syntax	CALCulate<cnum>:TDR:EQUalization:CTLE:ZERO1?
Return Type	Double
Default	650E6

CALCulate<cnum>:TDR:EQUalization:FILEname <file>

Applicable Models: All with TDR Options (S9x011A/B)

(Read-Write) This command sets the filename of the equalization equation user file. It is necessary to select the file using `CALCulate:TDR:EQUalization:TYPE` and turn ON the `:CALCulate:TDR:EQUalization:STATe`. This file is saved with `.csv` extension.

Specify the file name with the extension. When you use directory names (folder names) and file name, separate them with `"\"` (back slash), or `"/` (slash).

Parameters

- <num>** Channel number of the measurement. If unspecified, `<num>` is set to 1.
- <file>** Filename up to 254 characters.

Examples

```
CALC:TDR:EQU:FIL "C:\folder\User.csv"  
calculate2:tdr:equalization:filename "C:\folder\User.csv"
```

Query Syntax

`CALCulate<num>:TDR:EQUalization:FILEname?`

Return Type

String

Default

`" "` (Empty String)

CALCulate<num>:TDR:EQUalization:STATe <bool>

Applicable Models: All with TDR Options (S9x011A/B)

(Read-Write) Turns the equalization function state ON or OFF.

Parameters

- <num>** Channel number of the measurement. If unspecified, `<num>` is set to 1.
- <bool>** ON or 1 - Turns equalization ON.
OFF or 0 - Turns equalization OFF.

Examples

```
CALC:TDR:EQU:STAT ON  
calculate2:tdr:equalization:state off
```

Query Syntax

`CALCulate<num>:TDR:EQUalization:STATe?`

Return Type

Boolean

Default

OFF

CALCulate<num>:TDR:EQUalization:TYPE <enum>

Applicable Models: All with TDR Options (S9x011A/B)

(Read-Write) This command sets the equalization type.

Parameters

<cnum> Channel number of the measurement. If unspecified, <cnum> is set to 1.

<enum> Equalization type. Choose from:

EQUation - Option to enter values for equation calculation.

USER - Load user file.

Examples

```
CALC:TDR:EQU:TYPE EQU  
calculate2:tdr:equalization:type equation
```

Query Syntax CALCulate<cnum>:TDR:EQUalization:TYPE?

Return Type Double

Default EQUation

CALCulate<cnum>:TDR:EYE:EXECute

Applicable Models: All with TDR Options (S9x011A/B)

(Write-only) This command performs the calculation for the simulated eye diagram for the active trace.

Parameters

<cnum> Channel number of the measurement. If unspecified, <cnum> is set to 1.

Example

```
CALC:TDR:EYE:STAT ON  
CALC:PAR:MNUM:SEL 3  
CALC:TDR:EYE:EXEC
```

CALCulate<cnum>:TDR:EYE:INPut:BPATtern:LENGth <value>

Applicable Models: All with TDR Options (S9x011A/B)

(Read-Write) This command sets the bits' power of 2 for a PRBS pattern. This value is used only when the selected bit pattern type is PRBS.

Parameters

<num> Channel number of the measurement. If unspecified, <num> is set to 1.

<value> Bit pattern power of 2. The range is 3 to 15 (resolution is 1).

Examples

```
CALC:TDR:EYE:INP:BPAT:TYPE PRBS
```

```
CALC:TDR:EYE:INP:BPAT:LENG 7
```

Query Syntax

CALCulate<num>:TDR:EYE:INPut:BPATtern:LENGth?

Return Type

Integer

Default

7

CALCulate<num>:TDR:EYE:INPut:BPATtern:TYPE <enum>

Applicable Models: All with TDR Options (S9x011A/B)

(Read-Write) This command sets the bit pattern type for the simulated eye function.

Parameters

<num> Channel number of the measurement. If unspecified, <num> is set to 1.

<enum> Eye pattern type. Choose from:

PRBS - Pseudo-Random Bit Sequence.

K285 - K 28.5.

USER - Custom user-defined pattern.

STAT - Statistical calculation.

Examples

```
CALC:TDR:EYE:INP:BPAT:TYPE K285
```

```
calculate2:tdr:eye:input:bpattern:type k285
```

Query Syntax

CALCulate<num>:TDR:EYE:INPut:BPATtern:TYPE?

Return Type

String

Default

PRBS

CALCulate<num>:TDR:EYE:INPut:DRATe <value>

Applicable Models: All with TDR Options (S9x011A/B)

(Read-Write) This command sets the bit rate in bits/sec for the simulated eye function.

Parameters

- <num>** Channel number of the measurement. If unspecified, <num> is set to 1.
- <value>** Bit rate in bits/sec. The range is 1.21M to 60.8G.

Examples

```
CALC:TDR:EYE:INP:DRAT 1.1E9  
calculate2:tdr:eye:input:drate 1.1e9
```

Query Syntax CALCulate<num>:TDR:EYE:INPut:DRATe?

Return Type Double

Default 1G

CALCulate<num>:TDR:EYE:INPut:JITTer:DLIMit <value>

Applicable Models: All with TDR Options (S9x011A/B)

(Read-Write) This command sets the display limit value.

Parameters

- <num>** Channel number of the measurement. If unspecified, <num> is set to 1.
- <value>** Display limit value. The range is 0 to 1.

Examples

```
CALC:TDR:EYE:INP:JITT:DLIM 0  
calculate2:tdr:eye:input:jitter:dlimit 0
```

Query Syntax CALCulate<num>:TDR:EYE:INPut:JITTer:DLIMit?

Return Type Double

Default 1-E-9

CALCulate<num>:TDR:EYE:INPut:JITTer:PERiodic:FREQUency <value>

Applicable Models: All with TDR Options (S9x011A/B)

(Read-Write) This command sets the periodic jitter frequency. This value is used only when the periodic jitter function type is selected.

Parameters

- <num>** Channel number of the measurement. If unspecified, <num> is set to 1.
- <value>** Periodic jitter frequency in Hz. The range is 0 to TDR eye jitter max frequency.

Examples

```
CALC:TDR:EYE:INP:JITT:PER:FREQ 0  
calculate2:tdr:eye:input:jitter:periodic:frequency 0
```

Query Syntax CALCulate<num>:TDR:EYE:INPut:JITTer:PERiodic:FREQUency?

Return Type Double

Default 500E3

CALCulate<cnum>:TDR:EYE:INPut:JITTer:PERiodic:MAGNitude <value>

Applicable Models: All with TDR Options (S9x011A/B)

(Read-Write) This command sets the periodic jitter magnitude in rms. This value is used only when periodic jitter function type is selected.

Parameters

<cnum> Channel number of the measurement. If unspecified, <cnum> is set to 1.
<value> Periodic jitter magnitude. The range is 0 to 1 UI.

Examples

```
CALC:TDR:EYE:INP:JITT:TYPE:PER  
CALC:TDR:EYE:INP:JITT:PER:MAGN 0.5
```

Query Syntax CALCulate<cnum>:TDR:EYE:INPut:JITTer:PERiodic:MAGNitude?

Return Type Double

Default 0

CALCulate<cnum>:TDR:EYE:INPut:JITTer:RANDom:MAGNitude <value>

Applicable Models: All with TDR Options (S9x011A/B)

(Read-Write) This command sets the random jitter magnitude in rms. This value is used only when random jitter function type is selected.

Parameters

<cnum> Channel number of the measurement. If unspecified, <cnum> is set to 1.
<value> Random jitter magnitude. The range is 0 to 0.25 UI.

Examples

```
CALC:TDR:EYE:INP:JITT:TYPE:RAND  
CALC:TDR:EYE:INP:JITT:RAND:MAGN 0.05
```

Query Syntax CALCulate<cnum>:TDR:EYE:INPut:JITTer:RANDom:MAGNitude?

Return Type Double

Default 0

CALCulate<cnum>:TDR:EYE:INPut:JITTer:STATe <bool>

Applicable Models: All with TDR Options (S9x011A/B)

(Read-Write) Turns the jitter function state with simulated eye ON or OFF.

Parameters

- <cnum>** Channel number of the measurement. If unspecified, <cnum> is set to 1.
- <bool>** ON or 1 - Turns jitter ON.
OFF or 0 - Turns jitter OFF.

Examples

```
CALC:TDR:EYE:INP:JITT:STAT ON  
calculate2:tdr:eye:input:jitter:state off
```

Query Syntax CALCulate<cnum>:TDR:EYE:INPut:JITTer:STATe?

Return Type Boolean

Default OFF

CALCulate<cnum>:TDR:EYE:INPut:JITTer:TYPE <enum>

Applicable Models: All with TDR Options (S9x011A/B)

(Read-Write) This command sets the jitter function type for the simulated eye function.

Parameters

- <cnum>** Channel number of the measurement. If unspecified, <cnum> is set to 1.
- <enum>** Jitter type. Choose from:

RANDom - Random jitter function.

PERiodic - Periodic jitter function.

Examples

```
CALC:TDR:EYE:INP:JITT:TYPE RAND  
calculate2:tdr:eye:input:jitter:type random
```

Query Syntax CALCulate<cnum>:TDR:EYE:INPut:JITTer:TYPE?

Return Type String

Default PERiodic

CALCulate<cnum>:TDR:EYE:INPut:OLEVel <value>

Applicable Models: All with TDR Options (S9x011A/B)

(Read-Write) This command sets the voltage level for bit "1" for the simulated eye function.

Parameters

<num> Channel number of the measurement. If unspecified, <num> is set to 1.
<value> Level for bit "1". The range is -5 V to +5 V.

Examples

```
CALC:TDR:EYE:INP:OLEV 100E-3  
calculate2:tdr:eye:input:olevel 100e-3
```

Query Syntax CALCulate<num>:TDR:EYE:INPut:OLEVel?

Return Type Double

Default 0.2

CALCulate<num>:TDR:EYE:INPut:RTIME:DATA <value>

Applicable Models: All with TDR Options (S9x011A/B)

(Read-Write) This command sets the rise time value for the simulated eye function.

Parameters

<num> Channel number of the measurement. If unspecified, <num> is set to 1.
<value> Rise time for simulated eye function in seconds.

Examples

```
CALC:TDR:EYE:INP:RTIM:DATA 90E-12  
calculate2:tdr:eye:input:rtime:data 90e-12
```

Query Syntax CALCulate<num>:TDR:EYE:INPut:RTIME:DATA?

Return Type Double

Default 35E-12

CALCulate<num>:TDR:EYE:INPut:RTIME:THReshold <enum>

Applicable Models: All with TDR Options (S9x011A/B)

(Read-Write) This command sets the rise time threshold for the simulated eye.

Parameters

<num> Channel number of the measurement. If unspecified, <num> is set to 1.

<enum> Threshold levels. Choose from:

T1_9 - 10% to 90%.

T2_8 - 20% to 80%.

Examples

```
CALC:TDR:EYE:INP:RTIM:THR T1_9  
calculate2:tdr:eye:input:rtime:threshold t1_9
```

Query Syntax CALCulate<num>:TDR:EYE:INPut:RTIME:THReshold?

Return Type String

Default T1_9

CALCulate<num>:TDR:EYE:INPut:ZLEVel <value>

Applicable Models: All with TDR Options (S9x011A/B)

(Read-Write) This command sets the voltage level for bit "0" for the simulated eye function.

Parameters

<num> Channel number of the measurement. If unspecified, <num> is set to 1.

<value> Voltage level for bit "0". The range is -5 V to +5 V.

Examples

```
CALC:TDR:EYE:INP:ZLEV 100E-3  
calculate2:tdr:eye:input:zlevel 100e-3
```

Query Syntax CALCulate<num>:TDR:EYE:INPut:ZLEVel?

Return Type Double

Default 0

CALCulate<num>:TDR:EYE:MASK:FAIL?

Applicable Models: All with TDR Options (S9x011A/B)

(Read-only) This command returns the mask test result.

Parameters

<num> Channel number of the measurement. If unspecified, <num> is set to 1.

Examples

```
CALC:TDR:EYE:MASK:FAIL?  
calculate2:tdr:eye:mask:fail?
```

Return Type

Boolean

ON or 1 - Mask test fail.

OFF or 0 - Mask test pass.

Default

Not Applicable

CALCulate<num>:TDR:EYE:MASK:STATE <bool>

Applicable Models: All with TDR Options (S9x011A/B)

(Read-Write) Turns the mask test function state with simulated eye ON or OFF.

Parameters

<num> Channel number of the measurement. If unspecified, <num> is set to 1.

<bool> ON or 1 - Turns mask test ON.

OFF or 0 - Turns mask test OFF.

Examples

```
CALC:TDR:EYE:MASK:STAT ON  
calculate2:tdr:eye:mask:state off
```

Query Syntax

CALCulate<num>:TDR:EYE:MASK:STATE?

Return Type

Boolean

Default

OFF

CALCulate<num>:TDR:EYE:RESults:DATA?

Applicable Models: All with TDR Options (S9x011A/B)

(Read-only) This command returns the results of the eye measurement. There are 18 values returned. The minimum and maximum values are returned in addition to the displayed results (16 values) on the TDR application GUI.

Parameters

<num> Channel number of the measurement. If unspecified, <num> is set to 1.

Examples

```
CALC:TDR:EYE:RESults:DATA?  
calculate2:tdr:eye:results:data?
```

Return Type

Variant Array

Default

Not Applicable

CALCulate<cnum>:TDR:EYE:RESulsts:DISPlay:STATe <bool>

Applicable Models: All with TDR Options (S9x011A/B)

(Read-Write) Turns the overlay ON or OFF.

Parameters

- <cnum>** Channel number of the measurement. If unspecified, <cnum> is set to 1.
<bool> ON or 1 - Turns overlay ON.
OFF or 0 - Turns overlay OFF.

Examples

```
CALC:TDR:EYE:RES:DISP:STAT ON  
calculate2:tdr:eye:results:display:state off
```

Query Syntax CALCulate<cnum>:TDR:EYE:RESulsts:DISPlay:STATe?

Return Type Boolean

Default ON

CALCulate<cnum>:TDR:EYE:RESulsts:THReshold <enum>

Applicable Models: All with TDR Options (S9x011A/B)

(Read-Write) This command sets the rise time threshold level for the results of eye measurement.

Parameters

- <cnum>** Channel number of the measurement. If unspecified, <cnum> is set to 1.
<enum> Threshold levels. Choose from:
T1_9 - 10% to 90%.
T2_8 - 20% to 80%.

Examples

```
CALC:TDR:EYE:RES:THR T1_9  
calculate2:tdr:eye:results:threshold t1_9
```

Query Syntax CALCulate<cnum>:TDR:EYE:RESulsts:THReshold?

Return Type String

Default T1_9

CALCulate<cnum>:TDR:EYE:STATe <bool>

Applicable Models: All with TDR Options (S9x011A/B)

(Read-Write) Turns the Eye/Mask window ON or OFF.

Parameters

<num> Channel number of the measurement. If unspecified, <num> is set to 1.
<bool> ON or 1 - Turns Eye/Mask window ON.
OFF or 0 - Turns Eye/Mask window OFF.

Examples

```
CALC:TDR:EYE:STAT ON  
calculate2:tdr:eye:state off
```

Query Syntax CALCulate<num>:TDR:EYE:STATE?

Return Type Boolean

Default OFF

CALCulate<num>:TDR:MEASure[1-16]:ACTive:MARKer <value>

Applicable Models: All with TDR Options (S9x011A/B)

(Read-Write) This command sets active marker number.

Parameters

<num> Channel number of the measurement. If unspecified, <num> is set to 1.
<value> Marker number to activate. The range is 0 to 10.

Examples

```
CALC:TDR:MEAS1:ACT:MARK 1  
calculate2:tdr:measure1:active:marker 1
```

Query Syntax CALCulate<num>:TDR:MEASure[1-16]:ACTive:MARKer?

Return Type Integer

Default 0

CALCulate<num>:TDR:MEASure[1-16]:DTIME:DATA?

Applicable Models: All with TDR Options (S9x011A/B)

(Read-only) This command returns the delta time result value. You can get the result even if CALCulate:TDR:MEASure:DTIME:STATE is off.

Parameters

<num> Channel number of the measurement. If unspecified, <num> is set to 1.

Examples

```
CALC:TDR:MEAS1:DTIM:DATA?  
calculate2:tdr:measure1:dtim:data?
```

Return Type Double

Default Not Applicable

CALCulate<cnum>:TDR:MEASure[1-16]:DTIME:POSition <value>

Applicable Models: All with TDR Options (S9x011A/B)

(Read-Write) This command sets delta time reference position.

Parameters

- <cnum>** Channel number of the measurement. If unspecified, <cnum> is set to 1.
<value> Delta time reference position. The range is 0 to 100.

Examples

```
CALC:TDR:MEAS1:DTIM:POS 0  
calculate2:tdr:measure1:dtim:position 0
```

Query Syntax CALCulate<cnum>:TDR:MEASure[1-16]:DTIME:POSition?

Return Type Double

Default 50

CALCulate<cnum>:TDR:MEASure[1-16]:DTIME:STATe <bool>

Applicable Models: All with TDR Options (S9x011A/B)

(Read-Write) Turns the delta time marker in the marker search ON or OFF.

Parameters

- <cnum>** Channel number of the measurement. If unspecified, <cnum> is set to 1.
<bool> ON or 1 - Turns delta time marker ON.
OFF or 0 - Turns delta time marker OFF.

Examples

```
CALC:TDR:MEAS1:DTIM:STAT ON  
calculate2:tdr:measure1:dtim:state off
```

Query Syntax CALCulate<cnum>:TDR:MEASure[1-16]:DTIME:STATe?

Return Type Boolean

Default OFF

CALCulate<cnum>:TDR:MEASure[1-16]:DTIME:TARGet <value>

Applicable Models: All with TDR Options (S9x011A/B)

(Read-Write) This command sets the target trace number for the delta time function. The MEASure[1-16] is the trace number starting point for delta time. The <value> is the trace number stopping point for delta time.

Parameters

- <cnum> Channel number of the measurement. If unspecified, <cnum> is set to 1.
- <value> Trace number stopping point for delta time. The range is 1 to 16.

Examples

```
CALC:TDR:MEAS1:DTIM:TARG 5  
calculate2:tdr:measure1:dtime:target 5
```

Query Syntax

CALCulate<cnum>:TDR:MEASure[1-16]:DTIME:TARGet?

Return Type

Integer

Default

1

CALCulate<cnum>:TDR:MEASure[1-16]:FORMat <enum>

Applicable Models: All with TDR Options (S9x011A/B)

(Read-Write) This command sets the trace format.

Parameters

- <cnum> Channel number of the measurement. If unspecified, <cnum> is set to 1.
- <enum> Trace format.

For S-Parameter measurements, choose from:

MLINear

MLOGarithmic

PHASe

UPHase

IMAGinary

REAL

POLar

SMITH

SADMittance

SWR
GDElay
KELVin|
FAHRenheit
CELSius
PPHase
IMPedance
VOLT

For Time Domain measurements, choose from:

IMPedance
VOLT
MLOGarithmic
MLINear
REAL

Examples

```
CALC:TDR:MEAS1:FORM IMP  
calculate2:tdr:measure1:format impedance
```

Query Syntax CALCulate<cnum>:TDR:MEASure[1-16]:FORMat?

Return Type String

Default MLINear

CALCulate<cnum>:TDR:MEASure[1-16]:MARKer:REFerence[:STATe] <ON | OFF>

Applicable Models: All with TDR Options (S9x011A/B)

(Read-Write) Turns the reference marker ON or OFF.

Parameters

<num> Channel number of the measurement. There must be a selected measurement on that channel. If unspecified, <num> is set to 1.

<ON | OFF> **ON** (or 1) - turns reference marker ON

OFF (or 0) - turns reference marker ON

Examples

```
CALC:TDR:MEAS1:MARK:REF ON  
calculate2:tdr:measure1:marker:reference:state OFF
```

Query Syntax CALCulate<num>:TDR:MEASure[1-16]:MARKer:REFerence[:STATe]?

Return Type Boolean

Default OFF

CALCulate<num>:TDR:MEASure[1-16]:MARKer<mkr>[:STATe] <ON|OFF>

Applicable Models: All with TDR Options (S9x011A/B)

(Read-Write) Turns the specified marker ON or OFF.

Parameters

<num> Channel number of the measurement. There must be a selected measurement on that channel. If unspecified, <num> is set to 1.

<mkr> Any marker number from 1 to 15; if unspecified, value is set to 1.

<ON|OFF> **ON** (or 1) - turns marker ON.

OFF (or 0) - turns marker OFF.

Examples

```
CALC:TDR:MEAS:MARK ON  
calculate2:tdr:measure2:marker8 on
```

Query Syntax CALCulate<num>:TDR:MEASure[1-16]:MARKer<mkr>:STATe?

Return Type Boolean

Default Off

CALCulate<num>:TDR:MEASure[1-16]:PARAmeter <string>

Applicable Models: All with TDR Options (S9x011A/B)

(Read-Write) This command sets the measurement parameter.

Parameters

<num> Channel number of the measurement. If unspecified, <num> is set to 1.

<string> Measurement parameter.

For S-Parameter measurements::

Sxy

Sddxy

Sdcxy

Scdxy

Sccxy

X: 1 to 4

Y: 1 to 4

For Time Domain measurements:

Txy

Tddxy

Tdcxy

Tcdxy

Tccxy

Examples

```
CALC:TDR:MEAS1:PAR T11  
calculate2:tdr:measure1:parameter t11
```

Query Syntax CALCulate<num>:TDR:MEASure[1-16]:PARAmeter?

Return Type String

Default S11

CALCulate<num>:TDR:MEASure[1-16]:PEELing:STATe <bool>

Applicable Models: All with TDR Options (S9x011A/B)

(Read-Write) This command sets state for the peeling function.

Parameters

- <num>** Channel number of the measurement. If unspecified, <num> is set to 1.
- <bool>** ON or 1 - Turns peeling function ON.
OFF or 0 - Turns peeling function OFF.

Examples

```
CALC:TDR:MEAS1:PEEL:STAT ON  
calculate2:tdr:measure1:peeling:state off
```

Query Syntax CALCulate<num>:TDR:MEASure[1-16]:PEELing:STATe?

Return Type Boolean

Default OFF

CALCulate<num>:TDR:MEASure[1-16]:SMOothing:STATe <bool>

Applicable Models: All with TDR Options (S9x011A/B)

(Read-Write) This command sets state for the smoothing function.

Parameters

- <num>** Channel number of the measurement. If unspecified, <num> is set to 1.
- <bool>** ON or 1 - Turns smoothing function ON.
OFF or 0 - Turns smoothing function OFF.

Examples

```
CALC:TDR:MEAS1:SMO:STAT ON  
calculate2:tdr:measure1:smoothing:state off
```

Query Syntax CALCulate<num>:TDR:MEASure[1-16]:SMOothing:STATe?

Return Type Boolean

Default OFF

CALCulate<num>:TDR:MEASure[1-16]:TIME:IMPulse:WIDTh <value>

Applicable Models: All with TDR Options (S9x011A/B)

(Read-Write) This command sets the impulse width value for the transform function.

Parameters

- <num>** Channel number of the measurement. If unspecified, <num> is set to 1.
- <value>** Transform function impulse width value.

Examples

```
CALC:TDR:MEAS1:TIME:IMP:WIDTh 17E-12  
calculate2:tdr:measure1:time:impulse:width 17e-12
```

Query Syntax CALCulate<num>:TDR:MEASure[1-16]:TIME:IMPulse:WIDTh?

Return Type Double

Default 0

CALCulate<cnum>:TDR:MEASure[1-16]:TIME:STEP:RTIME <value>**Applicable Models:** All with TDR Options (S9x011A/B)**(Read-Write)** This command sets rise time value for the transform function.**Parameters**

<cnum> Channel number of the measurement. If unspecified, <cnum> is set to 1.

<value> Transform function rise time value in seconds.

Examples

```
CALC:TDR:MEAS1:TIME:STEP:RTIM 0  
calculate2:tdr:measure1:time:step:rtime 0
```

Query Syntax CALCulate<cnum>:TDR:MEASure[1-16]:TIME:STEP:RTIME?**Return Type** Double**Default** 0

CALCulate<cnum>:TDR:MEASure[1-16]:TIME:STEP:RTIME:THReshold <enum>**Applicable Models:** All with TDR Options (S9x011A/B)**(Read-Write)** This command sets the rise time threshold level for the results of eye measurement.**Parameters**

<cnum> Channel number of the measurement. If unspecified, <cnum> is set to 1.

<enum> Transform function rise time threshold levels. Choose from:

T1_9 - 10% to 90%.**T2_8** - 20% to 80%.**Examples**

```
CALC:TDR:MEAS1:TIME:STEP:RTIM:THR T1_9  
calculate2:tdr:measure1:time:step:rtime:threshold t1_9
```

Query Syntax CALCulate<cnum>:TDR:MEASure[1-16]:TIME:STEP:RTIME:THReshold?**Return Type** String**Default** T1_9

CALCulate<cnum>:TDR:MEASure[1-16]:TIME:TYPE <enum>

Applicable Models: All with TDR Options (S9x011A/B)

(Read-Write) This command sets the stimulus type for the transform function.

Parameters

<num> Channel number of the measurement. If unspecified, <num> is set to 1.

<enum> Transform function stimulus type. Choose from:

LPSTep - Low pass step.

LPIMPulse -Low pass impulse.

Examples

```
CALC:TDR:MEAS1:TIME:TYPE LPST  
calculate2:tdr:measure1:time:type lpstep
```

Query Syntax CALCulate<num>:TDR:MEASure[1-16]:TIME:TYPE?

Return Type String

Default LPSTep

CALCulate<num>:TDR:MEASure[1-16]:TTIME:DATA?

Applicable Models: All with TDR Options (S9x011A/B)

(Read-only) This command returns the rise time result value for marker search. You can get the data even if CALCulate:TDR:MEASure:TTIME:STATe is off.

Parameters

<num> Channel number of the measurement. If unspecified, <num> is set to 1.

Examples

```
CALC:TDR:MEAS1:TTIM:DATA?  
calculate2:tdr:measure1:ttime:data?
```

Return Type Double

Default Not Applicable

CALCulate<num>:TDR:MEASure[1-16]:TTIME:STATe <bool>

Applicable Models: All with TDR Options (S9x011A/B)

(Read-Write) This command displays the rise time marker.

Parameters

- <cnun>** Channel number of the measurement. If unspecified, <cnun> is set to 1.
- <bool>** ON or 1 - Turns rise time marker ON.
OFF or 0 - Turns rise time marker OFF.

Examples

```
CALC:TDR:MEAS1:TTIM:STAT ON  
calculate2:tdr:measure1:ttime:state off
```

Query Syntax CALCulate<cnun>:TDR:MEASure[1-16]:TTIME:STATe?

Return Type Boolean

Default OFF

CALCulate<cnun>:TDR:MEASure[1-16]:TTIME:THReshold <enum>

Applicable Models: All with TDR Options (S9x011A/B)

(Read-Write) This command sets the rise time threshold for the rise time in the marker search function.

Parameters

- <cnun>** Channel number of the measurement. If unspecified, <cnun> is set to 1.
- <enum>** Rise time threshold levels. Choose from:

T1_9 - 10% to 90%.

T2_8 - 20% to 80%.

Examples

```
CALC:TDR:MEAS1:TTIM:THR T1_9  
calculate2:tdr:measure1:ttime:threshold t1_9
```

Query Syntax CALCulate<cnun>:TDR:MEASure[1-16]:TTIME:THReshold?

Return Type String

Default T1_9

CALCulate<cnun>:TDR:TIME:COUPlE <bool>

Applicable Models: All with TDR Options (S9x011A/B)

(Read-Write) This command enables/disables time coupling.

Parameters

<num> Channel number of the measurement. If unspecified, <num> is set to 1.
<bool> ON or 1 - Turns time coupling ON.
OFF or 0 - Turns time coupling OFF.

Examples

```
CALC:TDR:TIME:COUP ON  
calculate2:tdr:time:couple off
```

Query Syntax CALCulate<num>:TDR:TIME:COUPLE?

Return Type Boolean

Default ON

CALCulate<num>:TDR:TIME:STEP:AMPLitude <value>

Applicable Models: All with TDR Options (S9x011A/B)

(Read-Write) This command sets or gets the step amplitude value.

Parameters

<num> Channel number of the measurement. If unspecified, <num> is set to 1.
<value> Step amplitude value in Hz, dBm, or seconds. The range is 0.001 to 5.

Examples

```
CALC:TDR:TIME:STEP:AMPL 200ms  
calculate2:tdr:time:step:amplitude .05s
```

Query Syntax CALCulate<num>:TDR:TIME:STEP:AMPLitude?

Return Type Double

Default 0.2

CALC:HOLD Commands

Controls the Trace Hold settings.

These commands are **Superseded** by the `CALCulate:MEASure:HOLD` commands.

CALCulate:HOLD
TYPE
CLEAr

Click on a keyword to view the command details.

see Also

- [Learn about Trace Hold](#)
- [Example Programs](#)
- [Synchronizing the Analyzer and Controller](#)
- [SCPI Command Tree](#)

Critical Note: CALCulate commands act on the selected measurement. You can select one measurement for each channel using `Calc:Par:MNUM` or `Calc:Par>Select`. [Learn more](#).

CALCulate<cnum>:HOLD:TYPE <char>

Applicable Models: N522xB, N523xB, N524xB, M937xA, P937xA

(Read-Write) Sets the type of trace hold to perform.

[See Critical Note](#)

Parameters

<cnum> Channel number of the measurement. There must be a selected measurement on that channel. If unspecified, <cnum> is set to 1.

<char> Trace Hold type. Choose from:

OFF - Disables the Trace Hold feature.

MINimum - Sets Trace Hold to store the lowest measured data points.

MAXimum - Sets Trace Hold to store the highest measured data points.

Examples

```
CALC:HOLD:TYPE MAX  
calculate2:hold:type minimum
```

Query Syntax CALCulate<ch>:HOLD:TYPE?

Return Type Character

Default OFF

CALCulate<cnum>:HOLD:CLEar

Applicable Models: N522xB, N523xB, N524xB, M937xA, P937xA

(Write-only) Resets the currently-stored data points to the live data trace and restarts the currently-selected Trace Hold type.

See Critical Note

Parameters

<cnum> Channel number of the measurement. There must be a selected measurement on that channel. If unspecified, <cnum> is set to 1.

Examples

```
CALC:HOLD:CLE  
calculate2:hold:clear
```

Query Syntax Not Applicable

Default Not Applicable

Calculate:Transform Commands

Specifies the settings for time domain transform.

These commands are **Superseded** by the `CALCulate:MEASure:TRANSform` commands.

CALCulate:TRANSform

COUple:

| [PARAmeters](#)

TIME:

| [ALIGnment](#)

| [CENTer](#)

| [IMPulse](#)

| [WIDTh](#)

| [KBESsel](#)

| [LPFRequency](#)

| [MARKer](#)

| [MODE](#)

| [UNIT](#)

| [SPAN](#)

| [START](#)

| [STATe](#)

| [STEP](#)

| [RTIME](#)

| [STIMulus](#)

| [STOP](#)

| [\[:TYPE\]](#)

Click on a keyword to view the command details.

See Also

- [Example Programs](#)
- [Learn about Time Domain](#)
- [Synchronizing the Analyzer and Controller](#)
- [SCPI Command Tree](#)

Critical Note: CALCulate commands act on the selected measurement. You can select one measurement for each channel using [Calc:Par:MNUM](#) or [Calc:Par>Select](#).

CALCulate<cnum>:TRANSform:COUPlE:PARAmeters <num>

Applicable Models: N522xB, N523xB, N524xB, M937xA, P937xA

(Read-Write) Specifies the time domain transform parameters to be coupled. The settings for those parameters will be copied from the selected measurement to all other measurements on the channel.

- To turn coupling ON and OFF, use [SENS:COUP:PAR](#)
- To specify Gating parameters to couple, use [CALC:FILT:COUP:PAR](#)

Learn more about [Time Domain Trace Coupling](#)

See [Critical Note](#)

Parameters

- <cnum> Channel number of the measurement. There must be a selected measurement on that channel. If unspecified, <cnum> is set to 1.
- <num> (Numeric) Parameters to couple. To specify more than one parameter, add the numbers.
- 1** - Transform Stimulus (Start, Stop, Center, and Span TIME settings.)
 - 2** - Transform State (ON / OFF)
 - 4** - Transform Window (Kaiser Beta / Impulse Width)
 - 8** - Transform Mode (Low Pass Impulse, Low Pass Step, Band Pass)
 - 16** - Transform Distance Marker Units

Examples

```
'To couple all parameters:
CALC:TRAN:COUP:PAR 31

'To couple Stimulus and Mode:
calculate2:transform:couple:parameters 9
```

Query Syntax CALCulate<cnum>:TRANSform:COUPle:PARameters?**Return Type** Numeric**Default** 29 (All parameters except 2 - Transform State)**CALCulate<cnum>:TRANSform:TIME:CENTer <num>****Applicable Models:** N522xB, N523xB, N524xB, M937xA, P937xA**(Read-Write)** Sets the center time for time domain measurements.See [Critical Note](#)**Parameters**

<cnum> Channel number of the measurement. There must be a selected measurement on that channel. If unspecified, <cnum> is set to 1.

<num> Center time in seconds; any number between:
 $\pm (\text{number of points}-1) / \text{frequency span}$ **Note:** This command will accept **MIN** or **MAX** instead of a numeric parameter. See [SCPI Syntax](#) for more information.**Examples**

```
CALC:TRAN:TIME:CENT 1e-8
calculate2:transform:time:center 15 ps
```

Query Syntax CALCulate<cnum>:TRANSform:TIME:CENTer?**Return Type** Numeric**Default** 0**CALCulate<cnum>:TRANSform:TIME:IMPulse:WIDTh <num>**

Applicable Models: N522xB, N523xB, N524xB, M937xA, P937xA

(Read-Write) Sets the impulse width for the transform window.

See Critical Note

Parameters

- <num> Channel number of the measurement. There must be a selected measurement on that channel. If unspecified, <num> is set to 1.
- <num> Impulse width in seconds; Choose any number between:
.6 / frequency span and 1.39 / frequency span

Examples

```
CALC:TRAN:TIME:IMP:WIDTH 10  
calculate2:transform:time:impulse:width 13
```

Query Syntax CALCulate<num>:TRANSform:TIME:IMPulse:WIDTh?

Return Type Numeric

Default .98 / Default Span

CALCulate<num>:TRANSform:TIME:KBESsel <num>

Applicable Models: N522xB, N523xB, N524xB, M937xA, P937xA

(Read-Write) Sets the parametric window for the Kaiser Bessel window.

See Critical Note

Parameters

- <num> Channel number of the measurement. There must be a selected measurement on that channel. If unspecified, <num> is set to 1.
- <num> Window width for Kaiser Bessel in seconds; Choose any number between:
0.0 and 13.0

Examples

```
CALC:TRAN:TIME:KBES 10  
calculate2:transform:time:kbessel 13
```

Query Syntax CALCulate<num>:TRANSform:TIME:KBESsel?

Return Type Numeric

Default 6

CALCulate<num>:TRANSform:TIME:LPFREQuency

Applicable Models: N522xB, N523xB, N524xB, M937xA, P937xA

(Write-only) Sets the start frequencies in LowPass Mode.

See Critical Note

Parameters

<num> Channel number of the measurement. There must be a selected measurement on that channel. If unspecified, <num> is set to 1.

Examples

```
CALC:TRAN:TIME:LPFR  
calculate2:transform:time:lpfrequency
```

Query Syntax Not applicable

Default Not applicable

CALCulate<num>:TRANSform:TIME:MARKer:MODE <char>

Applicable Models: N522xB, N523xB, N524xB, M937xA, P937xA

(Read-Write) Specifies the measurement type in order to determine the correct marker distance.

- Select Auto for S-Parameter measurements.
- Select Reflection or Transmission for arbitrary ratio or unratiod measurements.

This setting affects the display of ALL markers for only the ACTIVE measurement.

Learn more about [Distance Markers](#).

See Critical Note

Parameters

<num> Channel number of the measurement. There must be a selected measurement on that channel. If unspecified, <num> is set to 1.

<char> Choose from:

AUTO If the active measurement is an S-Parameter, automatically chooses reflection or transmission. If non S-Parameter measurements, reflection is chosen.

REFlection Displays the distance from the source to the receiver divided by two (to compensate for the return trip.)

TRANsmission Displays the distance from the source to the receiver.

Examples

```
CALC:TRAN:TIME:MARK:MODE REFL
calculate2:transform:time:marker:mode auto
```

Query Syntax CALCulate<cnum>:TRANSform:TIME:MARKer:MODE?**Return Type** Character**Default** Auto**CALCulate<cnum>:TRANSform:TIME:MARKer:UNIT <char>****Applicable Models:** N522xB, N523xB, N524xB, M937xA, P937xA

(Read-Write) Specifies the unit of measure for the display of marker distance values. This settings affects the display of ALL markers for only the ACTIVE measurement (unless Distance Maker Units are coupled using **CALC:TRAN:COUP:PAR**).

Learn more about [Distance Markers](#).See [Critical Note](#)**Parameters**

<cnum> Channel number of the measurement. There must be a selected measurement on that channel. If unspecified, <cnum> is set to 1.

<char> Choose from:

METRs**FEET****INCH**es**Examples**

```
CALC:TRAN:TIME:MARK:UNIT INCH
calculate2:transform:time:marker:unit feet
```

Query Syntax CALCulate<cnum>:TRANSform:TIME:MARKer:UNIT?**Return Type** Character**Default** METRs**CALCulate<cnum>:TRANSform:TIME:SPAN <num>**

Applicable Models: N522xB, N523xB, N524xB, M937xA, P937xA

(Read-Write) Sets the span time for time domain measurements.

See Critical Note

Parameters

- <num> Channel number of the measurement. There must be a selected measurement on that channel. If unspecified, <num> is set to 1.
- <num> Span time in seconds; any number between:
0 and $2 * [(number\ of\ points - 1) / frequency\ span]$

Note: This command will accept **MIN** or **MAX** instead of a numeric parameter. See **SCPI Syntax** for more information.

Examples

```
CALC:TRAN:TIME:SPAN 1e-8  
calculate2:transform:time:span maximum
```

Query Syntax CALCulate<num>:TRANSform:TIME:SPAN?

Return Type Numeric

Default 20 ns

CALCulate<num>:TRANSform:TIME:STARt <num>

Applicable Models: N522xB, N523xB, N524xB, M937xA, P937xA

(Read-Write) Sets the start time for time domain measurements.

See Critical Note

Parameters

- <num> Channel number of the measurement. There must be a selected measurement on that channel. If unspecified, <num> is set to 1.
- <num> Start time in seconds; any number between:
 $\pm (number\ of\ points - 1) / frequency\ span$

Note: This command will accept **MIN** or **MAX** instead of a numeric parameter. See **SCPI Syntax** for more information.

Examples

```
CALC:TRAN:TIME:STAR 1e-8  
calculate2:transform:time:start minimum
```

Query Syntax CALCulate<num>:TRANSform:TIME:STARt?

Return Type Numeric

Default -10 ns

CALCulate<cnum>:TRANSform:TIME:STATe <ON | OFF>

Applicable Models: N522xB, N523xB, N524xB, M937xA, P937xA

(Read-Write) Turns the time domain transform capability ON or OFF.

See Critical Note

Note: Sweep type must be set to Linear Frequency in order to use Time Domain Transform.

Parameters

<cnum> Channel number of the measurement. There must be a selected measurement on that channel. If unspecified, <cnum> is set to 1.

<ON|OFF> **ON** (or 1) - turns time domain ON.
OFF (or 0) - turns time domain OFF.

Examples

```
CALC:TRAN:TIME:STAT ON  
calculate2:transform:time:state off
```

Query Syntax CALCulate<cnum>:TRANSform:TIME:STATe?

Return Type Boolean (1 = ON, 0 = OFF)

Default OFF

CALCulate<cnum>:TRANSform:TIME:STOP <num>

Applicable Models: N522xB, N523xB, N524xB, M937xA, P937xA

(Read-Write) Sets the stop time for time domain measurements.

See Critical Note

Parameters

<cnum> Channel number of the measurement. There must be a selected measurement on that channel. If unspecified, <cnum> is set to 1.

<num> Stop time in seconds; any number between:
 $\pm (\text{number of points}-1) / \text{frequency span}$

Note: This command will accept **MIN** or **MAX** instead of a numeric parameter. See **SCPI Syntax** for more information.

Examples

```
CALC:TRAN:TIME:STOP 1e-8  
calculate2:transform:time:stop maximum
```

Query Syntax	CALCulate<cnum>:TRANSform:TIME:STOP?
Return Type	Numeric
Default	10 ns

CALCulate<cnum>:TRANSform:TIME:STEP:RTIME <num>

Applicable Models: N522xB, N523xB, N524xB, M937xA, P937xA

(Read-Write) Sets the step rise time for the transform window.

See Critical Note

Parameters

- <cnum> Channel number of the measurement. There must be a selected measurement on that channel. If unspecified, <cnum> is set to 1.
- <num> Rise time in seconds; Choose any number between:
.45 / frequency span and **1.48 / frequency span**

Examples

```
CALC:TRAN:TIME:STEP:RTIM 1e-8
calculate2:transform:time:step:rtime 15 ps
```

Query Syntax	CALCulate<cnum>:TRANSform:TIME:STEP:RTIME?
Return Type	Numeric
Default	.99 / Default Span

CALCulate<cnum>:TRANSform:TIME:STIMulus <char>

Applicable Models: N522xB, N523xB, N524xB, M937xA, P937xA

(Read-Write) Sets the type of simulated stimulus that will be incident on the DUT.

See Critical Note

Parameters

- <cnum> Channel number of the measurement. There must be a selected measurement on that channel. If unspecified, <cnum> is set to 1.
- <char> Choose from:
STEP - simulates a step DUT stimulus
IMPulse - simulates a pulse DUT stimulus

STEP can ONLY be used when **CALC:TRAN:TIME:TYPE** is set to LPASs (Lowpass). (STEP **cannot** be used with TYPE = BPASs.)

:STIM STEP will set **:TYPE** to **LPASs**

:TYPE BPASs will set **:STIM** to **IMPulse**

Examples

```
CALC:TRAN:TIME:STIM STEP  
calculate2:transform:time:stimulus impulse
```

Query Syntax CALCulate<cnum>:TRANSform:TIME:STIMulus?

Return Type Character

Default IMPulse

CALCulate<cnum>:TRANSform:TIME:ALIGNment <enum>

Applicable Models: N522xB, N523xB, N524xB, M937xA, P937xA

(Read-Write) Selects the way the PNA computes the DC value of the frequency-domain measurement. The correct DC value is required for inverse-FFT accuracy, and if not estimated properly, can cause distortions in the time-domain measurement in the form of an undesired slope in the waveform.

See **Critical Note**

Parameters

<cnum> Channel number of the measurements to be listed. If unspecified, <cnum> is set to 1.

<enum> Choose from:

LEGacy - The DC value is extrapolated using three data points. The transform offset is calculated using the delay of the first frequency point. This is the same algorithm used in the HP 8510 network analyzer.

NORMalize - The DC value is extrapolated using three data points. The transform offset is set to zero at $t=0$ minus six rise-times. This mode requires that a good S-parameter calibration has been performed, which can be verified by observing a flat time-domain response at $t=0$ when measuring a load located at the physical point corresponding to $t=0$. Setting the time domain trace to zero at a time before $t=0$ stabilizes the trace for determining impedances after time $t=0$, resulting in improved behavior compared to Legacy mode. This method is similar to that used with PLTS, and is very useful in determining the time-domain-transform response of transmission lines and printed-circuit-board characteristics.

Examples

```
CALC:TRAN:TIME:ALIG NORM  
calculate2:transform:time:alignment?
```

Return Type Enumeration

Default LEGacy

CALCulate<cnum>:TRANSform:TIME[:TYPE] <char>

Applicable Models: N522xB, N523xB, N524xB, M937xA, P937xA

(Read-Write) Sets the type of time domain measurement.

See Critical Note

Parameters

<cnum> Channel number of the measurement. There must be a selected measurement on that channel. If unspecified, <cnum> is set to 1.

<char> Type of measurement. Choose from:
LPASs - Lowpass; Must also send **CALC:TRAN:TIME:LPFRequency** before calibrating.
BPASs - Bandpass;

BPASs can **only** be used when **CALC:TRAN:TIME:STIM** is set to **IMPulse**.
(BPASs **cannot** be used with :STIM = STEP)

:STIM **STEP** will set :TYPE to **LPASs**

:TYPE **BPASs** will set :STIM to **IMPulse**

Examples

```
CALC:TRAN:TIME LPAS  
calculate2:transform:time:type bpas
```

Query Syntax CALCulate<cnum>:TRANSform:TIME[:TYPE]?

Return Type Character

Default BPAS

CALCulate:X (Axis) Commands

Controls the display of X-axis for various measurements.

These commands are **Superseded** by the CALCulate:MEASure:X commands.

```
CALCulate:X:  
  
  AXIS  
  
    | :DOMain  
  
    [:VALues]
```

Click on a keyword to view the command details.

See Also

- [Example Programs](#)
- [Synchronizing the Analyzer and Controller](#)
- [SCPI Command Tree](#)

Critical Note: CALCulate commands act on the selected measurement. You can select one measurement for each channel using Calc:Par:MNUM or Calc:Par:Select. [Learn more.](#)

CALCulate<ch>:X:AXIS <string>

Applicable Models: N522xB, N523xB, N524xB, M937xA, P937xA

(Write-Read) Sets the X-axis of the selected measurement to a DC Source. This command does not change the default setting for new traces.

Parameters

- <ch> Channel number of the selected measurement. If unspecified, value is set to 1.
- <string> String - (Not case-sensitive) For all channels EXCEPT DIQ, choose from the following:
- "Default"** - The default X-axis setting for the selected measurement. For Application measurements, the X-Axis domain is set with specific commands.
- "AO1"** - Internal DC source #1

"AO2" - Internal DC source #2

Note: For DIQ channels, see [CALC:X:AXIS:DOMain](#)

Examples

```
CALC:X:AXIS 'Default'  
calculate:x:axis "AO1"
```

Query Syntax CALCulate<ch>:X:AXIS?

Return Type String

Default "Default"

CALCulate<ch>:X:AXIS:DOMain <string>

Applicable Models: N522xB, N523xB, N524xB

(Write-Read) Sets and returns the X-Axis domain of the selected DIQ measurement.

Parameters

<ch> The Differential IQ channel number. If unspecified, value is set to 1.

Choose one of these:	Then set X-Axis Source (CALC:X:AXIS) using one of these as the argument.
"Frequency"	"F1", "F2", etc.
"Power"	Source port: "Port 1", "Port 2", etc.
"Phase"	Source port: "Port 1", "Port 2", etc.
"DC"	DC Source:"AO1", "AO2"
"Points"	"Points"

Example

1. CALC:X:AXIS:DOM "Power"
2. CALC:X:AXIS "Port 1"

Query Syntax CALCulate<ch>:X:AXIS:DOMain?

Return Type String

Default CALC:X:AXIS:DOMain: "Frequency"

CALC:X:AXIS: "F1"

CALCulate<cnum>:X[:VALues]?

Applicable Models: N522xB, N523xB, N524xB, M937xA, P937xA

(Read-only) Returns the stimulus values for the selected measurement in the current units. You can select one measurement for each channel using **Calc:Par:MNUM** or **Calc:Par:Select**. [Learn more](#).

This command can be used for all Measurement Classes.

Note: To avoid frequency rounding errors, specify **FORM:DATA** <Real,64> or <ASCii, 0>

Parameters

<cnum> Any existing channel number; if unspecified, value is set to 1.

Examples

1. Calc:Par:Sel "MyGCATrace"
2. CALC:X?

Return Type Depends on **FORM:DATA** command

Default Not applicable

CalPod Commands

The following commands are sent as a string argument from:

CONTRol:CALPod:COMMand <string>

CALPod
DISable
ENABle
HIDE
INITialize
ACTive
ALL
LAUNCh
RECorrect
ACTive
ALL
SHOW
STATe
TEMP?

Click on a [blue](#) keyword to view the command details.

In addition to the above Calpod commands, the following IEE 488 Common Commands can also be sent as a string argument:

- ***CLS** - Clears all errors and event data from the error/event queue.
- ***IDN?** - Returns the instrument identification information.

For 4 state CALPod support the following is required.

- CCT (configurable command table) version 1.4
- Controller FPGA version 8.4

- ***OPC?** - Operation complete query. This query immediately returns a value, independent of whether or not the operation is complete. A return value of 0 indicates the operation is not complete. A value of +1 indicates the operation is complete. Typically this command is used in a loop with a 0.25 second delay when waiting for an operation to complete.
- ***TST?** - Performs a communication test on all the currently enabled Calpods. 0 = Test failed on one or more enabled Calpods. 1 = All enabled Calpods working.
- **SYSTem:ERRor?** - Queries the Event/Error queue and returns the most recent error element.

Important Notes

- ALL commands on this page are sent as a string argument from: **CONTrol:CALPod:COMMand <string>**
- Use single quotes ONLY (NOT double quotes) for the CONT:CALP:COMM string arguments.
- Sending queries requires TWO question marks. See following note as example.
- To read errors with the commands on this page, use the Calpod query:
`CONT:CALP:COMM? 'SYSTem:ERRor?'`
- ALL queries return strings.

See Also

- [Example Programs](#)
- [Synchronizing the Analyzer and Controller](#)
- [SCPI Command Tree](#)

CALPod:DISable <port>

Applicable Models: N522xB, N523xB, N524xB, M937xA, E5080A, P937xA

(Write-only) Unassign Calpod serial number from the specified VNA port.

See important notes.

Parameters

<port> VNA port number to un-assign.

Examples

```
CONT:CALP:COMM 'CALP:DIS 2'
```

Query Syntax Not Applicable

Default Not Applicable

CALPod:ENABLE <port>,<sn>

Applicable Models: N522xB, N523xB, N524xB, M937xA E5080A, P937xA

(Write-read) Assign or return the Calpod serial number for the specified VNA port. If a Calpod module is already assigned to the specified VNA port, this assignment will replace the existing assignment.

See important notes.

Parameters

<port> VNA port number to be assigned the Calpod serial number.

<sn> Calpod serial number.

Examples

```
CONT:CALP:COMM 'CALP:ENAB 2, 0001234' 'WRITE
```

```
CONT:CALP:COMM? 'CALP:ENAB? 2' 'READ
```

Query Syntax CONTrol:CALPod:COMMand? 'CALPod:ENABLE? <port>'

Return Type String

Default Not Applicable

CALPod:HIDE

Applicable Models: N522xB, N523xB, N524xB, M937xA E5080A, P937xA

(Write-only) Hides the Calpod setup dialog.

See important notes.

Parameters None

Examples

```
CONT:CALP:COMM 'CALP:HIDE'
```

Query Syntax Not Applicable

Default Not Applicable

CALPod:INITialize:ACTive

Applicable Models: N522xB, N523xB, N524xB, M937xA E5080A, P937xA

(Write-only) Performs the initialize process for the active (selected) channel. Select a channel using `CALCulate:MEASure:PARAmeter`.

See important notes.

Parameters None

Examples `CONT:CALP:COMM 'CALP:INIT:ACT'`

Query Syntax Not Applicable

Default Not Applicable

CALPod:INITialize:ALL

Applicable Models: N522xB, N523xB, N524xB, M937xA E5080A, P937xA

(Write-only) Performs the initialize ALL channels process.

See important notes.

Parameters None

Examples `CONT:CALP:COMM 'CALP:INIT:ALL'`

Query Syntax Not Applicable

Default Not Applicable

CALPod:LAUNCh

Applicable Models: N522xB, N523xB, N524xB, M937xA E5080A, P937xA

(Write-only) Starts the Calpod software. The Calpod software can be started using this (Launch) command or by activating the Calpod user interface. Once the Calpod software is started it remains active until the VNA application is terminated.

Send this command first in your program, then wait a couple seconds while the software starts before sending the next command.

See important notes.

Parameters None

Examples `CONT:CALP:COMM 'CALP:LAUN'`

`wait 3`

Query Syntax Not Applicable

Default Not Applicable

CALPod:RECorrect:ACTIVE

Applicable Models: N522xB, N523xB, N524xB, M937xA E5080A, P937xA

(Write-only) Performs the recorrect process for the active (selected) channel. Select a channel using **CALCulate:MEASure:PARAmeter**.

See important notes.

Parameters None

Examples `CONT:CALP:COMM 'CALP:REC:ACT'`

Query Syntax Not Applicable

Default Not Applicable

CALPod:RECorrect:ALL

Applicable Models: N522xB, N523xB, N524xB, M937xA E5080A, P937xA

(Write-only) Performs the recorrect process for ALL channels.

See important notes.

Parameters None

Examples `CONT:CALP:COMM 'CALP:REC:ALL'`

Query Syntax Not Applicable

Default Not Applicable

CALPod:SHOW

Applicable Models: N522xB, N523xB, N524xB, M937xA E5080A, P937xA

(Write-only) Shows the Calpod setup dialog.

See important notes.

Parameters None

Examples `CONT:CALP:COMM 'CALP:SHOW'`

Query Syntax Not Applicable

Default Not Applicable

CALPod:STATe <sn>,<state>

Applicable Models: N522xB, N523xB, N524xB, M937xA E5080A, P937xA

(Write-only) Sets the specified Calpod module to specified impedance state.

See important notes.

Parameters

<sn> Serial number of the Calpod module. When set to **1**, all modules are set to the specified state.

<state> Impedance state. Not case sensitive. Choose from:

Short, Open, Load, or Thru

Examples `CONT:CALP:COMM 'CALPod:STATe 0001234,thru'`

Query Syntax Not Applicable

Default Thru

CALPod:TEMP? <sn>

Applicable Models: N522xB, N523xB, N524xB, M937xA E5080A, P937xA

(Read-only) Returns the temperature of the specified Calpod module in degrees Celsius.

See important notes.

Parameters

<sn> Serial number of the Calpod module.

Examples

```
CONT:CALP:COMM? 'CALPod:TEMP? 0001234'
```

Query Syntax Not Applicable

Return Type String

Default Not Applicable

Control Commands

Specifies the settings to remotely control the rear panel connectors, an external test set, Calpod modules, and ECal Module state.

CONTRol

AUXiliary - More Commands

CALPod:COMMand

CHANnel:INTerface:CONTRol:

| **CONFIg:RECall**

| **[STATe]**

ECAL:MODule:

| **PATH:**

| **COUNT?**

| **STATe**

| **STATe**

EXTernal:TESTset - More Commands

HANDler - More Commands

NOISe:SOURce[:STATe]

SIGNal:

| **TRIGger**

| **ATBA**

|

| **AIO**

| **PIN**

| **COUNT?**

| **FUNCTION**

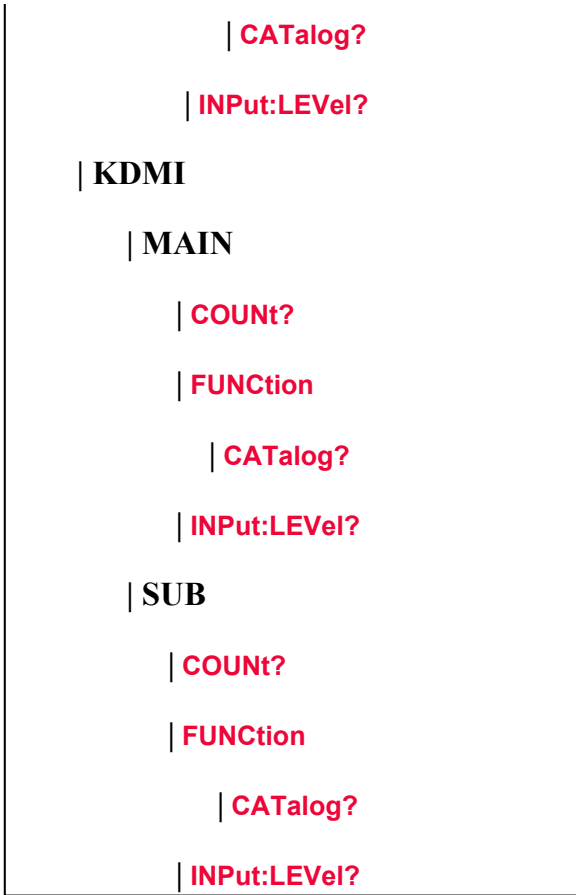

Click on a [keyword](#) to view the command details.

Blue command is superseded.

see Also

- [SCPI Command Tree](#)
 - [Material Handler IO connector](#)

CONTRol:CALPod:COMMand <string>

Applicable Models: N522xB, N523xB, N524xB, M937xA, E5080, P937xA

(Write-Read) Sends commands that control a Calpod module. Reads query versions Calpod commands.

See [ALL Calpod commands](#).

[Learn more about Calpod](#).

Parameters

<string> Calpod command. See [ALL Calpod commands](#) that can be used in this string.

Write Example

```
CONT:CALP:COMM 'CALP:INIT:ACT'
```

'Enclose all strings in SINGLE quotes (NOT double quotes)

Query Syntax

CONTrol:CALPod:COMMand? <string>

Relevant only for query strings.

Read Example

```
CONT:CALP:COMM? '*OPC?'
```

'returns 0 if the calpod software is currently processing an operation

'returns 1 if operations are complete

Return Type

String

Default

Not Applicable

CONTrol:CHANnel:INTerface:CONTrol:CONFig:RECall[:STATe] <string>

Applicable Models: N522xB, N523xB, N524xB, E5080A

(Write-only) Recalls an Interface Control configuration file. [Learn more about Interface Control](#).

Parameters

<string> File name and extension (.xml) of the configuration file to recall. Files are typically stored in the default folder "D:\". To recall from a different folder, specify the full path name.

Examples

```
CONT:CHAN:INT:CONT:CONF:REC 'MyConfigFile.xml'
```

```
control:channel:interface:control:config:recall:state
```

```
'D:\MyFile.xml'
```

Query Syntax

Not Applicable

Default

Not Applicable

CONTRol:CHANnel:INTerface:CONTRol[:STATe] <bool>

Applicable Models: N522xB, N523xB, N524xB, E5080

(Read-Write) Enables and disables ALL Interface Control settings. To send data, the individual interfaces must also be enabled. Learn more about Interface Control.

Parameters

<bool> Boolean

OFF (0) - Interface Control is disabled;NO control data is sent.

ON (1) - Interface Control is enabled.

Examples

```
CONT:CHAN:INT:CONT 1
```

```
control:channel:interface:control:state 0
```

Query Syntax CONTRol:CHANnel:INTerface:CONTRol[:STATe]?

Return Type Boolean

Default OFF (0)

CONTRol:ECAL:MODule<num>:PATH:COUNT? <name>

Applicable Models: All

(Read-only) Returns the number of unique states that exist for the specified path name on the selected ECal module.

This command performs exactly the same function as **SENS:CORR:CKIT:ECAL:PATH:COUNT?**

Use the **CONT:ECAL:MOD:PATH:STAT** command to set the module into one of those states.

Use **SENS:CORR:CKIT:ECAL:PATH:DATA?** to read the data for a state.

Parameters

[num] Optional argument. USB number of the ECal module. If unspecified (only one ECal module is connected to the USB), <num> is set to 1. If two or more modules are connected, use **SENS:CORR:CKIT:ECAL:LIST?** to determine how many, and **SENS:CORR:CKIT:ECAL:INF?** to verify their identities.

<name> Name of the path for which to read number of states. Choose from:
Reflection paths

- **A**
- **B**
- **C** (4-port modules)
- **D** (4-port modules)

Transmission paths

- **AB**
- **AC** (4-port modules)
- **AD** (4-port modules)
- **BC** (4-port modules)
- **BD** (4-port modules)
- **CD** (4-port modules)

Note: For each transmission path, the first of the available states is the through state, the second is the confidence (attenuator) state.

Examples

```
CONT:ECAL:MOD:PATH:COUNT? A
control:ecal:module2:path:count? cd
See example program
```

Return Type Integer

Default Not Applicable

CONTROL:ECAL:MODULE<num>:PATH:STATE <path>, <stateNum>

Applicable Models: All

(Write-only) Sets the internal state of the selected ECAL module. This command supersedes **CONT:ECAL:MOD:STAT**.

- Use **CONT:ECAL:MOD:PATH:COUN?** to read the number of unique states that exist for the specified path name on the module.
- Use **SENS:CORR:CKIT:ECAL:PATH:DATA?** to read the data for a state (from the module memory) corresponding to the stimulus values of a channel.

Parameters

[num] Optional argument. USB number of the ECal module. If unspecified (only one ECal module is connected to the USB), <num> is set to 1. If two or more modules are connected, use **SENS:CORR:CKIT:ECAL:LIST?** to determine how many, and **SENS:CORR:CKIT:ECAL:INF?** to verify their identities.

<path> Path name for which to set a state.

Note: The impedance paths are not independent. For example, changing the impedance presented on path A will cause a change to the impedance on path B.

Choose from:

Reflection paths

- **A**
- **B**
- **C** (4-port modules)
- **D** (4-port modules)

Transmission paths

- **AB**
- **AC** (4-port modules)
- **AD** (4-port modules)
- **BC** (4-port modules)
- **BD** (4-port modules)
- **CD** (4-port modules)

<stateNum> Number of the state to set. Refer to the following table to associate the <stateNum> with a state in your ECal module.

In addition, **CONT:ECAL:MOD:PATH:COUNT?** returns the number of states in the specified ECal module.

<stateNum>	N4432A and N4433A States	N4431A States	N469x and N755x States**	8509x States
One-Port Reflection States				
1	Open	Open	Impedance 1	Open
2	Short	Short	Impedance 2	Short
3	Impedance 1	Impedance 1	Impedance 3	Impedance 1
4	Impedance 2	Impedance 2	Impedance 4	Impedance 2
5			Impedance 5	
6			Impedance 6	
7			Impedance 7	
Two-Port Transmission States				
1	Thru	Thru	Thru	Thru
2	Confidence	Confidence	Confidence	Confidence

** The following modules have only FOUR Impedance states (1, 2, 3, 4):
N4690B ,N4691B ,N4692A ,N4696B, N7550A - N7556A.

Examples

```
CONT:ECAL:MOD:PATH:STATE A,5
```

```
control:ecal:module2:state BC,1
```

[See example program](#)

Query Syntax Not Applicable

Default Not Applicable

CONTrol:ECAL:MODule<num>:STATe <value> **Superseded**

Applicable Models: N522xB, N523xB, N524xB, M937xA, P937xA

This command is replaced with **CONT:ECAL:MOD:PATH:STATE**.

(Write-only) Sets the internal state of the selected ECAL module.

Parameters

- [num] Optional argument. USB number of the ECal module. If unspecified (only one ECal module is connected to the USB), <num> is set to 1. If two or more modules are connected, use **SENS:CORR:COLL:CKIT:INF?** to verify their identity.
- <value> Integer code for switching the module. The following are codes for Keysight ECal modules.

8509x Modules		
State	Port A	Port B
Open	0	0
Short	43	43
Load	33	33
Mismatch	4	16
Thru	84	
Confidence	20	

N469x and N755x Modules		
State	Port A	Port B
Open	36	33
Short	39	45
Load	37	37
Mismatch (Offset short)	53	53
Impedance 5 (Offset open)	5	5
Impedance 6 (Offset short)	21	21
Impedance 7 (Offset short)	38	41
Thru	42	
Confidence	40	

N4431A Modules				
State	Port A	Port B	Port C	Port D
Open	-1398	-1384	-2774	-2654
Short	-1350	-1381	-2582	-2642
Load	26985	-26986	-26986	26985
Mismatch	-26986	26985	26985	-26986
Path	Thru		Confidence	
AB Path	-2590		-598	
AC Path	-4011		85	
AD Path	-2517		16042	
BC Path	-1650		-598	
BD Path	-4011		85	
CD Path	-1352		16042	

N4432A and N4433A Modules				
State	Port A	Port B	Port C	Port D
Open	-6971	-11835	-14895	-14876
Short	-14395	-12859	-14899	-14905
Load	-14907	-14907	-14907	-14907
Offset Short	-9787	-6459	-14874	-14887
Path	Thru		Confidence	
AB Path	13765		30069	
AC Path	-10519		-2327	
AD Path	-10538		-2346	
BC Path	-5655		-1559	
BD Path	-5674		-1578	
CD Path	-15051		30069	

Examples

```
CONT:ECAL:MOD:STAT 36
control:ecal:module2:state 38
```

Query Syntax Not Applicable

Default Not Applicable

CONTRol:MULTiplexer<id>:OUTPut:<grp>[:DATA] <num>

Applicable Models: E5080

(Read-Write) Sets or returns the output port data for specified group with id of the E5092A multiport test set.

Notes: This command is available only for E5092A multiport test set.

Parameters

- <id> Id of the multiport test set either 1 or 2. If unspecified, Id is assumed to be 1.
- <grp> A | B | C | D
- <num> An integer specifying the decimal value of the control line. Values are obtained by adding weights from the following table that correspond to individual lines.

The output port data range is between 0 to 255 (0=All line are turns OFF and 255 all lines are turn ON).

Line	Weight
1	1
2	2
3	4
4	8
5	16
6	32
7	64
8	128

Examples `CONT:MULT1:OUTP:B 8`

Query Syntax `CONTRol:MULTiplexer<id>:OUTPut:<grp>[:DATA]?`

Return Type Numeric

Default 0

CONTRol:MULTiplexer<id>:OUTPut:<grp>VOLTage[:DATA] <volt>

Applicable Models: E5080

(Read-Write) Sets or returns the output voltage for specified group with id of the E5092A multiport test set.

Notes: This command is available only for E5092A multiport test set.

Parameters

<id> Id of the multiport test set either 1 or 2. If unspecified, Id is assumed to be 1.

<grp> A | B | C | D

<volt> Output voltage range for <grp> is between 0 to 5.2V and resolution is 10mV.

Examples

```
CONT:MULT1:OUTP:B:VOLT 4.2
```

Query Syntax CONTrol:MULTiplexer<id>:OUTPut:<grp>:VOLTage[:DATA]?

Return Type Numeric

Default 0 V

CONTrol:NOISe:SOURce[:STATe] <bool>

Applicable Models: N522xB, N523xB, N524xB

(Read-Write) Set and read the noise source (28V) ON and OFF.

Parameters

<bool> Boolean

OFF (0) - Noise Source OFF

ON (1) - Noise Source ON

Examples

```
CONT:NOIS:SOUR 1
```

```
control:noise:source:state 0
```

Query Syntax CONTrol:NOISe:SOURce[:STATe]?

Return Type Boolean

Default For VNA models with a **Noise Figure option** (028/029/H29), the 28V line is ON at application start and after a preset. The ON/OFF state is also available from a VNA softkey menu.

For VNA models WITHOUT a Noise Figure option (028/029/H29), the 28V line is OFF at application start and its state is not affected by a preset. The ON/OFF state is NOT available from a VNA softkey menu.

CONTROL:SIGNal <conn>,<char>

Applicable Models: N522xB, N523xB, N524xB

(Read-Write) Configures external triggering in the VNA.

Note: To configure external triggering in the current VNA models, use the **Trigger** commands.

- To control BNC1 and BNC2 with this command, then you **MUST** have **TRIG:PREF:AIGLobal = ON**. [Learn more](#)
- **Trigger:Sequence:Source** is automatically set to External when **CONTROL:SIGNal** is sent.
- Edge triggering is only available on some Microwave VNA models.
- For more information, see [External Triggering](#) in the VNA.

Parameters

<conn> Rear Panel connector to send or receive trigger signals. Choose from:

BNC1 Trigger IN from rear-panel Trigger IN BNC connector

Note: Only one of the input connectors is active at a time. When a command is sent to one, the VNA automatically makes the other INACTIVE.

BNC2 Trigger OUT to rear-panel Trigger OUT BNC connector.

MATHtrigger - Trigger IN from rear-panel **Material Handler connector Pin 18**

RDY - Ready for trigger OUT.

- PNA-X: Meas Trig RDY
- PNA-L: **Handler I/O p21 (Some models)**

<char> **INACTIVE** - Disables the specified connector <conn>.

Choose from ONLY the following when <conn> is set to BNC1 or AUXT or MATHtrigger:

- **TIENEGATIVE** - (Trigger In Edge Negative) - Triggers the VNA when receiving a negative going signal
- **TIEPOSITIVE** - (Trigger In Edge Positive) - Triggers the VNA when receiving a positive going signal
- **TILLOW** - (Trigger In Level Low) - Triggers the VNA when receiving a low level signal

- **TILHIGH** - (Trigger In Level High) - Triggers the VNA when receiving a High-level signal

Choose from ONLY the following when <conn> is set to BNC2:

Use **CONTRol:SIGNal:TRIGger:OUTP** to enable the BNC2 output.

The following selections send a positive or negative pulse before or after each trigger acquisition. This normally occurs each sweep unless a channel is in **point trigger** mode.

- **TOPPAFTER** - (Trigger Out Pulse Positive After) - Sends a POSITIVE going TTL pulse at the END of each trigger acquisition.
- **TOPPBEFORE** - (Trigger Out Pulse Positive Before) - Sends a POSITIVE going TTL pulse at the START of each trigger acquisition.
- **TOPNAFTER** - (Trigger Out Pulse Negative After) - Sends a NEGATIVE going TTL pulse at the END of each trigger acquisition.
- **TOPNBEFORE** - (Trigger Out Pulse Negative Before) - Sends a NEGATIVE going TTL pulse at the START of each trigger acquisition.

Choose from ONLY the following when <conn> is set to RDY:

- **LOW** Outputs a TTL low when the VNA is ready for trigger. (Default setting)
- **HIGH** Outputs a TTL high when the VNA is ready for trigger.

Examples

```
CONT:SIGN BNC1, TIENEGATIVE
control:signal bnc2, toppbefore

CONT:SIGN RDY, LOW
```

Query Syntax `CONTRol:SIGNal? <conn>`

In addition to the arguments listed above, the following is also a possible returned value:

NAVAILABLE - This feature is not available on this VNA

Return Type Character

Default At Preset:

BNC1 = INACTIVE
 BNC2 = INACTIVE
 AUXT = TILHIGH

When **Output is enabled**:

BNC1 = INACTIVE
BNC2 = TOPPAFTER
AUXT = TILHIGH

CONTrol:SIGNal:TRIGger:ATBA <bool>

Applicable Models: N522xB, N523xB, N524xB

(Read-Write) Accept Trigger Before Armed Determines what happens to an EDGE trigger signal if it occurs before the VNA is ready to be triggered. (LEVEL trigger signals are always ignored.) For more information, see [External triggering](#).

Parameters

<bool> Boolean

OFF (0) - A trigger signal is ignored if it occurs before the VNA is ready to be triggered.

ON (1) - A trigger signal is remembered and then used when the VNA becomes armed (ready to be triggered). The VNA remembers only one trigger signal.

Examples

```
CONT:SIGN:TRIG:ATBA 0  
control:signal:trigger:atba ON
```

Query Syntax CONTrol:SIGNal:TRIGger:ATBA?

Return Type Boolean

Default OFF

CONTrol:SIGNal:TRIGger:OUTP <bool>

Applicable Models: N522xB, N523xB, N524xB

(Read-Write) Output Enabled The VNA can be enabled to send trigger signals out the rear-panel TRIGGER OUT BNC connector. Use **CONTRol:SIGNal** to configure for output triggers.

Note: To configure external triggering in the current VNA models, use the **Trigger** commands.

For more information, see **External triggering**.

Parameters

<bool> Boolean
OFF (0) - VNA does NOT output trigger signals.
ON (1) - VNA DOES output trigger signals.

Examples

```
CONT:SIGN:TRIG:OUTP 1  
control:signal:trigger:outp OFF
```

Query Syntax CONTRol:SIGNal:TRIGger:OUTP?

Return Type Boolean

Default OFF

CONTRol:SIGNal:AIO:PIN:COUNT?

Applicable Models: E5080B

(Read only) Read the total number of pin on the application I/O. In case for the E5080B, always 15. For more information, see application I/O.

Parameters None

Examples

```
CONT:SIGN:AIO:PIN:COUN?  
control:signal:aio:pin:count?
```

Query Syntax CONTRol:SIGNal:AIO:PIN:COUNT?

Return Type Numeric value

Default 15

CONTRol:SIGNal:AIO:PIN<pin>:FUNCTion <func>

Applicable Models: E5080B

(Write-Read) Set and Read the function for the specified port in the application I/O interface. The assigned settings are preserved even after preset, firmware restart and power on/off, however, they are not saved in a state file.

Parameters

<pin> Pin Number.

<func> function name

Function name	Description	Type	Assignable pot number	Default Assignment
PULSE_OUT1	1st pulse output	Output	10	10
PULSE_OUT2	2nd pulse output	Output	11	11
PULSE_OUT3	3rd pulse output	Output	12	12
PULSE_OUT4	4th pulse output	Output	13	13
RF_PULSE_MOD_IN	RF pulse modulation	Input	8	8
PULSE_SYNC_IN	Pulse generator synchronization trigger input	INPUT	7	7
INPUT	Arbitrary input (CONT:SIGN:APPL:INP:LEV? to query the level on the assigned port)	Input	1 to 5, 10 to 13	N/A
LOW	Set the Low (Output Low level) at the assigned port.	Output	1 to 5, 10 to 13	1 to 5
HIGH	Set the High (Output High level) at the assigned port	Output	1 to 5, 10 to 13	N/A
NF_SOURCEx (x=1,2,...) *1	Noise Figure source switch control for port x	Output	1 to 5, 10 to 13	N/A
NF_RECIEVERx (x=1,2,...) *1	Noise Figure receiver switch control for port x	Output	1 to 5, 10 to 13	N/A
DCV_ON	+12V power output enable	Output	14	N/A
DCV_OFF	+12V power output disable	Output	14	14

*1) For Noise Figure switch control, the signal is asserted no matter which pins are used in the NF channel if the port index(x) is not specified.

Examples

```
CONT:SIGN:AIO:PIN:FUNC "LOW"  
control:signal:aio5:pin:function "NF_SOURCE15"
```

Query Syntax CONTrol:SIGNal:AIO:PIN:FUNC?**Return Type** <string>**Default** See the table in <func>

CONTrol:SIGNal:AIO:PIN<pin>:FUNCtion:CATalog?**Applicable Models:** E5080B

(Read Only) Read the list of the available function for the specified pin in the application I/O. Example, "RF_PULSE_MOD_IN" is returned for the pin 8.

Parameters

<pin> Pin Number.

Examples

```
CONT:SIGN:AIO:PIN3:FUNC:CAT?  
control:signal:aio:pin3:function:catalog?
```

Query Syntax CONTrol:SIGNal:AIO:PIN:FUNC:CAT?**Return Type** <string>, available function list with Comma separated chars**Default** See the table in <func> of **CONTrol:SIGNal:APPLication:FUNC?**

CONTrol:SIGNal:AIO:PIN<pin>:INPut:LEVel?

Applicable Models: E5080B

(Read only) Read the level of the specified INPUT pin of the application I/O. This command reads the level immediately after its execution. It is not necessary to assign the pin as INPUT by command. When the specified pin number is 6 to 9 or 14, "Specified Application IO port is not input port." error is returned.

Parameters

<pin> Pin Number. (E5080B: 1 to 5, 10 to 13)

Examples

```
CONT:SIGN:AIO:PIN:INP2:LEV?  
control:signal:aio:pin:input1:level?
```

Query Syntax CONTrol:SIGNal:AIO:PIN:INPut:LEVel?

Return Type Char ("HIGH" or "LOW")

Default N/A

CONTrol:SIGNal:KDMI:MAIN:COUNT?

Applicable Models: M980xA,P50xxA

(Read only) Read the number of ports in the main control port of the I/O connector interface. In case for the M980xA/P50xxA, always 6.

For more information, see [I/O Connector Interface \(M980xA/P50xxA\)](#)

Parameters None

Examples

```
CONT:SIGN:KDMI:MAIN:COUN?  
control:signal:kdm:main:count?
```

Query Syntax CONTrol:SIGNal:KDMI:MAIN:COUNT?

Return Type Numeric value

Default 6.

CONTrol:SIGNal:KDMI:MAIN<port>:FUNctiOn <func>

Applicable Models: M980xA,P50xxA

(Write-Read) Set and Read the function for the specified port in the main c of the I/O adapter interface. The assigned settings are preserved for each system configuration even after preset, firmware restart and power on/off.

For more information, see [I/O Connector Interface \(M980xA/P50xxA\)](#)

Parameters

<port> Port Number. The number of total ports is returned by [CONTrOl:SIGNal:KDMI:MAIN:COUNt?](#).

<func> function name

Function name	Description	Type	Assignable port number
PULSE_OUT1	1st pulse output	Output	1
PULSE_OUT2	2nd pulse output	Output	2
PULSE_OUT3	3rd pulse output	Output	3
PULSE_OUT4	4th pulse output	Output	4
RF_PULSE_MOD_IN	RF pulse modulation	Input	5 (Factory default)
INPUT	Arbitrary input (CONTrOl:SIGNal:KDMI:MAIN:INP:LEV? to query the level on the assigned port)	Input	3 (Factory default), 4 (Factory default), 6 (Factory default)
LOW	Set the Low (Output Low level) at the assigned port.	Output	1, 2, 3 or 4
HIGH	Set the High (Output High level) at the assigned port	Output	1 (Factory default), 2 (Factory default), 3 or 4
NF_SOURCEx (x=1,2,...) *1	Noise Figure source switch control for port x	Output	1, 2, 3 or 4
NF_RECIEVERx (x=1,2,...) *1	Noise Figure receiver switch control for port x	Output	1, 2, 3 or 4
NF_LOy (y=1,2,...)	Noise Figure LO switch control for module y	Output	1, 2, 3 or 4

*1) For Noise Figure switch control, the signal is asserted no matter which ports are used in the NF channel if the port/module index(x) is not specified.

Examples

```
CONT:SIGN:KDMI:MAIN1:FUNC "LOW"
control:signal:kdm:main2:function "NF_LO1"
```

Query Syntax CONTrol:SIGNal:KDMI:MAIN:FUNC?**Syntax****Return Type** <string>**Type****Default** See the table in <func>**CONTrol:SIGNal:KDMI:MAIN<port>:FUNCtion:CATalog?****Applicable Models:** M980xA,P50xxA

(Read Only) Read the list of the available function for the specified port in the main control of the I/O adapter interface. Example, "RF_PULSE_MOD_IN, INPUT1" is returned for the port 5.

For more information, see [I/O Connector Interface \(M980xA/P50xxA\)](#)

Parameters

<port> Port Number. The number of total ports is returned by [CONTrol:SIGNal:KDMI:MAIN:COUNT?](#).

Examples

```
CONT:SIGN:KDMI:MAIN:FUNC:CAT?
control:signal:kdm:main:function:catalog?
```

Query Syntax CONTrol:SIGNal:KDMI:MAIN:FUNC:CAT?**Return Type** <string>, available function list with Comma separated chars**Default** See the table in <func> of [CONTrol:SIGNal:KDMI:MAIN:FUNC?](#)**CONTrol:SIGNal:KDMI:MAIN:INPut<num>:LEVel?**

Applicable Models: M980xA, P50xxA

(Read only) Read the level of the specified INPUT port of the I/O adapter main side. This command reads the level immediately after its execution. It is not necessary to assign the port as INPUT by **CONTROL:SIGNAl:KDMI:MAIN:FUNCion** command. When the specified <num> is not 3 to 6, "Requested input is not assigned to any KDMI ports" error is returned.

For more information, see [I/O Connector Interface \(M980xA/P50xxA\)](#)

Parameters

<num> Input Number (M980xA, P50xxA: 3 to 6)

Examples

```
CONT:SIGN:KDMI:MAIN:INP2:LEV?  
control:signal:kdm:main:input1:level?
```

Query Syntax CONTROL:SIGNAl:KDMI:MAIN:INPut:LEVel?

Return Type Char ("HIGH" or "LOW")

Default N/A

CONTROL:SIGNAl:KDMI:SUB:COUNT?

Applicable Models: M980xA,P50xxA

(Read only) Read the number of ports in the sub control of the I/O adapter interface. In case for the M980xA/P50xxA, always 6.

For more information, see [I/O Connector Interface \(M980xA/P50xxA\)](#)

Parameters None

Examples

```
CONT:SIGN:KDMI:SUB:COUN?  
control:signal:kdm:sub:count?
```

Query Syntax CONTROL:SIGNAl:KDMI:SUB:COUNT?

Return Type Numeric value

Default 6

CONTROL:SIGNAl:KDMI:SUB<port>:FUNCtion <func>

Applicable Models: M980xA,P50xxA

(Write-Read) Set and Read the function for the specified port in the sub control port of the I/O adapter interface. The assigned settings are preserved for each system configuration even after preset, firmware restart and power on/off.

For more information, see [I/O Connector Interface \(M980xA/P50xxA\)](#)

Parameters

<port> Port Number. The number of total ports is returned by [CONTrol:SIGNal:KDMI:SUB:COUNT?](#).

<func> function name

Function name	Description	Type	Assignable pot number
TRIGGER_IN	External trigger	Input	1 (Factory default)
PULSE_SYNC_IN	Pulse synchronization	Input	2 (Factory default)
READY_FOR_TRIGGER	Ready for trigger	Output	3
TRIGGER_OUT	AUX trigger	Output	4
INDEX	index	Output	5
SWEEP_END	Sweep end	Output	6
INPUT	Arbitrary input (CONTI:SIGN:KDMI:SUB:INP:LEV? to query the level on the assigned port)	Input	3 (Factory default), 4 (Factory default)
LOW	Set the Low at the assigned port	Output	3, 4, 5 or 6
HIGH	Set the High at the assigned port	Output	3, 4, 5 (Factory default) or 6 (Factory default)
NF_SOURCEx (x=1,2,...) *1	Noise Figure source switch control for port x	Ouptpu	3, 4, 5 or 6
NF_RECIEVERx (x=1,2,...) *1	Noise Figure receiver switch control for port x	Output	3, 4, 5 or 6
NF_LOy (y=1,2,...)	Noise Figure LO switch control for module y	Output	3, 4, 5 or 6

*1) For Noise Figure switch control, the signal is asserted no matter which ports are

used in the NF channel if the port/module index(x) is not specified.

Examples

```
CONT:SIGN:KDMI:SUB3:FUNC "LOW"
control:signal:kdm:sub2:function "INPUT4"
```

Query Syntax CONTrol:SIGNal:KDMI:SUB:FUNCion?

Return Type < sting >

Default See the table in <func>

CONTrol:SIGNal:KDMI:SUB<port>:FUNCtion:CATalog?

Applicable Models: M980xA,P50xxA

(Read Only) Read the list of the available function for the specified port in the sub control port of the I/O adapter interface. Example, "TRIGGER_IN, INPUT3" is returned for the port 1.

For more information, see [I/O Connector Interface \(M980xA/P50xxA\)](#)

Parameters

<port> Port Number. The number of total ports is returned by [CONTrol:SIGNal:KDMI:SUB:COUNT?](#).

Examples

```
CONT:SIGN:KDMI:SUB:FUNC:CAT?
control:signal:kdm:sub:function:catalog?
```

Query Syntax CONTrol:SIGNal:KDMI:SUB:FUNC:CAT?

Return Type < sting >, available function list with Comma separated chars

Default See the table in <func> of [CONTrol:SIGNal:KDMI:SUB:FUNC?](#)

CONTrol:SIGNal:KDMI:SUB:INPut<num>:LEVel?

Applicable Models: M980xA, P50xxA

(Read only) Read the level of the specified INPUT port of the I/O adapter sub side. This command reads the level immediately after its execution. It is not necessary to assign the port as INPUT by **CONTRol:SIGNal:KDMI:SUB:FUNCion** command. The When the specified input number is not 1 to 4, "Requested input is not assigned to any KDMI port" error is returned.

For more information, see [I/O Connector Interface \(M980xA/P50xxA\)](#)

Parameters

<num> Input Number (M980xA, P50xxA: 1 to 4)

Examples

```
CONT:SIGN:KDMI:SUB:INP4:LEV?  
control:signal:kdm:sub:input5:level?
```

Query Syntax CONTRol:SIGNal:KDMI:MAIN:INPut:LEVel?

Return Type Char ("HIGH" or "LOW")

Default N/A

Control:Multiplexer Commands

Controls the E5092A Configurable Multiport Test Set.

CONTRol:MULTiplexer:

OUTPut

| **A|B|C|D[DATA]**

| **A|B|C|D:VOLTage[DATA]**

PORT

| **[:SElect]**

Click on a keyword to view the command details.

See Also

- Learn about External Test Set Control
- [Synchronizing the Analyzer and Controller](#)
- [SCPI Command Tree](#)

CONTRol:MULTiplexer<id>:OUTPut:<grp>[:DATA] <num>

Applicable Models: N522xB, N523xB, N524xB, E5080

(Read-Write) Sets or returns the output port data for specified group with id of the E5092A multiport test set.

Note: This command performs an **immediate** setting of the specified data on the indicated test set, as opposed to the **SENSe<cnum>:MULTiplexer<id>:OUTPut:<grp>[:DATA] <num>** command which sets the data only at the beginning of each sweep of the specified channel number 'cnum'.

Parameters

- <id> Id of the external test set either 1 or 2. If unspecified, Id is assumed to be 1. Must be previously set by the **SENS:MULT:TYPE** command.
- <grp> A | B | C | D
- <num> An integer specifying the decimal value of the control line. Values are obtained by adding weights from the following table that correspond to individual lines.

The output port data range is between 0 to 255 (0=All lines are turned OFF and 255 all lines are turned ON).

Line	Weight
1	1
2	2
3	4
4	8
5	16
6	32
7	64
8	128

Examples `CONT:MULT1:OUTP:B 8`

Query Syntax `CONTrol:MULTiplexer<id>:OUTPut:<grp>[:DATA]?`

Return Type Numeric

Default 0

`CONTrol:MULTiplexer<id>:OUTPut:<grp>:VOLTage[:DATA] <volt>`

Applicable Models: N522xB, N523xB, N524xB, E5080

(Read-Write) Sets or returns the output voltage for specified group with id of the E5092A multiport test set.

Note: This command performs an **immediate** setting of the specified voltage on the indicated test set, as opposed to the **SENSe<cnum>:MULTiplexer<id>:OUTPut:<grp>:VOLTage[:DATA] <volt>** command which sets the voltage only at the beginning of each sweep of the specified channel number 'cnum'.

Parameters

- <id> Id of the external test set either 1 or 2. If unspecified, Id is assumed to be 1. Must be previously set by the **SENS:MULT:TYPE** command.
- <grp> A | B | C | D
- <volt> Output voltage range for <grp> is between 0 to 5.2V and resolution is 10mV.

Examples `CONT:MULT1:OUTP:B:VOLT 4.2`

Query Syntax `CONTrol:MULTiplexer<id>:OUTPut:<grp>:VOLtage[:DATA]?`

Return Type Numeric

Default 0 V

CONTrol:MULTiplexer<id>:PORT<pnum>[:SElect] <string>

Applicable Models: N522xB, N523xB, N524xB, E5080

(Write-Only) Sets the multiport test set port. If this command creates a conflict with an existing port, the VNA will resolve the conflict.

Note: This command performs an **immediate** setting of the specified port on the indicated test set, as opposed to the **SENSe<cnum>:MULTiplexer<id>:PORT<pnum>:SElect <string>** command which sets the port only at the beginning of each sweep of the specified channel number 'cnum'.

Parameters

- <id> Id of the external test set. If unspecified, Id is assumed to be 1. Must be previously set by the **SENSe:MULT:TYPE** command.
- <pnum> Integer - Logical port number. The range is 1 to 20.
- <string> Physical port number.

Examples `CONT:MULT1:PORT3:SEL "4" 'sets logical port 3 to physical port 4.`

Return Type String

Default Not Applicable

CONTrol:HANDler:EXT:INDex:LOGic <char>

Applicable Models: M937xA, P937xA

(Read-Write) Sets the logic of the index line ("Trig Out" port) on the last PXIe module. There is no soft front-panel element for this feature.

Parameters

<char> Choose from:

POSitive - Causes the Index line to have positive logic (Low signal indicates that the measurement is complete)

NEGative - Causes the Index lines to have negative logic (High signal indicates that the measurement is complete).

Examples

```
CONT:HAND:EXT:INDEX:LOG POS
```

```
control:handler:ext:index:logic negative
```

Query Syntax CONTrol:HANDler:EXT:INDex:LOGic?

Return Type Character

Default POSitive

CSET:Fixture Commands

Manages several aspects of Cal Sets.

CSET:

| **CATalog?**

| **COPY**

| **DALL**

| **DATE?**

| **DELeTe**

| **EXISts?**

| **ETERm:**

 | **CATalog?**

 | **[:DATA]**

 | **X:VALues**

| **FIXTure:**

 | **CASCade**

 | **CHARacterize**

 | **DEEMbed**

 | **EMBed**

 | **ENR:EMBed**

 | **ZERO**

| **ITEM:**

 | **CATalog?**

 | **DATA?**

| **TIME?**

Click on a keyword to view the command details.

Note: There is no user-interface equivalent for some of these commands.

See Also

- Example Programs
- Synchronizing the Analyzer and Controller
- SCPI Command Tree

CSET:CATalog?

Applicable Models: All

This command replaces SENS:CORR:CSET:CAT?

(Read-only) Returns the names of Cal Sets stored on the VNA.

Parameters None

Examples

```
CSET:CAT?
```

Returns:

```
"CalSet_0913,CalSet_1,CalSet_2,CalSet_3,CalSet_4,CH1_CALREG,CH31_CALREG,MyCalAll_SMC_002,MyCalAll_STD_001"
```

Return Type Comma-separated string of names

Default Not Applicable

CSET:COPY <string>,<string>

Applicable Models: All

(Write-only) Creates a new Cal Set and copies the current Cal Set data into it. Use this command to manipulate data on a Cal Set without corrupting the original cal data.

Parameters

<string>,<string> The first string is the name of the current Cal Set. The second string is the name of the new Cal Set copy.

Examples

```
CSET:COPY 'My2Port', 'My2PortCopy'
```

Query Syntax Not Applicable

Default Not Applicable

CSET:DALL

Applicable Models: All

(Write-only) Deletes ALL Cal Sets from the VNA, including phase reference and Global Delta Match Cal Sets.

Parameters None

Examples

```
CSET:DALL
```

Query Syntax Not Applicable

Default Not Applicable

CSET:DATE? <string>

Applicable Models: All

(Read-only) Returns the (year, month, day) that the specified Cal Set was last saved.

See Also

MMEM:DATE?

MMEM:TIME?

CSET:TIME?

Parameters

<string> Cal Set name.

Examples

```
CSET:DATE? "CalSet_11"
```

```
'Returns :
```

```
+2013,+5,+1
```

Return Type Comma-separated integers.

Default Not Applicable

CSET:DELeTe <string>

Applicable Models: All

This command replaces SENS:CORR:CSET:DELeTe

(Write-only) Deletes the specified Cal Set from the VNA.

- If the Cal Set is currently being used by a channel, the Cal Set is deleted and correction for the channel is turned off.
- If the Cal Set is not found, no error is returned.

Parameters

<string> Name of the Cal Set to delete. Not case-sensitive.

Examples

```
CSET:DEL "MyCalSet"
```

Query Syntax Not Applicable

Default Not Applicable

CSET:EXISts? <string>

Applicable Models: All

(Read-only) Returns whether or not the specified Cal Set exists on the VNA.

Parameters

<string> Name or GUID of the Cal Set enclosed in quotes.

The GUID must also be enclosed in curly brackets.

Examples

```
dim check
check = CSET:EXISTS? "MyCalSet"
check = CSET:EXISTS? "{7C4EEA5E-40D2-4D70-A048-33BFFE704163}"
```

Return Type Boolean

ON or **1** - Cal Set exists.

OFF or **0** - Cal Set does NOT exist.

Default Not Applicable

CSET:ETERm:CATalog? <CSET Name>[,<errorTermFilter>]

Applicable Models: All

(Read-only) Returns a list of error term names for the given Cal Set.

Parameters

<CSET Name> (String) Name of Cal Set to query.

<errorTermFilter> (Optional argument) CSET:ETER:CAT? <CSETName>, "<errorTermFilter>" will return only the error term names with the filter string in them. For example, if it is a full 2-port cal, then CSET:ETER:CAT? <CSETName>, "cross" would return all "Crosstalk(n,n)" error terms. (Note that the filter is not case sensitive.)

Entering CSET:ETER:CAT? <CSETName> "" or CSET:ETER:CAT? <CSETName> will return all error terms for the given Cal Set.

Examples

```
CSET:ETER:CAT? "CalSet_1"
CSET:ETER:CAT? "CalSet_1", "trans"
```

Return Type Variant

Default Not Applicable

CSET:ETERm[:DATA] <CSET Name>,<ETerm Name>,<data>

Applicable Models: All

(Read-Write) Sets and returns the error term data (real, imaginary pairs) for the given Cal Set and error term name.

Parameters

- <CSET Name> (String) Name of Cal Set to manipulate.
- <ETerm Name> (String) Name used to identify an error term in the Cal Set.
- <data> (Block) Error term data - a real/imaginary data pair for each data point.

Examples

```
CSET:ETER "CalSet_1","Directivity(1,1)", 0.237,-1.422, 0.513,
0.895
CSET:ETER? "CalSet_1","Directivity(1,1)" 'read
```

Query Syntax CSET:ETERm:DATA? <CSET Name>,<ETerm Name>

Return Type Block data

Default Not Applicable

CSET:ETERm:X:VALues <CSET Name>,<ETerm Name>,<freqlist>

Applicable Models: All

(Read-Write) Sets and returns the x-axis frequencies for the given Cal Set and error term name. This command requires that the error term already be in existence either from a calibration session or having been created with CSET:ETER:DATA .

This command requires that the frequency array length match the existing size of the error term. For example, if the error term is 3 buckets long (3 complex numbers), then the frequency list must be 3 values long.

Parameters

- <CSET Name> (String) Name of Cal Set to manipulate.
- <ETerm Name> (String) Name used to identify an error term in the Cal Set.
- <freqlist> (Block) X-axis frequencies associated with the error term.

Examples

```
'Query error term data from calset named "Calset1"
CSET:ETER:DATA? "Calset7","Directivity(1,1) "

'If needed, change or upload the data for the "Directivity" error term (example)
CSET:ETER:DATA "Calset7","Directivity(1,1)",-3.86251918972E-002,+5.34659661
002,+2.90613174438E-002,-2.16645095497E-002,-1.38868670911E-003,+3.30922640
```

```
'Query what the frequency values are for the error term
CSET:ETER:X:VAL? "Calset7","Directivity(1,1) "

'If needed, change the frequency values for the error term
CSET:ETER:X:VAL
"Calset7","Directivity(1,1) ",1.000000000000E+007,1.424500000000E+008,2.749000
```

Query CSET:ETERm:X:VALues? <CSET Name>,<ETerm Name>

Syntax

Return Block data

Type

Default Not Applicable

CSET:FIXTure:CASCade <s2p1>,<s2p2>,<s2pResult>,<char>

Applicable Models: All

(Write-only) Combines the losses and phase shift of two S2P files into a single S2P file. [Learn more.](#)

Parameters

<s2p1> (String) Path and filename of one of the S2P files to be combined.

<s2p2> (String) Path and filename of the other S2P file to be combined.

<s2pResult> (String) Path and filename of the combined S2P file.

<char> (**Character**) Format. Choose from:

- REIM - Real, imaginary data pairs
- LOG - Log magnitude, phase
- LINear - Linear magnitude, phase

Examples CSET:FIXT:CASC "D:\a.s2p","D:\b.s2p","D:\c.s2p",LOG

Query Syntax Not Applicable

Default Not Applicable

CSET:FIXTure:CHARacterize <cs1>,<cs2>,<port>,<s2p>,<char>[,<pivot>]

Applicable Models: All

(Write-only) Characterizes a fixture based on two Cal Sets. The stimulus settings of the two Cal Sets do NOT have to be identical, but they MUST have a common frequency range for interpolation. A new S2P file is created. Learn more about Cal Plane Manager.

Parameters

- <cs1> (String) Name of an existing Cal Set 1 which describes the cal closest to the VNA. The Cal Set must reside on the VNA.
- <cs2> (String) Name of an existing Cal Set 2 which describes the cal closest to the DUT. The Cal Set must reside on the VNA.
- <port> (Numeric) Port number described in the Cal Sets.
- <s2p> (String) Name of the S2P file containing the adapter/fixture characterization.
- <char> (**Character**) Format. Choose from:
- REIM - Real, imaginary data pairs
 - LOG - Log magnitude, phase
 - LINear - Linear magnitude, phase
- [<pivot>] (Numeric) Optional argument. Phase value for the specified port.

Examples

```
CSET:FIXT:CHAR "CalSet1", "CalSet2", 1, "Fixture.s2p"
```

```
cset:fixture:characterize "CalSet1", "CalSet2", 2, "Fixture.s2p", 90
```

Query Syntax Not Applicable

Default Not Applicable

CSET:FIXTure:DEEMbed <cs1>,<cs2>,<s2p>,<port>, <compPwr>[,extrap]

Applicable Models: All

(Write-only) De-embeds a fixture from an existing Cal Set based on an S2P file. A new Cal Set is created with the effects of the fixture removed.

When the new Cal Set is applied to a channel, the effects of fixturing are removed from the measurement data. Do NOT enable fixturing. The effects of the fixture are removed when the new Cal Set is selected and correction is turned ON.

Parameters

- <cs1> (String) Name of an existing Cal Set which resides on the VNA.
- <cs2> (String) Name of new Cal Set which contains updated error terms with fixture de-embedded.
- <s2p> (String) Name of the S2P file which characterizes the adapter/fixture.
- <port> (Numeric) Port number from which fixture will be de-embedded.

<compPwr> (Boolean)

ON (1) - When the Cal Set contains a power correction array for the fixture port, that array will be compensated for the fixture loss.

Warning: enabling power compensation can result in an increase in test port power and consequently, increased power to the DUT. Use with caution.

OFF (0) - Do not compensate for loss in source power through the fixture.

[extrap] (Boolean) Optional argument.

ON (1) -Applies a simple extrapolation when the S2P file has a narrower frequency range than the Cal Set. The values for the first and last data points are extended in either direction to cover the frequency range of the Cal Set.

OFF (0) - Extrapolation is NOT performed (default setting).

Examples

```
CSET:FIXT:DEEM "MyCalSet","MyNewCalSet","Fixture.s2p",1,1
```

```
cset:fixture:deembed  
"MyCalSet","MyNewCalSet","Fixture.s2p",1,1,1 'extrapolation is  
performed if the s2p frequency range is narrower than that of  
the Cal Set.
```

Query Syntax Not Applicable

Default Not Applicable

CSET:FIXTure:EMBed <cs1>,<cs2>,<s2p>,<port>, <compPwr>[,extrap]

Applicable Models: All

(Write-only) Embeds a fixture (usually a matching network) into an existing Cal Set based on an S2P file. A new Cal Set is created with the effects of the matching network included in the correction data.

When the new Cal Set is applied to a channel, the effects of the fixture are included in the measurement data. Do NOT enable fixturing. The effects of the matching network are included when the new Cal Set is selected and correction is turned ON.

Parameters

<cs1> (String) Name of an existing Cal Set which resides on the VNA.

<cs2> (String) Name of new Cal Set which contains updated error terms with fixture embedded.

<s2p> (String) Name of the S2P file which characterizes the fixture / matching network.

<port> (Numeric) Port number to which fixture will be added.

<compPwr> (Boolean)

ON (1) - Increase the source power to compensate for the loss through the fixture. The result is that the specified power level will be correct at the DUT input.

Warning: enabling power compensation can result in an increase in test port power and consequently, increased power to the DUT. Use with caution.

OFF (0) - Do not compensate for loss in source power through the matching network.

[extrap] (Boolean) Optional argument.

ON (1) -Applies a simple extrapolation when the S2P file has a narrower frequency range than the Cal Set. The values for the first and last data points are extended in either direction to cover the frequency range of the Cal Set.

OFF (0) - Extrapolation is NOT performed (default setting).

Examples

```
CSET:FIXT:EMB "MyCalSet","MyNewCalSet","Fixture.s2p",1,1
```

```
cset:fixture:embed "MyCalSet","MyNewCalSet","Fixture.s2p",1,1,1  
'extrapolation is performed if the s2p frequency range is  
narrower than that of the Cal Set.'
```

Query Syntax Not Applicable

Default Not Applicable

CSET:FIXTure:ENR:EMBed <inEnr>,<s2p>,<outEnr>

Applicable Models: All

(Write-only) Generate a new ENR file by embedding an adapter to an existing ENR file.

Parameters

<inEnr> (String) Path and filename of original ENR file.

<s2p> (String) Path and filename of the S2P file which characterizes the adapter/fixture network.

<outEnr> (String) Path and filename of new ENR file to output

Examples

```
CSET:FIXT:EMB "D:\Original.enr", "D:\adapter.s2p", "D:\new.enr"
```

Query Syntax Not Applicable

Default Not Applicable

CSET:FIXTure:ZERO<original_s4p>,<result_s4p>,<sparameters>,<complexformat>

Applicable Models: All

(Write-only) Creates a new S4P file.

Parameters

<original_s4p> (String) Path and filename of the original S4P file.

<result_s4p> (String) Path and filename of the new S4P file.

<sparameters> (String) Comma-separated terms to zero-out.

<complexformat> (**Character**) Format. Choose from:

- REIM - Real, imaginary data pairs
- LOG - Log magnitude, phase
- LIN - Linear magnitude, phase

Examples

```
CSET:FIXT:ZERO  
"D:\originalFile.s4p", "D:\newFile.s4p", "S11,S21,S33", LOG
```

Query Syntax Not Applicable

Default Not Applicable

CSET:ITEM:CATalog? <calset>

Applicable Models: All

(Read-only) The Cal Set mainly contains error term data for measurement correction purposes. But Cal Sets can also contain auxiliary information used to describe how the Cal Set was constructed. This information is stored as name value pairs and can be accessed by the item name. The catalog query returns a list of item names contained in the specific Cal Set being queried.

Parameters

<calset> (String) Name of the Cal Set item.

Examples CSET:ITEM:CAT? "mycalset"

Return Type String

Default Not Applicable

CSET:ITEM:DATA? <calset>,<itemName>

Applicable Models: All

(Read-Write) Returns the VNA Measurement Class or Channel that created the specific Cal Set item.

About Cal Set Items

A Cal Set item is a named value. You can list the named values using CSET:ITEM:CATalog? or SENS:CORR:CSET:ITEM:CATalog?

You can query the value of a specific item by asking for its data: CSET:ITEM:DATA?

For example, one of the items added by the VNA firmware to every Cal Set is named 'Created By'. The value attached to this item is the name of the VNA Measurement Class or Channel that created the Cal Set. When an SMC cal is performed, you can query the Cal Set for the 'Create By' item, and it will return 'Scalar Mixer/Converter'. The same query on an NFx channel returns 'Noise Figure Converters'.

CSET:ITEM:DATA? "mycalset", "Created By"

Parameters

<cnum> Any existing channel number. If unspecified, value is set to 1

<calset> (String) Name of the Cal Set item.

<itemName> (String) VNA Measurement Class or Channel that created the Cal Set.

Examples SENS:CORR:CSET:ITEM? "mycalset", "Created By"

Return Type String

Default Not Applicable

CSET:TIME? <string>

Applicable Models: All

(Read-only) Returns the (hour, minute, second) that the specified Cal Set was last saved. The time is returned in local time as setup in the VNA operating system.

See Also

CSET:DATE?

MMEM:DATE?

MMEM:TIME?

Parameters

<string> Cal Set name.

Examples

```
CSET:TIME? "CalSet_11"
```

```
'Returns:
```

```
+13,+6,+1
```

Return Type Comma-separated integers.

Default Not Applicable

Display Commands

Controls the settings of the front panel screen.

```
DISPlay:  
  ANNotation  
  |  
  FREQuency[:STATE]  
  | MESSage:STATe  
  | [:STATus]  
  ARRange  
  CATalog?  
  COLor More  
  Commands  
  ENABle  
  FSIGn  
  GUI  
  | POWer  
  | SPIN  
  | RESolution  
  MEASure  
  | DELete  
  | FEED  
  | MEMory  
  | [:STATe]  
  | MOVE  
  | SElect  
  | [:STATe]  
  | TITLe  
  | DATA  
  | [:STATe]  
  | Y[:SCALe]  
  | AUTO  
  | PDIVision  
  | RLEVel  
  | RPOStion  
  SHEet  
  | ARRange  
  | CATalog  
  | STATe  
  | TITLe:DATA  
  SPLit
```

```

STATus
  | LOG
    | CLEar
TMAX
TILE
TOOLbar
  | CSET[:STATe]
  | ENTRy[:STATe]
  |
EXTensions[:STATe]
  | KEYS[:STATe]
  | MARKer[:STATe]
  | MEAS[:STATe]
  | STIMulus[:STATe]
  | SWEep[:STATe]
  |
TRANSform[:STATe]
UPDate
  | IMMediate
  | [:STATe]
VISible
WINDow
  | ANNotation
    | LIMit
      | XPOSITION
      | YPOSITION
    | MARKer
      | COUPle
      | NUMBer
      | MEASre
        |
        | XPOSITION
        | YPOSITION
      | NUMBer
      | RESolution
        | RESPonse
        | STIMulus
    |
SINGle[:STATe]
  | SIZE
  | STATe
  | SYMBol
  |

```

ABOVe[:STATe]
 | **VISible**
 | **XPOSition**
 | **YPOSition**
 | **[:STATe]**
 | **TRACe[:STATe]**
 | **Y[:STATe]**
 | **CATalog?**
 | **ENABle**
 | **FEED**
 | **NEXT[:NUMBer]?**
 | **SIZE**
 | **[STATe]**
 | **TABLE**
 | **TITLe**
 | **DATA**
 | **[STATe]**
 | **TRACe**
 | **DELeTe**
 | **FEED**
 | **MNUMber**
 |
GRATicule:GRID:LTYPe
 | **MEMory[:STATe]**
 | **MOVE**
 | **NEXT[:NUMBer]?**
 | **SElect**
 | **[STATe]**
 | **TITLe**
 | **DATA**
 | **[:STATe]**
 | **Y[:SCALe]**
 | **AUTO**
 | **COUPle**
 | **METHod**
 | **[STATe]**
 | **PDIVision**
 | **RLEVel**
 | **RPOSition**
 | **Y:AUTO**
 | **Y[:SCALe]**
 | **DIVisions**

Click on a keyword to view the command details.

[Blue](#) keywords are superseded.

See Also

- [Referring to Traces Channels Windows and Meas Using SCPI](#)
 - See an [example](#) using some of these commands
 - [Synchronizing the Analyzer and Controller](#)
 - [Learn about Screen Setup](#)
 - [SCPI Command Tree](#)
-

DISPlay:ANNotation:FREQuency[:STATe] <ON | OFF>

Applicable Models: All

(Read-Write) Turns frequency information on the display title bar ON or OFF for all windows.

Parameters

<ON | OFF> **ON** (or 1) - turns frequency annotation ON.
OFF (or 0) - turns frequency annotation OFF.

Examples

```
DISP:ANN:FREQ ON  
display:annotation:frequency:state off
```

Query Syntax DISPlay:ANNotation:FREQuency[:STATe]?

Return Type Boolean (1 = ON, 0 = OFF)

Default **ON (1)**

DISPlay:ANNotation:MESSAge:STATe <ON | OFF>

Applicable Models: All

(Read-Write) Enables and disables error pop-up messages on the display.

Parameters

<ON | OFF> **ON** (or 1) - enables error pop-up messages
OFF (or 0) - disables error pop-up messages

Examples

```
DISP:ANN:MESS:STAT ON  
display:annotation:message:state off
```

Query Syntax DISPlay:ANNotation:MESSage:STATe?

Return Type Boolean (1 = ON, 0 = OFF)

Default **ON (1)**

DISPlay:ANNotation[:STATus] <ON | OFF>

Applicable Models: All

(Read-Write) Turns the status bar at the bottom of the screen ON or OFF. The status bar displays information for the active window.

Parameters

<ON | OFF> **ON** (or 1) - turns status bar ON.
OFF (or 0) - turns status bar OFF.

Examples

```
DISP:ANN ON  
display:annotation:status off
```

Query Syntax DISPlay:ANNotation[:STATus]?

Return Type Boolean (1 = ON, 0 = OFF)

Default Last state that was set

DISPlay:ARRange <char>

Applicable Models: All

(Write-only) Places EXISTING measurements into pre-configured window arrangements. Overlay, Stack(2), Split(3), and Quad(4) creates new windows. To learn more, see [Window Layout](#).

Parameters

<char> Window arrangement. Choose from:

- TILE - tiles existing windows
- CAScade - overlaps existing windows
- OVERlay - all traces placed in 1 window
- STACk - 2 windows
- SPLit - 3 windows
- QUAD - 4 windows
- MEASure - 1 measurement per window
- CHANnel - 1 channel per window
- LTOR - Arrange existing windows as a single row of side-by-side windows.

Examples

```
DISP:ARR CASC
display:arrange cascade
```

Query Syntax Not Applicable

Default TILE

DISPlay:CATalog?

Applicable Models: All

(Read-only) Returns the existing Window numbers.

Note: If there are no traces in the window, this query returns the "EMPTY" string.

To read the window number of the selected trace, use [Calc:Par:WNUM](#).

Return Type String of Character values, separated by commas

Example

```
Two windows with numbers 1 and 2 returns:
"1,2"
```

Default Not applicable

DISPlay:ENABle <ON | OFF>

Applicable Models: All

(Read-Write) Specifies whether to disable or enable all analyzer display information **in all windows** in the analyzer application. Marker data is not updated. More CPU time is spent making measurements instead of updating the display.

Parameters

<ON | OFF> **ON** (or 1) - turns the display ON.
OFF (or 0) - turns the display OFF.

Examples

```
DISP:ENAB ON  
display:enable off
```

Query Syntax DISPlay:ENABle?

Return Type Boolean (1 = ON, 0 = OFF)

Default ON

DISPlay:FSIGn <ON | OFF>

Applicable Models: All

(Read-Write) Shows or hides the window which displays global pass/fail results.

Parameters

<ON | OFF> **ON** (or 1) - displays the pass/fail dialog
OFF (or 0) - hides the pass/fail dialog

Examples

```
DISP:FSIG ON  
display:fsign off
```

Query Syntax DISPlay:FSIGn?

Return Type Boolean (1 = ON, 0 = OFF)

Default OFF

DISPlay:GUI:POWER:SPIN:RESolution <real>

Applicable Models: All

(Read-Write) Sets and returns the resolution of the front panel knob when it is used to adjust Source Power manually.

Parameters

<real> Spin resolution value (Real value). The range of acceptable values is 0.01 to 100.

Examples

```
DISP:GUI:POW:SPIN:RES 0.01 'Write - Every tick of the front panel knob  
will change the Power Level by 0.01 dBm.  
display:gui:power:spin:resolution 0.01
```

**Query
Syntax**

DISPlay:GUI:POWer:SPIN:RESolution?

**Return
Type**

Real

Default

0.1

DISPlay:MEASure<mnum>:DELete

Applicable Models: All

(Write-only) Deletes the trace associated with the specified measurement number.

Note: The measurement is not deleted. This command does the reverse of **DISP:MEAS:FEED**.

Parameters

<mnum> Measurement number for each measurement. There must be a selected measurement on the trace. If unspecified, <mnum> is set to 1.

Examples

```
DISP:MEAS:DEL  
display:measure2:delete
```

**Query
Syntax**

DISPlay:MEASure<mnum>:DELete?

**Return
Type**

Not Applicable

Default

Not Applicable

DISPlay:MEASure<mnum>:FEED <wnum>

Applicable Models: All

(Write-only) This command creates a new trace in the specified window and connects the trace to measurement which results in the trace displaying the data from measurement.

Parameters

- <mnum> Measurement number for the measurement. If unspecified, <mnum> is set to 1.
- <wnum> Display the measurement in a specified Window number. The window must be turned on. In addition, a window number must be specified. The range is 1 to 160.

Examples

```
DISP:MEAS2:FEED 10  
display:measure:feed 90
```

Return Type Not Applicable
Default Not Applicable

DISPlay:MEASure<mnum>:MEMory[:STATe] <bool>

Applicable Models: All

(Read-Write) Turns the memory trace ON or OFF for the specified measurement.

Note: **DISP:MEAS:FEED** must first be done to feed the measurement to a trace. This command behaves the same as **DISP:WIND:TRAC:MEM[:STAT]** except that it only requires the measurement number.

Parameters

- <mnum> Measurement number for each measurement. There must be a selected measurement on the trace. If unspecified, <mnum> is set to 1.
- <bool> **ON or 1 - Turns the memory trace ON.**
OFF or 0 - Turns the memory trace OFF.

Examples

```
DISP:MEAS:MEM ON  
display:measure:memory:state off
```

Query Syntax DISPlay:MEASure<mnum>:MEMory[:STATe]?

Return Type Boolean
Default OFF

DISPlay:MEASure<mnum>:MOVE <toWin>

Applicable Models: All

(Write-only) Moves a trace associated with measurement number to the specified window. If the window is OFF, it will be turn ON.

Parameters

- <mnum> Measurement number for each measurement. There must be a selected measurement on the trace. If unspecified, <mnum> is set to 1.
- <toWin> **Number of the window to which the specified measurement is moved. If the window does not exist, it will be created.**

Examples `DISP:MEAS:MOVE 2`
`display:measure:move 1`

Query Not Applicable
Syntax Not Applicable
Default Not Applicable

DISPlay:MEASure<mnum>:SElect

Applicable Models: All

(Write-only) Activates the specified measurement to be selected.

Parameters

- <mnum> Measurement number for each measurement. There must be a selected measurement on the trace. If unspecified, <mnum> is set to 1.

Examples `DISP:MEAS:SEL`
`display:measure:select`

Query Not Applicable
Syntax Not Applicable
Default Not Applicable

DISPlay:MEASure<mnum>[:STATe] <bool>

Applicable Models: All

(Read-Write) Turns ON or OFF the display of a trace associated with the specified measurement. When OFF, the measurement behind the trace is still active.

Note: A trace must first be created (via FEED), then the visibility of the trace can be affected with this command. If the trace has not been created, an error is generated: 107,Requested trace not found.

Parameters

<mnum> Measurement number for each measurement. There must be a selected measurement on the trace. If unspecified, <mnum> is set to 1.

<bool> **ON or 1 - Turns the trace ON.**
OFF or 0 - Turns the trace OFF.

Examples

```
DISP:MEAS:STAT ON
display:measure off
```

Query Syntax DISPlay:MEASure<mnum>[:STATe]?

Return Type Boolean

Default ON or 1

DISPlay:MEASure<mnum>:TITLe:DATA <string>

Applicable Models: All

(Read-Write) Sets or gets the title for the specified measurement. The trace title is embedded in the trace status field. [Learn more about Trace Titles.](#)

Newer entries replace (not append) older entries. The title is turned ON and OFF with **DISP:WIND:TRAC:TITL:STAT.**

Parameters

<mnum> Measurement number for each measurement. There must be a selected measurement on the trace. If unspecified, <mnum> is set to 1.

<string> **Used as the title to be displayed for the measurement. Any characters (not spaces) enclosed with quotes.**

Examples

```
DISP:MEAS:TITL:DATA 'MyNewMeas'
display:measure:title:data 'hello'
```

Query Syntax DISPlay:MEASure<mnum>:TITLe:DATA?

Return Type String

Default Not Applicable

DISPlay:MEASure<mnum>:TITLe[:STATe] <bool>

Applicable Models: All

(Read-Write) Turns ON or OFF the measurement title.

Note: The measurement and trace need to exist. When turned OFF, the previous trace title returns. Set a new trace title using `DISP:WIND:TRAC:TITL:DATA`

[Learn more about Trace Titles](#)

Parameters

<mnum> Measurement number for each measurement. There must be a selected measurement on the trace. If unspecified, <mnum> is set to 1.

<bool> **ON or 1 - turns the title ON.**

OFF or 0 - turns the title OFF.

Examples

```
DISP:MEAS:TITL ON
display:measure:title:state off
```

Query Syntax

DISPlay:MEAS<mnum>:TITLe[:STATe]?

Return Type

Boolean

Default

OFF or 0

DISPlay:MEASure<mnum>:Y[:SCALe]:AUTO

Applicable Models: All

(Write-only) Performs an Autoscale on the specified trace in the specified measurement, providing the best fit display.

Autoscale is performed only when the command is sent; it does NOT keep the trace autoscaled indefinitely.

Autoscale behaves differently when **scale coupling** is enabled. How it behaves depends on the scale coupling method. [Learn more.](#)

See Also, `DISPlay:WINDow:Y:AUTO` which performs an Autoscale All.

Parameters

<mnum> Measurement number for each measurement. There must be a selected measurement on the trace. If unspecified, <mnum> is set to 1.

Examples

```
DISP:MEAS:Y:AUTO
display:measure:y:scale:auto
```

Query Syntax

Not Applicable

Default

Not Applicable

DISPlay:MEASure<mnum>:Y[:SCALe]:PDIVision <num>

Applicable Models: All

(Read-Write) Sets the Y axis Scale Per Division value of the specified trace associated with the specified measurement.

Note: The measurement and trace need to exist.

Parameters

- <mnum> Measurement number for each measurement. There must be a selected measurement on the trace. If unspecified, <mnum> is set to 1.
- <num> Units / division value (Real value). The range of acceptable values is dependent on format and domain.

Note: This command will accept MIN or MAX instead of a numeric parameter. See [SCPI Syntax](#) for more information.

Examples

```
DISP:MEAS:Y:PDIV 1
display:measure:y:scale:pdivision maximum
```

Query Syntax

DISPlay:MEASure<mnum>:Y[:SCALe]:PDIVision?

Return Type

Numeric

Default **10**

DISPlay:MEASure<mnum>:Y[:SCALe]:RLEVel <num>

Applicable Models: All

(Read-Write) Sets the Y axis Reference Level of the specified trace associated with the specified measurement.

Note: The measurement and trace need to exist.

Parameters

- <mnum> Measurement number for each measurement. There must be a selected measurement on the trace. If unspecified, <mnum> is set to 1.
- <num> Reference level value (Real value). The range of acceptable values is dependent on format and domain.

Note: This command will accept MIN or MAX instead of a numeric parameter. See [SCPI Syntax](#) for more information.

Examples

```
DISP:MEAS:Y:RLEV 0
display:measure:y:scale:rlevel minimum
```

Query Syntax **DISPlay:MEASure<mnum>:Y[:SCALe]:RLEVel?**
Return Type **Numeric**
Default **0**

DISPlay:MEASure<mnum>:Y[:SCALe]:RPOSition <num>

Applicable Models: All

(Read-Write) Sets the Reference Position of the specified trace associated with the specified measurement.

Note: The measurement and trace need to exist.

Parameters

- <mnum> Measurement number for each measurement. There must be a selected measurement on the trace. If unspecified, <mnum> is set to 1.
- <num> Reference position on the screen measured in horizontal graticules from the bottom (Real value). The range of acceptable values is dependent on format and domain.

Note: This command will accept MIN or MAX instead of a numeric parameter. See **SCPI Syntax** for more information.

Examples

```
DISP:MEAS:Y:RPOS 0  
display:measure:y:rposition maximum
```

Query Syntax **DISPlay:MEASure<mnum>:Y[:SCALe]:RPOSition?**
Return Type **Numeric**
Default **5**

DISPlay:SHEet<num>:ARRange <char>

Applicable Models: All

(Write-only) This command arranges existing windows to sheets.

Parameters

- <num> Sheet number
- <char> Sheet arrangement. Choose from:
 - WINDow: one sheet per window
 - CHANnel: one sheet per channel
 - TRACe: one channel per sheet
 - ONE: merge all windows into one sheet

Examples

```
DISP:SHE:ARR CHAN  
display:sheet:arrange channel
```

Query Syntax Not Applicable

Return Type Not Applicable

Default One sheet per window

DISPlay:SHEet<num>:CATalog?

Applicable Models: All

(Read-only) This command reads and displays comma separated list of window numbers which the sheet contains.

Parameters

- <num> Sheet number

Examples

```
DISP:SHE:CAT?  
display:sheet:catalog?
```

Return Type Character

Default 1

DISPlay:SHEet<num>:STATe

Applicable Models: All

(Write-only) Sets the sheet visible and invisible:

ON: If OFF, sets the sheet visible with a new window.

OFF: If ON, sets the sheet invisible with all the containing window state OFF
(DISPlay:WINDow:STATe OFF)

Parameters

<num> Sheet number

Examples

```
DISP:SHE:STAT ON
```

```
display:sheet:state off
```

Query Syntax DISPlay:SHEet:STATe?

Return Type Bool

Default OFF except for Sheet 1

DISPlay:SHEet<num>:TITLe:DATA <char>

Applicable Models: All

(Read-Write) This command sets or gets the sheet label.

Parameters

<num> Sheet number

<char> The label of the sheets. Default and present value is "Sheet 1"

Examples

```
DISP:SHE:TITL:DATA "Sheet 1"
```

```
display:sheet:title:data "Sheet 1"
```

Query Syntax DISPlay:SHEet:TITLe:DATA?

Return Type Character

Default "Sheet 1"

DISPlay:SPLit <num>

Applicable Models: All

(Write-only) Destroys all existing traces, channels and windows, then creates N windows. No channels are created.

Parameters

<num> N is 1 or greater.

Examples

```
DISP:SPL  
display:split
```

Query Syntax

DISPlay:SPLit?

Return Type

Numeric

Default

Not Applicable

DISPlay:STATus:LOG:CLEar

Applicable Models: All

(Write-only) Clears the message region in the status bar.

Parameters

Examples

```
DISP:STAT:LOG:CLE  
display:status:log:clear
```

Query Syntax

Not Applicable

Default

Not Applicable

DISPlay:TMAX <bool>

Applicable Models: All

(Read-Write) Maximizes (isolates) or restores the active trace in the active window. When turned ON, the active trace is the ONLY trace on the display. All other traces are hidden. [Learn more.](#)

Parameters

<bool> **ON** (or 1) - Maximize / isolates the active trace.

OFF (or 0) - Restores other traces to the normal window setting.

Examples

```
DISP:TMAX ON  
display:tmax 0
```

Query Syntax

DISPlay:TMAX?

Return Type

Boolean (1 = ON, 0 = OFF)

Default

OFF

DISPlay[:TILE] - **Superseded**

This command is replaced by [DISP:ARRange](#)

(Write-only) Tiles the windows on the screen.

Examples `DISP
display:tile`

Default Not Applicable

DISPlay:TOOLbar:CSET[:STATe] <bool>

Applicable Models: All

(Read-Write) Show or hide the calset toolbar.

Parameters

<bool> **ON** (or 1) - Toolbar ON.

OFF (or 0) - Toolbar OFF.

Examples `DISP:TOOL:CSET ON
display:toolbar:cset:state off`

Query Syntax DISPlay:TOOLbar:CSET[:STATe]?

Return Type Boolean (1 = ON, 0 = OFF)

Default ON

DISPlay:TOOLbar:ENTRy[:STATe] <bool>

Applicable Models: All

(Read-Write) Specifies whether to show or hide the active entry toolbar. [See this toolbar.](#)

Parameters

<bool> **ON** (or 1) - Toolbar ON.

OFF (or 0) - Toolbar OFF.

Examples

```
DISP:TOOL:ENTR ON  
display:toolbar:entry:state off
```

Query Syntax DISPlay:TOOLbar:ENTRy[:STATe]?

Return Type Boolean (1 = ON, 0 = OFF)

Default ON

DISPlay:TOOLbar:EXTensions[:STATe] <bool>

Applicable Models: All

(Read-Write) Specifies whether to show or hide the port extensions toolbar. [See this toolbar.](#)

Parameters

<bool> **ON** (or 1) - Toolbar ON.

OFF (or 0) - Toolbar OFF.

Examples

```
DISP:TOOL:EXT ON  
display:toolbar:extensions:state off
```

Query Syntax DISPlay:TOOLbar:EXTensions[:STATe]?

Return Type Boolean (1 = ON, 0 = OFF)

Default ON

DISPlay:TOOLbar:KEYS[:STATe] <bool>

Applicable Models: All

(Read-Write) Specifies whether to show or hide the virtual hardkeys on the VNA display. These are primarily used when the VNA is accessed remotely using VNC or Windows Remote Desktop.

Parameters

<bool> **ON** (or 1) - Keys ON.

OFF (or 0) - Keys OFF.

Examples

```
DISP:TOOL:KEYS ON  
display:toolbar:keys:state off
```

Query Syntax DISPLAY:TOOLbar:KEYS [:STATe]?

Return Type Boolean (1 = ON, 0 = OFF)

Default ON

DISPlay:TOOLbar:MARKer[:STATe] <bool>

Applicable Models: All

(Read-Write) Specifies whether to show or hide the marker toolbar. [See this toolbar.](#)

Parameters

<bool> **ON** (or 1) - Toolbar ON.

OFF (or 0) - Toolbar OFF.

Examples

```
DISP:TOOL:MARK ON  
display:toolbar:marker:state off
```

Query Syntax DISPlay:TOOLbar:MARKer[:STATe]?

Return Type Boolean (1 = ON, 0 = OFF)

Default ON

DISPlay:TOOLbar:MEASurement[:STATe] <bool> **OBSOLETE**

This toolbar was eliminated with A.10.00

(Read-Write) Specifies whether to show or hide the measurement toolbar.

Parameters

<bool> **ON** (or 1) - Toolbar ON.

OFF (or 0) - Toolbar OFF.

Examples

```
DISP:TOOL:MEAS ON  
display:toolbar:measurement:state off
```

Query Syntax DISPlay:TOOLbar:MEASurement[:STATe]?

Return Type Boolean (1 = ON, 0 = OFF)

Default ON

DISPlay:TOOLbar:STIMulus[:STATe] <bool> OBSOLETE

This toolbar was eliminated with A.10.00

(Read-Write) Specifies whether to show or hide the stimulus toolbar.

Parameters

<bool> **ON** (or 1) - Toolbar ON.

OFF (or 0) - Toolbar OFF.

Examples

```
DISP:TOOL:STIM ON  
display:toolbar:stimulus:state off
```

Query Syntax DISPlay:TOOLbar:STIMulus[:STATe]?

Return Type Boolean (1 = ON, 0 = OFF)

Default ON

DISPlay:TOOLbar:SWEep[:STATe] <bool> OBSOLETE

This toolbar was eliminated with A.10.00

(Read-Write) Specifies whether to show or hide the sweep control toolbar.

Parameters

<bool> **ON** (or 1) - Toolbar ON.

OFF (or 0) - Toolbar OFF.

Examples

```
DISP:TOOL:SWE ON  
display:toolbar:sweep:state off
```

Query Syntax DISPlay:TOOLbar:SWEEp[:STATe]?

Return Type Boolean (1 = ON, 0 = OFF)

Default ON

DISPlay:TOOLbar:TRANSform[:STATe] <bool>

Applicable Models: All

(Read-Write) Specifies whether to show or hide the Time Domain toolbar. [See this toolbar.](#)

Parameters

<bool> **ON** (or 1) - Toolbar ON.

OFF (or 0) - Toolbar OFF.

Examples

```
DISP:TOOL:TRAN ON  
display:toolbar:transform:state off
```

Query Syntax DISPlay:TOOLbar:TRANSform[:STATe]?

Return Type Boolean (1 = ON, 0 = OFF)

Default ON

DISPlay:UPDate[:STATe] <bool>

Applicable Models: All

(Read-Write) Enables or disables display updates. Disabling display updates improves measurement performance. When disabled, the display windows (traces, markers, etc.) are frozen.

Parameters

<bool> **ON** (or 1) - Toolbar ON.

OFF (or 0) - Toolbar OFF.

Examples

```
DISP:UPD ON
```

```
display:update:state off
```

Query Syntax DISPlay:UPDate[:STATe]?

Return Type Boolean (1 = ON, 0 = OFF)

Default ON

DISPlay:UPDate:IMMEDIATE

Applicable Models: All

(Write-only) Executes the display update once when the display update of the LCD screen is set to OFF (specifying False with the **DISPlay:ENABle** object).

Parameters

Examples

```
DISP:UPD:IMM
```

```
display:update:immediate
```

Query Syntax **Not Applicable**

Return Type Not Applicable

Default Not Applicable

DISPlay:VISible <ON | OFF>

Applicable Models: All

(Read-Write) Makes the VNA application visible or not visible. In the Not Visible state, the analyzer cycle time for making measurements, and especially data transfer, can be significantly faster because the display does not process data.

Parameters

<ON | OFF> **ON** (or 1) - VNA app is visible
OFF (or 0) - VNA app is NOT visible

Examples

```
DISP:VIS ON  
display:visible off
```

Query Syntax DISPlay:VISible?

Return Type Boolean (1 = ON, 0 = OFF)

Default ON

DISPlay:WINDow<wnum>:ANNotation:LIMit:XPOSition <num>

Applicable Models: All

(Read-Write) Sets and returns the X-axis position of the Limit Line Pass/Fail indicator on the VNA screen. The lower-left corner of the Pass/Fail indicator is the point of reference for positioning.

Parameters

<wnum> Any existing window number. If unspecified, value is set to 1.
<num> X-axis position. Choose a value between 0 (far left) and 10 (far right).

Examples

```
DISP:WIND:ANN:LIM:XPOS 1.5  
display:window:annotation:limit:xposition 5
```

Query Syntax DISPlay:WINDow:ANNotation:LIMit:XPOSition?

Return Type Numeric

Default 7

DISPlay:WINDow<wnum>:ANNotation:LIMit:YPOSition <num>

Applicable Models: All

(Read-Write) Sets and returns the Y-axis position of the Limit Line Pass/Fail indicator on the VNA screen. The lower-left corner of the Pass/Fail indicator is the point of reference for positioning.

Parameters

- <wnum> Any existing window number. If unspecified, value is set to 1.
- <num> Y-axis position. The maximum position is limited to the current Y-axis division value. Choose a value between 2 (bottom) and 30 (top).

Examples

```
DISP:WIND:ANN:LIM:YPOS 1.5  
display>window:annotation:limit:yposition 5
```

Query Syntax DISPlay:WINDow:ANNotation:LIMit:YPOSition?

Return Type Numeric

Default 0

DISPlay:WINDow<wnum>:ANNotation:MARKer:COUPlE[:STATe] <bool>

Applicable Models: All

(Read-Write) Sets the marker readouts to coupled (one combination annotation) or not coupled (one annotation per trace). This setting is per Window scope.

See other SCPI **Marker** commands. Learn more about **Marker readout**.

Parameters

- <wnum> Any existing window number. If unspecified, value is set to 1.
- <bool> **ON** (or 1) - Marker readouts are coupled
OFF (or 0) - Marker readouts are not coupled

Examples

```
DISP:WIND:ANN:MARK:COUP ON  
display>window:annotation:marker:couple on
```

Query Syntax DISPlay:WINDow:ANNotation:MARKer:COUPlE?

Return Type Boolean

Default ON

DISPlay:WINDow<wnum>:ANNotation:MARKer:NUMBer <num>

Applicable Models: All

This command replaces `DISP:WIND:ANN:MARK:SINGLE`

(Read-Write) Sets the number of marker readouts to display per trace. Display up to 20 marker readouts per window.

See other SCPI **Marker** commands. Learn more about **Marker readout**.

Parameters

- <wnum> Any existing window number. If unspecified, value is set to 1.
- <num> Number of marker readouts to display. Choose a value between 1 and 16.

Examples

```
DISP:WIND:ANN:MARK:NUMB 7  
display>window:annotation:marker:number 2
```

Query Syntax DISPlay:WINDow:ANNotation:MARKer:NUMBer?

Return Type Numeric

Default 5

`DISPlay:WINDow:ANNotation:MARKer:MEASure<mnum>:XPOSition <num>`

Applicable Models: All

(Read-Write) Sets the X-axis position of marker readouts. Readouts are right-justified at the specified position. This function is used when `:DISP:WIND:ANN:MARK:COUP:STAT` is off. Use `:DISP:WIND:ANN:MARK:XPOS` is used when `:DISP:WIND:ANN:MARK:COUP:STAT` is on.

See other SCPI **Marker** commands. Learn more about **Marker readout**.

Parameters

- <mnum> Measurement. If unspecified, value is set to 1.
- <num> X-axis position. Choose a value between 1 (far left) and 10 (far right).

Examples

```
DISP:WIND:ANN:MARK:MEAS:XPOS 1.5  
display>window:annotation:marker:measure:xposition 5
```

Query Syntax DISPlay:WINDow:ANNotation:MARKer:MEASure:XPoSition?

Return Type Numeric

Default 10

`DISPlay:WINDow:ANNotation:MARKer:MEASure<mnum>:YPOSition <num>`

Applicable Models: All

(Read-Write) Sets the Y-axis position of marker readouts. Readouts are top-justified at the specified position. This function is used when `:DISP:WIND:ANN:MARK:COUP:STAT` is off. Use `:DISP:WIND:ANN:MARK:YPOS` is used when `:DISP:WIND:ANN:MARK:COUP:STAT` is on.

See other SCPI **Marker** commands. Learn more about **Marker readout**.

Parameters

- `<mnum>` Measurement. If unspecified, value is set to 1.
- `<num>` Y-axis position. Choose a value between 1 (bottom) and 10 (top).

Examples

```
DISP:WIND:ANN:MARK:MEAS:YPOS 1.5  
display>window:annotation:marker:measure:yposition 5
```

Query Syntax `DISPlay:WINDow:ANNotation:MARKer:MEASure:YPOSition?`

Return Type Numeric

Default 10

DISPlay:WINDow<wnum>:ANNotation:MARKer:RESolution:STIMulus <num>

Applicable Models: All

(Read-Write) For the X-axis (stimulus), sets the number digits to display after the decimal point in marker readouts.

See other SCPI **Marker** commands. Learn more about **Marker readout**.

Parameters

- `<wnum>` Any existing window number. If unspecified, value is set to 1.
- `<num>` Number of digits to display. Choose a value between 2 and 6.

Examples

```
DISP:WIND:ANN:MARK:RES:STIM 2  
display>window:annotation:marker:resolution:stimulus 4
```

Query Syntax `DISPlay:WINDow:ANNotation:MARKer:RESolution:STIMulus?`

Return Type Numeric

Default 3

DISPlay:WINDow<wnum>:ANNotation:MARKer:RESolution:RESPonse <num>

Applicable Models: All

(Read-Write) For the Y-axis (response), sets the number digits to display after the decimal point in marker readouts.

See other SCPI **Marker** commands. Learn more about **Marker readout**.

Parameters

- <wnum> Any existing window number. If unspecified, value is set to 1.
- <num> Number of digits to display. Choose a value between 1 and 4.

Examples

```
DISP:WIND:ANN:MARK:RES:RESP 1
display>window:annotation:marker:resolution:stimulus 2
```

Query Syntax DISPlay:WINDow:ANNotation:MARKer:RESolution:RESPonse?

Return Type Numeric

Default 2

DISPlay:WINDow<wnum>:ANNotation:MARKer:SINGLE[:STATe] <bool> - Superseded

Applicable Models: All

Note: This command is replaced by **DISP:WIND:ANN:MARK:NUMB**

(Read-Write) Either shows marker readout of only the active trace or other traces simultaneously.

See other SCPI **Marker** commands. Learn more about **Marker readout**.

Parameters

- <wnum> Any existing window number. If unspecified, value is set to 1.
- <bool> **ON** (or 1) - Shows the readout of only the active marker for each trace.
OFF (or 0) - Shows up to 5 marker readouts per trace, up to 20 total readouts.

Examples

```
DISP:WIND:ANN:MARK:SING ON
display>window:annotation:marker:single off
```

Query Syntax DISPlay:WINDow:ANNotation:MARKer:SINGLE?

Return Type Boolean (1 = ON, 0 = OFF)

Default OFF

DISPlay:WINDow<wnum>:ANNotation:MARKer:SIZE <char>

Applicable Models: All

(Read-Write) Specifies the size of the marker readout text. See other SCPI **Marker** commands. Learn more about **Marker readout**.

Parameters

- <wnum> Any existing window number. If unspecified, value is set to 1.
- <char> Readout text size. Choose from: **NORMAL** | **LARGE**

Examples

```
DISP:WIND:ANN:MARK:SIZE LARG  
display>window:annotation:marker:size normal
```

Query Syntax DISPlay:WINDow:ANNotation:MARKer:SIZE?

Return Type Character

Default NORMAL

DISPlay:WINDow<wnum>:ANNotation:MARKer[:STATe] <ON | OFF>

Applicable Models: All

(Read-Write) Specifies whether to show or hide the Marker readout (when markers are ON) on the selected window. See other SCPI **Marker** commands. Learn more about **Marker readout**.

Parameters

- <wnum> Any existing window number. If unspecified, value is set to 1.
- <ON | OFF> **ON** (or 1) - turns marker readout ON.
OFF (or 0) - turns marker readout OFF.

Examples

```
DISP:WIND:ANN:MARK ON  
display>window:annotation:marker:state off
```

Query Syntax DISPlay:WINDow:ANNotation:MARKer[:STATe]?

Return Type Boolean (1 = ON, 0 = OFF)

Default ON

DISPlay:WINDow<wnum>:ANNotation:MARKer:SYMBOL <char>

Applicable Models: All

(Read-Write) Sets the symbol to display for marker position.

See other SCPI **Marker** commands.

Parameters

<wnum> Any existing window number. If unspecified, value is set to 1.

<char> Marker symbol. Choose from:

TRIangle

FLAG

LINE

[See pictures of each](#)

Examples

```
DISP:WIND:ANN:MARK:SYMB TRI
```

```
display>window:annotation:marker:symbol line
```

Query Syntax DISPlay:WINDow:ANNotation:MARKer:SYMBol?

Return Type Character

Default TRIangle

DISPlay:WINDow<wnum>:ANNotation:MARKer:VISible <char>

Applicable Models: All

(Read-Write) Shows the marker readouts only for active trace or for all traces. This setting is per Window scope. [See this toolbars](#)

Parameters

<wnum> Any existing window number. If unspecified, value is set to 1.

<char> **ACTive** - readout is turned on for active trace only.

ALL - readout is turned on for all traces.

Examples

```
DISP:WIND:ANN:MARK:VIS ACT
```

```
display>windows:annotation:marker:visible all
```

Query Syntax DISPlay:WINDow:ANNotation:MARKer:VISible?

Return Type Character

DISPlay:WINDow<wnum>:ANNotation:MARKer:SYMBol:ABOVe[:STATe] <ON | OFF>

Applicable Models: E5080, M9485A

(Read-Write) Specifies whether or not to force marker symbols to be displayed above the trace. When ON, all marker symbols will be displayed above the trace and the active marker will be filled solid. See other SCPI **Marker** commands.

Parameters

- <wnum> Any existing window number. If unspecified, value is set to 1.
- <ON | OFF> **ON (or 1)** - ALL marker symbols are displayed above the trace. Only the active marker is filled solid.
OFF (or 0) - ONLY the active marker is displayed above the trace. The active marker is not filled solid.

Examples

```
DISP:WIND:ANN:MARK:SYMB:ABOV ON
display:window:annotation:marker:symbol:above:state off
```

Query Syntax DISPlay:WINDow:ANNotation:MARKer:SYMBol:ABOVe[:STATe]?

Return Type Boolean (1 = ON, 0 = OFF)

Default OFF - ON in IM Spectrum and SA measurement classes

DISPlay:WINDow<wnum>:ANNotation:MARKer:XPOSition <num>

Applicable Models: All

(Read-Write) Sets the X-axis position of marker readouts. Readouts are right-justified at the specified position.

See other SCPI **Marker** commands. Learn more about **Marker readout**.

Parameters

- <wnum> Any existing window number. If unspecified, value is set to 1.
- <num> X-axis position. Choose a value between 1 (far left) and 10 (far right).

Examples

```
DISP:WIND:ANN:MARK:XPOS 1.5
display:window:annotation:marker:xposition 5
```

Query Syntax DISPlay:WINDow:ANNotation:MARKer:XPOSition?

Return Type Numeric

DISPlay:WINDow<wnum>:ANNotation:MARKer:YPOSition <num>

Applicable Models: All

(Read-Write) Sets the Y-axis position of marker readouts. Readouts are top-justified at the specified position.

See other SCPI **Marker** commands. Learn more about **Marker readout**.

Parameters

- <wnum> Any existing window number. If unspecified, value is set to 1.
- <num> Y-axis position. Choose a value between 1 (bottom) and 10 (top).

Examples

```
DISP:WIND:ANN:MARK:YPOS 1.5
display>window:annotation:marker:yposition 5
```

Query Syntax DISPlay:WINDow:ANNotation:MARKer:YPOSition?

Return Type Numeric

Default 10

DISPlay:WINDow<wnum>:ANNotation[:TRACe][:STATe] <ON | OFF>

Applicable Models: All

(Read-Write) Specifies whether to show or hide the Trace Status buttons on the left of the display.

Parameters

- <wnum> Any existing window number. If unspecified, value is set to 1.
- <ON | OFF> **ON** (or 1) - turns the buttons ON.
OFF (or 0) - turns the buttons OFF.

Examples

```
DISP:WIND:ANN ON
display>window:annotation:trace:state off
```

Query Syntax DISPlay:WINDow:ANNotation[:TRACe][:STATe]?

Return Type Boolean (1 = ON, 0 = OFF)

Default ON

DISPlay:WINDow<wnum>:ANNotation: Y[:STATe] <bool>

Applicable Models: All

(Read-Write) Turns ON or OFF the Y-axis scale label in display window.

Parameters

<wnum> Any existing window number. If unspecified, value is set to 1.

<bool> **ON or 1** - Turns ON the Y-axis scale.
OFF or 0 - Turns OFF the Y-axis scale.

Examples `DISP:WIND:ANN:Y ON`
`display>window:annotation:y off`

Query Syntax `DISPlay:WINDow:ANNotation:Y?`

Return Type Boolean

Default ON or 1

DISPlay:WINDow<wnum>:CATalog?

Applicable Models: All

(Read-only) Returns the trace numbers for the specified window.

Note: If there are no traces in the window, this query returns the "EMPTY" string.

Parameters

<wnum> Any existing window number. If unspecified, value is set to 1.

Example Window 1 with four traces:
`DISPlay:WINDow1:CATalog?`
Returns:
`"1,2,3,4"`

Return Type String of Character values separated by commas

Default Not applicable

DISPlay:WINDow<wnum>:ENABle <ON | OFF>

Applicable Models: All

(Read-Write) Specifies whether to disable or enable all analyzer display information **in the specified window**. Marker data is not updated. More CPU time is spent making measurements instead of updating the display.

Parameters

- <wnum> Any existing window number. If unspecified, value is set to 1.
- <ON | OFF> **ON** (or 1) - turns the display ON.
OFF (or 0) - turns the display OFF.

Examples

```
DISP:WIND:ENABle ON  
display:window1:enable off
```

Query Syntax DISPlay:WINDow<wnum>:ENABle?

Return Type Boolean (1 = ON, 0 = OFF)

Default ON

DISPlay:WINDow<wnum>:FEED <snum>

Applicable Models: All

(Write-only) This command feeds a specified window to the sheet. If there is a window in the sheet, the sheet is visible. If there is no window in the sheet, the sheet is not visible. If no windows exists in the system, one empty sheet is visible.

Parameters

- <wnum> Any existing window number. If unspecified, value is set to 1.
- <snum> Sheet number

Examples

```
DISP:WIND:FEED 5  
display:window:feed 5
```

Return Type Not Applicable

Default Not Applicable

DISPlay:WINDow<wnum>:NEXT[:NUMBer]?

Applicable Models: All

(Read-only) Returns the lowest window number which has less than the maximum number of traces. Basically, returns the first window which has room for another trace. Note that the window may need to be turned on first (i.e. disp:wind:stat ON may be needed).

Parameters

<wnum> Any existing window number. If unspecified, value is set to 1.

Examples

```
DISP:WIND:NEXT  
display:window1:NEXT
```

Query Syntax DISPlay:WINDow<wnum>:NEXT?

Return Type Not Applicable

Default Not Applicable

DISPlay:WINDow<wnum>:SIZE <char>

Applicable Models: All

(Read-Write) Sets or returns the window setting of Maximized, Minimized, or Normal. To arrange all of the windows, use **DISP:ARR**.

Parameters

<wnum> Any existing window number. If unspecified, value is set to 1

<char> Window size. Choose from:

MIN | MAX | NORM

Examples

```
DISP:WIND:SIZE MAX  
display:window:size norm
```

Query Syntax DISPlay:WINDow:SIZE?

Default Not Applicable

DISPlay:WINDow<wnum>[:STATe] <ON | OFF>

Applicable Models: All

(Read-Write) **Write** to create or delete a window on the screen or **Read** whether a window is present.

Parameters

- <wnum> Window number to create; choose any integer between **1** and the **maximum number of windows allowed in the VNA**.
- <ON | OFF> **ON** (or 1) - The window <wnum> is created.
OFF (or 0) - The window <wnum> is deleted.

Examples

```
DISP:WIND ON  
display:window2:state off
```

Query Syntax DISPLAY:WINDow<wnum>[:STATe]?

Return Type Boolean (1 = ON, 0 = OFF)

Default Window number "1" **ON**

DISPlay:WINDow<wnum>:TABLE <char>

Applicable Models: All

(Read-Write) **Write** to show the specified table at the bottom of the analyzer screen or **Read** to determine what table is visible.

Parameters

- <wnum> Any existing window number. If unspecified, value is set to 1
- <char> Table to show. Choose from:
OFF | MARKer | LIMit | SEGMENT | RLIMit | DISTortion

Examples

```
DISP:WIND:TABLE SEGM  
display:window:table off
```

Query Syntax DISPlay:WINDow<wnum>:TABLE?

Default OFF

DISPlay:WINDow<wnum>:TITLE:DATA <string>

Applicable Models: All

(Read-Write) Sets data in the window title area. The title is turned ON and OFF with **DISP:WIND:TITL:STAT OFF**.

Parameters

- <wnum> Any existing window number. If unspecified, value is set to 1.
- <string> Title to be displayed. Any characters, enclosed with quotes. If the title string exceeds 50 characters, an error will be generated and the title not accepted. Newer entries replace (not append) older entries.

Examples

```
DISP:WIND:TITL:DATA 'hello'
display:window2:title:data 'hello'
```

Query Syntax DISPlay:WINDow<wnum>:TITLe:DATA?

Return Type String

Default NA

DISPlay:WINDow<wnum>:TITLe[:STATe] <ON | OFF>

Applicable Models: All

(Read-Write) Turns display of the title string ON or OFF. When OFF, the string remains, ready to be redisplayed when turned back ON.

Parameters

- <wnum> Any existing window number. If unspecified, value is set to 1.
- <ON | OFF> **ON** (or 1) - turns the title string ON.
OFF (or 0) - turns the title string OFF.

Examples

```
DISP:WIND:TITL ON
Display:window1:title:state off
```

Query Syntax DISPlay:WINDow<wnum>:TITLe[:STATe]?

Return Type Boolean (1 = ON, 0 = OFF)

Default ON

DISPlay:WINDow<wnum>:TRACe<tnum>:DELete

Applicable Models: All

(Write-only) Deletes the specified trace from the specified window. The measurement parameter associated with the trace is not deleted.

Parameters

- <wnum> Any existing window number. If unspecified, value is set to 1.
- <tnum> The number of the trace to be deleted; if unspecified, value is set to 1.

Note: This is **NOT** the trace number of the channel which appears as the **Tr annotation** on the Trace Status display. This <tnum> is the trace number within the specified window, and is used **ONLY** for remote programs.

Examples

```
DISP:WIND:TRAC:DEL
display>window2:trace2:delete
```

Query Syntax Not Applicable

Default Not Applicable

DISPlay:WINDow<wnum>:TRACe<tnum>:FEED <name>

Applicable Models: All

(Write-only) Creates a new trace <tnum> and associates (feeds) a measurement <name> to the specified window<wnum>. This command should be executed immediately after creating a new measurement with **CALCulate:MEASure:DEFine**.

To feed the same measurement to multiple traces, create another measurement with the same <parameter>, but different <name>, using the **CALC:PAR:DEF** command. The analyzer will collect the data only once.

Parameters

- <wnum> Any existing window number. If unspecified, value is set to 1.
- <tnum> Trace number to be created. Choose any Integer between **1** and the VNA **maximum number of traces per window** allowed.

Note: This is **NOT** the trace number of the channel which appears as the **Tr annotation** on the Trace Status display. This <tnum> is the trace number within the specified window, and is used **ONLY** for remote programs.

<name> Name of the measurement that was defined with **CALC:PAR:DEF<name>,<parameter>**

Examples

```
DISP:WIND:TRAC:FEED 'test'
display:window2:trace2:feed 'test'
```

Query Syntax Not applicable**Default** "CH1_S11"**DISPlay:WINDow<wnum>:TRACe<tnum>:FEED:MNUMber <int>****Applicable Models:** All

(Write-only) Creates a new trace <tnum> for an existing measurement (MNUM) and associates (feeds) the measurement number to the specified window<wnum>. A measurement is created using the **CALC:MEAS:DEF** command.

Measurements created in the system all have unique numbers. Similarly, every window has a unique number and the numbers are displayed in the lower-left corner of each window. Every window has the capacity to hold a finite number of traces from 1 to N, where N is the maximum number of traces per window. Each window uses the same range of trace numbers. For example, window 1 can have a trace 1 and so can window 2.

Parameters

- <wnum> Any existing window number. If unspecified, value is set to 1.
- <tnum> Trace number to be created. Choose any Integer between 1 and the VNA **maximum number of traces per window** allowed.

Note: After executing the DISP:WIND:TRAC:FEED:MNUM command, a new trace is added to the specified window and the trace number of the channel which appears as the **Tr annotation** on the Trace Status display is the actual measurement number.

- <int> Number of an existing measurement. The range is 1 to 2000.

Examples

```
CALC:MEAS2:DEF "S22"
DISP:WIND:TRAC4:FEED:MNUM 2
```

Query Syntax Not applicable**Default** Not applicable**DISPlay:WINDow:TRACe:GRATicule:GRID:LTYPE <value>**

Applicable Models: All

(Read-Write) Sets and returns the grid line type (solid | dotted) for all open windows. Grid is returned to solid when the VNA is Preset. [Learn more.](#)

Parameters

<value> Line type. Choose from:

SOLid - solid lines

DOTTed - dotted lines

Examples

```
DISP:WIND:TRAC:GREAT:GRID:LTYPE SOL
display>window:trace:graticule:grid:ltype dotted
```

Query Syntax DISPlay:WINDow:TRACe:GRATicule:GRID:LTYPE?

Return Type Character

Default SOLID

DISPlay:WINDow<wnum>:TRACe<tnum>:MEMory[:STATe] <ON | OFF>

Applicable Models: All

(Read-Write) Turns the memory trace ON or OFF.

Parameters

<wnum> Any existing window number. If unspecified, value is set to 1.

<tnum> Any existing trace number; if unspecified, value is set to 1.

Note: This is **NOT** the trace number of the channel which appears as the **Tr annotation** on the Trace Status display. This <tnum> is the trace number within the specified window, and is used **ONLY** for remote programs.

<ON | OFF> **ON** (or 1) - turns the memory trace ON.

OFF (or 0) - turns the memory trace OFF.

Examples

```
DISP:WIND:TRAC:MEM ON
display>window2:trace2:memory:state off
```

Query Syntax DISPlay:WIND<wnum>:TRACe<tnum>:MEMory[:STATe]?

Return Type Boolean (1 = ON, 0 = OFF)

Default OFF

DISPlay:WINDow<fromWin>:TRACe<tnum>:MOVE <toWin>

Applicable Models: All

(Write-only) Moves a trace from one window to another window.

Parameters

<fromWin> Window number to move the trace **from**. If unspecified, value is set to 1.

Use **Disp:Cat?** to read the existing window numbers.

<tnum> Trace number to be moved. If unspecified, value is set to 1.

Use **Disp:Wind:Cat?** to read the trace numbers in an existing window.

Note: This is **NOT** the trace number of the channel which appears as the **Tr annotation** on the Trace Status display. This <tnum> is the trace number within the specified window, and is used **ONLY** for remote programs.

<toWin> Number of the window to move the trace **to**. If the window does not exist, it will be created.

Examples

```
DISP:WIND:TRAC2:MOVE 2
display>window2:trace2:move 1
```

Query Syntax Not applicable

Default Not applicable

DISPlay:WINDow<wnum>:TRACe:NEXT[:NUMBER]?

Applicable Models: All

(Read-only) Returns the next unused trace number. For example, if trace #1, #2, and #3 are being used, then this command will return 4.

Parameters

<wnum> Any existing window number. If unspecified, value is set to 1.

Examples

```
DISP:WIND:TRAC:NEXT?
display>window1:trace:NEXT?
```

Return Type Integer

Default Not Applicable

DISPlay:WINDow<wnum>:TRACe<tnum>:SElect

Applicable Models: All

(Write-only) Activates the specified trace in the specified window for front panel use.

Parameters

<wnum> Any existing window number. If unspecified, value is set to 1.

Use **Disp:Cat?** to read the existing window numbers.

<tnum> Any existing trace number; if unspecified, value is set to 1.

Note: This is **NOT** the trace number of the channel which appears as the **Tr annotation** on the Trace Status display. This <tnum> is the trace number within the specified window, and is used **ONLY** for remote programs.

Examples

```
DISP:WIND:TRAC:SEL  
display>window2:trace2:select
```

Query Syntax Not applicable

Default NA

DISPlay:WINDow<wnum>:TRACe<tnum>[:STATe] <ON | OFF>

Applicable Models: All

(Read-Write) Turns the display of the specified trace in the specified window ON or OFF. When OFF, the measurement behind the trace is still active.

Parameters

<wnum> Any existing window number. If unspecified, value is set to 1.

Use **Disp:Cat?** to read the existing window numbers.

<tnum> Any existing trace number; if unspecified, value is set to 1.

Use **Disp:Wind:Cat?** to read the trace numbers in an existing window.

Note: This is **NOT** the trace number of the channel which appears as the **Tr annotation** on the Trace Status display. This <tnum> is the trace number within the specified window, and is used **ONLY** for remote programs.

<ON | OFF> **ON** (or 1) - turns the trace ON.
OFF (or 0) - turns the trace OFF.

Examples

```
DISP:WIND:TRAC ON  
display>window2:trace2:state off
```

Query Syntax DISPlay:WIND<wnum>:TRACe<tnum>[:STATe]?

Return Type Boolean (1 = ON, 0 = OFF)

Default ON

DISPlay:WINDow<wnum>:TRACe<tnum>:TITLe:DATA <string>

Applicable Models: All

(Read-Write) Writes and read data to the trace title area. The trace title is embedded in the trace status field. [Learn more about Trace Titles.](#)

Newer entries replace (not append) older entries. The title is turned ON and OFF with **DISP:WIND:TRAC:TITL:STAT.**

Parameters

<wnum> Any existing window number. If unspecified, value is set to 1.

Use **Disp:Cat?** to read the existing window numbers.

<tnum> Trace number of the specified window. If unspecified, value is set to 1. Use **Display:Cat?** to read the window numbers. Use **Disp:Window:Cat?** to read the trace numbers of the specified window.

Note: This is **NOT** the trace number of the channel which appears as the **Tr annotation** on the Trace Status display. This <tnum> is the trace number within the specified window, and is used **ONLY** for remote programs.

<string> Title to be displayed. Any characters (not spaces) enclosed with quotes.

Examples

```
DISP:WIND:TRAC:TITL:DATA 'MyNewMeas '  
display>window2:trace3:title:data 'hello'
```

Query Syntax DISPlay:WINDow<wnum>:TRACe<tnum>TITLe:DATA?

Return Type String

Default Not Applicable

DISPlay:WINDow<wnum>:TRACe<tnum>:TITLe[:STATE] <bool>

Applicable Models: All

(Read-Write) Turns display of the Trace Title ON or OFF. When turned OFF, the previous trace title returns. Set a new trace title using `DISP:WIND:TRAC:TITL:DATA`

[Learn more about Trace Titles](#)

Parameters

<wnum> Any existing window number. If unspecified, value is set to 1

Use `Disp:Cat?` to read the existing window numbers.

<tnum> Trace number of the specified window. If unspecified, value is set to 1. Use `Display:Cat?` to read the window numbers. Use `Disp:Window:Cat?` to read the trace numbers of the specified window.

Note: This is **NOT** the trace number of the channel which appears as the **Tr annotation** on the Trace Status display. This <tnum> is the trace number within the specified window, and is used **ONLY** for remote programs.

<bool> **ON** (or 1) - turns the title ON.

OFF (or 0) - turns the title OFF.

Examples

```
DISP:WIND:TRAC:TITL ON  
Display>window2:trace3:title:state off
```

Query Syntax `DISPlay:WINDow<wnum>:TRACe<tnum>:TITLe[:STATe]?`

Return Type Boolean (1 = ON, 0 = OFF)

Default ON

`DISPlay:WINDow<wnum>:TRACe<tnum>:Y[:SCALe]:AUTO`

Applicable Models: All

(Write-only) Performs an **Autoscale** on the specified trace in the specified window, providing the best fit display.

Autoscale is performed only when the command is sent; it does NOT keep the trace autoscaled indefinitely.

Autoscale behaves differently when **scale coupling** is enabled. How it behaves depends on the scale coupling method. [Learn more.](#)

See Also, **DISPlay:WINDow:Y:AUTO** which performs an Autoscale All.

Parameters

<wnum> Any existing window number. If unspecified, value is set to 1.

Use **Disp:Cat?** to read the existing window numbers.

<tnum> Any existing trace number; if unspecified, value is set to 1.

Use **Disp:Wind:Cat?** to read the trace numbers in an existing window.

Note: This is **NOT** the trace number of the channel which appears as the **Tr annotation** on the Trace Status display. This <tnum> is the trace number within the specified window, and is used **ONLY** for remote programs.

Examples

```
DISP:WIND:TRAC:Y:AUTO
display>window2:trace2:y:scale:auto
```

Query Syntax Not applicable

Default Not applicable

DISPlay:WINDow:TRACe:Y[:SCALe]:COUPlE:METHod <char>

Applicable Models: All

(Read-Write) Sets and returns the method of scale coupling. [Learn more](#) about Scale coupling.

Parameters

<char> **OFF** - NO scale coupling for any windows.

WINDOW - Scale settings are coupled for traces in each window.

ALL - Scale settings are coupled for traces in ALL selected windows.

Enable the selected windows using **DISP:WIND:TRAC:Y:COUP ON**

Examples

```
DISP:WIND:TRAC:Y:COUP:METH ALL
```

```
Display>window2:trace:y:scale:method window
```

Query Syntax DISPlay:WINDow:TRACe:Y[:SCALe]:COUPle:METHOD?

Return Type Character

Default OFF

DISPlay:WINDow<wnum>:TRACe:Y[:SCALe]:COUPle[:STATe] <bool>

Applicable Models: All

(Read-Write) Enables and disables scale coupling for the specified window. [Learn more](#) about Scale coupling.

Parameters

<wnum> Any existing window number. If unspecified, value is set to 1

Use **Disp:Cat?** to read the existing window numbers.

<bool> **ON** (or 1) - Scale coupling enabled for specified window.

OFF (or 0) - Scale coupling disabled for specified window.

Examples

```
DISP:WIND:TRAC:Y:COUP ON
```

```
Display>window2:trace:y:scale:couple:state off
```

Query Syntax DISPlay:WINDow<wnum>:TRACe:Y[:SCALe]:COUPle[:STATe]?

Return Type Boolean (1 = ON, 0 = OFF)

Default ON

DISPlay:WINDow<wnum>:TRACe<tnum>:Y[:SCALE]:PDIVision <num>

Applicable Models: All

(Read-Write) Sets the Y axis **Per Division** value of the specified trace in the specified window.

Parameters

<wnum> Any existing window number. If unspecified, value is set to 1.

Use **Disp:Cat?** to read the existing window numbers.

<tnum> Any existing trace number; if unspecified, value is set to 1.

Use **Disp:Wind:Cat?** to read the trace numbers in an existing window.

Note: This is **NOT** the trace number of the channel which appears as the **Tr annotation** on the Trace Status display. This <tnum> is the trace number within the specified window, and is used **ONLY** for remote programs.

<num> Units / division value. The range of acceptable values is dependent on format and domain.

Note: This command will accept **MIN** or **MAX** instead of a numeric parameter. See **SCPI Syntax** for more information.

Examples

```
DISP:WIND:TRAC:Y:PDIV 1  
display>window2:trace2:y:scale:pdivision maximum
```

Query Syntax DISPlay:WINDow<wnum>:TRACe<tnum>:Y[:SCALE]:PDIVision?

Return Type Numeric

Default 10

DISPlay:WINDow<wnum>:TRACe<tnum>:Y[:SCALE]:RLEVEL <num>

Applicable Models: All

(Read-Write) Sets the Y axis Reference Level of the specified trace in the specified window.

Parameters

<wnum> Any existing window number. If unspecified, value is set to 1.

Use **Disp:Cat?** to read the existing window numbers.

<tnum> Any existing trace number; if unspecified, value is set to 1.

Use **Disp:Wind:Cat?** to read the trace numbers in an existing window.

Note: This is **NOT** the trace number of the channel which appears as the **Tr annotation** on the Trace Status display. This <tnum> is the trace number within the specified window, and is used **ONLY** for remote programs.

<num> Reference level value. The range of acceptable values is dependent on format and domain.

Note: This command will accept MIN or MAX instead of a numeric parameter. See **SCPI Syntax** for more information.

Examples

```
DISP:WIND:TRAC:Y:RLEV 0  
display:window2:trace2:y:scale:rlevel minimum
```

Query Syntax DISPlay:WINDow<wnum>:TRACe<tnum>:Y[:SCALe]:RLEVel?

Return Type Numeric

Default Not Applicable

DISPlay:WINDow<wnum>:TRACe<tnum>:Y[:SCALe]:RPOSition <num>

Applicable Models: All

(Read-Write) Sets the **Reference Position** of the specified trace in the specified window.

Parameters

<wnum> Any existing window number. If unspecified, value is set to 1.

Use **Disp:Cat?** to read the existing window numbers.

<tnum> Any existing trace number; if unspecified, value is set to 1.

Use **Disp:Wind:Cat?** to read the trace numbers in an existing window.

Note: This is **NOT** the trace number of the channel which appears as the **Tr annotation** on the Trace Status display. This <tnum> is the trace number within the specified window, and is used **ONLY** for remote programs.

<num> Reference position on the screen measured in horizontal graticules from the bottom. Choose a value between 0 and 10.

Note: This command will accept **MIN** or **MAX** instead of a numeric parameter. See **SCPI Syntax** for more information.

Examples

```
DISP:WIND:TRAC:Y:RPOS 0
```

```
display>window2:trace2:y:rposition maximum
```

Query Syntax DISPlay:WINDow<wnum>:TRACe<tnum>:Y[:SCALe]:RPOSition?

Return Type Numeric

Default 5

DISPlay:WINDow<wnum>:Y:AUTO

Applicable Models: All

(Write-only) Scales **ALL** of the traces to fit in the same window. This is equivalent to "Autoscale All" from the front panel.

Autoscale behaves differently when **scale coupling** is enabled. How it behaves depends on the scale coupling method. [Learn more](#).

Autoscale is performed only when the command is sent; it does NOT keep the trace autoscaled indefinitely.

See Also, **DISPlay:WINDow:TRACe:Y:AUTO** which Autoscales only the specified trace.

Parameters

<wnum> Any existing window number. If unspecified, value is set to 1.

Use **Disp:Cat?** to read the existing window numbers.

Examples

```
DISP:WIND:Y:AUTO
display>window2:y:auto
```

Query Syntax Not applicable

Default Not applicable

DISPlay:WINDow<wnum>:Y[:SCALe]:DIVisions <num>

Applicable Models: All

(Read-Write) Sets or returns the number of divisions in all the graphs, for the selected channel

Parameters

<wnum> **Any existing window number. If unspecified, value is set to 1**

Use **Disp:Cat?** to read the existing window numbers.

<bool> **ON or 1 - Scale coupling enabled for specified window.**

OFF or 0 - Scale coupling disabled for specified window.

<num> Number of divisions is between 4 to 30.

Units / division value. The range of acceptable values is dependent on format and domain.

Note: This command will accept MIN or MAX instead of a numeric parameter. See [SCPI Syntax](#) for more information.

Examples

```
DISP:WIND:Y:DIV 12
```

```
Display>window2:y:scale:divisions 12
```

**Query
Syntax**

DISPlay:WINDow<wnum>:Y[:SCALe]:DIVisions?

**Return
Type**

Boolean

Default 10

Format Commands

Specifies the way that data will be transferred when moving large amounts of data.

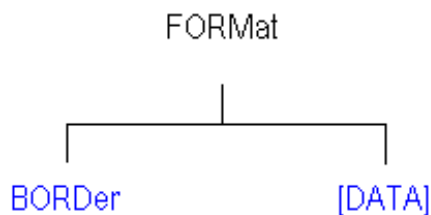

Click on a keyword to view the command details.

See Also

- [Example Programs](#)
- [Synchronizing the Analyzer and Controller](#)
- [SCPI Command Tree](#)

FORMat:BORDER <char>

Applicable Models: All

(Read-Write) Set the byte order used for GPIB data transfer. Some computers read data from the analyzer in the reverse order. This command is only implemented if FORMAT:DATA is set to :REAL.

If FORMAT:DATA is set to :ASCII, the swapped command is ignored.

Parameters

<char> Choose from:

NORMAL - Use when your controller is anything other than an IBM compatible computers.

SWAPped - for IBM compatible computers.

Note: Use **NORMAL** if you are using VEE, LabView, or T&M Tool kit.

Examples

```
FORM:BORD SWAP
format:border normal
```

Query Syntax

FORMat:BORDER?

Return Type Character

Default Normal

FORMat[:DATA] <char>

Applicable Models: All

(Read-Write) Sets the data format for transferring measurement data and frequency data.

- To transfer measurement data, use **CALC:MEAS:DATA**.
- To transfer Cal Set data, use **SENS:CORR:CSET:DATA**
- To transfer Source Power correction data, use:
 - **SOURce:POWer:CORRection:COLLect:TABLE:DATA**
 - **SOURce:POWer:CORRection:COLLect:TABLE:FREQuency**
 - **SOURce:POWer:CORRection:DATA**
- To transfer FIFO buffer data, use **SYST:FIFO:DATA?**

The following commands transfer frequency data. Use <**REAL, 64**>

- **CALC:MEAS:DATA:SNP?**
- **CALC:MEAS:X?**
- **SENS:X?**

Use **FORMat:BORDER** to change the byte order. Use “**NORMAL**” when transferring a binary block from LabView or Vee. For other programming languages, you may need to SWAP the byte order.

Parameters

<char> In the VNA, measurement data is stored as 32 bit and frequencies stored as 64 bit. Therefore, use **REAL,32** when getting data and **REAL,64** when getting frequencies. That way you are guaranteed to avoid losing any precision as well as getting the maximum speed on the data transfer.

Choose from:

- **REAL,32** - (default value for REAL) Best for transferring large amounts of measurement data. Can cause rounding errors in frequency data.
- **REAL,64** - Slower but has more significant digits than REAL,32. REQUIRED to accurately represent frequency data. See above list for commands which transfer frequency information.
- **ASCii,0** - The easiest to implement, but very slow. Use when you have small amounts of data to transfer.

Note The REAL,32 and REAL,64 arguments transfer data in block format as explained in [Transferring Measurement Data](#).

Examples

```
FORM REAL,64
format:data ascii
```

Query Syntax FORMat:DATA?

Return Type Character,Character

Default ASCii,0

Syst:Preset does NOT reset this command.

However, *RST does reset this command to ASCii,0

Hardcopy Command

Controls printing of the VNA screen and optional data to a printer or a file.

```
HCOPY:
  DPRinter
  FILE
  [IMMEDIATE]
  ITEM
    | AWINdow
    | CTABLE
    | GPFail
    | LOGO
    | MKRData
    | PNUMBER
    | SEGData
    | SWINdow
    | TIME
    | TTABLE
    | WFRaction
    | WINDows
  PAGE
    | DIMension
      | LLEFT
      | URIGHT
    | ORientation
    | SIZE
  SDUMP
    | DATA?
      | FORMat
  PRINters?
```

Click on a keyword to view the command details.

Blue commands are superseded or obsolete.

See Also

- [Learn more about VNA Printing](#)
- [Example Programs](#)

- Synchronizing the Analyzer and Controller
-

HCOPY:DPRinter <string>

Applicable Models: All

(Read-Write) Sets the default printer and selects as the current printer. Use **HCOPY:PRINters?** to return a list of locally installed printers.

This setting survives instrument preset and VNA application restart.

Parameters

<string> Name of the printer to become the default.

Examples

```
HCOP:DPR "MyPrinter"  
hcopy:dprinter "YourPrinter"
```

Query Syntax HCOPY:DPRinter?

Return Type String

Default Not Applicable

HCOPY:FILE <filename>

Applicable Models: All

(Write-only) Saves the screen image to a file. The image does NOT include the optional print data invoked by many HCOPI commands.

Parameters

<filename> Name of the file to save the screen to. The file is saved to the current working directory unless a valid full path name is specified.

Use one of the following suffixes:

.bmp - not recommended due to large file size

.jpg - not recommended due to poor quality

.png - recommended

Examples

```
HCOPY:FILE "myFile.png"  
hcopy:file "c:/data/myfile.png"
```

Query Syntax Not Applicable

Default Not Applicable

HCOPY[:IMMEDIATE]

Applicable Models: All

(Write-only) Prints the screen to the default printer.

Examples `HCOPY
hcopy:immediate`

Query Syntax Not applicable

Default Not Applicable

HCOPY:ITEM:AWINDOW[:STATE] <bool>

Applicable Models: All

(Read-Write) When ON, prints only the Active window. When OFF, prints all windows.

This setting survives instrument preset and VNA application restart.

Parameters

<bool> Active window state. Chose from:

OFF or (0) - Print ALL windows.

ON or (1) - Print Active window only.

Examples `HCOPY:ITEM:AWIN 1
hcopy:item:awindow:state off`

Query Syntax HCOPY:ITEM:AWINDOW[:STATE]?

Return Type Boolean

Default OFF (0)

HCOPY:ITEM:CTABLE[:STATE] <bool>

Applicable Models: All

(Read-Write) When ON, prints the channel settings table.

This setting survives instrument preset and VNA application restart.

Parameters

<bool> Channel table print state. Chose from:

OFF or (0) - Does NOT print the channel settings table.

ON or (1) - Prints channel settings table.

Examples

```
HCOPY:ITEM:CTAB 1
```

```
hcopy:item:ctable:state off
```

Query Syntax HCOpy:ITEM:CTABLE[:STATE]?

Return Type Boolean

Default OFF (0)

HCOPY:ITEM:GPFail[:STATE] <bool>

Applicable Models: All

(Read-Write) When ON, prints the **Global Pass/Fail** status in the page header.

This setting survives instrument preset and VNA application restart.

Parameters

<bool> Pass / Fail print state. Chose from:

OFF or (0) - Does NOT print Pass / Fail status.

ON or (1) - Print Pass / Fail status

Examples

```
HCOPY:ITEM:GPF 1
```

```
hcopy:item:gpfail:state off
```

Query Syntax HCOpy:ITEM:GPFail[:STATE]?

Return Type Boolean

Default OFF (0)

HCOPY:ITEM:LOGO[:STATE] <bool>

Applicable Models: All

(Read-Write) When ON, prints the Keysight Technologies logo in the page header.

This setting survives instrument preset and VNA application restart.

Parameters

<bool> Keysight logo print state. Chose from:

OFF or (0) - Prints the Keysight logo.

ON or (1) - Does NOT print the Keysight logo.

Examples

```
HCOPY:ITEM:LOGO 1
```

```
hcopy:item:logo:state off
```

Query Syntax HCOpy:ITEM:LOGO[:STATe]?

Return Type Boolean

Default OFF (0)

HCOPY:ITEM:MKRData[:STATe] <bool>

Applicable Models: All

(Read-Write) When ON, includes marker data as part of the **trace attributes table**.

To print marker data, **HCOPY:ITEM:TTABLE** must also be set to ON.

This setting does not affect the limited **marker readout data** that can be displayed in the measurement window.

This setting survives instrument preset and VNA application restart.

Parameters

<bool> Marker data print state. Chose from:

OFF or (0) - Does NOT print Marker data.

ON or (1) - Print Marker data.

Examples

```
HCOPY:ITEM:MKRD 1
```

```
hcopy:item:mkrdata:state off
```

Query Syntax HCOpy:ITEM:MKRData[:STATe]?

Return Type Boolean

Default OFF (0)

HCOPY:ITEM:PNUMBER[:STATE] <bool>

Applicable Models: All

(Read-Write) When ON, prints page numbers (1 of n) in the header at the top of each page.

This setting survives instrument preset and VNA application restart.

Parameters

<bool> Page number print state. Chose from:

OFF or (0) - Does NOT print page numbers.

ON or (1) - Print page numbers.

Examples

```
HCOPY:ITEM:PNUM 1
```

```
hcopy:item:pnumber:state off
```

Query Syntax HCOPY:ITEM:PNUMBER[:STATE]?

Return Type Boolean

Default OFF (0)

HCOPY:ITEM:SEGDATA[:STATE] <bool> - Obsolete

Note: This command no longer works beginning with A.09.40

(Read-Write) When ON, includes ALL segment data as part of the **channel settings table**.

To print ALL segment data, **HCOPY:ITEM:CTAB** must also be set to ON.

This setting survives instrument preset and VNA application restart.

Parameters

<bool> Expanded segment data print state. Chose from:

OFF or (0) - Does NOT print expanded segment data, but summary data is printed.

ON or (1) - Print expanded segment data.

Examples `HCOP:ITEM:SEGD 1`

`hcopy:item:segdata:state off`

Query Syntax `HCOPY:ITEM:SEGData[:STATe]?`

Return Type Boolean

Default OFF (0)

HCOPY:ITEM:SWINDOW[:STATe] <bool>

Applicable Models: All

(Read-Write) When ON, prints a single measurement window per page. When OFF, prints up to four measurement windows per page.

This setting survives instrument preset and VNA application restart.

Parameters

<bool> Single window print state. Chose from:

OFF or (0) - Print up to four windows per page.

ON or (1) - Print only one window per page.

Examples `HCOP:ITEM:SWIN 1`

`hcopy:item:swindow:state off`

Query Syntax `HCOPY:ITEM:SWINDOW[:STATe]?`

Return Type Boolean

Default OFF (0)

HCOPY:ITEM:TIME[:STATe] <bool>

Applicable Models: All

(Read-Write) When ON, prints the VNA computer date and time in the header.

This setting survives instrument preset and VNA application restart.

Parameters

<bool> Time stamp print state. Chose from:

OFF or (0) - Does NOT print time stamp.

ON or (1) - Print time stamp.

Examples

```
HCOPY:ITEM:TIME 1
```

```
hcopy:item:time:state off
```

Query Syntax HCOPY:ITEM:TIME:[STATE]?

Return Type Boolean

Default OFF (0)

HCOPY:ITEM:TTABLE[:STATE] <bool>

Applicable Models: All

(Read-Write) When ON, prints the trace attributes table.

This setting survives instrument preset and VNA application restart.

Parameters

<bool> Trace attributes table print state. Chose from:

OFF or (0) - Does NOT print the trace attributes table.

ON or (1) - Print the trace attributes table.

Examples

```
HCOPY:ITEM:TTABLE 1
```

```
hcopy:item:ttable:state off
```

Query Syntax HCOPY:ITEM:TTABLE[:STATE]?

Return Type Boolean

Default OFF (0)

HCOPY:ITEM:WFRaction <value>

Applicable Models: All

(Read-Write) Sets the vertical amount of a page that is filled by the measurement windows.

This setting survives instrument preset and VNA application restart.

Parameters

<value> Window size as a fraction of the page. Chose a value from .4 (40%) to 1.0 (100%)

Examples

```
HCOP:ITEM:WFR .8  
hcopy:item:wfraction .5
```

Query Syntax HCOPY:ITEM:WFRaction?

Return Type Numeric

Default .4

HCOPY:ITEM:WINDows[:STATe] <bool>

Applicable Models: All

(Read-Write) When ON, prints measurement windows.

Use **HCOPY:ITEM:AWINdow** to specify all windows or only the active window.

This setting survives instrument preset and VNA application restart.

Parameters

<bool> Windows print state. Chose from:
OFF or (0) - Does not print measurement windows.
ON or (1) - Print measurement windows.

Examples

```
HCOP:ITEM:WIND 1  
hcopy:item:windows:state off
```

Query Syntax HCOPY:ITEM:WINDows[:STATe]?

Return Type Boolean

Default OFF (0)

HCOPY:PAGE:DIMensions:LLEFt <left, lower>

Applicable Models: All

(Read-Write) Sets the left and lower page margins.

This setting survives instrument preset and VNA application restart.

Parameters

<left> Left page margin as a percentage of entire page width. Value must be between 0 and 1.

<lower> Lower page margin as a percentage of entire page length. Value must be between 0 and 1.

Examples

```
HCOPY:PAGE:DIM:LLEF .10,.10
```

```
hcopy:page:dimensions:lleft .5,.7
```

Query Syntax HCOpy:PAGE:DIMensions:LLEft?

Return Type Numeric, Numeric

Default Depends on selected page size

HCOPY:PAGE:DIMensions:URIGHT <right, upper>

Applicable Models: All

(Read-Write) Sets the right and upper page margins.

This setting survives instrument preset and VNA application restart.

Parameters

<right> Right page margin as a percentage of entire page width. Value must be between 0 and 1.

<upper> Upper page margin as a percentage of entire page length. Value must be between 0 and 1.

Examples

```
HCOPY:PAGE:DIM:URIG .10,.10
```

```
hcopy:page:dimensions:uright .5,.7
```

Query Syntax HCOpy:PAGE:DIMensions:URIGHT?

Return Type Numeric, Numeric

Default Depends on selected page size

HCOPY:PAGE:ORientation <char>

Applicable Models: All

(Read-Write) Sets the page orientation.

This setting survives instrument preset and VNA application restart.

Parameters

<char> Choose from:

- PORTrait
- LANDscape

Examples

```
HCOPY:PAGE:ORI PORT
hcopy:page:orientation landscape
```

Query Syntax HCOpy:PAGE:ORientation?

Return Type Character

Default PORTrait

HCOPY:PAGE:SIZE <int>

Applicable Models:

(Read-Write) Sets the paper type, which implies the page size.

This setting survives instrument preset and VNA application restart.

Parameters

<int> Choose from:I

Integer	Description
1	Letter 8 1/2 x 11 in
2	Letter Small 8 1/2 x 11 in
3	Tabloid 11 x 17 in
4	Ledger 17 x 11 in
5	Legal 8 1/2 x 14 in
6	Statement 5 1/2 x 8 1/2 in
7	Executive 7 1/4 x 10 1/2 in
8	A3 297 x 420 mm
9	A4 210 x 297 mm
10	A4 Small 210 x 297 mm
11	A5 148 x 210 mm
12	B4 (JIS) 250 x 354
13	B5 (JIS) 182 x 257 mm

For more paper type choices, see Microsoft's "wingdi.h" file, which can be downloaded as part of the Platform SDK.

Examples

```
HCOP:PAGE:SIZE 2
```

```
hcopy:page:size 5
```

Query Syntax HCOPY:PAGE:SIZE?

Return Type Integer

Default 1

HCOPY:SDUMp:DATA?

Applicable Models: All

(Read-only) Returns the display image in a definite-length arbitrary binary block. The format of the data is PNG by default. Use **HCOP:SDUMp:DATA:FORMat** to change the format.

This command is equivalent to saving an image to the VNA (**HCOPY:FILE**) and then using **MMEM:TRAN** to transfer the file to the computer.

Examples

```
HCOP:SDUM?
```

```
hcopy:sdump?
```

Return Type A definite-length arbitrary binary block

Default Not Applicable

HCOPY:SDUMp:DATA:FORMat <char>

Applicable Models: All

(Read-Write) Sets the graphic format for **HCOPY:SDUMp:DATA?**

Parameters

<char> Choose from: **JPG** | **BMP** | **PNG**

Examples `HCOP:SDUMp:DATA:FORMat BMP`

Query Syntax `HCOPY:SDUMp:DATA:FORMat?`

Return Type Character

Default PNG

HCOPY:PRINters?

Applicable Models: All

(Read-only) Returns a comma-separated list of printers installed on the VNA. Select a printer using **HCOPY:DPRinter**.

This setting survives instrument preset and VNA application restart.

Examples `HCOP:PRIN?`

`hcopy:printers?`

Query Syntax `HCOPY:PRINters?`

Return Type String

Default Not Applicable

Initiate Commands

Controls triggering signals

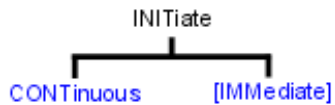

Click on a **red** keyword to view the command details.

See Also

- **Example** [Triggering the VNA](#)
 - [Learn about Triggering](#)
 - [Synchronizing the Analyzer and Controller](#)
 - [SCPI Command Tree](#)
-

INITiate:CONTInuous <boolean>

Applicable Models: All

(Read-Write) Specifies whether the VNA trigger source is set to Internal (continuous) or Manual.

- For SIMPLE, single-triggering of a single channel, use **Sens:Sweep:Mode SINGLE** which sets the number of trigger signals each channel will ACCEPT (Continuous, Groups, **Single**, or HOLD - none.)
- This command is a subset of **TRIG:SEQ:SOURce**, which can also set the trigger source to External.
- See a [map of user interface to SCPI triggering commands](#).
- For more information on triggering, see the [VNA Trigger Model](#).
- **See the Example program:** [Triggering the VNA using SCPI](#).

Parameters

<boolean> **ON** (or 1) - Internal (continuous) trigger.

OFF (or 0) - Manual sweep. Use **INIT:IMMediate** to send a trigger signal

Examples

```
INIT:CONT ON
initiate:continuous off
```

Query Syntax INITiate:CONTInuous?

Return Type Boolean (1 = ON, 0 = OFF)

INITiate<cnum>[:IMMEDIATE]**Applicable Models:** All

(Write-only) Stops the current sweeps and immediately sends a trigger. (Same as **Trigger!** on the VNA front panel).

- This command requires **Trigger:Source** to be set to Manual. This causes ONE trigger signal to be SENT each time INIT:IMM is issued.
- For SIMPLE, single-triggering of a single channel, use **Sens:Sweep:Mode SINGLE** which sets the number of trigger signals each channel will ACCEPT (Continuous, Groups, **Single**, or HOLD - none.)

See the Example program: [Triggering the VNA using SCPI](#)

Note: An **SMC Fixed Output** measurement cannot be triggered using this command. For more information, see the [example program](#).

To trigger ALL channels in turn:

Set ALL channels to Sens<ch>:Sweep:Mode Continuous. The <ch> argument in INIT<ch>:IMM is ignored.

Then...

- TRIG:SCOP ALL triggers ALL channels (in sequence) each time Init:Imm is sent.
- TRIG:SCOP CURRent triggers ONLY the NEXT channel each time Init:Imm is sent.

To trigger ONLY a specified channel:

1. Set ALL channels to Sens<ch>:Sweep:Mode HOLD
2. Send TRIG:SCOP CURRent
3. Send Init<ch>:Imm where <ch> is the channel to be triggered.

Advanced Situations that require some channels to be in CONT and others in HOLD are rare. The following describes the behavior of the Init:Imm command in these situations:

When **Trigger:Scope = Global:**

- If the SPECIFIED <cnum> channel is in hold mode, it is put in single trigger (accepts 1 trigger signal) and

goes to the end of the queue of channels to be triggered. The other 'non-hold' channels are triggered. The next Init:Imm triggers the specified channel first.

For example: ch1 is in Hold, ch2 and ch3 are in CONT and we send INIT1:IMM

- On the first INIT:IMM, ch2 and ch3 is triggered.
- next INIT:IMM, ch1, ch2, ch3 is triggered.
- next INIT:IMM, ch2 and ch3 is triggered.
- next INIT:IMM, ch1, ch2, ch3 is triggered, and so forth.

When Trigger:Scope = Channel

- Only ONE channel is triggered for each issued INIT<ch>:IMM command.
- If the specified channel is in hold, it is put in single trigger (accepts 1 trigger signal) and goes the end of the queue of channels to be triggered as in the 'Global' example.

This is one of the VNA overlapped commands. [Learn more.](#)

Parameters

<num> Any existing channel number. If unspecified, value is set to 1

Examples

```
INIT  
initiate2:immediate
```

Query Syntax Not applicable

Default Not applicable

LXI Command

SCPI Command Tree

LXI:IDENTify[:STATe] <bool>

Applicable Models: N522xB, N523xB, N524xB, E5080A

(Read-Write) Sets and returns the status of the LXI LAN status indicator on the LAN Status dialog.

Parameters

<bool> Choose from:

OFF or **0** - Changes the LXI Status indicator to 'NORMAL' and closes the dialog if it was opened by this command.

ON or **1** - Changes the LXI Status indicator to 'IDENTIFY' and opens the dialog if it was not already open.

Examples

```
LXI:IDEN 1  
lxi:identify:state off
```

Query Syntax LXI:IDENTify[:STATe]?

Return Type Boolean

Default OFF

Memory Commands

The memory commands control saving and loading instrument states and measurement trace data to the hard drive. To read and write trace data in GPIB format, see [CALC:MEAS:DATA](#).

MMEMory:

CATalog?

CDIRectory

COPY

DATE?

DELeTe

LOAD

| **ASCFactor**

| **BSCFactor**

| **CORRection**

| **CSARchive**

| **ENR**

| **[:FILE]**

| **LIMit**

| **PLOSs**

| **RLIMit**

| **SEGMENT**

| **STATe**

MDIRectory

MOVE

RDIRectory

STORe

| **ASCFactor**

| **BSCFactor**

| **CORRection**

| **CSARchive**

| **CSTate**

| **CITI**

| **DATA**

| **FORMat**

| **CSV:FORMat**

| **DATA**

| **ENR**

| **[:FILE]**

| **LIMit**

PLOs
RLIMit
SEGMENT
SSCReen
STATE
TRACe
TRACe
CONTents
CITIfile
FORMat
CITIfile
SNP
TDR More Commands
TIME?
TRANSfer

Click on a keyword to view the command details.

Blue commands are superseded.

See Also

- [Example Programs](#)
- [Learn about Save / Recall and File Types](#)
- [Synchronizing the Analyzer and Controller](#)
- [SCPI Command Tree](#)

Specifying Path Names

The MMEM commands use the following rules to specify path names:

- The default folder is "D:\". [Learn more.](#)
- You can change the active directory using [MMEMory:CDIRectory](#).
- Specify only the file name if using the active directory.
- You can also use an absolute path name to specify the folder and file.

MMEMory:CATalog[:<char>]? [<folder>]

Applicable Models: All

(Read-only) Returns a comma-separated string of file names that are in the specified folder. If there are no files of the specified type, "NO CATALOG" is returned. [Learn about File Types](#)

Parameters

<char> The type of files to list. Choose from:

- **STATe** - Instrument states (.sta)
- **CORRection** - Calibration Data (.cal)
- **CSARchive** - Instrument state and calibration data (.csa)
- **CSTate** - Instrument state and link to Calibration data (.cst)
- **[:File]**

If unspecified then ALL file types (even unknown types) are listed.

<folder> String - Any existing folder name. See [Specifying Path Names](#)

Examples

```
mMEM:CAT? 'lists all files from the current folder  
mmemory:catalog:correction? 'D:\' 'lists .cal files from the  
specified folder
```

Default Not applicable

MMEMemory:CDIRectory <folder>

Applicable Models: All

(Read-Write) Changes the folder name.

Parameters

<folder> Any drive and folder name that already exists.

If the same level as the default path, then no punctuation is required.

```
mMEM:CDIR Service
```

If the new folder is at a different level than the default, use a slash (/) before the folder name and enclose in quotes.

```
mmemory:cdirectory '/automation' 'changes default directory up  
one level.
```

You can use an absolute path to specify the new folder.

```
mmemory:cdirectory 'C:/automation/service'
```

Query Syntax MMEMory:CDIRectory? 'Returns the current folder name

Return Type String

Default See [Specifying Path Names](#)

MMEMory:COPY <file1>,<file2>

Applicable Models: All

(Write-only) Copies file1 to file2. Extensions must be specified.

Parameters

<file1> String - Name of the file to be copied. See [Specifying Path Names](#)

<file2> String - Name of the file to be created from file1.

Examples

```
MMEM:COPY 'MyFile.cst', 'YourFile.cst'
```

Query Syntax Not applicable

Default Not applicable

MMEMory:DATE? <fileName>

Applicable Models: All

(Read-only) Returns the (year, month, day) that the specified file was last saved.

To query the last date and time a cal set was modified, use [CSET DATE?](#) and [CSET:TIME?](#)

See Also

[MMEM:TIME?](#)

Parameters

<fileName> String - File name. See [Specifying Path Names](#)

Example

```
MMEM:DATE? "myFile.txt"
```

'Returns

+2013,+4,+12

```
mmemory:date? "D:\Calset_18.pcs"
```

'Returns

+2013,+4,+12

Return Type Comma-separated integers

Default Not applicable

MMEMory:DELeTe <file>

Applicable Models: All

(Write-only) Deletes file. Extensions must be specified.

Parameters

<file> String - Name of the file to be deleted. See [Specifying Path Names](#)

Examples `MMEM:DEL 'MyFile.cst'`

Query Syntax Not applicable

Default Not applicable

MMEMory:LOAD[:<char>] <file>

Applicable Models: All

(Write-only) Loads the specified file. [Learn about File Types](#)

Parameters

<char> The type of file to load. Choose from:

- **ASCFactor**
- **BSCFactor**
- **STATe** - Instrument states (.sta)
- **CORRection** - Calibration Data (.cal)
- **CSARchive** - Instrument state and calibration data (.csa)
- **CState** - Instrument state and link to Calibration data (.cst)
- **ENR** - Excess Noise Source data ([Noise Figure App only](#))\
- **SEGMENT**
- **[:File]**
- When <char> is **ENR**, then include **CAL**, - See example below.

- *.sNp files CAN be recalled to the VNA although no <char> is used. See example below.

If <char> is unspecified, the extension must be included in the filename.

If an extension is specified in <file> that does not agree with <char> then no action is taken.

<file> String - Name of the file to be loaded. See [Specifying Path Names](#)

Examples

```
MMEM:LOAD 'MyFile.cst'
mmemory:load:state 'MyInstState'

MMEM:LOAD:ENR CAL, "D:/data/calset/346C_16500.enr"

MMEM:LOAD "MyFile.s2p"
```

Query Syntax Not applicable

Default Not applicable

MMEMory:LOAD:LIMit <file>

Applicable Models: All

(Write-only) Load limit test data of the active trace of the active channel from a CSV file.

Parameters

<file> A file path by string format.

The CSV file shall have header lines and a title row as follows.

"# E5080 Limit Test"

"# Revision: 1.00"

TYPE,BEGIN STIMULUS,END STIMULUS,BEGIN RESPONSE,END RESPONSE

Examples

```
MMEM:LOAD:LIM 'MyFile.csv'
```

Query Syntax Not Applicable

Default Not Applicable

MMEMory:LOAD:RLIMit <file>

Applicable Models: All

(Write-only) Load ripple limit test data of the active trace of the active channel from a CSV file.

Parameters

<file> A file path by string format.

The CSV file shall have header lines and a title row as follows.

"# E5080 Ripple Limit Test"

"# Revision: 1.00"

TYPE,BEGIN STIMULUS,END STIMULUS,MAX RIPPLE

Examples

```
MMEM:LOAD:RLIM 'MyFile.csv'
```

Query Syntax Not Applicable

Default Not Applicable

MMEMemory:MDIRectory <folder>

Applicable Models: All

(Write-only) Makes a folder.

Parameters

<folder> String - Name of the folder to make. See [Specifying Path Names](#)

Examples

```
MMEM:MDIR 'MyFolder'
```

```
mmemory:mdirectory 'D:/NewFolder'
```

Query Syntax Not applicable

Default Not applicable

MMEMemory:MOVE <file1>,<file2>

Applicable Models: All

(Write-only) Renames <file1> to <file2>. File extensions must be specified.

Parameters

<file1> String - Name of the file to be renamed. See [Specifying Path Names](#)

<file2> String - Name of the new file.

Examples `MMEM:MOVE 'MyFile.cst', 'YourFile.cst'`

Query Syntax Not applicable

Default Not applicable

MMEMory:RDIRECTory <folder>

Applicable Models: All

(Write-only) Removes the specified folder.

Parameters

<folder> String - Name of the folder to remove. See [Specifying Path Names](#)

Examples `MMEM:RDIR 'MyFolder'`

Query Syntax Not applicable

Default Not applicable

MMEMory:STORE[:<char>] <file>

Applicable Models: All

(Write-only) Stores the specified file (.sta, .cal, .cst, .csa, .snp, s2px).

Learn about [saving SNP files on the VNA](#).

Learn about [saving S2Px files on the VNA](#).

To save other data files, use `MMEM:STOR:DATA`.

To save ENR files, use `MMEMory:STORE:ENR`

Parameters

<char> Optional argument. The type of file to store. Choose from:

- **ASCFactor**
- **BSCFactor**
- **CORRection** - Calibration Data (.cal)
- **CSARchive** - Instrument state and calibration data (.csa)
- **CSTate** - Instrument state and link to Calibration data (.cst)
- **CSV:FORMat**
- **ENR**
- **[:File]**
- **PLOs**
- **SEGMENT**
- **STATe** - Instrument states (.sta)
- **STATe:TRACe**
- **TRACe**

No <char> is specified for s1p, s2p, s2px and so forth.

Include either <char> or the file extension. If both <char> and the extension are specified, they must agree or an error is returned and no action is taken. See examples below.

[Learn about File Types](#)

<file> String - Name of any valid file that does not already exist. See [Specifying Path Names](#)

Examples

```
MMEM:STOR:STAT 'myState'
mmemory:store 'c:/bin/myState.sta'
MMEM:STOR 'MyData.S2P'
```

Query Syntax Not applicable

Default Not applicable

MMEMory:STORe:CITifile:DATA <filename> - Superseded

Applicable Models: All

This command is replaced with **MMEMory:STORe:DATA**.

(Write only) Saves UNFORMATTED trace data to .cti file. [Learn more.](#)

Parameters

<filename> Any path that already exists with filename.

If the same level as the default, then no path is required.

```
MMEM:STOR:CIT:DATA 'MYFile.cti'
```

Of you can specify an absolute path and filename:

```
mmemory:store:citifile:data "D:\myFile.cti"
```

Query Syntax Not Applicable

Default See [Specifying Path Names](#)

MMEMory:STORe:CITifile:FORMat <filename> - **Superseded**

Applicable Models: All

This command is replaced with **MMEMory:STORe:DATA**.

(Write only) Saves FORMATTED trace data to .cti file. [Learn more.](#)

Parameters

<filename> Any path that already exists with filename.

If the same level, then no path is required

```
MMEM:STOR:CIT:FORM 'MYFile.cti'
```

Of you can specify an absolute path and filename:

```
mmemory:store:citifile:format "D:\myFile.cti"
```

Query Syntax Not Applicable

Default See [Specifying Path Names](#)

MMEMory:STORe:DATA <filename>,<type>,<scope>,<format>,<selector>

Applicable Models: All

(Write-only) Stores trace data to the following file types: *.prn, *.cti, *.csv, *.mdf. Not all choices are valid with other arguments. See [Valid parameter combinations](#) below.

Notes:

To save snp files, use [CALC:MEAS:Data:SNP:PORTs:SAVE](#)

To save state and calibration files, use [MMEM:STORE](#)

This command replaces the following:

- [MMEMory:STORE:CITifile:DATA](#)
 - [MMEMory:STORE:CITifile:FORMat](#)
 - [MMEMory:STORE:TRACe:FORMat:CITifile](#)
 - [MMEMory:STORE:TRACe:CONTent:CITifile](#)
-

Parameters

<filename> (String) Name and extension of the file to which data will be saved. If the extension does not agree with the file type, an error is NOT returned but the data may NOT be what you expect.

[See rules for specifying a filename.](#)

<type> (String) File type to save. Choose from:

"PRN Trace Data" - *.prn data. [Learn more.](#)

"Citifile Data Data" - unformatted *.cti data. [Learn more.](#)

"Citifile Formatted Data" - formatted *.cti data.

"CSV Formatted Data" - formatted *.csv data. [Learn more.](#)

"MDIF Data" - *.mdf data. [Learn more.](#)

"GCA Sweep Data" - Gain compression data. [Learn more.](#)

"IMD Sweep Data" - Swept IMD data. [Learn more.](#)

<scope> (String) How much data to save. Choose from:

"Trace" - only the specified measurement number is saved.

"Displayed" - all displayed measurements are saved.

"Channel" - all measurements that are in the channel in which the selected measurement reside are saved.

"Auto"

For all Standard Meas Class (S-parameter) channels:

- When correction is OFF, the specified trace is saved.
- When correction is ON, all corrected parameters associated with the calibrated ports in the Cal Set are saved.

For all other channels:

- When correction is OFF or ON, the specified trace is saved.

<format> The format in which data is saved. Choose from:

"Displayed" - the format is the same as that in which it is displayed on the VNA screen.

"RI" - Real / Imaginary

"MA" - Magnitude / Angle

"DB" - LogMag / Degrees

<selector> (Integer) Choose from:

-1 Use when <scope> = "Displayed" (does NOT require a selected trace).

<measurement number> Use for all other <scope> selections. Use **Calc:Par:MNUM?** to read the measurement number of the selected trace.

The following are **valid parameter combinations** for ALL measurement classes:

Parameters			
<type> (String)	<scope> (String)	<format> (String)	<selector> (Numeric)
"PRN Trace Data"	"Trace"	"Displayed"	Measurement number
Example: <code>MMEemory:STORE:DATA "myData.prn","PRN Trace Data","Trace","Displayed",2</code>			

"Citifile Data Data"	"Trace" or "Auto" or "Channel"	"RI"	Measurement number
	"Displayed"	"RI"	-1

Example: `MMEemory:STORe:DATA "myData.cti","Citifile Data Data","AUTO","RI",3`

"Citifile Formatted Data"	"Trace" or "Auto"	"RI" or "MA" or "DB"	Measurement number
	"Channel"	"RI" or "MA" or "DB" or "Displayed"	Measurement number
	"Displayed"	"RI" or "MA" or "DB" or "Displayed"	-1

Example: `MMEemory:STORe:DATA "myData.cti","Citifile Formatted Data","AUTO","MA",3`

"CSV Formatted Data"	"Trace" or "Auto" or "Channel"	"RI" or "MA" or "DB" or "Displayed"	Measurement number
	"Displayed"	"RI" or "MA" or "DB"	-1

Example: `MMEemory:STORe:DATA "myData.csv","CSV Formatted Data","displayed","RI",-1`

"MDIF Data"	"Trace" or "Auto"	"RI" or "Displayed" or "Channel"	Measurement number
	"Displayed"	"RI" or "Displayed"	-1

Example: `MMEemory:STORe:DATA "myData.mdf","MDIF Data","displayed","displayed",-1`

The following parameter combinations save *.csv files in specific formats for GCA and Swept IMD classes:

Parameters			
<type> (String)	<scope> (String)	<format> (String)	<selector> (Numeric)
"GCA Sweep Data"	"Auto"	"DB"	GCA channel number
Example: <code>MMEemory:STORe:DATA "myData","gca sweep data","displayed","displayed",-1</code>			
"IMD Sweep Data"	"Auto"	"DB"	Swept IMD channel number
Example: <code>MMEemory:STORe:DATA "myData.mdf","MDIF Data","displayed","displayed",-1</code>			

Query Syntax Not applicable

Default Not applicable

MMEMory:STORe:ENR CAL, <file>

Applicable Models: All

(Write-only) Stores an ENR (Excess Noise Source) data. (Noise Figure App only)

To set and read ENR data, use SENS:CORR:ENR:CAL:TABLE:DATA.

Parameters

<file> String - Name of any valid file that is not already in existence. See [Specifying Path Names](#)

Examples `MMEM:STOR:ENR CAL, "C:/data/calset/346C_16500.enr"`

Query Syntax Not applicable

Default Not applicable

MMEMory:STORe:LIMit <file>

Applicable Models: All

(Write-only) Saves limit test data of the active trace of the active channel into a CSV file.

Parameters

<file> A file path by string format.

The CSV file shall have header lines and a title row as follows.

"# VNA Limit Test"

"# Revision: 1.00"

TYPE,BEGIN STIMULUS,END STIMULUS,BEGIN RESPONSE,END
RESPONSE

Examples `MMEM:STOR:LIM 'MyFile.csv'`

Query Not Applicable

Syntax

Default Not Applicable

MMEMory:STORe:RLIMit <file>

Applicable Models: All

(Write-only) Saves ripple limit test data of the active trace of the active channel into a CSV file.

Parameters

<file> A file path by string format.
The CSV file shall have header lines and a title row as follows.
"# VNA Ripple Limit Test"
"# Revision: 1.00"
TYPE,BEGIN STIMULUS,END STIMULUS,MAX RIPPLE

Examples

```
MMEM:STOR:RLIM 'MyFile.csv'
```

Query Syntax Not Applicable

Default Not Applicable

MMEMemory:STORe:SSCReen <file>

Applicable Models: All

(Write-only) Stores the specified file as a bitmap file (.bmp).

Parameters

<file> String - Name of any valid file that does not already exist. See [Specifying Path Names](#)

Examples

```
MMEM:STOR:SSCR 'myState'  
mmemory:store:sscreen 'c:/bin/myState.bmp'
```

Query Syntax Not applicable

Default Not applicable

MMEMemory:STORe:TRACe:FORMat:CITifile <char> - Superseded

Applicable Models: All

This command is replaced with **MMEMory:STORe:DATA**.

(Read-Write) Specifies the format of subsequent citifile save statements.

Parameters

<char> Format in which the citifile will be saved with subsequent **MMEMory:STORe:CIT:FORMat** statements. Choose from:

MA - Linear Magnitude / degrees

DB - Log Magnitude / degrees

RI - Real / Imaginary

AUTO - Format in which the trace is already displayed. If other than Log Mag, Linear Magnitude, or Real/Imag, then the format will be in Real/Imag.

DISP - Displayed format.

Examples **MMEM:STOR:TRAC:FORM:CIT MA**

Query Syntax MMEMory:STORe:TRACe:FORMat:CITifile?

Return Type Character

Default Auto

MMEMory:STORe:TRACe:CONTents:CITifile <char> - Superseded

Applicable Models: All

This command is replaced with **MMEMory:STORe:DATA**.

(Read-Write) Specifies the contents of subsequent citifile save statements. (See **Data Define Saves**)

Parameters

<char> Choose from:

SING - Single trace

DISP - All displayed traces

AUTO - All displayed traces

Examples **MMEM:STOR:TRAC:CONT:CIT SING**

Query Syntax MMEMory:STORe:TRACe:CONTents?

Return Type Character

Default Auto

MMEMory:STORe:TRACe:FORMat:SNP <char>

Applicable Models: All

(Read-Write) Specifies the format of subsequent .s1p, .s2p, .s3p; s4p save statements. [Learn more.](#)

To save SNP data, use **CALC:MEAS:DATA:SNP:PORTs:SAVE**

Parameters

<char> Choose from:

MA - Linear Magnitude / degrees

DB - Log Magnitude / degrees

RI - Real / Imaginary

AUTO - data is output in currently selected trace format. If other than LogMag, LinMag, or Real/Imag, then output is in Real/Imag.

Examples `MMEM:STOR:TRAC:FORM:SNP MA`

Query Syntax MMEMory:STORe:TRACe:FORMat:SNP?

Return Type Character

Default Auto'

MMEMory:TIME? <fileName>

Applicable Models: All

(Read-only) Returns the (hour, minute, second) that the specified file was last saved. The time is returned in local time as setup in the VNA operating system.

To query the last date and time a cal set was modified, use **CSET DATE?** and **CSET:TIME?**

See Also

MMEM:DATE?

Parameters

<fileName> String - File name. See [Specifying Path Names](#)

Example

```
MMEM:TIME? "myFile.txt"
'returns
+12,+34,+12

mmemory:time? "D:\Calset_18.pcs"
'returns
+12,+34,+12
```

Return Type Comma-separated integers

Default Not applicable

MMEMory:TRANSfer <fileName>,<dataBlock>

Applicable Models: All

(Read-Write) Transfers data between the VNA and an external controller. Other MMEM commands transfer data between the VNA application and the VNA hard drive. If <fileName> already exists, it will be overwritten. The file must be no larger than 20MB.

To read **trace data** from the VNA in block format, use **CALC:MEAS:DATA**.

Parameters

<fileName> String - File name. See [Specifying Path Names](#)

<dataBlock> **Block Data** - The contents of the file.

The data block is a block of binary data. Use the following syntax:

#<num digits><byte count><data bytes><NL><END>

where:

<num_digits> specifies how many digits are contained in <byte_count>

<byte_count> specifies how many data bytes will follow in <data bytes>

Example:

#210ABCDE+WXYZ<nl><end>

Where:

- always sent before definite block data

2 - specifies that the byte count is two digits (2)

10 - specifies the number of data bytes that will follow, not counting
<NL><END>

ABCDE+WXYZ - 10 digits of data

<NL><END> - always sent at the end of block data

Example

[See example program](#)

Query Syntax

MMEMory:TRANsfer? <fileName>

Reads block data from the specified file location.

Default

Not applicable

Output Commands

Controls two output functions: RF power and Noise Source.

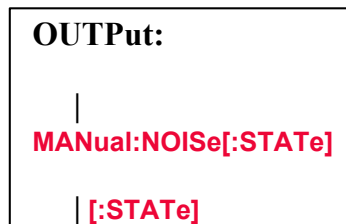

Click on a [red](#) keyword to view the command details.

See Also

- [Example Programs](#)
- [Synchronizing the Analyzer and Controller](#)
- [SCPI Command Tree](#)

OUTPut:MANual:NOISe[:STATe] <bool>

Applicable Models: N522xB, N523xB, N524xB, M937xA, P937xA

(Read-Write) Sets and reads the noise source (28V) ON or OFF.

Parameters

<bool> **ON (1)** - Noise source ON

OFF (0) - Noise source OFF

Examples

```
OUTP:MAN:NOIS 0
output:manual:noise:state 1
```

Query Syntax OUTPut:MANual:NOISe[:STATe]?

Return Type Boolean (1 = ON, 0 = OFF)

Default For VNA models with a [Noise Figure option](#) (028/029/H29), the 28V line is always ON. The ON/OFF state is also available from a VNA softkey menu.

For VNA models WITHOUT a Noise Figure option (028/029/H29), the 28V line is OFF by default and survives a preset. The ON/OFF state is NOT available from a VNA softkey menu.

OUTPut[:STATe] <ON | OFF>

Applicable Models: All

(Read-Write) Turns RF power from the source ON or OFF.

See note about source power state with instrument state save and recall.

Parameters

<ON | OFF> **ON** (or 1) - turns RF power ON

OFF (or 0) - turns RF power OFF

Examples

```
OUTP ON  
output:state off
```

Query Syntax OUTPut[:STATe]?

Return Type Boolean (1 = ON, 0 = OFF)

Default ON

Sense Amplifier

When you use the M9485A, you can control the M9379A amplifier through the VNA firmware. The following commands are available when the launcher includes the M9379A.

```
SENSe:AMPLifier:M9379
| COUNT?
| MODule
| :ATTenuation
| :CHASsis
| :CONTrol[:STATe]
| :PATH
| :POWer[:STATe]
| :SLOT
| :SWITCh:PATH
```

Click on a keyword to view the command details.

SENSe<cnum>:AMPLifier:M9379:COUNT?

Applicable Models: M9485A

(Read-only) Returns the total number of M9379A amplifier modules that are connected to the VNA firmware.

Parameters

<cnum> Any existing channel number; if unspecified, value is set to 1. This command is common for all channels and the setting is ignored.

Examples

```
SENS:AMPL:M9379:COUNT?
sense2:amplifier:m9379:count
```

Return Type Numeric

Default Not applicable

SENSe<cnum>:AMPLifier:M9379:MODule<mod>:ATTenuation <att>

Applicable Models: M9485A

(Read-Write) Sets and reads the attenuation of the M9379A amplifier 1.

Parameters

- <cnum> Any existing channel number; if unspecified, value is set to 1.
- <mod> Module number of M9379A. The number starts from 1 for the leftmost module of M9379A.
- <att> Attenuation in dB from 0 to 28 with 2 step

Examples

```
SENS:AMPL:M9379:MOD1:ATT 10  
sense2:amplifier:m9379:module2:attenuation 5
```

Query Syntax SENSe<cnum>:AMPLifier:M9379:MODule<mod>:ATTenuation?

Return Type Numeric

Default 28

SENSe<cnum>:AMPLifier:M9379:MODule<mod>:CHASsis?

Applicable Models: M9485A

(Read Only) Returns the chassis number where the specified M9379A module is located.

Parameters

- <cnum> Any existing channel number; if unspecified, value is set to 1. This command is common for all channels and the setting is ignored.
- <mod> Module number of M9379A. The number starts from 1 for the leftmost module of M9379A.

Examples

```
SENS:AMPL:M9379:MOD1:CHAS?  
sense2:amplifier:m9379:module2:chassis?
```

Return Type Numeric

Default Not applicable

SENSe<cnum>:AMPLifier:M9379:MODule<mod>:CONTrol[:STATe] <bool>

Applicable Models: M9485A

(Read-Write) Sets and reads the status of M9379A control.

Parameters

- <cnum> Any existing channel number; if unspecified, value is set to 1.
- <mod> Module number of M9379A. The number starts from 1 for the leftmost module of M9379A.
- <bool> Module control state. Choose from:
 - 0** or **OFF** - Skips to control the M9379A at the specified channel.
 - 1** or **ON** - Enables to control the M9379A at the specified channel.

Examples

```
SENS:AMPL:M9379:MOD1:CONT ON  
sense2:amplifier:m9379:module2:control 0
```

Query Syntax SENSE<cnum>:AMPLifier:M9379:MODule<mod>:CONTrol[:STATE]?

Return Type Boolean

Default 1 or ON

```
SENSe<cnum>:AMPLifier:M9379:MODule<mod>:PATH <char>
```

Applicable Models: M9485A

(Read-Write) Sets and reads the path for the M9379A amplifier 1.

Parameters

- <cnum> Any existing channel number; if unspecified, value is set to 1.
- <mod> Module number of M9379A. The number starts from 1 for the leftmost module of M9379A.
- <char> Path. Choose from:
 - THRU** - Through.
 - AMPLifier** - amplifier 1.
 - NFReceiver** - NF receiver switch (NF measurement only)

Examples

```
SENS:AMPL:M9379:MOD1:PATH THRU  
sense2:amplifier:m9379:module2:path amplifier
```

Query Syntax SENSE<cnum>:AMPLifier:M9379:MODule<mod>:PATH?
Return Type Char
Default THRU

SENSE<cnum>:AMPLifier:M9379:MODule<mod>:POWER[:STATe] <bool>

Applicable Models: M9485A

(Read-Write) Sets and reads the status of M9379A power.

Parameters

- <cnum> Any existing channel number; if unspecified, value is set to 1. This command is common for all channels and the setting is ignored.
- <mod> Module number of M9379A. The number starts from 1 for the leftmost module of M9379A.
- <bool> power control state. Choose from:
 - 0** or **OFF** - Power off
 - 1** or **ON** - Power on

Examples

```
SENS:AMPL:M9379:MOD1:POW ON  
sense2:amplifier:m9379:module2:power 0
```

Query Syntax SENSE<cnum>:AMPLifier:M9379:MODule<mod>:POWER[:STATe]?
Return Type Boolean
Default 0 or OFF

SENSE<cnum>:AMPLifier:M9379:MODule<mod>:SLOT?

Applicable Models: M9485A

(Read Only) Reads the slot number where the M9379A is located.

Parameters

- <cnum> Any existing channel number; if unspecified, value is set to 1. This command is common for all channels and the setting is ignored.
- <mod> Module number of M9379A. The number starts from 1 for the leftmost module of M9379A.

Examples

```
SENS:AMPL:M9379:MOD1:SLOT?  
  
sense2:amplifier:m9379:module2:slot?
```

Return Type Numeric

Default Not applicable

SENSe<cnum>:AMPLifier:M9379:MODule<mod>:SWITCh:PATH <char>

Applicable Models: M9485A

(Read-Write) Sets and reads the path for the M9379A switch

Parameters

- <cnum> Any existing channel number; if unspecified, value is set to 1.
- <mod> Module number of M9379A. The number starts from 1 for the leftmost module of M9379A.
- <char> Path. Choose from:
 - A** - Path A
 - B** - Path B
 - NFSource** - NF source switch (NF measurement only)
 - NFLO** - NF LO switch (Option 720 only)
 - NFReceiver** - NF receiver switch (NF measurement only)

Examples

```
SENS:AMPL:M9379:MOD1:SWIT:PATH A  
  
sense2:amplifier:m9379:module2:switch:path b
```

Query Syntax SENSe<cnum>:AMPLifier:M9379:MODule<mod>:SWITCh:PATH?

Return Type <char>

Default A

Sense:Average Commands

Sets sweep-to-sweep averaging parameters. Averaging is a noise reduction technique that averages each data point over a user-specified number of sweeps. Averaging affects all of the measurements in the channel.

SENSe:AVERage
CLEar
COUNT
MODE
[STATe]

Click on a keyword to view the command details.

See Also

- [Example](#) using some of these commands.
- [Learn about Averaging](#)
- [Synchronizing the Analyzer and Controller](#)
- [SCPI Command Tree](#)

SENSe<cnum>:AVERage:CLEar

Applicable Models: All

(Write-only) Clears and restarts averaging of the measurement data. Does NOT apply to point averaging.

Parameters

<cnum> Any existing channel number; if unspecified, value is set to 1.

Examples

```
SENS: AVER: CLE  
sense2: average: clear
```

Query Syntax Not applicable

Default Not applicable

SENSe<cnum>:AVERage:COUNt <num>

Applicable Models: All

(Read-Write) Sets the number of measurements to combine for an average. Must also set **SENS:AVER[:STATe] ON**

Parameters

- <num> Any existing channel number; if unspecified, value is set to 1.
- <num> Number of measurements to average. Choose any number between **1** and **65536** (2^{16}).

Examples

```
SENS:AVER:COUN 999  
sense2:average:count 73
```

Query Syntax SENSE<num>:AVERAge:COUNT?

Return Type Numeric

Default 1

SENSe<num>:AVERAge:MODE <char>

Applicable Models: All

(Read-Write) Sets the type of averaging to perform: Point or Sweep.

Parameters

- <num> Any existing channel number; if unspecified, value is set to 1.
- <num> Averaging Type. Choose from:
 - POINT** - Averaging measurements are made on each data point before stepping to the next data point.
 - SWEEP** - Averaging measurements are made on subsequent sweeps until the required number of averaging sweeps are performed.

Examples

```
SENS:AVER:MODE POIN  
sense2:average:mode sweep
```

Query Syntax SENSE<num>:AVERAge:MODE?

Return Type Character

Default Sweep

SENSe<num>:AVERAge[:STATe] <ON | OFF>

Applicable Models: All

(Read-Write) Turns trace averaging ON or OFF.

Parameters

<cnm> Any existing channel number; if unspecified, value is set to 1.

<ON | OFF> **ON** (or 1) - turns averaging ON.
OFF (or 0) - turns averaging OFF.

Examples

```
SENS:AVER ON  
sense2:average:state off
```

Query Syntax SENSE<cnm>:AVERage[:STATe]?

Return Type Boolean (1 = ON, 0 = OFF)

Default Off

SENSe:BANDwidth | BWIDth Commands

SENSe:BANDwidth | BWIDth:

RESolution <num>

TRACk:FORCe

TRACk[:STATe] <bool>

See Also

- [Example Programs](#)
- [Learn about IF Bandwidth](#)
- [Synchronizing the Analyzer and Controller](#)
- [SCPI Command Tree](#)

SENSe<cnum>:BANDwidth | BWIDth[:RESolution] <num>

Applicable Models: All

(Read-Write) Sets the bandwidth of the digital IF filter to be used in the measurement. (Use either **Sense:Bandwidth** or **Sense:Bwidth**)

Parameters

<cnum> Any existing channel number. If unspecified, value is set to 1

<num> IF Bandwidth in Hz. The list of valid IF Bandwidths is different depending on the VNA model. ([Click to see the lists.](#)) If an invalid number is specified, the analyzer will round up to the closest valid number.

This parameter supports MIN and MAX as arguments. [Learn more.](#)

Examples

```
SENS:BWID 1KHZ
sense2:bandwidth:resolution 1000
```

Query Syntax SENSe<cnum>:BANDwidth | BWIDth[:RESolution]?

Return Type Numeric

Default Varies with VNA model.

SENSe<cnum>:BANDwidth | BWIDth:TRACk:FORCe <bool>

Applicable Models: N522xB, N5234B, N5235B, N524xB, E5080

(Read-Write) Enables/disables the **Reduce IF BW at Low Frequencies** feature in segments with IFBW arbitrary.

(Use either **Sense:Bandwidth:Track:Force** or **Sense:Bwidth:Track:Force**).

Parameters

<num> Any existing channel number. If unspecified, value is set to 1

<bool> Choose from:

ON or **1** - Enable reduce IF BW at Low Frequencies in segments with IFBW arbitrary.

OFF or **0** - Disable reduce IF BW at Low Frequencies in segments with IFBW arbitrary.

Examples

```
SENS:BWID:TRAC:FORC OFF
sense2:bandwidth:track:force 1
```

Query Syntax SENSE<num>:BANDwidth | BWIDth:TRACK:FORCE?

Return Type Boolean

Default OFF

SENSE<num>:BANDwidth | BWIDth:TRACK[:STATE] <bool>

Applicable Models: N522xB, N5234B, N5235B, N524xB, E5080

(Read-Write) Sets and returns the state of the **Reduce IF BW at Low Frequencies** feature.

(Use either **Sense:Bandwidth:Track** or **Sense:Bwidth:Track**).

Parameters

<num> Any existing channel number. If unspecified, value is set to 1

<bool> Choose from:

ON or **1** - Reduce IF BW at Low Frequencies is set ON

OFF or **0** - Reduce IF BW at Low Frequencies is set OFF

Examples

```
SENS:BWID:TRAC OFF
sense2:bandwidth:track 1
```

Query Syntax SENSE<num>:BANDwidth | BWIDth:TRACK[:STATE]?

Return Type Boolean

Default OFF

Sense:Class Command

SENSe:CLASs:

NAME?

Click on a keyword to view the command details.

See Also

- [Learn about Measurement Class](#)
 - [Synchronizing the Analyzer and Controller](#)
 - [SCPI Command Tree](#)
-

SENSe<num>:CLASs:NAME?

Applicable Models: All

(Read-only) Returns the measurement class name of the specified channel. Use **CALCulate:MEASure:DEFine** and **CALCulate:MEASure:PARAmeter** commands to create measurements.

Parameters

<num> Any existing channel number; if unspecified, value is set to 1.

Examples

```
SENS:CLAS:NAME?  
sense2:class:name?
```

```
For a standard S-Parameter channel, returns...  
"Standard"
```

Default Not applicable

Control

When you use E5080B, you can control the Interface control through the VNA firmware.

SENSe:CONTRol:

| [:STATe]

| :DWELI

| :HANDler

| [:DATA]

| [:STATe]

| :DIO

| [:STATE]

| :VIO

| :LEVel

| :IMMediate

| :IOTYpe

| :PIO

| :TYPE

| :LEVel

| :RFFE

| :CLOCK

| :CSEQuence

| :SADDress

| :TYPE

| :BCOunt

| :ADDRess

| [:WRITe]:DATA

| :READ:DATA

| :COUNT

:MACRo
[:STATe]
:COMMand
:FILE
:ARGuments

Click on a keyword to view the command details.

SENSe<cnum>:CONTrol:[:STATe] <bool>

Applicable Models: E5080B

(Read-Write) Sets and read the state of interface control for all channels. Channel number is ignored.

Parameters

<cnum> Channel number.

<bool> Module control state. Choose from:

0 or **OFF** - Interface control port signals won't be sent.

1 or **ON** - Interface control port signals will be sent.

Examples

```
SENS:CONT  
sense2:control?
```

Query Syntax :SENSe<cnum>:CONTrol:[:STATe]?

Return Type Boolean

Default OFF or 0

Preset 0

Save or Recall Yes

SENSe<cnum>:CONTrol:DWELI <char>, <num>

Applicable Models: E5080B

(Read-Write) Sets and read the delay time between the time all interface control port signals and all commands sent and the one measurements start. Set independently per channel and for forward and reverse sweep. Not set per IO type.

Parameters

<num> Channel number.

<char> Character - when to send remote commands. Choose from:

AFTer - After the channel sweep ends.

BEFore - Before the channel sweep starts.

<num> Wait time in milliseconds. Any positive integer is allowed.

Examples

```
SENS:CONT:DWEL BEF 10
sense2:control:dwel1?
```

Query Syntax :SENSE<num>:CONTrol:DWEL? <char>

Return Type Character

Default 0

Preset 0

Save or Recall Yes

SENSE<num>:CONTrol:HANDler:<grp>[:DATA] <char>, <num>

Applicable Models: E5080B

(Read-Write) Sends values to the respective Handler I/O port (A-D). Although ports C and D are normally bidirectional, ONLY Output mode is allowed using the Interface Control feature. It cannot read from these, or any other ports.

Parameters

<num> Channel number.

<grp> Port identifier to set bits for. Choose from:

A , B , C and D .

<char> Character - when to send remote commands. Choose from:

AFTer - After the channel sweep ends.

BEFore - Before the channel sweep starts.

<num> The number of the data bits to set. The range of the value is determined as follows.

Port A: 0 - 255

Port B: 0 - 255

Port C: 0 - 15

Port D: 0 - 15

Examples

```
SENS:CONT:HAND:B AFT, 255  
sense2:control:handler:B? after
```

Query Syntax :SENSe<cnum>:CONTrol:HANDler:<grp>[:DATA]? <char>

Return Type Numeric

Default 0

Preset 0

Save or Recall Yes

SENSe<cnum>:CONTrol:HANDler[:STATE] <char>, <bool>

Applicable Models: E5080B

(Read-Write) Set and read the control function state for each channel. If ON, Handler I/O port signals will be sent before the beginning of the sweep or after the end of the sweep. If OFF, these signals will not be changed.

Parameters

<cnum> Channel number.

<char> Character - when to send remote commands. Choose from:

AFTer - After the channel sweep ends.

BEFore - Before the channel sweep starts.

<bool> Choose from:

ON (1) - Handler I/O port signals will be sent.

OFF (0) - Handler I/O port signals won't be sent.

Examples

```
SENS:CONT:HAND AFT, ON  
sense2:control:handler? after
```

Query Syntax :SENSe<num>:CONTrol:HANDler[:STATe]? <char>

Return Type Boolean

Default 1

Preset 1

Save or Recall Yes

SENSe<num>:CONTrol:DIO<id>[:STATe] <char>, <bool>

Applicable Models: E5080B

(Read-Write) Set and read the control function state for each channel. If ON, DUT control signals will be sent before the beginning of the sweep or after the end of the sweep. If OFF, then DUT signals will not be changed.

Parameters

<num> Channel number.

<id> DIO number, 1 or 2

<char> Character - when to send remote commands. Choose from:

AFTer - After the channel sweep ends.

BEFore - Before the channel sweep starts.

<bool> Function enable or disable control.

Choose from: **ON** or **OFF**

Examples

```
SENS:CONT:DIO1 AFT, ON  
sense2:control:dio1? after
```

Query Syntax :SENSe<num>:CONTrol:DIO<id>[:STATe]? <char>

Return Type Boolean (1= ON, 0= OFF)

Default OFF

SENSe<cnum>:CONTrol:DIO<id>:VIO[:STATe] <char>, <bool>

Applicable Models: E5080B

(Read-Write) Set and read the VIO function state for each channel. If ON, then VIO's voltage is set to the value which is determined by SENSe:CONTrol:DIO:LEVel before the beginning of the sweep or after the end of the sweep. If OFF, the VIO's voltage is disabled.

Parameters

<cnum> Channel number.

<id> DIO number, 1 or 2

<char> Character - when to send remote commands. Choose from:

AFTer - After the channel sweep ends.

BEFore - Before the channel sweep starts.

<bool> Function enable or disable control.

Choose from: **ON** or **OFF**

Examples

```
SENSe:CONT:DIO1:VIO AFT, OFF  
sense2:control:dio1:vio? after
```

Query Syntax :SENSe<cnum>:CONTrol:DIO<id>:VIO[:STATe]? <char>

Return Type Boolean (1= ON, 0= OFF)

Default ON

SENSe<cnum>:CONTrol:DIO<id>:LEVel <char>, <num>

Applicable Models: E5080B

(Read-Write) Specifies IO level of the DUT Control DIO1 or DIO2's 8-bit IO. The value of AFTer is overwritten by the one of BEFore and vice versa due to set the same value to both AFTer and BEFore.

Parameters

<cnum> Channel number.

<id> DIO number, 1 or 2

<char> Character - when to send remote commands. Choose from:

AFTer - After the channel sweep ends.

BEFore - Before the channel sweep starts.

<num> IO level in volt. Value range, 0.9 to 3.5, step 0.05.

Examples `SENS:CONT:DIO1:VIO AFT, OFF`
`sense2:control:dio1:vio? after`

Query Syntax :SENSe<cnum>:CONTrol:DIO<id>:LEVel? <char>

Return Type Numeric

Default 1.2

Note: The default value definition comes from MIPI RFFE standard. Referring to the VIO Supply Pin Requirements, 1.2V is the minimum typical voltage value of the definition.

SENSe<cnum>:CONTrol:DIO<id>:IMMEDIATE <char>

Applicable Models: E5080B

(Write only) Specifies parameter set of DUT Control function for each channel. And, fetch E5080B Hardware status values (PIO input state, RFFE read command results) and stores the values in Firmware variables. If executed, the DUT signals will be sent immediately. It doesn't matter if **Enable DUT Control** is ON or OFF.

Parameters

<cnum> Channel number.

<id> DIO number, 1 or 2

<char> Character - when to send remote commands. Choose from:

AFTer - After the channel sweep ends.

BEFore - Before the channel sweep starts.

Examples `SENS:CONT:DIO1:IMM BEF`

Query Syntax Not applicable

Default Not applicable

SENSe<cnum>:CONTrol:DIO<id>:IOType<iogroup> <char>, <enum>

Applicable Models: E5080B

(Read-Write) Specifies IO function type of the 8-bit IO pin, for each IO group. IO group1 is IO pin 1 and 2, group2 is pin 3 and 4, group3 is pin 5 and 6, group4 is pin 7 and 8.

Parameters

<num> Channel number.

<id> DIO number, 1 or 2

<iogroup> IO group number. Value range, 1 to 4.

<char> Character - when to send remote commands. Choose from:

AFTer - After the channel sweep ends.

BEFore - Before the channel sweep starts.

<enum> Set the IO function for the IO group. Choose from: **PARallel** or **RFFE**

Examples

```
SENS:CONT:DIO1:IOTY AFT, RFFE  
sense2:control:diol:ioty1? after
```

Query Syntax :SENSe<num>:CONTRol:DIO<id>:IOTYpe<iogroup>? <char>

Return Type Character

Default PARallel

SENSe<num>:CONTRol:DIO<id>:PIO<iopin>:TYPE <char>, <enum>

Applicable Models: E5080B

(Read-Write) Set or read the signal direction type of Parallel IO, for each IO pin.. This setting is valid when the IO pin function is selected as parallel IO.

Parameters

<num> Channel number.

<id> DIO number, 1 or 2

<iopin> IO pin number.

<char> Character - when to send remote commands. Choose from:

AFTer - After the channel sweep ends.

BEFore - Before the channel sweep starts.

<enum> IO direction. Choose from: **IN** or **OUT**

Examples

```
SENS:CONT:DIO1:PIO:TYPE AFT, IN
sense2:control:dio1:pio2:type? after
```

Query Syntax :SENSe<cnum>:CONTrol:DIO<id>:PIO<iopin>:TYPE? <char>

Return Type Character

Default OUT

SENSe<cnum>:CONTrol:DIO<id>:PIO<iopin>:LEVel <char>, <enum>

Applicable Models: E5080B

(Read-Write) Set or read the signal level of IO pin, high or low. This setting is valid when the IO pin function is selected as parallel IO. If the IO type is IN, this command shall be a read-only command. Write command will cause error.

Parameters

<cnum> Channel number.

<id> DIO number, 1 or 2

<iopin> IO pin number.

<char> Character - when to send remote commands. Choose from:

AFTer - After the channel sweep ends.

BEFore - Before the channel sweep starts.

<enum> Signal level. Choose from: **HIGH** or **LOW**

Examples

```
SENS:CONT:DIO1:PIO:LEV AFT, HIGH
sense2:control:dio1:pio7:level? after
```

Query Syntax :SENSe<cnum>:CONTrol:DIO<id>:PIO<iopin>:LEVel? <char>

Return Type Character

Default LOW

SENSe<cnum>:CONTrol:DIO<id>:RFFE:CLOCK <char>, <num>

Applicable Models: E5080B

(Read-Write) Set or read the RFFE clock rate.

Parameters

<num> Channel number.

<id> DIO number, 1 or 2

<char> Character - when to send remote commands. Choose from:

AFTer - After the channel sweep ends.

BEFore - Before the channel sweep starts.

<num> Clock rate in Hz. Value range, 25kHz to 25000kHz. Possible values are (50000/n) kHz, with integer n, 2000 to 2.

Examples

```
SENS:CONT:DIO1:RFFE:CLOC AFT, 25000  
sense2:control:dio1:rffe:clock? after
```

Query Syntax :SENSe<num>:CONTrol:DIO<id>:RFFE:CLOCK? <char>

Return Type Numeric

Default 50000

Note: The default value is the minimum integer value of clock rate, which meets the RFFE standard frequency range.

SENSe<num>:CONTrol:DIO<id>:RFFE<rffech>:CSEQuence<csnum>:SADDress <char>, <num>

Applicable Models: E5080B

(Read-Write) Set or read the Slave Address (“SA” in GUI) for the specified command sequence.

Parameters

<num> Channel number.

<id> DIO number, 1 or 2

<rffech> RFFE channel number. 1 to 4.

<csnum> RFFE command sequence number. 1 to 16.

<char> Character - when to send remote commands. Choose from:

AFTer - After the channel sweep ends.

BEFore - Before the channel sweep starts.

<num> DUT RFFE Slave Address. 0 to 15.

Examples

```
SENS:CONT:DIO1:RFFE:CSEQ:SADD AFT, 2  
sense2:control:dio1:rffe1:csequence2:saddress? after
```

Query :SENSe<cnum>:CONTrol:DIO<id>:RFFE<rffech>:CSEQuence<csnum>:SADDress

Syntax <char>

Return Numeric

Type

Default 0

SENSe<cnum>:CONTrol:DIO<id>:RFFE<rffech>:CSEQuence<csnum>:TYPE <char>, <enum>

Applicable Models: E5080B

(Read-Write) Set or read the command sequence type for the specified command sequence.

Parameters

<cnum> Channel number.

<id> DIO number, 1 or 2

<rffech> RFFE channel number. 1 to 4.

<csnum> RFFE command sequence number. 1 to 16.

<char> Character - when to send remote commands. Choose from:

AFTer - After the channel sweep ends.

BEFore - Before the channel sweep starts.

<enum> RFFE command sequence type. Choose from:

R 0WRite : Register 0 Write

RREad : Register Read

RWRite : Register Write

ERRead : Extended Register Read

ERWRite : Extended Register Write

Examples

```
SENS:CONT:DIO1:RFFE:CSEQ:TYPE AFT, R0WR
sense2:control:diol:rffel:csequence2:type? after
```

Query Syntax :SENSe<cnum>:CONTRol:DIO<id>:RFFE<rffech>:CSEQuence<csnum>:TYPE? <char>

Return Type Character

Default RREad

SENSe<cnum>:CONTRol:DIO<id>:RFFE<rffech>:CSEQuence<csnum>:BCOunt <char>, <num>

Applicable Models: E5080B

(Read-Write) Set and read the byte count for the specified command sequence.

Parameters

<cnum> Channel number.

<id> DIO number, 1 or 2

<rffech> RFFE channel number. 1 to 4.

<csnum> RFFE command sequence number. 1 to 16.

<char> Character - when to send remote commands. Choose from:

AFTer - After the channel sweep ends.

BEFore - Before the channel sweep starts.

<num> Byte Count value. Integer value. The value range is coupled with command sequence type setting.

Command sequence type	Byte count range
Register 0 Write	1 (fixed)
Register Read	
Register Write	
Extended Register Write	1 to 16
Extended Register Read	

Examples

```
SENS:CONT:DIO1:RFFE:CSEQ:BCO AFT, 4
sense2:control:diol:rffel:csequence2:bcount? after
```

Query Syntax :SENSe<cnum>:CONTrol:DIO<id>:RFFE<rffech>:CSEquence<csnum>:BCOunt?<char>

Return Type Numeric

Default 1

SENSe<cnum>:CONTrol:DIO<id>:RFFE<rffech>:CSEquence<csnum>:ADDRess <char>, <num>

Applicable Models: E5080B

(Read-Write) Set and read the address value for the specified command sequence.

Parameters

<cnum> Channel number.

<id> DIO number, 1 or 2

<rffech> RFFE channel number. 1 to 4.

<csnum> RFFE command sequence number. 1 to 16.

<char> Character - when to send remote commands. Choose from:

AFTer - After the channel sweep ends.

BEFore - Before the channel sweep starts.

<num> Address value. Integer value. The value range is coupled with command sequence type setting.

Command sequence type	Byte count range
Register 0 Write	0 (fixed)
Register Read	#h00 to #h1F (0-31)
Register Write	
Extended Register Write	#h00 to #hFF (0-255)
Extended Register Read	

Examples

```
SENS:CONT:DIO1:RFFE:CSEQ:ADDR AFT, 4
sense2:control:diol:rffel:csequence2:address? after
```

Query Syntax :SENSe<cnum>:CONTrol:DIO<id>:RFFE<rffech>:CSEquence<csnum>:ADDRess <char>

Return Type Numeric
Default 0

SENSe<cnum>:CONTrol:DIO<id>:RFFE<rffech>:CSEQuence<csnum>[:WRITe]:DATA <char>, <data>

Applicable Models: E5080B

(Read-Write) Set and read the data values for the specified command sequence.

This command works if the command sequence type is “Register 0 Write” or “Register Write” or “Extended Register Write”. If the command sequence type is “Register Read” or “Extended Register Read”, this command will cause error.

Parameters

<cnum> Channel number.

<id> DIO number, 1 or 2

<rffech> RFFE channel number. 1 to 4.

<csnum> RFFE command sequence number. 1 to 16.

<char> Character - when to send remote commands. Choose from:

AFTer - After the channel sweep ends.

BEFore - Before the channel sweep starts.

<data> Comma separated list of data values. The value length is coupled with byte count setting. If data list length does not match with byte count setting, write command will cause error.

Examples

```
SENS:CONT:DIO1:RFFE:CSEQ:WRIT:DATA AFT, 10  
sense2:control:dio1:rff1:csequence2:write:data? after
```

Query Syntax :SENSe<cnum>:CONTrol:DIO<id>:RFFE<rffech>:CSEQuence<csnum>[:WRITe]:[<char>

Return Type Comma separated numeric values

Default 0

SENSe<cnum>:CONTrol:DIO<id>:RFFE<rffech>:CSEQuence<csnum>:READ:DATA? <char>

Applicable Models: E5080B

(Read only) Read the data and parity value pairs from DUT for the specified command sequence.

Parameters

- <num> Channel number.
- <id> DIO number, 1 or 2
- <rffech> RFFE channel number. 1 to 4.
- <csnum> RFFE command sequence number. 1 to 16.
- <char> Character - when to send remote commands. Choose from:
 - AFTer** - After the channel sweep ends.
 - BEFore** - Before the channel sweep starts.

Examples

```
SENS:CONT:DIO1:RFFE:CSEQ:READ:DATA? AFT
sense2:control:dio1:rff1:csequence2:read:data? after
```

- Query Syntax** :SENSe<num>:CONTrol:DIO<id>:RFFE<rffech>:CSEQuence<csnum>:READ:DA<char>
- Return Type** Comma separated numeric values, list of data and parity pairs.
E x. Byte count is 3 case, return values are below:
[data#1],[parity#1],[data#2],[parity#2],[data#3],[parity#3]
- Default** Not applicable

SENSe<num>:CONTrol:DIO<id>:RFFE<rffech>:CSEQuence:COUNT <char>

Applicable Models: E5080B

(Read-Write) Set and read the RFFE Command Sequence count. If user set the larger value than previously set, new RFFE Command Sequences will be added with default parameter value.

Parameters

- <num> Channel number.
- <id> DIO number
- <rffech> RFFE channel number. 1 to 4.

<char> Character - when to send remote commands. Choose from:

AFTer - After the channel sweep ends.

BEFore - Before the channel sweep starts.

Examples

```
SENS:CONT:DIO1:RFFE:CSEQ:COUN AFT
sense2:control:dio1:rff1:csequence:count? after
```

Query Syntax :SENSe<cnum>:CONTrol:DIO<id>:RFFE<rffech>:CSEQuence:COUNT? <char>

Return Type Numeric

Default 0

SENSe<cnum>:CONTrol:MACRo[:STATe] <char>, <bool>

Applicable Models: E5080B

(Read-Write) Enables or disables software interface controls.

Parameters

<cnum> Channel number.

<char> Character - when to send remote commands. Choose from:

AFTer - After the channel sweep ends.

BEFore - Before the channel sweep starts.

<bool> **ON** or **1** - Turns software interface control ON.

OFF or **0** - Turns software interface control OFF.

Examples

```
SENS:CONT:MACR AFT, ON
sense2:control:macro? after
```

Query Syntax :SENSe<cnum>:CONTrol:MACRo[:STATe]? <char>

Return Type Boolean

Default OFF

SENSe<cnum>:CONTrol:MACRo:COMMand <char>, <cmdList>

Applicable Models: E5080B

(Read-Write) Set and read SCPI commands with target GPIB addresses (numbers) or VISA addresses. The specified SCPI commands are sent to the target instruments before the first trace on the channel begins sweeping . It is the end user’s responsibility to use this command.

Parameters

<cnum> Channel number.

<char> Character - when to send remote commands. Choose from:

AFTer - After the channel sweep ends.

BEFore - Before the channel sweep starts.

<cmdList> The string of “\n” separates a pair of GPIB/VISA addresses and SCPI commands, and the string of “ ” separates GPIB/VISA address and SCPI in the following format;

“address1 command1\naddress2 command2\n ...”

Examples

```
SENS:CONT:MACR:COMM AFT
sense2:control:macro? after
```

Query Syntax :SENSe<cnum>:CONTrol:MACRo:COMMand? <char>

Return Type String of comma-separated GPIB/VISA addresses and SCPI commands

Default " "

SENSe<cnum>:CONTrol:MACRo:FILE <char>, <path>

Applicable Models: E5080B

(Read-Write) Set and read a file path to a macro. The macro is executed before the first trace on the channel begins sweeping . It is the end user’s responsibility to use this command. It’s needed to check the check box of “Enable Drive Access” in the SCPI dialog to execute the actual macro file.

Parameters

<cnum> Channel number.

<char> Character - when to send remote commands. Choose from:

AFTer - After the channel sweep ends.

BEFore - Before the channel sweep starts.

<path> Command line strings

Examples `SENS:CONT:MACR:FILE AFT, "cscript D:\temp\test.vbs"
sense2:control:file? after`

Query Syntax :SENSe<cnum>:CONTrol:MACRo:FILE? <char>

Return Type String

Default " "

SENSe<cnum>:CONTrol:MACRo:FILE:ARGuments <char>, <arg>

Applicable Models: E5080B

(Read-Write) Set and read arguments for a macro. The macro is executed before the first trace on the channel begins sweeping . It is the end user's responsibility to use this command. It's needed to check the check box of "Enable Drive Access" in the SCPI dialog to execute the actual macro file.

Parameters

<cnum> Channel number.

<char> Character - when to send remote commands. Choose from:

AFTer - After the channel sweep ends.

BEFore - Before the channel sweep starts.

<arg> Arguments for a macro

Examples `SENS:CONT:MACR:FILE:ARG AFT, "localhost "
sense2:control:file? after`

Query Syntax :SENSe<cnum>:CONTrol:MACRo:FILE:ARGuments? <char>

Return Type String

Default " "

Sense:Correction Commands

Performs and applies calibration and other error correction features.

- To perform a Guided Calibration, use ONLY the **Sens:Corr Coll:GUIDed** commands.
- To perform an Unguided Calibration, do NOT use the Sens:Corr:Coll:Guided commands.
- See the "Unguided" [example programs](#) for clarification.

```
SENSe:CORRection
  CACHe:MODE
  CCHeck
    | [ACQuire]
    | DONE
    | PARAmeter
  CKIT - More Commands
  COLlect
    | [ACQuire]
    | APPLy
    | CKIT - More Commands
    | DISPlay:WINDow
      | AOFF
      | [STATe]
    | GUIDed - More Commands
    | ISOLation:
      | AVER:INCRement
      | ECAL[:STATe]
    | METHod
      | PORT:SUBS:
        | FULL:VAL
        | RESet
        | RESPonse:VAL
        | STAT
    | NOISe
      | ENR:ADAP:DEEMbed[:STATe]
      | LO:PCAL[:STATe]
      |
      | PSEN:ADAP:DEEMbed[:STATe]
    | SAVE
    | SWEEp:CHANnel
      | AOFF
```

| **[STATe]**

CSET - More Commands

ENR:CALibration:TABLE

| **DATA**

| **ID:DATA**

| **SERial:DATA**

EXTension - More Commands

GCSetup

| **POWER**

| **SENSor:**

| **CKIT**

| **CONNector**

IMPedance:INPut

| **MAGNitude**

INTerpolate[:STATe]

ISOLation[:STATe]

METHods

| **MATCH**

| **PORT**

| **SUBSet**

| **FULL[:VALue]**

| **RESet**

| **RESPonse[:VALue]**

| **[:STATe]**

PREference

| **CALibration**

| **[FOM:]RANGe**

| **CSET**

| **SAVE**

| **SAVUser**

| **ECAL**

| **ORientation**

| **OVERrange[:STATe]**

| **PMAP**

| **SIMCal**

| **TRIG:FREE**

RPOWER:OFFSet

| **[AMPLitude]**

RVELocity

| **COAX**

SFOward

| [STATe]

[STATe]

TCOLd:USER:VALue

TDR More Commands

TStandards

| [STATe]

TYPE

| CATalog?

WAVE[:METHod]

Click on a keyword to view the command details.

Blue commands are superseded.

See Also

- [Example Programs](#)
- [New See Calibrating the VNA Using SCPI](#)
- [Learn about Measurement Calibration](#)
- [Synchronizing the Analyzer and Controller](#)
- [SCPI Command Tree](#)

SENSe:CORRection:CAChE:MODE <num>

Applicable Models: All

(Read-Write) Set this mode at ON for SNP file fast saving. This must be enabled before the SNP data is acquired by `CALC:MEAS:DATA:SNP:PORTS:SAVE` or `CALC:DATA:SNP:PORTS:SAVE`. This value is not channel specific and applies to all standard channels.

Parameters

<num> 0: Always off

1: Always on

N: On when the current correction port count is = N. For example, if correction is done at 4 ports and N=5, cache mode is OFF

Examples

```
SENS:CORR:CAChE:MODE 2 'any value > 0 and < 9 will work for this example
```

```
SENS:SWE:MODE SING;*OPC?
```



```
CALC:MEAS1:DATA:SNP:PORTS:SAVE
"1,2,3,4,5,6,7,8","multiportdevice.s8p", FAST
```

Query Syntax SENSE:CORRection:CAChE:MODE?

Return Type Numeric

Default 5 at Firmware restart. Preset does not affect the setting.

SENSe<cnum>:CORRection:CChEck[:ACQuire] <mod>[,char]

Applicable Models: All

(Write-only) Reads the 'confidence data' associated with the specified ECal module and puts it into memory. The measurement is selected using **SENS:CORR:CCH:PAR**. This command is compatible with *OPC.

Note: A confidence check can NOT be performed remotely from User Characterizations that are stored on the VNA disk.

Parameters

<cnum> Any existing channel number. If unspecified, value is set to 1.

<mod> ECAL Module that contains the confidence data. Choose from:

ECAL1

..through..

ECAL50

[char] Optional argument. Specifies which characterization within the ECal module that the confidence data will be read from.

CHAR0 Factory characterization (data that was stored in the ECal module by Keysight). Default if not specified.

CHAR1 User characterization #1

CHAR2 User characterization #2

...and so forth up to:

CHAR12 User characterization #12

Examples

```
SENS:CORR:CChEck ECAL2
```

```
sense2:correction:ccheck:acquire ecal1,char1
```

Query Syntax Not applicable

Default Not applicable

SENSe<cnUm>:CORRection:CCHeck:DONE

Applicable Models: All

(Write-only) Concludes the Confidence Check and sets the ECal module back into the idle state.

Parameters

<cnUm> Any existing channel number. If unspecified, value is set to 1

Examples

```
SENS:CORR:CCH:DONE
sense2:correction:ccheck:done
```

Query Syntax Not applicable

Default Not applicable

SENSe<cnUm>:CORRection:CCHeck:PARAmeter <Mname>

Applicable Models: All

(Read-Write) Specifies an existing measurement to be used for the Confidence Check.

Note: A confidence check can NOT be performed remotely from User Characterizations that are stored on the VNA disk.

Parameters

<cnUm> Any existing channel number. If unspecified, value is set to 1

<Mname> Name of the measurement you are selecting for the confidence check. The measurement must already exist.

Examples

```
SENS:CORR:CCH:PAR 'TEST'
'selects the measurement "test" on channel 1 for the confidence
check

sense2:correction:ccheck:parameter 'test'
'selects the measurement "test" on channel 2 for the confidence
check
```

Query Syntax SENSe<cnUm>:CORRection:CCHeck:PARAmeter?

Returns the name of the selected measurement on channel <cnUm>.

Return Type String

Default Not applicable

SENSe<cnum>:CORRection:COLLect[:ACQuire] <class>[,subclass][,sync]

Applicable Models: All

(Write-only) For UNGUIDED calibration, measures the specified standards from the selected calibration kit. The calibration kit is selected using the **Sense:Correction:Collect:CKIT** command.

For using two sets of standards, see **SENS:CORR:TST**.

Note: Before using this command you must select two items:

1. Select a calibration method using **SENS:CORR:COLL:METH**
2. Select a measurement using **CALCulate:MEASure:DEFine**. You can select one measurement for each channel.

Parameters

<cnum> Any existing channel number. If unspecified, value is set to 1

<class> **Measures the standards associated with these class labels.** Choose from:

Label	SOLT (Forward)	SOLT (Reverse)	TRL
STAN1	SA	SA	TRL "R"
STAN2	SB	SB	N/A
STAN3	SC	SC	TRL "L"
STAN4	FWD TRANS	REV TRANS	TRL "T"
STAN5	Generic Isolation; not associated with calibration kit definition.		
ECAL1			

through ECAL modules

ECAL50

RESPonse Same as **Normalize** selection in Unguided Cal. (subclass is ignored)

POWer Take a receiver power cal sweep and turn correction ON

SLSET Sets 'sliding load type', and increments the "number of slides" count. The total number of slides is critical to the correct calculation of the sliding load algorithm. See a **sliding load cal example**.

SLDONE Computes the sliding load using a circle fit algorithm.

[subclass] Optional argument. For mechanical calibration kits, choose from the following to specify the standard to be acquired from the **SENS:CORR:COLL:CKIT:ORDer** list. If not specified, subclass is set to **SST1**.

- SST1** First standard in the order list
- SST2** Second standard in the order list
- SST3** Third standard in the order list
- SST4** Fourth standard in the order list
- SST5** Fifth standard in the order list
- SST6** Sixth standard in the order list
- SST7** Seventh standard in the order list

If an ECAL module (1 through 8) is specified for <class>, choose one of the following for specifying which characterization within the ECal module will be used for the acquire. If not specified, the default is **CHAR0**.

- CHAR0** Factory characterization (data that was stored in the ECal module by Keysight)
- CHAR1** User characterization #1
- CHAR2** User characterization #2

...and so forth up to:

- CHAR12** User characterization #12

[sync] Optional argument. Choose from:

SYNchronous - blocks SCPI commands during standard measurement (default behavior)

ASYNchronous - does NOT block SCPI commands during standard measurement.

[Learn more about this argument](#)

Examples

```
SENS:CORR:COLL STAN1
```

```
'If SENS:CORR:COLL:CKIT:ORDER2 5,3,7  
was specified, the following command measures standard 3 (the  
second in the order list)
```

```
sense1:correction:collect:acquire stan3,sst2
```

```
SENS:CORR:COLL ECAL4,ASYN; *OPC?
```

```
sense2:correction:collect:acquire ecal2,char1
```

Query Syntax Not applicable

Default Not applicable

SENSe<cnum>:CORRection:COLLect:APPLY

Applicable Models: All

(Write-only) Applies error terms to the measurement that is selected using `CALCulate:MEASure:PARAmeter`.

Note: Before using this command you must select a measurement using `CALCulate:MEASure:DEFine`. You can select one measurement for each channel.

Note: This command is only necessary if you need to modify error terms. If you do not need to modify error terms, `SENSe<cnum>:CORRection:COLLect:SAVE` calculates and then automatically applies error terms after you use `SENS:CORR:COLL:ACQuire` to measure cal standards.

Parameters

<cnum> Any existing channel number. If unspecified, value is set to 1

Example

```
1. CALCulate2:PARAmeter:SElect S21_2 'select the measurement to  
   apply terms to  
2. SENSe2:CORRection:COLLect:MEthod SPARSOLT 'set type of cal  
   method.  
3. CALCulate2:DATA? SCORR1 'download the error term of interest  
4. 'Modify the error term here  
5. CALCulate2:DATA SCORR1 'upload the error term of interest  
6. SENSe2:CORRection:COLLect:APPLY 'applies the error terms to  
   the measurement
```

Query Syntax Not applicable

Default Not applicable

SENSe:CORRection:COLLect:DISPlay:WINDow:AOff

Applicable Models: All

(Write-only) Clears the flags for windows to be shown during calibrations. To flag a window to be shown see **SENSe:CORRection:COLLect:DISPlay:WINDow:AOff**.

Examples

```
SENSe:CORRection:COLLect:DISPlay:WINDow:AOff
```

```
sense:correction:collect:display>window:aoff
```

[See an example using this command.](#)

Query Syntax Not Applicable

Default Not Applicable

SENSe:CORRection:COLLect:DISPlay:WINDow<wNum>[:STATe] <bool>

Applicable Models: All

(Write-only) Set the 'show' state of the window to be displayed during a calibration to view the measurements/channels. [Learn more.](#)

When this command is sent, the specified window is 'flagged' to be shown during calibration. The flag is cleared when the window is closed. A Preset or Instrument State Recall also closes the window. If the same window number is reopened, this command must be sent again to show the window during a calibration. The flag is NOT saved with an instrument state.

Send this command for each additional window to show during a calibration.

Parameters

<wNum> Window number to show during a calibration. The calibration window will also be shown with this window.

The window must already be created.

Use **DISPlay:CATalog?** to read all existing window numbers.

<bool> Window state. Choose from:

ON (or 1) - Show the specified window during calibration.

OFF (or 0) - Do NOT show the specified window during calibration.

Examples

```
SENS:CORR:COLL:DISP:WIND1 1
```

```
sense:correction:collect:display>window2:state off
```

See an example using this command.

Query Syntax Not Applicable

Default OFF

SENSe:CORRection:COLLEct:ISOLation:AVERage:INCRement <num>

Applicable Models: All

(Read-Write) Specifies amount to increment (increase) the channel averaging factor during isolation measurement of the ECal module during an unguided ECal calibration.

Note: if the channel currently has averaging turned OFF and <num> is greater than 1, averaging will be turned ON only during the isolation measurements and with the averaging factor equal to <num>.

Parameters

<num> Incremental Averaging factor. The maximum averaging factor is 65536 (2^{16}).

Examples

```
SENS:CORR:COLL:ISOL:AVER:INCR 16
```

```
sense:correction:collect:isolation:average:increment 0
```

Query Syntax SENSe:CORRection:COLLEct:ISOLation:AVERage:INCRement?

Return Type Numeric

Default 8 - If this command is NOT sent, but **ECal isolation is measured**, then averaging will be turned ON with factor set to 8 during the isolation measurement.

SENSe<cnum>:CORRection:COLLEct:ISOLation:ECAL[:STATe] <bool>

Applicable Models: All

(Read-Write) Specifies whether or not the isolation state of the ECal module will be measured as part of an unguided ECal calibration.

An unguided calibration is performed using the SENS:CORR:COLL:METH and SENS:CORR:COLL:ACQ commands.

Note: The inherent isolation of the VNA is better than that attained with this command. ONLY use this command when using an external test set, and ONLY using a 8509x ECal module.

Parameters

- <cnum> Any existing channel number. If unspecified, value is set to 1
- <bool> **ON** (or 1) - isolation is measured during the unguided ECal calibration.
OFF (or 0) isolation is NOT measured during the unguided ECal calibration.

Examples

```
SENS1:CORR:COLL:ISOL:ECAL ON  
sense2:correction:collect:isolation:ecal:state 0
```

Query Syntax SENSE:CORRection:COLLect:ISOLation:ECAL:STATe?

Return Type Boolean (1 = ON, 0 = OFF)

Default OFF

SENSe<cnum>:CORRection:COLLect:METHod <char>

Applicable Models: All

(Read-Write) For UNGUIDED calibration, sets the calibration method (also known as 'Calibration Type' on calibration dialog box.) To select a Cal Type from a Cal Set, use CALC:MEAS:CORR:TYPE.

Note: Before using this command you must select a measurement using CALCulate:MEASure:PARAmeter. You can select one measurement for each channel.

Parameters

- <cnum> Any existing channel number. If unspecified, value is set to 1
- <char> Choose from:

Method	Description
NONE	No Cal method
REFL1OPEN	Response Open
REFL1SHORT or REFL1	Response Short
REFL3	Full 1 port
RESPonse	Same as Normalize selection in Unguided Cal.
RPOWer	Receiver Power Cal - Used only with receiver measurements.
TRAN1	Response Thru - Requires a Thru standard.
TRAN2	Response Thru and Isolation - Requires a Thru standard.
SPARSOLT	Full SOLT 2 port

Examples	<pre>SENS:CORR:COLL:METH REFL1 sense2:correction:collect:method sparsolt</pre>
Query Syntax	SENSe<num>:CORRection:COLLect:METhod?
Return Type	Character
Default	Not Applicable

SENSe<num>:CORRection:COLLect:METhod:PORT:SUBS:FULL:VAL <port numbers>

Applicable Models: M9485A

(Read-Write) : Specify the ports allowed to participate in a multiport calibration.

Parameters

- <num> Any existing channel number. If unspecified, value is set to 1
- <port numbers> comma separated list of ports

Examples

```
SENS:CORR:COLL:METH:PORT:SUBS:FULL:VAL 1,2,3
sense2:correction:collect:method:port:subs:full:val 1,2,3
```

Calset is 16 port VNA with a 16 port calibration.

Full 3Port (1,2,3) error correction on ports 1,2,3

All other port parameters are uncorrected.

Query Syntax SENSE<cnum>:CORRection:COLLect:METHod:PORT:SUBS:FULL:VAL?

Return Type Character

Default Not Applicable

SENSe<cnum>:CORRection:COLLect:METHod:PORT:SUBS:RESet

Applicable Models: M9485A

(Write Only) : Reset the the full and response list of the port subset correction.

Parameters

<cnum> Any existing channel number. If unspecified, value is set to 1

Examples

```
SENS:CORR:COLL:METH:PORT:SUBS:RES
```

Query Syntax Not Applicable

Return Type Not Applicable

Default Not Applicable

SENSe<cnum>:CORRection:COLLect:METHod:PORT:SUBS:RESPonse:VAL <port numbers>

Applicable Models: M9485A

(Read-Write) : Specify the ports that can be corrected using lesser corrections (enhanced response). This list is not allowed to overlap with the full multiport calibration list specified by :SENS:CORR:COLL:METH:PORT:FULL:VAL.

Parameters

<cnum> Any existing channel number. If unspecified, value is set to 1

<port numbers> comma separated list of ports

Examples

Calset: 16 port VNA with a 16 port calibration

Example 1

```
SENS:CORR:METH:PORT:SUBS:FULL:VAL 1,2,3,4,5,6
```

```
SENS:CORR:METH:PORT:SUBS:RESP:VAL 7,8,
```

Full 6 Port on ports 1 to 6

Enhanced Response for parameters involving ports 7 and 8

No correction for ports 9 to 16

Example 2

```
SENS:CORR:METH:PORT:SUBS:FULL:VAL 0
```

```
SENS:CORR:METH:PORT:SUBS:RESP:VAL  
1,2,3,4,5,6,7,8,9,10,11,12,13,14,15,16
```

All parameters are enhance response corrected

Query Syntax SENSE<cnum>:CORRection:COLLect:METhod:PORT:SUBS:RESPonse:VAL?

Return Type Character

Default Not Applicable

SENSe<cnum>:CORRection:COLLect:METhod:PORT:SUBS:STAT <bool>

Applicable Models: M9485A

(Read-Write) Enabling the port subset correction

Parameters

<cnum> Any existing channel number. If unspecified, value is set to 1

<bool> Devolve Calibration state. Choose from:

OFF or 0 - Off .

ON or 1 - On

Examples

```
SENS:CORR:COLL:METH:PORT:SUBS:STAT ON
sense2:correction:collect:method:port:subs:stat 1
```

Query Syntax

```
SENSe<cnm>:CORRection:COLLect:METHod:PORT:SUBS:STAT?
```

Return Type

Boolean

Default

Not Applicable

SENSe<ch>:CORRection:COLLect:NOISe:ENR:ADAPter:DEEMbed:[STATe] <bool>

Applicable Models: All with Noise Figure Option (S9x029A/B, 028, 029)

(Read-Write) Set and read the state of ENR Adapter de-embedding. [Learn more.](#)

Parameters

<ch> Any existing channel number. If unspecified, value is set to 1

<bool> ENR Adapter de-embed state. Choose from:

OFF or **0** - Do not force de-embedding.

ON or **1** - Force de-embedding.

Examples

```
SENS:CORR:COLL:NOIS:ENR:ADAP:DEEM 0
sense2:correction:collect:noise:enr:adapter:deembed:state ON
```

Query Syntax

```
SENSe:CORRection:COLLect:NOISe:ENR:ADAPter:DEEMbed:[STATe]?
```

Return Type

Boolean

Default

0 - OFF

SENSe<ch>:CORRection:COLLect:NOISe:LO<n>:PCAL[:STATe] <bool>

Applicable Models: VNAs with Noise Figure Option (S9x029A/B, 028, 029) (Excepts M9485A, M980xA, P50xxA)

(Read-Write) Enables and disables LO power calibration for NFX.

Parameters

- <ch> Any existing channel number. If unspecified, value is set to 1
- <n> LO Stage (number). Choose 1 for NFX.
- <bool> LO Power Cal state. Choose from:
 - OFF** or **0** - Disable LO Power Cal
 - ON** or **1** - Enable LO Power Cal

Examples

```
SENS:CORR:COLL:NOIS:LO1:PCAL 0  
sense2:correction:collect:noise:lo1:pcal:state ON
```

Query Syntax SENSE:CORRection:COLLect:NOISe:LO<n>:PCAL:STATe?

Return Type Boolean

Default 0 - OFF

SENSe<ch>:CORRection:COLLect:NOISe:PSENSor:ADAPter:DEEMbed:[STATe] <bool>

Applicable Models: VNAs with Noise Figure Option (S9x029A/B, 028, 029)

(Read-Write) Set and read the state of power sensor adapter de-embedding. [Learn more.](#)

Parameters

- <ch> Any existing channel number. If unspecified, value is set to 1
- <bool> Power sensor adapter de-embed state. Choose from:
 - OFF** or **0** - Do not force de-embedding.
 - ON** or **1** - Force de-embedding.

Examples

```
SENS:CORR:COLL:NOIS:PSEN:ADAP:DEEM 0  
sense2:correction:collect:noise:psensor:adapter:deembed:state ON
```

Query Syntax SENSe:CORRection:COLLect:NOISe:PSENSor:ADAPter:DEEMbed:[STATe]?

Return Type Boolean

Type

Default O - OFF

SENSe<cnum>:CORRection:COLLect:SAVE

Applicable Models: All

(Write-only) For UNGUIDED calibrations ONLY. This command does the following:

- calculates the error terms using the selected :METHod
- applies the error terms to the selected measurement (turns error correction ON.)
- saves the calibration error-terms to the channels Cal Register or a User Cal Set.

The Cal Register or User Cal Set is determined by the setting of the **SENS:CORR:PREFERENCE:CSET:SAVE** command.

Do NOT use this command during an ECAL. When performing an ECAL calibration using **SENS:CORR:COLL:ACQuire**, this SAVE operation is performed automatically before the completion of a successful ACQuire.

Before using this command you must select a measurement using **CALCulate:MEASure:PARAmeter**. You can select one measurement for each channel.

Parameters

<cnum> Any existing channel number. If unspecified, value is set to 1

Examples

```
SENS:CORR:COLL:SAVE  
sense2:correction:collect:save
```

Query Syntax Not applicable

Default Not applicable

SENSe:CORRection:COLLect:SWEep:CHANnel:AOff

Applicable Models: All

(Write-only) Clears ALL flags for channels to sweep during calibration. To flag a channel, see `SENS:CORR:COLL:SWE:CHAN`.

Examples

```
SENS:CORR:COLL:SWE:CHAN:AOFF
sense:correction:collect:sweep:channel:aoff
See an example using this command.
```

Default Not applicable

SENSe<cnum>:CORRection:COLLection:SWEep:CHANnel<cnum2>[:STATe] <bool>

Applicable Models: All

(Write-only) Specifies the channel to sweep during a Calibration.

When this command is sent, the <cnum2> channel is 'flagged' to be swept during calibration.

The flag is cleared when the channel is deleted, if the Measurement Class is changed, or if all measurements are deleted from the channel.

If the same channel number is recreated, this command must be sent again to sweep the channel during a calibration. The flag is NOT saved with an instrument state.

A Preset or Instrument State Recall deletes the channel.

Parameters

<cnum> The channel to be calibrated. If unspecified, value is set to 1.

<cnum2> The channel to sweep when waiting to measure a standard.

This channel must already exist with at least one measurement in the channel. If this channel is in continuous sweep mode, it must have the same attenuator settings and path configuration (PNA-X only).

<bool> Channel sweep state. Choose from:

ON (or 1) - Sweep the channel during calibration.

OFF (or 0) - Do NOT sweep the channel during calibration.

Examples

```
SENS:CORR:COLL:SWE:CHAN2 1
sense2:correction:collect:sweep:channel3:state off
See an example using this command.
```

Query Syntax Not Applicable

Default OFF

SENSe:CORRection:ENR:CALibration:TABLE:DATA <freq, value, freq, value...>

Applicable Models: All

(Read-Write) Set and read the ENR (Excess Noise Ratio) calibration data. All of the frequency and ENR data must be sent at the same time. Use **MMEM:LOAD** to load, and **MMEM:STORE:ENR CAL** to save ENR table data from disk. [Learn more about Noise Source ENR files.](#)

Parameters

<freq, value> (Numeric) ENR data. Frequency value in Hz followed by a ENR noise value in dB. Enter as many pairs as necessary.

Examples

```
SENS:CORR:ENR:CAL:TABL:DATA 1.0E9,14.37,2.5E9,15.28
sense:correction:enr:calibration:table:data
1.0E9,14.37,2.5E9,15.28
```

Query Syntax SENSe:CORRection:ENR:CALibration:TABLE:DATA?

Return Type Comma separated numeric values

Default Not Applicable

SENSe:CORRection:ENR:CALibration:TABLE:ID:DATA <id>

Applicable Models: All

(Read-Write) Sets and returns ID of ENR table. While this is for informational purposes only, it can be used to record the model of the noise source. [Learn more about ENR files.](#)

Parameters

<id> (String) Identifier for the ENR table.

Examples

```
SENS:CORR:ENR:CAL:TABL:ID:DATA "346C"
sense:correction:enr:calibration:table:id:data "ENR Table"
```

Query Syntax SENSe:CORRection:ENR:CALibration:TABLE:ID:DATA?

Return Type String

Default Not Applicable

SENSe:CORRection:ENR:CALibration:TABLE:SERial:DATA <sn>

Applicable Models: All

(Read-Write) Sets and returns the serial number of noise source. This is for informational purposes only to identify the specific noise source for which the data pertains. [Learn more about ENR files.](#)

Parameters

<sn> Serial number of the noise source for which the data applies, enclosed in quotes.

Examples

```
SENS:CORR:ENR:CAL:TABL:SER:DATA "ABCD1234"  
sense:correction:enr:calibration:table:serial:data "ABCD1234"
```

Query Syntax SENSE:CORRection:ENR:CALibration:TABLE:SERial:DATA?

Return Type String

Default Not Applicable

SENSe<ch>:CORRection:GCSetup:POWer <num>

Applicable Models: N522xB, N524xB, M9485A, E5080

(Read-Write) Set and read the power level at which to perform the Source Power Cal portion of a Gain Compression (Opt S93086A/B) Calibration. [Learn more about this setting.](#)

Parameters

<num> Power level in dB. Choose a value from +30 to (-30).

Examples

```
SENS:CORR:GCS:POW 0  
sense:correction:gcsetup:power 5
```

Query Syntax SENSE:CORRection:GCSetup:POWer?

Return Type Numeric

Default 0

SENSe<ch>:CORRection:GCSetup:SENSor:CKIT <string>

Applicable Models: N522xB, N524xB, M9485A, E5080

(Read-Write) Set and read the cal kit to be used for calibrating at the port 1 reference plane when the power sensor connector is different from the DUT port 1. [Learn more.](#)

Parameters

<string> Cal Kit. Use **SENS:CORR:COLL:GUID:CKIT:PORT1:CAT?** to return a list of valid cal kits.

Examples

```
SENS:CORR:GCS:SENS:CKIT "85052B"
```

Query Syntax SENSE:CORRection:GCSetup:SENSor:CKIT?

Return Type String

Default Not Applicable

SENSe<ch>:CORRection:GCSetup:SENSor:CONNector<string>

Applicable Models: N522xB, N524xB, M9485A, E5080

(Read-Write) Set and read the power sensor connector type which is used to perform the Source Power Cal portion of a Gain Compression Calibration. [Learn more.](#)

Parameters

<string> Power sensor connector type. Use **SENS:CORR:COLL:GUID:CONN:CAT?** to return a list of valid connector types.

Select "Ignored" to NOT compensate for the adapter.

Examples

```
SENS:CORR:GCS:SENS:CKIT "3.5 mm (50) male"
```

Query Syntax SENSE:CORRection:GCSetup:SENSor:CKIT?

Return Type String

Default Not Applicable

SENSe:CORRection:IMPedance:INPut:MAGNitude <num>

Applicable Models: All

(Read-Write) Sets and returns the system impedance value for the analyzer.

Parameters

<num> System Impedance value in ohms. Choose any number between 0.001 and 1000 ohms.

Examples

```
SENS:CORR:IMP:INP:MAGN 75  
sense:correction:impedance:input:magnitude 50.5
```

Query Syntax SENSE:CORRection:IMPedance:INPut:MAGNitude?

Return Type Numeric

Default 50

SENSe<ch>:CORRection:INTerpolate[:STATe] <ON | OFF>

Applicable Models: All

(Read-Write) Turns correction interpolation ON or OFF.

Note: Before using this command you must select a measurement using **CALC:PAR:SEL**. You can select one measurement for each channel.

Parameters

<ch> Any existing channel number. If unspecified, value is set to 1.

<ON | OFF> **ON** (or 1) - turns interpolation ON.
OFF (or 0) - turns interpolation OFF.

Examples

```
SENS:CORR:INT ON  
sense2:correction:interpolate:state off
```

Query Syntax SENSe<cnum>:CORRection:INTerpolate[:STATe]?

Return Type Boolean (1 = ON, 0 = OFF)

Default ON

SENSe<ch>:CORRection:ISOLation[:STATe] <ON | OFF> OBSOLETE

This command no longer works beginning in the VNA 5.2 release. The set and query of this command will NOT return an error.

To perform isolation as part of an unguided calibration, you must explicitly measure the isolation standard using **SENS:CORR:COLL:ACQ Stan5**.

To measure isolation as part of an ECal, use **SENS:CORR:COLL:ISOL:ECAL**.

(Read-Write) Turns isolation cal ON or OFF during Full 2-port calibration. If this command is not sent, the default state is to **disable** Isolation.

Parameters

- <ch> Any existing channel number. If unspecified, value is set to 1.
- <ON | OFF> **ON** (or 1) - turns isolation ON.
- OFF** (or 0) - turns isolation OFF.

Examples

```
SENS:CORR:ISOL ON  
sense2:correction:isolation:state off
```

Query Syntax SENSE<num>:CORRection:ISOLation[:STATe]?

Return Type Boolean (1 = ON, 0 = OFF)

Default OFF - (Isolation disabled)

SENSe<ch>:CORRection:METHods:MATCh <bool>

Applicable Models: All

(Read-Write) Turns match-correction ON or OFF. Use this command AFTER performing an Guided Power Cal. [Learn more](#).

Parameters

- <ch> Channel number on which Guided Power Cal was performed. If unspecified, value is set to 1.
- <bool> **ON** (or 1) - Turns match-correction ON
- OFF** (or 0) - Turns match-correction OFF.

Examples

```
SENS:CORR:METH:MATC 0  
sense2:correction:methods:match off
```

Query Syntax SENSe<num>:CORRection:METHods:MATCh?

Return Type Boolean (1 = ON, 0 = OFF)

Default ON

SENSe<ch>:CORRection:METhods:PORT:SUBSet:FULL[:VALue] <port numbers>

Applicable Models: All

(Read-Write) Sets and returns the selected ports to include in a full NPort correction. All other ports are corrected with enhanced response calibration if available. [Learn more](#).

Note: The **SENSe:CORRection:METhods:PORT:SUBSet[:STATe]** must be set to ON to enable the full command.

Parameters

- <ch>** Channel number.
- <port numbers>** Comma separated list of ports to include in the full correction.

Examples

16-port VNA with an active 16-port calibration

```
SENS:CORR:METH:PORT:SUBS:STAT 1
SENS:CORR:METH:PORT:SUBS:FULL:VAL 1,2,3
sense2:correction:methods:port:subset:full:value 1,2,3
```

```
Result: Full correction on ports 1, 2, and 3
All other port parameters are uncorrected
```

Query Syntax SENSe<cnum>:CORRection:METhods:PORT:SUBSet:FULL[:VALue]?

Return Type Array_int

Default All ports included

SENSe<ch>:CORRection:METhods:PORT:SUBSet:RESet

Applicable Models: All

(Write) Resets the full and response list to their default values. [Learn more](#).

Parameters

- <ch>** Channel number.

Examples

```
SENS:CORR:METH:PORT:SUBS:RES
sense2:correction:methods:port:subset:reset
```

Return Type Not applicable

Default Not applicable

SENSe<ch>:CORRection:METhods:PORT:SUBSet:RESPOuse[:VALue] <port numbers>

Applicable Models: All

(Read-Write) Sets and returns the selected ports to be corrected with enhanced response calibration.
[Learn more.](#)

Note: The **SENSe:CORRection:METhods:PORT:SUBSet[:STATe]** must be set to ON to enable the response command.

Parameters

- <ch> Channel number.
- <port numbers> Comma separated list of ports to include for enhanced response correction.

Examples

```
Example #1:  
16-port VNA with an active 16-port calibration  
  
SENS:CORR:METH:PORT:SUBS:STAT 1  
SENS:CORR:METH:PORT:SUBS:FULL:VAL 1,2,3,4,5,6  
SENS:CORR:METH:PORT:SUBS:RESP:VAL 7,8  
  
Result: Full correction on ports 1-6  
Enhanced response corrected for parameters involving ports 7 and 8  
No correction for ports 9-16  
  
Example #2:  
16-port VNA with an active 16-port calibration  
  
SENS:CORR:METH:PORT:SUBS:FULL:VAL 0  
SENS:CORR:METH:PORT:SUBS:RESP:VAL  
1,2,3,4,5,6,7,8,9,10,11,12,13,14,15,16  
Result: Enhanced response correction for parameters involving any ports
```

Query Syntax SENSe<cnum>:CORRection:METhods:PORT:SUBSet:RESPOuse[:VALue]?

Return Type Array_int

Default Empty list

SENSe<ch>:CORRection:METhods:PORT:SUBSet[:STATe] <bool>

Applicable Models: All

(Read-Write) Set and return the ON/OFF subset correction state. [Learn more.](#)

Parameters

- <ch> Channel number.
- <bool> Choose from:
 - 0 - OFF** - Subset correction OFF.
 - 1 - ON** - Subset correction ON.

Examples

```
SENS:CORR:METH:PORT:SUBS:STAT 1  
sense2:correction:methods:port:subset:state 1
```

Query Syntax SENSE<cnum>:CORRection:METhods:PORT:SUBSet[:STATe]?

Return Type Boolean

Default 0

SENSe:CORRection:PREFeRence:CALibration[:FOM]:RANGe <char>

Applicable Models: All

(Read-Write) Specifies the FOM frequency range to use when performing calibration.

Parameters

- <char> Choose from:
 - PRIMary** - Used for calibrating at the mmWave frequencies when NOT using a test set. [Learn more.](#)
 - AUTO** - All other calibration situations.

Examples

```
SENS:CORR:PREF:CAL:RANG PRIM  
sense:correction:preference:calibration:fom:range auto
```

Query Syntax SENSe:CORRection:PREFeRence:CALibration[:FOM]:RANGe?

Return Type Character

Default AUTO

SENSe:CORRection:PREFeRence:CSET:SAVE <char>

Applicable Models: All

Important Notes:

- This command replaces **SENS:CORR:PREF:CSET:SAVU**
- With 6.0 we implemented a change that defaults to saving completed calibrations to Cal Registers instead of User Cal Sets. To revert to the old behavior, send this command with the USER argument.

(Read-Write) Specifies the default manner in which calibrations that are performed using SCPI or COM are to be stored. Cal data is ALWAYS stored to the channel Cal Register regardless of this setting.

This setting survives instrument preset and reboot. It remains until changed by another execution of this command.

Note: Cal Set arguments used with commands such as **SENS:CORR:COLL:GUID:INIT**, **SENS:CORR:COLL:GUID:SAVE** and **SENS:CORR:COLL:GUID:SAVE:CSET** will override of any of these default preference settings.

Learn about [Cal Registers and User Cal Sets](#).

Parameters

<char> **CALRegister** - Each Cal is saved ONLY to the channel Cal Register. If the error terms from a new Cal can co-exist with those in the Cal Register, they are appended.

USER - Each Cal is saved to its own new User Cal Set file. The Cal Set name is automatically generated. To change the name, send **SENS:CORR:CSET:NAME** after the cal is complete. This reverts to pre-6.0 behavior.

REUSE - The cal is saved to the Cal Set that is currently selected on the specified channel, which could be the channel Cal Register. If the channel does not yet have a selected Cal Set, the cal will be saved to a new User Cal Set with an automatically-generated name. If the error terms from a new Cal can co-exist with those in the Cal Set, they are appended.

Examples

```
SENS:CORR:PREF:CSET:SAVE USER  
sense:correction:preference:cset:save reuse
```

Query Syntax SENSE:CORRection:PREFErence:CSET:SAVE?

Return Type Character

Default CALRegister

SENSe:CORRection:PREFeRence:CSET:SAVUser <bool> **Superseded**

Applicable Models: N522xB, N523xB, N524xB, M9485A

This command is replaced with **SENS:CORR:PREF:CSET:SAVE**

NOTE: With 6.0 we implemented a change that defaults to saving completed calibrations to Cal Registers instead of User Cal Sets. To revert to the old behavior, send this command as ON (1). For UI and COM use, this can be done from the **GPIB console**.

(Read-Write) Specifies whether cal data is automatically saved to a User Cal Set file after performing a SCPI calibration. Cal data is always saved to a Cal Register regardless of this setting.

This setting survives instrument preset and reboot. It remains until changed by another execution of this command.

Learn about **Cal Registers and User Cal Sets**.

Parameters

<bool> **ON** or **1** - Cal is automatically saved to a User Cal Set file when performing a SCPI calibration. The Cal Set name is automatically generated. To change the name, send **SENS:CORR:CSET:NAME** after the cal is complete. Reverts to pre-6.0 behavior.

OFF or **0** - Cal is NOT automatically saved to a User Cal Set. To save a calibration to a User Cal Set, use **SENS:CORR:COLL:GUID:INIT**.

Examples

```
SENS:CORR:PREF:CSET:SAVU 1  
sense:correction:preference:cset:savuser 0
```

Query Syntax SENSe:CORRection:PREFeRence:CSET:SAVUser?

Return Type Boolean (1 = ON, 0 = OFF)

Default OFF (0)

SENSe:CORRection:PREFeRence:ECAL:ORlentation[:STATe] <ON|OFF>

Applicable Models: All

(Read-Write) Specifies whether or not the VNA should perform orientation of the ECal module during calibration. Orientation is a technique by which the VNA automatically determines which ports of the module are connected to which ports of the VNA. Orientation begins to fail at very low power levels or if there is much attenuation in the path between the VNA and the ECal module. If orientation is turned OFF, the **SENS:CORR:PREF:ECAL:PMAP** command must be used to specify the port connections before performing a cal.

Note: For 3-port or 4-port measurements, when orientation is OFF, you are not allowed to specify how the ECAL module is connected. Instead, the VNA determines the orientation. Use **SENS:CORR:COLL:GUID:DESC?** to query the orientation. The VNA does not verify that you made the connection properly.

This setting remains until the VNA is restarted or this command is sent again.

Parameters

<bool> ECAL orientation state. Choose from:

ON or **1** - VNA performs orientation of the ECal module.

OFF or **0** - VNA does NOT performs orientation of the ECal module.

Examples

```
SENS:CORR:PREF:ECAL:ORI OFF
```

```
sense:correction:preference:ecal:orientation:state on
```

Query Syntax SENSE:CORRection:PREFErence:ECAL:ORientation[:STATe]?

Return Type Boolean (1 = ON, 0 = OFF)

Default ON (1)

SENSe:CORRection:PREFErence:ECAL:OVERrange[:STATe] <ON|OFF>

Applicable Models: All

(Read-Write) Sets and returns the ECAL over range state.

Parameters

<bool> ECAL over range state. Choose from:

ON or **1** - Enable ECAL over range.

OFF or **0** - Disable ECAL over range.

Examples

```
SENS:CORR:PREF:ECAL:OVER OFF
```

```
sense:correction:preference:ecal:overrange:state on
```

Query Syntax SENSE:CORRection:PREFErence:ECAL:OVERrange[:STATE]?

Return Type Boolean (1 = ON, 0 = OFF)

Default ON (1)

SENSe:CORRection:PREFErence:ECAL:PMAP <module>,<string>

Applicable Models: All

(Read-Write) When ECAL module orientation is turned OFF (**SENS:CORR:PREF:ECAL:ORI**), this command specifies the port mapping (which ports of the module are connected to which ports of the VNA) prior to performing ECAL calibrations.

This setting remains until the VNA is restarted or this command is sent again.

Parameters

<module> Specifies which ECAL module this port map is being applied to. Choose from:

ECAL1

.through.

ECAL50

<string> Format this parameter in the following manner:

Aw,Bx,Cy,Dz

where

- A, B, C, and D are literal ports on the ECAL module

- w,x,y, and z are substituted for VNA port numbers to which the ECAL module port is connected.

Ports of the module which are not used are omitted from the string.

For example, on a 4-port ECal module with

port A connected to VNA port 2

port B connected to VNA port 3

port C not connected

port D connected to VNA port 1

the string would be: A2,B3,D1

If either the receive port or source port (or load port for 2-port cal) of the CALC:PAR:SElEcted measurement is not in this string and orientation is OFF, an attempt to perform an ECal calibration will fail.

Examples

```
SENS:CORR:PREF:ECAL:PMAP ECAL2, 'A1,B2'
sense:correction:preference:ecal:pmap ecal3, 'a2,b1,c3'
```

Query Syntax SENSE:CORRection:PREFErence:ECAL:PMAP? <module>

Return Type String

Default Null string ()

SENSE:CORRection:PREFErence:SIMCal <bool> **Obsolete**

This command is no longer supported. [Learn more about old and new behaviors.](#)

(Read-Write) Sets and returns a preference for the Unguided Cal behavior described below. This setting persists until it is changed.

This preference can also be set ON by executing the script on the VNA at C:/Program Files/Keysight/Network Analyzer/System/wincal32.reg.

Parameters

<bool> Boolean - Choose from:

0 - OFF - Reverts to new (preferred) behavior. An error is returned if standard data is not acquired before sending **SENS:CORR:COLL:SAVE**.

1 - ON - (WinCal compatible) Prevents **SENS:CORR:COLL:SAVE** from failing when standard data has not, and will not, be acquired.

Examples

```
SENS:CORR:PREF:SIMC 0
```

```
sense:correction:preference:simcal 1
```

Query Syntax

```
SENSe:CORRection:PREFErence:SIMCal?
```

Return Type

Boolean

Default

0

SENSe:CORRection:PREFErence:TRIG:FREE <char>, <bool>

Applicable Models: All

(Read-Write) Sets and returns the preference for the trigger behavior during a calibration. This setting persists until it is changed.

Note: If **TRIGger:SOURce** = Manual, during a calibration the VNA ALWAYS switches to Internal for one trigger, then back to Manual, regardless of this preference command.

Parameters

<char> Character - Calibration type. Choose from:

GUIDed - preference setting pertains to a Guided calibration.

UNGuided - preference setting pertains to an Unguided calibration.

<bool> Boolean - Choose from:

0 - OFF - The trigger behavior during the specified calibration type DOES respect the setting of the **TRIGger:SOURce** command. For example, when Trigger source = External, the single trigger method will wait for the External trigger signal and then allow only one sweep.

1 - ON - (Pre-6.0 behavior) The trigger behavior during the specified calibration type does NOT respect the setting of the **TRIGger:SOURce** command. For example, when Trigger source = External, during calibration the VNA switches to Internal sweep, responds to one trigger signal to measure the standard, then switches back to External.

Examples

```
SENS:CORR:PREF:TRIG:FREE GUID,1
```

```
sense:correction:preference:trig:free unguided,0
```

Query Syntax

```
SENSe:CORRection:PREFErence:TRIG:FREE? <char>
```

Return Type

Boolean

Default

OFF for both calibration types.

SENSe<cnum>:CORRection:RPOWer:OFFSet[:AMPLitude] <num>**Applicable Models:** All

(Read-Write) Adjusts a receiver power cal to account for components or adapters that are added between the source port and receiver while performing this cal. For more information, see [Receiver Cal](#).

Parameters

- <cnum> Any existing channel number. If unspecified, value is set to 1
- <num> Offset Value in dB. Specify loss as a negative number; and gain as a positive number. Choose a number between -200 and 200.

Examples

```
SENS:CORR:RPOW:OFFS .5  
sense2:correction:rpower:offset:amplitude .-5
```

Query Syntax SENSe<cnum>:CORRection:RPOWer:OFFSet[:AMPLitude]?

Return Type Numeric

Default 0

SENSe<cnum>:CORRection:RVELocity:COAX <num>**Applicable Models:** All

(Read-Write) Sets the velocity factor to be used with Electrical Delay and Port Extensions.

Parameters

- <cnum> Any existing channel number. If unspecified, value is set to 1
- <num> Velocity factor. Choose a number between **0** and **10**
(.66 polyethylene dielectric; .7 PTFE dielectric)

Examples

```
SENS:CORR:RVEL:COAX .66  
sense2:correction:rvelocity:coax .70
```

Query Syntax SENSe<cnum>:CORRection:RVELocity:COAX?

Return Type Numeric

Default 1

SENSe<cnum>:CORRection:SFORward[:STATe] <boolean>

Applicable Models: All

(Read-Write) Sets the direction a calibration will be performed when only one set of standards is used.

Use **SENSe:CORRection:TStandards[:STATe]** **OFF** to specify that only one set of standards will be used.

Parameters

- <cnun> Any existing channel number. If unspecified, value is set to 1
- <boolean> **ON (1)** - FORWARD direction of a 2-port calibration will be performed
OFF (0) - REVERSE direction of a 2-port calibration will be performed

Examples

```
SENS:CORR:SFOR 1
sense2:correction:sforward:state 0

See an example using this command
```

Query Syntax SENSe<cnun>:CORRection:SFORward[:STATe]?

Return Type Boolean

Default ON

SENSe<cnun>:CORRection[:STATe] <ON | OFF>

Applicable Models: All

(Read-Write) Turns error correction ON and OFF for the specified channel.

Note: Before using this command you must select a measurement using **CALCulate:MEASure:PARAmeter**. You can select one measurement for each channel.

Parameters

- <cnun> Any existing channel number. If unspecified, value is set to 1
- <ON | OFF> **ON** (or 1) - correction is applied to the channel.
OFF (or 0) - correction is NOT applied to the channel.

Examples

```
SENS:CORR ON
sense2:correction:state off
```

Query Syntax SENSe<cnun>:CORRection[:STATe]?

To query the error correction state for a measurement, use **CALC:MEAS:CORR:STATe?**

Return Type Boolean (1 = ON, 0 = OFF)

Default OFF

SENSe<cnum>:CORRection:TCOLd:USER:VALue <num>

Applicable Models: All

(Read-Write) Sets and returns the temperature of the noise source connector. Learn more about [Noise Figure Calibration](#).

Parameters

<cnum> Any existing channel number. If unspecified, value is set to 1.

<num> Noise source temperature in Kelvin.

Examples

```
SENS:CORR:TCOL:USER:VAL 295
```

```
sense2:correction:tcold:user:value 298
```

See an [example](#) using this command

Query Syntax SENSe<cnum>:CORRection:TCOLd:USER:VALue?

Return Type Numeric

Default Not Applicable

SENSe<cnum>:CORRection:TSTandards[:STATe] <boolean>

Applicable Models: All

(Read-Write) Specifies the acquisition of calibration data using ONE or TWO sets of standards.

Parameters

<cnum> Any existing channel number. If unspecified, value is set to 1.

<boolean> **ON (1)** - TWO identical sets of standards will be used to simultaneously calibrate two ports (for both Forward and Reverse parameters).

OFF (0)- ONE set of standards will be used to perform a full 2-port calibration, one port at a time.

When specifying ON (use two sets), the **SENS:CORR:COLL:ACQuire** command uses the same standard index for each calibration class. To specify the calibration standard gender for each port, you must first ensure that the order of calibration class accurately reflects the configuration of your DUT. For example, for a DUT with a male connector on port 1 and a female connector on port 2, order the devices within the S11 classes (A, B, and C) such that the MALE standards are first in the list. Then order the S22 classes specifying the

FEMALE standards as the first in the list.

Examples

```
SENS:CORR:TST 1
sense2:correction:tstandard:state 0

See an example using this command
```

Query Syntax SENSE<cnum>:CORRection:TSTandards[:STATe]?

Return Type Boolean

Default ON

SENSe:CORRection:TYPE:CATalog? <char>

Applicable Models: All

(Read-Write) Lists the Cal Types in the VNA by either GUID or registered name. [Learn more about applying Cal Type using SCPI.](#)

Note: Before using this command you must select a measurement using [CALCulate:MEASure:PARAmeter](#). You can select one measurement for each channel.

Parameters

<char> Specifies the type of list. Choose from:

GUID - the registered GUID of the Cal Type

NAME - the registered name of the Cal Type

Examples

```
SENS:CORR:TYPE:CAT? GUID
```

Query Syntax SENSe<cnum>:CORRection:TYPE:CATalog? <char>

Return Type Comma-separated string

Default Not Applicable

SENSe<cnum>:CORRection:WAVE[:METHod] <param>

Applicable Models: N522xB, N523xB, N524xB

(Write-Read) Sets and returns the wave correction method.

Parameters

<num> Any existing channel number. If unspecified, value is set to 1.

<parm> Wave correction method. Choose from:

ACTual - Full error corrected actual waves at DUT plane.

MATCh – Matched corrected waves at DUT plane.

RESPonse - Response corrected wave at DUT plane.

Examples

```
SENS1:CORR:WAVE ACT
```

Query Syntax SENSE<num>:CORR:WAVE[:METHod]?

Return Type String

Default MATCh

Sense:Correction:CKIT Commands

Manages the list of cal kits that are installed in the VNA.

```
SENSe:CORR:CKIT

CLEar
COUNT?

ECAL
  | CHARacterize More commands
  | CLISt?
  | DMEMory
    | CLEar
    | IMPort
  | EXPort
  | INFormation
  | KNAME
    | INFormation
  | LIST?
  | ORlent?
  | PATH
    | COUNT?
    | DATA?

EXPort
IMPOrt
INITialize
LOAD
```

- Click on a red keyword to view the command details.
- Red is a superseded command

- [New See Calibrating the VNA Using SCPI](#)
- [Learn about Modifying Cal Kits](#)
- [Synchronizing the Analyzer and Controller](#)
- [SCPI Command Tree](#)

SENSe:CORRection:CKIT:CLEar[:IMMediate] [ckit]

Applicable Models: All

(Write-only) Deletes installed cal kits.

Parameters

[ckit] Optional String. Cal Kit to delete. If not specified, all VNA Cal kits are deleted, including custom kits.

Examples

```
SENS:CORR:CKIT:CLE
```

```
sense:correction:ckit:clear:immediate "85052B"
```

Query Syntax Not Applicable

Default Not Applicable

SENSe:CORRection:CKIT:COUNT?

Applicable Models: All

(Read-only) Returns the number of installed cal kits.

Examples

```
SENS:CORR:CKIT:COUNT?
```

Query Syntax SENS:CORR:CKIT:COUNT?

Return Type Numeric

Default Not Applicable

SENSe:CORRection:CKIT:ECAL<mod>:CLISt?

Applicable Models: All

(Read-only) Returns a list of characterizations stored in the specified ECal module.

Parameters

<mod> ECal module from which to read user characterization numbers. Choose from 1 to 50. If unspecified, value is set to 1.

Examples

```
Module 1 contains User Characterizations 1 and 3.  
  
SENSe:CORRection:CKIT:ECAL:CLIST?  
  
'Returns the following (0 always indicates the factory  
characterization):  
  
0,1,3
```

Return Type Numeric list, separated by commas.

Default Not Applicable

SENSe:CORRection:CKIT:ECAL:DMEMory:CLEar <kitName>

Applicable Models: All

(Write-only) Deletes user characterizations from VNA disk memory.

Parameters

<kitName> Optional String argument. ECal Model, User Characterization name + " ECal", and serial number of the ECal module, separated by spaces. See examples below.

If unspecified, ALL User Characterizations that are stored in VNA disk memory are deleted.

Examples

```
'These examples all use "MyUserChar" as the User  
characterization name.  
  
'The "My User Char" characterization is deleted from disk  
memory.  
  
SENS:CORR:CKIT:ECAL:DMEM:CLE "N4433A MyUserChar ECal 00001"  
  
'All User characterizations are deleted from disk memory.  
  
SENS:CORR:CKIT:ECAL:DMEM:CLE
```

Query Syntax Not Applicable

Default Not Applicable

SENSe:CORRection:CKIT:ECAL:DMEMory:IMPort <file>

Applicable Models: All

(Write-only) After the VNA disk memory is **Exported** to a file, use this command to Import the file into VNA disk memory, which allows the User Characterization to be used with the VNA and ECal module.

Note: An ECal confidence check can NOT be performed remotely from User Characterizations that are stored on the VNA disk.

Parameters

<file> String. Full path and file name of file that was exported.

Examples

```
SENS:CORR:CKIT:ECAL:DMEM:IMP "D:\myDiskUserChar.euc"
```

Query Syntax Not Applicable

Default Not Applicable

SENSe:CORRection:CKIT:ECAL:EXPort <kit>[,<file>][,<NewName>]]

Applicable Models: All

(Write-only) Saves an existing ECal characterization to a file. Use this command to archive the user characterization or to move the characterization to a different VNA for use with the specified ECal module. After exporting the user characterization, use **SENS:CORR:CKIT:ECAL:DMEM:IMPort** to make the user characterization available for use.

Parameters

<kit> String. Not case sensitive. ECal Model, User char name + " ECal", and serial number of the ECal module used for the characterization, separated by spaces. See examples below.

If the model and serial number of the module is not found, an error is returned.

[<file>] Optional String argument. Path and filename of the user characterization. If not specified, the file is saved using characterization name + ".euc". If the path is not specified, it is stored in C:/Program Files/Keysight/Network Analyzer/ECal User Characterizations/. The extension ".euc" is appended if one is not specified.

[<NewName>] Optional String argument. This allows you to change the name for the User Characterization. When specified, the new name is saved in the file with the characterization. If unspecified, the existing user characterization name is

saved.

Note: If this argument is specified, the second argument (<file>) must also be specified.

Examples

'These examples all use "MyUserChar" as the User characterization name.

'All parameters specified

```
SENS:CORR:CKIT:ECAL:EXP "N4433A MyUserChar ECal  
00001", "myUserChar.euc", "NewUserChar"
```

'First two parameters are specified

```
sense:correction:ckit:ecal:export "N4691B MyUserChar ECal  
00500", "myUserChar.euc"
```

'Only first parameter is specified

```
SENS:CORR:CKIT:ECAL:EXP "N4433A MyUserChar ECal 00001"
```

Query Syntax Not Applicable

Default Not Applicable

SENSe:CORRection:CKIT:ECAL<mod>:INFormation? [<char>]

Applicable Models: All

(Read-only) Reads the identification and characterization information from the specified ECal module.

Note: To read user-characterization information that is stored in VNA disk memory, then use **SENSe:CORRection:CKIT:ECAL:KNAM:INF?**

Parameters

<mod> ECal module from which to read characterizations. Choose from 1 through 50. If unspecified, value is set to 1.

Do NOT assume the <mod> number is the order in which ECal modules were connected.

Use **SENSe:CORRection:CKIT:ECAL:LIST?** to read a list of <mod> numbers of currently-attached ECal modules.

<char> Optional argument. Specifies which characterization to read information from. If not specified, value is set to CHAR0.

Choose from:

- CHAR0 Factory characterization (data that was stored in the ECal module by Keysight)
- CHAR1 User characterization #1
- CHAR2 User characterization #2
- - through -
- CHAR12 User characterization #12

Examples

```
SENS:CORR:CKIT:ECAL2:INformation? char5
```

'Example return string:

```
"ModelNumber: 85092-60007, SerialNumber: 01386, ConnectorType: N5FN5F, PortAConnector: Type N (50) female, PortBConnector: Type N (50) female, MinFreq: 30000, MaxFreq: 9100000000, NumberOfPoints: 250, Calibrated: July 4 2002"
```

Return Type Character

Default Not Applicable

SENSe:CORRection:CKIT:ECAL:KNAME:INformation? <kitName>

Applicable Models: All

(Read-only) Reads the identification and characterization information from the specified ECal module or VNA disk memory.

[Learn more about User Characterization in VNA Disk Memory.](#)

Parameters

<kitName> String. ECal model and characterization to read information from, enclosed in quotes, in the following format:

<model> <name> **ECal** <serial number>

Where:

<model>: Always required

<name>:

- For the factory characterization, do not specify.

- For a user-characterization stored in the module, use **User <n>** in the string, where <n> is the user-characterization number. Not case sensitive. Separate User and <n> with a space.
- For a user-characterization stored in VNA disk memory, use <charName> from **SENS:CORR:CKIT:ECAL:CHAR:DMEM:SAVE <charName>**

ECal - not case sensitive

<serial number>: Optional. Include when two or more ECal modules with same model number are attached to the VNA,

Each item is separated with a space.

Examples

```
'For a factory characterization in module memory:
SENS:CORR:CKIT:ECAL:KNAM:INF? "N4433A ECal"

'For user characterization in module memory with optional serial
number:
SENS:CORR:CKIT:ECAL:KNAM:INF? "N4433A User 1 ECal 00028"

'For user characterization "foo" in disk memory:
SENS:CORR:CKIT:ECAL:KNAM:INF? "N4433A foo ECal 00028"

'Example return string:

"ModelNumber: N4433A, SerialNumber: 00028, ConnectorType:
N5FN5F, PortAConnector: Type N (50) female, PortBConnector: Type
N (50) female, MinFreq: 30000, MaxFreq: 9100000000,
NumberOfPoints: 250, Calibrated: July 4 2002"
```

Return Type String

Default Not Applicable

SENSe:CORRection:CKIT:ECAL:LIST?

Applicable Models: All

(Read-only) Returns a list of index numbers for ECal modules that are currently attached to the VNA. Use these numbers (called <mod> in VNAHelp) to refer to the ECal module using SCPI commands.

Examples

```
SENS:CORR:CKIT:ECAL:LIST?
```

```
'If 2 modules are attached to the VNA  
'then the returned list will be:
```

```
+1,+2
```

```
'If NO modules are attached to the VNA  
'then the returned list will be:
```

```
+0
```

See example program using this command.

Return Type Numeric list, separated by commas.

Default Not Applicable

SENSe<ch>:CORRection:CKIT:ECAL<n>:ORient? <pnaPort>[,<charN>]

Applicable Models: All

(Read-only) Returns the ECal port that is connected to the specified VNA port. A calibration does not have to be in process.

<ch> Channel number that contains the frequency range to be calibrated.

<n> ECal module number. Choose from 1 through 50.

If unspecified (only one ECal module is connected to the USB), <n> is set to 1.

If two or more modules are connected, use **SENS:CORR:CKIT:ECAL:LIST?** to determine how many, and **SENS:CORR:CKIT:ECAL:INF?** to verify their identities.

<pnaPort> VNA port number.

<charN> Optional argument. If unspecified, factory data (CHAR0) is used. User Characterization number that matches the physical adapters/fixtures that are on the ECal module. This aids in determining the orientation of the ECal module.

Choose from:

- **CHAR0** Factory characterization (data that was stored in the ECal module by Keysight)
- **CHAR1** User characterization #1

- **CHAR2** User characterization #2

and so forth up to:

- **CHAR12** User characterization #12

Beginning with A.08.33, up to 12 User Characterizations can be stored in a single ECal module. Previous releases allowed up to 5. [Learn more.](#)

Examples

```
SENS1:CORR:CKIT:ECAL1:ORI? 2
```

```
sense2:correction:ckit,ecall1:orient? 2, char2
```

Return Type

The returned ECal port number is a 1-based number: 1 = Port A, 2 = Port B, 3 = Port C, 4 = Port D.

Zero (0) is returned when the auto-orientation routine is unable to resolve the orientation.

Default Not Applicable

SENSe:CORRection:CKIT:ECAL<n>:PATH:COUNT? <path>

Applicable Models: All

(Read-only) Returns the number of unique states that exist for the specified path name on the selected ECal module.

This command performs exactly the same function as **CONT:ECAL:MOD:PATH:COUNT?**

Use the **CONT:ECAL:MOD:PATH:STAT** command to set the module into one of those states.

Use **SENS:CORR:CKIT:ECAL:PATH:DATA?** to read the data for a state.

Parameters

<n> USB number of the ECal module. Choose from 1 to 50.

If unspecified (only one ECal module is connected to the USB), <n> is set to 1. If two or more modules are connected, use **SENS:CORR:CKIT:ECAL:LIST?** to determine how many, and **SENS:CORR:CKIT:ECAL:INF?** to verify their identities.

<path> Name of the path for which to read number of states. Choose from:

Reflection paths

- **A**

- **B**
- **C** (4-port modules)
- **D** (4-port modules)

Transmission paths

- **AB**
- **AC** (4-port modules)
- **AD** (4-port modules)
- **BC** (4-port modules)
- **BD** (4-port modules)
- **CD** (4-port modules)

Examples

```
CONT:ECAL:MOD:PATH:COUNT?
control:ecal:module2:path:count?
```

Return Type Integer

Default Not Applicable

SENSE<ch>:CORRection:CKIT:ECAL<num>:PATH:DATA? <path>, <stateNum>[,<char>]

Applicable Models: All

(Read-only) Returns the data for a state from the memory of the selected ECal module. The returned data is interpolated if necessary to have the same stimulus values as the specified channel <ch>.

- For a reflection path state, the data is reflection S-parameter data. The number of values equals the number of stimulus points on the channel multiplied by 2 (because they are complex numbers).
- For a transmission path state, the data is all 4 S-parameters of the state. The number of values returned is 4 times that of a reflection state.

The data is returned in the same format as **CALC:MEAS:DATA:SNP?**

Note: This command returns SNP data without header information, and in columns, not in rows as .SnP files. This means that the data returned from this command sends all frequency data, then all Sx1 magnitude or real data, then all Sx1 phase or imaginary data, and so forth.

Parameters

<ch> Any existing channel number. If unspecified, value is set to 1.

<num> Optional argument. USB number of the ECal module. Choose from 1 through 50.

If unspecified (only one ECal module is connected to the USB), <num> is set to 1. If two or more modules are connected, use **SENS:CORR:CKIT:ECAL:LIST?** to determine how many, and **SENS:CORR:CKIT:ECAL:INF?** to verify their identities.

<path> Name of the path for which to read number of states. Choose from:

Reflection paths

- **A**
- **B**
- **C** (4-port modules)
- **D** (4-port modules)

Transmission paths

- **AB**
- **AC** (4-port modules)
- **AD** (4-port modules)
- **BC** (4-port modules)
- **BD** (4-port modules)
- **CD** (4-port modules)

<stateNum> Number of the state to set. Refer to the following table to associate the <stateNum> with a state in your ECal module.

In addition, **CONT:ECAL:MOD:PATH:COUNT?** returns the number of states in the specified ECal module.

<stateNum>	N4432A and N4433A States	N4431A States	N469x and N755x States**	8509x States
One-Port Reflection States				
1	Open	Open	Impedance 1	Open
2	Short	Short	Impedance 2	Short
3	Impedance 1	Impedance 1	Impedance 3	Impedance 1
4	Impedance 2	Impedance 2	Impedance 4	Impedance 2
5			Impedance 5	
6			Impedance 6	
7			Impedance 7	
Two-Port Transmission States				
1	Thru	Thru	Thru	Thru
2	Confidence	Confidence	Confidence	Confidence

** The following modules have only FOUR Impedance states (1, 2, 3, 4):
N4690B ,N4691B ,N4692A ,N4696B, N7550A - N7556A.

<char> Optional argument. Specifies which characterization within the ECal module to read information from. If not specified, value is set to CHAR0.

Choose from:

- **CHAR0** Factory characterization (data that was stored in the ECal module by Keysight)
 - **CHAR1** User characterization #1
 - **CHAR2** User characterization #2
- and so forth up to:
- **CHAR12** User characterization #12

Examples `SENS:CORR:CKIT:ECAL1:PATH:DATA? A,1`

Return Type S1P or S2P

Default Not Applicable

SENSe:CORRection:CKIT:EXPort <kit>[,<file>]

Applicable Models: All

(Write-only) Saves an existing cal kit definitions to a file. Use this command to archive or move a user-defined or modified cal kit to a different VNA. After exporting the cal kit, use **SENS:CORR:CKIT:IMPort** to make the cal kit available for use on the VNA. This command provides the same behavior as the Installed Kits - Save As button on the **Edit VNA Cal Kits** dialog.

Parameters

- <kit>** String. Not case sensitive. Name of the cal kit to export, as seen in the Cal Kits field of the **Select DUT Connectors and Cal Kits** dialog of a SMART Cal.
- <file>** Optional String argument. Path and filename to where the Cal Kit file is to be saved. If not specified, the file is saved using **<kit> + ".ckt"**. If the path is not specified, it is stored in **C:/Program Files/Keysight/Network Analyzer/PNACalKits/User**.

Examples

```
'File unspecified
SENS:CORR:CKIT:EXP "MyCalKit"

'Both parameters are specified
sense:correction:ckit:export "MyCalKit","C:/myBackupCalKit.ckt"
```

Query Syntax Not Applicable

Default Not Applicable

SENSe:CORRection:CKIT:IMPort <string>

Applicable Models: All

(Write-only) Imports the specified cal kit (.ckt file) and appends the imported kit to the end of the list of kits.

Note: Although there is no limit to the number of cal kits that can be imported, during an **Unguided cal**, you can access ONLY mechanical cal kits #1 through #95.

Parameters

<string> Path and cal kit name.

Examples

```
SENSe:CORRection:CKIT:IMPort "c:\users\public\network  
analyzer\documents\85033D.ckt"
```

Query Syntax Not Applicable

Default Not Applicable

SENSe:CORRection:CKIT:INITialize[:IMMediate] [ckit]

Applicable Models: All

(Write-only) Restores default factory installed cal kits. This command also selects kit number 1, as you would using **SENS:CORR:COLL:CKIT:SEL 1**. Therefore, if you intend to work with a Cal Kit remotely, select the Cal Kit **AFTER** sending this command.

Note: This command can also delete all existing User-defined Cal Kits. However, if saved using Save As, these kits can be restored in the same manner as after a VNA firmware upgrade. [Learn more about saving modified Cal Kits.](#)

Parameters

[ckit] Optional String. Cal Kit to restore. If not specified, all VNA factory Cal kits are restored.

Examples

```
SENS:CORR:CKIT:INITialize  
sense:correction:ckit:initialize:immediate "85052B"
```

Query Syntax Not Applicable

Default Not Applicable

SENSe:CORRection:CKIT:LOAD <string>

Applicable Models: All

(Write-only) Loads the specified collection of cal kits from a .wks file. You can make your own collection of cal kits from the **Advanced Modify Cal Kit** menu.

Parameters

<string> Path and file name of the cal kit collection.

Examples

```
sense:correction:ckit:load "C:/Program Files/Keysight/Network Analyzer/PnaCalKits/factory/wMyCalKits.wks"
```

Query Syntax Not Applicable

Default Not Applicable

Sense:Correction:Collect:Ckit Commands

Use to change the definitions of calibration kit standards.

SENSe:CORRection:COLLect:CKIT:

| **CATalog?**

| **CONNector**

| **ADD**

| **CATalog?**

| **DELeTe**

| **FNAME**

| **SNAME**

| **DESCription**

| **INFormation?**

| **NAME**

| **OLAB**

| **OLISt?**

| **ORDer**

| **PORT[:SElect]**

| **RESet**

| **SElect**

| **STANdard**

| **CO, C1, C2, C3**

| **CHARacter**

| **DELay**

| **FMAXimum**

| **FMINimum**

| **IMPedance**

| **LO, L1, L2, L3**

| **LABel**
| **LOSS**
| **REMove**
| **SDEscription**
| **[SElect]**
| **TYPE**
| **TZReal**
| **TZImag**
| **TRLoption**
| **IMPedance**
| **LRLChar**
| **RPLane**

Click on a keyword to view the command details.

Blue keywords are superseded commands.

Most of these commands act on the currently selected standard from the currently selected calibration kit.

- To select a Calibration kit, use **SENS:CORR:COLL:CKIT:SEL**.
- To select a Calibration standard, use **SENS:CORR:COLL:CKIT:STAN:SEL**
- See an **example** program that **CREATES a New Cal Kit**
- See an **example** program that **MODIFIES an Existing Cal Kit**
- **Learn about Modifying Cal Kits**
- **Synchronizing the Analyzer and Controller**
- **SCPI Command Tree**

Note: You should provide data for every definition field - for every standard in your calibration kit. If a field is not set, the default value may not be what you expect.

For more information, read **Specifying Calibration Standards and Kits for Keysight Vector Network Analyzers**

SENSe:CORRection:COLLect:CKIT:CATalog?

Applicable Models: All

(Read-only) Returns the names of the first 95 mechanical cal kits in your VNA that can be used for unguided calibrations.

Examples `SENS:CORR:COLL:CKIT:CAT?`

Return Type A comma-separated string

Default Not Applicable

SENSe:CORRection:COLLect:CKIT:CONNector:ADD <family>,<start>,<stop>,<z0>,<gender>,<media>,<cutoff>

Applicable Models: All

(Write only) Creates a new connector. The connector is automatically added to the list of available connectors for the currently selected cal kit. If a connector includes both male and female connectors, each connector must be added separately.

Parameters

<family> (String) Name of connector family. Limited to 50 characters.

<start> Start frequency

<stop> Stop frequency

<z0> Characteristic Impedance of the connector in ohms.

<gender> Connector gender. Choose from:

MALE

FEMALE

NONE

<media> Media of the connector. Choose from:

COAX - coaxial

WAVE - waveguide

<cutoff> Cutoff frequency of the connector (waveguide only).

Examples `SENS:CORR:COLL:CKIT:CONN:ADD "PSC 1.8 mm",0 HZ,999.9
GHZ,50,FEMALE,COAX,0.0
SENS:CORR:COLL:CKIT:CONN:ADD "PSC 1.8 mm",0 HZ,999.9
GHZ,50,MALE,COAX,0.0`

Query Syntax Not applicable

Default Not Applicable

SENSe:CORRection:COLLect:CKIT:CONNector:CATalog?

Applicable Models: All

(Read-only) Returns a comma-separated list of all connectors defined within the currently selected cal kit. The returned string includes the connector family name followed by the connector gender, if any. Kits may include a primary connector family name and additional connector family names.

Connector family names are case sensitive. A connector family named "PSC 2.4" is different from a connector family named "psc 2.4".

Learn more about [Connector Family Name](#).

Examples

```
SENS:CORR:COLL:CKIT:CONN:CAT?
```

```
'Returned string
```

```
"Type-N (50) male, Type-N (50) female"
```

Default Not Applicable

SENSe:CORRection:COLLect:CKIT:CONNector:DELeTe

Applicable Models: All

(Write-only) Deletes the primary connector family name from the selected kit. The VNA allows multiple connector families for each kit. If a kit includes multiple connector families, only the first listed (primary) connector family name is deleted.

Once the connector family is deleted, the connector may not be assigned to any new or existing standard within the kit.

The previously defined standards retain their association to the deleted connector name. To reassign standards to a new connector family name, use [SENS:CORR:COLL:CKIT:CONN:SNAME](#).

Examples

```
SENS:CORR:COLL:CKIT:CONN:DEL
```

Query Syntax Not Applicable

Default Not Applicable

SENSe:CORRection:COLLect:CKIT:CONNector:FNAME <name>

Applicable Models: All

(Read-Write) Replaces the primary connector family name from the selected kit with a new connector family name. The connector family name is replaced in all standards in the kit that share that name. The VNA allows multiple connector families for each kit. If a kit includes multiple connector families, only the first listed (primary) connector family name is replaced. Use the query form of this command to return the name of the primary connector family.

Parameters

<name> New connector family name. Limited to 50 characters.

Examples

```
SENS:CORR:COLL:CKIT:CONN:FNAME 'MYPSC35'  
Sense:correction:collect:ckit:connector:name 'My Type N'
```

Query Syntax SENSE:CORRection:COLLEct:CKIT:CONNector:FNAME?

Return Type String

Default Not Applicable

SENSe:CORRection:COLLEct:CKIT:CONNector:SNAME <family>,<gender>,<port>

Applicable Models: All

(Read-Write) Assigns a family name to the currently selected standard from the currently selected kit. Specify each port of a 2-port standard individually. Use the query form of this command to read the connector family name assigned to the current standard. The name is not assigned unless the connector family name is previously defined within the selected kit.

Parameters

<family> String. Connector family name.

<gender> Connector gender. Choose from:
MALE
FEMALE
NONE

<port> Number of the connector port to be assigned the connector family name. 2-port standards such as a thru line must be assigned separately. It is not relevant which connector is port 1 or port 2.

- 1** Specifies a 1-port standard or the first port of a 2-port standard.
- 2** Specifies the second port of a 2-port standard.

Examples

```
SENS:CORR:COLL:CKIT:CONN:SNAME "Type-N (50)",MALE,1
```

Query Syntax	SENSe:CORRection:COLLect:CKIT:CONNector:SNAME?
Return Type	String
Default	Not Applicable

SENSe:CORRection:COLLect:CKIT:DESCription <string>

Applicable Models: All

(Read-Write) Modifies the cal kit description field of the selected kit. This description appears in the [Edit VNA Cal Kit dialog box](#).

Parameters

<string> Description of the cal kit. Limited to 50 characters.

Examples `SENSe:CORR:COLL:CKIT:DESC "My New CalKit"`

Query Syntax SENSe:CORRection:COLLect:CKIT:DESCription?

Return Type String

Default Not Applicable

SENSe:CORRection:COLLect:CKIT:INFOrmation? <module>[,char]

Applicable Models: All

(Read Only) Reads characterization information from an ECal module.

Parameters

<module> Specifies which ECal module to read from. Choose from:

ECAL1

.through.

ECAL50

[char] Optional argument.

Specifies which characterization within the ECal module to read information from. If this argument is not used, the default is **CHAR0**. **CHAR1** through **CHAR5** are for user characterizations that may have been written to the module by the User Characterization feature on the VNA. Choose from:

CHAR0 Factory characterization (data that was stored in the ECal module by

Keysight)

CHAR1 User characterization #1

CHAR2 User characterization #2

- through -

CHAR12 User characterization #12

Examples

```
SENS:CORR:COLL:CKIT:INF? ECAL4  
sense:correction:collect:ckit:information? ecal2,char1
```

Example return string:

```
ModelNumber: 85092-60007, SerialNumber: 01386, ConnectorType:  
N5FN5F, PortAConnector: Type N (50) female, PortBConnector: Type  
N (50) female, MinFreq: 30000, MaxFreq: 9100000000,  
NumberOfPoints: 250, Calibrated: July 4 2002
```

Return Type Character

Default Not Applicable

SENSe:CORRection:COLLection:CKIT:NAME <name>

Applicable Models: All

(Read-Write) Sets a name for the selected calibration kit.

Parameters

<name> Calibration Kit name. Any string name, can include numerics, period, and spaces; any length (although the dialog box display is limited to about 30 characters).

Examples

```
SENS:CORR:COLL:CKIT:NAME 'MYAPC35'  
sense:correction:collect:ckit:name 'mytypen'
```

Query Syntax SENSe:CORRection:COLLection:CKIT:NAME?

Return Type String

Default Not Applicable

SENSe:CORRection:COLLection:CKIT:OLABel<class> <name>

Applicable Models: All

(Read-Write) Sets the label for the calibration class designated by <class>. The label is used in the prompts for connecting the calibration standards associated with that <class>.

Parameters

<class> Number of the calibration class. Choose a number between: 1 and 18. The <class> numbers are associated with the following calibration Classes:

	Class	Description
Port 1		
1	SA	Reflection standard
2	SB	Reflection standard
3	SC	Reflection standard
4	FWD TRANS	Thru/Delay standard
Port 2		
5	SA	Reflection standard
6	SB	Reflection standard
7	SC	Reflection standard
8	REV TRANS	Thru/Delay standard

3-port analyzers only

Port 3		
9	S33A	Reflection standard
10	S33B	Reflection standard
11	S33C	Reflection standard
12	S32T	Thru/Delay standard
13	S23T	Thru/Delay standard
14	S31T	Thru/Delay standard
15	S13T	Thru/Delay standard

TRL Calibrations

16	TRL "T"	Thru standard
17	TRL "R"	Reflect standard
18	TRL "L"	Line standard

<name> Label for the calibration class. Must be enclosed in quotes. Any string between 1 and 12 characters long. Cannot begin with a numeric.

Examples

```
SENS:CORR:COLL:CKIT:OLAB3 'LOADS'  
sense:correction:collect:ckit:olabel14 'Thru'
```

Return Type String

Default Not Applicable

SENSe:CORRection:COLLect:CKIT:OLISt[class]?

Applicable Models: All

(Read-only) Returns seven values of standards that are assigned to the specified class.

This command ALWAYS applies to the Cal Kit that is selected (using **SENS:CORR:COLL:CKIT:SEL**) when this **ORDER** command is sent.

Parameters

<class> Number of the calibration class to be queried. The <class> numbers are associated with the following calibration Classes:

	Class	Description
Port 1		
1	SA	Reflection standard
2	SB	Reflection standard
3	SC	Reflection standard
4	FWD TRANS	Thru/Delay standard
Port 2		
5	SA	Reflection standard
6	SB	Reflection standard
7	SC	Reflection standard
8	REV TRANS	Thru/Delay standard

3-port analyzers ONLY (N3381A/2A/3A)

4-port analyzers use S11 and S22 classes **(see example program)**

Port 3		
9	S33A	Reflection standard
10	S33B	Reflection standard
11	S33C	Reflection standard

12	S32T	Thru/Delay standard
13	S23T	Thru/Delay standard
14	S31T	Thru/Delay standard
15	S13T	Thru/Delay standard

TRL Calibration

16	TRL "T"	Thru standard
17	TRL "R"	Reflect standard
18	TRL "L"	Line standard

Examples

SENS:CORR:COLL:CKIT:OLIS8?

Always returns 7 standard numbers. Unassigned standards return 0

Return Type

Numeric; returns the <class> number of the selected standard.

Default

Not Applicable

SENSe:CORRection:COLLect:CKIT:ORDeR<class> <std> [,<std>] [,<std>] [,<std>] [,<std>] [,<std>]

Applicable Models: All

(Read-Write) Sets a standard number to a calibration class. This command does **NOT** set or dictate the order for measuring the standards. For more information, see Assigning Standards to a Calibration Class.

This command ALWAYS applies to the Cal Kit that is selected (using **SENS:CORR:COLL:CKIT:SEL**) when this ORDeR command is sent.

Parameters

<class> Number of the calibration class that is assigned to <standard>. Choose a number between: **1** and **18**. The <class> numbers are associated with the following calibration Classes:

	Class	Description	STAN#
Port 1			
1	SA	Reflection standard	STAN1
2	SB	Reflection standard	STAN2
3	SC	Reflection standard	STAN3
4	FWD TRANS	Thru/Delay standard	STAN4
Port 2			
5	SA	Reflection standard	STAN1
6	SB	Reflection standard	STAN2
7	SC	Reflection standard	STAN3
8	REV TRANS	Thru/Delay standard	STAN4

3-port analyzers ONLY (N3381A/2A/3A)

4-port analyzers use S11 and S22 classes (see example program)

Port 3			
9	S33A	Reflection standard	STAN1
10	S33B	Reflection standard	STAN2
11	S33C	Reflection standard	STAN3
12	S32T	Thru/Delay standard	STAN4
13	S23T	Thru/Delay standard	STAN4
14	S31T	Thru/Delay standard	STAN4
15	S13T	Thru/Delay standard	STAN4

TRL Calibration

16	TRL "T"	Thru standard	STAN4
17	TRL "R"	Reflect standard	STAN1
18	TRL "L"	Line standard	STAN3

<std> Standard number to be assigned to the class; Choose a standard between 1 and 30. One standard is mandatory; up to six additional standards are optional.

Examples

'Assigns standard 3 to S11A class:

```
SENS:CORR:COLL:CKIT:ORD1 3
```

'Assigns standard 2 and 5 to S21T class class:

```
sense:correction:collect:ckit:order4 2,5
```

Query Syntax

SENSe:CORRection:COLLect:CKIT:ORDeR<class>?

'Returns only the first standard assigned to the specified class. To query the remaining standards, use

SENSe:CORRection:COLLect:CKIT:OLIST[1-15]?

Return Type

Numeric

Default

Not Applicable

SENSe<cnum>:CORRection:COLLect:CKIT:PORT<n>[:SELeCt] <string>

Applicable Models: All

(Read-Write) Sets and returns the name of the Cal Kit to use for **Unguided** cal.

This command effectively does the same task as **SENS:CORR:COLL:CKIT** but specifies the cal kit by name.

Note: During an **Unguided cal**, you can access **ONLY** mechanical cal kits #1 through #95. However, there is no limit to the number of cal kits that can be imported.

Parameters

<cnum> Currently not used. The unguided cal kit selection is for all ports on all channels.

<n> Currently not used. The unguided cal kit selection is for all ports on all channels.

<string> Cal Kit name enclosed in quotes. Use **SENS:CORR:COLL:CKIT:CAT?** to read a list of all available Cal Kits in the VNA.

Examples

```
SENS:CORR:COLL:CKIT:PORT "85052B"
```

```
sense2:correction:collect:ckit:port:select "85052D"
```

Query Syntax

SENSe<cnum>:CORRection:COLLect:CKIT:PORT<n>:SELeCt?

Return Type

String

Default

Last kit selected

SENSe:CORRection:COLLect:CKIT:RESet <num> - **Superseded**

Applicable Models: All

This command is replaced by `Sens:Corr:Ckit:Init`.

(Write-only) Resets the selected calibration kit to factory default definition values.

Parameters

<num> The number of the calibration kit to be reset. Choose any integer between: **1** and **8**

Examples

```
SENS:CORR:COLL:CKIT:RESet 1
sense:correction:collect:ckit:reset 4
```

Query Syntax Not Applicable

Default Not Applicable

SENSe<cnum>:CORRection:COLLect:CKIT[:SELEct] <num>

Applicable Models: All

(Read-Write) Selects (makes active) a calibration kit for **performing** an **UNGUIDED** calibration or for **modifying** standards. All subsequent "CKIT" commands that are sent apply to this selected calibration kit. Select a calibration standard using `SENS:CORR:COLL:CKIT:STAN <num>`. Kits 1 to approximately kit 37 are factory installed Cal Kits.

Note: During an **Unguided cal**, you can access **ONLY** mechanical cal kits #1 through #95. However, there is no limit to the number of cal kits that can be imported.

This command effectively does the same task as `SENS:CORR:COLL:CKIT:PORT` which specifies the cal kit by name instead of this command which specifies by number.

Parameters

<cnum> Any existing channel number; if unspecified, value is set to 1.

<num> The number of the calibration kit. Choose from:

Use `SENSe:CORRection:COLLect:CKIT:RESet` to restore Cal Kits to default values.

Name

- 1 Cal Kit 1
- 2 Cal Kit 2
- 3 Cal Kit 3

- 94 Cal Kit 94
 95 Cal Kit 95
 99 ECal module

Note: Always check the list of available cal kits using `SENSe:CORRection:COLLect:CKIT:CATalog?` to ensure that the correct cal kit is selected.

Examples `SENS:CORR:COLL:CKIT 2`
`sense2:correction:collect:ckit:select 7`

Query Syntax `SENSe<cnum>:CORRection:COLLect:CKIT?`

Return Type Numeric

Default Last kit selected

`SENSe:CORRection:COLLect:CKIT:STANdard:C0 <num>`

Applicable Models: All

(Read-Write) Sets the C0 value (the first capacitance value) for the selected standard. For a detailed discussion of this value, search for App Note 8510-5B at www.Keysight.com.

Parameters

<num> Value for C0 in femtofarads (1E-15)

Examples **The following commands set C0=15 femtofarads:**

```
SENS:CORR:COLL:CKIT:STAN:C0 15
sense:correction:collect:ckit:standard:c0 15
```

Query Syntax `SENSe:CORRection:COLLect:CKIT:STANdard:C0?`

Return Type Numeric

Default Not Applicable

`SENSe:CORRection:COLLect:CKIT:STANdard:C1 <num>`

Applicable Models: All

(Read-Write) Sets the C1 value (the second capacitance value) for the selected standard. For a detailed discussion of this value, search for App Note 8510-5B at www.Keysight.com.

Parameters

<num> Value for C1.

Examples

The following two commands set C1=15:

```
SENS:CORR:COLL:CKIT:STAN:C1 15  
sense:correction:collect:ckit:standard:c1 15
```

Query Syntax

SENSe:CORRection:COLLect:CKIT:STANdard:C1?

Return Type

Numeric

Default

Not Applicable

SENSe:CORRection:COLLect:CKIT:STANdard:C2 <num>

Applicable Models: All

(Read-Write) Sets the C2 value (the third capacitance value) for the selected standard. For a detailed discussion of this value, search for App Note 8510-5B at www.Keysight.com.

Parameters

<num> Value for C2.

Examples

The following two commands set C2:

```
SENS:CORR:COLL:CKIT:STAN:C2 15  
sense:correction:collect:ckit:standard:c2 15
```

Query Syntax

SENSe:CORRection:COLLect:CKIT:STANdard:C2?

Return Type

Numeric

Default

Not Applicable

SENSe:CORRection:COLLect:CKIT:STANdard:C3 <num>

Applicable Models: All

(Read-Write) Sets the C3 value (the fourth capacitance value) for the selected standard. For a detailed discussion of this value, search for App Note 8510-5B at www.Keysight.com.

Parameters

<num> Value for C3.

Examples

```
The following two commands set C3  
SENS:CORR:COLL:CKIT:STAN:C3 15  
sense:correction:collect:ckit:standard:c3 15
```

Query Syntax

SENSe:CORRection:COLLect:CKIT:STANdard:C3?

Return Type

Numeric

Default

Not Applicable

SENSe:CORRection:COLLect:CKIT:STANdard:CHARacter <char>

Applicable Models: All

(Read-Write) Sets the media type of the selected calibration standard.

Parameters

<char> Media type of the standard. Choose from:
Coax - Coaxial Cable
Wave - Waveguide

Examples

```
SENS:CORR:COLL:CKIT:STAN:CHAR COAX  
sense:correction:collect:ckit:standard:character wave
```

Query Syntax

SENSe:CORRection:COLLect:CKIT:STANdard:CHARacter?

Return Type

Numeric

Default

Coax

SENSe:CORRection:COLLect:CKIT:STANdard:DELay <num>

Applicable Models: All

(Read-Write) Sets the electrical delay value for the selected standard.

Parameters

<num> Electrical delay in picoseconds

Examples

The following two commands set delay to 50 picoseconds

```
SENS:CORR:COLL:CKIT:STAN:DEL 50e-12  
sense2:correction:collect:ckit:standard:delay 50ps
```

Query Syntax SENSE:CORRection:COLLect:CKIT:STANdard:DELay?

Return Type Numeric

Default Not Applicable

SENSe:CORRection:COLLect:CKIT:STANdard:FMAXimum <num>

Applicable Models: All

(Read-Write) Sets the maximum frequency for the selected standard.

Parameters

<num> Maximum frequency in Hertz.

Examples

```
SENS:CORR:COLL:CKIT:STAN:FMAX 9e9  
sense:correction:collect:ckit:standard:fmaximum 9Ghz
```

Query Syntax SENSE:CORRection:COLLect:CKIT:STANdard:FMAXimum?

Return Type Numeric

Default Not Applicable

SENSe:CORRection:COLLect:CKIT:STANdard:FMINimum <num>

Applicable Models: All

(Read-Write) Sets the minimum frequency for the selected standard.

Parameters

<num> Minimum frequency in Hertz.

Examples

```
SENS:CORR:COLL:CKIT:STAN:FMIN 1e3  
sense:correction:collect:ckit:standard:fminimum 1khz
```

Query Syntax SENSE:CORRection:COLLect:CKIT:STANdard:FMINimum?

Return Type Numeric

Default Not Applicable

SENSe:CORRection:COLLect:CKIT:STANdard:IMPedance <num>

Applicable Models: All

(Read-Write) Sets the characteristic impedance for the selected standard.

Parameters

<num> Impedance in Ohms

Examples

```
SENS:CORR:COLL:CKIT:STAN:IMP 75  
sense:correction:collect:ckit:standard:impedance 50.3
```

Query Syntax SENSE:CORRection:COLLect:CKIT:STANdard:IMPedance?

Return Type Numeric

Default 50

SENSe:CORRection:COLLect:CKIT:STANdard:L0 <num>

Applicable Models: All

(Read-Write) Sets the L0 value (the first inductance value) for the selected standard. For a detailed discussion of this value, search for App Note 8510-5B at www.Keysight.com.

Parameters

<num> Value for L0 in femtohenries (1E-15)

Examples

The following two commands set L0=15 femtohenries:

```
SENS:CORR:COLL:CKIT:STAN:L0 15
sense:correction:collect:ckit:standard:l0 15
```

Query Syntax

SENSe:CORRection:COLLect:CKIT:STANdard:L0?

Return Type

Numeric

Default

Not Applicable

SENSe:CORRection:COLLect:CKIT:STANdard:L1 <num>

Applicable Models: All

(Read-Write) Sets the L1 value (the second inductance value) for the selected standard. For a detailed discussion of this value, search for App Note 8510-5B at www.Keysight.com.

Parameters

<num> Value for L1.

Examples

The following two commands set L1=15:

```
SENS:CORR:COLL:CKIT:STAN:L1 15
sense:correction:collect:ckit:standard:l1 15
```

Query Syntax

SENSe:CORRection:COLLect:CKIT:STANdard:L1?

Return Type

Numeric

Default

Not Applicable

SENSe:CORRection:COLLect:CKIT:STANdard:L2 <num>

Applicable Models: All

(Read-Write) Sets the L2 value (the third inductance value) for the selected standard. For a detailed discussion of this value, search for App Note 8510-5B at www.Keysight.com.

Parameters

<num> Value for L2.

Examples

The following two commands set L2=15:

```
SENS:CORR:COLL:CKIT:STAN:L2 15
sense:correction:collect:ckit:standard:l2 15
```

Query Syntax

SENSe:CORRection:COLLect:CKIT:STANdard:L2?

Return Type

Numeric

Default

Not Applicable

SENSe:CORRection:COLLect:CKIT:STANdard:L3 <num>

Applicable Models: All

(Read-Write) Sets the L3 value (the fourth inductance value) for the selected standard. For a detailed discussion of this value, search for App Note 8510-5B at www.Keysight.com.

Parameters

<num> Value for L3.

Examples

The following two commands set L3=15:

```
SENS:CORR:COLL:CKIT:STAN:L3 15
sense:correction:collect:ckit:standard:l3 15
```

Query Syntax

SENSe:CORRection:COLLect:CKIT:STANdard:L3?

Return Type

Numeric

Default

Not Applicable

SENSe:CORRection:COLLect:CKIT:STANdard:LABel <name>

Applicable Models: All

(Read-Write) Sets the label for the selected standard. The label is used to prompt the user to connect the specified standard.

Parameters

<name> Label for the standard; Must be enclosed in quotes. Any string between **1** and **12** characters long. Cannot begin with a numeric.

Examples

```
SENS:CORR:COLL:CKIT:STAN:LAB 'OPEN'  
sense:correction:collect:ckit:standard:label 'Short2'
```

Query Syntax

SENSe:CORRection:COLLect:CKIT:STANdard:LABel?

Return Type

String

Default

Not Applicable

SENSe:CORRection:COLLect:CKIT:STANdard:LOSS <num>

Applicable Models: All

(Read-Write) Sets the insertion loss for the selected standard.

Parameters

<num> Insertion loss in Gohms / sec. (GigaOhms per second of electrical delay)

Examples

```
SENS:CORR:COLL:CKIT:STAN:LOSS 3.5e9  
sense:correction:collect:ckit:standard:loss 3
```

Query Syntax

SENSe:CORRection:COLLect:CKIT:STANdard:LOSS?

Return Type

Numeric

Default

Not Applicable

SENSe:CORRection:COLLect:CKIT:STANdard:REMOve

Applicable Models: All

(Write only) Deletes the selected standard from the selected cal kit.

Examples

```
SENS:CORR:COLL:CKIT:STAN:REMOve
```

Default

Not Applicable

SENSe:CORRection:COLLect:CKIT:STANdard:SDEscription <string>

Applicable Models: All

(Read-Write) Modifies the description of the selected standard of the selected kit. This description appears in the **edit kit dialog box**.

Parameters

<string> Description of the standard.

Examples

```
SENS:CORR:COLL:CKIT:STAN:SDES "My New Standard"
```

Query Syntax

```
SENSe:CORRection:COLLect:CKIT:STANdard:SDEscription?
```

Return Type

String

Default

Not Applicable

SENSe:CORRection:COLLect:CKIT:STANdard[:SELEct] <num>

Applicable Models: All

(Read-Write) Selects the calibration standard. All subsequent "CKIT" commands to modify a standard will apply to the selected standard. Select a calibration kit using **SENS:CORR:COLL:CKIT:SEL**

Parameters

<num> Number of the standard. Choose any number between:
1 and 30

Examples

```
SENS:CORR:COLL:CKIT:STAN 3  
sense:correction:collect:ckit:standard:select 8
```

Query Syntax

```
SENSe:CORRection:COLLect:CKIT:STANdard[:SELEct]?
```

Return Type

Numeric

Default

1

SENSe:CORRection:COLLect:CKIT:STANdard:TYPE <char>

Applicable Models: All

(Read-Write) Sets the type for the selected standard.

Parameters

<char> Choose from:
OPEN
SHORT
LOAD
SLOAD (sliding load)

THRU (through)

ARBI (arbitrary)

DATAbased (data-based)

Examples

```
SENS:CORR:COLL:CKIT:STAN:TYPE LOAD  
sense:correction:collect:ckit:standard:type short
```

Query Syntax

SENSe:CORRection:COLLect:CKIT:STANdard:TYPE?

Return Type

Character

Default

Not Applicable

SENSe:CORRection:COLLect:CKIT:STANdard:TZReal <num>

Applicable Models: All

(Read-Write) Sets the TZReal component value of the Terminal Impedance for the selected standard.

Note: Only applicable when the Standard Type is set to **ARBI**

Parameters

<num> Value for TZReal in Ohms

Examples

The following commands set TZReal=15 Ohms:

```
SENS:CORR:COLL:CKIT:STAN:TZReal 15  
sense:correction:collect:ckit:standard:TZReal 15
```

Query Syntax

SENSe:CORRection:COLLect:CKIT:STANdard:TZReal?

Return Type

Numeric

Default

Not Applicable

SENSe:CORRection:COLLect:CKIT:STANdard:TZImag <num>

Applicable Models: All

(Read-Write) Sets the TZImag component value of the Terminal Impedance for the selected standard.

Note: Only applicable when the Standard Type is set to **ARBI**

Parameters

<num> Value for TZImag in Ohms

Examples

The following two commands set TZImag=15 Ohms:

```
SENSe:CORR:COLL:CKIT:STAN:TZImag 15
sense:correction:collect:ckit:standard:TZImag 15
```

Query Syntax

SENSe:CORRection:COLLect:CKIT:STANdard:TZImag?

Return Type

Numeric

Default

Not Applicable

SENSe:CORRection:COLLect:CKIT:TRLoption:IMPedance <char>

Applicable Models: All

(Read-Write) Sets the reference impedance when using this TRL cal kit. [Learn more.](#)

Before sending this command, select a cal kit using **SENSe:CORR:COLL:CKIT:SELect**.

Parameters

<char> Choose from:

SYSTEM - The system impedance is used as the reference impedance. During a Guided or Unguided Cal, the Z0 of the Cal standard's connector definition sets the System Z0.

Make this selection when the desired test port impedance differs from the impedance of the LINE standard. Also, make this selection when skin effect impedance correction is desired for coax lines.

LINE The impedance of the line standard is used as the reference impedance, or center of the Smith Chart. Any reflection from the line standard is assumed to be part of the directivity error.

Examples

```
SENSe:CORR:COLL:CKIT:TRL:IMP SYST
sense:correction:collect:ckit:trloption:impedance line
```

Query Syntax	SENSe:CORRection:COLLect:CKIT:TRLOption:IMPedance?
Return Type	Character
Default	LINE

SENSe:CORRection:COLLect:CKIT:TRLOption:LRLChar <bool>

Applicable Models: All

(Read-Write) This setting ONLY applies if an LRL Cal Kit is being modified AND Testport Reference Plane is set to THRU AND the TRL Thru class standard and the TRL Line/Match class standard both have the same values for Offset Z0 and Loss. Otherwise, this setting is ignored.

Before sending this command, select a cal kit using **SENS:CORR:COLL:CKIT:SElect**.

Parameters

<bool> Choose from:

1 or **ON** - Automatically correct for line loss and dispersion characteristics.

0 or **OFF** - Select when anomalies appear during a calibrated measurement which may indicate different loss and impedance values for the Line standards.

Examples

```
SENS:CORR:COLL:CKIT:TRL:LRLC 1
```

```
sense:correction:collect:ckit:trloption:lrlchar off
```

Query Syntax	SENSe:CORRection:COLLect:CKIT:TRLOption:LRLChar?
Return Type	Boolean
Default	OFF

SENSe:CORRection:COLLect:CKIT:TRLOption:RPLane <char>

Applicable Models: All

(Read-Write) Sets the reference impedance when using this cal kit. [Learn more.](#)

Before sending this command, select a cal kit using `SENS:CORR:COLL:CKIT:SElect`.

Parameters

<char> Choose from:

THRU The THRU standard definition is used to establish the measurement reference plane. Select if the THRU standard is zero-length or very short.

REFlect The REFLECT standard definition is used to establish the position of the measurement reference plane. Select if the THRU standard is not appropriate AND the delay of the REFLECT standard is well defined. Also, select If a flush short is used for the REFLECT standard because a flush short provides a more accurate phase reference than a Thru standard.

Examples

```
SENS:CORR:COLL:CKIT:TRL:RPL THRU
```

```
sense:correction:collect:ckit:trloption:rplane reflect
```

Query Syntax `SENSe:CORRection:COLLect:CKIT:TRLOption:RPLane?`

Return Type Character

Default THRU

Sense:Correction:Cset Commands

Performs actions on calibration sets.

SENSe:CORREction:CSET

ACTivate

CATalog?

COPY

CREate

| **DEFault**

DATA

DEACTivate

DELeTe

DESCription

ETERm

| **CATalog?**

| **[DATA]**

FLATten

GENerate

| **RECeiver**

GUID

ITEM

| **CAT?**

| **[[:DATA]?**

NAME

SAVE

[SELeCt]

STANdard
CATalog?
STIMulus?
TSET
ALLPorts?
TYPE?
TYPE
CATalog?

Click on a keyword to view the command details.

[Blue](#) keywords are superseded commands. [Learn more.](#)

See Also

- [Creating Cal Sets](#)
- [Example Programs](#)
- [Learn about Cal Sets](#)
- [Synchronizing the Analyzer and Controller](#)

SENSe<cnun>:CORRection:CSET:ACTivate <string>, <bool>

Applicable Models: All

This command replaces [SENS:CORR:CSET:GUID](#)

(Read-Write) Selects and applies a Cal Set to the specified channel.

Use [SENS:CORR:CSET:CAT?](#) to list the Cal Sets.

Parameters

- <cnun> Any existing channel number. If unspecified, value is set to 1
- <string> Cal Set to make active. Specify the Cal Set by **GUID** or **Name**. Use [SENS:CORR:CSET:CAT?](#) to list the available Cal Sets in either format.
- <bool> Should the Cal Set stimulus values be applied to the channel. Choose from:

ON (1) Apply the Cal Set stimulus values to the channel.

OFF (0) Do NOT apply the Cal Set stimulus values. If the Cal Set stimulus values do not match the channel stimulus values, then the following will occur:

- If interpolation is ON, then interpolation will be attempted. This may fail if the channel frequency is outside the range of the Cal Set.
- If interpolation is OFF, the selection will be abandoned and an error is returned:

Examples

```
SENS:CORR:CSET:ACT "My2Port",1  
  
sense:correction:cset:activate? name  
' returns  
"My2Port"
```

Query Syntax SENSE<cnum>:CORRection:CSET:ACTivate? [GUID|NAME]

Returns the name of the Cal Set that is applied to the specified channel. Choose from **GUID** or **NAME** to specify which string is returned. If unspecified, the GUID of the Cal Set is returned. If no Cal Set is applied to the specified channel, then "No Calset Selected" is returned.

Return Type String

Default Not Applicable

SENSe:CORRection:CSET:CATalog? [char] - Superseded

Applicable Models: N522xB, N523xB, N524xB, M937xA, P937xA

This command is replaced by **CSET:CAT?**

(Read-only) Returns a list of Cal Sets.

Parameters

<char> Optional argument. The list is returned in one of the following formats. Both return comma-separated string lists.

GUID Cal Sets are listed by GUID (Default if unspecified).

NAME Cal Sets are listed by Name

Examples

```
SENS:CORR:CSET:CAT?  
  
'Returns:  
{FD6F863E-9719-11d5-8D6C-00108334AE96},{1B03B2CE-971A-11d5-8D6C-  
00108334AE96}
```

```
sense2:correction:cset:catalog? name
```

Default Not Applicable

SENSe<cnum>:CORRection:CSET:COpy <string>

Applicable Models: All

(Write-only) Creates a new Cal Set and copies the current Cal Set data into it. Use this command to manipulate data on a Cal Set without corrupting the original cal data.

Parameters

- <cnum> Channel number using the Cal Set to be copied. If unspecified, value is set to 1
- <string> Name of the new Cal Set.

Examples

```
SENS2:CORR:CSET:COpy 'My2Port'
```

Query Syntax Not Applicable

Default Not Applicable

SENSe<cnum>:CORRection:CSET:CREate [name]

Applicable Models: All

(Write-only) Creates an empty Cal Set and attaches it to the specified channel. This command is ONLY necessary before remotely filling the Cal Set with error term data. (For Advanced Users).

A Cal Set is automatically created, applied to the channel, and saved at the completion of a guided cal according to the preference setting **SENS:CORR:PREF:CSET:SAVE**.

Parameters

- <cnum> Any existing channel number. If unspecified, value is set to 1
- [name] Optional argument. Name of the Cal Set. Spaces or punctuation are NOT allowed. If unspecified, a unique name is chosen in the form "Calset_N" where N is a unique number.

Examples

```
SENS:CORR:CSET:CRE 'My2Port'
```

Query Syntax Not Applicable

Default Not Applicable

SENSe<cnum>:CORRection:CSET:CREate:DEFault [<csetname>], [<correctiontype>]

Applicable Models: All

(Write-only) Creates a unity Cal Set useful for debugging or to quickly test a prototype of automation software.

Parameters

<cnum> Any existing channel number. If unspecified, value is set to 1

[<csetname>] Optional argument. Name of the Cal Set. Spaces or punctuation are NOT allowed. If unspecified, a unique name is chosen in the form "Calset_N" where N is a unique number.

[<correctiontype>] Optional argument. Specifies the correction type to use as the default. Use the **SENSe:CORRection:TYPE:CATalog?** command for a list of correction types.

Examples

```
'This example applies 2-port error correction as if the system
were perfect.
All error terms will be 1 or 0.
SENS:CORR:CSET:CRE:DEF 'My2Port', 'Full 2P(1,2)'
```

Query Syntax Not Applicable

Default Not Applicable

SENSe<cnum>:CORRection:CSET:DATA <eterm, portA, portB,>[<rec>] <block>

Applicable Models: All

(Read-Write) Read or Write a specific error term from/to the Cal Set currently attached to the specified channel. (For Advanced Users). The command can be used only for the error terms listed. See **SENS:CORR:CSET:ETERM** to get and put error term data using a string argument for all error terms.

Parameters

<cnum> Any existing channel number. If unspecified, value is set to 1

<eterm, portA, portB> **Error Term, Port pair of the specified error term.**

portB>

Although not all error terms use two port numbers, two are required by the VNA in all cases. Each port number must be between 1 and the number of ports on the VNA.

EDIR - directivity

portA: the port at which directivity is measured.

portB: Not used, but must be a valid VNA port number.

ESRM - source match

portA: the port at which source match is measured.

portB: Not used, but must be a valid VNA port number.

ERFT - reflection tracking

portA: the port at which reflection tracking is measured.

portB: Not used, but must be a valid VNA port number.

ELDM - load match

portA: the port at which load match is measured.

portB: the source port.

Load match is measured with a cable connected between the measured port (portA) and the source port (portB).

The cal system requires that the complete matrix of loadmatch arrays be filled.

In most cases you can measure loadmatch once at a port, driven by any other port. Then use that data for all variations of the receive port. (The exception is the 3-port VNA models, which requires the loadmatch-measured port to be driven by every other port.)

For example: Measure the loadmatch at port2 while driving port1. Then upload this same data to the following arrays:

ELDM,2,1,<data>

ELDM,2,3,<data>

ELDM,2,4,<data>

ETRT - transmission tracking

portA: the receive port

portB: the source port for this measurement

EXTLK - crosstalk

portA: the receive port

portB: the source port for this measurement

ERSPT - response tracking.

portA: Not used, but must be a valid VNA port number.

portB: Not used, but must be a valid VNA port number.

ERSPI - response isolation.

portA: Not used, but must be a valid VNA port number.

portB: Not used, but must be a valid VNA port number.

<rec> <string> - Specify the VNA receiver for which the Eterm applies.

Required ONLY when Eterm is response tracking (**ERSPT**) or response isolation (**ERSPI**).

Logical receiver notation is allowed.

A full 4-port calibration requires the following terms be uploaded:

		PORT B			
		1	2	3	4
P O R T A	1	EDIR,1,1	ELDM,1,2	ELDM,1,3	ELDM,1,4
		ERFT,1,1	ETRT,1,2	ETRT,1,3	ETRT,1,4
		ESRM,1,1	EXTLK,1,2	EXTLK,1,3	EXTLK,1,4
	2	ELDM,2,1	EDIR,2,2	ELDM,2,3	ELDM,2,4
		ETRT,2,1	ERFT,2,2	ETRT,2,3	ETRT,2,4
		EXTLK,2,1	ESRM,2,2	EXTLK,2,3	EXTLK,2,4
	3	ELDM,3,1	ELDM,3,2	EDIR,3,3	ELDM,3,4
		ETRT,3,1	ETRT,3,2	ERFT,3,3	ETRT,3,4
		EXTLK,3,1	EXTLK,3,2	ESRM,3,3	EXTLK,3,4
	4	ELDM,4,1	ELDM,4,2	ELDM,4,3	EDIR,4,4
		ETRT,4,1	ETRT,4,2	ETRT,4,3	ERFT,4,4
		EXTLK,4,1	EXTLK,4,2	EXTLK,4,3	ESRM,4,4

Reflection terms

Transmission terms

<block> (Block). Error term data. A Real / Imaginary data pair for each data point.

Format is set using **FORM:DATA** command.

For REAL binary formats, refer to **Getting Data from the Analyzer using SCPI**

Example

```
'Set the directivity term with a cal set using 5 points  
SENS1:CORR:CSET:DATA EDIR, 1, 1, +6.12569600000E-002,-  
7.27163800000E-003,-3.63812000000E-003,+1.33521800000E-002,-  
4.36775100000E-003,+1.87792400000E-002,-4.09239100000E-  
003,+4.24291200000E-002,-2.03784900000E-002,+3.21425100000E-002"
```

Query Syntax

SENSe<cnum>:CORRection:CSET:DATA? <eterm,portA,
portB>,<rec>

Query Examples

```
'Read the response isolation eterms for the port 1 reference  
receiver  
  
sens:corr:cset:data? ERSPI,1,1,'R1'  
  
'Same receiver using logical receiver notation  
  
sens:corr:cset:data? ERSPI,1,1,'a1'
```

Return Type

Block data

Default

Not Applicable

SENSe<cnum>:CORRection:CSET:DEACTivate

Applicable Models: All

(Write-only) Unselects a Cal Set from the specified channel.

Parameters

<cnum> Channel number to have Cal Set unselected.

Examples

```
SENS:CORR:CSET:DEAC  
  
sense2:correction:cset:deactivate
```

Query Syntax

Not Applicable

Default

Not Applicable

SENSe:CORRection:CSET:DELete <string> - Superseded

Applicable Models: N522xB, N523xB, N524xB, M937xA, P937xA

This command is replaced by **CSET:DEL**.

(Write-only) Deletes a Cal Set from the set of available Cal Sets. This method immediately updates the Cal Set file on the hard drive. If the Cal Set is currently being used by a channel or does not exist, this request will be denied and an error is returned.

Parameters

<string> Cal Set to be deleted. Specify the Cal Set by **GUID** or **Name**. Use **SENS:CORR:CSET:CAT?** to list the available Cal Sets in either format.

Examples

```
SENS:CORR:CSET:DEL '{2B893E7A-971A-11d5-8D6C-00108334AE96}'  
sense2:correction:cset:delete 'MyCalSet'
```

Query Syntax Not Applicable

Default Not Applicable

SENSe<cnun>:CORRection:CSET:DESCription <string>

Applicable Models: All

(Read-Write) Sets or returns the descriptive string assigned to the selected Cal Set. Change this string so that you can easily identify each Cal Set. Apply and select the Cal Set using **SENS:CORR:CSET:ACT**.

Parameters

<cnun> Any existing channel number. If unspecified, value is set to 1

<string> The descriptive string associated with the currently-selected Cal Set

Examples

```
SENS:CORR:CSET:DESC 'MyCalSet'  
sense2:correction:cset:description 'thisCalSet'
```

Query Syntax SENSe<cnun>:CORRection:CSET:DESCription?

Return Type String

Default Not Applicable

SENSe<cnun>:CORRection:CSET:ETERm[:DATA] <string>,<data>

Applicable Models: All

(Read-Write) Sets or returns error term data for all VNA measurements.

Parameters

- <num> Any existing channel number. If unspecified, value is set to 1
- <string> (String) Error term to read or write. The error term is specified using the EXACT case-sensitive string displayed in the [Cal Set Viewer](#) utility. See [SENS:CORR:CSET:DATA](#) for a description of port numbers.

The following Noise figure error terms are listed for convenience:

- **RcvNoiseCorr_m_n** Noise correlation matrix of the noise receiver (a 2x2 complex matrix). The row and column indices m and n range from 1 to 2.
- **RcvT_m_n** T-matrix of the noise receiver (a 2x2 complex matrix). The row and column indices m and n range from 1 to 2.
- **GammaTuner_n** Reflection coefficient for impedance state n of the embedded noise tuner (Ecal module) in the port 1 source path. For the Keysight 4691 family of Ecal modules, n can range from 1 to 7.

<data> (Block) Error term data. A Real / Imaginary data pair for each data point.

Format is set using [FORM:DATA](#) command.

For REAL binary formats, refer to [Getting Data from the Analyzer using SCPI](#)

Examples

```
SENS:CORR:CSET:ETERM "Directivity(1,1)", 0.237,-1.422, 0.513,
0.895 ' set directivity(source error term for 2 points
SENS:CORR:CSET:ETERM? "Directivity(1,1)" 'read
```

Query Syntax SENSE<num>:CORRection:CSET:ETERm[:DATA]? <string>

Return Type Block data

Default Not Applicable

SENSe<num>:CORRection:CSET:ETERm:CATalog?

Applicable Models: All

(Read-only) Returns a list of error term names found in the current Cal Set that is applied to the specified channel.

Parameters

Examples

```
SENS:CORR:CSET:ETER:CAT?
```

```
'For a 1-port cal, returns
```

```
"Directivity(1,1),ReflectionTracking(1,1),SourceMatch(1,1)"
```

Return Type String

Default Not Applicable

SENSe<cnum>:CORRection:CSET:FLATten <string>

Applicable Models: All

(Write-only) When a Cal Set that was produced by a calibration has been interpolated or otherwise modified (for example, by **Fixturing operations**) this command saves the modified Cal Set to the VNA hard drive so that it can be reused. There is no User Interface equivalent for this command.

Background

When a Cal Set is selected for use by a channel, the channel reads the Cal Set from disk (master Cal Set). If the channel aligns perfectly with the Cal Set, the master Cal Set is used directly. In this case, the active Cal Set is the master Cal Set.

When processing occurs on the error terms due to interpolation or modification due to the use of fixturing, the channel will generate a temporary "memory-resident" Cal Set. In this case, the active Cal Set is the memory-resident Cal Set. This FLATten command allows you to save the active Cal Set to disk.

Depending on the measurement conditions, this flattening of the Cal Set can improve performance, especially if the Cal Set is applied often (using multiple recall states) or used by many channels.

Flattening a version of the Cal Set for each channel can avoid the interpolation or the fixturing processing that would otherwise occur when the Cal Set is selected or the instrument state is recalled.

You will have to manage the application of such a Cal Set as the VNA itself will have no way to determine what processing had been done once the flatten command is used. For example, if fixture de-embedding occurred prior to the flatten command, that Cal Set should then be applied WITHOUT fixturing on, because fixturing is already embedded in that Cal Set. It is your responsibility to apply

the Cal Set properly.

If you want to repeatedly de-embed multiple networks (i.e. concatenate multiple 2-port de-embedding files) you can use the flatten command to create a new master Cal Set after each de-embed, and sequentially add additional de-embed networks.

Parameters

- <num> Channel number on which the modified Cal Set resides. If unspecified, value is set to 1
- <string> Name of the new Cal Set. Spaces or punctuation NOT allowed.

Examples

```
SENS:CORR:CSET:FLAT "MyCalSet"
```

Query Syntax Not Applicable

Default Not Applicable

SENSe<num>:CORRection:CSET:GENerate:RECeiver <receiverName>

Applicable Models: All Models

This command converts the selected Cal Set from an S-parameter Cal Set to an S-parameter+Power Cal Set. This command requires a Cal Set to be selected.

There are 2 modes for using this command:

Mode 1:

The <receiverName> is optional. If not specified, then ResponseTracking(a1) is set to 1, and the rest of ResponseTracking() terms are computed to be consistent with the S-parameter calibration terms.

Mode 2:

Use this pattern when there is already a receiver calibration for one of the receivers. In that case, this command can be used to transfer the receiver calibration to the other receivers.

If <receiverName> is specified, it must be either 'a1','a2','a3', etc or 'b1','b2','b3'. The ResponseTracking term for this receiver must already be added to the Cal Set, or else this command will generate an error. This command will then compute the ResponseTracking() terms for all of the other receivers in a manner consistent with the S-parameter calibration terms.

Parameters

- <num> Channel number on which the modified Cal Set resides. If unspecified, value is set to 1.

<receiverName> Name of the receiver ('a1', 'a2', 'a3', etc., or 'b1', 'b2', 'b3', etc.)

Examples

```
SENS:CORR:CSET:GEN:REC 'a1'
```

Query Syntax

SENSe<cnum>:CORRection:CSET:GENerate:RECeiver?

Default

Not Applicable

SENSe<cnum>:CORRection:CSET:GUID <string> **Superseded**

Applicable Models: N522xB, N523xB, N524xB, M937xA, P937xA

This command is replaced by **SENS:CORR:CSET:ACTivate**.

(Read-Write) Selects the Cal Set identified by the string parameter (GUID) and applies it to the specified channel.

- A Cal Set cannot be selected for a channel which is not ON.
- If the stimulus settings of the selected Cal Set differ from those of the selected channel, the instrument will automatically change the channel's settings to match the Cal Set.

Parameters

<cnum> Any existing channel number. If unspecified, value is set to 1

<string> GUID of the desired Cal Set. The curly brackets and hyphens must be included.

Examples

```
SENS:CORR:CSET:GUID '{2B893E7A-971A-11d5-8D6C-00108334AE96}'  
sense2:correction:cset:guid '{2B893E7A-971A-11d5-8D6C-  
00108334AE96}'
```

Query Syntax

SENSe<cnum>:CORRection:CSET:GUID?

Returns the GUID of the currently-selected Cal Set for the specified channel.

Return Type

String

Default

Not Applicable

SENSe<cnum>:CORRection:CSET:ITEM:CATalog?

Applicable Models: All

(Read-only) Returns the names of the items in the Cal Set.

Parameters

Examples

```
SENS:CORR:CSET:ITEM:CAT?
```

```
"Created By,Firmware Revision,Model Number,Serial  
Number" 'Example returned item names.'
```

Return Type String

If no Cal Set is applied on the current channel, the following error message is displayed:

+163, "Requested Cal Set was not found in Cal Set Storage."

Default Not Applicable

SENSe<cnum>:CORRection:CSET:ITEM[:DATA]? <itemName>

Applicable Models: All

(Read-only) Read the value of the Cal Set item. The Cal Set item is added by the VNA firmware to every Cal Set.

About Cal Set Items

A Cal Set item is a named value. You can list the named values using CSET:ITEM:CATalog? or SENS:CORR:CSET:ITEM:CATalog?

You can query the value of a specific item by asking for its data: CSET:ITEM:DATA?

For example, one of the items added by the VNA firmware to every Cal Set is named 'Created By'. The value attached to this item is the name of the VNA Measurement Class or Channel that created the Cal Set. When an SMC cal is performed, you can query the Cal Set for the 'Created By' item, and it will return 'Scalar Mixer/Converter'. The same query on an NFx channel returns 'Noise Figure Converters'.

Parameters

<cnum> Any existing channel number. If unspecified, value is set to 1

<itemName> (String) Item added by the VNA firmware to the currently loaded Cal Set.

Examples

```
SENS:CORR:CSET:ITEM? "Model Number"
```

```
"N5242B" 'Example returned Model Number value.'
```

Return Type String

If no Cal Set is applied on the current channel, the following error message is displayed:

+163, "Requested Cal Set was not found in Cal Set Storage."

Default Not Applicable

SENSe<cnum>:CORRection:CSET:NAME <string>

Applicable Models: All

(Read-Write) Sets or queries the name of the Cal Set currently applied to the specified channel.

Parameters

<cnum> Any existing channel number. If unspecified, value is set to 1

<string> Name of the Cal Set. Spaces or punctuation NOT allowed.

Examples

```
SENS:CORR:CSET:NAME 'MyCalSet'  
sense2:correction:cset:name 'thisCalSet'
```

Query Syntax SENSe<cnum>:CORRection:CSET:NAME?

Return Type String

Default Not Applicable

SENSe<cnum>:CORRection:CSET:SAVE [<char>]

Applicable Models: All

This command is NOT necessary after completion of a calibration. A Cal Set is automatically created, applied to the channel, and saved at the completion of a guided cal according to the preference setting **SENS:CORR:PREF:CSET:SAVE**.

(Read Write)

Saves the channel's Cal Set to the VNA hard drive. For example, use this command after writing data to a Cal Set using **SENS:CORR:CSET:DATA** (For Advanced Users).

The file name is saved as "**CSETx.cst**" where x is the user number assigned to <char>, and .cst specifies a Cal Set and instrument state. This is not the same syntax as a file saved through the default choices from the front panel, which is "**at00x.cst**". For more information on the file naming syntax, see the **MMEMory** subsystem. Learn more about **Instrument/Cal States**.

Parameters

<cnum> Any existing channel number. If unspecified, value is set to 1

[<char>] Optional argument. Choose from:

USER01

USER02...

and so forth, until...

USER10

If <char> is NOT specified, changes that may have been made are saved to the cal set and NOT to the *.cst file.

Examples

```
SENS:CORR:CSET:SAVE USER03
sense2:correction:cset:save user09

'save changes to only the cal set

SENS:CORR:CSET:SAVE
```

Query Syntax SENSE<num>:CORRection:CSET:SAVE?

Queries the last correction set saved.

Return Type Character

Default Not applicable

SENSe<num>:CORRection:CSET[:SELEct] <char> **Superseded**

Applicable Models: N522xB, N523xB, N524xB, M937xA, P937xA

This command is replaced by **MMEM:LOAD**

(Read-Write) Recalls a *.cst file from memory. The file name is "CSETx.cst" where x is the user number assigned to <char>. Learn more about [.cst files](#)

For more information on the file naming syntax, see the **MMEMory** subsystem.

Note: This command does NOT select a Cal Set for a channel. To select a Cal Set, use **SENS:CORR:CSET:ACTivate**

Parameters

<num> Any existing channel number. If unspecified, value is set to 1

<char> Choose from:

DEF - Presets the analyzer

USER01 - Restores User01 calibration data

USER02 - Restores User02 calibration data

through...

USER10 - Restores User10 calibration data

Examples

```
SENS:CORR:CSET DEF  
sense2:correction:cset:select user02
```

Query Syntax

SENSe<cnum>:CORRection:CSET[:SElect]?

Return Type

Character

Default

DEF

SENSe<cnum>:CORRection:CSET:STANdard[:DATA] <string>,<data>

Applicable Models: All

(Read-Write) Sets or returns standard data. Standard data is available for Unguided Cals ONLY.

Note: The “Standards data” container in the calset is intended for internal use only. External access is provided for use in diagnosing calibration problems. Users should not form any expectations as to the presence of the data or the naming conventions used.

Parameters

- <cnum> Any existing channel number. If unspecified, value is set to 1
- <string> (String) Cal standard to read or write. The standard is specified using the EXACT case-sensitive string displayed in the **Cal Set Viewer** utility. See **SENS:CORR:CSET:DATA** for a description of port numbers.
- <data> (Block). Acquisition data. A Real / Imaginary data pair for each data point.
Format is set using **FORM:DATA** command.

For REAL binary formats, refer to **Getting Data from the Analyzer using SCPI**

Examples

```
SENS:CORR:CSET:STAN 'S11C(1,1), 0.237,-1.422, 0.513, 0.895 '  
Set acquisition data for two points.  
  
SENS:CORR:CSET:STAN:DATA? "S11C(1,1)" 'Read data
```

Query Syntax

SENSe<cnum>:CORRection:CSET:STANdard[:DATA]? (string)

Return Type

Block data

Default

Not Applicable

SENSe:CORRection:CSET:STANdard:CATalog?

Applicable Models: All

(Read-only) Returns a list of available standard name found in the current Cal Set that is applied to the specific channel.

Parameters

Examples `SENS:CORR:CSET:STAN:CAT?`

Return Type String

Default Not Applicable

SENSe<ch>:CORRection:CSET:STIMulus? [num]

Applicable Models: All

(Read-only) Returns the source or response stimulus values for the Cal Set that is currently used by channel <ch>. Values are returned in the format specified by **FORM:DATA** (Block or ASCII).

Parameters

<ch> Channel number to query Cal Set stimulus values. If unspecified, value is set to 1

[num] Optional argument. Range of frequencies to return. These values would be different when FOM (Opt S93080A) is enabled.

0 - returns source frequencies. Default setting if not specified.

1 - returns response frequencies.

2 - returns primary frequencies.

Examples `SENS:CORR:CSET:STIM?`
`sense:correction:cset:stimulus 1`

Return Type Numeric

Default Not Applicable

SENSe:CORRection:CSET:TSET:ALLPorts? <cset>

Applicable Models: All

(Read-only) Reads the port mapping used for the specified Cal Set. The returned values are the physical ports. The POSITION of the returned values corresponds to the logical ports.

For example, with an N44xx test set, if the returned string is "PNA 1,TS 2,PNA 2, TS 4" this means:

- VNA 1 is assigned to logical port 1
- TS 2 is assigned to logical port 2
- VNA 2 is assigned to logical port 3
- TS 4 is assigned to logical port 4

Parameters

<cset> **(String)** Name or GUID of the Cal Set. Use **SENS:CORR:CSET:CAT?** to read the list of available Cal Set names or GUIDs.

Examples

```
SENS:CORR:CSET:TSET:ALLP? "MyCalSet"  
sens:correction:cset:tset:allports? "{2B893E7A-971A-11d5-8D6C-  
00108334AE96}"
```

Return Type String

Default Not Applicable

SENSe:CORRection:CSET:TSET:TYPE? <cset>

Applicable Models: All

(Read-only) Reads the test set type (model) used for the specified Cal Set.

Parameters

<cset> **(String)** Name or GUID of the Cal Set. Use **SENS:CORR:CSET:CAT?** to read the list of available Cal Set names or GUIDs.

Examples

```
SENS:CORR:CSET:TSET:TYPE? "MyCalSet"  
  
'returns "N44xx"  
  
sens:correction:cset:tset:type? "{2B893E7A-971A-11d5-8D6C-  
00108334AE96}"
```

Return Type String

Default Not Applicable

SENSe<ch>:CORRection:CSET:TYPE:CATalog? [format]

Applicable Models: All

(Read-only) Query the Cal Types available in the selected Cal Set. The output is a comma separated list of Guids or a Cal Type names. [Learn more about applying Cal Types using SCPI.](#)

Use **CALC:MEAS:CORR:TYPE** to apply a Cal Type.

Parameters

<ch> Any existing channel number. If unspecified, value is set to 1
[format] (Optional) Format of the output of cal types. choose from:

NAME - (default) returns a list of cal type string names.

GUID - returns a list of cal type GUIDs

Examples

```
SENS:CORR:CSET:TYPE:CAT? NAME
```

```
SENS2:CORRection:CSET:TYPE:CAT?
```

Return Type String

Default Not Applicable

Sense:Correction:Extension Commands

Performs and applies Port Extensions.

SENSe:CORREction:EXTension:

AUTO

- | **CONFig**
- | **DCOffset**
- | **LOSS**
- | **MEASure**
- | **PORT**
- | **RESet**
- | **STARt**
- | **STOP**

PORT

- | **DISTance**
- | **FREQuency**
- | **INCLude**
 - | **[STATe]**
- | **LDC**
- | **LOSS**
- | **MEDium**
- | **SYSMedia**
- | **SYSVelocity**
- | **[TIME]**
- | **UNIT**

VELFactor
WGCutoff
RECeiver
[TIME]
[STATe]

Click on a keyword to view the command details.

See Also

- [Example Programs](#)
- [Learn about Port Extensions](#)
- [Synchronizing the Analyzer and Controller](#)
- [SCPI Command Tree](#)

SENSe<num>:CORRection:EXTension:AUTO:CONFIg <char>

Applicable Models: All

(Read-Write) Sets the frequencies used to calculate Automatic Port Extension. [Learn more about calculating Automatic Port Extension.](#)

Parameters

<num> Any existing channel number. If unspecified, value is set to 1

<char> Frequencies to be used:

CSPN Use current frequency span.

AMKR - Use active marker frequency.

USPN - Use custom user span. Use **SENS:CORR:EXT:AUTO:STAR** and **SENS:CORR:EXT:AUTO:STOP** to specify start and stop frequency.

Examples

```
SENS:CORR:EXT:AUTO:CONF CSPN
sense2:correction:extension:auto:config amkr
```

Query Syntax SENSe<num>:CORRection:EXTension:AUTO:CONFIg ?

Return Type Character

Default CSPN

SENSe<cnum>:CORRection:EXTension:AUTO:DCOFFset <bool>

Applicable Models: All

(Read-Write) Specifies whether or not to include DC Offset as part of automatic port extension. [Learn more about Automatic DC Offset](#). Only allowed when **SENS:CORR:EXT:AUTO:LOSS** is set to ON.

Parameters

- <cnum> Any existing channel number. If unspecified, value is set to 1
- <bool> ON (or 1) - Includes DC Offset correction.
OFF (or 0) - Does NOT include DC Offset correction.

Examples

```
SENS:CORR:EXT:AUTO:DCOF 1  
sense2:correction:extension:auto:dcoffset off
```

Query Syntax SENSe<cnum>:CORRection:EXTension:AUTO:DCOFFset?

Return Type Boolean

Default OFF (0)

SENSe<cnum>:CORRection:EXTension:AUTO:LOSS <bool>

Applicable Models: All

(Read-Write) Specifies whether or not to include loss correction as part of automatic port extension. [Learn more about Loss Compensation](#) in port extension.

Parameters

- <cnum> Any existing channel number. If unspecified, value is set to 1
- <bool> ON (or 1) - Includes Loss correction.
OFF (or 0) - Does NOT include Loss correction.

Examples

```
SENS:CORR:EXT:AUTO:LOSS 1  
sense2:correction:extension:auto:loss off
```

Query Syntax SENSe<cnum>:CORRection:EXTension:AUTO:LOSS?

Return Type Boolean

Default OFF (0)

SENSe<cnum>:CORRection:EXTension:AUTO:MEASure <char>

Applicable Models: All

(Write-only) Measures either an OPEN or SHORT standard. When this command is sent, the VNA acquires the measurement with which to set automatic port extensions. This command should be preceded by the CALCulate:PARAmeter:MNUMber <num> where num is the trace number of a measurement on the specified channel. [Learn more about which standard to measure.](#)

Parameters

<cnum> Any existing channel number. If unspecified, value is set to 1

<char> Standard to be measured. Choose from:

OPEN Measure OPEN standard

SHORT Measure SHORT standard

Examples

```
SENS:CORR:EXT:AUTO:MEAS OPEN  
sense2:correction:extension:auto:measure short
```

Query Syntax Not Applicable

Default Not Applicable

SENSe<cnum>:CORRection:EXTension:AUTO:PORT<n> <bool>

Applicable Models: All

(Read-Write) Enables and disables automatic port extensions on the specified port.

Parameters

<cnum> Any existing channel number. If unspecified, value is set to 1

<n> VNA Port number to enable or disable for automatic port extensions.

<bool> ON (or 1) - Enable

OFF (or 0) - Disable

Examples

```
SENS:CORR:EXT:AUTO:PORT2 0  
sense2:correction:extension:auto:port4 on
```

Query Syntax SENSe<cnum>:CORRection:EXTension:AUTO:PORT<n>?

Return Type Boolean

Default All ports ON (enabled)

SENSe<cnum>:CORRection:EXTension:AUTO:RESet

Applicable Models: All

(Write-only) Clears old port extension delay and loss data in preparation for acquiring new data. Send this command prior to sending a new series of **SENS:CORR:EXT:AUTO:MEAS**. If acquiring both OPEN and SHORT standards, do not send this command between those acquisitions.

Parameters

<cnum> Any existing channel number. If unspecified, value is set to 1

Examples

```
SENS:CORR:EXT:AUTO:RES  
sense2:correction:extension:auto:reset
```

Query Syntax Not Applicable

Default Not Applicable

SENSe<cnum>:CORRection:EXTension:AUTO:STARt <value>

Applicable Models: All

(Read-Write) Set the start frequency for custom user span. [Learn more about User Span.](#)

Parameters

<cnum> Any existing channel number. If unspecified, value is set to 1

<value> User span start value. Must be within the frequency range of the active channel and less than the value set by SENS:CORR:EXT:AUTO:STOP.

Examples

```
SENS:CORR:EXT:AUTO:STAR 1E9  
sense2:correction:extension:auto:start 200e6
```

Query Syntax SENSe<cnum>:CORRection:EXTension:AUTO:STARt <value>?

Return Type Numeric

Default Start frequency of the current active channel.

SENSe<cnum>:CORRection:EXTension:AUTO:STOP <value>

Applicable Models: All

(Read-Write) Set the stop frequency for custom user span. [Learn more about User Span.](#)

Parameters

- <cnm> Any existing channel number. If unspecified, value is set to 1
- <value> User span stop value. Must be within the frequency range of the active channel and greater than the value set by SENS:CORR:EXT:AUTO:START

Examples

```
SENS:CORR:EXT:AUTO:STOP 1E9  
sense2:correction:extension:auto:stop 200e6
```

Query Syntax SENSE<cnm>:CORRection:EXTension:AUTO:STOP <value>?

Return Type Numeric

Default Stop frequency of the current active channel.

SENSe<cnm>:CORRection:EXTension:PORT<pnum>:DISTance <value>

Applicable Models: All

(Read-Write) Sets and returns the port extension delay in physical length (distance).

Parameters

- <cnm> Any existing channel number. If unspecified, value is set to 1.
- <pnum> Port Number that will receive the delay setting. If unspecified, value is set to 1.
- <value> Physical length of fixture of added transmission line. First specify units with [SENS:CORR:EXT:PORT:UNIT](#).

Examples

```
SENS:CORR:EXT:PORT1:DIST 12  
sense2:correction:extension:port2:distance .003
```

Query Syntax SENSE<cnm>:CORRection:EXTension:PORT<pnum>:DISTance?

Return Type Numeric

Default 0

SENSe<cnm>:CORRection:EXTension:PORT<pnum>:FREQuency<n> <value>

Applicable Models: All

(Read-Write) Sets and returns the frequency for the Freq and Loss pair number and for the specified port number.

[Learn about Loss Compensation values.](#)

Parameters

- <cnum> Any existing channel number. If unspecified, value is set to 1
- <pnum> Port Number that will receive the freq/loss settings. If unspecified, value is set to 1.
- <n> Freq and Loss pair number. Choose from 1 or 2. If unspecified, value is set to 1.
- <value> Frequency value. Choose a frequency within the frequency span of the VNA.

Examples

```
SENS:CORR:EXT:PORT1:FREQ1 10E9  
sense2:correction:extension:port2:freq2 2E10
```

Query Syntax SENSE<cnum>:CORRection:EXTension:PORT<pnum>:FREQuency<n>?

Return Type Numeric

Default 1 GHz

SENSe<cnum>:CORRection:EXTension:PORT<pnum>:INCLude<n>[:STATe] <bool>

Applicable Models: All

(Read-Write) Sets and returns the ON/OFF state for the Freq and Loss pair number and for the specified port number.

[Learn about Loss Compensation values.](#)

Note: This command affects ALL measurements on the specified channel.

Parameters

- <cnum> Any existing channel number. If unspecified, value is set to 1
- <pnum> Port Number that will receive the Freq/Loss settings. If unspecified, value is set to 1.
- <n> Freq and Loss pair. Choose from 1 or 2. If unspecified, value is set to 1.

<value> State of Freq and Loss values for port extension.

0 or OFF Specified Freq and Loss values are OFF

1 or ON Specified Freq and Loss values are ON

Examples

```
SENS:CORR:EXT:PORT:INCL 0  
sense2:correction:extension:port2:include2:state on
```

Query Syntax SENSE<cnm>:CORRection:EXTension:PORT<pnum>:INCLude[:STATe]?

Return Type Boolean

Default OFF

SENSe<cnm>:CORRection:EXTension:PORT<pnum>:LDC <value>

Applicable Models: All

(Read-Write) Sets and returns the Port Loss at DC value for the specified port number.

[Learn about Loss Compensation values.](#)

Note: This command affects ALL measurements on the specified channel.

Parameters

<cnm> Any existing channel number. If unspecified, value is set to 1

<pnum> Port number to receive Loss value. If unspecified, value is set to 1.

<value> Loss in dB. Choose a value between -90 and 90

Examples

```
SENS:CORR:EXT:PORT:LDC 1.5  
sense2:correction:extension:port2:ldc .1
```

Query Syntax SENSE<cnm>:CORRection:EXTension:PORT<pnum>:LDC?

Return Type Numeric

Default 0

SENSe<cnm>:CORRection:EXTension:PORT<pnum>:LOSS<n> <value>

Applicable Models: All

(Read-Write) Sets and returns the Loss value for the specified port number.

[Learn about Loss Compensation values.](#)

Note: This command affects ALL measurements on the specified channel.

Parameters

- <num> Any existing channel number. If unspecified, value is set to 1
- <pnum> Port Number that will receive the Freq/Loss settings. If unspecified, value is set to 1.
- <n> Loss "Use" number. Choose from 1 or 2. If unspecified, value is set to 1.
- <value> Loss in dB. Choose a value between -90 and 90

Examples

```
SENS:CORR:EXT:PORT:LOSS1 1  
sense2:correction:extension:port2:loss2 .1
```

Query Syntax SENSE<num>:CORRection:EXTension:PORT<pnum>:LOSS<n>?

Return Type Numeric

Default 0

SENSe<num>:CORRection:EXTension:PORT<pnum>:MEDium <char>

Applicable Models: All

(Read-Write) Sets and returns the media type of the added fixture or transmission line.

See also [SENS:CORR:EXT:PORT:SYSMedia](#)

Note: This command affects ALL measurements on the specified channel.

Parameters

- <num> Any existing channel number. If unspecified, value is set to 1
- <pnum> Port Number for which media type is being set. If unspecified, value is set to 1.
- <char> Medium type. Choose from:
 - COAX
 - WAVEguide

Examples

```
SENS:CORR:EXT:PORT:MED COAX
```

```
sense2:correction:extension:port2:medium waveguide
```

Query Syntax

```
SENSe<cnum>:CORRection:EXTension:PORT<pnum>:MEDium?
```

Return Type

Character

Default

COAX

SENSe<cnum>:CORRection:EXTension:PORT:SYSMedia <bool>

Applicable Models: All

(Read-Write) Sets and returns the state of coupling with the system Media type. [Learn more.](#)

Note: This command potentially affects ALL measurements on the VNA.

Parameters

<cnum> Any existing channel number. If unspecified, value is set to 1

<bool> Coupling state. Choose from:

- **ON** (or 1) - Media type is coupled with the system setting.
- **OFF** (or 0) - Media type is NOT coupled with the system setting.

Examples

```
SENS:CORR:EXT:PORT:SYSM 1
```

```
sense2:correction:extension:port:sysmedia off
```

Query Syntax

```
SENSe<cnum>:CORRection:EXTension:PORT:SYSMedia?
```

Return Type

Boolean

Default

1 or ON (Coupled)

SENSe<cnum>:CORRection:EXTension:PORT<pnum>:SYSVelocity <bool>

Applicable Models: All

(Read-Write) Sets and returns the state of coupling with the system Velocity Factor value. [Learn more.](#)

Note: This command potentially affects ALL measurements on the VNA.

Parameters

- <cnum> Any existing channel number. If unspecified, value is set to 1
- <pnum> Port Number for which system Velocity Factor coupling is being set. If unspecified, value is set to 1.
- <bool> Coupling state. Choose from:
 - **ON** (or 1) - Velocity Factor is coupled with the system setting.
 - **OFF** (or 0) - Velocity Factor is NOT coupled with the system setting.

Examples

```
SENS:CORR:EXT:PORT:SYSV 1
sense2:correction:extension:port2:sysvelocity off
```

Query Syntax SENSE<cnum>:CORRection:EXTension:PORT<pnum>:SYSVelocity?

Return Type Boolean

Default 1 or ON (Coupled)

SENSe<cnum>:CORRection:EXTension:PORT<pnum>[:TIME] <num>

Applicable Models: All

(Read-Write) Sets the extension delay value in time at the specified port. Must also set **SENS:CORR:EXT ON.**

Note: This command affects ALL measurements on the specified channel.

Parameters

- <cnum> Any existing channel number. If unspecified, value is set to 1
- <pnum> Port Number that will receive the extension. If unspecified, value is set to 1.
- <num> The port extension in seconds; may include suffix. Choose a number between: -1E18 and 1E18

Examples

```
SENS:CORR:EXT:PORT 2MS
sense2:correction:extension:port2 .00025
```

Query Syntax SENSe<cnum>:CORRection:EXTension:PORT<pnum> [:TIME]?

Return Type Numeric

Default 0

SENSe<num>:CORRection:EXTension:PORT:UNIT <char>

Applicable Models: All

(Read-Write) Sets and returns the units for specifying port extension delay in physical length (distance).

Parameters

<num> Any existing channel number. If unspecified, value is set to 1.

<char> Units for delay in distance. Choose from:

- METer
- FEET
- INCH

Examples

```
SENS:CORR:EXT:PORT:UNIT MET
sense2:correction:extension:port:unit inch
```

Query Syntax SENSe<num>:CORRection:EXTension:PORT:UNIT?

Return Type Character

Default METer

SENSe<num>:CORRection:EXTension:PORT<pnum>:VELFactor <value>

Applicable Models: All

(Read-Write) Sets and returns the velocity factor of the fixture or added transmission line.

Parameters

- <cnum> Any existing channel number. If unspecified, value is set to 1
- <pnum> Port Number for which velocity factor is being set. If unspecified, value is set to 1.
- <value> Velocity Factor.

Set **SENS:CORR:EXT:PORT:SYSV** to use the system velocity factor.

Examples

```
SENS:CORR:EXT:PORT:VELF .6  
sense2:correction:extension:port2:velfactor 1
```

Query Syntax SENSE<cnum>:CORRection:EXTension:PORT<pnum>:VELFactor?

Return Type Numeric

Default System Velocity Factor

SENSe<cnum>:CORRection:EXTension:PORT<pnum>:WGCutoff <value>

Applicable Models: All

(Read-Write) Sets and returns the cutoff (minimum) frequency of the added waveguide fixture or transmission line.

Parameters

- <cnum> Any existing channel number. If unspecified, value is set to 1
- <pnum> Port Number for which media type is being set. If unspecified, value is set to 1.
- <value> Cutoff frequency in Hz.

This value is ignored when **SENS:CORR:EXT:PORT:MED** is set to **COAX** for the same port.

Examples

```
SENS:CORR:EXT:PORT:WGC 1e8  
sense2:correction:extension:port2:wgcutoff 100Mhz
```

Query Syntax SENSe<cnum>:CORRection:EXTension:PORT<pnum>:WGCutoff?

Return Type Numeric

Default System Media Cutoff Frequency

SENSe<cnum>:CORRection:EXTension:RECeiver<Rnum>[:TIME] <num>

Applicable Models: N522xB, N523xB, N524xB, M937xA, P937xA

(Read-Write) Sets the extension value at the specified receiver. Must also set **SENS:CORR:EXT ON**.

Note: Before using this command you must select a measurement using **CALC:MEAS:DEFine**. You can select one measurement for each channel.

Parameters

- <cnum> Any existing channel number. If unspecified, value is set to 1
- <Rnum> Number of the receiver that will receive the extension. If unspecified, value is set to 1
Choose from:
 - 1 for Receiver A
 - 2 for Receiver B
- <num> The electrical length in seconds; may include suffix. Choose a number between:
-10 and 10

Examples

```
SENS:CORR:EXT:REC 2MS  
sense2:correction:extension:receiver2:time .00025
```

Query Syntax SENSe<cnum>:CORRection:EXTension:RECeiver<Rnum> [:TIME]?

Return Type Numeric

Default 0

SENSe<cnum>:CORRection:EXTension[:STATe] <ON | OFF>

Applicable Models: All

(Read-Write) Turns port extensions ON or OFF.

Parameters

<cnum> Any existing channel number. If unspecified, value is set to 1

<ON | OFF> **ON** (or 1) - turns port extensions ON.

OFF (or 0) - turns port extensions is OFF.

Examples

```
SENS:CORR:EXT ON  
sense2:correction:extension:state off
```

Query Syntax SENSE<cnum>:CORRection:EXTension[:STATe]?

Return Type Boolean (1 = ON, 0 = OFF)

Default OFF

Sense:Correction:Collect:Guided Commands

Performs and applies a SmartCal (Guided) calibration and other error correction features.

Important Notes:

- To perform a **Guided Calibration** , use ONLY Sens:Corr:Coll:Guided commands. See the "Guided" example programs for clarification.
- ALWAYS send ALL measurement setup commands BEFORE initializing a remote calibration.

SENSe:CORRection:COLLect:GUIDed:

ABORt

ACQuire

ADAPter

| **COUNt**

| **ZERO**

| **CREate?**

| **DELay**

| **DESCRiption**

| **PATHs**

CHANnel:MODE

CKIT

| **CATalog?**

| **PORT**

| **CATalog?**

| **[SElect]**

CONNector

| **CATalog?**

| **PORT**

| **[SElect]**

DATA

| **CATalog?**

DESCRiption

ECal

| **ACQuire**

| **SElect**

ETERms

| **COMPut**

| **LOAD[:CSET]**

INITiate

ISOLation

| **AVERage**

| **INCRement**

| **PATHs**

ITERations

| **COUNT?**

| **MINimum?**

| **RESet**

LIST

| **COUNT?**

| **STEP**

| **COUNT?**

| **DESCription?**

| **LABEL?**

| **PORTs?**

| **STANDARD**

| **LABEL?**

| **PORTs?**

| **STYPE?**

| **TPORTs?**

| **STYPE?**

| **TPORTs?**

METHod

PACQuire

PATH

| **CMETHod**

[| TMEthod](#)
[PORTs?](#)
[PREFerence](#)
[| SLIDingload](#)
[PSENsor - More commands](#)
[SAVE](#)
[| CSET](#)
[SMC - More commands](#)
[STEPS?](#)
[THRU](#)

Click on a keyword to view the command details.

[Blue](#) keywords are superseded commands.

See Also

- ECal Orientation commands
- Examples using these commands.
- Calibrating the VNA Using SCPI
- Learn about Measurement Calibration
- Synchronizing the Analyzer and Controller

SENSe<ch>:CORRection:COLLEct:GUIDed:ABORt

Applicable Models: All

(Write-only) Aborts the acquiring of a guided calibration that has been INITIALIZED but has not yet been concluded using the SAVE command. If at least one Cal standard has already been measured, and the Calibration Window is being displayed, this command also closes the Calibration Window and re-tiles the other measurement windows.

Parameters

<ch> Channel being calibrated, depending on the CHAN:MODE setting. If unspecified, value is set to 1.

Examples

```
SENS:CORR:COLL:GUID:ABOR
sense2:correction:collect:guided:abort
```

Query Syntax Not Applicable

Default Not Applicable

SENSe:<ch>CORRection:COLLect:GUIDed[:ACQuire] STAN<n>[,sync]

Applicable Models: All

(Write-only) Initiates the measurement of the specified calibration standard. Executing this command with an unnecessary standard has no affect.

The measured data is stored and used for subsequent calculations of error correction coefficients. All standards must be measured before a calibration can be completed. Any measurement can be repeated until the SENS:CORR:COLL:GUID:SAVE command is executed.

Query the user prompt description using SENS:CORR:COLL:GUID:DESC?

Query the required calibration steps using SENS:CORR:COLL:GUID:STEP?

Parameters

- <ch> Channel being calibrated, depending on the CHAN:MODE setting. If unspecified, value is set to 1.
- STAN<n> Choose from:STAN1, STAN2, etc. through STANn where n is the number of cal standard connection steps for the calibration.

Note: You do not necessarily have to invoke these connection steps in sequential order, but you must issue this command for all of the steps to be able to complete the calibration.

[sync] Optional argument. Choose from:

SYNChronous - blocks SCPI commands during standard measurement (default behavior).

ASYNchronous - does NOT block SCPI commands during standard measurement.

Learn more about this argument

Examples

```
SENS:CORR:COLL:GUID STAN1  
sense2:correction:collect:guided:acquire stan1
```

Query Syntax Not Applicable

Default Not Applicable

SENSe<ch>:CORRection:COLLect:GUIDed:ADAPter:CREate? <conn1>, <conn2>

Applicable Models: All

(Read-only) Specifies the use of a THRU adapter to be used during the Guided Cal Unknown THRU and Adapter Removal Cal. Returns an adapter index <n> which is used to refer to the adapter in several related commands. See Cal Thru Methods. While the choice of which end of the adapter is <conn1> and <conn2> is arbitrary, it is necessary to remember which will be used on each test port.

The settings for this command remain until Preset, or the command is sent using a different setting, or until the ZERO command is sent.

Parameters

- <ch> Channel being calibrated, depending on the CHAN:MODE setting. If unspecified, value is set to 1.
- <conn1> Adapter port 1 connector type. Use SENS:CORR:COLL:GUID:CONN:CAT? to return a list of valid connector types.
- <conn2> Adapter port 2 connector type.

Examples See example using this command.

Return Type Numeric

Default Not Applicable

SENSe<ch>:CORRection:COLLect:GUIDed:ADAPter:COUNT?

Applicable Models: All

(Read-Only) Returns the number of THRU adapters that have been created for this calibration using SENS:CORR:COLL:GUID:ADAP:CREate .

Parameters

- <ch> Channel being calibrated, depending on the CHAN:MODE setting. If unspecified, value is set to 1.

Examples See example using this command.

Return Type Numeric

Default Not Applicable

SENSe:<ch>CORRection:COLLect:GUIDed:ADAPter:COUNT:ZERO

Applicable Models: All

(Write-only) Removes all adapters that have been defined for calibrations on the specified channel using SENS:CORR:COLL:GUID:ADAP:CREate .

Parameters

<ch> Channel being calibrated, depending on the CHAN:MODE setting. If unspecified, value is set to 1.

Examples

```
SENS:CORR:COLL:GUID:ADAP:COUNT:ZERO  
sense2:correction:collect:guided:adapter:count:zero
```

Query Syntax Not Applicable

Default Not Applicable

SENSe<ch>:CORRection:COLLEct:GUIDed:ADAPter<n>:DELAy <coax>, [w phase, wdelay]

Applicable Models: All

(Write-only) Specifies the adapter delay. and optionally waveguide delay and optional phase offset (degrees) of adapter <n>.

The settings for this command remain until Preset, or the command is sent using a different setting, or until the ZERO command is sent.

Parameters

<ch> Channel being calibrated, depending on the CHAN:MODE setting. If unspecified, value is set to 1.

<n> Adapter index number that was returned from SENS:CORR:COLL:GUID:ADAP:CREate?

<coax> Delay value of coax adapter <n> in seconds. If the adapter has no coax connector, enter 0.

<wphase> Waveguide phase offset in degrees. If the adapter has no waveguide connector, do not enter a value.

<wdelay> Waveguide delay in seconds. If the adapter has no waveguide connector, do not enter a value.

Examples

```
See example using this command.
```

Default Not Applicable

SENSe<ch>:CORRection:COLLEct:GUIDed:ADAPter<n>:DESCRiption <string>

Applicable Models: All

(Write-only) Specifies the adapter description for use as the guided cal connection prompts.

The settings for this command remain until Preset, or the command is sent using a different setting, or until the ZERO command is sent.

Parameters

- <ch> Channel being calibrated, depending on the CHAN:MODE setting. If unspecified, value is set to 1.
- <n> Adapter index number that was returned from SENS:CORR:COLL:GUID:ADAP:CREate?
- <string> Adapter description.

Examples

See example using this command.

Query Syntax Not Applicable

Default Not Applicable

SENSe<ch>:CORRection:COLLEct:GUIDed:ADAPter<n>:PATHs <port pairs>

Applicable Models: All

(Write-only) Specifies the port pairs for which the adapter will be used for a THRU connection.

For example, for a 3-port cal on channel 1 using ports 1,2,and 3), to use adapter 1 between the ports (1 to 2) and (1 to 3) the following command is used: SENS1:CORR:COLL:GUID:ADAP1:PATH 1,2,1,3.

The adapter must have the same DUT connectors as the ports that are already specified for these ports.

The settings for this command remain until Preset, or the command is sent using a different setting, or until the ZERO command is sent.

Parameters

- <ch> Channel being calibrated, depending on the CHAN:MODE setting. If unspecified, value is set to 1.
- <n> Adapter index number that was returned from SENS:CORR:COLL:GUID:ADAP:CREate?
- <port pair> Ports for which the adapter will be used. The orientation is not critical, as the VNA will align the connector types as necessary. The minimum number of Thru connections required is the number of ports to calibrated -1.

Examples See example using this command.

Query Syntax Not Applicable

Default Not Applicable

SENSe:CORRection:COLLect:GUIDed:CHANnel:MODE <bool>

Applicable Models: All

(Read-Write) Determines whether or not to honor the channel <ch> argument in guided calibration SCPI commands.

Parameters

<bool> **OFF (0)** Honor all <ch> arguments. This means the <ch> channel is calibrated regardless of which channel is currently active.

ON (1) Legacy behavior. Behavior is specified by the following table:

<ch> channel type Std or App	Active channel type Std or App	Behavior
Std	Std	Active chan cal'd
Std	App	"Channel not found" error
App	Std	<ch> chan cal'd
App	App	<ch> chan cal'd

Learn about Standard vs Application channels.

Examples `SENS:CORR:COLL:GUID:CHAN:MODE 0`

`sense:correction:collect:guided:channel:mode ON`

Query Syntax `SENSe:CORRection:COLLect:GUIDed:CHANnel:MODE?`

Return Type Boolean

Default OFF - This is the default beginning with A.09.50

ON - Default before A.09.50

SENSe:CORRection:COLLect:GUIDed:CKIT:CATalog? <connector>

Applicable Models: All

(Read-only) This command replaces SENS:CORR:COLL:GUID:CKIT:PORT:CAT?

Returns a comma-separated list of valid kits that use the specified connector type. This includes mechanical cal kits, applicable characterizations found within ECal modules currently connected to the VNA, **and all user characterizations stored in VNA disk memory.** For ECal modules, the returned list includes the serial numbers. See ECal User Characterization commands.

Use items in the list to select the kit to be used with the SENS:CORR:COLL:GUID:CKIT:PORT and SENSE<ch>:CORRection:COLLect:GUIDed:PSENsor<pnum>:CKIT commands.

Parameters

<conn> String. Connector type. Use SENS:CORR:COLL:GUID:CONN:CAT? to return a list of valid connector types.

Examples

```
SENSe:CORR:COLL:GUID:CKIT:CAT? "Type N (50) male"
```

Return Type

String

Default

Not Applicable

SENSe:CORRection:COLLect:GUIDed:CKIT:PORT<pnum>:CATalog? **Superseded**

Applicable Models: All

(Read-only) This command is replaced by SENSE:CORR:COLL:GUID:CKIT:CAT?.

Returns a comma-separated list of valid kits for the specified VNA port. In addition to mechanical calibration kits, this will include applicable characterizations found within ECal modules currently connected to the VNA.

Use items in the list to select the kit to be used with the SENS:CORR:COLL:GUID:CKIT:PORT command.

Note: The serial number is returned for ALL ECal modules that are connected with the connector type of the specified port. Previously, the returned list would include the serial numbers to distinguish the ECal modules only when two or more identical ECal models were connected to the VNA.

Parameters

<pnum> Any existing port number. If unspecified, value is set to 1

Examples

```
SENS:CORR:COLL:GUID:CKIT:PORT1:CAT?
'When "Type N (50) male" is specified for connector type,
returns:
"85054D, 85032F"
```

```
'When two identical ECal modules are connected for the connector
type,
'the return string includes serial numbers

"85092-60010 ECal 10675, 85092-60010 ECal 00758"
```

Return Type String

Default Not Applicable

SENSe<ch>:CORRection:COLLect:GUIDed:CKIT:PORT<pnum>[:SElect] <kit>

Applicable Models: All

(Read-Write) Specifies the calibration kit (mechanical or ECal) for each port to be used during a guided calibration. An unused port does NOT need to have a specified Cal Kit.

1. Specify the connector type for the port with SENS:CORR:COLL:GUID:CONN:PORT.
2. Query the valid available kits for the connector on each port with SENS:CORR:COLL:GUID:CKIT:PORT:CAT?
3. Specify the kit using this command.
4. Perform a query of this command. If the <kit> parameter was incorrectly entered, an error will be returned.

When using this command to specify the cal kit for the output of a VMC calibration mixer, specify port 3. If port 3 is already used for the output of the DUT mixer, then specify port 4. [Learn more.](#)

Parameters

- <ch> Channel being calibrated, depending on the CHAN:MODE setting. If unspecified, value is set to 1.
- <pnum> Any existing port number. If unspecified, value is set to 1
- <kit> Calibration kit to be used for the specified port. **Case-sensitive.**

When using an ECal module, include the characterization name in the <kit> string. Use SENSE:CORR:COLL:GUID:CKIT:CAT? to read the list of characterizations available in the module and in VNA disk memory.

If two or more identical ECal modules are connected to the VNA, the serial number must be included to distinguish the ECal modules.

Examples

```
'Note: All of the following examples specify port 1 only
' Mechanical Cal kit

SENS:CORR:COLL:GUID:CKIT:PORT1 '85055A'
```



```

' Standard ECal modules
SENS:CORR:COLL:GUID:CKIT:PORT1 "N4691-60004 ECal"
' Non-factory ECal characterizations are specified as follows:
SENS:CORR:COLL:GUID:CKIT:PORT1 "N4691-60004 User 1 ECal"
' When two or more ECal modules with the same model number are
' connected, also specify the serial number as follows:
SENS:CORR:COLL:GUID:CKIT:PORT1 "N4691-60004 ECal 01234"
' When Disk Memory ECal user characterizations are used,
' specify both the User char and the serial number as follows:
SENS:CORR:COLL:GUID:CKIT:PORT1 "N4691-60004 MyDskChar ECal
01234"

```

Query Syntax SENSE:CORRection:COLLect:GUIDed:CKIT:PORT<pnum>[:SElect]?

Return Type String - If the <kit> parameter was incorrectly entered while writing, an error will be returned.

Default Not Applicable

SENSe:CORRection:COLLect:GUIDed:CONNector:CATalog?

Applicable Models: All

(Read only) Returns a list of valid connectors based on the connector descriptions of the available cal kits. Use an item from the returned list to specify a connector for

SENS:CORR:COLL:GUID:CONN:PORT

Here are the more common connector types:

W-band waveguide	Type B	1.00 mm female
V-band waveguide	Type A (50) female	1.00 mm male
U-band waveguide	Type A (50) male	1.85 mm male
R-band waveguide	Type F (75) female	1.85 mm female
Q-band waveguide	Type F (75) male	2.92 mm female
K-band waveguide	Type N (75) female	2.92 mm male
P-band waveguide	Type N (75) male	APC 2.4 female
X-band waveguide	Type N (50) female	APC 2.4 male
7-16 female	Type N (50) male	APC 3.5 female
7-16 male		APC 3.5 male
		APC 7

Examples

```
SENS:CORR:COLL:GUID:CONN:CAT?
```

Returns:

```
Type N (50) female, Type N (50) male, APC 7 (50), 3.5 mm (50)
male, 3.5 mm (50) female, User Connector A
```

Return Type Comma separated string values

Default Not Applicable

SENSe<ch>:CORRection:COLLect:GUIDed:CONNector:PORT<pnum>[:SElect] <conn>

Applicable Models: All

(Read-Write) Specifies a DUT connector type for every port during the Guided Calibration procedure. Valid DUT connector names are stored within calibration kits. Some cal kits may include both male and female DUT connectors. Therefore, specifying the DUT connector gender may be required.

The VNA remembers previous Guided Cal settings. Therefore, for completeness, unused ports can either be defined as "Not used" or use the SENS:CORR:COLL:GUID:ABORt command to clear all ports. The ABORt command is a more thorough approach and more convenient. See Guided Cal examples.

- A single port with a valid <conn> name indicates a 1-Port calibration will be performed.
- Two ports with valid <conn> names indicate either a 2-Port SOLT or TRL calibration will be performed depending on the standards definition found within the cal kit and the capability of the VNA.
- Three ports with valid <conn> names indicate a 3-Port calibration will be performed, and so forth.

Follow these steps to ensure port connectors are specified correctly:

1. Use SENS:CORR:COLL:GUID:CONN:CAT? to query available connectors before specifying the port connector.
2. Set a connector type for each port using this command.
3. Perform a query of this command. If the connector type was incorrectly entered, an error will be returned.
4. Specify the cal kit to use for each port with SENS:CORR:COLL:GUID:CKIT:PORT

Parameters

<ch> Channel being calibrated, depending on the CHAN:MODE setting. If unspecified, value is set to 1.

<pnum> Any existing port number. If unspecified, value is set to 1.

<conn> String - DUT connector type to connect with VNA port <pnum>. **Case-sensitive.**

Examples

'Specifying a 2-port cal (1 & 2) on a 4-port VNA

```
SENS:CORR:COLL:GUID:CONN:PORT1 'Type N (50) female'
SENS:CORR:COLL:GUID:CONN:PORT2 'Type N (50) male'
SENS:CORR:COLL:GUID:CONN:PORT3 'Not used'
SENS:CORR:COLL:GUID:CONN:PORT4 'Not used'
```

Query Syntax SENSE:CORRection:COLLEct:GUIDed:CONNector:PORT<pnum>[:SElect]?

Return Type String

Default Not Applicable

SENSe<ch>:CORRection:COLLEct:GUIDed:DATA STAN<n>, <meas parameter>, [<ECal state num>]

Applicable Models: All

(Read-Write) Sets and returns the measurement data for a specified measurement parameter of a particular step of a guided cal (and for a specific state of an ECal if the step is an ECal step). The measurement data is complex real-and-imaginary pairs where the number of points is the current number of points on the channel, and is in ASCII or binary format as dictated by the current setting of the FORMat:DATA command.

Note: This command only applies to cals of standard S-parameter channels.

Parameters

<ch> Any existing channel number. If unspecified, value is set to 1.

STAN<n> Choose from:STAN1, STAN2, etc. through STANn where n is the number of cal standard connection steps for the calibration.

Note: You do not necessarily have to invoke these connection steps in sequential order.

<meas parameter> Measurement parameters for standard S-parameter channels.

[<ECal state num>] ECal state number.

Examples

See an example that uses this command.

Query Syntax SENSE:CORRection:COLLEct:GUIDed::DATA? STAN<n>, <meas parameter>, [<ECal state num>]

Return Type Depends on FORMat:DATA

Default Not Applicable

SENSe<ch>:CORRection:COLLEct:GUIDed:DATA:CATalog? STAN<n>

Applicable Models: All

(Read-only) Returns a comma-delimited string of measurement parameters that have to be measured in the specified step number of a guided calibration.

Note: This command only applies to calcs of standard S-parameter channels.

Parameters

- <ch> Any existing channel number. If unspecified, value is set to 1.
- STAN<n> Choose from:STAN1, STAN2, etc. through STANn where n is the number of cal standard connection steps for the calibration.

Note: You do not necessarily have to invoke these connection steps in sequential order.

Examples

```
SENS:CORR:COLL:GUID:DATA:CAT? STAN1  
See an example that uses this command.
```

Return Type String

Default Not Applicable

SENSe<ch>:CORRection:COLLEct:GUIDed:DESCription? <step>

Applicable Models: All

(Read-only) Returns the connection description for the specified calibration step.

Parameters

- <ch> Channel being calibrated, depending on the CHAN:MODE setting. If unspecified, value is set to 1.
- <step> A number from 1 to the number of steps required to complete the calibration (Use SENS:CORR:COLL:GUID:STEP? to query the number of steps)

Examples

```
SENS:CORR:COLL:GUID:DESC? 10  
  
'Returns:  
Connect APC 7 Open to port3
```

Return Type String

Default Not Applicable

SENSe<ch>:CORRection:COLLEct:GUIDed:ECAL:ACQ <cal method>. <port list>, [calset]

Applicable Models: All

(Write only) Execute the Ecal calibration with specified Ecal using `SENS:CORR:COLL:GUID:ECAL:SEL` . If ECal module is not specified, the first Ecal in the list is used. One item that we discussed is that this command needs to be overlapped. That's because it can be quite slow to finish an ecal, and slow operations need to be implemented using overlapped SCPI. Otherwise, the client will time out and will be unable to poll for completion. So, the command must be followed with either a `*OPC?` or a `*OPC` and serial poll.

Parameters

- `<ch>` Channel to be calibrated, depending on the `CHAN:MODE` setting. If unspecified, value is set to 1.
- `<cal method>` **String** Calibration Method.
- SOLT: using defined through
- SOLR: using undefined through
- ERESponse: Enhanced Response
- `<port list>` **Array** Port number to be calibrated. If enhanced response (ERESponse) is selected, the first port number is the stimulus port and the second port number is the response port.
- `[calset]` Optional argument. Cal Set name
- If NOT specified, behavior depends on the `SENS:CORR:PREFerence:CSET:SAVE` setting.

If specified, choose an **existing** Cal Set, either by name or by GUID.

- By Cal Set name: include quotes.
- Query all Cal Set GUIDs with `SENS:CORR:CSET:CAT?`

An error is reported if the Cal Set is not found.

The Cal Set is either supplemented or overwritten depending on the method, connectors, and ports selected. Learn more about Cal Sets.

Examples

```
' Full 2 port cal with defined through for ports 2 and 3
SENS:CORR:COLL:GUID:ECAL:ACQ SOLT,2,3

' Enhance Response Cal for ports 4 (Stimulus) and 1 (Response)
SENS:CORR:COLL:GUID:ECAL:ACQ ERES,4,1

' Full 2 port cal with calset and undefined through for ports 1
```

```
to 4
```

```
SENS:CORR:COLL:GUID:ECAL:ACQ SOLR,1,2,3,4,"MyCalSet"
```

Query Syntax Not Applicable

Default Not Applicable

SENSe<ch>:CORRection:COLLEct:GUIDed:ECAL[:SELEct] <ecal kit>

Applicable Models: All

(Read-Write) Specifies the Ecal Kit for Ecal Calibration. This is a new command that specifies the ECal kit to be used in the new 1-shot ECal execution command. If not specified, the 1-shot command will internally select the top one from the connected ECal kits (like the basic cal and start cal dialogs are doing.)

The top ecal kit in the list can be determined in two ways: by an internal module number that is dependent on the order in which the ecals are enumerated on the USB. Or it could be an alphabetical sorting by name. This default selection will allow the user to use generic test code but only if there is only one ECal connected.

Parameters

- <ch> Channel to be calibrated, depending on the CHAN:MODE setting. If unspecified, value is set to 1.
- <ecal kit> Ecal kit to be used for the specified port. **Case-sensitive.**

Include the characterization name in the <kit> string. Use SENSE:CORR:COLL:GUID:CKIT:CAT? to read the list of characterizations available in the module and in VNA disk memory.

If two or more identical ECal modules are connected to the VNA, the serial number must be included to distinguish the ECal modules.

Examples

```
' Standard ECal modules
SENS:CORR:COLL:GUID:ECAL "N4691-60004 ECal"
' Non-factory ECal characterizations are specified as follows:
SENS:CORR:COLL:GUID:ECAL "N4691-60004 User 1 ECal"
' When two or more ECal modules with the same model number are
' connected, also specify the serial number as follows:
SENS:CORR:COLL:GUID:ECAL "N4691-60004 ECal 01234"
```

```
' When Disk Memory ECal user characterizations are used,  
' specify both the User char and the serial number as follows:  
SENS:CORR:COLL:GUID:ECAL "N4691-60004 MyDskChar ECal 01234"
```

Query Syntax SENSE:CORRection:COLLect:GUIDed:ECAL[:SElect]?

Return Type String - If the <kit> parameter was incorrectly entered while writing, an error will be returned.

Default Not Applicable

SENSe<ch>:CORRection:COLLect:GUIDed:ETERms:COMPute [cal set name]

Applicable Models: All

(Write-only) Computes the error correction terms, turns Correction ON, and saves the calibration to an existing, specified Cal Set.

The cal acquisition process does not conclude as with the SAVE command. This command leaves the cal acquisition in memory to allow re-measuring/re-computing. To conclude the cal acquisition process, use the SENS:CORR:COLL:GUID:ABOR . command.

Learn all about Cal Sets.

Note: This command is NOT supported for application channels (Gain Compression, SMC/VMC, Noise Figure, IMD and so forth). Use SENS:CORR:COLL:GUID:SAVE and save to a cal register. You can then use SENS:CORR:CSET:COPY to copy the cal register to a named Cal Set.

- Use this command instead of specifying the optional name or GUID argument in SENS:CORR:COLL:GUID:INIT .
- Use SENS:CORRection:CSET commands to get names of existing Cal Sets.
- The cal data is also saved to the channel Cal Register.
- If all of the required standards have not been measured, the calibration will not complete properly.

For Calibrate All Channels

When this command is used during a Cal All session, the <cal set name> argument sets the User Cal Set prefix. All generated Cal Sets will be preceded with this string name.

- Cal Set prefix can also be set using SYST:CAL:ALL:CSET:PREFix . When the Cal Set prefix has already been set with SYST:CAL:ALL:CSET:PREFix , this command overwrites it.
- When <cal set name> is an empty string, a User Cal Set will not be saved. Only Cal Registers will be

saved.

Parameters

- <ch> Channel being calibrated, depending on the CHAN:MODE setting. If unspecified, value is set to 1.
- <cal set name> **String** - Name of an existing Cal Set to be overwritten.

See Calibrate All Channels note (above).

Examples

```
SENS:CORR:COLL:GUID:ETER:COMP "{2B893E7A-971A-11d5-8D6C-00108334AE96}"  
  
sense:correction:collect:guided:eterms:compute "MyCalSet"
```

Query Syntax Not Applicable

Default Not Applicable

SENSe<ch>:CORRection:COLLEct:GUIDed:ETERms:LOAD[:CSET] <cset>,<calPort> [,csPort]

Applicable Models: All

(Write-only) Loads 1-port error terms from a Cal Set into the current Guided Cal sequence. When the Cal steps are recomputed, connection steps are removed due to the loading of the error terms.

This command must be sent after the INIT command. This command was implemented to facilitate calibrating a large matrix of external ports and most users will not need to use this command.

See example of how to use this command.

Parameters

- <ch> Channel being calibrated, depending on the CHAN:MODE setting. If unspecified, value is set to 1.
- <cset> **String** Name of User Cal Set in which the error terms reside.
- <pnum> **Integer** Port number of the current cal to receive error terms.
- [csPort] **Integer** Optional argument. Port number associated with the error terms in the Cal Set. If unspecified, the same port number as <calPort> is used.

Examples See example

Query Syntax Not Applicable

Default Not Applicable

SENSe<ch>:CORRection:COLLEct:GUIDed:INITiate[:IMMEDIATE] [string][, bool][,char]

Applicable Models: All

(Write-only) Initiates a guided calibration.

- The VNA determines the measurements needed to perform the calibration using the settings specified from the SENS:CORR:COLL:GUID:CONN:PORT and SENS:CORR:COLL:GUID:CKIT:PORT commands.
- After this command is executed, subsequent commands can be used to query the number of measurement steps, issue the acquisition commands, query the connection description strings, and subsequently complete a guided calibration. See example calibration programs .

Parameters

<ch> Channel to be calibrated, depending on the CHAN:MODE setting. If unspecified, value is set to 1.

[string] Optional argument. Cal Set name or GUID enclosed in quotes.

If NOT specified, behavior depends on the SENS:CORR:PREFeRence:CSET:SAVE setting.

If specified, choose an **existing** Cal Set, either by name or by GUID.

- By Cal Set name: include quotes.
- Query all Cal Set GUIDs with SENS:CORR:CSET:CAT?

An error is reported if the Cal Set is not found.

The Cal Set is either supplemented or overwritten depending on the method, connectors, and ports selected. Learn more about Cal Sets.

[bool] Optional argument. To set this argument, also set the first optional argument. See example below.

OFF (0) If Cal Set stimulus settings differ from the existing channel, do not change channel stimulus settings. The Cal Set is saved to the current setting of the SENS:CORR:PREF:CSET:SAVE command. This is the default setting if not specified.

ON (1) If Cal Set stimulus settings differ from the existing channel, change the channel stimulus settings to match the Cal Set settings.

[char] Optional argument. To set this argument, also set the first two optional arguments. See example below.

SYNChronous - blocks further SCPI commands while processing this command.. (default setting).

ASYNchronous - does NOT block further SCPI commands while processing this command.

Learn more about this argument

Examples

```
SENS:CORR:COLL:GUID:INIT
'set first optional argument
SENS:CORR:COLL:GUID:INIT "MyCalSet"
'set two optional arguments
SENS:CORR:COLL:GUID:INIT " ",1
'set all optional arguments
SENS:CORR:COLL:GUID:INIT "MyCalSet",1,ASYN
```

Query Syntax Not Applicable

Default Not Applicable

SENSe<ch>:CORRection:COLLEct:GUIDed:ISOLation:AVERage:INCRement <num>

Applicable Models: All

(Read-Write) Specifies amount to increment (increase) the channels averaging factor during measurement of isolation standards in a guided calibration.

Note: If the channel has averaging turned OFF and the value of <num> is greater than 1, averaging will be turned ON only during the isolation measurements and with the averaging factor equal to <num>.

Parameters

<ch> Channel being calibrated, depending on the CHAN:MODE setting. If unspecified, value is set to 1.

<num> Amount to increment the averaging factor for the isolation measurement. The maximum averaging factor for the channel is 65536 (2^{16}).

Examples

```
'Measure isolation on all paths for the cal
SENS:CORR:COLL:GUID:ISOL ALL
'Remove the port pairs 1-to-2 and 1-to-3 from the list of paths on
which to measure isolation
sense:correction:collect:guided:isolation:paths REMOVE,1,2,1,3
```

Query Syntax SENSE<ch>:CORRection:COLLect:GUIDed:ISOLation:AVERage:INCRement?

Return Type Numeric

Default 8 - If this command is NOT sent, but isolation is measured, then averaging will be turned ON with factor set to 8 during the isolation measurements.

SENSe<ch>:CORRection:COLLect:GUIDed:ISOLation[:PATHs] <char>[,<p1a, p1b, p2a, p2b>]

Applicable Models: All

(Read-Write) Specifies the paths (port pairs) to make isolation measurements on during a guided calibration.

Parameters

<ch> Channel being calibrated, depending on the CHAN:MODE setting. If unspecified, value is set to 1.

<char> **ALL** Measure isolation on all pairings of the ports that are to be calibrated.

NONE Do not measure isolation on any pairing of the ports to be calibrated. (Default behavior).

ADD Add one or more specific pairings of ports to the list of port pairings for which isolation will be measured.

REMove Remove one or more specific pairings of ports from the list of port pairings for which isolation will be measured. If many paths are to be measured, it may be easier to first send ALL, then REMove and specify the paths to remove.

<p1a, p2a...> For use when <char> is **ADD** or **REMove**.

Specify Port numbers in pairs:

- For 3-port cals, specify up to 3 pairs.
- For 4-port cals, specify up to 6 pairs.

p1a, p1b (Path1 - port A and port B)

p2a, p2b (Path2 - port A and port B)

p3a, p3b (Path3 - port A and port B)

Examples 'Measure isolation on all paths for the cal

```
SENS:CORR:COLL:GUID:ISOL ALL
```

```
'Remove the port pairs 1-to-2 and 1-to-3 from the list of paths  
on which to measure isolation
```

```
sense:correction:collect:guided:isolation:paths REMOVE,1,2,1,3
```

Query Syntax SENSE<ch>:CORRection:COLLect:GUIDed:ISOLation:PATHs?

Note: if isolation is not be measured on any of the paths, the query returns 0

Return Type Numeric

Default 0 - Isolation not measured on any paths.

SENSe<ch>:CORRection:COLLect:GUIDed:ITERations:COUNT? <step>

Applicable Models: All

(Read-only) Designed to be used for an iterative cal standard such as a sliding load, this command returns the number of iterative measurement acquisitions that has been made for the specified step.

Zero (0) is returned if the step has not yet been measured.

For most cal steps that have already been measured, this command returns 1.

Set SENS:CORR:COLL:GUID:PREF:SLID ITER to count acquisition steps.

Parameters

- <ch> Channel being calibrated, depending on the CHAN:MODE setting. If unspecified, value is set to 1.
 - <step> Guided Cal step number for which the acquisition number will be returned.
- Use SENS:CORR:COLL:GUID:STEP? to query the number of steps in the calibration.

Examples

```
SENS:CORR:COLL:GUID:ITER:COUN? 4
```

```
'Example return:
```

```
5
```

```
See example program
```

Return Type Numeric

Default Not Applicable

SENSe<ch>:CORRection:COLLEct:GUIDed:ITERations:MINimum? <step>

Applicable Models: All

(Read-only) Designed to be used for an iterative cal standard such as a sliding load, this command returns the minimum number of required iterative measurement acquisitions for the specified step.

For most connection steps this will return 1, but for an iterative cal standard such as a sliding load, it will return a number such as 5.

Set SENS:CORR:COLL:GUID:PREF:SLID ITER to count acquisition steps.

Parameters

- <ch> Channel being calibrated, depending on the CHAN:MODE setting. If unspecified, value is set to 1.
- <step> Guided Cal step number for which to return the number of iterative measurement acquisitions that have been made. Use SENS:CORR:COLL:GUID:STEP? to query the number of steps in the calibration.

Examples

```
SENS:CORR:COLL:GUID:ITER:MIN? 4
```

```
'Example return:
```

```
5
```

```
See example program
```

Return Type Numeric

Default Not Applicable

SENSe<ch>:CORRection:COLLEct:GUIDed:ITERations:RESet <step>

Applicable Models: All

(Write-only) Resets the specified guided cal connection step as unmeasured. This clears all previous measurements made for that step.

Parameters

- <ch> Channel being calibrated, depending on the CHAN:MODE setting. If unspecified, value is set to 1.
- <step> Guided Cal step number to reset. Use SENS:CORR:COLL:GUID:STEP? to query the number of steps in the calibration.

Examples

```
SENS:CORR:COLL:GUID:ITER:RESet? 4
```

See example program

Return Type Not Applicable

Default Not Applicable

SENSe<ch>:CORRection:COLLect:GUIDed:LIST:COUNT?

Applicable Models: All

(Read-only) Returns the number of measurement steps required to complete the current guided calibration. This command is the same as the SENS:CORR:COLL:GUID:STEP command.

Parameters

- <ch> Any existing channel number. If unspecified, value is set to 1.

Examples

```
SENS:CORR:COLL:GUID:LIST:COUN?
```

```
sense2:correction:collect:guided:list:count?
```

Return Type Numeric

Default 0

SENSe<ch>:CORRection:COLLect:GUIDed:LIST:STEP<ListCount>:COUNT?

Applicable Models: All

(Read-only) Returns the number of standards for step[n]. This is generally 1 unless the standard is an isolation standard or a composite standard.

Parameters

- <ch> Any existing channel number. If unspecified, value is set to 1.
- <ListCount> Step number from 1 to 1000.

Examples

```
SENS:CORR:COLL:GUID:LIST:STEP:COUN?  
sense2:correction:collect:guided:list:step1:count?
```

Return Type Numeric

Default 1

SENSe<ch>:CORRection:COLLEct:GUIDed:LIST:STEP<ListCount>:DESCription?

Applicable Models: All

(Read-only) Returns the step description.

Parameters

- <ch> Any existing channel number. If unspecified, value is set to 1.
- <ListCount> Step number from 1 to 1000.

Examples

```
SENS:CORR:COLL:GUID:LIST:STEP:DESC?  
sense2:correction:collect:guided:list:step1:description?
```

Return Type String

Default Not Applicable

SENSe<ch>:CORRection:COLLEct:GUIDed:LIST:STEP<ListCount>:LABel?

Applicable Models: All

(Read-only) Returns the label for the complete standard used in the step. If the standard is a composite standard, the label is for the composite device.

Parameters

- <ch> Any existing channel number. If unspecified, value is set to 1.
- <ListCount> Step number from 1 to 1000.

Examples

```
SENS:CORR:COLL:GUID:LIST:STEP:LAB?  
sense2:correction:collect:guided:list:step1:label?
```

Return Type String

Default Not Applicable

SENSe<ch>:CORRection:COLLEct:GUIDed:LIST:STEP<ListCount>:PORTs?

Applicable Models: All

(Read-only) Returns the number of ports on the standard used in the step. If the standard is a composite standard, the number of ports applies to the composite. So if the composite standard is an offset line connected to a load, the composite device is a 1 port device.

Parameters

- <ch> Any existing channel number. If unspecified, value is set to 1.
- <ListCount> Step number from 1 to 1000.

Examples

```
SENS:CORR:COLL:GUID:LIST:STEP:PORT?  
sense2:correction:collect:guided:list:step1:ports?
```

Return Type Numeric

Default Not Applicable

SENSe<ch>:CORRection:COLLEct:GUIDed:LIST:STEP<ListCount>:STANdard<StandardCount>:

Applicable Models: All

(Read-only) Returns the label for the one of the standards used in the step. If the step contains only a single standard, the response to this query is identical to
SENS:CORR:COLL:GUID:LIST:STEP:LAB?

Parameters

- <ch> Any existing channel number. If unspecified, value is set to 1.
- <ListCount> Step number from 1 to 1000.
- <StandardCount> Standard number from 1 to 3.

Examples

```
SENS:CORR:COLL:GUID:LIST:STEP:STAN:LAB?  
sense2:correction:collect:guided:list:step1:standard2:label?
```

Return Type String

Default Not Applicable

SENSe<ch>:CORRection:COLLEct:GUIDed:LIST:STEP<ListCount>:STANdard<StandardCount>:

Applicable Models: All

(Read-only) Returns the number of ports on one of the standard used in the step. If the step contains only a single standard, the response to this query is identical to
SENS:CORR:COLL:GUID:LIST:STEP:PORT?

Parameters

- <ch> Any existing channel number. If unspecified, value is set to 1.
- <ListCount> Step number from 1 to 1000.
- <StandardCount> Standard number from 1 to 3.

Examples

```
SENS:CORR:COLL:GUID:LIST:STEP:STAN:PORT?  
sense2:correction:collect:guided:list:step1:standard2:ports?
```

Return Type Numeric

Default Not Applicable

SENSe<ch>:CORRection:COLLEct:GUIDed:LIST:STEP<ListCount>:STANdard<StandardCount>:

Applicable Models: All

(Read-only) Returns the enumeration for the type of standard that describes one of the standard devices used in the step. If the step contains only a single standard, the response to this query is identical to SENS:CORR:COLL:GUID:LIST:STEP:STYP?

The following list of enumerations is currently defined:

OPEN | SHORt | LOAD | REFLection | THRU | LINE | ECAL | ISOLation | COMPosite | SENSor | PHASeref | MIXer

Parameters

- <ch> Any existing channel number. If unspecified, value is set to 1.
- <ListCount> Step number from 1 to 1000.
- <StandardCount> Standard number from 1 to 3.

Examples

```
SENS:CORR:COLL:GUID:LIST:STEP:STAN:STYP?  
sense2:correction:collect:guided:list:step1:standard2:stype?
```

Return Type Enumeration

Default OPEN

SENSe<ch>:CORRection:COLLect:GUIDed:LIST:STEP<ListCount>:STANdard<StandardCount>:

Applicable Models: All

(Read-only) Returns the list of VNA test ports to which one of the standards is attached. If the step contains only a single standard, the response to this query is identical to SENS:CORR:COLL:GUID:LIST:STEP:TPORts?

Parameters

- <ch> Any existing channel number. If unspecified, value is set to 1.
- <ListCount> Step number from 1 to 1000.
- <StandardCount> Standard number from 1 to 3.

Examples

```
SENS:CORR:COLL:GUID:LIST:STEP:STAN:TPOR?  
sense2:correction:collect:guided:list:step1:standard2:tports?
```

Return Type Numeric

Default Not Applicable

SENSe<ch>:CORRection:COLLect:GUIDed:LIST:STEP<ListCount>:STYPe?

Applicable Models: All

(Read-only) Returns the enumeration for the type of standard device used in the step.

The following list of enumerations is currently defined:

OPEN | SHORt | LOAD | REFLection | THRU | LINE | ECAL | ISOLation | COMPOSITE | SENSor | PHASeref | MIXer

Parameters

- <ch> Any existing channel number. If unspecified, value is set to 1.
- <ListCount> Step number from 1 to 1000.

Examples

```
SENS:CORR:COLL:GUID:LIST:STEP:STYP?  
sense2:correction:collect:guided:list:step1:stype?
```

Return Type Enumeration

Default OPEN

SENSe<ch>:CORRection:COLLEct:GUIDed:LIST:STEP<ListCount>:TPORts?

Applicable Models: All

(Read-only) Returns the list of VNA test ports to which the standard(s) in this step is attached.

Parameters

- <ch> Any existing channel number. If unspecified, value is set to 1.
- <ListCount> Step number from 1 to 1000.

Examples

```
SENS:CORR:COLL:GUID:LIST:STEP:TPOR?  
sense2:correction:collect:guided:list:step1:tports?
```

Return Type Numeric

Default Not Applicable

SENSe:CORRection:COLLEct:GUIDed:METHOD <char> **Superseded**

Applicable Models: All

This command is replaced with SENS:CORR:COLL:GUID:PATH:CMETHOD and SENS:CORR:COLL:GUID:PATH:TMETHOD.

(Read-Write) Selects from one of several algorithms available for performing the THRU portion of a guided calibration. Learn more about THRU methods.

Parameters

<char> **DEFAULT** - Informs guided calibrations to use the default algorithm when computing the number of needed standards acquisition steps. (default selection if omitted.)

ADAP - Use the adapter removal algorithm

FLUSH - Use with insertable devices.

UNKN - Use the Unknown THRU algorithm with calibrations for non-insertable devices.

DEFined - Use the THRU definition that you stored in the cal kit file, or ECal module.

TRL - Select TRL Cal Type for guided cals. Valid for "TRL ready" Cal Kits with properly assigned TRL cal classes.

SOLT - Select SOLT Cal Type for guided cals. Valid for any kit with properly assigned SOLT cal classes.

Examples

```
SENS:CORR:COLL:GUID:METH ADAP
sense:correction:collect:guided:method unkn
```

Query Syntax SENSE:CORRection:COLLEct:GUIDed:METhod?

Return Type Character

Default DEFAULT

SENSe<ch>:CORRection:COLLEct:GUIDed:PACQuire STAN<n>

Applicable Models: All

(Write-only) Show the Cal Window , and optionally one or more other specific windows before acquiring a Cal standard. This command will cause the Cal Window to display the specific measurements that are to be made for that particular Cal standard to facilitate the connection of standards.

Parameters

- <ch> Channel being calibrated, depending on the CHAN:MODE setting. If unspecified, value is set to 1.
- STAN<n> Choose from:STAN1, STAN2, etc. through STANn where n is the number of cal standard connection steps for the calibration.

Note: You do not necessarily have to invoke these connection steps in sequential order.

Examples

```
SENS:CORR:COLL:GUID:PACQuire STAN2  
sense:correction:collect:guided:pacquire STAN5
```

See an example that uses this command.

Query Syntax Not Applicable

Default Not Applicable

**SENSe<ch>:CORRection:COLLEct:GUIDed:PATH:CMETHod
<port1>,<port2>,<caltype1[,caltype2]>**

Applicable Models: All

Note: This command replaces SENS:CORR:COLL:GUID:METH.

(Read-Write) Specifies the calibration method for each port pair.

Note: Sending this command will overwrite the VNAs SmartCal determinations for the most accurate cal method for your connector settings and Cal Kits. Send this command ONLY if you have a deliberate reason for overwriting the SmartCal logic. You can send the query form of this command to learn the cal method determined by SmartCal.

See Thru Pairs Sequence to learn how to send this and other Thru commands.

After sending this command, send the query form to be sure that the command was accepted. If not, then the chosen Cal method is not compatible with the specified Thru method. For example, if the specified Thru method is Unknown Thru, an attempt to set Enhanced Response Cal should be

rejected.

Learn more about Thru Methods.

Parameters

- <ch> Channel being calibrated, depending on the CHAN:MODE setting. If unspecified, value is set to 1.
- <port1> First port of the pair to be calibrated.
- <port2> Second port of the pair to be calibrated.
- <caltype1[caltype2]> (String) Cal type for the port pair, enclosed in a single pair of quotes. NOT case-sensitive.

caltype1 Choose from:

- TRL
- SOLT
- QSOLTN
- EnhRespN
- TransRespN

For the last two arguments, replace **N** with the port to be used as the source port, which **MUST** be one of the port pair.

caltype2 **Optional argument. Use only when performing an adapter removal cal on the pair. This argument specifies the Cal type on the second port. Caltype1 then specifies the Cal type of the first port.**

Choose from the same arguments as caltype1.

Examples

```
SENS:CORR:COLL:GUID:PATH:CMETHOD 2,3,"QSOLT2"
```

```
sense:correction:collect:guided:path:cmethod 2,3,"solt,trl"
```

Query Syntax

```
SENSe<ch>:CORRection:COLLect:GUIDed:PATH:CMETHOD?  
<port1>,<port2>
```

If only one caltype is returned then its NOT adapter removal.

Return Type

String

Default

The most accurate Cal method for the current cal.

**SENSe<ch>:CORRection:COLLect:GUIDed:PATH:TMETHod
<port1>,<port2>,<thruType1[,thruType2]>**

Applicable Models: All

Note: This command replaces SENS:CORR:COLL:GUID:METH.

(Read-Write) Specifies the calibration **THRU** method for each port pair.

Note: Sending this command will overwrite the VNAs SmartCal determination for the thru method. Send this command **ONLY** if you have a deliberate reason for overwriting the SmartCal logic. You can send the query form of this command to learn the THRU method determined by SmartCal.

See Thru Pairs Sequence to learn how to send this and other Thru commands.

Learn more about Thru methods.

Parameters

- <ch> Channel being calibrated, depending on the CHAN:MODE setting. If unspecified, value is set to 1.
- <port1> First port of the port pair to be calibrated.
- <port2> Second port of the port pair to be calibrated.
- <thruType1[,thruType2]> (String) Thru methods for port pair, enclosed in a single pair of quotes. NOT case-sensitive.

thruType1 Calibration Thru method. Choose from:

- **Defined Thru** Measures a Thru for which there is a stored definition in the Cal kit of the lowest-numbered port of the pair. For example, if the port pair is 1,2, then the cal kit for port 1 **MUST** contain a Defined Thru.
- **Zero Thru** Measures a Zero length Thru, also known as Flush-Thru.
- **Undefined Thru** (Also known as Unknown Thru) A Thru type for which there is NOT a stored definition in the Cal Kit. Valid **ONLY** for SOLT cal type.
- **Undefined Thru using a Defined Thru** (ECal modules **ONLY**) Measures the internal Thru as an Unknown Thru.

thruType2 Optional argument. Use **ONLY** when Adapter Removal Cal is specified for the pair using SENS:CORR:COLL:GUID:PATH:CMETHod . When specifying ThruType2, this is the only valid argument: "**Defined Thru, Defined Thru**"

Examples

```
SENS:CORR:COLL:GUID:PATH:TMethod 2,3,"Zero Thru"
sense:correction:collect:guided:path:tmethod 2,3,"Defined Thru,Defined Thru"
```

Query Syntax

```
SENSe<ch>:CORRection:COLLect:GUIDed:PATH:TMETHOD?
<port1>,<port2>
```

Always returns two parts:

If the second part of the string is empty, adapter removal is NOT being performed.

If the string is "Defined Thru, Defined Thru", adapter removal IS being performed.

Return Type

String

Default

The most accurate Thru method for the current cal.

SENSe<ch>:CORRection:COLLect:GUIDed:PORTs?

Applicable Models: All

(Read-only) Returns the list of ports being calibrated by an active calibration session.

Parameters

<ch> Any existing channel number. If unspecified, value is set to 1.

Examples

```
SENS:CORR:COLL:GUID:PORT?
sense2:correction:collect:guided:ports?
```

Return Type

List of numbers

Default

Not Applicable

SENSe<ch>:CORRection:COLLect:GUIDed:PREFerence:SLIDingload <char>

Applicable Models: All

(Read-Write) Specifies the behavior for guided cal steps that involve a sliding load in a cal that is about to be performed. Send this command BEFORE sending the Guided INIT command.

Although the term 'Preference' is used in the command, this is NOT a VNA preference. This setting does NOT survive instrument preset or reboot. It remains ONLY for the duration of the Guided Cal.

Parameters

<char> Behavior when measurements of sliding load are acquired. Choose from:

DIALog - The Sliding load dialog box appears when the acquire command is received for a sliding load step. All slide positions are measured (with a user-interface prompt) from a single invocation of the acquire command.

ITERate - Each invocation of the acquire command for a sliding load step measures a single slide position and increments the slide position counter. No Move Sliding Load prompt is presented on the VNA screen.

Examples

```
SENS:CORR:COLL:GUID:PREF:SLID ITER
```

See example program

Query Syntax SENSE<ch>:CORRection:COLLEct:GUIDed:PREFeRence:SLIDingload?

Return Type Character

Default DIALog

SENSe<ch>:CORRection:COLLEct:GUIDed:SAVE[:IMMEDIATE] [bool]

Applicable Models: All

(Write-only) Completes the guided cal by computing the error correction terms, turning Correction ON, and saving the calibration to a Cal Set. If all of the required standards have not been measured, the calibration will not complete properly.

Learn all about Cal Sets.

Parameters

<ch> Channel being calibrated, depending on the CHAN:MODE setting. If unspecified, value is set to 1.

[bool] Optional argument. If unspecified, the default behavior is the current VNA preference setting of SENSE:CORRection:PREFeRence:CSET:SAVE .

OFF (0) Save cal data ONLY to a Cal Register.

ON (1) Save cal data to a Cal Register and a User Cal Set. The filename is automatically generated.

- For application channels (Gain Compression, SMC/VMC, Noise Figure, IMD and so forth), this command saves ONLY to a Cal Register. Use SENS:CORR:CSET:COPY to copy the cal register to a named calset.
- For a Calibrate All Channels session, this argument is ignored. Instead, use SYST:CAL:ALL:CSET:PREFIX .

Examples

```
SENS:CORR:COLL:GUID:SAVE  
sense2:correction:collect:guided:save:immediate 0
```

Query Syntax Not Applicable

Default Not Applicable

SENSe<ch>:CORRection:COLLEct:GUIDed:SAVE:CSET <cal set name or guid>

Applicable Models: All

(Write-only) Completes the guided cal by computing the error correction terms, turning Correction ON, and saving the calibration to an existing, specified Cal Set. This command performs the same function as SENSE:CORRection:COLLEct:GUIDed:SAVE , except this command allows the name or GUID of the Cal Set to be specified.

Learn all about Cal Sets.

Note: This command is NOT supported for application channels (Gain Compression, SMC/VMC, Noise Figure, IMD and so forth). Use SENS:CORR:COLL:GUID:SAVE and save to a cal register. You can then use SENS:CORR:CSET:COPY to copy the cal register to a named Cal Set.

- Use this command instead of specifying the optional name or GUID argument in SENS:CORR:COLL:GUID:INIT .
- Use SENS:CORRection:CSET commands to get names or GUIDs of existing Cal Sets.
- The cal data is also saved to the channel Cal Register.
- If all of the required standards have not been measured, the calibration will not complete properly.

For Calibrate All Channels

When this command is used during a Cal All session, the <cal set name> argument sets the User Cal Set prefix. All generated Cal Sets will be preceded with this string name.

- Cal Set prefix can also be set using SYST:CAL:ALL:CSET:PREFIX . When the Cal Set prefix has already been set with SYST:CAL:ALL:CSET:PREFIX , this command overwrites it.
- When <cal set name> is an empty string, a User Cal Set will not be saved. Only Cal Registers will be saved.

Parameters

<ch> Channel being calibrated, depending on the CHAN:MODE setting. If unspecified, value is set to 1.

<cal set name or guid> **String** - Name or GUID of an existing Cal Set to be overwritten. If specifying a GUID, curly brackets must be included.

See Calibrate All Channels note (above).

Examples

```
SENS:CORR:COLL:GUID:SAVE:CSET "{2B893E7A-971A-11d5-8D6C-00108334AE96}"
sense:correction:collect:guided:save:cset "MyCalSet"
```

Query Syntax Not Applicable

Default Not Applicable

SENSe<ch>:CORRection:COLLect:GUIDed:STEPs?

Applicable Models: All

(Read-only) Returns the number of measurement steps required to complete the current guided calibration. This command is sent after the SENS:CORR:COLL:GUID:INIT , SENS:CORR:COLL:GUID:CONN:PORT and SENS:CORR:COLL:GUID:CKIT:PORT commands.

Parameters

<ch> Any existing channel number. If unspecified, value is set to 1.

Examples

```
SENS:CORR:COLL:GUID:STEP?
sense2:correction:collect:guided:steps?
```

Return Type Numeric

Default Not Applicable

SENSe<ch>:CORRection:COLLect:GUIDed:THRU:PORTs <t1a, t1b, t2a, t2b, t3a, t3b...>

Applicable Models: All

(Read-Write) For calibrating more than 2-ports ONLY. Specifies the port pairs for the Thru connections of the calibration. Send the query form of this command to learn the Thru pairs determined by SmartCal.

Note: Sending this command will overwrite the VNAs SmartCal determinations for the thru ports. Send this command ONLY if you have a deliberate reason for overwriting the SmartCal logic.

See Thru Pairs Sequence to learn how to send this and other Thru commands.

Parameters

- <ch> Channel being calibrated, depending on the CHAN:MODE setting. If unspecified, value is set to 1.
- <t1a,t1b...> Always specify port numbers in pairs: For example: 1,2 or 1,2,1,3
- For 3-port cals, specify two or three pairs.
 - For 4-port cals, specify from three up to six pairs.

Examples

```
SENS:CORR:COLL:GUID:THRU:PORT 1,2,1,3,1,4 '4-port measurement
sense:correction:collect:guided:thru:ports 1,2,2,3 '3-port
measurement
```

Query Syntax SENSE<ch>:CORRection:COLLect:GUIDed:THRU:PORTs?

Return Type Numeric

Default Port pairings that were used in the previous cal.

THRU Pairs sequence

The SmartCal logic always determines the best calibration based on your specified connectors and ports.

The following three commands overwrite the SmartCal logic. Send these commands ONLY if you have a deliberate reason for overwriting the SmartCal logic.

- sens:corr:coll:guid:THRU:PORTS <p1, p2>
- sens:corr:coll:guid:path:tmet <p1,p2, thrutype>
- sens:corr:coll:guid:path:cmet <p1,p2, calmethod>

When sending one or more of these commands, they must be sent in the following sequence with the other commands listed here.

Note: The **GUID:INIT** command is sent before and after these commands.

1. SENS:CORR:COLL:GUID:CONN:PORT(N)
 2. SENS:CORR:COLL:GUID:CKIT:PORT (N)
 3. **SENS:CORR:COLL:GUID:INIT**
 4. SENS:CORR:COLL:GUID:THRU:PORTS <P1, P2>
 5. SENS:CORR:COLL:GUID:PATH:TMET <P1,P2, THRUTYPE>
 6. SENS:CORR:COLL:GUID:PATH:CMET <P1,P2, CALMETHOD>
 7. SENS:CORR:COLL:GUID:PATH:CMET ? <P1,P2> (RECOMMENDED)
 8. **SENS:CORR:COLL:GUID:INIT**
-

Sense:Couple Commands

SENSe:COUPle
|
PARAmeter
|
[STATe]

Click on a keyword to view the command details.

See Also

- [Example Programs](#)
 - [Synchronizing the Analyzer and Controller](#)
 - [SCPI Command Tree](#)
-

SENSe<cnum>:COUPle <ALL | NONE>

Applicable Models: All

(Read-Write) Sets the sweep mode as Chopped or Alternate.

[Learn about Alternate Sweep](#)

Parameters

<cnum> Any existing channel number; if unspecified, value is set to 1.

<ALL | NONE> **ALL** - Sweep mode set to Chopped - reflection and transmission measured on the same sweep.

NONE - Sweep mode set to Alternate - reflection and transmission measured on separate sweeps. Improves Mixer bounce and Isolation measurements.
Increases sweep time

Examples

```
SENS:COUP ALL  
sense2:couple none
```

Query Syntax SENSe<cnum>:COUPle?

Return Type Character

Default ALL

SENSe<cnum>:COUPle:PARAmeter[:STATe] <bool>

Applicable Models: All

(Read-Write) Turns ON and OFF Time Domain Trace Coupling. All of the measurements in the specified channel are coupled.

- To select Transform parameters to couple, use **CALC:MEAS:TRAN:COUP:PAR**
- To select Gating parameters to couple, use **CALC:MEAS:FILT:COUP:PAR**

Learn more about [Time Domain Trace Coupling](#).

Parameters

<cnum> Any existing channel number; if unspecified, value is set to 1.

<bool> **ON (or 1)** - Turns ON Time Domain Trace Coupling.

OFF (or 0) - Turns OFF Time Domain Trace Coupling.

Examples

```
SENS:COUP:PAR 0  
sense2:couple:parameter:state on
```

Query Syntax SENSE<cnum>:COUPLE:PARAMeter[:STATe]?

Return Type Boolean

Default ON (or 1)

Sense DC

Controls the PXI DC measurement.

SENSe:DC:
CURRent:RANGe
SAMPles
DPOint
POINts
TIME
VOLTage:RANGe

Click on a keyword to view the command details.

SENSe<ch>:DC:CURRent:RANGe <name>, <num>

Applicable Models: M937xA, M9485A, P937xA

(Read-Write) Sets and reads the range (in Amps) used for sensing current, which must be higher than the maximum current you expect to measure. This command is available for PXI SMU only. This is the same function with “IKtM911xMeasurement Interface” section, “SenseCurrentRange” property of the M911x driver.

Parameters

- <ch> Any existing channel number. If unspecified, value is set to 1.
- <name> String. DC Meter Name.
"SMU*C" or "SMU*V" represents the SMU DC Meter name. "*" is the SMU module number. "C" means current measurement, "V" means voltage measurement.
- <num> Range in Amps (3, 0.001 or 0.0001)

Examples

```
SOUR:DC:CURR:RANG "SMU1", 10
```

Query Syntax SENSe<ch>:DC:CURRent:RANGe? <name>

Return Type Numeric

Default 3

SENSe<ch>:DC:SAMPles:DPOint <name>, <num>

Applicable Models: M937xA, M9485A, P937xA

(Read-Write) Sets and reads the trigger offset in the measurement sweep. A negative value specifies pre-trigger samples, and a positive value specifies post-trigger delay samples. This command is available for PXI SMU only. This is the same function with “IKtM911xMeasurementSweep Interface” section, “OffsetPoints” property of the M911x driver.

Parameters

- <ch> Any existing channel number. If unspecified, value is set to 1.
- <name> String. DC Meter Name.
"SMU*C" or "SMU*V" represents the SMU DC Meter name. "*" is the SMU module number. "C" means current measurement, "V" means voltage measurement.
- <num> Offset points value. Value range: 1 to 100000, step 1,

Examples SOUR:DC:SAMP:DPO "SMU1", 10

Query Syntax SENSe<ch>:DC:SAMPles:DPOint? <name>

Return Type Numeric

Default 0

SENSe<ch>:DC:SAMPles:POINTs <name>, <num>

Applicable Models: M937xA, M9485A, P937xA

(Read-Write) Sets and reads the DC measurement number of sample counts per one point measurement. This command is available for both PXI SMU and Digital/Analog I/O M9341B. For PXI SMU, this is the same function with “IKtM911xMeasurementSweep Interface” section, “Points” property of the M911x driver.

Parameters

- <ch> Any existing channel number. If unspecified, value is set to 1.
- <name> String. DC Meter Name.

[SMU] "SMU*C" or "SMU*V" represents the SMU DC Meter name. "*" is the SMU module number. "C" means current measurement, "V" means voltage measurement.

[M9341B] "AI1", "AI2", "AI3", "AI4", "AOC1" or "AOC2"

- <num> Sample count value. Value range: 1 to 100000, step 1 (SMU),

Examples

```
SOUR:DC:SAMP:POINT "SMU1", 1000
```

Query Syntax SENSE<ch>:DC:SAMPLES:POINTS? <name>

Return Type Numeric

Default 3255 (SMU), 500 (M9341B)

SENSE<ch>:DC:SAMPLES:TIME <name>, <num>

Applicable Models: M937xA, M9485A, P937xA

(Read-Write) Sets and reads the DC measurement time per one point measurement. The value of SENSE:DC:SAMPLES:POINTS can be calculated by this value. This command allows you to have the same measurement time for different kind of modules whose sample rates are different. This command is available for both PXI SMU and Digital/Analog I/O M9341B.

Parameters

- <ch> Any existing channel number. If unspecified, value is set to 1.
- <name> String. DC Meter Name.

[SMU] "SMU*C" or "SMU*V" represents the SMU DC Meter name. "*" is the SMU module number. "C" means current measurement, "V" means voltage measurement.

[M9341B] "AI1", "AI2", "AI3", "AI4", "AOC1" or "AOC2",

<num> Measurement time in seconds

[SMU] M9111A sample time is 5.12usec per point.

[M9341B] Only one value can be set for one M9341B module. Its sample time is 20 nsec per point.

Examples SOUR:DC:SAMP:TIME "SMU1C", 1000

Query Syntax SENSE<ch>:DC:SAMPLEs:TIME? <name>

Return Type Numeric

Default 0.0166656 (SMU), 0.00001 (M9341B)

SENSE<ch>:DC:VOLTage:RANGe <name>, <num>

Applicable Models: M937xA, M9485A, E5080A, P937xA

(Read-Write) Sets and reads the range (in Volts) used for sensing voltage, which must be higher than the maximum current you expect to measure. This command is available for M937xA, M9485A with Digital/Analog I/O M9341B or E5080A.

Parameters

<ch> Any existing channel number. If unspecified, value is set to 1.

<name> String. DC Meter Name.

"AI1", "AI2", "AI3", or "AI4"

<num> Range in Volts (M937xA, M9485A: 1, 5 or 10) (E5080A: 1 or 10)

Examples SOUR:DC:CURR:RANG "AI1", 10

Query Syntax SENSE<ch>:DC:VOLTage:RANGe? <name>

Return Type Numeric

Default 10

DUT Control

When you use the PXI VNAs, you can control the M9341B 8 bit IO through the VNA firmware. The following commands are available when the launcher includes the M9341B.

SENSe:DUTControl:M9341:[MODule]

| **[:STATe]**

| **:IOTYpe**

| **:LEVel**

| **:PIO**

| **:TYPE**

| **:LEVel**

| **:RFFE**

| **:CLOCK**

| **:CSEQuence**

| **:SADDress**

| **:TYPE**

| **:BCOunt**

| **:ADDRes**

| **[:WRITe]:DATA**

| **:READ:DATA**

| **:COUNt**

Click on a keyword to view the command details.

SENSe<cnum>:DUTControl:M9341[:MODule<mod>][:STATe] <bool>

Applicable Models: All PXIe VNAs

(Read-Write) Sets and reads the DUT Control function state for each channel.

Parameters

- <cnun> Any existing channel number; if unspecified, value is set to 1. This command is common for all channels and the setting is ignored.
- <mod> Module number of M9341B. The number starts from 1 for the leftmost module of M9341B.
- <bool> Module control state. Choose from:
 - 0** or **OFF** - Skips to control the M9341A/B at the specified channel.
 - 1** or **ON** - Enables to control the M9341A/B at the specified channel.

Examples

```
SENS:DUTC:M9341
sense2:dutcontrol:m9341?
```

Query Syntax :SENSe<cnun>:DUTControl:M9341[:MODule<mnum>][:STATe]?

Return Type Boolean

Default OFF or 0

```
:SENSe<cnun>:DUTControl:M9341[:MODule<mod>]:IOType<iogroup> <iofunc>
```

Applicable Models: All PXIe VNAs

(Read-Write) Sets and returns I/O function type of the 8 bit Input/Output pins, for each I/O group.

Parameters

- <cnun> Any existing channel number; if unspecified, value is set to 1. This command is common for all channels and the setting is ignored.
- <mod> Module number of M9341B. The number starts from 1 for the leftmost module of M9341B.
- <iogroup> IO group number. Value range, 1 to 4.
 - 1: Group 1 (pins No. 1 and 2)
 - 2: Group 2 (pins No. 3 and 4)
 - 3: Group 3 (pins No. 5 and 6)
 - 4: Group 4 (pins No. 7 and 8)

<iofunc> set the IO function for the io group. <PARallel | RFFE>.

Examples

```
SENS:DUTC:M9341:IOTY1 PAR
sense2:dutcontrol:m9341:module2:iotype RFFE
```

Return Type Char

Default PARallel

```
:SENSe<cnum>:DUTControl:M9341[:MODule<mod>]:LEVel <lvl>
```

Applicable Models: All PXIe VNAs

(Read-Write) Sets and reads the output voltage level of the M9341B 8bit I/O

Parameters

<cnum> Any existing channel number; if unspecified, value is set to 1.

<mod> Module number of M9341B. The number starts from 1 for the leftmost module of M9341B.

<lvl> IO level in volt. Value range: 0.9 to 3.5. Step 0.05.

Examples

```
SENS:DUTC:M9341:LEV 1.5
sense2:dutcontrol:m9341:module2:level?
```

Query Syntax :SENSe<cnum>:DUTControl:M9341[:MODule<mnum>]:LEVel?

Return Type Numeric

Default 1.2

```
:SENSe<cnum>:DUTControl:M9341[:MODule<mod>]:PIO<iopin>:TYPE <dir>
```

Applicable Models: All PXIe VNAs

(Read-Write) Sets and reads the signal direction type of Parallel IO, for each IO pin. This setting is valid when the io pin function is selected as parallel IO.

Parameters

- <num> Any existing channel number; if unspecified, value is set to 1.
- <mod> Module number of M9341B. The number starts from 1 for the leftmost module of M9341B.
- <iopin> IO pin number
- <dir> IO direction. Choose from: **IN** or **OUT**

Examples

```
SENS:DUTC:M9341:PIO:TYPE IN
sense2:dutcontrol:m9341:module2:pio2:type?
```

Query Syntax :SENSe<num>:DUTControl:M9341[:MODule<mnum>]:PIO<iopin>:TYPE?

Return Type Character

Default OUT

```
:SENSe<num>:DUTControl:M9341[:MODule<mod>]:PIO<iopin>:LEVel <lvl>
```

Applicable Models: All PXIe VNAs

(Read-Write) Sets and reads the signal level of IO pin, high or low. This setting is valid when the io pin function is selected as parallel IO.

If the IO type is IN, this command shall be a read-only command. Write command will cause error.

Parameters

- <num> Any existing channel number; if unspecified, value is set to 1.
- <mod> Module number of M9341B. The number starts from 1 for the leftmost module of M9341B.
- <iopin> IO pin number
- <lvlr> Signal level. Choose from: **HIGH** or **LOW**

Examples

```
SENS:DUTC:M9341:PIO:LEV LOW
sense2:dutcontrol:m9341:module2:pio2:level?
```

Query Syntax :SENSe<num>:DUTControl:M9341[:MODule<mnum>]:PIO<iopin>:LEVel?

Return Type Char

Default LOW

:SENSe<cnum>:DUTControl: M9341[:MODUle<mod>]:RFFE:CLOCK <clk>

Applicable Models: All PXIe VNAs

(Read-Write) Sets and reads the RFFE clock rate.

Parameters

- <cnum> Any existing channel number; if unspecified, value is set to 1. This command is common for all channels and the setting is ignored.
- <mod> Module number of M9341B. The number starts from 1 for the leftmost module of M9341B.
- <clk> Clock rate in Hz. Value range, 25kHz to 25000kHz. Possible values are 50000/n, with integer n, 2000 to 2. User can use suffix such as “kHz” and so on.

Examples

```
:SENS:DUTC:M9341:RFFE:CLOCK 25KHZ  
sense2:dutcontrol:m9341:module2:rffe:clock?
```

Query Syntax :SENSe<cnum>:DUTControl: M9341[:MODUle<mnum>]:RFFE:CLOCK?

Return Type numeric

Default 50000

:SENSe<cnum>:DUTControl:M9341[:MODUle<mod>]:RFFE<rffech>:CSEQUence<csnum>:SADD <adrs>

Applicable Models: All PXIe VNAs

(Read-Write) Sets and reads the Slave Address (“SA” in GUI) for the specified command sequence.

Parameters

- <cnun> Any existing channel number; if unspecified, value is set to 1. This command is common for all channels and the setting is ignored.
- <mod> Module number of M9341B. The number starts from 1 for the leftmost module of M9341B
- <rffech> RFFE channel number. 1 to 4
- <csnum> RFFE command sequence number. 1 to 16.
- <adrs> DUT RFFE Slave Address. 0 to 15.

Examples

```
:SENS:DUTC:M9341:RFFE:CSEQ:SADD 2  
sense2:dutcontrol:m9341:module2:rffe:csequence2:address?
```

Query Syntax :SENSe<cnun>:DUTControl:M9341[:MODUle<mnum>]:RFFE<rffech>:CSEQuence<csnum>

Return Type numeric

Default 0

```
:SENSe<cnun>:DUTControl:M9341[:MODUle<mod>]:RFFE<rffech>:CSEQuence<csnum>:TYPE  
<typ>
```

Applicable Models: All PXIe VNAs

(Read-Write) Sets and reads the command sequence type for the specified command sequence.

Parameters

- <cnun> Any existing channel number; if unspecified, value is set to 1. This command is common for all channels and the setting is ignored.
- <mod> Module number of M9341B. The number starts from 1 for the leftmost module of M9341B
- <rffech> RFFE channel number. 1 to 4
- <csnum> RFFE command sequence number. 1 to 16.
- <adrs> RFFE command sequence type. Choose from:

ROWrite : Register 0 Write

RREad : Register Read

RWrite : Register Write

ERRead : Extended Register Read

ERWrite : Extended Register Write

Examples

```
:SENS:DUTC:M9341:RFFE:CSEQ:TYPE R0WR
```

```
sense2:dutcontrol:m9341:module2:rffe:csequence2:type?
```

Query Syntax :SENSe<cnum>:DUTControl:M9341[:MODule<mnum>]:RFFE<rffech>:CSEQuence<csnum>

Return Type Char

Default RREad

```
:SENSe<cnum>:DUTControl:M9341[:MODule<mod>]:RFFE<rffech>:CSEQuence<csnum>:BCOu<byt>
```

Applicable Models: All PXIe VNAs

(Read-Write) Sets and reads the byte count for the specified command sequence.

Parameters

<cnum> Any existing channel number; if unspecified, value is set to 1. This command is common for RFFE and the setting is ignored.

<mod> Module number of M9341B. The number starts from 1 for the leftmost module of M9341B

<rffech> RFFE channel number. 1 to 4

<csnum> RFFE command sequence number. 1 to 16.

<byt> **Byte Count value. Integer value. The value range is coupled with command sequence type**

Command sequence type	Byte count range
Register 0 Write	1
Register Read	
Register Write	
Extended Register Write	1 to 16
Extended Register Read	

Examples

```
:SENS:DUTC:M9341:RFFE:CSEQ:BCO 4
```

```
sense2:dutcontrol:m9341:module2:rffe:csequence2:bcount?
```

Query Syntax

```
:SENSe<cnun>:DUTControl:M9341[:MODule<mnum>]:RFFE<rffech>:CSEQuence<csn
```

Return Type Numeric

Default 1

```
SENSe<cnun>:DUTControl:M9341[:MODule<mod>]:RFFE<rffech>:CSEQuence<csnum>:ADDR<adrs>
```

Applicable Models: All PXIe VNAs

(Read-Write) Sets and reads the address value for the specified command sequence..

Parameters

<cnun> Any existing channel number; if unspecified, value is set to 1. This command is common for M9341B and the setting is ignored.

<mod> Module number of M9341B. The number starts from 1 for the leftmost module of M9341B

<rffech> RFFE channel number. 1 to 4

<csnum> RFFE command sequence number. 1 to 16.

<adrs> Address value. Integer value. The value range is coupled with command sequence type setting.

Command sequence type	Byte count range
Register 0 Write	0 (fixed)
Register Read	#h00 to #h1F (0-31)
Register Write	
Extended Register Write	#h00 to #hFF (0-255)
Extended Register Read	

Examples

```
:SENS:DUTC:M9341:RFFE:CSEQ:ADDR 2
```

```
sense2:dutcontrol:m9341:module2:rffe:csequence2:address?
```

Query Syntax

```
:SENSe<cnun>:DUTControl:M9341[:MODule<mnum>]:RFFE<rffech>:CSEQuence<csn
```

Return Type Numeric
Default 0

SENSe<cnum>:DUTControl:M9341[:MODule<mnum>]:RFFE<rffech>:CSEquence<csnum>[:WRITE<data>

Applicable Models: All PXIe VNAs

(Read-Write) Sets and reads the data values for the specified command sequence.

This command works if the command sequence type is “Register 0 Write” or “Register Write” or “Extend the command sequence type is “Register Read” or ”Extended Register Read”, this command will cause error.

Parameters

- <cnum> Any existing channel number; if unspecified, value is set to 1. This command is common for setting is ignored.
- <mod> Module number of M9341B. The number starts from 1 for the leftmost module of M9341B
- <rffech> RFFE channel number. 1 to 4
- <csnum> RFFE command sequence number. 1 to 16.
- <adrs> comma separated list of data values. The value length is coupled with byte count setting. If not match with byte count setting, write command will cause error.

Examples

```
:SENS:DUTC:M9341:RFFE:CSEQ:WRITE:DATA 10  
sense2:dutcontrol:m9341:module2:rffe:csequence2:write:data?
```

Query Syntax :SENSe<cnum>:DUTControl:M9341[:MODule<mnum>]:RFFE<rffech>:CSEquence<csnum>

Return Type Comma separated numeric values

Default 0

SENSe<cnum>:DUTControl:M9341[:MODule<mnum>]:RFFE<rffech>:CSEquence<csnum>:READ

Applicable Models: All PXIe VNAs

(Read only) Reads the data and parity value pairs from DUT for the specified command sequence.

Parameters

- <cnun> Any existing channel number; if unspecified, value is set to 1. This command is common for the setting is ignored.
- <mod> Module number of M9341B. The number starts from 1 for the leftmost module of M9341B
- <rffech> RFFE channel number. 1 to 4
- <csnum> RFFE command sequence number. 1 to 16.

Examples

```
:SENS:DUTC:M9341:RFFE:CSEQ:READ:DATA?  
sense2:dutcontrol:m9341:module2:rffe:csequence2:read:data?
```

Query Syntax :SENSe<cnun>:DUTControl:M9341[:MODUle<mnum>]:RFFE<rffech>:CSEQuence<csn

Return Type Comma separated numeric values, list of data and parity pairs.

Ex. Byte count is 3 case, return values are below:

[data#1],[parity#1],[data#2],[parity#2],[data#3],[parity#3]

Default Not applicable

```
SENSe<cnun>:DUTControl:M9341[:MODUle<mnum>]:RFFE<rffech>:CSEQuence<csnum>:COU  
<cnt>
```

Applicable Models: All PXIe VNAs

(Read-Write) Sets and reads the the number of RFFE Command Sequence. If user set the larger value than set, new RFFE command sequences will be added with the default parameter value.

Parameters

- <cnun> Any existing channel number; if unspecified, value is set to 1. This command is common for and the setting is ignored.
- <mod> Module number of M9341B. The number starts from 1 for the leftmost module of M9341B
- <rffech> RFFE channel number. 1 to 4
- <cnt> RFFE Command Sequence count. 1 to 16.

Examples

```
:SENS:DUTC:M9341:RFFE:CSEQ:COUN 10  
sense2:dutcontrol:m9341:module2:rffe:csequence2:count?
```

Query Syntax :SENSE<cnun>:DUTControl:M9341[:MODule<mnum>]:RFFE<rffech>:CSEQUence<csn

Return Type Numeric

Default 0

Sense:FOM (Frequency Offset) Commands

Controls the frequency offset settings which cause stimulus and response frequencies to be different.

Note: These commands replace the previous FOM commands. Although the old commands will continue to work, they can NOT be mixed with these new commands.

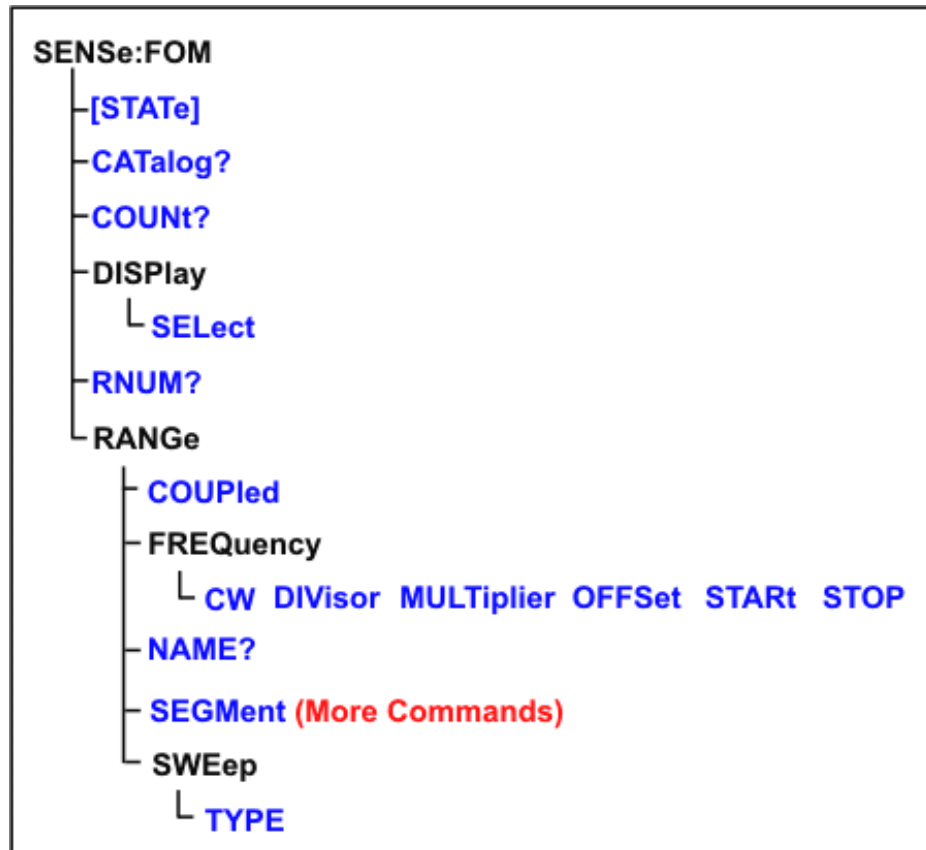

Click on a [red](#) keyword to view the command details.

See Also

- [FOM Example Program](#)
- [Learn about Frequency Offset](#)
- [Synchronizing the Analyzer and Controller](#)
- [SCPI Command Tree](#)

SENSE<num>:FOM[:STATe] <bool>

Applicable Models: All with FOM Options (S9x080A/B, S9x082A/B, S9x083A/B)

(Read-Write) Turns Frequency Offset ON and OFF. Frequency offset settings are not enabled until this setting is ON.

Send this command (FOM ON) AFTER sending other FOM settings to avoid 'out-of-range' errors.

Parameters

<cnun> Any existing channel number; if unspecified, value is set to 1.

<bool> ON (or 1) - turns FOM ON.

OFF (or 0) - turns FOM OFF.

Examples

```
SENS:FOM 1
sense2:fom:state on
```

Query Syntax SENSE<cnun>:FOM:STATE?

Return Type Boolean

Default OFF

SENSe<cnun>:FOM:CATalog?

Applicable Models: All with FOM Options (S9x080A/B, S9x082A/B, S9x083A/B)

(Read-only) Returns a comma-separated list of available range names in the VNA.

Use **SENS:FOM:CAT?** to see a list of available range names.

Use **SENS:FOM:COUNT?** to see a list of available range numbers.

Use **SENS:FOM:RNUM?** to see the range number for a specific name.

Use **SENS:FOM:RANG:NAME?** to see the range name for a specific number.

External devices can appear in the list of range names. [Learn more.](#)

Parameters

<cnun> Any existing channel number; if unspecified, value is set to 1.

Examples

```
SENS:FOM:CAT?

'returns

"Primary, Source, Receivers"
```

Return Type String

Default Not Applicable

SENSe<num>:FOM:COUNT?

Applicable Models: All with FOM Options (S9x080A/B, S9x082A/B, S9x083A/B)

(Read-only) Returns the number of valid range numbers in the VNA.

Parameters

<num> Any existing channel number; if unspecified, value is set to 1.

Examples

```
SENS:FOM:COUNT?  
sense2:fom:count?
```

Query Syntax SENSe<num>:FOM:COUNT?

Return Type Numeric

Default Not Applicable

SENSe<num>:FOM:DISPlay:SElect <string>

Applicable Models: All with FOM Options (S9x080A/B, S9x082A/B, S9x083A/B)

(Read-Write) Select the range to be displayed on the VNA x-axis. All traces in the channel have this same x-axis scaling.

Parameters

<num> Any existing channel number; if unspecified, value is set to 1.

<string> Range name. Case insensitive. Use **SENSe:FOM:CAT?** to see a list of available frequency range names.

Examples

```
SENS:FOM:DISPlay:SElect "source2"  
sense2:fom:display:select "source"
```

Query Syntax SENSe<num>:FOM:DISPlay:SElect?

Return Type String

Default Receivers

SENSe<num>:FOM:RNUM? <string>

Applicable Models: All with FOM Options (S9x080A/B, S9x082A/B, S9x083A/B)

(Read-only) Returns the number of a specified range name.

The FOM range items are typically numbered as follows:

1. Primary
2. Source
3. Receivers
4. Source2 (if present)

Use **SENS:FOM:CAT?** to see a list of available range names.

Use **SENS:FOM:COUNT?** to see a list of available range numbers.

Use **SENS:FOM:RANG:NAME?** to see the range name for a specific number.

External devices can appear in the list of range names. [Learn more.](#)

Parameters

- <cnm> Any existing channel number; if unspecified, value is set to 1.
<string> Range name for which a number is being queried. Case insensitive.

Examples

```
SENS:FOM:RNUM? "receivers"  
sense2:fom:rnum? "Source2"
```

Return Type Numeric

Default Not Applicable

SENSe<cnm>:FOM:RANGe<n>:COUPlEd <bool>

Applicable Models:All with FOM Options (S9x080A/B, S9x082A/B, S9x083A/B)

(Read-Write) Sets and returns the state of coupling (ON or OFF) of the specified range to the primary range.

Parameters

- <cnum> Any existing channel number; if unspecified, value is set to 1.
- <n> Range number to couple to primary range. An error is returned when attempting to couple to the Primary range (1).

Use **SENS:FOM:CAT?** to see a list of available range names.

Use **SENS:FOM:COUNt?** to see a list of available range numbers.

Use **SENS:FOM:RNUM?** to see the range number for a specific name.

Use **SENS:FOM:RANG:NAME?** to see the range name for a specific number.

<bool> **ON** (or 1) - Couple range to primary range.

OFF (or 0) - Do NOT couple to primary range.

Examples

```
SENS:FOM:RANG:COUP 1
sense2:fom:range2:coupled 0
```

Query Syntax SENSE<cnum>:FOM:RANGe<n>:COUPled?

Return Type Boolean

Default ON (or 1) Coupled

SENSe<cnum>:FOM:RANGe<n>:FREQuency:CW <num>

Applicable Models: All with FOM Options (S9x080A/B, S9x082A/B, S9x083A/B)

(Read-Write) Sets and returns the CW frequency.

This setting is valid for the primary range, or if the specified range is already **uncoupled** from the primary range and if the **sweep type** is CW.

Parameters

<cnum> Any existing channel number; if unspecified, value is set to 1.

<n> Range number. If unspecified, value is set to 1.

Use **SENS:FOM:CAT?** to see a list of available range names.

Use **SENS:FOM:COUNt?** to see a list of available range numbers.

Use **SENS:FOM:RNUM?** to see the range number for a specific name.

Use **SENS:FOM:RANG:NAME?** to see the range name for a specific number.

<num> CW frequency value in Hz. Choose any frequency within the range of the VNA.

Examples

```
SENS:FOM:RANG:FREQ: CW 1e9  
sense2:fom:range2:frequency:cw 10000000
```

Query Syntax SENSE<cnum>:FOM:RANGe:<n>:FREQuency: CW?

Return Type Numeric

Default Center frequency of the VNA.

SENSe<cnum>:FOM:RANGe<n>:FREQuency:DIVisor <num>

Applicable Models: All with FOM Options (S9x080A/B, S9x082A/B, S9x083A/B)

(Read-Write) Sets and returns the divisor value.

This setting is valid only if the specified range is **coupled** to the primary range.

Parameters

<cnum> Any existing channel number; if unspecified, value is set to 1.

<n> Range number. If unspecified, value is set to 1.

Use **SENS:FOM:CAT?** to see a list of available range names.

Use **SENS:FOM:COUNT?** to see a list of available range numbers.

Use **SENS:FOM:RNUM?** to see the range number for a specific name.

Use **SENS:FOM:RANG:NAME?** to see the range name for a specific number.

<num> Divisor value (unitless).

Examples

```
SENS:FOM:RANG:FREQ:DIV 3
sense2:fom:range2:frequency:divisor 0
```

Query Syntax SENSE<cnum>:FOM:RANGe<n>:FREQuency:DIVisor?

Return Type Numeric

Default 1

SENSe<cnum>:FOM:RANGe<n>:FREQuency:MULTiplier <num>

Applicable Models: All with FOM Options (S9x080A/B, S9x082A/B, S9x083A/B)

(Read-Write) Sets and returns the multiplier value to be used when coupling this range to the primary range.

This setting is valid only if the specified range is **coupled** to the primary range.

Parameters

<cnum> Any existing channel number; if unspecified, value is set to 1.

<n> Range number. If unspecified, value is set to 1.

Use **SENS:FOM:CAT?** to see a list of available range names.

Use **SENS:FOM:COUNT?** to see a list of available range numbers.

Use **SENS:FOM:RNUM?** to see the range number for a specific name.

Use **SENS:FOM:RANG:NAME?** to see the range name for a specific number.

<num> Multiplier value. (Unitless)

Examples

```
SENS:FOM:RANG:FREQ:MULT 1  
sense2:fom:range2:frequency:multiplier 2
```

Query Syntax SENSE<cnum>:FOM:RANGe<n>:FREQUency:MULTiplier?

Return Type Numeric

Default 1

SENSE<cnum>:FOM:RANGe<n>:FREQUency:OFFSet <num>

Applicable Models: All with FOM Options (S9x080A/B, S9x082A/B, S9x083A/B)

(Read-Write) Sets and returns the offset value to be used when coupling this range to the primary range. [Learn more about offset value.](#)

This setting is valid only if the specified range is **coupled** to the primary range.

Parameters

<cnum> Any existing channel number; if unspecified, value is set to 1.

<n> Range number. If unspecified, value is set to 1.

Use **SENS:FOM:CAT?** to see a list of available range names.

Use **SENS:FOM:COUNt?** to see a list of available range numbers.

Use **SENS:FOM:RNUM?** to see the range number for a specific name.

Use **SENS:FOM:RANG:NAME?** to see the range name for a specific number.

<num> Offset value. (Unitless)

Examples

```
SENS:FOM:RANG:FREQ:OFFS 1E9  
sense2:fom:range2:frequency:offset 10000000
```

Query Syntax SENSE<cnum>:FOM:RANGe<n>:FREQUency:OFFSet?

Return Type Numeric

Default 0

SENSE<cnum>:FOM:RANGe<n>:FREQUency:STARt <num>

Applicable Models: All with FOM Options (S9x080A/B, S9x082A/B, S9x083A/B)

(Read-Write) Sets and returns the Start value of frequency range. Also specify **Stop frequency**.

This setting is valid for the primary range, or if the specified range is already **uncoupled** from the primary range and if the **sweep type** is LOG or LINear.

Parameters

<cnm> Any existing channel number; if unspecified, value is set to 1.

<n> Range number. If unspecified, value is set to 1.

Use **SENS:FOM:CAT?** to see a list of available range names.

Use **SENS:FOM:COUNt?** to see a list of available range numbers.

Use **SENS:FOM:RNUM?** to see the range number for a specific name.

Use **SENS:FOM:RANG:NAME?** to see the range name for a specific number.

<num> Start value in Hz. Choose any frequency within the range of the VNA.

Examples

```
SENS:FOM:RANG:FREQ:STAR 1GHz
sense2:fom:range2:frequency:start 100000000
```

Query Syntax SENSE<cnm>:FOM:RANGe<n>:FREQUency:STARt?

Return Type Numeric

Default Minimum frequency of the VNA.

SENSe<cnm>:FOM:RANGe<n>:FREQUency:STOP <num>

Applicable Models: All with FOM Options (S9x080A/B, S9x082A/B, S9x083A/B)

(Read-Write) Sets and returns the Stop value of frequency range. Also specify **Start frequency**.

This setting is valid for the primary range, or if the specified range is already **uncoupled** from the primary range and if the **sweep type** is LOG or LINear.

Parameters

<cnm> Any existing channel number; if unspecified, value is set to 1.

<n> Range number. If unspecified, value is set to 1.

Use **SENS:FOM:CAT?** to see a list of available range names.

Use **SENS:FOM:COUNt?** to see a list of available range numbers.

Use **SENS:FOM:RNUM?** to see the range number for a specific name.

Use **SENS:FOM:RANG:NAME?** to see the range name for a specific number.

<num> Stop value in Hz. Choose any frequency within the range of the VNA.

Examples

```
SENS:FOM:RANG:FREQ:STOP 1e12
sense2:fom:range2:frequency:stop 10000000000
```

Query Syntax SENSE<cnum>:FOM:RANGe<n>:FREQuency:STOP?

Return Type Numeric

Default Maximum frequency of the VNA.

SENSE<cnum>:FOM:RANGe<n>:NAME?

Applicable Models: All with FOM Options (S9x080A/B, S9x082A/B, S9x083A/B)

(Read-only) Returns the name of range<n>.

The FOM range items are typically named as follows:

1. Primary
2. Source
3. Receivers
4. Source2 (if present)

Use **SENS:FOM:CAT?** to see a list of available range names.

Use **SENS:FOM:COUNt?** to see a list of available range numbers.

Use **SENS:FOM:RNUM?** to see the range number for a specific name.

Parameters

<cnum> Any existing channel number; if unspecified, value is set to 1.

<n> Range number. If unspecified, value is set to 1.

Examples

```
SENS:FOM:RANG:NAME?
sense2:fom:range2:name?
```

Return Type String

Default Not Applicable

SENSe<num>:FOM:RANGe<n>:SWEep:TYPE <char>

Applicable Models: All with FOM Options (S9x080A/B, S9x082A/B, S9x083A/B)

(Read-Write) Sets and returns the sweep type to be used with the specified range.

This setting is valid only if the specified range is already **uncoupled** from the primary range.

Learn about **Unsupported Sweep Type combinations**.

Parameters

<num> Any existing channel number; if unspecified, value is set to 1.

<n> Range number. If unspecified, value is set to 1.

Use **SENS:FOM:CAT?** to see a list of available range names.

Use **SENS:FOM:COUNt?** to see a list of available range numbers.

Use **SENS:FOM:RNUM?** to see the range number for a specific name.

Use **SENS:FOM:RANG:NAME?** to see the range name for a specific number.

<char> Sweep type. Choose from:

CW - Also specify **CW frequency**.

LINEar - Also specify frequency Start/Stop or Center/Span

LOG - Also specify frequency Start/Stop or Center/Span

PHASe - See all **Phase sweep** settings.

POWER - Also specify power Start/Stop or Center/Span

SEGMENT - Also specify **segment sweep** settings.

Examples

```
SENS:FOM:RANG:SWE:TYPE LOG
sense2:fom:range2:sweep:type linear:
```

Query Syntax SENSe<num>:FOM:RANGe<n>:SWEep:TYPE?

Return Type Character

Default Linear

Sense:FOM:Range:Segment Commands

Constructs a segment table for a specified **UNCOUPLED** FOM range.

Note: Do NOT use **Sens:Segment** commands for FOM segment sweep.

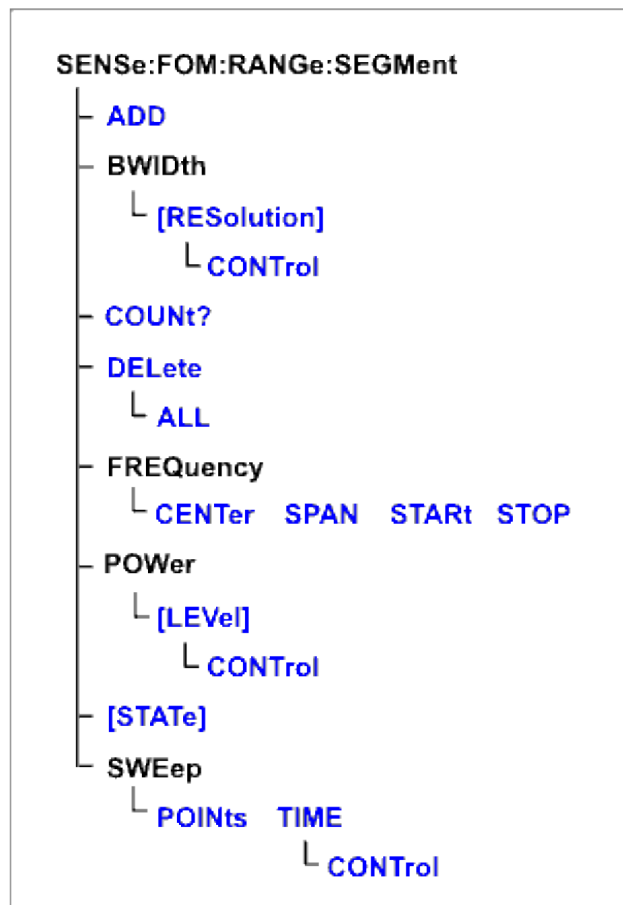

Click on a **red** keyword to view the command details.

See Also

- [Other SENSE:FOM Commands](#)
- [Example Programs](#)
- [Synchronizing the Analyzer and Controller](#)
- [SCPI Command Tree](#)

SENSE<cnum>:FOM:RANGE<n>:SEGMENT<s>:ADD

Applicable Models: All with FOM Options (S9x080A/B, S9x082A/B, S9x083A/B)

(Write-only) Adds a segment.

Parameters

- <cnum> Any existing channel number; if unspecified, value is set to 1.
- <n> Range number. If unspecified, value is set to 1.
- <s> Segment number to add. If unspecified, value is set to 1. Segment numbers must be sequential. If a new number is added where one currently exists, the existing segment and those following are incremented by one.

Examples

Two Segments exist (1 and 2). The following command will add a new segment (1). The existing (1 and 2) will become (2 and 3) respectively.

```
sense2:fom:range2:segment:add
```

Query Syntax Not Applicable

Default Not Applicable

SENSe<cnum>:FOM:RANGe<n>:SEGMENT<s>:BWIDth[:RESolution] <num>

Applicable Models: All with FOM Options (S9x080A/B, S9x082A/B, S9x083A/B)

(Read-Write) Sets the IF Bandwidth for the specified segment. First set **SENS:FOM:RANGe:SEGM:BWIDth:CONTRol ON**. All subsequent segments that are added assume the new IF Bandwidth value.

Valid either for Receiver range or for Primary range when coupled to Receiver.

Parameters

- <cnum> Any existing channel number; if unspecified, value is set to 1.
- <n> Range number. If unspecified, value is set to 1.
- <s> Segment number for which to set independent IF Bandwidth.
- <num> IF Bandwidth in Hz. The list of valid IF Bandwidths is different depending on the VNA model. [See the list of valid IFBW values](#). If an invalid number is specified, the analyzer will round up to the closest valid number.

Examples

```
SENS:FOM:RANG:SEGM:BWIDth 100
```

```
sense2:fom:range2:segment4:ewidth:resolution 1e3
```

Query Syntax SENSe<cnum>:FOM:RANGe<n>:SEGMENT<s>:BWIDth[:RESolution]?

Return Type Numeric

Default Varies with model.

SENSe<cnum>:FOM:RANGe<n>:SEGMENT:BWIDth[:RESolution]:CONTrol <bool>

Applicable Models: All with FOM Options (S9x080A/B, S9x082A/B, S9x083A/B)

(Read-Write) Specifies whether the IF Bandwidth resolution can be set independently for each segment. When set, each segment added after this will be set to ON automatically.

Valid either for Receiver range or for Primary range. Primary range value is ignored unless Receiver is coupled to Primary.

Parameters

<cnum> Any existing channel number; if unspecified, value is set to 1.

<n> Range number. If unspecified, value is set to 1.

<bool> **ON** (or 1) - turns Bandwidth control ON. Bandwidth can be set for each segment

OFF (or 0) - turns Bandwidth control OFF. Use the channel IF bandwidth setting instead.

Examples

```
SENS:FOM:RANG:SEGM:BWIDth:CONT 0
```

```
sense2:fom:range2:segment:bandwidth:resolution:control 1
```

Query Syntax SENSe<cnum>:FOM:RANGe<n>:SEGMENT:BWIDth[:RESolution]:CONTrol?

Return Type Boolean

Default OFF

SENSe<cnum>:FOM:RANGe<n>:SEGMENT:COUNT?

Applicable Models: All with FOM Options (S9x080A/B, S9x082A/B, S9x083A/B)

(Read-only) Returns the number of segments that exist for the specified range.

Parameters

<cnum> Any existing channel number; if unspecified, value is set to 1.

<n> Range number. If unspecified, value is set to 1.

Examples

```
SENS:FOM:RANG:SEGM:COUN?
```

```
sense2:fom:range2:segment:count?
```

Return Type Numeric

Default Not Applicable

SENSe<cnum>:FOM:RANGe<n>:SEGMENT<s>:DELete

Applicable Models: All with FOM Options (S9x080A/B, S9x082A/B, S9x083A/B)

(Write-only) Deletes the specified sweep segment.

Parameters

<cnum> Any existing channel number; if unspecified, value is set to 1.

<n> Range number. If unspecified, value is set to 1.

<s> Number of the segment to delete. If unspecified, value is set to 1.

Examples

```
SENS:FOM:RANG:SEGM3:DEL
```

```
sense2:fom:range2:segment4:delete
```

Query Syntax Not Applicable

Default Not Applicable

SENSe<cnum>:FOM:RANGe<n>:SEGMENT:DELete:ALL

Applicable Models: All with FOM Options (S9x080A/B, S9x082A/B, S9x083A/B)

(Write-only) Deletes all sweep segments in the specified range.

Parameters

<num> Any existing channel number; if unspecified, value is set to 1.

<n> Range number. If unspecified, value is set to 1.

Examples

```
SENS:FOM:RANG:SEGM:DEL:ALL  
sense2:fom:range2:segment:delete:all
```

Query Syntax Not Applicable

Default Not Applicable

SENSe<num>:FOM:RANGe<n>:SEGMENT<s>:FREQUENCY:CENTer <num>

Applicable Models: All with FOM Options (S9x080A/B, S9x082A/B, S9x083A/B)

(Read-Write) Sets and returns the center frequency for the specified sweep segment. Also specify segment frequency span.

Parameters

<num> Any existing channel number; if unspecified, value is set to 1.

<n> Range number. If unspecified, value is set to 1.

<s> Segment number to modify. Choose any existing segment number.

<num> Center Frequency in Hz. Choose any number between the minimum and maximum frequency of the analyzer.

Examples

```
SENS:FOM:RANG:SEGM:FREQ:CENT 1GHz  
sense2:fom:range2:segment4:frequency:center 1e9
```

Query Syntax SENSe<num>:FOM:RANGe<n>:SEGMENT<s>:FREQUENCY:CENTer?

Return Type Numeric

Default Stop Frequency of the previous segment. If first segment, start frequency of the analyzer.

SENSe<num>:FOM:RANGe<n>:SEGMENT<s>:FREQUENCY:SPAN <num>

Applicable Models: All with FOM Options (S9x080A/B, S9x082A/B, S9x083A/B)

(Read-Write) Sets and returns the span frequency for the specified sweep segment. Also specify segment center frequency.

Parameters

- <cnum> Any existing channel number; if unspecified, value is set to 1.
- <n> Range number. If unspecified, value is set to 1.
- <s> Segment number to modify. Choose any existing segment number.
- <num> Frequency span in Hz. Choose any number between the minimum and maximum frequency of the analyzer.

Examples

```
SENS:FOM:RANG:SEGM:FREQ:SPAN 1GHz  
sense2:fom:range2:segment4:frequency:span 1e9
```

Query Syntax SENSE<cnum>:FOM:RANGe<n>:SEGMent<s>:FREQuency:SPAN?

Return Type Numeric

Default If first segment, frequency span of the analyzer. Otherwise 0.

SENSE<cnum>:FOM:RANGe<n>:SEGMent<s>:FREQuency:STARt <num>

Applicable Models: All with FOM Options (S9x080A/B, S9x082A/B, S9x083A/B)

(Read-Write) Sets and returns the start frequency for the specified sweep segment. Also specify segment stop frequency.

All other segment Start and Stop Frequency values that are larger than this frequency are changed to this frequency.

Parameters

- <cnum> Any existing channel number; if unspecified, value is set to 1.
- <n> Range number. If unspecified, value is set to 1.
- <s> Segment number to modify. Choose any existing segment number.
- <num> Start frequency in Hz. Choose any number between the minimum and maximum frequency of the analyzer.

Examples

```
SENS:FOM:RANG:SEGM:FREQ:STAR 1GHz  
sense2:fom:range2:segment4:frequency:start 1e9
```

Query Syntax SENSE<cnum>:FOM:RANGe<n>:SEGMent<s>:FREQuency:STARt?

Return Type Numeric

Default Stop Frequency of the previous segment. If first segment, start frequency of the analyzer.

SENSe<cnum>:FOM:RANGe<n>:SEGMENT<s>:FREQUency:STOP <num>

Applicable Models: All with FOM Options (S9x080A/B, S9x082A/B, S9x083A/B)

(Read-Write) Sets and returns the stop frequency for the specified sweep segment. Also specify segment start frequency.

All other segment Start and Stop Frequency values that are larger than this frequency are changed to this frequency.

Parameters

- <cnum> Any existing channel number; if unspecified, value is set to 1.
- <n> Range number. If unspecified, value is set to 1.
- <s> Segment number to modify. Choose any existing segment number.
- <num> Stop frequency in Hz. Choose any number between the minimum and maximum frequency of the analyzer.

Examples

```
SENS:FOM:RANG:SEGM:FREQ:STOP 1GHz  
sense2:fom:range2:segment4:frequency:stop 1e9
```

Query Syntax SENSe<cnum>:FOM:RANGe<n>:SEGMENT<s>:FREQUency:STOP?

Return Type Numeric

Default Stop Frequency of the previous segment. If first segment, start frequency of the analyzer.

SENSe<cnum>:FOM:RANGe<n>:SEGMENT<s>:POWER<p>[:LEVel] <num>

Applicable Models: All with FOM Options (S9x080A/B, S9x082A/B, S9x083A/B)

(Read-Write) Sets the Port Power level for the specified sweep segment. First set SENS:FOM:RANG:SEGM:POW:CONTRol ON.

When **port power is Coupled**, setting port power for one port will apply port power for all source ports.

All subsequent segments that are added assume the new Power Level value.

Valid either for Source ranges or for Primary range when **coupled** to the source.

Parameters

- <cnum> Any existing channel number; if unspecified, value is set to 1.
- <n> Range number. If unspecified, value is set to 1.
- <s> Segment number to modify. Choose any existing segment number.
- <p> Port number of the source. If unspecified, value is set to 1.
- <num> Power level in dBm.

Note: The range of settable power values depends on the VNA model and if source attenuators are installed. To determine the range of values, send SOUR:POW? MAX and SOUR:POW? MIN. (**SOUR:POW:ATT:AUTO** must be set to ON).

Actual achievable leveled power depends on frequency.

Examples

```
SENS:FOM:RANG:SEGM:POW -5  
sense2:fom:range2:segment4:power2:level 5
```

Query Syntax SENSE<cnum>:FOM:RANGe<n>:SEGMent<s>:POWer<p>[:LEVel]?

Return Type Numeric

Default 0

SENSE<cnum>:FOM:RANGe<n>:SEGMent:POWer[:LEVel]:CONTRol <bool>

Applicable Models: All with FOM Options (S9x080A/B, S9x082A/B, S9x083A/B)

(Read-Write) Specifies whether Power Level is to be set independently for each segment.

Valid either for Source ranges or for Primary range. Primary range value is ignored unless Source is **coupled** to Primary.

Parameters

- <cnm> Any existing channel number; if unspecified, value is set to 1.
- <n> Range number. If unspecified, value is set to 1.
- <bool> ON (or 1) - Power level will be set for each segment.
OFF (or 0) - Use the channel power level setting.

Examples

```
SENS:FOM:RANG:SEGM:POW:CONT 0  
sense2:fom:range2:segment:power:control on
```

Query Syntax SENSE<cnm>:FOM:RANGe<n>:SEGMENT:POWer[:LEVel]:CONTrol?

Return Type Boolean

Default OFF (or 0)

SENSe<cnm>:FOM:RANGe<n>:SEGMENT<s>[:STATe] <bool>

Applicable Models: All with FOM Options (S9x080A/B, S9x082A/B, S9x083A/B)

(Read-Write) Turns the specified sweep segment ON or OFF.

Parameters

- <cnm> Any existing channel number; if unspecified, value is set to 1.
- <n> Range number. If unspecified, value is set to 1.
- <s> Segment number to be turned ON or OFF. Choose any existing segment number.
- <bool> ON (or 1) - turns segment ON.
OFF (or 0) - turns segment OFF.

Examples

```
SENS:FOM:RANG:SEGM 0  
sense2:fom:range2:segment4:state on
```

Query Syntax SENSE<cnm>:FOM:RANGe<n>:SEGMENT<s>[STATe]?

Return Type Boolean

Default OFF (or 0)

SENSe<cnum>:FOM:RANGe<n>:SEGMENT<s>:SWEep:POINTs <num>

Applicable Models: All with FOM Options (S9x080A/B, S9x082A/B, S9x083A/B)

(Read-Write) Sets the number of data points for the specified sweep segment.

Parameters

- <cnum> Any existing channel number; if unspecified, value is set to 1.
- <n> Range number. If unspecified, value is set to 1.
- <s> Segment number to modify. Choose any existing segment number.
- <num> Number of points in the segment. The total number of points in all segments cannot exceed 20001. A segment can have as few as 1 point.

Examples

```
SENS:FOM:RANG:SEGM:SWE:POIN 101  
sense2:fom:range2:segment4:sweep:points 201
```

Query Syntax SENSe<cnum>:FOM:RANGe<n>:SEGMENT<s>:SWEep:POINTs?

Return Type Numeric

Default 21

SENSe<cnum>:FOM:RANGe<n>:SEGMENT<s>:SWEep:TIME <num>

Applicable Models: All with FOM Options (S9x080A/B, S9x082A/B, S9x083A/B)

(Read-Write) Sets the time the VNA takes to sweep the specified segment.

Valid ONLY for receiver ranges.

Parameters

- <cnum> Any existing channel number; if unspecified, value is set to 1.
- <n> Range number. If unspecified, value is set to 1.
- <s> Segment number for which to set sweep time.
- <num> Sweep time in seconds. Choose a number between 0 and 100

Examples

```
SENS:FOM:RANG:SEGM:SWE:TIME 1  
sense2:fom:range2:segment3:sweep:time .1
```

Query Syntax SENSe<cnum>:FOM:RANGe<n>:SEGMENT<s>:SWEep:TIME?

Return Type Numeric
Default Not Applicable

SENSe<cnum>:FOM:RANGe<n>:SEGMENT:SWEep:TIME:CONTRol <bool>

Applicable Models: All with FOM Options (S9x080A/B, S9x082A/B, S9x083A/B)

(Read-Write) Specifies whether Sweep Time can be set independently for each sweep segment.

Valid either for Receiver ranges or for Primary range. Primary range value is ignored unless Receiver is **coupled** to Primary.

Parameters

- <cnum> Any existing channel number; if unspecified, value is set to 1.
- <n> Range number. If unspecified, value is set to 1.
- <bool> **ON** (or 1) - Sweep time will be set for each segment.
OFF (or 0) - Use the channel sweep time setting.

Examples

```
SENS:FOM:RANG:SEGM:SWE:TIME:CONT 1  
sense2:fom:range2:segment:sweep:time:control off
```

Query Syntax SENSe<cnum>:FOM:RANGe<n>:SEGMENT:SWEep:TIME:CONTRol?

Return Type Boolean
Default OFF

Sense:Frequency Commands

Sets the sweep frequencies of the analyzer.

SENSE:FREQuency

| [CENTer](#)

| [CW](#) | [FIXed](#)

| [SPAN](#)

| [STARt](#)

| [STOP](#)

Click on a keyword to view the command details.

see Also

- [Example](#) using some of these commands.
- [Learn about Frequency Sweep](#)
- [Synchronizing the Analyzer and Controller](#)
- [SCPI Command Tree](#)
- See [CALCulate:MEASure:X:VALues](#) for frequency point data.

SENSE<num>:FREQuency:CENTer <num>

Applicable Models: All

(Read-Write) Sets the center frequency of the analyzer.

Parameters

- <num> Any existing channel number. If unspecified, value is set to 1
- <num> Center frequency. Choose any number between the **minimum** and **maximum** frequency limits of the analyzer. Units are Hz.

This command will accept **MIN** or **MAX** instead of a numeric parameter. See [SCPI Syntax](#) for more information.

Examples

```
SENS:FREQ:CENT 1000000
sense2:frequency:center 1mhz
sense2:frequency:center 1e6
```

Query Syntax SENSE<num>:FREQUENCY:CENTer?

Return Type Numeric

Default Center of the analyzer's frequency span

SENSe<num>:FREQUENCY[:CW |:FIXed] <num>

Applicable Models: All

(Read-Write) Sets the Continuous Wave (or Fixed) frequency. Must also send **SENS:SWEEP:TYPE CW** to put the analyzer into CW sweep mode.

Parameters

- <num> Any existing channel number. If unspecified, value is set to 1
- <num> CW frequency. Choose any number between the **minimum** and **maximum** frequency limits of the analyzer. Units are Hz.

This command will accept **MIN** or **MAX** instead of a numeric parameter. See [SCPI Syntax](#) for more information.

Examples

```
SENS:FREQ 1000000
SENS:FREQ:CW MIN
sense2:frequency:fixed 1mhz
```

Query Syntax SENSe<num>:FREQUENCY[:CW |:FIXed]?

Return Type Numeric

Default 1 GHz

SENSe<num>:FREQuency:SPAN <num>

Applicable Models: All

(Read-Write) Sets the frequency span of the analyzer.

Parameters

- <num> Any existing channel number. If unspecified, value is set to 1
- <num> Frequency span in Hz. Choose any number from **70** (minimum) and the **maximum** frequency span of the analyzer.

This command will accept **MIN** or **MAX** instead of a numeric parameter. See [SCPI Syntax](#) for more information.

Examples

```
SENS:FREQ:SPAN 1000000
sense2:frequency:span max
```

Query Syntax SENSe<num>:FREQuency:SPAN?

Return Type Numeric

Default Maximum frequency span of the analyzer

SENSe<num>:FREQuency:STARt <num>

Applicable Models: All

(Read-Write) Sets the start frequency of the analyzer.

Parameters

- <num> Any existing channel number. If unspecified, value is set to 1
- <num> Start frequency. Choose any number between the **MIN** and **MAX** frequency limits of the analyzer. Units are Hz.

If FREQ:START is set greater than FREQ:STOP, then the stop frequency is set to the start frequency + frequency span.

This command will accept **MIN** or **MAX** instead of a numeric parameter. See [SCPI Syntax](#) for more information.

Examples

```
SENS:FREQ:STAR 1000000
sense2:frequency:start MIN
```

Query Syntax SENSe<num>:FREQuency:STARt?

Return Type Numeric

Default Minimum frequency of the analyzer

SENSe<cnum>:FREQuency:STOP <num>

Applicable Models: All

(Read-Write) Sets the stop frequency of the analyzer.

Parameters

<cnum> Any existing channel number. If unspecified, value is set to 1

<num> Stop frequency. Choose any number between 70 (minimum) and **maximum** frequency limits of the analyzer. Units are Hz.

If **FREQ:STOP** is set less than **FREQ:START**, then the start frequency is set to the stop frequency - frequency span.

This command will accept **MIN** or **MAX** instead of a numeric parameter. See [SCPI Syntax](#) for more information.

Examples

```
SENS:FREQ:STOP 1000000
```

```
sense2:frequency:stop max
```

Query Syntax SENSe<cnum>:FREQuency:STOP?

Return Type Numeric

Default Maximum frequency of the analyzer

SENSe:GCSetup Commands

Controls the Gain Compression configuration.

SENSe:GCSetup:

AMODe <char>

COMPression:

| **ALGorithm <char>**

| **BACKoff:LEVel <num>**

| **DELTA:X <num>**

| **DELTA:Y <num>**

| **INTerpolate**

| **[[:STATE]**

| **LEVel <num>**

| **SATuration:LEVel**

EOSoperation <string>

PMAP

| **INPut?**

| **OUTPut?**

POWer:

| **LINear:INPut:LEVel <num>**

| **REVerse:LEVel <num>**

| **STARt:LEVel <num>**

| **STOP:LEVel <num>**

SAFE:

| **CPADjustment <num>**

| **ENABLE <bool>**

| **FPADjustment <num>**

| **FTHReshold <num>**

<p> MLIMit <num></p> <p>SFA?</p> <p>SMART:</p> <p> CDC</p> <p> MITerations <num></p> <p> SITerations <bool></p> <p> STIMe <num></p> <p> TOLerance <num></p> <p>SWEEp:</p> <p> FREQuency:POINts <num></p> <p> POWEr:POINts <num></p>
--

Click on a keyword to view the command details.

See Also

Other Gain Compression commands

- [CALCulate:MEASure:DEFine](#) - creates a gain compression measurement.
- [CALC:MEAS:GCMeas:ANAL](#) - Gain Compression Analysis settings
- **GCA Calibration** uses the Guided Calibration commands, except for the following:
 - [Sens:Corr:GCS:Power](#) - sets power level for Source Power Cal

GCX

- Setup Mixer using [Sense:Mixer commands](#)
- Calibrate using [SMC commands](#) and [Guided commands](#)
- **Example Programs**
 - [Create and Cal a Gain Compression Measurement](#)
 - [Create and Cal a GCX Measurement](#)
- [Learn about Gain Compression Application](#)
- [Synchronizing the Analyzer and Controller](#)

SENSe<ch>:GCSetup:AMODE <char>

Applicable Models: All with Gain Compression Option

(Read-Write) Set and read the method by which gain compression data is acquired.

Parameters

- <ch> Any existing GCA channel. If unspecified, value is set to 1.
<char> Choose from:

- PFREQUENCY - 2D Power Per Frequency
- FPOWER - 2D Frequency Per Power
- SMARTSWEEP - Smart Sweep

Examples

```
SENS:GCS:AMOD SMAR  
sense:gcsetup:amode pfrequency
```

Query Syntax SENSe<ch>:GCSetup:AMODE ?

Return Type Character

Default SMARTSWEEP

SENSe<ch>:GCSetup:COMPRESSION:ALGORITHM <char>

Applicable Models: All with Gain Compression Option

(Read-Write) Set and read the algorithm method used to compute gain compression.

Parameters

- <ch> Any existing GCA channel. If unspecified, value is set to 1.
<char> Algorithm method. Choose from:

- CFLG - compression from linear gain
- CFMG - compression from maximum gain
- BACKOFF - compression from BackOff
- XYCOM - X/Y Compression
- SAT - compression from saturation

Examples

```
SENS:GCS:COMP:ALG BACK
```

```
sense:gcsetup:compression:algorithm XYcom
```

Query Syntax SENSE<ch>:GCSetup:COMPression:ALGorithm?**Return Type** Character**Default** CFLG**SENSe<ch>:GCSetup:COMPression:BACKoff:LEVEL <num>****Applicable Models:** All with Gain Compression Option**(Read-Write)** Set and read value for the BackOff compression algorithm.**Parameters**

<ch> Any existing GCA channel. If unspecified, value is set to 1.

<num> Backoff value in dB. Choose a value between 1 and 99.

Examples

```
SENS:GCS:COMP:BACK:LEV 10
```

```
sense:gcsetup:compression:backoff:level 5
```

Query Syntax SENSE<ch>:GCSetup:COMPression:BACKoff:LEVEL?**Return Type** Numeric**Default** 10**SENSe<ch>:GCSetup:COMPression:DELTA:X <num>****Applicable Models:** All with Gain Compression Option**(Read-Write)** Set and read the 'X' value in the delta X/Y compression algorithm.**Parameters**

<ch> Any existing GCA channel. If unspecified, value is set to 1.

<num> X value in dB. Choose a value from .01 to 10.

Examples

```
SENS:GCS:COMP:DELTA:X 9
```

```
sense:gcsetup:compression:delta:X 8
```

Query Syntax SENSE<ch>:GCSetup:COMPression:DELTA:X?**Return Type** Numeric**Default** 10

SENSe<ch>:GCSetup:COMPression:DELTA:Y <num>

Applicable Models: All with Gain Compression Option

(Read-Write) Set and read the "Y" value in the delta X/Y compression algorithm.

Parameters

- <ch> Any existing GCA channel. If unspecified, value is set to 1.
- <num> Y value in dB. Choose a value from .01 to 10.

Examples

```
SENS:GCS:COMP:DELTA:Y 9  
sense:gcsetup:compression:delta:Y 8
```

Query Syntax SENSe<ch>:GCSetup:COMPression:DELTA:Y?

Return Type Numeric

Default 9

SENSe<ch>:GCSetup:COMPression:INTerpolate[:STATE] <bool>

Applicable Models: All with Gain Compression Option

(Read-Write) Sets whether or not interpolation should be performed on 2D measured compression data. Applies ONLY to **2D acquisition modes**.

Parameters

- <ch> Any existing GCA channel. If unspecified, value is set to 1.
- <bool> Choose from:
 - ON** or **(1)** Interpolate the results
 - OFF** or **(0)** Do NOT interpolate the results but return the value closest to compression.

Examples

```
SENS:GCS:COMP:INT 1  
sense:gcsetup:compression:interpolate off
```

Query Syntax SENSe<ch>:GCSetup:COMPression:INTerpolation?

Return Type Boolean

Default OFF

SENSe<ch>:GCSetup:COMPression:LEVel <num>

Applicable Models: All with Gain Compression Option

(Read-Write) Set and read the desired gain reduction (from reference gain).

This value is used for Compression from Linear Gain and Compression from Maximum Gain.

Use **SENS:GCS:COMP:ALG CFLG** to set this compression algorithm.

Parameters

- <ch> Any existing GCA channel. If unspecified, value is set to 1.
- <num> Compression level in dB. Choose a value between .01 and 100.

Examples

```
SENS:GCS:COMP:LEV 1  
sense:gcsetup:compression:level 3
```

Query Syntax SENSe<ch>:GCSetup:COMPression:LEVel?

Return Type Numeric

Default 1

SENSe<ch>:GCSetup:COMPression:SATuration:LEVel <num>

Applicable Models: All with Gain Compression Option

(Read-Write) Set and read the deviation dB from the maximum Pout. This is the point of saturation.

Use **SENS:GCS:COMP:ALG CFLG** to set this compression algorithm.

Parameters

- <ch> Any existing GCA channel. If unspecified, value is set to 1.
- <num> Saturation level in dB. Choose a value between .01 and 10.

Examples

```
SENS:GCS:COMP:SAT:LEV 1  
sense:gcsetup:compression:saturation:level 3
```

Query Syntax SENSe<ch>:GCSetup:COMPressionSATuration:LEVel?

Return Type Numeric

Default .1 dB

SENSe<ch>:GCSetup:EOSoperation <char>

Applicable Models: All with Gain Compression Option

(Read-Write) This setting is used to protect a sensitive device from too much power during the sweep retrace. Other instrument settings or channels may over-ride this setting. [Learn more.](#)

Parameters

- <ch> Any existing GCA channel. If unspecified, value is set to 1.
- <char> End Of Sweep operation. Choose from:
- STANdard Use the default VNA method. [Learn more.](#)
 - POff Always turn power OFF while waiting.
 - PStArt Sweep Start power
 - PStOp Sweep Stop power.

Examples

```
SENS:GCS:EOS PSTA  
sense:gcsetup:eosoperation standard
```

Query Syntax SENSE<ch>:GCSetup:EOSoperation?

Return Type Character

Default STANdard

SENSe<ch>:GCSetup:PMAP <in>,<out>

Applicable Models: All with Gain Compression Option

(Write-only) Set the DUT-to-VNA port mapping for the Gain Compression measurement.

Parameters

- <ch> Any existing GCA channel. If unspecified, value is set to 1.
- <in> VNA port which is connected to the DUT input.
- <out> VNA port which is connected to the DUT output.

Examples

```
SENS:GCS:PMAP 1,2  
sense:gcsetup:pmap 2,1
```

Query Syntax Not Applicable

Default 1,2

SENSe<ch>:GCSetup:PMAP:INPut?

Applicable Models: All with Gain Compression Option

(Read-only) Read the VNA port number to be connected to the DUT Input.

Use **SENS:GCS:PORTMap** to set the port mapping.

Parameters

<ch> Any existing GCA channel. If unspecified, value is set to 1.

Examples

```
SENS:GCS:PMAP:INP?  
sense:gcsetup:pmap:input?
```

Return Type Numeric

Default 1

SENSe<ch>:GCSetup:PMAP:OUTPut?

Applicable Models: All with Gain Compression Option

(Read-only) Read the VNA port number to be connected to the DUT Output.

Parameters

<ch> Any existing GCA channel. If unspecified, value is set to 1.

Examples

```
SENS:GCS:PMAP:OUTP?  
sense:gcsetup:pmap:output?
```

Return Type Numeric

Default 2

SENSe<ch>:GCSetup:POWER:LINear:INPut:LEVel <num>

Applicable Models: All with Gain Compression Option

(Read-Write) Set and read the input power at which Linear Gain and all S-parameters are measured.

Parameters

- <ch> Any existing GCA channel. If unspecified, value is set to 1.
- <num> Input power level in dBm. Choose a value from +30 to (-30).

Examples

```
SENS:GCS:POW:LIN:INP:LEV 0  
sense:gcsetup:power:linear:input:level -10
```

Query Syntax SENSE<ch>:GCSetup:POWer:LINEar:INPut:LEVel?

Return Type Numeric

Default -25 dBm

SENSE<ch>:GCSetup:POWer:REVerse:LEVel <num>

Applicable Models: All with Gain Compression Option

(Read-Write) Set and read the reverse power level to the DUT. This is applied to the DUT output port when making reverse measurements like S22.

Parameters

- <ch> Any existing GCA channel. If unspecified, value is set to 1.
- <num> Reverse power level in dBm. Choose a value from +30 to (-30).

Examples

```
SENS:GCS:POW:REV:LEV 0  
sense:gcsetup:power:reverse:level -5
```

Query Syntax SENSE<ch>:GCSetup:POWer:REVerse:LEVel?

Return Type Numeric

Default -5

SENSE<ch>:GCSetup:POWer:STARt:LEVel <num>

Applicable Models: All with Gain Compression Option

(Read-Write) Set and read the start power level.

Parameters

- <ch> Any existing GCA channel. If unspecified, value is set to 1.
- <num> Start power level in dBm. Choose a value from +30 to (-30).

Examples

```
SENS:GCS:POW:STAR:LEV 0  
sense:gcsetup:power:start:level -5
```

Query Syntax SENSE<ch>:GCSetup:POWER:START:LEVel?

Return Type Numeric

Default -25

SENSE<ch>:GCSetup:POWER:STOP:LEVel <num>

Applicable Models: All with Gain Compression Option

(Read-Write) Set and read the stop power level.

Parameters

- <ch> Any existing GCA channel. If unspecified, value is set to 1.
- <num> Stop power level in dBm. Choose a value from +30 to (-30).

Examples

```
SENS:GCS:POW:STOP:LEV 0  
sense:gcsetup:power:stop:level -5
```

Query Syntax SENSE<ch>:GCSetup:POWER:STOP:LEVel?

Return Type Numeric

Default -5

SENSE<ch>:GCSetup:SAFE:CPADjustment <num>

Applicable Models: All with Gain Compression Option

(Read-Write) Set and read the Safe Sweep COARSE power adjustment. [Learn more.](#)

Parameters

- <ch> Any existing GCA channel. If unspecified, value is set to 1.
- <num> Coarse power adjustment setting in dBm. Choose a value between 0 and 6.

Examples

```
SENS:GCS:SAFE:CPAD 2  
sense:gcsetup:safe:cpadjustment 3.5
```

Query Syntax SENSE<ch>:GCSetup:SAFE:CPADjustment?

Return Type Numeric

Default 3.0

SENSE<ch>:GCSetup:SAFE:ENABLE <bool>

Applicable Models: All with Gain Compression Option

(Read-Write) Set and read the (ON | OFF) state of Safe Sweep mode. [Learn more](#)

Parameters

- <ch> Any existing GCA channel. If unspecified, value is set to 1.
- <num> **(Boolean)** - Safe Sweep state. Choose from:
 - OFF (or 0)** - Disable Safe Sweep
 - ON (or 1)** - Enable Safe Sweep

Examples

```
SENS:GCS:SAFE:ENAB 0  
sense:gcsetup:safe:enable 1
```

Query Syntax SENSE<ch>:GCSetup:SAFE:ENABLE?

Return Type Boolean

Default 0

SENSE<ch>:GCSetup:SAFE:FPADjustment <num>

Applicable Models: All with Gain Compression Option

(Read-Write) Set and read the Safe Sweep FINE power adjustment. [Learn more](#)

Parameters

- <ch> Any existing GCA channel. If unspecified, value is set to 1.
- <num> Fine power adjustment setting in dBm. Choose a value between 0 and 3.

Examples

```
SENS:GCS:SAFE:FPAD 2  
sense:gcsetup:safe:fpadjustment .5
```

Query Syntax SENSE<ch>:GCSetup:SAFE:FPADjustment?

Return Type Numeric

Default 1.0 dBm

SENSE<ch>:GCSetup:SAFE:FTHReshold <num>

Applicable Models: All with Gain Compression Option

(Read-Write) Set and read the compression level in which Safe Sweep changes from the COARSE power adjustment to the FINE power adjustment. [Learn more](#)

Parameters

- <ch> Any existing GCA channel. If unspecified, value is set to 1.
- <num> Threshold setting in dB. Choose a value between 0 and 3.

Examples

```
SENS:GCS:SAFE:FTHR .1  
sense:gcsetup:safe:fthreshold .75
```

Query Syntax SENSE<ch>:GCSetup:SAFE:FTHReshold?

Return Type Numeric

Default 0.5 dB

SENSE<ch>:GCSetup:SAFE:MLimit <num>

Applicable Models: All with Gain Compression Option

(Read-Write) When the VNA port that is connected to the DUT Output measures this value, the input power to the DUT is no longer incremented at that frequency. Safe Mode must be enabled with `SENS:GCS:SAFE:ENAB ON` [Learn more](#)

Parameters

- <ch> Any existing GCA channel. If unspecified, value is set to 1.
- <num> Maximum power limit in dBm. Choose a value from -100 to +100

Examples

```
SENS:GCS:SAFE:MLIM 20  
sense:gcsetup:safe:mlimit 30
```

Query Syntax SENSE<ch>:GCSetup:SAFE:MLIMit?

Return Type Numeric

Default 30

SENSE<ch>:GCSetup:SFAilures?

Applicable Models: All with Gain Compression Option

(Read-only) Returns a comma-separated list of the frequency indexes that were out of tolerance for SMART Sweep mode, or at the power limit for 2D acquisition modes. Zero (0) is the first frequency data point.

Must be Single triggered. Invalid results occur if the GCA channel is continuously sweeping.

Parameters

- <ch> Any existing GCA channel. If unspecified, value is set to 1.

Examples

```
SENS:GCS:SFA?  
sense:gcsetup:sfailures?
```

Return Type Comma-separated list of frequency indexes.

Default Not Applicable

SENSE<ch>:GCSetup:SMART:CDC <bool>

Applicable Models: All with Gain Compression Option

(Read-Write) Set and read the DC readings at the compression point in the last iteration of a smart sweep. Taking only these DC readings improves measurement speed.

Parameters

- <ch> Any existing GCA channel. If unspecified, value is set to 1.
- <bool> Choose from:
 - ON** or **(1)** Enable reading DC value at compression point in the last iteration of a smart sweep.
 - OFF** or **(0)** Disable reading DC value at compression point in the last iteration of a smart sweep.

Examples

```
SENS:GCS:SMAR: CDC 1  
sense:gcsetup:smart:cdc off
```

Query Syntax SENSE<ch>:GCSetup:SMART: CDC?

Return Type Boolean

Default OFF

SENSe<ch>:GCSetup:SMART:MITerations <num>

Applicable Models: All with Gain Compression Option

(Read-Write) Set and read the maximum permitted number of iterations which SMART Sweep may utilize to find the desired compression level, to within the specified tolerance.

Parameters

- <ch> Any existing GCA channel. If unspecified, value is set to 1.
- <num> Maximum number of iterations. Choose a value between 1 and 500

Examples

```
SENS:GCS:SMAR: MIT 5  
sense:gcsetup:smart:miterations 3
```

Query Syntax SENSE<ch>:GCSetup:SMART:MITerations?

Return Type Numeric

Default 20

SENSe<ch>:GCSetup:SMART:SITerations <bool>

Applicable Models: All with Gain Compression Option

(Read-Write) Set and read enable for showing intermediate results for each iteration of SMART Sweep

Parameters

- <ch> Any existing GCA channel. If unspecified, value is set to 1.
- <bool> Choose from:
 - ON** or **(1)** Compression traces are updated after each iteration.
 - OFF** or **(0)** Compression traces are updated after ALL iterations are complete.

Examples

```
SENS:GCS:SMAR:SIT 1
sense:gcsetup:smart:siterations off
```

Query Syntax SENSE<ch>:GCSetup:SMART:SIterations?

Return Type Boolean

Default OFF

SENSe<ch>:GCSetup:SMART:STIME <num>

Applicable Models: All with Gain Compression Option

(Read-Write) Set and read the amount of time SMART Sweep will dwell at the first point where the input power changes by the Backoff or X level. Applies only to SMART Sweep when Backoff or XY compression methods are selected. [Learn more.](#)

Parameters

- <ch> Any existing GCA channel. If unspecified, value is set to 1.
- <num> Settling time in seconds. Choose any positive value.

Examples

```
SENS:GCS:SMAR:STIM 1
sense:gcsetup:smart:stime .1
```

Query Syntax SENSe<ch>:GCSetup:SMART:STIME?

Return Type Numeric

Default 0

SENSe<ch>:GCSetup:SMART:TOLerance <num>

Applicable Models: All with Gain Compression Option

(Read-Write) Set and read the acceptable range SMART Sweep will allow for the measured compression level.

Parameters

- <ch> Any existing GCA channel. If unspecified, value is set to 1.
- <num> Tolerance level in dBm. Choose a value between .01 and 10

Examples

```
SENS:GCS:SMAR:TOL .1  
  
sense:gcsetup:smart:tolerance .05
```

Query Syntax SENSE<ch>:GCSetup:SMART:TOLerance?

Return Type Numeric

Default .05

SENSe<ch>:GCSetup:SWEep:FREQuency:POINts <num>

Applicable Models: All with Gain Compression Option

(Read-Write) Set and read the number of data points in each frequency sweep. [Learn more](#)

Parameters

- <ch> Any existing GCA channel. If unspecified, value is set to 1.
- <num> Frequency points. Do not exceed the max number of data points.

[See Data Points Limit](#)

Examples

```
SENS:GCS:SWE:FREQ:POIN 201  
  
sense:gcsetup:sweep:frequency:points 101
```

Query Syntax SENSe<ch>:GCSetup:SWEep:FREQuency:POINts?

Return Type Numeric

Default 201

SENSe<ch>:GCSetup:SWEep:POWER:POINts <num>

Applicable Models: All with Gain Compression Option

(Read-Write) Set and read the number of data points in each power sweep. Applies ONLY to 2D acquisition modes.

Parameters

- <ch> Any existing GCA channel. If unspecified, value is set to 1.
- <num> Power points. Do not exceed the max number of data points.

[See Data Points Limit](#)

Examples

```
SENS:GCS:SWE:POW:POIN 50  
sense:gcsetup:sweep:power:points 21
```

Query Syntax SENSE<ch>:GCSetup:SWEEp:POWER:POINTs?

Return Type Numeric

Default 21

Sense:Mixer Commands

Performs Mixer setup and configuration.

```
SENSe:MIXer:  
  APPLy  
  AVOIdspurs  
  CALCulate  
  DISCard  
  IF:FREQ:  
    | SIDeband  
    | STARt  
    | STOP  
  INPut:FREQ:  
    | DENominator  
    | FIXed  
    | MODE  
    | NUMerator  
    | STARt  
    | STOP  
  INPut:POWer  
    | STARt  
    | STOP  
    | USENominal  
  LO:FREQ:  
    | DENominator  
    | FIXed  
    | ILTI  
    | MODE  
    | NUMerator  
    | STARt  
    | STOP  
  LO:NAME  
  LO:POWer  
    | STARt  
    | STOP  
  LOAD  
  NORMalize:POINT  
  OUTPut:FREQ:  
    | FIXed  
    | MODE  
    | SIDeband  
    | STARt
```

STOP
PHASe
PMAp
INPut
OUTPut
RECalculate
REVerse
ROLE
CAalog?
DEvice
SAVE
SEGment More Commands
STAGe (number of LOs)
XAXis

Click on a keyword to view the command details.

See Also

- [Example Programs](#)
- [Learn about the Frequency Converter Application](#)
- [Synchronizing the Analyzer and Controller](#)
- [SCPI Command Tree](#)

Note: If you are changing several mixer configuration settings, you can make all the changes first and then issue the **Calculate** and **Apply** commands as you would do from the user interface.

SENSe<ch>:MIXer:APPLy

Applicable Models: All

(Write only) Applies the mixer setup settings and turns the channel ON. (Performs the same function as the Apply button on the **mixer setup dialog box**).

Parameters

<ch> Any existing channel number. If unspecified, value is set to 1

Examples

SENS : MIX : APPL

Query Syntax Not Applicable

Default Not Applicable

SENSe<ch>:MIXer:AVOIdspurs <bool>

Applicable Models: N522xB, N523xB, N524xB

(Read Write) Sets and returns the state of the avoid spurs feature. [Learn more about avoid spurs.](#)

Parameters

- <ch> Any existing channel number. If unspecified, value is set to 1
- <bool> Avoid spurs state. Choose from
 - 0 - Avoid spurs OFF
 - 1 - Avoid spurs ON

Examples

```
SENS:MIX:AVO  
sense2:mixer:avoidspurs 1
```

Query Syntax SENSe<ch>:MIXer:AVOIdspurs?

Return Type Boolean

Default 0 (OFF)

SENSe<ch>:MIXer:CALCulate <char>

Applicable Models: All

(Write only) Calculates the Input, IF, or Output frequencies of the mixer setup and updates the channel settings.

Note: The target mode must be swept. This command does not allow calculation of fixed values.

Parameters

- <ch> Any existing channel number. If unspecified, value is set to 1
- <char> Mixer port to be calculated. Choose from:

<char>	1st or only stage requires:	In addition, 2nd stage requires:
INPut	<ul style="list-style-type: none"> • Output Start/Stop/Fixed frequencies • LO Start/Stop/Fixed frequencies • Output sideband (High or Low) 	<ul style="list-style-type: none"> • IF Start/Stop/Fixed frequencies • 2nd Start/Stop/Fixed frequencies • IF sideband (High or Low)
BOTH	NA	<ul style="list-style-type: none"> • IF Start/Stop/Fixed frequencies • Both Start/Stop/Fixed frequencies
OUTPut	<ul style="list-style-type: none"> • Input Start/Stop/Fixed frequencies • LO Start/Stop/Fixed frequencies • Output sideband (High or Low) 	<ul style="list-style-type: none"> • IF Start/Stop/Fixed frequencies • 2nd Start/Stop/Fixed frequencies • IF sideband (High or Low)
LO_1	<ul style="list-style-type: none"> • Input Start/Stop/Fixed frequencies • Output Start/Stop/Fixed frequencies • Output sideband (High or Low) 	<ul style="list-style-type: none"> • IF Start/Stop/Fixed frequencies • 2nd Start/Stop/Fixed frequencies • IF sideband (High or Low)
LO_2	NA	<ul style="list-style-type: none"> • Input Start/Stop/Fixed frequencies • 1st LO Start/Stop/Fixed frequencies • Output Start/Stop/Fixed frequencies • IF sideband(High or Low) • Output sideband(High or Low)

Examples

SENS:MIX:CALC Output

Query Syntax Not Applicable

Default Not Applicable

SENSe<ch>:MIXer:DISCard

Applicable Models: All

(Write only) Cancels changes that have been made to the Converter setup and reverts to the previously-saved setup. Same as the Cancel button on the **mixer setup dialog box**.

Parameters

<ch> Any existing channel number. If unspecified, value is set to 1

Examples `SENS:MIX:DISC`

Query Syntax Not Applicable

Default Not Applicable

SENSe<ch>:MIXer:IF:FREQuency:SIDeband <char>

Applicable Models: All

(Read-Write) When **two LO stages are used**, sets or returns whether to select the sum or difference for the IF1 product. (Input + or - LO1 = IF1)

- This setting corresponds to the  buttons on LO1 on the **Mixer setup dialog**
- This setting is ignored when **ONE LO stage** is selected.
- Also set `SENS:MIX:OUTP:FREQ:SID` to LOW or HIGH to determine the output frequency of the mixer.

See Note

Parameters

<ch> Any existing channel number. If unspecified, value is set to 1.

<char> Sideband value. Choose from

LOW - Difference (-)

HIGH - Sum (+)

Examples `SENS:MIX:IF:FREQ:SID LOW`
`SENSe2:MIXer:IF:FREQ:SIDeband HIGH`

Query Syntax SENSE<ch>:MIXer:IF:FREQuency:SIDeband?
Return Type Character
Default LOW

SENSe<ch>:MIXer:IF:FREQuency:STARt <num>

Applicable Models: All

(Read-Write) Sets or returns the IF start frequency value of the mixer. [See Note](#)

Parameters

<ch> Any existing channel number. If unspecified, value is set to 1.
<num> IF Start Frequency value

Examples

```
SENS:MIX:IF:FREQ:STAR 1e9  
SENSe2:MIXer:IF:FREQ:STARt 1000000000
```

Query Syntax SENSE<ch>:MIXer:IF:FREQuency:STARt?

Return Type Numeric

Default Not Applicable

SENSe<ch>:MIXer:IF:FREQuency:STOP <num>

Applicable Models: All

(Read-Write) Sets or returns the stop frequency value of the mixer IF frequency. [See Note](#)

Parameters

<ch> Any existing channel number. If unspecified, value is set to 1.
<num> IF Stop Frequency value

Examples

```
SENS:MIX:IF:FREQ:STOP 2e9  
SENSe2:MIXer:IF:FREQ:STOP 2000000000
```

Query Syntax SENSE<ch>:MIXer:IF:FREQuency:STOP?

Return Type Numeric

Default Not Applicable

SENSe<ch>:MIXer:INPut:FREQuency:DENominator <value>

Applicable Models: All

(Read-Write) Sets or returns the denominator value of the Input Fractional Multiplier. [See Note](#)

Parameters

<ch> Any existing channel number. If unspecified, value is set to 1.

<value> Input denominator value.

Examples

```
SENS:MIX:INP:FREQ:DEN 5  
SENS2:MIXer:INPut:FREQ:DENominator 4
```

Query Syntax SENSE<ch>:MIXer:INPut:FREQuency:DENominator?

Return Type Numeric

Default Not Applicable

SENSe<ch>:MIXer:INPut:FREQuency:FIXed<value>

Applicable Models: All

(Read-Write) Sets or returns the fixed frequency of the input. [See Note](#)

Parameters

<ch> Any existing channel number. If unspecified, value is set to 1.

<value> Input frequency.

Examples

```
SENSe:MIXer:INPut:FREQ:FIXed 1e9  
SENSe2:MIXer:INPut:FREQ:FIXed 1000000000
```

Query Syntax SENSe<ch>:MIXer:INPut:FREQuency:FIXed?

Return Type Numeric

Default Not Applicable

SENSe<ch>:MIXer:INPut:FREQuency:MODE <char>

Applicable Models: All

(Read-Write) Sets or returns the Input sweep mode.

Parameters

- <ch> Any existing channel number. If unspecified, value is set to 1.
- <char> Input sweep mode. Choose either **FIXED** or **SWEPT**

Examples

```
SENS:MIX:INP:FREQ:MODE FIXED  
SENSe2:MIXer:INP:FREQ:MODE swept
```

Query Syntax SENSE<ch>:MIXer:INPut:FREQuency:MODE?

Return Type Character

Default Fixed

SENSe<ch>:MIXer:INPut:FREQuency:NUMerator <value>

Applicable Models: All

(Read-Write) Sets or returns the numerator value of the Input Fractional Multiplier. [See Note](#)

Parameters

- <ch> Any existing channel number. If unspecified, value is set to 1.
- <value> Input numerator value.

Examples

```
SENS:MIX:INP:FREQ:NUM 3  
SENSe2:MIXer:INPut:FREQ:NUMerator 1
```

Query Syntax SENSE<ch>:MIXer:INPut:FREQ:NUMerator?

Return Type Numeric

Default Not Applicable

SENSe<ch>:MIXer:INPut:FREQuency:STARt <value>

Applicable Models: All

(Read-Write) Sets or returns the Input start frequency value of the mixer. [See Note](#)

Parameters

- <ch> Any existing channel number. If unspecified, value is set to 1.
- <value> Input Start frequency

Examples

```
SENS:MIX:INP:FREQ:STAR 1e9
SENSe2:MIXer:INPut:FREQ:START 1000000000
```

Query Syntax SENSE<ch>:MIXer:INPut:FREQuency:START?

Return Type Numeric

Default Not Applicable

SENSe<ch>:MIXer:INPut:FREQuency:STOP <value>

Applicable Models: All

(Read-Write) Sets or returns the Input stop frequency value of the mixer. [See Note](#)

Parameters

- <ch> Any existing channel number. If unspecified, value is set to 1.
- <value> Input stop frequency

Examples

```
SENS:MIX:INP:FREQ:STOP 2e9
SENSe2:MIXer:INPut:FREQ:STOP 2000000000
```

Query Syntax SENSE<ch>:MIXer:INPut:FREQuency:STOP?

Return Type Numeric

Default Not Applicable

SENSe<ch>:MIXer:INPut:POWer <value>

Applicable Models: All

(Read-Write) Sets or returns the value of the Input Power.

Parameters

- <ch> Any existing channel number. If unspecified, value is set to 1.
- <value> Input power in dBm.

Examples

```
SENS:MIX:INP:POW 9  
SENSe2:MIXer:INPut:POWer 5
```

Query Syntax SENSe<ch>:MIXer:INPut:POWer?

Return Type Numeric

Default Not Applicable

SENSe<ch>:MIXer:INPut:POWer:START <value>

Applicable Models: All

(Read-Write) Sets the input start power for a power sweep in a mixer channel like SMC. The value is only used when the sweep type is power sweep.

Parameters

- <ch> Any existing channel number. If unspecified, value is set to 1.
- <value> Input power value in units of dBm.

Examples

```
SENS:MIX:INP:POW STAR 6  
SENSe2:MIXer:INPut:POWer:START 5
```

Query Syntax SENSe<ch>:MIXer:INPut:POWer:START?

Return Type Numeric

Default Not Applicable

SENSe<ch>:MIXer:INPut:POWer:STOP <value>

Applicable Models: All

(Read-Write) Sets the input stop power for a power sweep in a mixer channel . The value is only used when the sweep type is power sweep.

Parameters

<ch> Any existing channel number. If unspecified, value is set to 1.

<value> Input power value in units of dBm.

Examples

```
SENS:MIX:INP:POW STOP 9  
SENSe2:MIXer:INPut:POWer:STOP 5
```

Query Syntax SENSE<ch>:MIXer:INPut:POWer:STOP?

Return Type Numeric

Default Not Applicable

SENSe<ch>:MIXer:INPut:POWer:USENominal <bool>

Applicable Models: All

(Read-Write) Toggles the Use Nominal Incident Power setting ON and OFF. This setting is ONLY to be used with SMC measurements. [Learn more about Nominal Incident Power.](#)

Parameters

<ch> Any existing channel number. If unspecified, value is set to 1.

<value> **(boolean)** - Nominal Incident Power State. Choose from:

ON (1) - Turn nominal incident power ON

OFF (0) - Turn nominal incident power OFF

Examples

```
SENS:MIX:INP:POW:USEN 1  
SENSe2:MIXer:INPut:POWer:USENominal OFF
```

Query Syntax SENSE<ch>:MIXer:INPut:POWer:USENominal?

Return Type Boolean

Default OFF

SENSe<ch>:MIXer:LO<n>:FREQuency:DENominator <value>

Applicable Models: All

(Read-Write) Sets or returns the denominator value of the LO Fractional Multiplier. [See Note](#)

Parameters

- <ch> Any existing channel number. If unspecified, value is set to 1.
- <n> LO stage number. Choose 1 or 2.
- <value> LO denominator.

Examples

```
SENS:MIX:LO:FREQ:DEN 5  
SENSe2:MIXer:LO2:FREQ:DENominator 4
```

Query Syntax SENSE<ch>:MIXer:LO<n>:FREQuency:DENominator?

Return Type Numeric

Default 1

SENSe<ch>:MIXer:LO<n>:FREQuency:FIXed <value>

Applicable Models: All

(Read-Write) Sets or returns the fixed frequency of the specified mixer LO. [See Note](#)

Parameters

- <ch> Any existing channel number. If unspecified, value is set to 1.
- <n> LO stage number. Choose 1 or 2
- <value> LO frequency.

Examples

```
SENS:MIX:LO:FREQ:FIX 1e9  
SENSe2:MIXer:LO2:FREQ:FIXed 1000000000
```

Query Syntax SENSE<ch>:MIXer:LO<n>:FREQuency:FIXed?

Return Type Numeric

Default Not Applicable

SENSe<ch>:MIXer:LO<n>:FREQuency:ILTl <bool>

Applicable Models: All

(Read-Write) Specifies whether to use the Input frequency that is **greater than** the LO or **less than** the LO. To learn more, see the **mixer setup** dialog box help.

Parameters

- <ch> Any existing channel number. If unspecified, value is set to 1.
- <n> LO stage number. Choose **1** or **2**
- <bool> **ON (1)** - Use the Input that is Greater than the specified LO.
OFF (0) - Use the Input that is Less than the specified LO.

Examples

```
SENS:MIX:LO1:FREQ:ILTI 1  
sense2:mixer:lo2:frequency:ilti ON
```

Query Syntax SENSE<ch>:MIXer:LO<n>:FREQuency:ILTI?

Return Type Boolean

Default OFF

SENSe<ch>:MIXer:LO<n>:FREQuency:MODE <char>

Applicable Models: All

(Read-Write) Sets or returns the LO sweep mode.

Parameters

- <ch> Any existing channel number. If unspecified, value is set to 1.
- <n> LO stage number. Choose **1** or **2**
- <char> LO sweep mode. Choose either **FIXED** or **SWEPT**

Examples

```
SENS:MIX:LO:FREQ:MODE FIXED  
SENSe2:MIXer:LO2:FREQ:MODE swept
```

Query Syntax SENSE<ch>:MIXer:LO<n>:FREQuency:MODE?

Return Type Character

Default Fixed

SENSe<ch>:MIXer:LO<n>:FREQuency:NUMerator <value>

Applicable Models: All

(Read-Write) Sets or returns the numerator value of the LO Fractional Multiplier. [See Note](#)

Parameters

- <ch> Any existing channel number. If unspecified, value is set to 1.
- <n> LO stage number. Choose **1** or **2**
- <value> LO Numerator.

Examples

```
SENS:MIX:LO:FREQ:NUM 5  
SENSe2:MIXer:LO2:FREQ:NUMerator 4
```

Query Syntax SENSE<ch>:MIXer:LO<n>:FREQuency:NUMerator?

Return Type Numeric

Default Not Applicable

SENSe<ch>:MIXer:LO<n>:FREQuency:STARt <value>

Applicable Models: All

(Read-Write) Sets or returns the LO start frequency value. [See Note](#)

Parameters

- <ch> Any existing channel number. If unspecified, value is set to 1.
- <n> LO stage number. Choose **1** or **2**
- <value> LO Start Frequency in Hertz.

Examples

```
SENS:MIX:LO:FREQ:STAR 5E9
```

Query Syntax SENSE<ch>:MIXer:LO<n>:FREQuency:STARt?

Return Type Numeric

Default Not Applicable

SENSe<ch>:MIXer:LO<n>:FREQuency:STOP <value>

Applicable Models: All

(Read-Write) Sets or returns the LO stop frequency value. [See Note](#)

Parameters

- <ch> Any existing channel number. If unspecified, value is set to 1.
- <n> LO stage number. Choose **1** or **2**
- <value> LO Stop Frequency in Hertz.

Examples

```
SENS:MIX:LO:FREQ:STOP 5E9
```

Query Syntax SENSE<ch>:MIXer:LO<n>:FREQuency:STOP?

Return Type Numeric

Default Not Applicable

SENSe<ch>:MIXer:LO<n>:NAME <value>

Applicable Models: All

(Read-Write) Sets or returns the name of the VNA internal source or external source to use as the LO in a converter measurement.

Important Note: This setting is immediately send to the channel configuration. First set and apply mixer frequency settings, then send this command. Otherwise, 'invalid setting' errors may occur.

See [Remotely Specifying a Source Port](#).

Parameters

- <ch> Any existing channel number. If unspecified, value is set to 1.
- <n> LO stage number. Choose 1 or 2.
- <value> **(string)** - LO Source name. Use [Source:CAT?](#) to return a list of valid source ports. An external source must be configured and selected to be valid. [Learn more about external source configuration](#).

Examples

```
SENS:MIX:LO:NAME "MySource"
```

Query Syntax SENSe<ch>:MIXer:LO<n>:NAME?

Return Type String

Default "Not Controlled"

SENSe<ch>:MIXer:LO<n>:POWER <value>

Applicable Models: All

(Read-Write) Sets or returns the LO Power fixed value.

Parameters

- <ch> Any existing channel number. If unspecified, value is set to 1.
- <n> LO stage. Choose **1** or **2**
- <value> LO Power in dBm

Examples `SENS:MIX:LO:POW 9`

Query Syntax `SENSe<ch>:MIXer:LO<n>:POWER?`

Return Type Numeric

Default Not Applicable

`SENSe<ch>:MIXer:LO<n>:POWER:START <value>`

Applicable Models: All

(Read-Write) For an LO power sweep, sets or returns the LO power start value.

Parameters

- <ch> Any existing channel number. If unspecified, value is set to 1.
- <n> LO stage. Choose **1**
- <value> LO start power in dBm

Examples `SENS:MIX:LO1:POW:STAR -10`

Query Syntax `SENSe<ch>:MIXer:LO1:POWER:START?`

Return Type Numeric

Default - 20 dBm

`SENSe<ch>:MIXer:LO<n>:POWER:STOP <value>`

Applicable Models: All

(Read-Write) For an LO power sweep, sets or returns the LO power stop value.

Parameters

- <ch> Any existing channel number. If unspecified, value is set to 1.
- <n> LO stage. Choose 1
- <value> LO stop power in dBm

Examples

```
SENS:MIX:LO1:POW:STOP 10
```

Query Syntax SENSE<ch>:MIXer:LO1:POWer:STOP?

Return Type Numeric

Default -10 dBm

SENSE<ch>:MIXer:LOAD <name>

Applicable Models: All

(Write-only) Loads a previously-configured mixer attributes file (.mxr)

Parameters

- <ch> Any existing channel number. If unspecified, value is set to 1.
- <name> Path and file name (including .mxr extension) to load.

Examples

```
SENSE:MIXer:LOAD "C:/Program Files/Keysight/Network Analyzer/Documents/Mixer/MyMixer.mxr"
```

Default Not Applicable

SENSE<ch>:MIXer:NORMALize:POINT <value>

Applicable Models: All

(Read-Write) Sets or returns the data point for normalizing the phase measurement. [Learn more.](#)

Parameters

- <ch> Channel number of the SMC measurement. If unspecified, value is set to 1.
- <value> Normalization data point. Choose a data point number between 1 and the max number of data points in the sweep that has the least amount of expected noise.

Examples

```
SENS:MIX:NORM:POIN 101  
sense2:mixer:normalize:point 50
```

Query Syntax SENSE<ch>:MIXer:NORMalize:POINT?

Return Type Numeric

Default Middle point in the sweep

SENSe<ch>:MIXer:OUTPut:FREQuency:FIXed <value>

Applicable Models: All

(Read-Write) Sets or returns the output fixed frequency of the mixer. [See Note](#)

Parameters

- <ch> Any existing channel number. If unspecified, value is set to 1.
- <value> Output fixed frequency in Hertz.

Examples

```
SENS:MIX:OUTP:FREQ:FIX 5e9
```

Query Syntax SENSE<ch>:MIXer:OUTPut:FREQuency:FIXed?

Return Type Numeric

Default Not Applicable

SENSe<ch>:MIXer:OUTPut:FREQuency:MODE <char>

Applicable Models: All

(Read-Write) Sets or returns the Output sweep mode.

Parameters

<ch> Any existing channel number. If unspecified, value is set to 1.

<char> Output sweep mode. Choose either **FIXED** or **SWEPT**

Examples

```
SENS:MIX:OUTP:FREQ:MODE FIXED
SENSe2:MIXer:OUTPut:FREQuency:MODE swept
```

Query Syntax SENSE<ch>:MIXer:OUTPut:FREQuency:MODE?

Return Type Character

Default Fixed

SENSe<ch>:MIXer:OUTPut:FREQuency:SIDeband <value>

Applicable Models: All

(Read-Write) Specify whether to select the sum (High) or difference (Low) products.

- When one LO is used: Input + or - LO1 = Output frequency
- When two LOs are used: IF1 + or - LO2 = Output frequency

Use **SENS:MIX:IF:FREQ:SID** when two LOs are used to determine the IF1 frequency.

Use **Sens:Mixer:Stage** to set 1 or 2 LOs

See Note

Parameters

<ch> Any existing channel number. If unspecified, value is set to 1.

<value> Sideband value. Choose from

LOW - Low or Difference (-)

HIGH - High or Sum (+)

Examples

```
SENS:MIX:OUTP:FREQ:SID LOW
SENSe2:MIXer:OUTPut:FREQ:SIDeband HIGH
```

Query Syntax SENSE<ch>:MIXer:OUTPut:FREQuency:SIDeband?

Return Type Character

Default LOW

SENSe<ch>:MIXer:OUTPut:FREQuency:STARt <value>

Applicable Models: All

(Read-Write) Sets or returns the Output start frequency of the mixer. [See Note](#)

Parameters

- <ch> Any existing channel number. If unspecified, value is set to 1.
- <value> Output start frequency

Examples

```
SENS:MIX:OUTP:FREQ:STAR 1e9
SENSe2:MIXer:OUTPut:FREQ:STARt 1000000000
```

Query Syntax SENSe<ch>:MIXer:OUTPut:FREQuency:STARt?

Return Type Numeric

Default Not Applicable

SENSe<ch>:MIXer:OUTPut:FREQuency:STOP <value>

Applicable Models: All

(Read-Write) Sets or returns the Output stop frequency of the mixer. [See Note](#)

Parameters

- <ch> Any existing channel number. If unspecified, value is set to 1.
- <value> Output stop frequency

Examples

```
SENS:MIX:OUTP:FREQ:STOP 1e9
SENSe2:MIXer:OUTPut:FREQ:STOP 1000000000
```

Query Syntax SENSe<ch>:MIXer:OUTPut:FREQuency:STOP?

Return Type Numeric

Default Not Applicable

SENSe<ch>:MIXer:PHASe <bool>

Applicable Models: N522xB, N523xB, N524xB

(Read Write) Sets and returns the state of SMC Phase measurements and calibrations. [Learn more.](#)

In the User Interface, there are two "enable phase" checkboxes: in the [Phase Settings dialog](#) and in the [Calibration Wizard](#). Checking one enables both. This single command also enables both.

Parameters

- <ch> Any existing channel number. If unspecified, value is set to 1
- <bool> Include Phase measurement state. Choose from
- ON or 1 - Include phase in SMC measurements
 - OFF or 0 - Do NOT include phase in SMC measurements

Examples

```
SENS:MIX:PHAS 1
```

```
sense2:mixer:phase off
```

Query Syntax SENSE<ch>:MIXer:PHASe?

Return Type Boolean

Default 0 (OFF)

SENSe<ch>:MIXer:PMAP <in>,<out>

Applicable Models: All

(Write-only) Sets the VNA to DUT port map for FCA measurements. Use SENS:MIX:PMAP:INP? and SENS:MIX:PMAP:OUTP? to read these values. [Learn about selectable FCA DUT ports.](#)

Changing the ports may limit your ability to use an internal second source. If a selected port is shared by one of the sources, then that source will not be available as an LO source. [Learn more about Internal second sources.](#)

Parameters

- <ch> Any existing channel number. If unspecified, value is set to 1.
- <in> VNA port to connect to the DUT input.
- For SMC, choose any unused VNA port.
 - For VMC, set to 1.
- <out> VNA port to connect to the DUT output. Choose any unused port for SMC and VMC.

Examples `SENS:MIX:PMAP 2,1`
`sense2:mixer:pmap 4,2`

Query Syntax Not Applicable

Default 1,2

SENSe<ch>:MIXer:PMAP:INPut?

Applicable Models: All

(Read-only) Returns the VNA port that is mapped to the DUT input. Use `SENS:MIX:PMAP` to set this value.

Learn about [selectable FCA DUT ports](#).

Parameters

<ch> Any existing channel number. If unspecified, value is set to 1.

Examples `SENS:MIX:PMAP:INP?`
`sense2:mixer:pmap:input?`

Default 1

SENSe<ch>:MIXer:PMAP:OUTPut?

Applicable Models: All

(Read-only) Returns the VNA port that is mapped to the DUT output. Use `SENS:MIX:PMAP` to set this value.

Learn about [selectable FCA DUT ports](#).

Parameters

<ch> Any existing channel number. If unspecified, value is set to 1.

Examples `SENS:MIX:PMAP:OUTP?`
`sense2:mixer:pmap:output?`

Default 2

SENSe<ch>:MIXer:RECalculate

Applicable Models: All

(Write only) Repeats the last calculation that was performed, including all ON (state) segments in segment table.

Parameters

<ch> Any existing channel number. If unspecified, value is set to 1

Examples `SENS:MIX:REC`

Query Syntax Not Applicable

Default Not Applicable

SENSe<ch>:MIXer:REVerse <bool>

Applicable Models: All

(Read-Write) Sets whether to include SC12 sweeps during measurements.

Parameters

<ch> Any existing channel number. If unspecified, value is set to 1.

<bool> (Boolean) Choose from:

ON (1) - Include the SC12 (reverse) sweep.

OFF (0) - Do NOT Include the SC12 (reverse) sweep.

Examples `SENS:MIX:REV 1`
`sense2:mixer:reverse ON`

Query Syntax `SENSe<ch>:MIXer:REVerse?`

Return Type Boolean

Default ON (1)

SENSe<ch>:MIXer:ROLE:CATalog? - Superseded

Applicable Models: All

(Read-only) This command is replaced with SENSE:ROLE:CATalog which can be used by all channels.

Returns a list of valid roles for the IMD Converter application.

Parameters

<ch> Any existing channel number. If unspecified, value is set to 1.

Examples

```
SENS:MIX:ROLE:CAT?  
sense2:mixer:role:catalog?
```

Default Not Applicable

SENSe<ch>:MIXer:ROLE:DEvice <role>,<source> **Superseded**

Applicable Models: All

(Read-Write) This command is replaced with SENSE:ROLE:DEvice which can be used by all channels.

Assigns a configured external source to the specified role for the converter application.

Parameters

<ch> Any existing channel number. If unspecified, value is set to 1.

<role> (String) Role to which the external source is assigned. Choose from:

For IMDX and IMSX, choose from:

"RF2"

"LO1"

"LO2"

For all other converter applications, choose from:

"LO1"

"LO2"

<source> String) Source name from **Source Configuration dialog**.

Examples

```
SENS:MIX:ROLE:DEV "LO1","LO1Name"  
sense2:mixer:role:device "LO1","LO1Name"
```

Query Syntax SENSe<ch>:MIXer:ROLE:DEvice? <source>

Return Type String
Default Not Applicable

SENSe<ch>:MIXer:SAVE <name>

Applicable Models: All

(Write-only) Saves the settings for the mixer/converter test setup to a mixer attributes file.

Parameters

<ch> Any existing channel number. If unspecified, value is set to 1.
<name> Path and file name (including .mxrx extension) to save.

Examples `SENSe:MIXer:SAVE "C:/Program Files/Keysight/Network Analyzer/Documents/Mixer/MyMixer.mxrx"`

Default Not Applicable

SENSe<ch>:MIXer:STAGe <n>

Applicable Models: All

(Read-Write) Number of IF stages (LOs) used in the mixer. [See Note](#)

Parameters

<ch> Any existing channel number. If unspecified, value is set to 1.
<n> Number of stages. Choose either **1** or **2**

Examples `SENSe1:MIXer:LO1:FREQ:NUMerator 6
SENSe1:BWID 1000
SENSe1:MIXer:SEGMENT1:ADD 165
'New segments will reset stage to single stage mode. Therefore,
always add dual stage setting after adding segments
SENSe1:MIXer:STAGe 2`

Query Syntax SENSe<ch>:MIXer:STAGe?

Return Type Numeric

Default 1

SENSe<ch>:MIXer:XAXis <char>

Applicable Models: All

(Read-Write) Sets or returns the swept frequency range to display on the X-axis for the IMDx or NFx channel.

For FCA and GCX measurements, use **CALC:MEAS:MIXer:XAXis**

Parameters

- <ch> Channel number of the IMDx or NFx Converter measurement. If unspecified, value is set to 1.
- <char> Frequency range to display on the X-Axis. NOT case-sensitive. Choose from:
- **INPUT** - Input frequency range
 - **LO_1** - LO frequency range
 - **LO_2** - LO 2 frequency range
 - **OUTPUT** - Output frequency range

If the specified frequency range is not swept, the default swept range is used.

Examples

```
SENSe:MIXer:XAXis INPUT  
sense2:mixer:xaxis LO_1
```

Return Type Character

Default Search is made in the following order until a swept range is found:

1. OUTPUT
 2. INPUT (If the OUTPUT is fixed)
 3. Number of Points (If ALL ranges are fixed)
-

Sense:Multiplexer Commands

Controls External Test Sets (N44xx, E5092A, "Z", and "H" series).

SENSe:MULTiplexer:

ADDRes

ALLPorts

CATalog?

COUNt?

DISPlay

INCount?

LABel

OUTPut

| **A|B|C|D[DATA]**

| **A|B|C|D:VOLTage[DATA]**

| **[DATA]**

PORT

| **CATalog?**

| **SElect**

STATe

TSET9

| **OUTPut**

| **PORT1**

| **PORT2**

| **PORT3**

| **PORT4**

TYPE

Click on a keyword to view the command details.

Red commands are superseded.

See Also

- [See an example program](#) using these commands.
- [Learn about External Test Set Control](#)
- [Synchronizing the Analyzer and Controller](#)
- [SCPI Command Tree](#)

SENSe:MULTiplexer<id>:ADDRess <address>

Applicable Models: N522xB, N523xB, N524xB,E5080A

(Read-Write) Sets and returns the address for the external test set at the specified ID. This command should be immediately preceded by the **SENSe:MULT:TYPE** command.

Note: This command is **not** applicable to the E509xA USB test sets, on which the address is set by DIP switches on the rear panel.

Parameters

<id> Id of the external test set. If unspecified, Id is assumed to be 1. Must be previously set by the **SENSe:MULT:TYPE** command.

<address> Integer The test set address.

- For a GPIB test set (N44xx and some specials), this is the GPIB address.
- For a test set I/O test set (some specials), it is the position of the test set in the chain (starting at 0).

Examples

```
SENS:MULT1:TYPE "Z5623A_K66" ' use K66 test set, and reference it
through ID 1
SENS:MULT1:ADDR 0 ' first test set in sequence
' All subsequent commands using SENS:MULT1 will refer to this
test set
```

Query Syntax SENSe:MULTiplexer<id>:ADDRess?

Return Type Numeric

Default Not Applicable

SENSe<cnum>:MULTiplexer<id>:ALLPorts <string>

Applicable Models: N522xB, N523xB, N524xB, E5080A

(Read-Write) Sets or gets the port selections for all available ports on the specified channel.

Parameters

<cnum> Any existing channel number. If unspecified, value is set to 1.

<id> Id of the external test set. If unspecified, Id is assumed to be 1. Must be previously set by the **SENSe:MULT:TYPE** command.

<string> Comma-separated list of port selections, one for each port. Each port selection must correspond to one of the values returned by **SENS:MULT:PORT:CAT?**.

Do NOT include + and - .

Examples

```
' for channel 5 and test set 1, set port 1 to T1,  
' port 2 to A, port 3 to R2+, port 4 to R3-.  
SENS5:MULT1:ALLP "T1,A,R2,R3 "
```

Query Syntax SENSe<cnum>:MULTiplexer<id>:ALLPorts?

Return Type STRING

Default Not Applicable

SENSe:MULTiplexer:CATalog?

Applicable Models: N522xB, N523xB, N524xB, E5080A

(Read-Only) Returns a comma-separated list of the external test sets models that are currently supported. Choose one of these items to send **SENS:MULT1:TYPE**.

Examples SENS:MULT:CAT?

Return Type String

Default Not Applicable

SENSe:MULTiplexer<id>:COUNT?

Applicable Models: N522xB, N523xB, N524xB, E5080A

(Read-Only) Returns the total number of ports of the specified test set.

Returns 0 if no test set is connected (GPIB test sets only).

Parameters

<id> Id of the external test set. If unspecified, Id is assumed to be 1. Must be previously set by the **SENSe:MULT:TYPE** command.

Examples

```
SENS:MULT1:COUN?  
sense:multiplexer2:count?
```

Return Type Numeric

Default Not Applicable

SENSe:MULTiplexer<id>:DISPlay[:STATe] <bool>

Applicable Models: N522xB, N523xB, N524xB, E5080A

(Read-Write) Turns ON and OFF the display of the test set control status bar. This status bar indicates the test set that is being controlled and the current port mappings. This setting is turned ON automatically when the test set is enabled.

Parameters

<id> Id of the external test set. If unspecified, Id is assumed to be 1. Must be previously set by the **SENSe:MULT:TYPE** command.

<bool> ON(1) Turns ON the display.

OFF (0) Turns OFF the display.

Examples

```
SENS:MULT1:DISP 1  
sense:multiplexer2:display:state on
```

Query Syntax SENSe:MULTiplexer<id>:DISPlay[:STATe]?

Return Type Boolean

Default OFF (0)

SENSe:MULTiplexer<id>:INCount?

Applicable Models: N522xB, N523xB, N524xB, E5080A

(Read-Only) Returns the number of input ports for the specified test set.

- For test sets such as the E5092A that do NOT use jumper cables to route the stimulus and response signals, this command returns the number of test set ports that can be connected to the VNA.
- For test sets that DO use jumper cables to route the stimulus and response signals, such as the N44xx, the return value is not valid.

Parameters

<id> Id of the external test set. If unspecified, Id is assumed to be 1. Must be previously set by the **SENSe:MULT:TYPE** command.

Examples `SENS3:MULT1:INC? ' ' returns the number of input ports for test set 1 on channel 3`

Return Type Numeric

Default Not Applicable

SENSe<cnum>:MULTiplexer:LABel <string>

Applicable Models: N522xB, N523xB, N524xB, E5080A

(Read-Write) Sets and returns the display label for the testset on the specified channel. The label appears in a status bar at the bottom of the VNA display when **SENS:MULT:DISP** is set to ON.

Note: This command does not apply to the use of the E509xA test sets.

Parameters

<cnum> Any existing channel number. If unspecified, value is set to 1.

<string> Display label text.

Examples `SENS3:MULT:LAB 'High-power output'`

Query Syntax `SENSe<cnum>:MULTiplexer:LABel?`

Return Type String

Default Not Applicable

SENSe<cnum>:MULTiplexer<id>:OUTPut:<grp>[:DATA] <num>

Applicable Models: N522xB, N523xB, N524xB, E5080A

(Read-Write) Sets or returns the output port data for specified group with id of the E5092A multiport test set.

Parameters

- <cnm> Any existing channel number. If unspecified, value is set to 1.
- <id> Id of the external test set either 1 or 2. If unspecified, Id is assumed to be 1. Must be previously set by the **SENS:MULT:TYPE** command.
- <grp> A | B | C | D
- <num> An integer specifying the decimal value of the control line. Values are obtained by adding weights from the following table that correspond to individual lines.

The output port data range is between 0 to 255 (0=All lines are turned OFF and 255 all lines are turned ON).

Line	Weight
1	1
2	2
3	4
4	8
5	16
6	32
7	64
8	128

Examples `SENS3:MULT1:OUTP:B 8`

Query Syntax `SENSe<cnm>:MULTiplexer<id>:OUTPut:<grp>[:DATa]?`

Return Type Numeric

Default 0

`SENSe<cnm>:MULTiplexer<id>:OUTPut:<grp>:VOLTage[:DATA] <volt>`

Applicable Models: N522xB, N523xB, N524xB, E5080A

(Read-Write) Sets or returns the output voltage for specified group with id of the E5092A multiport test set.

Parameters

- <cnum> Any existing channel number. If unspecified, value is set to 1.
- <id> Id of the external test set either 1 or 2. If unspecified, Id is assumed to be 1. Must be previously set by the **SENS:MULT:TYPE** command.
- <grp> A | B | C | D
- <volt> Output voltage range for <grp> is between 0 to 5.2V and resolution is 10mV.

Examples `SENS3:MULT1:OUTP:B:VOLT 4.2`

Query Syntax `SENSe<cnum>:MULTiplexer<id>:OUTPut:<grp>:VOLtage[:DATa]?`

Return Type Numeric

Default 0 V

SENSe<cnum>:MULTiplexer<id>:OUTPut[:DATa] <num>

Applicable Models: N522xB, N523xB, N524xB, E5080A

(Read-Write) Sets or returns the control line value for the specified channel. If this command is used when the selected test set type is an E5092A test set type, then it reads/writes data just for "group A" of the test set's output lines.

Parameters

- <cnum> Any existing channel number. If unspecified, value is set to 1.
- <id> Id of the external test set. If unspecified, Id is assumed to be 1. Must be previously set by the **SENSe:MULT:TYPE** command.
- <numr> An integer specifying the decimal value of the control line. Values are obtained by adding weights from the following table that correspond to individual lines.

Line	Weight
1	1
2	2
3	4
4	8
5	16
6	32
7	64
8	128

Note:

- The E5092A interprets SENS:MULT1:OUTP 0 as all lines OFF.
- All "Z" and "H" series test sets interpret SENS:MULT1:OUTP 0 as all lines ON.

Refer to your test set documentation for setting control line values.

Examples

`SENS3:MULT1:OUTP 48` 'For Z5623A K64, lines 5 and 6 are OFF; all other lines are set to ON state.'

Query Syntax SENSE<cnum>:MULTiplexer<id>:OUTPut[:DATA]?

Return Type Numeric

Default Not Applicable

SENSe:MULTiplexer<id>:PORT<pnum>:CATalog?

Applicable Models: N522xB, N523xB, N524xB, E5080A

(Read-Only) Returns a comma-separated list of valid port selections for the specified port.

Parameters

<id> Id of the external test set. If unspecified, Id is assumed to be 1. Must be previously set by the **SENSe:MULT:TYPE** command.

<pnum> Integer - Input port number for which to return valid Output port selections. Read the number of input ports for the test set using **SENS:MULT:INCount?**

Examples

```
SENS:MULT1:PORT3:CAT? ' returns the valid port selections for port 3
```

Return Type String

Default Not Applicable

SENSe<cnum>:MULTiplexer<id>:PORT<pnum>:SElect <string>

Applicable Models: N522xB, N523xB, N524xB, E5080A

(Write-Only) Sets a port mapping for a single port. If this command creates a conflict with an existing port, the VNA will resolve the conflict.

Note: This command is not supported for the Z5623AK44.

Parameters

<cnum> Channel number of the measurement. If unspecified, value is set to 1.

<id> Id of the external test set. If unspecified, Id is assumed to be 1. Must be previously set by the **SENSe:MULT:TYPE** command.

<pnum> Integer - Logical port number.

<string> Physical port number.

Examples

```
SENS:MULT1:PORT3:SEL "4" 'sets logical port 3 to physical port 4.
```

Return Type String

Default Not Applicable

SENSe:MULTiplexer<id>:STATE <bool>

Applicable Models: N522xB, N523xB, N524xB, E5080A

(Read-Write) Enables and disables (ON/OFF) the port mapping and control line output of the specified test set.

If the specified test set is not connected or not ON, then setting State ON will report an error. All other properties can be set when the test set is not connected.

When this command is set to ON, then the display of the test set status bar (**SENS:MULT:DISP**) is also set to ON.

Parameters

- <id> Id of the external test set. If unspecified, Id is assumed to be 1. Must be previously set by the **SENSe:MULT:TYPE** command.
- <bool> ON(1) Enables test set control.
OFF (0) Disables test set control.

Examples

```
SENS:MULT1:STAT 1  
sense2:multiplexer2:state on
```

Query Syntax SENSE<num>:MULTiplexer<id>:STATe?

Return Type Boolean

Default OFF (0)

SENSe<num>:MULTiplexer<id>:TSET9:OUTPut[:DATA] <data> **Superseded**

Applicable Models: N522xB, N523xB, N524xB, E5080A

Note: This command is replaced with **SENS:MULT:OUTP**

(Read-Write) Sets the control lines of the specified E5091A. Control lines, provided through a E5091A front panel connector, are used to control external equipment such as a part handler. See your E5091A documentation to learn more about control lines.

Parameters

- <num> Channel number of the measurement. If unspecified, value is set to 1.
- <id> Id of the E5091A test set. Choose from 1 or 2. [Learn how to set ID value.](#)
- <data> Data value used to set control lines. Values are obtained by adding weights from the following table that correspond to individual lines. HIGH =1; LOW=0.

Line	Weight
1	1
2	2
3	4
4	8
5	16
6	32
7	64
8	128

0 - Sets all lines low

255 - Sets all lines high

Examples

'The following sets line 3 and 4 high. All other lines low.'

```
SENS:MULT1:TSET9:OUTP 12
```

Query Syntax SENSE<cnum>:MULTiplexer<id>:TSET9:OUTPut[:DATA]?

Return Type Numeric

Default 0

SENSe<cnum>:MULTiplexer<id>:TSET9:PORT1 <char> **Superseded**

Applicable Models: N522xB, N523xB, N524xB, E5080A

Note: This command is replaced with **SENS:MULT:ALLPorts** which sets ALL ports to the specified outputs.

(Read-Write) Switches Port 1 of the specified E5091A to one of the available outputs.

Parameters

<cnum> Any existing channel number; if unspecified, value is set to 1.

<id> Id of the E5091A test set. Choose from 1 or 2. [Learn how to set ID value.](#)

<char> Output port to be switched to. Choose from:

A

T1 - (If Port 2 already is connected to T1, then Port 2 will be switched to T2.)

Examples

```
SENS:MULT1:TSET9:PORT1 A
```

Query Syntax SENSE<cnum>:MULTiplexer<id>:TSET9:PORT1?
Return Type Character
Default A

SENSe<cnum>:MULTiplexer<id>:TSET9:PORT2 <char> **Superseded**

Applicable Models: N522xB, N523xB, N524xB, E5080A

Note: This command is replaced with **SENS:MULT:ALLPorts** which sets ALL ports to the specified outputs.

(Read-Write) Switches Port 2 of the specified E5091A to one of the available outputs.

Parameters

- <cnum> Any existing channel number; if unspecified, value is set to 1.
- <id> Id of the E5091A test set. Choose from 1 or 2. [Learn how to set ID value.](#)
- <char> Output port to be switched to. Choose from:

 T1 - If Port 1 already is connected to T1, then Port 1 will be switched to A.

T2

Examples

```
SENS:MULT1:TSET9:PORT2 T2
```

Query Syntax SENSE<cnum>:MULTiplexer<id>:TSET9:PORT2?
Return Type Character
Default T1

SENSe<cnum>:MULTiplexer<id>:TSET9:PORT3 <char> **Superseded**

Applicable Models: N522xB, N523xB, N524xB, E5080A

Note: This command is replaced with **SENS:MULT:ALLPorts** which sets ALL ports to the specified outputs.

(Read-Write) Switches Port 3 of the specified E5091A to one of the available outputs.

Parameters

- <num> Any existing channel number; if unspecified, value is set to 1.
- <id> Id of the E5091A test set. Choose from 1 or 2. [Learn how to set ID value.](#)
- <char> Output port to be switched to. Choose from:
 - R1** (R1+)
 - R2** (R2+)
 - R3** (R3+) If option 007 (7port), R2 is selected.

Examples

```
SENS:MULT1:TSET9:PORT3 R2
```

Query Syntax SENSE<num>:MULTiplexer<id>:TSET9:PORT3?

Return Type Character

Default R1

SENSe<num>:MULTiplexer<id>:TSET9:PORT4 <char> **Superseded**

Applicable Models: N522xB, N523xB, N524xB, E5080A

Note: This command is replaced with **SENS:MULT:ALLPorts** which sets ALL ports to the specified outputs.

(Read-Write) Switches Port 4 of the specified E5091A to one of the available outputs.

Parameters

- <num> Any existing channel number; if unspecified, value is set to 1.
- <id> Id of the E5091A test set. Choose from 1 or 2. [Learn how to set ID value.](#)
- <char> Output port to be switched to. Choose from:
 - R1** (R1-)
 - R2** (R2-)
 - R3** (R3-) If option 007 (7port), R2 is selected.

Examples `SENS:MULT1:TSET9:PORT4 R2`

Query Syntax `SENSe<num>:MULTiplexer<id>:TSET9:PORT4?`

Return Type Character

Default R1

SENSe:MULTiplexer<id>:TYPE <name>

Applicable Models: N522xB, N523xB, N524xB, E5080A

(Read-Write) If any E509xA test set is connected to the VNA's USB, or the VNA has **no** Test Set I/O hardware interface, then this command is expected to specify which configuration of E509xA test set is to be used. Otherwise if the VNA has a Test Set I/O hardware interface, this command loads a configuration file for the specified type of external test set.

If the selected test set type is **not** one of the E509xA configurations, then this command should be immediately followed by the **SENSe:MULT:ADDRess** command.

Parameters

<name> String The name of the type of test set. Must be one of the items in the list returned by the **SENSe:MULT:CATalog?** query.

<id> Id of the external test set. Set by this command. Use consecutive values starting at 1.

Examples `SENS:MULT1:TYPE "Z5623AK66" ' use K66 test set, and reference it through ID 1`

Query Syntax `SENSe:MULTiplexer<id>:TYPE?`

Return Type String

Default Not Applicable

SENSe:NOISe Commands

Controls the Noise Figure / NFX configuration and calibration.

```
SENSe:NOISe:
  AVERAge <num>
    | STATe <bool>
  BWIDth <num>
  CALibration:
    | METHod <string>
    | RMETHod <string>
  ENR:FILEname
  <string>
  EXDC:NAME
  GAIN <num>
    | CTCheck
  IMPedance:COUNt
  <num>
  NARRowband[:STATe]
  <bool>
  PMAP <in>,<out>
    | INPut?
    | OUTPut?
  PULL[:STATe] <bool>
  RECeiver <char>
  SNP? <string>
    | SAVE <string>
  SOURce:
    | CKIT <string>
    | CONNector
  <string>
```

<p>SWEEp</p> <p> TIME?</p> <p>TEMPerature:AMBient</p> <p><num></p> <p>TUNer:</p> <p> ID <string></p> <p> INPut <string></p> <p> ORlent[:STATe]</p> <p> OUTPut <string></p>

Click on a keyword to view the command details.

Other Noise Figure SCPI commands

The calibration commands listed in this topic are supplemental to the [Guided Cal commands](#).

- [CALCulate:MEASure:DEFine](#) - creates a noise figure measurement.
- [CONTrol:NOISe:SOURce](#) or [OUTPut:MANual:NOISe\[:STATe\]](#) - turns the Noise Source ON and OFF.
- [MMEMory:LOAD:ENR](#) and [MMEM:STORe:ENR](#) - load and save ENR files.
- [SENSe:PATH:CONF:ELEMent\[:STATe\]](#) - sets the port 1 and port 2 noise switches.
- [SENS:CORR:ENR:CAL:-](#) manage ENR data - usually not necessary.
- [SYST:PREF:ITEM:SWIT:DEF](#) - Sets the default setting of the Noise Tuner switch
- [SENS:CORR:NOISe](#) commands - noise calibration
- [SENS:CORR:Guided](#) commands - performs most of noise cal.

See Also

- **Examples:**
 - [Create and Cal a Noise Figure Measurement](#)
 - [Create and Cal an NFX Measurement](#)
- [Learn about Noise Figure Application](#)
- [Synchronizing the Analyzer and Controller](#)
- [SCPI Command Tree](#)

SENSe<ch>:NOISe:AVERAge[:COUNT] <num>

Applicable Models: All with with Noise Figure Option (S9x029A/B, 028, 029)

(Read-Write) Set and read the averaging factor for the noise receiver. [Learn more](#)

Parameters

- <ch> Noise Figure channel number. If unspecified, value is set to 1.
- <num> Averaging value. Choose any number from 1 to 99.

Examples

```
SENS:NOIS:AVER 20  
sense:noise:average:count 10
```

Query Syntax SENSe:NOISe:AVERAge[:COUNT]?

Return Type Numeric

Default 1

SENSe<ch>:NOISe:AVERAge:STATe <bool>

Applicable Models: VNAs with Noise Figure Option (S9x029A/B, 028, 029)

(Read-Write) Turns noise averaging ON and OFF.

Parameters

- <ch> Noise Figure channel number. If unspecified, value is set to 1.
- <bool> Averaging state. Choose from
 - 0 - Noise averaging OFF
 - 1 - Noise averaging ON

Examples

```
SENS:NOIS:AVER:STAT 0  
sense:noise:average:state 1
```

Query Syntax SENSe:NOISe:AVERAge:STATe?

Return Type Boolean

Default 0 - OFF

SENSe<ch>:NOISe:BWIDth[:RESolution] <num>

Applicable Models: All with Noise Figure Option (S9x029A/B, 028, 029)

(Read-Write) Set and read the bandwidth of the noise receiver. [Learn more](#)

Parameters

<ch> Noise Figure channel number. If unspecified, value is set to 1.

<num> Bandwidth value. Choose from:

For **Sens:Noise:Receiver = NOISe** (Opt 029) choose from: 800 KHz, 2 MHz, 4 MHz, 8 MHz, or 24 MHz or the numerical equivalent, such as 8e6 and so forth.

For **Sens:Noise:Receiver = NORMAl** (Opt 028) choose from: 720 kHz or 1.2 MHz

If the value does not match one of these, it is rounded up to the next valid bandwidth value.

Examples

```
SENS:NOIS:BWID 2e6
```

```
sense:noise:bandwidth:resolution 8mhz
```

Query Syntax SENSE:NOIS:BWIDth[:RESolution]?

Return Type Numeric

Default 4 MHz for Noise Receiver

1.2 MHz for Normal Receiver

SENSe<ch>:NOISe:CALibration:METHOD <string>

Applicable Models: All with Noise Figure Option (S9x029A/B, 028, 029)

(Read-Write) Set and read the method for performing a calibration on a noise channel.

Parameters

<ch> Noise Figure channel number. If unspecified, value is set to 1.

<string> Calibration method. NOT case-sensitive. Choose from:

- "VectorFull" or "Vector"
- "SParameter" (Not available for NFX measurements)
- "ScalarFull" or "Scalar"

Examples `SENS:NOIS:CAL:METH "Vector"`

```
sense:noise:calibration:method "SParameter"
```

Query Syntax `SENSe:NOISe:CALibration:METhod?`

Return Type String

Default "VectorFull"

SENSe<ch>:NOISe:CALibration:RMETHod <string>

Applicable Models: All with Noise Figure Option (S9x029A/B, 028, 029)

(Read-Write) Set and read the method used to characterize the noise receivers. [Learn more.](#)

Parameters

<ch> Noise Figure channel number. If unspecified, value is set to 1.

<string> Receiver characterization method. NOT case-sensitive. Choose from:

- "NoiseSource" - Use a noise source. This selection is NOT allowed when a standard VNA receiver is used as the noise receiver ([SENS:NOIS:REC NORM](#)).
- "PowerMeter" - Use a power meter. **NOTE:** This selection is NOT allowed when the [Noise Bandwidth](#) is 8 MHz or 24 MHz.

Examples `SENS:NOIS:CAL:RMET "PowerMeter"`

```
sense:noise:calibration:rmethod "noisesource"
```

Query Syntax `SENSe:NOISe:CALibration:RMETHod?`

Return Type String

Default "NoiseSource"

SENSe<ch>:NOISe:ENR:FILEname <string>

Applicable Models: All with Noise Figure Option (S9x029A/B, 028, 029)

(Read-Write) Set and read the path and name of the ENR file associated with the noise source.

Parameters

- <ch> Noise Figure channel number. If unspecified, value is set to 1.
- <string> Full path, filename, and extension of the ENR file.

Examples

```
SENS:NOIS:ENR:FIL "c:/ProgramFiles/Keysight/Network Analyzer/Documents/ENR/346C.enr"

sense:noise:enr:filename "c:/ProgramFiles/Keysight/Network Analyzer/Documents/ENR/346C.enr"
```

Query Syntax SENSE:NOISE:ENR:FILENAME?

Return Type String

Default Not applicable

SENSE<ch>:NOISE:EXDC:NAME <string>

Applicable Models: All with Noise Figure Option (S9x029A/B, 028, 029)

(Read-Write) Set and read the external DC source name in order to control the noise source.

Parameters

- <ch> Noise Figure channel number but this number is ignored for this command.
- <string> DC source name. The DC source should be defined in the external device dialog in advance.

Examples

```
Add DC-biased Noise Source named "NoiseSource1". Open NF channel before sending following commands.

SYSTEM:CONFigure:EDEvice:ADD "NoiseSource1"

SYSTEM:CONFigure:EDEvice:DTYPE "NoiseSource1","DC Source"

SYSTEM:CONFigure:EDEvice:DRIVER "NoiseSource1", "DC Source"

SYSTEM:CONFigure:EDEvice:IOConfig "NoiseSource1",
"GPIB0::23::INSTR"

SYSTEM:CONFigure:EDEvice:LOAD "NoiseSourceSettings.xml",
"NoiseSource1"

SENSE:NOISE:EXDC:NAME "NoiseSource1"

NOTE: NoiseSourceSettings.xml has setting information about
```



```
waiting time and SCPI commands to DC Source. Create this xml
file before sending SCPI commands.
```

Query Syntax SENSE:NOISE:EXDC:NAME?

Return Type String

Default ""

SENSe<ch>:NOISE:GAIN <num>

Applicable Models: All with Noise Figure Option (S9x029A/B, 028, 029)

(Read-Write) Set and read the amount of gain for the noise receiver. This setting is NOT used when **Sens:Noise:Receiver = NORMAL** (Opt 028)

Parameters

- <ch> Noise Figure channel number. If unspecified, value is set to 1.
- <num> Gain value. Choose from:
- **0** - Low gain; select if the gain of your DUT is relatively high (>35 dB).
 - **15** - Medium gain; select if the gain of your DUT is about average (20 dB to 45 dB)
 - **30** - High gain; select if the gain of your DUT is relatively low (<30 dB).

[Learn more about Noise Receiver Gain setting.](#)

If the value does not match one of these, it is rounded up to the next legal value.

Examples SENS:NOIS:GAIN 15

```
sense:noise:gain 0
```

Query Syntax SENSE:NOISE:GAIN?

Return Type Numeric

Default 30

SENSe<ch>:NOISE:GAIN:CTCheck <bool>

Applicable Models: All with Noise Figure Option (S9x029A/B, 028, 029)

(Read-Write) Turns noise threshold checking ON and OFF.

Parameters

- <ch> Noise Figure channel number. If unspecified, value is set to 1.
- <bool> Threshold checking state. Choose from
 - 0 - Noise threshold checking OFF
 - 1 - Noise threshold checking ON

Examples

```
SENS:NOIS:GAIN:CTC 0  
sense:noise:gain:ctcheck 1
```

Query Syntax SENSE:NOISe:GAIN:CTCheck?

Return Type Boolean

Default 0 - OFF

SENSe<ch>:NOISe:IMPedance:COUNT <num>

Applicable Models: All with Noise Figure Option (S9x029A/B, 028, 029)

(Read-Write) Sets the number of impedance states to use during calibrated measurements.

Parameters

- <ch> Noise Figure channel number. If unspecified, value is set to 1.
- <num> Number of impedance states to use. Choose between 4 and the maximum number allowed by the noise tuner device. The more states that are used, the more accurate, and slower, the measurement. If the specified number exceeds the capability of the device, the measurement will use the maximum number of states the device allows.

Examples

```
SENS:NOIS:IMP:COUN 5  
sense:noise:impedance:count 7
```

Query Syntax SENSE:NOISe:IMPedance:COUNT?

Return Type Numeric

Default 4

SENSe<ch>:NOISe:NARRowband[:STATe] <bool>

Applicable Models: All with Noise Figure Option (S9x029A/B, 028, 029) (Excepts M9485A, M980xA, P50xxA)

(Read-Write) Turns narrowband noise figure compensation ON and OFF

Parameters

- <ch> Noise Figure channel number. If unspecified, value is set to 1.
- <bool> Compensation state. Choose from
 - 0 or OFF - Narrowband noise compensation OFF
 - 1 or ON - Narrowband noise compensation ON

Examples

```
SENS:NOIS:NARR 0  
sense:noise:narrowband:state 1
```

Query Syntax SENSE:NOISe:NARRowband[:STATe]?

Return Type Boolean

Default 0 - OFF

SENSe<ch>:NOISe:PMAP <in>,<out>

Applicable Models: All with Noise Figure Option (S9x029A/B, 028, 029)

(Write-only) Set and read the DUT-to-VNA port mapping for Noise Figure. Port mapping is allowed ONLY when **SENS:NOIS:REC** is set to **NORM** (standard PNA-X receiver).

Parameters

- <ch> Any existing NF or NFX channel. If unspecified, value is set to 1.
- <in> VNA port which is connected to the DUT input.
- <out> VNA port which is connected to the DUT output.

Examples

```
SENS:NOIS:PMAP 1,2  
sense:noise:pmap 2,1  
See example program
```

Query Syntax Not Applicable

Default 1,2

SENSe<ch>:NOISe:PMAP:INPut?

Applicable Models: All with Noise Figure Option (S9x029A/B, 028, 029)

(Read-only) Read the VNA port number to be connected to the DUT Input.

Use **SENS:NOISe:PMap** to set the port mapping.

Parameters

<ch> Any existing NF or NFX channel. If unspecified, value is set to 1.

Examples

```
SENS:NOIS:PMap:INP?  
sense:noise:pmap:input?
```

Return Type Numeric

Default 1

SENSe<ch>:NOISe:PMAP:OUTPut?

Applicable Models: All with Noise Figure Option (S9x029A/B, 028, 029)

(Read-only) Read the VNA port number to be connected to the DUT Output.

Parameters

<ch> Any existing NF or NFX channel. If unspecified, value is set to 1.

Examples

```
SENS:NOIS:PMAP:OUTP?  
sense:noise:pmap:output?
```

Return Type Numeric

Default 2

SENSe<ch>:NOISe:PULL[:STATe] <bool>

Applicable Models: All with Noise Figure Option (S9x029A/B, 028, 029)

(Read-Write) Enables and disables the use of source pull technique to compute S22. [Learn more.](#)

Parameters

- <ch> Noise Figure channel number. If unspecified, value is set to 1.
- <bool> Source pull technique state. Choose from:
 - OFF** or **0** - Disable use of source pull technique.
 - ON** or **1** - Enable use of source pull technique.

Examples

```
SENS:NOIS:PULL 0  
sense2:noise:pull:state ON
```

Query Syntax SENSE:NOISe:PULL[:STATe]?

Return Type Boolean

Default 0 - OFF

SENSe<ch>:NOISe:RECeiver <char>

Applicable Models: All with Noise Figure Option (S9x029A/B, 028, 029) (Excepts M9485A, M980xA, P50xxA)

(Read-Write) Sets and returns the noise receiver to use for noise measurements.

Parameters

- <ch> Noise Figure channel number. If unspecified, value is set to 1.
- <char> Noise receiver. Choose from:
 - NORMal** The standard VNA receiver. (Opt 028 and Opt 029)
 - NOISe** The low-noise receivers. (Opt 029 only)

Examples

```
SENS:NOIS:REC NORM  
sense2:noise:receiver noise
```

Query Syntax SENSE:NOISe:RECeiver?

Return Type Character

Default NOISe

SENSe<ch>:NOISe:SNP? [string]

Applicable Models: All with Noise Figure Option (S9x029A/B, 028, 029) (Except M9485A)

(Read-Only) Returns S-parameter and noise parameter data for vector noise figure measurements.

Noise parameters are NOT valid for NFX or Scalar noise figure measurements. Learn more about [noise parameters](#).

Parameters

- <ch> Noise Figure channel number. If unspecified, value is set to 1.
- [string] Optional parameter. Choose "**NoiseParameter**" - Noise parameter data.
If unspecified, only S-parameter data is saved.

Examples

```
SENS:NOIS:SNP?  
sense2:noise:snp? "NoiseParameter"
```

Return Type Comma-separated values

Data is returned in this order:

1. <all frequencies | point number>
2. <real S11> <imag S11> <real S21> <imag S21> <real S12> <imag S12>
<real S22> <imag S22>

Then if noise parameters are specified:

3. <NFMin dB> <mag GammaOpt> <phase GammaOpt> <Rn/Z0>

The data display format depends on **MMEM:STOR:TRAC:FORM:SNP**

Default Not Applicable

SENSe<ch>:NOISe:SNP:SAVE <filename>, [data]

Applicable Models: All with Noise Figure Option (S9x029A/B, 028, 029)

(Write-only) Saves the S-parameters and vector noise parameters to an S2P file. For NFX channels, mixer setup information is included as comments at the beginning of the file.

Learn more about [noise parameters](#).

The format of the snp data is set with **MMEM:STOR:TRAC:FORM:SNP**.

The following is sample data for two data points from a Noise Figure measurement:

! Keysight Technologies,N5242A,USxxxxxxx,A.09.85

! pnan-nn Thu Nov 01 12:26:27 2012

HZ S MA R 50

!freq (Hz) S11M S11A S21M S21A S12M S12A S22M
S22A

2000000000 9.038147e-001 6.241193e+001 5.855965e+000 -6.116778e+001 2.232653e-002 -
1.475392e+002 5.275644e-001 1.750775e+002

8000000000 6.951366e-001 -1.458202e+002 5.307699e+000 -7.055212e+001 7.838612e-002 -
1.460951e+002 3.986142e-001 -2.226317e+001

! Noise Parameters

!freq (Hz) NFMin(dB) Rho_opt(Mag) Rho_opt(deg) Rn/Z0

2000000000 1.251697e+000 2.172018e-001 -8.765875e+001 1.806663e-001

8000000000 1.583849e+000 2.015185e-001 1.029875e+002 1.320403e-001

Parameters

<ch> Noise Figure channel number. If unspecified, value is set to 1.

<filename> Path (optional), filename and suffix of location to store SNP data. If path is not specified, the current path is used.

[data] String. Optional parameter. Choose "**NoiseParameter**" - Noise parameter data.

If unspecified, only S-parameter data is saved.

Examples

```
SENS:NOIS:SNP:SAVE "MySparams.s2p"
```

```
sense2:noise:snp:save "C:/Program Files/Keysight/Network Analyzer/Documents/MyNoiseParams.s2p", "NoiseParameter"
```

Query Syntax Not Applicable

Default Not Applicable

SENSe<ch>:NOISe:SOURce:CKIT <string>

Applicable Models: All with Noise Figure Option (S9x029A/B, 028, 029)

(Read-Write) Set and read the Cal Kit that will be used for the Noise Source adapter.

An adapter is always necessary to connect a 346C Noise Source to the VNA port 2. Select a Cal Kit that is the same type and gender as the noise source connector.

If the Noise Source mates directly to VNA port 2, then set this type to "None".

Parameters

- <ch> Noise Figure channel number. If unspecified, value is set to 1.
- <string> Cal Kit. Case sensitive.

To read possible cal kit strings for the adapter:

- Change the port connector type to that of the noise source using:
`SENS:CORR:COLL:GUID:CONN:PORT<n>`
- Then read the possible cal kit strings for that port using:
`SENS:CORR:COLL:GUID:CKIT:PORT<n>:CAT?`

Examples

```
SENS:NOIS:SOUR:CKIT "N4691-60004 ECal"  
sense:noise:source:ckit "
```

Query Syntax SENSE:NOISE:SOURCE:CKIT?

Return Type String

Default Not applicable

SENSe<ch>:NOISe:SOURce:CONNector <string>

Applicable Models: All with Noise Figure Option (S9x029A/B, 028, 029)

(Read-Write) Set and read the Noise Source connector type and gender. The Keysight 346C has an "APC 3.5 male" connector.

Parameters

- <ch> Noise Figure channel number. If unspecified, value is set to 1.
- <string> Noise source connector type and gender. Case sensitive.

Use **SENS:CORR:COLL:GUID:CONN:CAT?** to read possible connector strings.

Examples

```
SENS:NOIS:SOUR:CONN "APC 3.5 male"  
sense:noise:source:connector "APC 3.5 female"
```

Query Syntax SENSE:NOISE:SOURce:CONNector?

Return Type String

Default Not applicable

SENSe<ch>:NOISE:SWEep:TIME?

Applicable Models: All with Noise Figure Option (S9x029A/B, 028, 029)

(Read-only) Returns the APPROXIMATE time the channel will take to make one noise receiver sweep given the current setup. This, along with the sweep time for a standard receiver measurement and the following calculations, can tell you how long a "single" sweep would take so that you can set an appropriate "timeout" in your program.

To calculate the total sweep time:

Noise Figure on amplifiers (Vector Correction ON):

- $2 * SSwpTime + X * NoiseReceiverSweepTime$**
- Where X = the number of noise receiver impedance state sweeps. (Default is 4).

Noise Figure on converters (NFX) correction on - increased number of sweeps due to extra mixer sweeps and source pulling:

- $4 * SSwpTime + X * NoiseReceiverSweepTime$ (without source pulling)**
- $8 * SSwpTime + X * NoiseReceiverSweepTime$ (with source pulling)**
- Where X = the number of noise receiver impedance state sweeps. (Default is 4).

Note: The number of sweeps to perform a noise measurement is annotated at the bottom of the Noise Figure screen.

Parameters

<ch> Noise Figure channel number. If unspecified, value is set to 1.

Examples

```
SENS:NOIS:SWE:TIM?  
sense:noise:sweep:time?
```

Return Type Double

Default Not applicable

SENSe<ch>:NOISe:TEMPerature:AMBient <num>

Applicable Models: All with Noise Figure Option (S9x029A/B, 028, 029)

(Read-Write) Sets the temperature at which the current noise measurement is occurring. [Learn more](#)

Parameters

<ch> Noise Figure channel number. If unspecified, value is set to 1.

<num> Ambient temperature in Kelvin.

Examples

```
SENS:NOIS:TEMP:AMB 292  
sense:noise:temperature 289
```

Query Syntax SENSe:NOISe:TEMPerature:AMBient?

Return Type Numeric

Default 295

SENSe<ch>:NOISe:TUNer:ID <string>

Applicable Models: All with Noise Figure Option (S9x029A/B, 028, 029) (Except M9485A)

(Read-Write) Set and read the identity of the noise tuner. This is an ECal model and serial number string. To read the identities of the connected ECal modules, use **SENSe:CORRection:CKIT:ECAL:LIST?** and **SENSe:CORRection:CKIT:ECAL<mod>:INFormation?**

Parameters

- <ch> Noise Figure channel number. If unspecified, value is set to 1.
- <string> ECal model and serial number string. The ECal module must be connected when this command is sent.

Examples

```
SENS:NOIS:TUN:ID "N4691-60004 ECal 02822"  
sense:noise:tuner:id ""N4691-60004 ECal 02822"
```

Query Syntax SENSe:NOISe:TUNer:ID?

Return Type String

Default Not applicable

SENSe<ch>:NOISe:TUNer:INPut <string>

Applicable Models: All with Noise Figure Option (S9x029A/B, 028, 029) (Except M9485A)

(Read-Write) Sets and reads the port of the ECal noise tuner that is connected to the VNA SOURCE OUT.

Parameters

- <ch> Noise Figure channel number. If unspecified, value is set to 1.
- <string> ECal port identifier. Case sensitive.

Examples

```
SENS:NOIS:TUN:INP "B"  
sense:noise:tuner:input "A"
```

Query Syntax SENSe:NOISe:TUNer:INPut?

Return Type String

Default "B"

SENSe<ch>:NOISe:TUNer:ORlent[:STATe] <bool>

Applicable Models: All with Noise Figure Option (S9x029A/B, 028, 029) (Except M9485A)

(Read-Write) Sets the state of auto orientation for a noise tuner during Noise Figure for NFX.

Parameters

- <ch> Noise Figure channel number. If unspecified, value is set to 1.
- <bool> Auto-orientation state. Choose from:
 - OFF** or **0** - Disable Auto-orientation
 - ON** or **1** - Enable Auto-orientation

Examples

```
SENS:NOIS:TUN:ORI 0  
sense2:noise:tuner:orient:state ON
```

Query Syntax SENSE:NOISe:TUNer:ORlent[:STATe]?

Return Type Boolean

Default 1 - ON

SENSe<ch>:NOISe:TUNer:OUTPut <string>

Applicable Models: All with Noise Figure Option (S9x029A/B, 028, 029) (Except M9485A)

(Read-Write) Sets and reads the port of the ECal noise tuner that is connected to the CPLR THRU.

Parameters

- <ch> Noise Figure channel number. If unspecified, value is set to 1.
- <string> ECal port identifier. Case sensitive.

Examples

```
SENS:NOIS:TUN:OUTP "B"  
sense:noise:tuner:output "A"
```

Query Syntax SENSE:NOISe:TUNer:OUTput?

Return Type String

Default "A"

Sense:Path:Config Commands

Controls the path configuration settings.

SENSe:PATH:CONFig

- | [CATalog?](#)
- | [COPY](#)
- | [DELeTe](#)
- | [DTEXT](#)
- | [ELEMeNt](#)
 - | [CATalog?](#)
 - | [\[STATe\]](#)
 - | [VALue:CATalog](#)
- | [NAME](#)
- | [SELeCt](#)
- | [STORe](#)

Click on a keyword to view the command details.

The 'ELEMeNt' commands are used for both RF path and IF path configuration.

- [RF Configuration elements and values](#)
- [IF Configuration elements and values](#)

See Also

- [Example Programs](#)
- [Learn about RF Path Configuration](#)
- [Learn about IF Path Configuration](#)
- [Synchronizing the Analyzer and Controller](#)
- [SCPI Command Tree](#)

SENSe:PATH:CONFig:CATalog?

Applicable Models: N522xB, N523xB, N524xB

(Read-only) Returns a list of configuration names stored in the VNA.

Examples `SENS:PATH:CONF:CAT?`

Return Type Comma-separated list of double-quoted strings

Default Not Applicable

SENSe<ch>:PATH:CONFIg:COPIY <num>

Applicable Models: N522xB, N523xB, N524xB

(Write-only) Copies the mechanical switch and attenuator settings from the specified channel <num> to channel <ch>.

To avoid potential conflicts, all port couplings in the calling channel will be turned OFF and all port attenuator settings will be set to manual before copying the switch or attenuator settings. The two channels CAN be of different measurement classes.

Use **SYSTem:MACRo:COPIY:CHANnel** to copy ALL settings from one channel to another.

Parameters

<ch> Channel number to copy mechanical settings to. If unspecified, value is set to 1.

<num> Channel number to copy mechanical settings from.

Examples `'Copies mechanical settings from chan 2 to chan 1.'`

`SENS1:PATH:CONF:COPIY 2`

Return Type Not Applicable

Default Not Applicable

SENSe:PATH:CONFIg:DELEte <string>

Applicable Models: N522xB, N523xB, N524xB

(Write-only) Deletes the specified configuration name from the VNA. The factory configurations cannot be deleted. This is the only method of distinguishing a factory configuration from a user-named configuration.

Parameters

<string> Configuration name to be deleted.

Examples

```
SENS:PATH:CONF:DEL "MyMixer"
```

Return Type Not Applicable

Default Not Applicable

SENSe:PATH:CONFig:DTEXT <string>

Applicable Models: N522xB, N523xB, N524xB

(Read-Write) Write and read descriptive text associated with the configuration. This text is displayed in the path configuration dialog. Text is generally used to describe external connections that must be made manually to complete the configuration setup.

Parameters

<string> Descriptive text enclosed in quotes. Double quotes are not allowed within the descriptive text.

Examples

```
SENS:PATH:CONF:DTEX "Connect J1 jumper on the rear panel."
```

Query Syntax SENSe<ch>:PATH:CONFig:DTEXT?

Return Type String

Default Not Applicable

SENSe<ch>:PATH:CONFig:ELEMent:CATalog?

Applicable Models: N522xB, N523xB, N524xB

(Read-only) Returns the names of configurable elements as a comma-delimited list of strings.

See a list of configurable elements and settings for various VNA models.

Parameters

<ch> Any existing channel number; if unspecified, value is set to 1.

Examples

```
SENS:PATH:CONF:ELEM:CAT?
```

```
'returns
```

```
"Combiner", "Src1", "Src2"
```

Default Not Applicable

SENSe<ch>:PATH:CONFig:ELEMent[:STATe] <elem>, <setting>

Applicable Models: N522xB, N523xB, N524xB, M9485A with M9341B, M937xA with M9341B, P937xA, M980xA and P500xA

(Read-Write) Write or read the setting of a specified element in the current configuration.

For M9341B, this can enable the pulse modulation for AUX Out 1 and 2.

Parameters

<ch> Any existing channel number; if unspecified, value is set to 1.

<elem> Name of the element for which a setting is to be made.

"AuxOut1PulseModEnable" or "AuxOut2PulseModEnable" (not applicable for M980xA and P500xA)

'IFGAINa1', 'IFGAINb1', 'IFGAINa2', 'IFGAINb2', ... (applicable for Spectrum Analyzer channels on M980xA and P500xA)

"PulseTrigInput", "PulseModDrive", "Src1Out1PulseModeEnable" (applicable for M980xA and P500xA)

<setting> Element setting.

"Disable" or "Enable" (not applicable for M980xA and P500xA)

'Auto', '6', '8', '10', '12', '14', '16', '18', '20', '22', '24', '26' (applicable for Spectrum Analyzer channels on M980xA and P500xA)

Examples `SENS:PATH:CONF:ELEM "Combiner", "Normal"`

Query Syntax `SENSe<ch>:PATH:CONFig:ELEMent? "AuxOut1PulseModEnable"`

Returns the current state of the AUX Out 1. (not applicable for M980xA and P500xA)

`SENSe<ch>:PATH:CONFig:ELEMent[:STATe]?<elem>`

Return Type String

Default Not applicable

`SENSe<ch>:PATH:CONFig:ELEMent:VALue:CATalog? <element>`

Applicable Models: N522xB, N523xB, N524xB

(Read-only) Returns the list of valid settings that can be used with the specified element.

See a list of configurable elements and settings for various VNA models.

Parameters

- `<ch>` Any existing channel number; if unspecified, value is set to 1.
- `<element>` String. Element name for which to return valid settings.

Examples `SENS:PATH:CONF:ELEM:VAL:CAT? "Combiner"`

`'returns "Normal", "Reversed"`

Default Not Applicable

`SENSe<ch>:PATH:CONFig:NAME?`

Applicable Models: N522xB, N523xB, N524xB

(Read-only) Returns the name of the current configuration only if NO individual element settings had been changed since selecting or storing a configuration. When element settings change, the path configuration name is cleared.

Parameters

<ch> Any existing channel number; if unspecified, value is set to 1.

Examples

```
SENS:PATH:CONF:NAME?  
'returns "Default"
```

Return Type String

Default Not Applicable

SENSe<ch>:PATH:CONFig:SElect <string>

Applicable Models: N522xB, N523xB, N524xB

(Write only) Loads the named configuration onto the specified channel.

Note: Loading a stored configuration will over-write MANY RF and IF path configuration settings. Make your measurement settings AFTER recalling a stored configuration, NOT before.

Use **SENS:PATH:CONF:CAT?** to return the configuration names that are stored on the VNA.

Parameters

<ch> Any existing channel number; if unspecified, value is set to 1.

<string> Configuration name. "Default" is the default factory configuration.

Examples

```
SENS:PATH:CONF:SEL 'default'  
sense2:path:CONFig:select "MyMixer"
```

Query Syntax Not Applicable

Default "Default"

SENSe<ch>:PATH:CONFig:STORe <name>

Applicable Models: N522xB, N523xB, N524xB

(Write only) Saves the path configuration currently associated with channel <ch> to the specified configuration name.

Parameters

- <ch> Any existing channel number; if unspecified, value is set to 1.
- <name> String. Configuration name. Factory configurations can NOT be overwritten. Specifying the name of a pre-defined factory configuration will result in an error.

Examples

```
SENS:PATH:CONF:STOR "MyMixer"
```

Query Syntax Not Applicable

Default Not Applicable

Sense:Power Command

[Learn about Receiver Attenuation](#)

SENSe<cnum>:POWer:ATTenuator <recvr>,<num>

Applicable Models: N522xB, N523xB, N524xB, M937xA, P937xA

(Read-Write) Sets the attenuation level for the specified receiver.

Note: Attenuation cannot be set with Sweep Type set to Power

Parameters

<cnum> Any existing channel number. If unspecified, value is set to 1

<recvr> Receiver to get attenuation. Choose from:

- **ARECeiver** - receiver A
- **BRECeiver** - receiver B
- **CRECeiver** - receiver C
- **DRECeiver** - receiver D

Receiver attenuation can NOT be set using [logical receiver notation](#).

<num> Attenuation value in dB. To determine how many receiver attenuators, the maximum receiver attenuation, and attenuation step size, for a VNA model, see [VNA Models and Options](#).

If a number other than these is entered, the analyzer will select the next lower valid value. For example, if 19 is entered for the E8361A/C, then 10 dB attenuation will be selected.

Examples

```
SENS:POW:ATT AREC,10  
sense2:power:attenuator breceiver,30
```

Query Syntax SENSe<cnum>:POWer:ATTenuator? <recvr>

Return Type Numeric

Default 0

Sense:Pulse Commands

Beginning with A.09.50, these commands can also be used to control an external Pulse Generator.

[Learn more.](#)

SENSe:PULSe

- | [CATalog?](#)
- | [DELay](#)
- | [DINCrement](#)
- | [HDELay](#)
- | [ADC?](#)
- | [MODulator](#)
- | [\[:STATe\]](#)
- | [INVert](#)
- | [OPTion:PULSe4](#)
- | [PERiod](#)
- | [STATe](#)
- | [SUBPointtrig](#)
- | [TPOLarity](#)
- | [TTYPe](#)
- | [WIDTh](#)

Click on a keyword to view the command details.

To make other Pulse settings, such as enabling the internal pulse modulators, use this command:

- [SENSe<ch>:PATH:CONFIg:ELEMent\[:STATe\] <elem>, <setting>](#)
- At that command help topic, click the **IF Configuration elements and values** link to see the Pulse element and setting (in the middle box) to configure.

See Also

- [SENS:SWEep:PULSE](#) - configures the channel for pulse measurements

- External Pulse Generator configuration commands
- SENS:IF configuration commands
- Example Programs
- Integrated Pulse Application
- Synchronizing the Analyzer and Controller
- SCPI Command Tree

Pulse Definitions

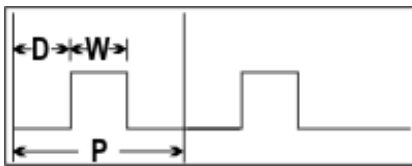

- D = Delay; the time before each pulse begins
- W = Width; the time the pulse is ON
- P = Period; one complete pulse cycle
- Duty Cycle = W/P

Important: If $D + W$ is greater than P , then undefined VNA behavior results. There is NO error message or warning.

SENSe:PULSe:CATalog?

Applicable Models: All with Pulsed RF Measurement Option

(Read-only) Returns the string names of internal and configured external pulse generators.

Parameters None

Examples SENS:PULS:CAT?

Default Not Applicable

SENSe<ch>:PULSe<n>:DELay <value>[,<name>]

Applicable Models: All with Pulsed RF Measurement Option

(Read-Write) Sets the pulse delay. The amount of time before a new pulse begins.

See [Pulse Definition diagram](#).

Parameters

- <ch> Any existing channel number; if unspecified, value is set to 1.
- <n> Internal pulse generator number. Choose from 0 to 4.
0 is the generator that pulses the ADC.
- <value> Delay value in seconds. Choose a value from about 33ns to about 70 seconds.
- <name> Optional. String name of the pulse generator.
Required for use with [external pulse generators](#).
Use [SENSe:PULSe:CAT?](#) to return the names of configured pulse generators.
If specified, <n> is ignored.
If unspecified, <n> is required for internal pulse generators.

Examples

```
SENS:PULS1:DEL .5  
SENS:PULS:DEL .5, "My81110"
```

Query Syntax SENSE<ch>:PULSe<n>:DELay? [<name>]

Return Type Numeric

Default 0

SENSe<ch>:PULSe<n>:DINCrement <value>[,<name>]

Applicable Models: All with Pulsed RF Measurement Option (Except M980xA, P50xxA, E5080B)

(Read-Write) Sets the pulse delay increment. The delay increments with each pulse by the <value> amount.

For example, in this diagram the delay starts as 1. On the second pulse, delay=2. On the third pulse, delay=3.

Important: If **D + W** is greater than **P**, then undefined VNA behavior results. There is NO error message or warning. Delay includes the incremented value.

This is useful for pulse profiling.

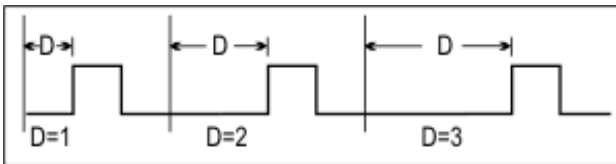

See Pulse Definition diagram.

Parameters

- <ch> Any existing channel number; if unspecified, value is set to 1.
- <n> Pulse generator number. Choose from 0 to 4.
0 is the generator that pulses the ADC.
- <value> Delay increment value in seconds.
- <name> Optional. String name of the pulse generator.
Required for use with **external pulse generators**.
Use **SENSe:PULSe:CAT?** to return the names of configured pulse generators.
If specified, <n> is ignored.
If unspecified, <n> is required for internal pulse generators.

Examples

```
SENS:PULS1:DINC .5  
SENS:PULS:DINC .5, "My81110"
```

Query Syntax SENSE<ch>:PULSe<n>:DINCrement? [<name>]

Return Type Numeric

Default 0

SENSe:PULSe<n>:HDELay:ADC?

Applicable Models: All with Pulsed RF Measurement Option

(Read-only) Returns the ADC delay for pulse measurements.

Parameters

- <n> Internal pulse generator number. Choose from 1 to 4.
0 is the generator that pulses the ADC.

Examples

```
SENS : PULS : HDEL : ADC?
```

Default Not Applicable

SENSe<ch>:PULSe<n>:HDELay:MODulator <value>

Applicable Models: All with Pulsed RF Measurement Option

(Read-Write) Sets the time lag between the pulse drive signal and the actual RF output.

The following diagram shows Pulse1 used as the pulse drive signal.

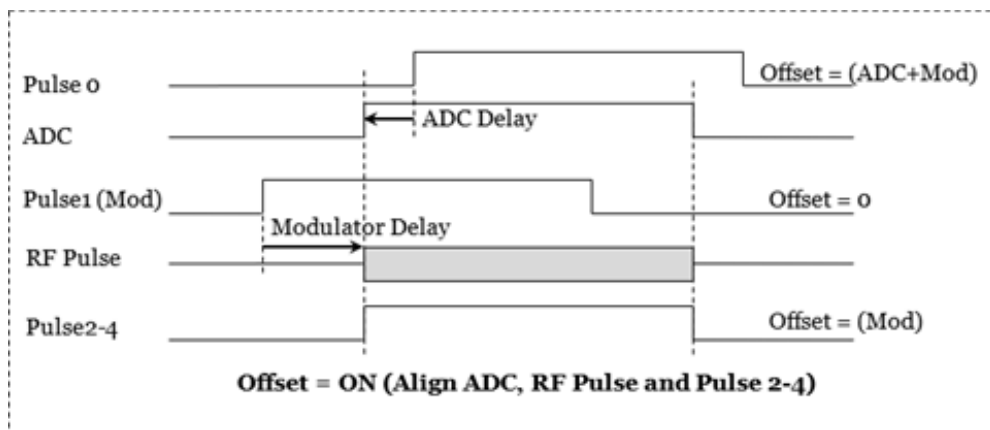
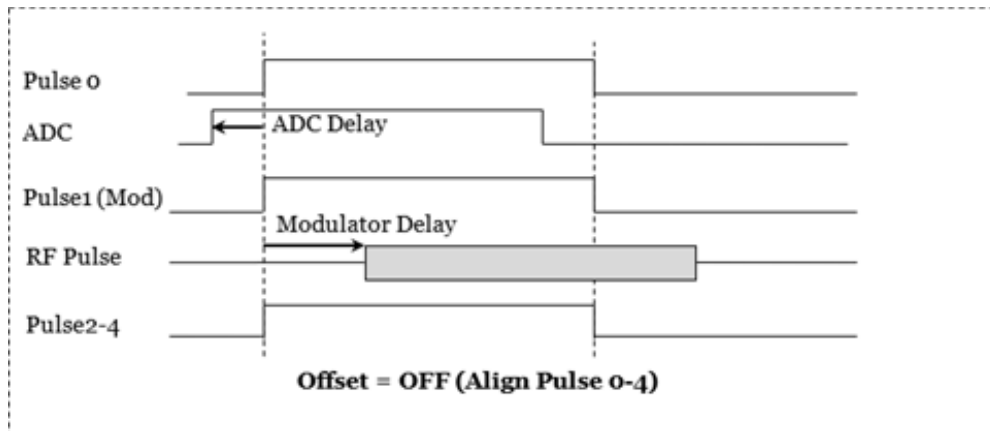

Parameters

- <ch> Any existing channel number; if unspecified, value is set to 1.
- <n> Internal pulse generator number. Choose from 1 to 4.
- 0 is the generator that pulses the ADC.
- <value> Delay value in seconds.

Examples

```
SENS:PULS1:HDEL:MOD 50ns
```

Query Syntax SENSE<ch>:PULSe<n>:HDElay:MODulator?

Return Type Numeric

Default 50 ns

SENSe<ch>:PULSe<n>:HDElay[:STATe] <value>

Applicable Models: All with Pulsed RF Measurement Option

(Read-Write) Enables/disables modulator and ADC delays for pulse measurements.

Parameters

- <ch> Any existing channel number; if unspecified, value is set to 1.
- <n> Pulse generator number. Choose from 0 to 4.
- 0 is the generator that pulses the ADC.
- <value> Boolean
- ON (or 1) - turns delays ON.
- OFF (or 0) - turns delays OFF.

Examples

```
SENS:PULS1:HDEL 1
```

Query Syntax SENSE<ch>:PULSe:HDElay[:STATe]? [<name>]

Return Type Boolean

Default OFF

SENSe<ch>:PULSe<n>:INVert <value>[,<name>]

Applicable Models: All with Pulsed RF Measurement Option

(Read-Write) Sets whether to invert the polarity of the pulse.

Parameters

- <ch> Any existing channel number; if unspecified, value is set to 1.
- <n> Pulse generator number. Choose from 0 to 4.
0 is the generator that pulses the ADC.
- <value> Boolean
ON (or 1) - Invert the pulse generator polarity. This causes the pulse ON time to be active low and OFF be active high.
OFF (or 0) - Do NOT Invert the pulse generator polarity.
- <name> Optional. String name of the pulse generator.
Required for use with **external pulse generators**.
Use **SENSe:PULSe:CAT?** to return the names of configured pulse generators.
If specified, <n> is ignored.
If unspecified, <n> is required for internal pulse generators.

Examples

```
SENS:PULS1:INV 1  
SENS:PULS:INV 1, "My81110"
```

Query Syntax SENSE<ch>:PULSe:INVert? [<name>]

Return Type Boolean

Default OFF (0)

SENSe<ch>:PULSe4:OPTion <bool>

Applicable Models: All with Pulsed RF Measurement Option

(Read-Write) Turns pulse4 output ON and OFF. Enable pulse4 to use an oscilloscope connected to pin 13 of the PULSE I/O connector on the rear panel of the VNA to display when the ADC is making measurements.

Note: The pulse output must be on using **SENSe:PULSe4[:STATE] ON** to view ADC activity.

Parameters

- <ch> Any existing channel number; if unspecified, value is set to 1.
- <bool> Choose from:
- ON** (or 1) - Pulse 4 output pin indicates ADC activity.
 - OFF** (or 0) - Pulse 4 output pin indicates legacy behavior (pulse generator number 4 output).

Examples

```
SENSe:PULS4:OPT 1
```

Query Syntax SENSe<ch>:PULSe4:OPTion?

Return Type Boolean

Default OFF

SENSe<ch>:PULSe:PERiod <value>[,<name>]

Applicable Models: All with Pulsed RF Measurement Option

(Read-Write) Sets the pulse-period (1/PRF) for ALL pulse generators.

The resolution of the period is:

DSP version: **4.0** = 16.667nS.

DSP version: **5.0** = 10nS

[Learn more](#) about DSP version.

[See Pulse Definition diagram.](#)

Parameters

- <ch> Any existing channel number; if unspecified, value is set to 1.
- <value> Pulse period in seconds. Choose a value from about 33ns to about 70 seconds.
- <name> Required for use with an **external pulse generator**.

String name of the external pulse generator.

If unspecified, the period for the internal pulse generators are set.

Use **SENSe:PULSe:CAT?** to return the names of configured pulse generators.

Examples

```
SENS:PULS:PERiod .05  
SENS:PULS:PER .01, "My81110"
```

Query Syntax SENSE<ch>:PULSe:PERiod? [<name>]

Return Type Numeric

Default 1e-3 sec

SENSe<ch>:PULSe<n>[:STATe] <value>[,<name>]

Applicable Models: All with Pulsed RF Measurement Option

(Read-Write) Turns the pulse output ON and OFF.

Parameters

- <ch> Any existing channel number; if unspecified, value is set to 1.
- <n> Pulse generator number. Choose from 0 to 4.
0 is the generator that pulses the ADC.
- <value> Boolean
ON (or 1) - turns pulse output ON.
OFF (or 0) - turns pulse output OFF.
- <name> Optional. String name of the pulse generator.
Required for use with **external pulse generators**.
Use **SENSe:PULSe:CAT?** to return the names of configured pulse generators.
If specified, <n> is ignored.
If unspecified, <n> is required for internal pulse generators.

Examples

```
SENS:PULS1 1  
SENS:PULS 1, "My81110"
```

Query Syntax SENSE<ch>:PULSe[:STATe]? [<name>]

Return Type Boolean

Default OFF

SENSe<ch>:PULSe<n>:SUBPointtrig <bool>

Applicable Models: All with Pulsed RF Measurement Option (Except M980xA, P50xxA, E5080B)

(Read-Write) Enables / Disables subpoint triggering. When enabled and performing **Point Averaging**, Each rising edge of P0 triggers a subpoint (one of N acquisitions in an N point average). Must also enable the P0 generator using **SENS:PULS0:STAT**.

Learn more about the PNA-X pulse generators.

Parameters

- <ch> Any existing channel number; if unspecified, value is set to 1.
- <n> Pulse generator number. **Must be 0** as this is the generator that triggers the ADC.
- <bool> ON (or 1) - turns subpoint triggering ON.
OFF (or 0) - turns subpoint triggering OFF.

Examples `SENS:PULS0:SUBP 1`

Query Syntax SENSe<ch>:PULSe0:SUBPointtrig?

Return Type Boolean

Default OFF

SENSe<ch>:PULSe:TPOLarity <char>

Applicable Models: All with Pulsed RF Measurement Option

(Read-Write) Sets the polarity of the trigger signal to which the internal pulse generators will respond when being externally triggered at the PulseSyncIn pin.

Note: This feature requires DSP version: **4.0 FPGA: 34** or higher. [Learn more.](#)

Learn more about the PNA-X pulse generators.

Parameters

- <ch> Any existing channel number; if unspecified, value is set to 1.
 - <char> Pulse polarity. Choose from:
 - POSitive** - VNA responds to rising edge or HIGH level
 - NEGative** - VNA responds to falling edge or LOW level.
- Set Edge or Level triggering using **SENS:PULS:TTYPe**.

Examples

```
SENS:PULS:TPOL NEG
```

Query Syntax SENSE<ch>:PULSe:TPOLarity?

Return Type Character

Default POSitive - Also the polarity used when the PNA-X does not have the required DSP hardware.

SENSe<ch>:PULSe<n>:TTYPe <char>

Applicable Models: All with Pulsed RF Measurement Option (Except M980xA, P50xxA, E5080B)

(Read-Write) Sets the type of trigger signal to which the internal pulse generators will respond when being externally triggered at the PulseSyncIn pin.

Note: This feature requires DSP version: **4.0 FPGA: 34** or higher. [Learn more.](#)

Learn more about the PNA-X pulse generators.

Parameters

- <ch> Any existing channel number; if unspecified, value is set to 1.
- <char> Trigger type. Choose from:
 - EDGE** - VNA responds to the edge (rising or falling) of a signal
 - LEVeL** - VNA responds to the level (HIGH or LOW) of a signal

Set polarity using **SENS:PULS:TPOL**

Examples

```
SENS:PULS:TTYP EDGE
```

Query Syntax SENSE<ch>:PULSe:TTYPe?

Return Type Character

Default LEVl - Also the type used when the PNA-X does not have the required DSP hardware.

SENSe<ch>:PULSe<n>:WIDTh <value>[,<name>]

Applicable Models: All with Pulsed RF Measurement Option

(Read-Write) Sets the pulse width. The amount of time that the pulse is ON.

See [Pulse Definition diagram](#).

Parameters

- <ch> Any existing channel number; if unspecified, value is set to 1.
- <n> Pulse generator number. Choose from 0 to 4.
0 is the generator that pulses the ADC.
- <value> Pulse width in seconds. Choose a value from about 33ns to about 70 seconds.
- <name> Optional. String name of the pulse generator.
Required for use with **external pulse generators**.
Use **SENSe:PULSe:CAT?** to return the names of configured pulse generators.
If specified, <n> is ignored.
If unspecified, <n> is required for internal pulse generators.

Examples

```
SENS:PULS:WIDT .5  
SENS:PULS:WIDT .5, "My81110"
```

Query Syntax SENSE<ch>:PULSe<n>:WIDTh? [<name>]

Return Type Numeric

Default 1e-4 sec

Sense:Roscillator Command

[Learn about the Reference Osc.](#)

SENSe:ROSCillator:EXTernal:FREQuency

Applicable Models: M980xA, P50xxA

(Read-Write) Set and read Reference Oscillator frequency inputted into the reference input connector. 100 MHz reference is typical.

Parameters

<num> 1E+7 or 1E+8
1E+7: accepts 10 MHz reference
1E+8: accepts 100 MHz reference

Examples

```
SENS:ROSC:EXT:FREQ 1E7  
sense:roscillator:external:frequency 1E7
```

Query Syntax SENS:ROSC:EXT:FREQ?

Return Type Numeric

Default 1E+7

SENSe:ROSCillator:OUTPut:FREQuency

Applicable Models: M980xA, P50xxA

(Read-Write) Set and read Reference Oscillator frequency outputted from the reference output connector. 100 MHz reference is typical.

Parameters

<num> 1E+7 or 1E+8
1E+7: outputs 10 MHz reference.
1E+8: outputs 100 MHz reference

Examples

```
SENS:ROSC:OUTP:FREQ 1E8  
sense:roscillator:output:frequency 1E8
```

Query Syntax SENS:ROSC:EXT:FREQ?

Return Type Numeric

Default 1E+7

SENSe:ROSCillator:SOURce?

Applicable Models: M980xA, P50xxA, N522xB, N523xB, N524xB, E5080A/B

(Read-only) Applying a signal to the Reference Oscillator connector automatically sets the Reference Oscillator to EXTERNAL. This command allows you to check that it worked.

- **EXT** is returned when a signal is present at the Reference Oscillator connector.
- **INT** is returned when **NO** signal is present at the Reference Oscillator connector.

Examples

```
SENS:ROSC:SOUR?  
sense:roscillator:source?
```

Return Type Character

Default Not applicable

SENSe:ROSCillator:SOURce <state>

Applicable Models: M937xA, P937xA, M980xA, P50xxA

(Write-only) Set and read the Reference Oscillator state.

Note: This setting is NOT cleared with Preset. However, it does clear when the M937xA software is restarted.

Parameters

<state> Choose from the following:

INTERNAL - Use the internal Reference Oscillator.

EXTERNAL - Use an external Reference Oscillator. Use **SENSe:ROSCillator:SOURce:CONDition?** to determine if the M937xA is locked to the external oscillator.

Examples

```
SENS:ROSC:SOUR INT  
sense:roscillator:source external
```

Query Syntax Not applicable

Return Type Not applicable

Default INTERNAL

SENSe:ROSCillator:SOURce:CONDition?

Applicable Models: M937xA, P937xA, M980xA, P50xxA

(Read-only) Reads the Reference Oscillator 'locked' condition.

When SENS:ROSC:SOUR is set to Internal, this command will always return "LOCKed".

When SENS:ROSC:SOUR is set to External, then this function takes about 100 usec to read the state of the hardware.

Examples

```
SENS:ROSC:SOUR:COND?  
sense:roscillator:source:condition?
```

Return Type Character

Default Not applicable

Spectrum Analyzer Commands

Controls the Spectrum Analyzer Application.

SA Application - SA Setup tab

SA Setup : Channel 1

SA Source Coherence Advanced

Sweep Type

- Linear Frequency
- Segments

Processing

Resolution Bandwidth: 300.000000 kHz Auto

Video Bandwidth: 300.000000 kHz Auto

Detector Type: Peak Bypass

Averaging Type: Power 1

Settings

Start: 10.000000000 MHz

Stop: 26.500000000000 GHz

Center: 13.255000000000 GHz

Span: 26.490000000000 GHz

Nbr of Points: 1001

Attenuators

Receiver	Attenuator
A	0 dB
B	0 dB
C	0 dB
D	0 dB

Defaults OK Cancel Apply Help

SENSe:SA:BANDwidth:RESolution:
SENSe:SA:BANDwidth:[RESolution]
SENSe:SA:BANDwidth:[RESolution]
SENSe:SA:BANDwidth:RESolution
SENSe:SA:BANDwidth:RESolution
SENSe:SA:BANDwidth:RESolution
SENSe:SA:BANDwidth:VIDeo
SENSe:SA:BANDwidth:VIDeo:AUTO
SENSe:SA:BANDwidth:VIDeo MIN
SENSe:SA:BANDwidth:VIDeo MAX
SENSe:SA:DETECTOR:FUNCTION
SENSe:SA:DETECTOR:BYPass:[STA]
SENSe:SA:BANDwidth:VIDeo:AVE
SENSe:SA:BANDwidth:VIDeo:AVE

Source Setup tab

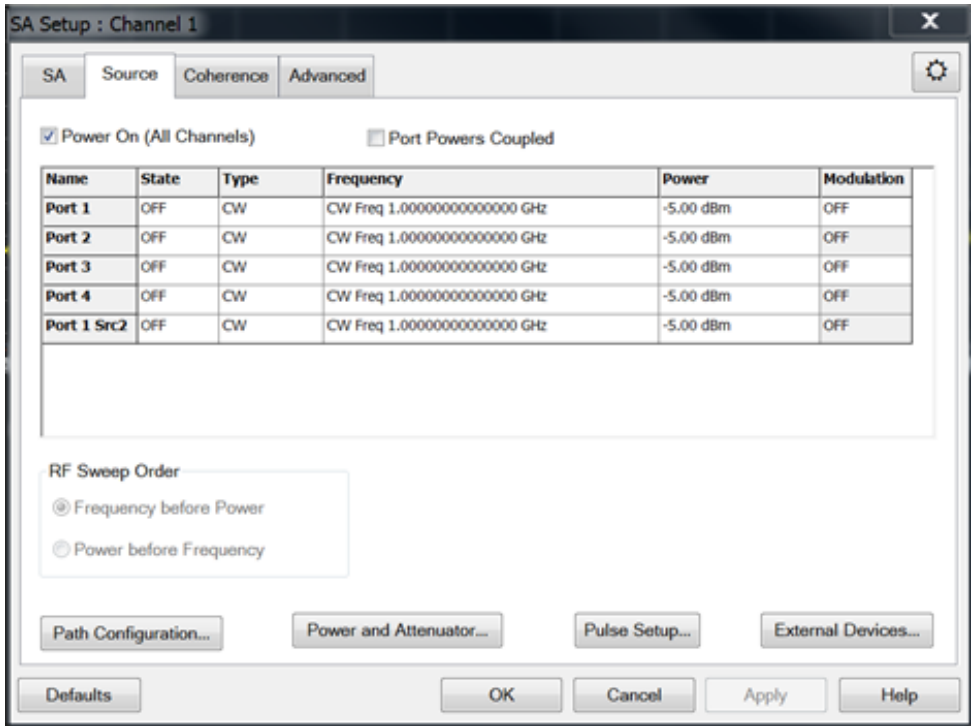

SENSE:SA:SOURce:SWEep:TYPE
 SENSE:SA:SOURce:FREQUency:S
 SENSE:SA:SOURce:FREQUency:S
 SENSE:SA:SOURce:FREQUency:C
 SENSE:SA:SOURce:POW:SWEep:
 SENSE:SA:SOURce:POW:SWEep:
 SENSE:SA:SOURce:POWER:START
 SENSE:SA:SOURce:POWER:STOP
 SENSE:SA:SOURce:POWER[:VALUe
 SOURce:PHASe:ITERation
 SOURce:PHASe:START
 SOURce:PHASe:STOP
 SOURce:PHASe[:FIXed]
 SENSE:SA:SOURce:SWEep:FIRSt[:
 SENSE:SA:SOURce:SWEep:POINT
 SENSE:SA:SOURce:SWEep:REPe:

Coherence Setup tab (Not applicable for M98x0A, P50xxA)

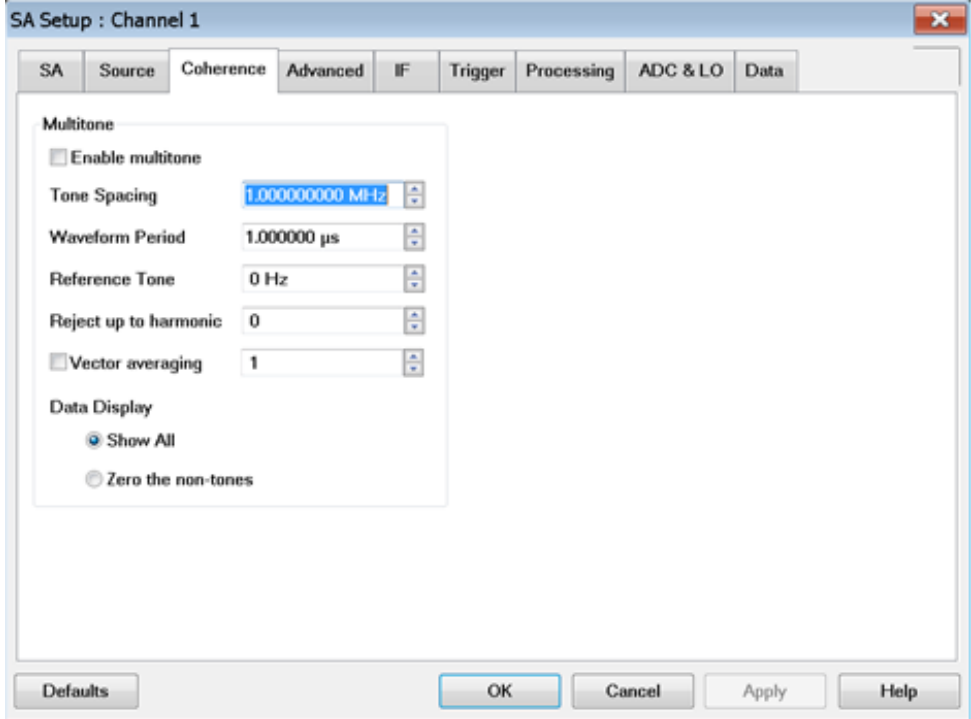

SENSE:SA:COHerence:MULTitone[:
 SENSE:SA:COHerence:MULTitone:
 SENSE:SA:COHerence:MULTitone:
 SENSE:SA:COHerence:MULTitone:
 SENSE:SA:COHerence:MULTitone:
 SENSE:SA:COHerence:MULTitone:
 SENSE:SA:COHerence:MULTitone:
 SENSE:SA:COHerence:VECTor:AV
 SENSE:SA:COHerence:VECTor:AV
 SENSE:SA:COHerence:MULTitone:

Advanced Setup tab

SA Setup : Channel 1

SA Source Coherence **Advanced**

Properties

RBW Shape: Gaussian

Image Reject Type: Normal

Image Reject Strength: Normal

RBW / VBW: 1.000000

Span / RBW: 106.000000

CF Step Size: 100.000000 MHz Auto

Occupied BW search min: 250.000000 MHz

DC Sources

Enable DC outputs

Enable DC sweep

Number of DC levels: 11

Sweep Order

DC before RF

RF before DC

DC Sources...

Advanced >>

Defaults OK Cancel Apply Help

SENSe:SA:BANDwidth:SHAPE

SENSe:SA:IMAGe:REJect

SENSe:SA:IMAGe:STRENGTH

SENSe:SA:BANDwidth:VIDeo:RATIo

SENSe:SA:FREQUency:SPAN:BAN

SENSe:SA:BANDwidth:SEARCh:OC

SENSe:SA:SOURce:DC:SWEEP[:ST

SENSe:SA:SOURce:DC:SWEEP:PC

SENSe:SA:FREQUency:TUNE:IMMe

SENSe:SA:SOURce:DC:SWEEP:FIF

IF Setup tab

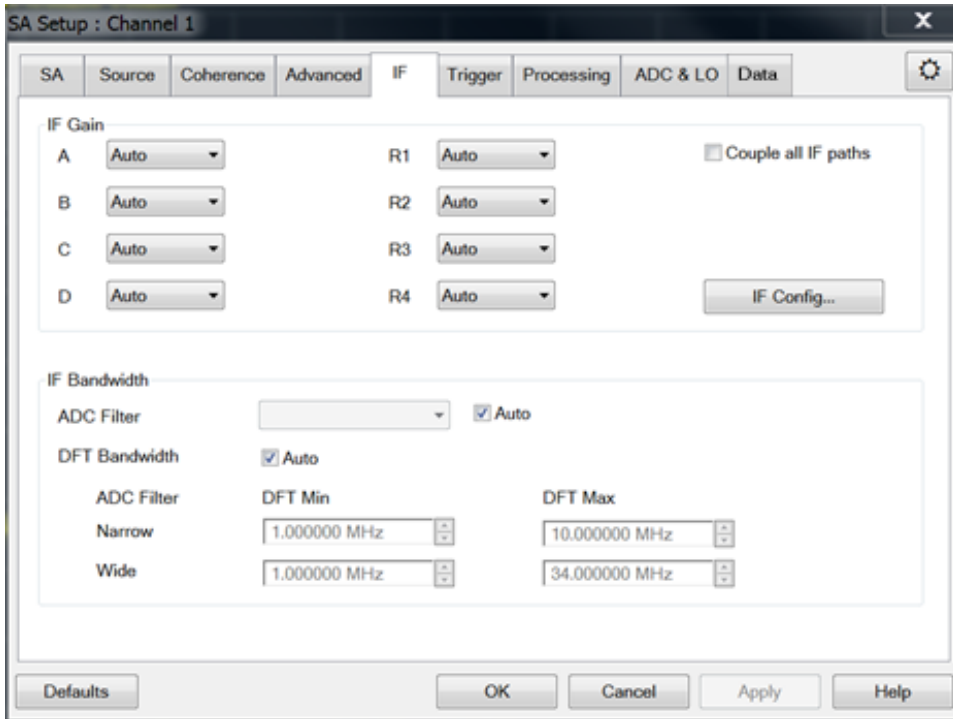

SENSe:SA:ADC:FILTER

SENSe:SA:ADC:FILTER:AUTO

SENSe:SA:DFT:BANDwidth:AUTO

SENSe:SA:DFT:BANDwidth:NARRO

SENSe:SA:DFT:BANDwidth:NARRO

SENSe:SA:DFT:BANDwidth:WIDE:M

SENSe:SA:DFT:BANDwidth:WIDE:M

Trigger Setup tab

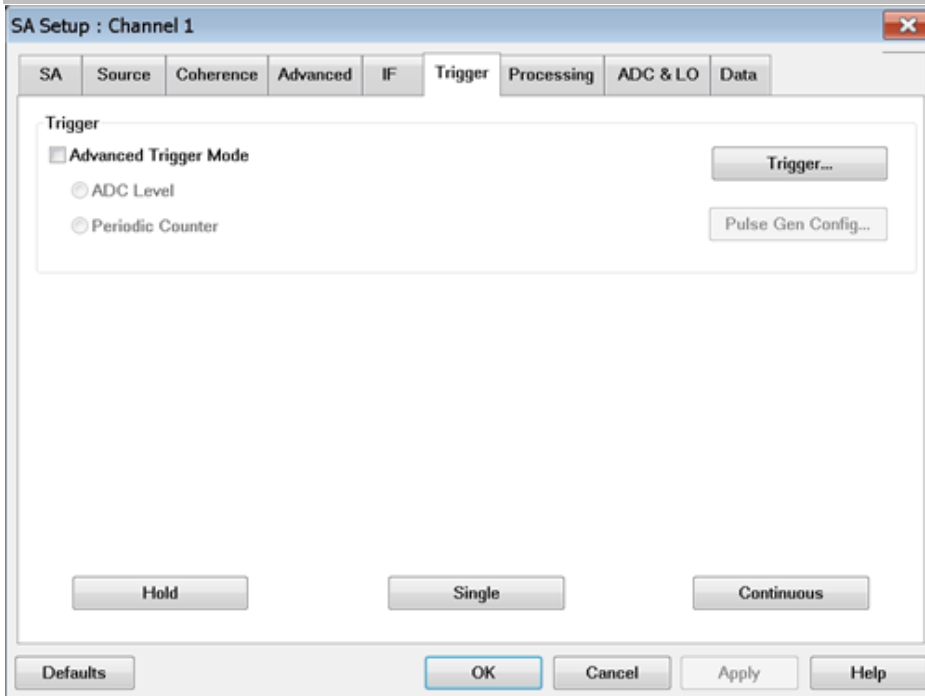

SENSe:SA:TRIGer:LEVel[:STATe]

SENSe:SA:TRIGer:LEVel:VALue

SENSe:SA:TRIGer:PERCounter[:STATe]

SENSe:SA:TRIGer:PERCounter:VALue

Processing Setup tab

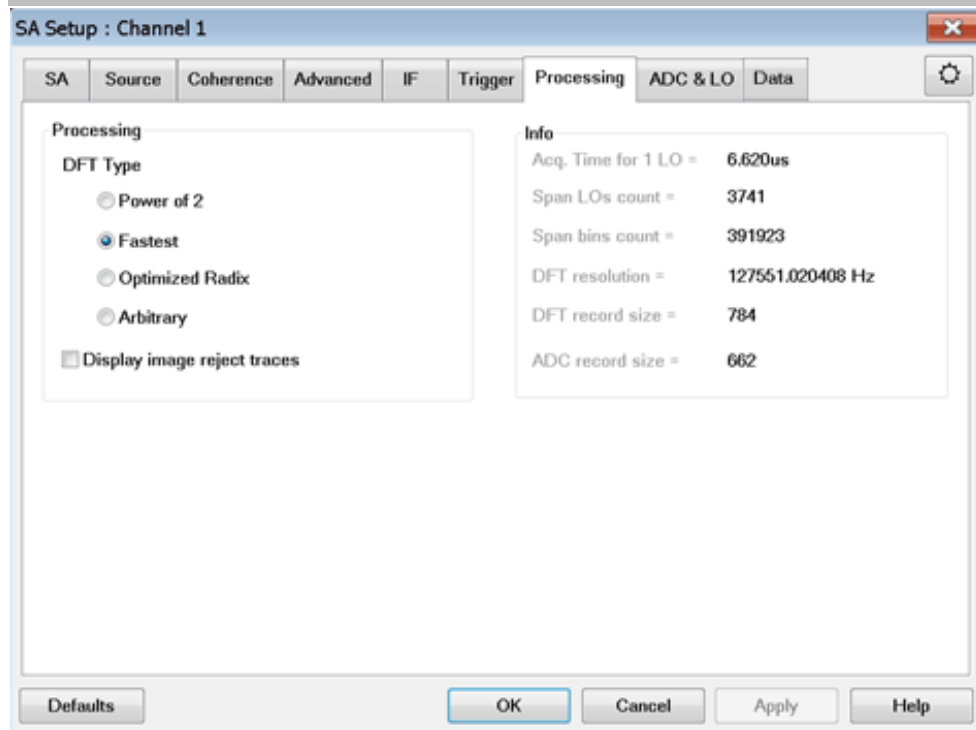

SENSe:SA:DFT:TYPE

SENSe:SA:TRACe:IMAGe[:STATe

SENSe:SA:ADC:ACQTime?

SENSe:SA:LO:COUNT?

SENSe:SA:SPAN:BINS:COUNT?

SENSe:SA:DFT:RESolution?

SENSe:SA:DFT:RECORD:SIZE?

SENSe:SA:ADC:RECORD:SIZE:VAL

ADC & LO Setup tab

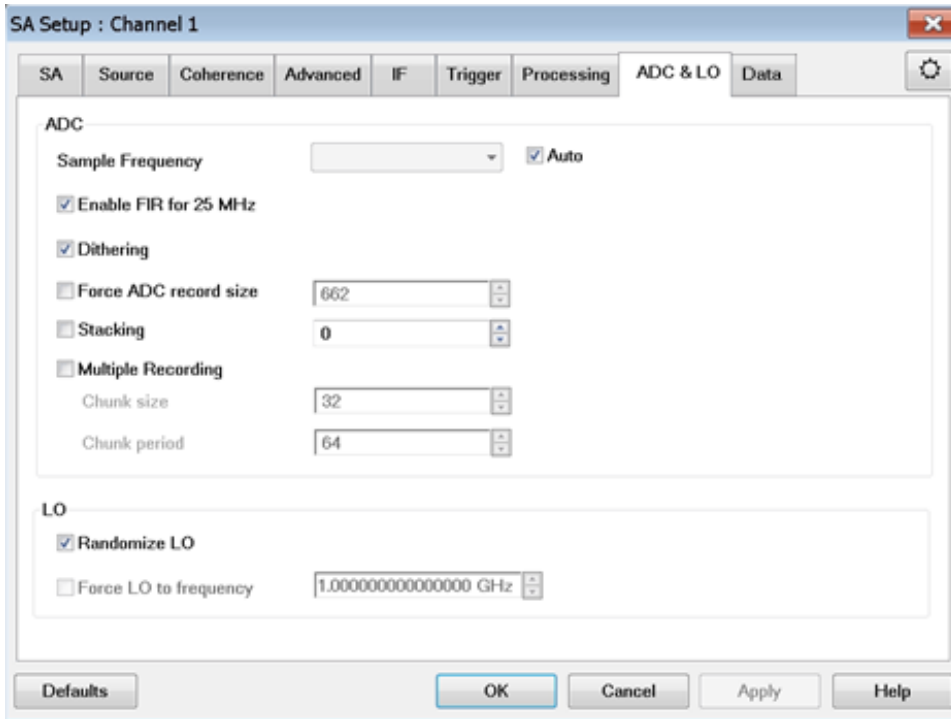

SENSe:SA:ADC:SAMPlE:RATE
 SENSe:SA:ADC:SAMPlE:RATE:AUT
 SENSe:SA:ADC:SAMPlE:DECimatio
 SENSe:SA:ADC:DITHer:[STATe]
 SENSe:SA:ADC:RECOrd:SIZE:VALU
 SENSe:SA:ADC:RECOrd:SIZE:MAX'
 SENSe:SA:ADC:RECOrd:SIZE:MIN?
 SENSe:SA:ADC:RECOrd:SIZE:FORI
 SENSe:SA:ADC:RECOrd:SIZE:FORI
 SENSe:SA:ADC:STACking:VALue
 SENSe:SA:ADC:STACking:STATe
 SENSe:SA:ADC:MREC:SIZE
 SENSe:SA:ADC:MREC:PERiod
 SENSe:SA:ADC:MREC[:STATe]
 SENSe:SA:LO:RANDom:[STATe]
 SENSe:SA:LO:FREQ:FORCe
 SENSe:SA:LO:FREQ:VALue

Data tab

SENSe:SA:DATA:TYPE

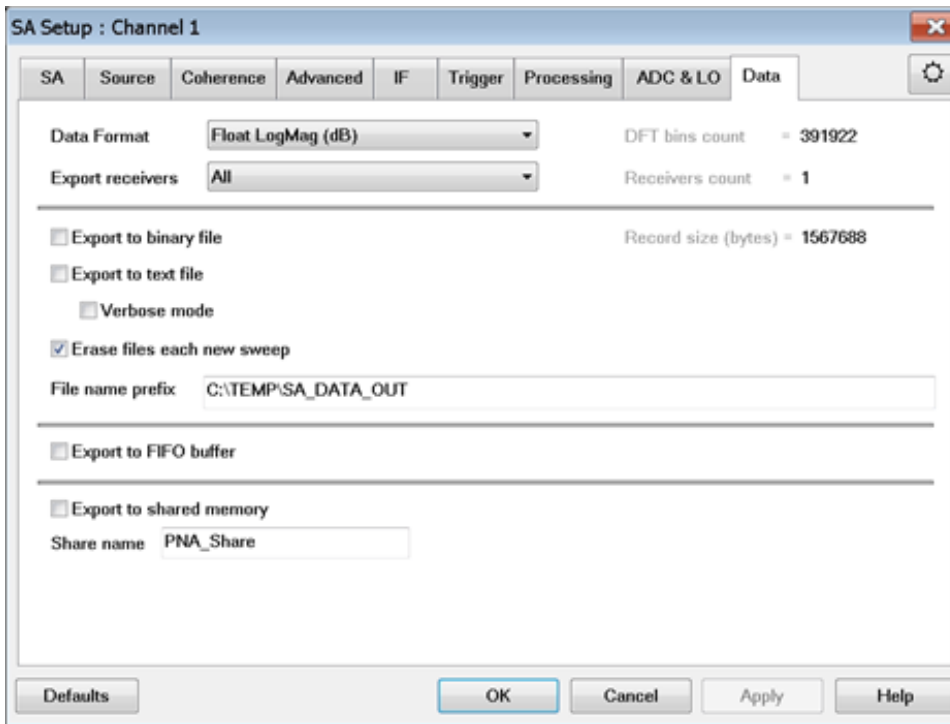

SENSE:SA:DATA:START?
 SENSE:SA:DATA:RECEIVERS?
 SENSE:SA:DATA:RECEIVERS:LIST
 SENSE:SA:DATA:RECEIVERS:COUNT?
 SENSE:SA:DATA:BINs:COUNT?
 SENSE:SA:DATA:SIZE?
 SENSE:SA:DATA:SIZE:BIN?
 SENSE:SA:DATA:SIZE:LOW?
 SENSE:SA:DATA:SIZE:HIGH?
 SENSE:SA:DATA:FILE:BINARy[:STATe]
 SENSE:SA:DATA:FILE:TEXT:MARKERS[:S
 SENSE:SA:DATA:FILE:TEXT[:STATe]
 SENSE:SA:DATA:FILE:TEXT:VERBOSe[:S
 SENSE:SA:DATA:FILE:ERASe[:STATe]
 SENSE:SA:DATA:FILE:PREFIX
 SENSE:SA:DATA:FIFO[:STATe]
 SENSE:SA:DATA:SHARed[:STATe]
 SENSE:SA:DATA:SHARed:NAME
 SENSE:SA:DATA:THRESHold[:STATe]
 SENSE:SA:DATA:THRESHold:VALue
 SENSE:SA:DATA:WFACtor

Other SA SCPI commands

SA Application - Setup tab

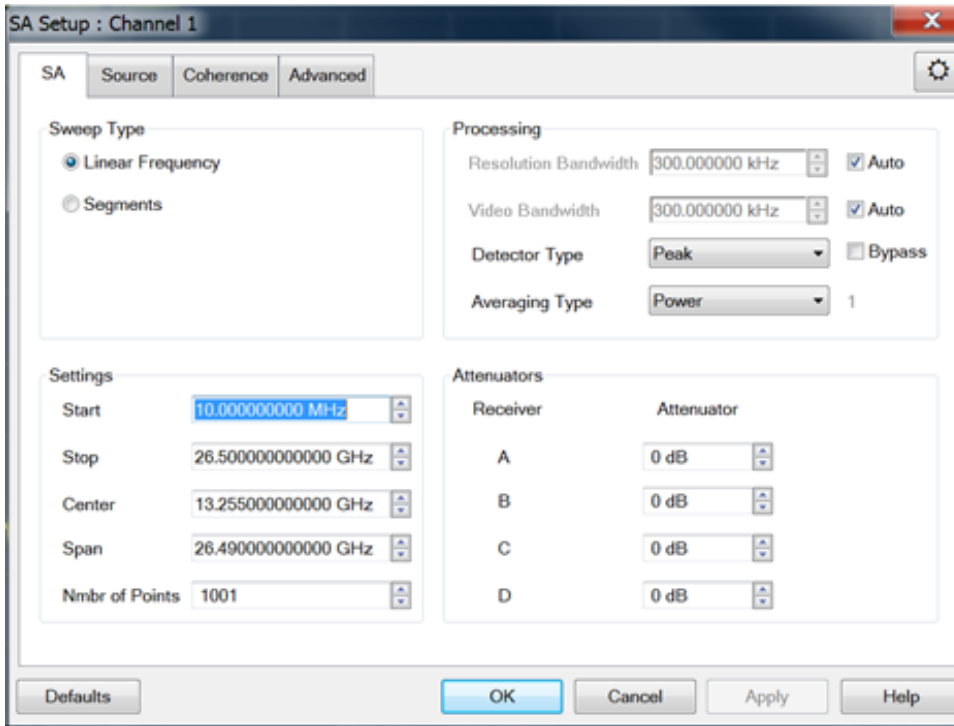

SENS:FREQ:STAR

SENS:FREQ:STOP

SENS:FREQ:CENT

SENS:FREQ:SPAN

SENS:FREQ:SPAN:FULL

SENS:FREQ:CENT:STEP:SIZE

SENS:FREQ:CENT:STEP:AUTO

SENS:FREQ:CW

SENS:SWE:POIN

SENS:POWer:ATT

SENS:PATH:CONFig:ELEM

IF Gain Settings

SA Marker Settings

Sets and reads the bandwidth of the band density marker.
 CALCulate:MEASure:SA:MARKer:BDENsity:BW
 CALCulate:SA:MARKer:BDENsity:BW

Returns the band density level in dBm/Hz from the band density marker.
 CALCulate:MEASure:SA:MARKer:BDENsity:DATA?
 CALCulate:SA:MARKer:BDENsity:DATA?

Marker to SA
 CALC:MEAS:MARKer:SET SA

Read Band Power
 CALC:MEAS:SA:MARK:BPOWer:DATA?

Set and
read Band
Power Span
CALC:MEAS:SA:MARK:BPOWer:SPAN

Set Band
Power State
CALC:MEAS:SA:MARK:BPOWer[:STATe]

Read
occupied
bandwidth center
frequency
CALC:MEAS:SA:MARK:OCCBand:CENTer?

Set and
read
occupied
bandwidth
percentage
of span
CALC:MEAS:SA:MARK:OCCBand:PERCent

Read the
occupied
bandwidth
power.
CALC:MEAS:SA:MARK:OCCBand:POWer?

Read
occupied
bandwidth
span
CALC:MEAS:SA:MARK:OCCBand:SPAN?

Set
occupied
bandwidth
state
CALC:MEAS:SA:MARK:OCCBand[:STATe]

Sets and
reads the
state of
the band
density
noise
marker.
CALCulate:MEASure:SA:MARKer:BDENsity:NOISe[:STATe]
CALCulate:SA:MARKer:BDENsity:NOISe[:STATe]

Sets and
reads the
bandwidth
of the
band
power
density
CALCulate:MEASure:SA:MARKer:BDENsity:POWer:BW
CALCulate:SA:MARKer:BDENsity:POWer:BW

marker.

Sets and reads the state of the band power density marker. `CALCulate:MEASure:SA:MARKer:BDENsity:POWer[:STATe]`
`CALCulate:SA:MARKer:BDENsity:POWer[:STATe]`

Sets and reads the bandwidth of the band tone density marker. `CALCulate:MEASure:SA:MARKer:BDENsity:TONE:BW`
`CALCulate:SA:MARKer:BDENsity:TONE:BW`

Sets and reads the state of the band tone density marker. `CALCulate:MEASure:SA:MARKer:BDENsity:TONE[:STATe]`
`CALCulate:SA:MARKer:BDENsity:TONE[:STATe]`

Sets and reads the spacing of the band tone density marker. `CALCulate:MEASure:SA:MARKer:BDENsity:TONE:TSPacing`
`CALCulate:SA:MARKer:BDENsity:TONE:TSPacing`

Sets and reads the frequency span used by Power Density to normalize the power. `CALCulate:MEASure:SA:MARKer:BDENsity:EQSPan`
`CALCulate:SA:MARKer:BDENsity:EQSPan`

Other SA commands

- `CALCulate:MEASure:DEFine` - creates an SA measurement.

- **SA Calibration** uses the Guided Calibration commands.

See Also

- **Example Program:** Create an SA Measurement
- Learn about SA Application
- Synchronizing the Analyzer and Controller
- SCPI Command Tree

SENSe<ch>:SA:ADC:ACQTime?

Applicable Models: All with Spectrum Analysis Options (S9x09xxA/B, S9x090A/B)

(Read-only) Returns the LO acquisition time which is the ADC Record Size x ADC Sampling Frequency (10 nsec or 40 nsec) x (1 + Stacking) x (Video Average.Coefficient).

Parameters

<ch> Channel number of the measurement. If unspecified, value is set to 1.

Examples

```
SENS:SA:ADC:ACQT?
sense2:sa:adc:acqtime?
```

Default Not applicable

SENSe<ch>:SA:ADC:DITHer[:STATe] <bool>

Applicable Models: All with Spectrum Analysis Options (S9x09xxA/B, S9x090A/B) (Except M98x0A, P50xxA)

(Read-Write) Set and read the ON/OFF state of the dither setting

Parameters

- <ch> Any existing SA channel. If unspecified, value is set to 1.
- <bool> Choose from:
 - 0 - OFF** - Dither OFF.
 - 1 - ON** - Dither ON.

Learn about these settings .

Examples `SENS:SA:ADC:DITH 1`

Query Syntax `SENSe<ch>:SA:ADC:DITH?`

Return Type Boolean

Default 0

`SENSe<ch>:SA:ADC:FILTER <num>`

Applicable Models: All with Spectrum Analysis Options (S9x09xxA/B, S9x090A/B) (Except M98x0A, P50xxA)

(Read-Write) Set and read the ADC filter cutoff frequency. The entered frequency value is rounded to the closest value supported by the VNA (11 MHz or 38 MHz).

Parameters

- `<ch>` Any existing SA channel. If unspecified, value is set to 1.
- `<num>` Choose 11 MHz or 38 MHz.

Learn about these settings.

Examples `SENS:SA:ADC:FILTER 11MHz`

Query Syntax `SENSe<ch>:SA:ADC:FILTER?`

Return Type Numeric

Default 11 MHz

`SENSe<ch>:SA:ADC:FILTER:AUTO <bool>`

Applicable Models: All with Spectrum Analysis Options (S9x09xxA/B, S9x090A/B) (Except M98x0A, P50xxA)

(Read-Write) Set and read how the ADC filter is set. When ON, the ADC filter is set based on the start and stop frequencies and the ADC sampling frequency.

Parameters

- <ch> Any existing SA channel. If unspecified, value is set to 0.
 - <bool> Choose from:
 - 0 - OFF** - ADC filter is set manually using SENS:SA:ADC:FILT .
 - 1 - ON** - ADC filter is set automatically.
- Learn about these settings .

Examples

```
SENS:SA:ADC:FILT:AUTO ON
```

Query Syntax

```
SENSe<ch>:SA:ADC:FILT:er:AUTO?
```

Return Type

Boolean

Default

1

```
SENSe<ch>:SA:ADC:MREC:PERiod <value>
```

Applicable Models: All with Spectrum Analysis Options (S9x09xxA/B, S9x090A/B) (Except M98x0A, P50xxA)

(Read-Write) Set and read the period to wait between ADC record chunks.

Parameters

- <ch> Any existing SA channel. If unspecified, value is set to 1.
 - <value> Choose a value between 64 and 33554432
- Learn about these settings .

Examples

```
SENS:SA:ADC:MREC:PER 256
```

Query Syntax

```
SENSe<ch>:SA:ADC:MREC:PERiod?
```

Return Type

Integer

Default

64

SENSe<ch>:SA:ADC:MREC:SIZE <value>

Applicable Models: All with Spectrum Analysis Options (S9x09xxA/B, S9x090A/B) (Except M98x0A, P50xxA)

(Read-Write) Set and read the size of the ADC record chunks.

Parameters

- <ch> Any existing SA channel. If unspecified, value is set to 1.
<value> Choose a value between 1 and (ADC record size / 2).

Learn about these settings .

Examples

```
SENS:SA:ADC:MREC:SIZE 256
```

Query Syntax SENSe<ch>:SA:ADC:MREC:SIZE?

Return Type Integer

Default 32

SENSe:SA:ADC:MREC[:STATe] <bool>

Applicable Models: All with Spectrum Analysis Options (S9x09xxA/B, S9x090A/B) (Except M98x0A, P50xxA)

(Read-Write) Set and read the ON/OFF state of the multiple recording function. Multiple recording allows the ADC Record Size to be divided and acquired in smaller "chunks" and also to specify a wait period between these acquisitions.

Parameters

- <ch> Any existing SA channel. If unspecified, value is set to 1.
<bool> Choose from:

0 - OFF - ADC record size "chunking" OFF.

1 - ON - ADC record size "chunking" ON.

Learn about these settings .

Examples

```
SENS:SA:ADC:MREC 0
```

Query Syntax SENSe<ch>:SA:ADC:MREC[:STATe]?

Return Type Boolean

Default 0

SENSe<ch>:SA:ADC:RECOrd:SIZE:FORCe[:STATe] <bool>

Applicable Models: All with Spectrum Analysis Options (S9x09xxA/B, S9x090A/B)

(Read-Write) Set and read the ADC record size mode.

Parameters

- <ch> Any existing SA channel. If unspecified, value is set to 1.
- <bool> Choose from:
- 0 - OFF** - ADC record size set automatically.
 - 1 - ON** - Manually set ADC record to specified size.

Learn about these settings .

Examples

```
SENS:SA:ADC:REC:SIZE:FORC:STAT 1
```

Query Syntax SENSe<ch>:SA:ADC:REC:SIZE:FORC[:STATe]?

Return Type Boolean

Default 0

SENSe<ch>:SA:ADC:RECOrd:SIZE:FORCe:VALue <num>

Applicable Models: All with Spectrum Analysis Options (S9x09xxA/B, S9x090A/B)

(Read-Write) Set and read the integer size value for the force ADC record size feature.

Parameters

- <ch> Any existing SA channel. If unspecified, value is set to 1.
- <num> ADC record size.

Learn about these settings .

Examples

```
SENS:SA:ADC:REC:SIZE:FORC:VAL 64
```

Query Syntax SENSe<ch>:SA:ADC:REC:SIZE:FORC:VAL?

Return Type Numeric

Default Not applicable

SENSe<ch>:SA:ADC:RECOrd:SIZE:MAX?

Applicable Models: All with Spectrum Analysis Options (S9x09xxA/B, S9x090A/B)

(Read-only) Read the current maximum available ADC record size.

Parameters

<ch> Any existing SA channel. If unspecified, value is set to 1.

Examples `SENS:SA:ADC:REC:SIZE:MAX?`

Return Type Integer

Default Not applicable

`SENSe<ch>:SA:ADC:RECORD:SIZE:MIN?`

Applicable Models: All with Spectrum Analysis Options (S9x09xxA/B, S9x090A/B)

(Read-only) Read the current minimum available ADC record size.

Parameters

<ch> Any existing SA channel. If unspecified, value is set to 1.

Examples `SENS:SA:ADC:REC:SIZE:MIN?`

Return Type Integer

Default Not applicable

`SENSe<ch>:SA:ADC:RECORD:SIZE:VALUE?`

Applicable Models: All with Spectrum Analysis Options (S9x09xxA/B, S9x090A/B)

(Read-only) Read ADC record size value.

Parameters

<ch> Any existing SA channel. If unspecified, value is set to 1.

Examples `SENS:SA:ADC:REC:SIZE:VAL? 256`

Return Type Integer

Default Not applicable

`SENSe<ch>:SA:ADC:SAMPLE:DECIMATION:FIR <bool>`

Applicable Models: All with Spectrum Analysis Options (S9x09xxA/B, S9x090A/B) (Except M98x0A, P50xxA)

(Read-Write) Set and read the FIR filter for 25 MHz decimation.

Parameters

- <ch> Any existing SA channel. If unspecified, value is set to 1.
- <bool> Choose from:
 - 0 - OFF** -Disable 25 MHz FIR filter.
 - 1 - ON** - Enable 25 MHz FIR filter.

Examples

```
SENS:SA:ADC:SAMPle:DECimation:FIR 1
```

Query Syntax SENSE<ch>:SA:ADC:SAMPle:DECimation:FIR?

Return Type Boolean

Default 0

```
SENSe<ch>:SA:ADC:SAMPle:RATE <num>
```

Applicable Models: All with Spectrum Analysis Options (S9x09xxA/B, S9x090A/B) (Except M98x0A, P50xxA)

(Read-Write) Set and read the ADC sampling frequency. The entered frequency is rounded to the closest value supported by the VNA (25 MHz or 100 MHz).

Parameters

- <ch> Any existing SA channel.
 - <num> Choose from 100 MHz or 25 MHz.
- [Learn about these settings.](#)

Examples

```
SENS:SA:ADC:SAMP:RATE 100MHz
```

Query Syntax SENSe<ch>:SA:ADC:SAMP:RATE?

Return Type Numeric

Default 100 MHz

```
SENSe<ch>:SA:ADC:SAMPle:RATE:AUTO <bool>
```

Applicable Models: All with Spectrum Analysis Options (S9x09xxA/B, S9x090A/B) (Except M98x0A, P50xxA)

(Read-Write) Set and read the ADC sample rate mode.

Parameters

- <ch> Any existing SA channel. If unspecified, value is set to 1.
 - <bool> Choose from:
 - 0 - OFF** - Manually set ADC sampling rate using SENSE:SA:ADC:SAMPle:RATE .
 - 1 - ON** - ADC sampling rate set automatically.
- Learn about these settings .

Examples

```
SENS : SA : ADC : SAMP : RATE : AUTO 1
```

Query Syntax SENSE<ch>:SA:ADC:SAMPle:RATE:AUTO?

Return Type Boolean

Default 1

SENSe:SA:ADC:STACKing:STATe <bool>

Applicable Models: All with Spectrum Analysis Options (S9x09xxA/B, S9x090A/B) (Except M98x0A, P50xxA)

(Read-Write) Set and read the ON/OFF state of the ADC sample stacking.

Parameters

- <ch> Any existing SA channel. If unspecified, value is set to 1.
 - <bool> Choose from:
 - 0 - OFF** - ADC sample stacking OFF.
 - 1 - ON** - ADC sample stacking ON.
- Learn about these settings .

Examples

```
SENS : SA : ADC : STAC : STAT 0
```

Query Syntax SENSE<ch>:SA:ADC:STACKing:STATe?

Return Type Boolean

Default 0

SENSe<ch>:SA:ADC:STACking:VALue [<MAX>] <value>

Applicable Models: All with Spectrum Analysis Options (S9x09xxA/B, S9x090A/B) (Except M98x0A, P50xxA)

(Read-Write) Set and read the ADC stacking value.

Parameters

- <ch> Any existing SA channel. If unspecified, value is set to 0 (no stacking).
- [<MAX>] Sets and reads the current maximum available stacking size.
- <value> Choose a value between 0 and 65535.

Learn about these settings.

Examples

```
SENS:SA:ADC:STAC:VAL 1
```

Query Syntax SENSe<ch>:SA:ADC:STACking:VALue? MAX

Return Type Integer

Default 0

SENSe<ch>:SA:BANDwidth[:RESolution] <num>

Applicable Models: All with Spectrum Analysis Options (S9x09xxA/B, S9x090A/B)

(Read-Write) Set and read the resolution bandwidth. Also set SENS:SA:BAND:AUTO OFF.

Parameters

- <ch> Any existing SA channel. If unspecified, value is set to 1.
- <num> Choose a value between 6 Hz and 3 MHz. Attempting to set the bandwidth outside these bounds will force the bandwidth to the nearest bound.

Learn about these settings .

Examples

```
SENS:SA:BAND 1e3
```

Query Syntax SENSe<ch>:SA:BANDwidth[:RESolution]?

Return Type Numeric

Default 100 kHz

SENSe<ch>:SA:BANDwidth:RESolution <enum>

Applicable Models: All with Spectrum Analysis Options (S9x09xxA/B, S9x090A/B)

(Read-Write) Set and read the minimum and maximum resolution bandwidth.

Parameters

- <ch> Any existing SA channel. If unspecified, value is set to 1.
<enum> Choose from:

MAX

MIN

Examples

```
SENS:SA:BAND:RES MAX
```

Query Syntax SENSe<ch>:SA:BANDwidth:RESolution? MIN

Return Type Double

Default N/A

SENSe<ch>:SA:BANDwidth[:RESolution]:AUTO <bool>

Applicable Models: All with Spectrum Analysis Options (S9x09xxA/B, S9x090A/B)

(Read-Write) Set and read how the resolution bandwidth is set. When ON, the resolution bandwidth is set based on Span/RBW ratio.

Parameters

- <ch> Any existing SA channel. If unspecified, value is set to 1.
<bool> Choose from:

0 - OFF - Res. BW is set manually using SENS:SA:BAND .

1 - ON - Res. BW is set automatically.

Learn about these settings .

Examples

```
SENS:SA:BAND:AUTO 1
```

Query Syntax SENSe<ch>:SA:BANDwidth[:RESolution]:AUTO?

Return Type Boolean

Default 1

SENSe<ch>:SA:BANDwidth:RESolution:CATalog?

Applicable Models: All with Spectrum Analysis Options (S9x09xxA/B, S9x090A/B)

(Read-only) Read the list of all Resolution Bandwidth values currently supported with spectrum analyzer current settings.

Parameters

<ch> Any existing SA channel. If unspecified, value is set to 1.

Examples SENS:SA:BAND:RES:CAT?

Default Not applicable

SENSe<ch>:SA:BANDwidth:SEARch:OCCupied:MIN <num>

Applicable Models: All with Spectrum Analysis Options (S9x09xxA/B, S9x090A/B)

(Read-Write) Set and read the minimum search frequency to use during an Occupied BW search measurement. Power below this frequency is ignored.

Parameters

<ch> Any existing SA channel. If unspecified, value is set to 1.

<num> Minimum search frequency value.

Learn about these settings .

Examples SENS:SA:BAND:SEAR:OCC:MIN 300e6

Query Syntax SENSe<ch>:SA:BANDwidth:SEARch:OCCupied:MIN?

Return Type Numeric

Default 250 MHz

SENSe<ch>:SA:BANDwidth:SHAPE <enum>

Applicable Models: All with Spectrum Analysis Options (S9x09xxA/B, S9x090A/B)

(Read-Write) Set and read the resolution bandwidth shape.

Parameters

- <ch> Any existing SA channel. If unspecified, value is set to 1.
- <enum> Choose from:
 - GAUSSian**
 - FLATtop**
 - KAISer**
 - BLACKman**
 - NONE**

Learn about these settings.

Examples

```
SENS:SA:BAND:SHAP GAUS
```

Query Syntax SENSE<ch>:SA:BANDwidth:SHAPE?

Return Type Enumeration

Default GAUSSian

```
SENSe<ch>:SA:BANDwidth:VIDeo <enum>
```

Applicable Models: All with Spectrum Analysis Options (S9x09xxA/B, S9x090A/B)

(Read-Write) Set and read the minimum and maximum video bandwidth.

Parameters

- <ch> Any existing SA channel. If unspecified, value is set to 1.
- <enum> Choose from:
 - MAX**
 - MIN**

Examples

```
SENS:SA:BAND:VID MAX
```

Query Syntax SENSe<ch>:SA:BANDwidth:VIDeo? MIN

Return Type Double

Default N/A

SENSE<ch>:SA:BANDwidth:VIDeo <num>

Applicable Models: All with Spectrum Analysis Options (S9x09xxA/B, S9x090A/B)

(Read-Write) Set and read the Video bandwidth. Also set SENS:SA:BAND:VID:AUTO OFF.

Parameters

- <ch> Any existing SA channel. If unspecified, value is set to 1.
- <num> Choose a value between 3 Hz and 3 MHz. Going outside this range places the trace into a hold mode.

[Learn about these settings .](#)

Examples

```
SENS:SA:BAND:VID 1e5
```

Query Syntax SENSE<ch>:SA:BANDwidth:VIDeo?

Return Type Numeric

Default 100 kHz

SENSE<ch>:SA:BANDwidth:VIDeo:AUTO <bool>

Applicable Models: All with Spectrum Analysis Options (S9x09xxA/B, S9x090A/B)

(Read-Write) Set and read how the video bandwidth is set. When ON, video bandwidth is set based on RBW/VBW ratio.

Parameters

- <ch> Any existing SA channel. If unspecified, value is set to 1.
- <bool> Choose from:
- 0 - OFF** - Video BW is set manually using SENS:SA:BAND.
 - 1 - ON** - Video BW is set automatically.

[Learn about these settings .](#)

Examples

```
SENS:SA:BAND:VID:AUTO 1
```

Query Syntax SENSE<ch>:SA:BANDwidth:VIDeo:AUTO?

Return Type Boolean

Default 1

SENSe<ch>:SA:BANDwidth:VIDeo:AVERage:COUNT?

Applicable Models: All with Spectrum Analysis Options (S9x09xxA/B, S9x090A/B)

(Read-only) Reads the number of Video bandwidth sweeps that are averaged together. This readout is displayed on the SA setup page.

Parameters

<ch> Any existing SA channel. If unspecified, value is set to 1.

Examples

```
SENS:SA:BAND:VID:AVER:COUNT?
```

Query Syntax SENSe<ch>:SA:BANDwidth:VIDeo:AVER:COUNT?

Return Type Numeric

Default 1

SENSe<ch>:SA:BANDwidth:VIDeo:AVER:TYPE <enum>

Applicable Models: All with Spectrum Analysis Options (S9x09xxA/B, S9x090A/B)

(Read-Write) Set and read the averaging type.

Parameters

<ch> Any existing SA channel. If unspecified, value is set to 1.

<enum> Choose from:

VOLTage

POWER

LOG

VMAX (Voltage Max)

VMIN (Voltage Min)

Learn about these settings.

Examples

```
SENS:SA:BAND:VID:AVER:TYPE VOLT
```

Query Syntax SENSe<ch>:SA:BANDwidth:VIDeo:AVER:TYPE?

Return Type Enumeration

Default POWer

SENSe<ch>:SA:BANDwidth:VIDeo:RATio <num>

Applicable Models: All with Spectrum Analysis Options (S9x09xxA/B, S9x090A/B)

(Read-Write) Set and read the RBW / VBW ratio.

Parameters

- <ch> Any existing SA channel. If unspecified, value is set to 1.
- <num> RBW / VBW ratio.

Learn about these settings .

Examples

```
SENS : SA : BAND : VID : RAT
```

Query Syntax SENSe<ch>:SA:BANDwidth:VIDeo:RATio?

Return Type Numeric

Default 1.0

SENSe<ch>:SA:DATA:BINs:COUNT?

Applicable Models: All with Spectrum Analysis Options (S9x09xxA/B, S9x090A/B)

(Read-only) Read the number of DFT points to be exported across the total RF span. Note that this number is modified by the SENSe:SA:COHerence:MULTitone:DATA ZNT setting: If coherent multitone mode is enabled, only the frequency points that are on the multitone grid are exported.

Parameters

- <ch> Any existing SA channel. If unspecified, value is set to 1.

Examples

```
SENS : SA : DATA : BIN : COUN?
```

Return Type Integer

Default Not applicable

SENSe<ch>:SA:DATA:FIFO[:STATe] <bool>

Applicable Models: All with Spectrum Analysis Options (S9x09xxA/B, S9x090A/B)

(Read-Write) Enables/disables exporting data to the FIFO (First-IN, First-OUT) data buffer. FIFO is a circular buffer that allows very fast Read-Write access.

Parameters

- <ch> Any existing SA channel. If unspecified, value is set to 1.
- <bool> Choose from:
 - 0 - OFF** - Export data to FIFO disabled.
 - 1 - ON** - Export data to FIFO enabled.

Examples

```
SENS:SA:DATA:FIFO 1
```

Query Syntax SENSE<ch>:SA:DATA:FIFO[:STATE]?

Return Type Boolean

Default 0

Note: FIFO commands are under SYTSEM:FIFO , and a new set of commands has been added here for binary data.

```
SENSe<ch>:SA:DATA:FILE:BINary[:STATE] <bool>
```

Applicable Models: All with Spectrum Analysis Options (S9x09xxA/B, S9x090A/B)

(Read-Write) Enables/disables binary file (*.bin) output. Data is not exported until the next new sweep occurs.

Parameters

- <ch> Any existing SA channel. If unspecified, value is set to 1.
- <bool> Choose from:
 - 0 - OFF** - Disable binary file output.
 - 1 - ON** - Enable binary file output.

Examples

```
SENS:SA:DATA:FILE:BIN 1
```

Query Syntax SENSe<ch>:SA:DATA:FILE:BINary[:STATE]?

Return Type Boolean

Default 0

SENSe<ch>:SA:DATA:FILE:ERASe[:STATe] <bool>

Applicable Models: All with Spectrum Analysis Options (S9x09xxA/B, S9x090A/B)

(Read-Write) Enables/disables erasing output data files after each sweep. When disabled, data is appended to the output file after each sweep which could lead to very large files sizes (and eventually fill the disk).

Parameters

- <ch> Any existing SA channel. If unspecified, value is set to 1.
- <bool> Choose from:
- 0 - OFF** - Erase data files after each sweep disabled.
 - 1 - ON** - Erase data files after each sweep enabled.

Examples

```
SENS:SA:DATA:FILE:ERA 1
```

Query Syntax SENSe<ch>:SA:DATA:FILE:ERASe[:STATe]?

Return Type Boolean

Default 1

SENSe<ch>:SA:DATA:FILE:PREFfix <string>

Applicable Models: All with Spectrum Analysis Options (S9x09xxA/B, S9x090A/B)

(Read-Write) Set and return the file name prefix for the data file. The receivers selected in SENSe:SA:DATA:RECEivers:LIST will be appended to the specified prefix name with either "_X.txt" if a text file is exported (SENSe:SA:DATA:FILE:TEXT) or "_X.bin" if a binary file is exported (SENSe:SA:DATA:FILE:BINary). X is the receiver name.

Parameters

- <ch> Any existing SA channel. If unspecified, value is set to 1.
- <string> **String**. Specified prefix.

Examples

```
SENS:SA:DATA:FILE:PREF "C:\TEMP\SA_DATA_OUT"
```

Query Syntax SENSe<ch>:SA:DATA:FILE:PREFfix?

Return Type String

Default "C:\TEMP\SA_DATA_OUT"

SENSe<ch>:SA:DATA:FILE:TEXT:MARKers[:STATe] <bool>

Applicable Models: All with Spectrum Analysis Options (S9x09xxA/B, S9x090A/B)

(Read-Write) Enables/disables adding marker data to the text file (*.txt) output.

Parameters

<ch> Any existing SA channel. If unspecified, value is set to 1.

<bool> Choose from:

0 - OFF - Do not add marker data to the text file output.

1 - ON - Add marker data to the text file output.

Examples

SENS : SA : DATA : FILE : TEXT : MARK : STAT 1

Query Syntax SENSe<ch>:SA:DATA:FILE:TEXT:MARKers[:STATe]?

Return Type Boolean

Default 0

SENSe<ch>:SA:DATA:FILE:TEXT[:STATe] <bool>

Applicable Models: All with Spectrum Analysis Options (S9x09xxA/B, S9x090A/B)

(Read-Write) Enables/disables text file (*.txt) output. Data is not exported until the next new sweep occurs.

Parameters

<ch> Any existing SA channel. If unspecified, value is set to 1.

<bool> Choose from:

0 - OFF - Disable text file output.

1 - ON - Enable text file output.

Examples

SENS : SA : DATA : FILE : TEXT 1

Query Syntax SENSe<ch>:SA:DATA:FILE:TEXT[:STATe]?

Return Type Boolean

Default 0

SENSe<ch>:SA:DATA:FILE:TEXT:VERBoSe[:STATe] <bool>

Applicable Models: All with Spectrum Analysis Options (S9x09xxA/B, S9x090A/B)

(Read-Write) Enables/disables exporting frequency and data for text files. Data is not exported until the next new sweep occurs.

Parameters

- <ch> Any existing SA channel. If unspecified, value is set to 1.
- <bool> Choose from:
 - 0 - OFF** - Disable text file output.
 - 1 - ON** - Enable text file output.

Examples

SENS:SA:DATA:FILE:TEXT 1

Query Syntax

SENSe<ch>:SA:DATA:FILE:TEXT[:STATe]?

Return Type

Boolean

Default

0

SENSe<ch>:SA:DATA:RECeivers?

Applicable Models: All with Spectrum Analysis Options (S9x09xxA/B, S9x090A/B)

(Read-only) Read the list of receivers that will be exported to a data file.

Parameters

- <ch> Any existing SA channel. If unspecified, value is set to 1.
- <list> **String** . Comma separated list of receivers.

Examples

SENS:SA:DATA:RECeivers?

Return Type

String

Default

Not applicable

Note: The list is set with SENS:SA:DATA:REC:LIST can contain more receivers, this query will only return the ones that are currently measured and that are in the receiver list.

SENSe<ch>:SA:DATA:RECeivers:COUNT?

Applicable Models: NAll with Spectrum Analysis Options (S9x09xxA/B, S9x090A/B)

(Read-only) Read the number of currently exported receivers.

Parameters

<ch> Any existing SA channel. If unspecified, value is set to 1.

Examples SENS:SA:DATA:REC:COUN?

Return Type Integer

Default Not applicable

SENSe<ch>:SA:DATA:RECEivers:LIST <string>

Applicable Models: All with Spectrum Analysis Options (S9x09xxA/B, S9x090A/B)

(Read-Write) Set and read the list of receivers to export. The order set using this command will determine the order in which data will be exported to the FIFO data buffer.

Parameters

<ch> Any existing SA channel. If unspecified, value is set to 1.

<string> **String** . Comma separated list of receivers. The “All” option will select all the currently working receivers of the current channel. If the user sets an empty list, this is equivalent to sending “ALL”.

Examples SENS:SA:DATA:REC:LIST "A,B,a1,a2"

Query Syntax SENSe<ch>:SA:DATA:RECEivers:LIST?

Return Type String

Default Not applicable

Note: This list can contain receivers that are not currently measured in the channel. However, this is not an issue. To get the current list of receivers that export data, query SENS:SA:DATA:REC?

SENSe<ch>:SA:DATA:SHARed:NAME <string>

Applicable Models: All with Spectrum Analysis Options (S9x09xxA/B, S9x090A/B)

(Read-Write) Assigns a specified name to the Microsoft Windows shared data mechanism when SENSE:SA:DATA:SHARed:STATe is enabled.

Parameters

- <ch> Any existing SA channel. If unspecified, value is set to 1.
- <string> **String** . Memory file name.

Examples

```
SENS:SA:DATA:SHAR:NAM "Mem_Share"
```

Query Syntax SENSE<ch>:SA:DATA:SHARed:NAME?

Return Type String

Default Not applicable

```
SENSe<ch>:SA:DATA:SHARed[::STATe] <bool>
```

Applicable Models: All with Spectrum Analysis Options (S9x09xxA/B, S9x090A/B)

(Read-Write) Enables/disables exporting data to shared memory, which is the fastest way to transfer data between applications.

Parameters

- <ch> Any existing SA channel. If unspecified, value is set to 1.
- <bool> Choose from:
 - 0 - OFF** - Disable memory sharing.
 - 1 - ON** - Enable memory sharing.

Examples

```
SENS:SA:DATA:SHAR 1
```

Query Syntax SENSe<ch>:SA:DATA:SHARed[::STATe]?

Return Type Boolean

Default 0

```
SENSe<ch>:SA:DATA:SIZE?
```

Applicable Models: All with Spectrum Analysis Options (S9x09xxA/B, S9x090A/B)

(Read-only) Read the byte size of the data to be exported in binary mode.

Parameters

<ch> Any existing SA channel. If unspecified, value is set to 1.

Examples

```
SENS:SA:DATA:SIZE?
```

Return Type Integer

Default Not applicable

Note: Returned number can exceed the maximum integer number size. In that case, an error will be raised. For that reason, we provide an access to larger numbers with the same query and LSB or MSB suffixes.

```
SENSe<ch>:SA:DATA:SIZE:BIN?
```

Applicable Models: All with Spectrum Analysis Options (S9x09xxA/B, S9x090A/B)

(Read-only) Read the byte size of one data bin in binary mode .

Parameters

<ch> Any existing SA channel. If unspecified, value is set to 1.

Examples

```
SENS:SA:DATA:SIZE:BIN?
```

Return Type Integer

Default Not applicable

```
SENSe<ch>:SA:DATA:SIZE:HIGH?
```

Applicable Models: All with Spectrum Analysis Options (S9x09xxA/B, S9x090A/B)

(Read-only) Read the most significant bytes (MSB) of the byte size of the data to be exported.

Parameters

<ch> Any existing SA channel. If unspecified, value is set to 1.

Examples SENS:SA:DATA:SIZE:HIGH?

Return Type Integer

Default Not applicable

SENSe<ch>:SA:DATA:SIZE:LOW?

Applicable Models: All with Spectrum Analysis Options (S9x09xxA/B, S9x090A/B)

(Read-only) Read the least significant bytes (LSB) of the byte size of the data to be exported.

Parameters

<ch> Any existing SA channel. If unspecified, value is set to 1.

Examples SENS:SA:DATA:SIZE:LOW?

Return Type Integer

Default Not applicable

SENSe<ch>:SA:DATA:STARt?

Applicable Models: All with Spectrum Analysis Options (S9x09xxA/B, S9x090A/B)

(Read-only) Read the frequency of the first RF bin.

Parameters

<ch> Any existing SA channel. If unspecified, value is set to 1.

Examples SENS:SA:DATA:STAR?

Return Type Double

Default Not applicable

Note: This value can differ slightly from the SA Sweep start frequency, the frequency of the first RF bin is aligned with the current DFT grid.

SENSe<ch>:SA:DATA:THReshold[:STATe] <bool>

Applicable Models: All with Spectrum Analysis Options (S9x09xxA/B, S9x090A/B)

(Read-Write) Enables/disables data level threshold mode. Set the threshold level using the SENSe:SA:DATA:THReshold:VALue command.

Parameters

- <ch> Any existing SA channel. If unspecified, value is set to 1.
- <bool> Choose from:
- 0 - OFF** - Disable threshold mode.
 - 1 - ON** - Enable threshold mode.

Examples

```
SENS:SA:DATA:THR:STAT 1
```

Query Syntax SENSe<ch>:SA:DATA:THReshold[:STATe]?

Return Type Boolean

Default 0

SENSe<ch>:SA:DATA:THReshold:VALue <num>

Applicable Models: All with Spectrum Analysis Options (S9x09xxA/B, S9x090A/B)

(Read-Write) Set and read the threshold value (dBm). For text file output with verbose mode, only the frequencies with power greater than this threshold setting will be written to the file. This command can be used as a kind of simple spurious search.

Parameters

- <ch> Any existing SA channel. If unspecified, value is set to 1.
- <num> Threshold setting in dBm.

Examples

```
SENS:SA:DATA:THR:VAL -5 dBm
```

Query Syntax SENSe<ch>:SA:DATA:THReshold:VALue?

Return Type Real

Default -60 dBm

SENSe<ch>:SA:DATA:TYPE <enum>

Applicable Models: All with Spectrum Analysis Options (S9x09xxA/B, S9x090A/B)

(Read-Write) Set and read the data format.

Parameters

- <ch> Any existing SA channel. If unspecified, value is set to 1.
- <enum> Choose from:

MAGDb : Set data format to log magnitude in dBm.

AMPVolt : Set data format to linear magnitude in volts.

PINT : Set data format to Packed Integers: a more compact (2 bytes) numeric representation for dBm. Each set of 2 bytes is a short number s, to get the dBm value compute (s/200.0 -36.165).

Examples

```
SENS:SA:DATA:TYPE MAGDB
```

Query Syntax SENSE<ch>:SA:DATA:TYPE?

Return Type Enumeration

Default MAGDB

SENSe<ch>:SA:DATA:WFACTor?

Applicable Models: All with Spectrum Analysis Options (S9x09xxA/B, S9x090A/B)

(Read-only) Read the windowing factor for band power computation. This factor is derived from the window type (Gaussian, flat top, etc.). When doing the sum of linear power over a band, use this factor to compensate the side lobe effect of windowing to get an accurate band power value.

Parameters

- <ch> Any existing SA channel. If unspecified, value is set to 1.

Examples

```
SENS:SA:DATA:WFACTor?
```

Return Type Real

Default Not applicable

SENSe:SA:DETEctor:BYPass:[STATe] <bool>

Applicable Models: All with Spectrum Analysis Options (S9x09xxA/B, S9x090A/B)

(Read-Write) Set and read the ON/OFF state of the detector bypass setting.

Parameters

- <ch> Any existing SA channel. If unspecified, value is set to 1.
 - <bool> Choose from:
 - 0 - OFF** - Detector bypass OFF.
 - 1 - ON** - Detector bypass ON.
- Learn about these settings .

Examples

```
SENS:SA:DET:BYP 0
```

Query Syntax SENSE<ch>:SA:DETECTOR:BYPass:[STATE]?

Return Type Boolean

Default 0

```
SENSe<ch>:SA:DETECTOR:FUNCTION <enum>
```

Applicable Models: All with Spectrum Analysis Options (S9x09xxA/B, S9x090A/B)

(Read-Write) Set and read the detector type.

Parameters

- <ch> Any existing SA channel. If unspecified, value is set to 1.
- <enum> Choose from:
 - PEAK**
 - AVERAge**
 - SAMPlE**
 - NORMal**
 - NEGPeak**
 - PSAMPlE** (Peak Sample)
 - PAVERage** (Peak Average)

Learn about these settings.

Examples	<code>SENS:SA:DET:FUNC AVER</code>
Query Syntax	<code>SENSe<ch>:SA:DETECTOR:FUNCTION?</code>
Return Type	Enumeration
Default	PEAK

`SENSe<ch>:SA:DFT:BANDwidth:AUTO <bool>`

Applicable Models: All with Spectrum Analysis Options (S9x09xxA/B, S9x090A/B)

(Read-Write) Set and read the default values for DFT bandwidth.

Parameters

- <ch> Any existing SA channel. If unspecified, value is set to 1.
- <bool> Choose from:
 - 0 - OFF** -DFT minimum and maximum values are set manually:
 - Narrow** - 500 kHz to 11 MHz
 - Wide** - 500 kHz to 44 MHz
 - 1 - ON** - DFT minimum and maximum values are set to their default values:
 - Narrow** - 1 MHz to 10 MHz
 - Wide** - 1 MHz to 34 MHz

Examples	<code>SENS:SA:DFT:BAND:AUTO 0</code>
Query Syntax	<code>SENSe<ch>:SA:DFT:BANDwidth:AUTO?</code>
Return Type	Boolean
Default	1

`SENSe<ch>:SA:DFT:BANDwidth:NARRow:MAX <num>`

Applicable Models: All with Spectrum Analysis Options (S9x09xxA/B, S9x090A/B) (Except M98x0A, P50xxA)

(Read-Write) Set and read the maximum value for narrow DFT bandwidth. The maximum narrow DFT bandwidth setting is 11 MHz. The SENSE:SA:DFT:BANDwidth:AUTO must be set to OFF to set this value manually.

Parameters

<ch> Any existing SA channel. If unspecified, value is set to 1.

<num> Max narrow DFT bandwidth.

Examples `SENS:SA:DFT:BAND:NARR:MAX 11e6`

Query Syntax SENSE<ch>:SA:DFT:BANDwidth:NARRow:MAX?

Return Type Double

Default 10e6

`SENSe<ch>:SA:DFT:BANDwidth:NARRow:MIN <num>`

Applicable Models: All with Spectrum Analysis Options (S9x09xxA/B, S9x090A/B) (Except M98x0A, P50xxA)

(Read-Write) Set and read the minimum value for narrow DFT bandwidth. The minimum narrow DFT bandwidth setting is 500 kHz. The SENSE:SA:DFT:BANDwidth:AUTO must be set to OFF to set this value manually.

Parameters

<ch> Any existing SA channel. If unspecified, value is set to 1.

<num> Minimum narrow DFT bandwidth.

Examples `SENS:SA:DFT:BAND:NARR:MIN 5e5`

Query Syntax SENSe<ch>:SA:DFT:BANDwidth:NARRow:MIN?

Return Type Double

Default 1e6

`SENSe<ch>:SA:DFT:BANDwidth:WIDE:MAX <num>`

Applicable Models: All with Spectrum Analysis Options (S9x09xxA/B, S9x090A/B)

(Read-Write) Set and read the maximum value for wide DFT bandwidth. The maximum wide DFT bandwidth setting is 44 MHz. The SENSE:SA:DFT:BANDwidth:AUTO must be set to OFF to set this value manually.

Parameters

- <ch> Any existing SA channel. If unspecified, value is set to 1.
- <num> Max wide DFT bandwidth.

Examples SENS:SA:DFT:BAND:WIDE:MAX 44e6

Query Syntax SENSE<ch>:SA:DFT:BANDwidth:WIDE:MAX?

Return Type Double

Default 34e6

SENSe<ch>:SA:DFT:BANDwidth:WIDE:MIN <num>

Applicable Models: All with Spectrum Analysis Options (S9x09xxA/B, S9x090A/B)

(Read-Write) Set and read the minimum value for wide DFT bandwidth. The minimum wide DFT bandwidth setting is 500 kHz. The SENSE:SA:DFT:BANDwidth:AUTO must be set to OFF to set this value manually.

Parameters

- <ch> Any existing SA channel. If unspecified, value is set to 1.
- <num> Minimum wide DFT bandwidth.

Examples SENS:SA:DFT:BAND:WIDE:MIN 5e5

Query Syntax SENSE<ch>:SA:DFT:BANDwidth:WIDE:MIN?

Return Type Double

Default 1e6

SENSe<ch>:SA:DFT:RECORD:SIZE?

Applicable Models: All with Spectrum Analysis Options (S9x09xxA/B, S9x090A/B)

(Read-only) Read the current DFT record size. This value is based on the SENSE:SA:ADC:RECORD:SIZE:VALUE and SENSE:SA:DFT:TYPE settings.

Parameters

<ch> Any existing SA channel. If unspecified, value is set to 1.

Examples

```
SENS:SA:DFT:REC:SIZE?
```

Return Type Integer

Default Not applicable

SENSe<ch>:SA:DFT:RESolution?

Applicable Models: All with Spectrum Analysis Options (S9x09xxA/B, S9x090A/B)

(Read-only) Read the DFT resolution.

Parameters

<ch> Any existing SA channel. If unspecified, value is set to 1.

Examples

```
SENS:SA:DFT:RES?
```

Default Not applicable

SENSe<ch>:SA:DFT:TYPE <enum>

Applicable Models: All with Spectrum Analysis Options (S9x09xxA/B, S9x090A/B)

(Read-Write) Set and return the DFT record size type. The DFT SENSE:SA:DFT:RECORD:SIZE is based on the SENSE:SA:ADC:RECORD:SIZE:VALUE and the DFT record size type.

Parameters

<ch> Any existing SA channel. If unspecified, value is set to 1.

<enum> Choose from:

POW2 - Sets the DFT record size to the next power of 2 greater than or equal to the current ADC record size.

RADix - Sets the DFT to the nearest equal or larger integer that can be decomposed with 2, 3, 5, 7, 11, 13 radices.

ARbitrary - Sets DFT record size equal to the ADC record size. If the current ADC record size is a large prime number, then the DFT can be very slow.

FASTest - Sets the DFT record size as close as possible to the ADC record size (larger or equal) while optimizing processing speed.

Examples `SENS:SA:DFT:TYPE ARB`

Query Syntax `SENSe<ch>:SA:DFT:TYPE?`

Return Type Enumeration

Default RADix

Note: In previous releases the default was POW2.

`SENSe<ch>:SA:FFT:DITHer[:STATE] <bool>`

Applicable Models: All with Spectrum Analysis Options (S9x09xxA/B, S9x090A/B)

(Read-Write) Set and read the ON/OFF state of the FFT grid dither setting

Parameters

- `<ch>` Any existing SA channel. If unspecified, value is set to 1.
- `<bool>` Choose from:
 - 0 - OFF** - Dither OFF.
 - 1 - ON** - Dither ON.

Examples `SENS:SA:FFT:DITH ON`

Query Syntax `SENSe<ch>:SA:FFT:DITH?`

Return Type Boolean

Default 0

`SENSe<ch>:SA:FFT:RES?`

Applicable Models: All with Spectrum Analysis Options (S9x09xxA/B, S9x090A/B)

(Read-only) Read the FFT resolution.

Parameters

<ch> Any existing SA channel. If unspecified, value is set to 1.

Examples `SENS:SA:FFT:RES?`

Default Not applicable

`SENSe<ch>:SA:FREQuency:SPAN:BANDwidth[:RESolution]:RATio <value>`

Applicable Models: All with Spectrum Analysis Options (S9x09xxA/B, S9x090A/B)

(Read-Write) Set and read the Frequency Span / RBW ratio.

Parameters

<ch> Any existing SA channel. If unspecified, value is set to 1.

<value> Frequency Span / RBW ratio. Choose a value between 1 and 200e9.

Learn about these settings .

Examples `SENS:SA:FREQ:SPAN:BAND:RAT 100`

Query Syntax `SENSe<ch>:SA:FREQuency:SPAN:BANDwidth[:RESolution]:RATio ?`

Return Type Integer

Default 106

`SENSe<ch>:SA:FREQuency:TUNE:IMMEDIATE [sync]`

Applicable Models: All with Spectrum Analysis Options (S9x09xxA/B, S9x090A/B)

(Write-only) Auto tunes and zooms in on a signal within a SA sweep.

Parameters

<ch> Any existing SA channel. If unspecified, value is set to 1.

[sync] **SYNChronous** - blocks SCPI commands during auto tune process (default behavior). When no sync is specified, sync is set to SYNChronous.

Note: The auto tune feature can take seconds to process, so a timeout error is likely to occur when sending other commands/queries before the completion of the auto tune process.

ASYNchronous - does NOT block SCPI commands during auto tune process.

Note: The ASYNchronous mode provides a method to check/wait remotely for completion of the auto tune process while allowing other commands/queries to be sent.

Note: In ASYNchronous mode, *OPC? will freeze the instrument and should not be used. Instead, use *OPC and *ESR? to check for completion.

Examples

SENS : SA : FREQ : TUNE : IMM

Return Type Not applicable

Default SYNChronous

SENSe<ch>:SA:COHerence:MULTitone:DATA <enum>

Applicable Models: All with Spectrum Analysis Options (S9x09xxA/B, S9x090A/B) (Except M98x0A, P50xxA)

(Read-Write) Set and read the data display mode.

Parameters

- <ch> Any existing SA channel. If unspecified, value is set to 1.
- <enum> Choose from:

ALL: Legacy SA mode - all frequency points are displayed.

ZNTones: All the frequencies that are not on the multi-tone coherence grid are set to 200 dBm before being displayed. This setting only has an effect if the coherence multitone mode is enabled.

Examples

```
SENS : SA : COH : MULT : DATA ALL
```

Query Syntax SENSE<ch>:SA:COHerence:MULTitone:DATA?

Return Type Enum

Default ALL

SENSe<ch>:SA:COHerence:MULTitone:HREJect <num>

Applicable Models: All with Spectrum Analysis Options (S9x09xxA/B, S9x090A/B) (Except M98x0A, P50xxA)

(Read-Write) Set and read the number of test signal harmonics you want to be protected against. This adds constraints to the list of LOs used to cover the span.

Parameters

- <ch> Any existing SA channel. If unspecified, value is set to 1.
- <num> Number of test signal harmonics to be protected. The more this number is increased, the more constraints are added on the span LOs setting.

Examples

```
SENS : SA : COH : MULT : HREJ 0
```

Query Syntax SENSe<ch>:SA:COHerence:MULTitone:HREJect?

Return Type Integer

Default 0

SENSe<ch>:SA:COHerence:MULTitone:NYQReJect <num>

Applicable Models: All with Spectrum Analysis Options (S9x09xxA/B, S9x090A/B) (Except M98x0A, P50xxA)

(Read-Write) Sets and returns the Nyquist protection level. Avoids Nyquist images of the IF higher order signal to fall back on multitone frequencies. This setting can only be set > 1 if the tone spacing of the multitone is not an integer divider of 100 MHz.

Parameters

- <ch> Any existing SA channel. If unspecified, value is set to 1.
- <num> Nyquist protection level.

Examples `SENS:SA:COH:MULT:NYQR 2`

Query Syntax `SENSe<ch>:SA:COHerence:MULTitone:NYQReject?`

Return Type Integer

Default 0

SENSe<ch>:SA:COHerence:MULTitone:PERiod <num>

Applicable Models: All with Spectrum Analysis Options (S9x09xxA/B, S9x090A/B) (Except M98x0A, P50xxA)

(Read-Write) Set and read the test signal repetition rate (in seconds). This value is 1/SA:COH:MULT:SPAC.

Parameters

- <ch> Any existing SA channel. If unspecified, value is set to 1.
- <num> Test signal repetition rate (in seconds).

Examples `SENS:SA:COH:MULT:PER 1E6`

Query Syntax `SENSe<ch>:SA:COHerence:MULTitone:PERiod?`

Return Type Double

Default 1E6

SENSe<ch>:SA:COHerence:MULTitone:REFerence <num>

Applicable Models: All with Spectrum Analysis Options (S9x09xxA/B, S9x090A/B) (Except M98x0A, P50xxA)

(Read-Write) Set and read the multitone image rejection offset frequency. If the multitone grid does not start from 0 Hz, this command is used to set its offset. To make this more convenient, this command accepts as well the frequency of any tone of the multitone grid (Hz).

Parameters

- <ch> Any existing SA channel. If unspecified, value is set to 1.
- <num> Offset frequency (in Hz).

Examples `SENS:SA:COH:MULT:REF 0`

Query Syntax `SENSe<ch>:SA:COHerence:MULTitone:REFErence?`

Return Type Double

Default 0

`SENSe<ch>:SA:COHerence:MULTitone:SPACing <num>`

Applicable Models: All with Spectrum Analysis Options (S9x09xxA/B, S9x090A/B) (Except M98x0A, P50xxA)

(Read-Write) Set and read the tone spacing of the multitone signal (in Hz). This value is 1/SA:COH:MULT:PER.

Parameters

- <ch> Any existing SA channel. If unspecified, value is set to 1.
- <num> Frequency spacing of multitone signal (in Hz).

Examples `SENS:SA:COH:MULT:SPAC 1E6`

Query Syntax `SENSe<ch>:SA:COHerence:MULTitone:SPACing?`

Return Type Double

Default 1000000

`SENSe<ch>:SA:COHerence:MULTitone[:STATe] <bool>`

Applicable Models: All with Spectrum Analysis Options (S9x09xxA/B, S9x090A/B) (Except M98x0A, P50xxA)

(Read-Write) Enables/disables multitone image rejection. When enabled, the window type is set to No Window and the list of RBW possible values is recomputed according to the multitone spacing. When disabled, the window type is set back to what it was before enabling and the RBW list is also set to the previous setting.

Parameters

- <ch> Any existing SA channel. If unspecified, value is set to 1.
- <bool> **Choose from:**
 - 0 - OFF** - Multitone image rejection disabled.
 - 1 - ON** - Multitone image rejection enabled.

Examples

```
SENS:SA:COH:MULT 1
```

Query Syntax SENSE<ch>:SA:COHerence:MULTitone[:STATe]?

Return Type Boolean

Default OFF

```
SENSe<ch>:SA:COHerence:MULTitone:VALid?
```

Applicable Models: All with Spectrum Analysis Options (S9x09xxA/B, S9x090A/B) (Except M98x0A, P50xxA)

(Read-only) Read the current multitone settings and determine if they are valid or not.

Parameters

- <ch> Channel number of the measurement. If unspecified, value is set to 1.

Examples

```
SENS:SA:COH:MULT:VAL?
```

```
sense2:sa:coherence:multitone:valid?
```

Return Type Boolean (ON, OFF, 1, 0) A "1" is valid and a "0" is invalid.

Default Not applicable

```
SENSe<ch>:SA:IMAGe:REJect <enum>
```

Applicable Models: All with Spectrum Analysis Options (S9x09xxA/B, S9x090A/B)

(Read-Write) Set and read the image reject mode.

Parameters

- <ch> Any existing SA channel. If unspecified, value is set to 1.
- <enum> Choose from:
 - NHIGH
 - NLOW
 - MIN
 - NORMAL
 - BETTER
 - MAX

Learn about these settings.

Examples

```
SENS:SA:IMAG:REJ NLOW
```

Query Syntax SENSE<ch>:SA:IMAGe:REJect?

Return Type Enumeration

Default NORMAL

```
SENSe<ch>:SA:IMAGe:STRENgth <enum>
```

Applicable Models: All with Spectrum Analysis Options (S9x09xxA/B, S9x090A/B)

(Read-Write) Sets and returns the image rejection strength. During the image rejection process, several LO acquisitions overlap at the same RF frequency. As a result, different RF signal values can be returned. This command sets the acceptable power differences between LOs in determining actual signals.

Parameters

- <ch> Any existing SA channel. If unspecified, value is set to 1.
- <enum> Choose from:
 - WEAK:** 3 dB (approximate number, depends on RBW)
 - NORMAL:** 1 dB (approximate number, depends on RBW)
 - STRONG:** 0.5 dB (approximate number, depends on RBW)

Examples

```
SENS:SA:IMAG:STREN STRONG
```

Query Syntax SENSE<ch>:SA:IMAGe:STRENGth?

Return Type Enumeration

Default MEDium

```
SENSe<ch>:SA:LO:FREQ:FORCe <bool>
```

Applicable Models: All with Spectrum Analysis Options (S9x09xxA/B, S9x090A/B)

(Read-Write) Set and read enable force LO to frequency mode.

Parameters

- <ch> Any existing SA channel. If unspecified, value is set to 1.
 - <bool> Choose from:
 - 0 - OFF** - Force LO to frequency is disabled.
 - 1 - ON** - Manually set LO to specified frequency using SENSE:SA:LO:FREQ:VALue . Only applied if Image Reject is set to None, LO High or None, LO Low.
- Learn about these settings .

Examples

```
SENS:SA:LO:FREQ:FORC 1
```

Query Syntax SENSE<ch>:SA:LO:FREQ:FORC?
Return Type Boolean
Default 0

SENSE<ch>:SA:LO:FREQ:VALue <num>

Applicable Models: All with Spectrum Analysis Options (S9x09xxA/B, S9x090A/B)

(Read-Write) Set and read enable force LO to frequency.

Parameters

<ch> Any existing SA channel. If unspecified, value is set to 1.
<num> Frequency in Hz. Choose a value within the frequency range of the analyzer.

Learn about these settings .

Examples

```
SENS:SA:LO:FREQ:VAL 1e9
```

Query Syntax SENSE<ch>:SA:LO:FREQ:VAL?
Return Type Numeric
Default 1 GHz

SENSE<ch>:SA:LO:COUNt?

Applicable Models: All with Spectrum Analysis Options (S9x09xxA/B, S9x090A/B)

(Read-only) Returns the number of LO acquisitions determined by the **Image Reject** selection and the span.

Parameters

<ch> Channel number of the measurement. If unspecified, value is set to 1.

Examples

```
SENS:SA:LO:COUN?
```

```
sense2:sa:lo:count?
```

Default Not applicable

SENSE<ch>:SA:LO:RANDom[:STATe] <bool>

Applicable Models: All with Spectrum Analysis Options (S9x09xxA/B, S9x090A/B)

(Read-Write) Set and read the LO randomize state.

Parameters

- <ch> Any existing SA channel. If unspecified, value is set to 1.
- <char> Choose from:
 - 0 - OFF** - LO Randomize is set to OFF.
 - 1 - ON** - LO Randomize is set to ON.

Learn about these settings .

Examples

```
SENS:SA:LO:RAND 1
```

Query Syntax SENSE<ch>:SA:LO:RANDom[:STATE]?

Return Type Boolean

Default 1

```
SENSe<ch>:SA:SOURce:DC:SWEep:FIRst[:DIMension] <enum>
```

Applicable Models: All with Spectrum Analysis Options (S9x09xxA/B, S9x090A/B)

(Read-Write) Set and read the DC sweep order. The SA may be programmed to loop through a series of spectrum measurements at multiple RF source frequencies, multiple RF source powers, and multiple DC voltages. These settings determine whether the DC sources are swept before the RF power and frequencies are swept, or whether the DC sources are swept after the RF power and frequencies are swept.

Parameters

- <ch> Any existing SA channel. If unspecified, value is set to 1.
- <enum> DC sweep order. Choose from:
 - DC** - Sweep through each DC voltage step first then sweep through the next frequency.
 - RF** - Sweep through each frequency step first then sweep through the next DC voltage.

Learn about these settings

Examples

```
SENS:SA:SOUR:DC:SWE:FIR DC
```

Query Syntax SENSE<ch>:SA:SOUR:DC:SWEep:FIRst?
Return Type Enumeration
Default DC

SENSe<ch>:SA:SOURce:DC:SWEep:POINT <value>

Applicable Models: All with Spectrum Analysis Options (S9x09xxA/B, S9x090A/B)

(Read-Write) Set and read the number of steps the source will make across the specified source DC range. This setting is common to all sources.

Parameters

<ch> Any existing SA channel. If unspecified, value is set to 1.
<value> Point count. Choose an integer value of 1 or higher.

Learn about these settings

Examples

```
SENS:SA:SOUR:DC:SWE:POIN 100
```

Query Syntax SENSE<ch>:SA:SOUR:DC:SWEep:POINT?
Return Type Integer
Default 1

SENSe:SA:SOURce:DC:SWEep[:STATe] <bool>

Applicable Models: All with Spectrum Analysis Options (S9x09xxA/B, S9x090A/B)

(Read-Write) Set and read the ON/OFF state of the DC sources. If ON, the DC sources sweep between their start and stop voltages. If OFF, the DC sources are set to their start voltages.

Parameters

<ch> Any existing SA channel. If unspecified, value is set to 1.
<bool> Choose from:

0 - OFF - DC sweep OFF.

1 - ON - DC sweep ON.

Learn about these settings .

Examples

```
SENS:SA:SOUR:DC:SWE 1
```

Query Syntax SENSE<ch>:SA:SOURce:DC:SWEep[:STATe]?

Return Type Boolean

Default 0

SENSe<ch>:SA:SOURce<port>:FREQUENCY:CW <num>[,src]

Applicable Models: All with Spectrum Analysis Options (S9x09xxA/B, S9x090A/B)

(Read-Write) Set and read the source CW frequency.

Parameters

- <ch> Any existing SA channel. If unspecified, value is set to 1.
- <port> Source port number of the VNA. If unspecified, value is set to 1. To make settings for ports that are not simple numbers, use the [src] argument.
- <num> CW frequency in Hz. Choose a value within the frequency range of the analyzer.
- [,src] **String** . (NOT case sensitive). Source port. Optional. Use SOUR:CAT? to return a list of valid port names.

While this argument can be used to make settings for ALL ports, it is designed to access ports such as an external source , or one of the Source 2 outputs on the 2-port 2-source PNA-X model such as "Port 1 Src2". Otherwise, the <port> argument performs the same function. If both arguments are specified, [src] takes priority.

Examples

```
SENS:SA:SOUR:FREQ:CW 1e10  
sense2:sa:source:frequency:cw 1e9,"Port 1 Src2"
```

Query Syntax SENSE<ch>:SA:SOURce<port>:FREQUENCY:CW?

Return Type Numeric

Default Center frequency of the analyzer.

SENSe<ch>:SA:SOURce<port>:FREQUENCY:START <num>[,src]

Applicable Models: All with Spectrum Analysis Options (S9x09xxA/B, S9x090A/B)

(Read-Write) Set and read the source start frequency.

Parameters

- <ch> Any existing SA channel. If unspecified, value is set to 1.
- <port> Source port number of the VNA. If unspecified, value is set to 1. To make settings for ports that are not simple numbers, use the [src] argument.
- <num> Start frequency in Hz. Choose a value within the frequency range of the analyzer.
- [,src] **String** . (NOT case sensitive). Source port. Optional. Use SOUR:CAT? to return a list of valid port names.

While this argument can be used to make settings for ALL ports, it is designed to access ports such as an external source , or one of the Source 2 outputs on the 2-port 2-source PNA-X model such as "Port 1 Src2". Otherwise, the <port> argument performs the same function. If both arguments are specified, [src] takes priority.

Examples

```
SENS:SA:SOUR:FREQ:STAR 1e9  
sense2:sa:source:frequency:start 1e9,"Port 1 Src2"
```

Query Syntax SENSE<ch>:SA:SOURce<port>:FREQuency:STARt?

Return Type Numeric

Default Start frequency of the analyzer.

```
SENSe<ch>:SA:SOURce<port>:FREQuency:STOP <num>[,src]
```

Applicable Models: All with Spectrum Analysis Options (S9x09xxA/B, S9x090A/B)

(Read-Write) Set and read the source stop frequency.

Parameters

- <ch> Any existing SA channel. If unspecified, value is set to 1.
- <port> Source port number of the VNA. If unspecified, value is set to 1. To make settings for ports that are not simple numbers, use the [src] argument.
- <num> Stop frequency in Hz. Choose a value within the frequency range of the analyzer.
- [,src] **String** . (NOT case sensitive). Source port. Optional. Use SOUR:CAT? to return a list of valid port names.

While this argument can be used to make settings for ALL ports, it is designed to access ports such as an external source , or one of the Source 2 outputs on the 2-port 2-source PNA-X model such as "Port 1 Src2". Otherwise, the <port> argument performs the same function. If both arguments are specified, [src] takes priority.

Examples

```
SENS:SA:SOUR:FREQ:STOP 1e10  
sense2:sa:source:frequency:stop 1e9,"Port 1 Src2"
```

Query Syntax SENSE<ch>:SA:SOURce<port>:FREQuency:STOP?

Return Type Numeric

Default Stop frequency of the analyzer.

```
SENSe<ch>:SA:SOURce:POW:SWEep:POINt:COUNT <value>
```

Applicable Models: All with Spectrum Analysis Options (S9x09xxA/B, S9x090A/B)

(Read-Write) Set and read the number of steps the source will make across the specified source power range. This setting is common to all sources.

Parameters

- <ch> Any existing SA channel. If unspecified, value is set to 1.
- <value> Point count. Choose an integer value of 1 or higher.

Examples

```
SENS : SA : SOUR : POW : SWE : POIN : COUN 100
```

Query Syntax SENSE<ch>:SA:SOUR:POW:SWEep:POINT:COUNT?

Return Type Integer

Default 1

```
SENSe<ch>:SA:SOURce:POW:SWEep:REPeat:COUNT <value>
```

Applicable Models: All with Spectrum Analysis Options (S9x09xxA/B, S9x090A/B)

(Read-Write) Set and read the number of SA (receiver) sweeps for each Source Step. This setting is common to all sources.

Parameters

- <ch> Any existing SA channel. If unspecified, value is set to 1.
- <value> Repeat count. Choose an integer value of 1 or higher.

Examples

```
SENS : SA : SOUR : POW : SWE : REP : COUN 5
```

Query Syntax SENSE<ch>:SA:SOUR:POW:SWEep:REPeat:COUNT?

Return Type Integer

Default 1

```
SENSe<ch>:SA:SOURce<port>:POWER:STARt <dBm>[,src]
```

Applicable Models: All with Spectrum Analysis Options (S9x09xxA/B, S9x090A/B)

(Read-Write) Set and read the source start power level. This command applies to Power or LFPower sweep types.

Parameters

- <ch> Any existing SA channel. If unspecified, value is set to 1.
- <port> Source port number of the VNA. If unspecified, value is set to 1. To make settings for ports that are not simple numbers, use the [src] argument.
- <dBm> Start power level in dBm. Choose a value within the power range of the source.
- [,src] **String** . (NOT case sensitive). Source port. Optional. Use SOUR:CAT? to return a list of valid port names.

While this argument can be used to make settings for ALL ports, it is designed to access ports such as an external source , or one of the Source 2 outputs on the 2-port 2-source PNA-X model such as "Port 1 Src2". Otherwise, the <port> argument performs the same function. If both arguments are specified, [src] takes priority.

Examples

```
SENS : SA : SOUR : POW : STAR 0
```

Query Syntax SENSE<ch>:SA:SOURce<port>:POWer:START?

Return Type Numeric

Default Default of source

```
SENSe<ch>:SA:SOURce<port>:POWer:STOP <dBm>[,src]
```

Applicable Models: All with Spectrum Analysis Options (S9x09xxA/B, S9x090A/B)

(Read-Write) Set and read the source stop power level. This command applies to Power or LFPower sweep types.

Parameters

- <ch> Any existing SA channel. If unspecified, value is set to 1.
- <port> Source port number of the VNA. If unspecified, value is set to 1. To make settings for ports that are not simple numbers, use the [src] argument.
- <dBm> Stop power level in dBm. Choose a value within the power range of the source.
- [,src] **String** . (NOT case sensitive). Source port. Optional. Use SOUR:CAT? to return a list of valid port names.

While this argument can be used to make settings for ALL ports, it is designed to access ports such as an external source , or one of the Source 2 outputs on the 2-port 2-source PNA-X model such as "Port 1 Src2". Otherwise, the <port> argument performs the same function. If both arguments are specified, [src] takes priority.

Examples `SENS:SA:SOUR:POW:STOP -5`

Query Syntax `SENSE<ch>:SA:SOURce<port>:POWER:STOP?`

Return Type Numeric

Default Default of source

SENSE<ch>:SA:SOURce<port>:POWER[:VALue] <dBm>[,src]

Applicable Models: All with Spectrum Analysis Options (S9x09xxA/B, S9x090A/B)

(Read-Write) Set and read the source output power level. This command applies to CW or LINear sweep types.

Parameters

- <ch> Any existing SA channel. If unspecified, value is set to 1.
- <port> Source port number of the VNA. If unspecified, value is set to 1. To make settings for ports that are not simple numbers, use the [src] argument.
- <dBm> Source output power level in dBm. Choose a value within the power range of the source.
- [,src] **String** . (NOT case sensitive). Source port. Optional. Use SOUR:CAT? to return a list of valid port names.

While this argument can be used to make settings for ALL ports, it is designed to access ports such as an external source , or one of the Source 2 outputs on the 2-port 2-source PNA-X model such as "Port 1 Src2". Otherwise, the <port> argument performs the same function. If both arguments are specified, [src] takes priority.

Examples `SENS:SA:SOUR:POW -5`

Query Syntax `SENSE<ch>:SA:SOURce<port>:POWER?`

Return Type Numeric

Default Default of source

SENSe<ch>:SA:SOURce:SWEep:FIRst[:DIMension] <enum>

Applicable Models: All with Spectrum Analysis Options (S9x09xxA/B, S9x090A/B)

(Read-Write) Set and read the sweep order. This command applies whenever frequency and power are being swept (LFPower sweep type). Otherwise, this setting is ignored. For example, if all the active sources are set to CW and/or LINear sweep type, or if all the active sources are set to CW and/or POWer sweep type, the sweep order is ignored. If any active source is set to LFPower sweep type, or if an active source is set to LINear sweep type and another active source is set to POWer sweep type, then the sweep order setting will be used.

Parameters

- <ch> Any existing SA channel. If unspecified, value is set to 1.
- <enum> Sweep order. Choose from:
- FREQ** - Sweep from Start to Stop frequency first followed by a power sweep.
 - POWER** - Sweep power first then sweep from Start to Stop frequency.

Examples

```
SENS:SA:SOUR:SWE:FIR POW
```

Query Syntax SENSe<ch>:SA:SOUR:SWEep:FIRst?

Return Type Enumeration

Default FREQ

SENSe<ch>:SA:SOURce<port>:SWEep:POINT:COUNT <value>

Applicable Models: All with Spectrum Analysis Options (S9x09xxA/B, S9x090A/B)

(Read-Write) Set and read the number of steps the source will make across the specified source frequency range.

Parameters

- <ch> Any existing SA channel. If unspecified, value is set to 1.
- <port> Source port number of the VNA. If unspecified, value is set to 1. To make settings for ports that are not simple numbers, use the [src] argument.
- <value> Point count. Choose a value between 1 and 2e9.

Examples

```
SENS:SA:SOUR:SWE:POIN:COUN 100
```

Query Syntax SENSe<ch>:SA:SOUR:SWEep:POINT:COUNT?

Return Type Integer

Default 1

SENSe<ch>:SA:SOURce<port>:SWEep:REPeat:COUNT <value>

Applicable Models: All with Spectrum Analysis Options (S9x09xxA/B, S9x090A/B)

(Read-Write) Set and read the number of SA (receiver) sweeps for each Source Step. This setting is common to all sources.

Parameters

- <ch> Any existing SA channel. If unspecified, value is set to 1.
- <port> Source port number of the VNA. If unspecified, value is set to 1. To make settings for ports that are not simple numbers, use the [src] argument.
- <value> Repeat count. Choose a value between 1 and 2e9.

Examples

SENS:SA:SOUR:SWE:REP:COUN 5

Query Syntax SENSe<ch>:SA:SOUR:SWEep:REPeat:COUNT?

Return Type Integer

Default 1

SENSe<ch>:SA:SOURce<port>:SWEep:TYPE <enum>[,src]

Applicable Models: All with Spectrum Analysis Options (S9x09xxA/B, S9x090A/B)

(Read-Write) Set and read the source sweep type.

Parameters

- <ch> Any existing SA channel. If unspecified, value is set to 1.
- <port> Source port number of the VNA. If unspecified, value is set to 1. To make settings for ports that are not simple numbers, use the [src] argument.
- <enum> Sweep type. Choose from:
 - CW** - SA source is at a single frequency, set with SENS:SA:SOUR:FREQ:CW
 - LINear** - SA source sweeps from Start to Stop in linear steps.
 - POWer** - SA source is set to a power sweep.
 - LFPower** - SA source is set to sweep from the Start to Stop frequency and

power sweep. The order is determined by the SENS:SA:SOUR:SWEep:FIRst command.

[,src] **String** . (NOT case sensitive). Source port. Optional. Use SOUR:CAT? to return a list of valid port names.

While this argument can be used to make settings for ALL ports, it is designed to access ports such as an external source , or one of the Source 2 outputs on the 2-port 2-source PNA-X model such as "Port 1 Src2". Otherwise, the <port> argument performs the same function. If both arguments are specified, [src] takes priority.

Examples

```
SENS:SA:SOUR:SWE:TYPE CW
sense2:sa:source:sweep:type linear,"Port 1 Src2"
```

Query Syntax SENSE<ch>:SA:SOURce<port>:SWEep:TYPE?

Return Type Enumeration

Default CW

SENSe<ch>:SA:SPAN:BINS:COUNT?

Applicable Models: All with Spectrum Analysis Options (S9x09xxA/B, S9x090A/B)

(Read-only) Read the current span DFT bin count.

Parameters

<ch> Any existing SA channel. If unspecified, value is set to 1.

Examples

```
SENS:SA:SPAN:BINS:COUN?
```

Return Type Integer

Default Not applicable

SENSe<ch>:SA:TRACe:IMAGe[:STATe] <bool>

Applicable Models: All with Spectrum Analysis Options (S9x09xxA/B, S9x090A/B)

(Read-Write) Set and read the show / hide state of the image reject traces in the measurement parameters dialog.

Parameters

- <ch> Any existing SA channel. If unspecified, value is set to 1.
 - <bool> Choose from:
 - 0 - OFF** -Disable image reject traces.
 - 1 - ON** - Enable image reject traces and set mode using SENS:SA:IMAG:REJ .
- Learn about these settings .

Examples

```
SENS:SA:TRAC:IMAG ON
```

Query Syntax SENSE<ch>:SA:TRACe:IMAGe[:STATe]?

Return Type Boolean

Default 0

SENSe:SA:TRIGer:LEVel[:STATe] <bool>

Applicable Models: All with Spectrum Analysis Options (S9x09xxA/B, S9x090A/B) (Except M98x0A, P50xxA)

(Read-Write) Set and read the ON/OFF state of a measurement trigger event that will occur whenever the ADC level is greater than the value specified using the SENSE:SA:TRIGer:LEVel:VALue command.

Parameters

- <ch> Any existing SA channel. If unspecified, value is set to 1.
 - <bool> Choose from:
 - 0 - OFF** - ADC measurement trigger OFF.
 - 1 - ON** - ADC measurement trigger ON.
- Learn about these settings .

Examples

```
SENS:SA:TRIG:LEV 0
```

Query Syntax SENSE<ch>:SA:TRIGer:LEVel[:STATe]?

Return Type Boolean

Default 0

SENSe<ch>:SA:TRIGer:LEVel:VALue <value>

Applicable Models: All with Spectrum Analysis Options (S9x09xxA/B, S9x090A/B) (Except M98x0A, P50xxA)

(Read-Write) Set and read the ADC trigger level.

Parameters

- <ch> Any existing SA channel. If unspecified, value is set to 1.
- <value> Choose a value between 0 and 16383.

Learn about these settings .

Examples

```
SENS:SA:TRIG:LEV:VAL 10
```

Query Syntax SENSe<ch>:SA:TRIGer:LEVel:VALue?

Return Type Integer

Default 100

SENSe:SA:TRIGer:PERCounter[:STATe] <bool>

Applicable Models: All with Spectrum Analysis Options (S9x09xxA/B, S9x090A/B) (Except M98x0A, P50xxA)

(Read-Write) Set and read the ON/OFF state of a measurement trigger event based on the specified period set using the SENSe:SA:TRIGer:PERCounter:VALue command.

Parameters

- <ch> Any existing SA channel. If unspecified, value is set to 1.
- <bool> Choose from:

0 - OFF - Periodic counter OFF.

1 - ON - Periodic counter ON.

Learn about these settings .

Examples

```
SENS:SA:TRIG:PERC 0
```

Query Syntax	SENSe<ch>:SA:TRIGer:PERCounter[:STATe]?
Return Type	Boolean
Default	0

SENSe<ch>:SA:TRIGer:PERCounter:VALue <value>

Applicable Models: All with Spectrum Analysis Options (S9x09xxA/B, S9x090A/B) (Except M98x0A, P50xxA)

(Read-Write) Set and read the periodic counter value. This command initiates a measurement trigger event based on the specified period.

Parameters

<ch> Any existing SA channel. If unspecified, value is set to 1.
<value> Choose a value between 0 and 2147483647.

Learn about these settings .

Examples SENS:SA:TRIG:PERC:VAL 64

Query Syntax	SENSe<ch>:SA:TRIGer:PERCounter:VALue?
Return Type	Integer
Default	256

SENSe<ch>:SA:COHerence:VECTor:AVErAge[:STATe] <bool>

Applicable Models: All with Spectrum Analysis Options (S9x09xxA/B, S9x090A/B) (Except M98x0A, P50xxA)

(Read-Write) Set and read the ON/OFF state of the vector averaging.

Parameters

<ch> Any existing SA channel. If unspecified, value is set to 1.
<bool> Choose from:

0 - OFF - Vector averaging OFF.

1 - ON - Vector averaging ON.

Learn about these settings .

Examples SENS:SA:COH:VECT:AVER:STAT 1

Query Syntax SENSE<ch>:SA:COHerence:VECTor:AVERage:STATe?

Return Type Boolean

Default 0

SENSe<ch>:SA:COHerence:VECTor:AVERage:VALue <value>[,<enum>]

Applicable Models: All with Spectrum Analysis Options (S9x09xxA/B, S9x090A/B) (Except M98x0A, P50xxA)

(Read-Write) Set and read the vector averaging value. In addition, read the minimum and maximum values using MIN/MAX.

Parameters

<ch> Any existing SA channel. If unspecified, value is set to 1.
<value> Choose a value between 0 and 65536.

Learn about these settings .

<enum> **MIN** - Read the minimum value.
MAX - Read the maximum value.

Examples SENS:SA:COH:VECT:AVER:VAL 1

SENS:SA:COH:VECT:AVER:VAL MAX

SENS:SA:COH:VECT:AVER:VAL? MAX

Query Syntax SENSE<ch>:SA:COHerence:VECTor:AVERage:VALue?

Return Type Integer

Default 1 (no averaging)

Sense:Segment Commands

Defines the segment sweep settings.

Enable segment sweep with SENS:SWE:TYPE SEGMENT.

SENSe:Segment

| **ADD**

| **ARbitrary**

| **BWIDth**

| **PORT**

| **[:RESolution]**

| **CONTRol**

| **[RESolution]**

| **CONTRol**

| **COUNT**

| **DELeTe**

| **ALL**

| **FREQuency**

| **CENTer**

| **SPAN**

| **STARt**

| **STOP**

| **LIST**

| **POWer**

| **ATTenuation**

| **RECeiver**

| **CONTRol**

| **REFerence**

| **TEST**

| [LEVel]
 | CONTrol
| SA
 | DTHReshold
 | CONTrol
 | MTReference
 | CONTrol
 | MAX?
 | MIN?
 | VAVerage
 | CONTrol
 | VIDeobw
 | CONTrol
| SHLO
 | CONTrol
| SOURCE
 | RECeiver:GAIN
 | ALL
 | CONTrol
| [STATe]
| SWEep
 | DELay
 | CONTrol
 | DWELI
 | CONTrol
| GENeration
 | CONTrol
| POINts

TOTal?
TIME
CONTRol
TOTal?
X
SPACing

Click on a keyword to view the command details.

See Also

- Example: Upload and Download a Segment List
- Learn about Segment Sweep
- Synchronizing the Analyzer and Controller
- SCPI Command Tree

SENSe<cnum>:SEGMENT<snum>:ADD

Applicable Models: All

(Write-only) Adds a segment.

Parameters

- <cnum> Any existing channel number. If unspecified, value is set to 1
- <snum> Segment number to add. If unspecified, value is set to 1 . Segment numbers must be sequential. If a new number is added where one currently exists, the existing segment and those following are incremented by one.

Examples

Two Segments exist (1 and 2). The following command will add a new segment (1). The existing (1 and 2) will become (2 and 3) respectively .

```
SENS : SEG1 : ADD
sense2 : segment1 : add
```

Query Syntax

Not applicable. Use Sense:Segment:Count to determine the number of segments in a trace.

Default

Not Applicable

SENSe<cnum>:SEGMENT:ARBITrary <ON | OFF>

Applicable Models: All

(Read-Write) Enables you to setup a segment sweep with arbitrary frequencies. The start and stop frequencies of each segment can overlap other segments. Also, each segment can have a start frequency that is greater than its stop frequency which causes a reverse sweep over that segment. Learn more about Arbitrary Segment Sweep.

Parameters

- <num> Any existing channel number. If unspecified, value is set to 1.
- <ON | OFF> **ON** (or 1) - Allows the setup of arbitrary segment sweep.
OFF (or 0) - Prevents the setup of arbitrary segment sweep.

Examples

```
SENS:SEGM:ARB ON  
sense2:segment:arbitrary off
```

Query Syntax SENSE<num>:SEGMENT:ARbitrary?

Return Type Boolean (1 = ON, 0 = OFF)

Default OFF

SENSe<num>:SEGMENT<num>:BWIDth:PORT<pnum>[:RESolution] <num>

Applicable Models: All

(Read-Write) Specifies whether the IF Bandwidth resolution can be set independently for each segment for the selected port and channel.

Parameters

- <num> Any existing channel number. If unspecified, value is set to 1
- <num> Segment number to modify. Choose any existing segment number.
- <pnum> Individual port number of the source: Port 1 to Port 2/Port 4. If unspecified, value is set to 1.
- <num> IF Bandwidth of each segment in Hz. The list of valid IF Bandwidths is different depending on the VNA model. (Click to see the lists.) If an invalid number is specified, the analyzer will round up to the closest valid number.

Note : This command will accept **MIN** or **MAX** instead of a numeric parameter. See SCPI Syntax for more information.

Examples

```
SENS:SEGM:BWID:PORT1 1KHZ  
sense2:segment2:bandwidth:PORT2:resolution max
```

Query SENSE<cnum>:SEGMENT<snum>:BWIDTh \
Syntax BANDwidth:PORT<pnum>[:RESolution]?
Return Type Numeric
Default Varies with VNA model.

SENSE<cnum>:SEGMENT:BWIDTh | BWIDTh:PORT<pnum>[:RESolution]:CONTrol <bool>

Applicable Models: All

(Read-Write) Turns ON or OFF the individual (Port 1 to Port 2/Port 4) IF Bandwidth control in the segment sweep table.

Parameters

<cnum> Any existing channel number. If unspecified, value is set to 1
<pnum> Individual port number of the source: Port 1 to Port 2/Port 4. If unspecified, value is set to 1.
<bool> Specified the individual IFBW control, either ON or OFF.

ON or 1 - Turns ON the individual port IFBW control.

OFF or 0 - Turns OFF the individual port IFBW control.

Examples

```
SENS:SEGM:BWID:PORT1:CONT ON  
sense2:segment2:bandwidth:PORT2:resolution:control off
```

Query Syntax SENSE<cnum>:SEGMENT<snum>:BWIDTh | BANDwidth:PORT<pnum>[:RESolution]:CONTrol?

Return Type Boolean

Default OFF or 0

SENSE<cnum>:SEGMENT<snum>:BWIDTh[:RESolution] <num>

Applicable Models: All

(Read-Write) Sets the IF Bandwidth for the specified segment. First set SENS:SEGM:BWIDth:CONTRol ON. All subsequent segments that are added assume the new IF Bandwidth value.

Parameters

- <cnun> Any existing channel number. If unspecified, value is set to 1
- <snum> Segment number to modify. Choose any existing segment number.
- <num> IF Bandwidth in Hz. The list of valid IF Bandwidths is different depending on the VNA model. (Click to see the lists.) If an invalid number is specified, the analyzer will round up to the closest valid number.

Note : This command will accept **MIN** or **MAX** instead of a numeric parameter. See SCPI Syntax for more information.

Examples

```
SENS:SEGM:BWID 1KHZ
sense2:segment2:bwid:resolution max
```

Query Syntax SENSE<cnun>:SEGMent<snum>:BWIDth[:RESolution]?

Return Type Numeric

Default Varies with VNA model.

SENSe<cnun>:SEGMent:BWIDth[:RESolution]:CONTRol <ON | OFF>

Applicable Models: All

(Read-Write) Specifies whether the IF Bandwidth resolution can be set independently for each segment.

Parameters

- <cnun> Any existing channel number. If unspecified, value is set to 1
- <ON | OFF> **ON** (or 1) - turns Bandwidth control ON. Bandwidth can be independently set for each segment.
- OFF** (or 0) - turns Bandwidth control OFF. Use the channel IF bandwidth setting SENS:BWID .

Examples

```
SENS:SEGM:BWID:CONT ON
sense2:segment:bwid:control off
```

Query Syntax SENSE<cnun>:SEGMent:BWIDth[:RESolution]:CONTRol?

Return Type Boolean (1 = ON, 0 = OFF)

Default OFF

SENSe<cnum>:SEGMENT:COUNT?

Applicable Models: All

(Read-only) Queries the number of segments that exist in the specified channel.

Parameters

<cnum> Any existing channel number. If unspecified, value is set to 1

Examples

```
SENS:SEGM:COUNT?  
sense2:segment:count?
```

Return Type Numeric

Default 1 segment

SENSe<cnum>:SEGMENT<snum>:DELEte

Applicable Models: All

(Write-only) Deletes the specified sweep segment. When ALL segments are deleted, SENS:SWE:TYPE is automatically set to Linear because there are no segments to sweep.

<cnum> Any existing channel number. If unspecified, value is set to 1

<snum> Number of the segment to delete. If unspecified, value is set to 1

Examples

```
SENS:SEGM:DEL  
sense2:segment2:delete
```

Query Syntax Not applicable

Default Not Applicable

SENSe<cnum>:SEGMENT:DELEte:ALL

Applicable Models: All

(Write-only) Deletes all sweep segments. When this command is executed, SENS:SWE:TYPE is automatically set to Linear because there are no segments to sweep.

Parameters

<cnum> Any existing channel number. If unspecified, value is set to 1

Examples

```
SENS:SEGM:DEL:ALL
sense2:segment:delete:all
```

Query Syntax Not applicable

Default Not Applicable

SENSe<cnum>:SEGMENT<snum>:FREQUENCY:CENTer <num>

Applicable Models: All

(Read-Write) Sets the Center Frequency for the specified segment. The Frequency Span of the segment remains the same. The Start and Stop Frequencies change accordingly.

Note : All previous segment's Start and Stop Frequencies that are larger than the new Start Frequency are changed to the new Start Frequency. All following segment's start and stop frequencies that are smaller than the new Stop Frequency are changed to the new Stop Frequency.

Parameters

<cnum> Any existing channel number. If unspecified, value is set to 1

<snum> Segment number to modify. Choose any existing segment number.

<num> Center Frequency in Hz. Choose any number between the **minimum** and **maximum** frequency of the analyzer.

Note : This command will accept **MIN** or **MAX** instead of a numeric parameter. See SCPI Syntax for more information.

Examples

```
SENS:SEGM:FREQ:CENT 1MHZ
sense2:segment2:frequency:center 1e9
```

Query Syntax SENSE<cnum>:SEGMENT<snum>:FREQUENCY:CENTer?

Return Type Numeric

Default Stop Frequency of the previous segment. If first segment, start frequency of the analyzer.

SENSe<cnum>:SEGMent<snum>:FREQUency:SPAN <num>

Applicable Models: All

(Read-Write) Sets the Frequency Span for the specified segment. The center frequency of the segment remains the same. The start and stop frequencies change accordingly.

Note: All previous segment's Start and Stop Frequencies that are larger than the new Start Frequency are changed to the new Start Frequency. All following segment's start and stop frequencies that are smaller than the new Stop Frequency are changed to the new Stop Frequency.

Parameters

- <cnum> Any existing channel number. If unspecified, value is set to 1
- <snum> Segment number to modify. Choose any existing segment number.
- <num> Frequency Span in Hz. Choose any number between the **minimum** and **maximum** frequency of the analyzer.

Note : This command will accept **MIN** or **MAX** instead of a numeric parameter. See SCPI Syntax for more information.

Examples

```
SENS:SEGM:FREQ:SPAN 1MHZ  
sense2:segment2:frequency:span max
```

Query Syntax SENSe<cnum>:SEGMent<snum>:FREQUency:SPAN?

Return Type Numeric

Default If first segment, frequency span of the analyzer. Otherwise 0.

SENSe<cnum>:SEGMent<snum>:FREQUency:START <num>

Applicable Models: All

(Read-Write) Sets the Start Frequency for the specified sweep segment.

Notes

All other segment Start and Stop Frequency values that are larger than this frequency are changed to this frequency.

To return the start and stop frequency of the entire sweep (all segments), Use SENS:FREQ:START? and SENS:FREQ:STOP?

Parameters

- <cnum> Any existing channel number. If unspecified, value is set to 1
- <snum> Segment number to modify. Choose any existing segment number.

<num> Start Frequency in Hz. Choose any number between the **minimum** and **maximum** frequency of the analyzer.

Note : This command will accept **MIN** or **MAX** instead of a numeric parameter. See SCPI Syntax for more information.

Examples

```
SENS:SEGM:FREQ:STAR 1MHZ
sense2:segment2:frequency:start minimum
```

Query Syntax SENSE<cnum>:SEGMent<snum>:FREQUency:START?

Return Type Numeric

Default Stop Frequency of the previous segment. If first segment, start frequency of the analyzer.

SENSe<cnum>:SEGMent<snum>:FREQUency:STOP <num>

Applicable Models: All

(Read-Write) Sets the Stop Frequency for the specified sweep segment.

Notes

All other segment Start and Stop Frequency values that are larger than this frequency are changed to this frequency.

To return the start and stop frequency of the entire sweep (all segments), Use SENS:FREQ:START? and SENS:FREQ:STOP?

Parameters

<cnum> Any existing channel number. If unspecified, value is set to 1

<snum> Segment number to modify. Choose any existing segment number.

<num> Stop Frequency in Hz. Choose any number between the **minimum** and **maximum** frequency of the analyzer.

Note : This command will accept **MIN** or **MAX** instead of a numeric parameter. See SCPI Syntax for more information.

Examples

```
SENS:SEGM:FREQ:STOP 1MHZ
sense2:segment2:frequency:stop maximum
```

Query Syntax SENSE<cnum>:SEGMent<snum>:FREQUency:STOP?

Return Type Numeric

Default If first segment, stop frequency of the analyzer. Otherwise, start frequency of the segment.

SENSe<cnum>:SEGMENT:LIST <char>,<numSegs>,<data>

Applicable Models: All

(Read-Write) Reads or writes the entire list of values in the segment sweep table.

Note: For binary data transfer, specify 64-bit instead of 32-bit using FORMat[:DATA]. This is because higher frequencies used on VNA exceed the maximum value that can be represented by a 32-bit floating point number.

When sending/receiving this data as binary (FORMat[:DATA] REAL,64), use FORMat:BORDER to specify the correct 'endianness' (byte ordering) corresponding to your programming environment / computer platform.

Parameters

<cnum> Any existing channel number. If unspecified, value is set to 1

<char> Choose from:

SSTOP - Frequency values are Start and Stop for each segment.

CSPAN - Frequency values are Center and Span for each segment.

<numSegs> Total number of sweep segments being input. This allows the VNA to determine how many values per-each-segment are in the input <data> block.

<data> A list of segments specified using either a comma-separated string of data, or an array of double (real,64) depending on the state of FORM:DATA. Each segment is specified with a minimum of 4 and maximum of 7 values consecutively. The set of values that specify each segment should be in the following order :

1. Segment state (Boolean 1 for ON and 0 for OFF)
2. Number of Points in the segment
3. Start Freq (when <char> is SSTOP), or Center Freq (when <char> is CSPAN)
4. Stop Freq (when <char> is SSTOP), or Freq Span (when <char> is CSPAN)
5. IFBW (optional for the Write)
6. Dwell Time (optional for the Write)
7. Power (optional for the Write) - see below.

The first four data elements must always be supplied. After those values, data must be supplied for successive optional elements. For example, to set dwell time values, you must also supply IFBW values, because IFBW (#5) precedes dwell time (#6) in the array order.

The IF Bandwidth , Sweep Time and Source Power Control settings do NOT affect the order in which elements are interpreted.

The number of elements to supply for Power depends on the following two settings:

1. Source Power Option - ON allows segments to have independent power levels.
2. Couple Ports = Off allows different power levels for each test port.

CouplePorts	SourcePowerOption	Number of Elements
False	False	Each port has its own channel-wide power setting, which is set using SOURce:POWer[:LEVel] . Provide exactly 7 elements per segment. The last element (power) is ignored.
False	True	Provide 6 elements + total number of ports. The first 7 elements are still interpreted the same. The remaining elements (in-order) are interpreted as the power levels to set on that segment for Ports 2 through N, where N is the total number of ports currently enabled for the VNA or for a VNA with multiport external test set.
True	False	Provide exactly 7 elements per segment. The last element (power) is ignored.
True	True	Provide exactly 7 elements per segment. The last element (power) is honored.

Examples

`SENS:SEGM:LIST SSTOP,1,1,201,10E6,26.5E9,1E3,0,-10 1 segment,`

```
state ON, 201 points, 10 MHz to 26.5 GHz, 1kHz IFBW, 0 dwell  
time, -10 dBm (port powers coupled)
```

```
sense2:segment:list? cspan
```

See Upload and Download a Segment List example program

Query Syntax SENSE<cnum>:SEGMENT:LIST? [char].

If unspecified, char is set to SSTOP.

The number of data elements per segment returned will be 6 + total number of source ports, regardless of the IF Bandwidth, Sweep Time and Source Power Control settings. For the N5264B, which has no source ports, the query will return just 6 values per segment. For all other VNA models, the last elements in each segment correspond to the power level for each port.

Return Type Returns block data in the format specified by FORMAT[:DATA].

Default Not Applicable

SENSE<cnum>:SEGMENT:POWER:ATTENUATION:RECEIVER:CONTROL <bool>

Applicable Models: N522xB, N523xB, N524xB, M9485A

(Read-Write) Turns ON or OFF the individual receiver attenuator control in the segment sweep table.

Parameters

<cnum> Any existing channel number. If unspecified, value is set to 1.

<bool> **ON or 1** - Turns ON the individual receiver attenuator control.

OFF or 0 - Turns OFF the individual receiver attenuator control

Examples

```
SENS:SEGM:POW:ATT:REC:REC:CONT ON
```

```
sense:segment:power:attenuation:receiver:control 1
```

Query Syntax SENSE<cnum>:SEGMENT:POWER:ATTENUATION:RECEIVER:CONTROL?

Return Type Boolean. If querying for the standard (M9376A) port, the return value is 0

Default OFF or 0

SENSE<cnum>:SEGMENT<snum>:POWER<port>:ATTENUATION:RECEIVER:REFERENCE <num>

Applicable Models: N522xB, N523xB, N524xB, M9485A

(Read-Write) Sets the attenuation level for the specified reference attenuator for each segment.

Parameters

- <cnum> Any existing channel number. If unspecified, value is set to 1.
- <snum> Segment number to modify. Choose any existing segment number. If unspecified, value is set to 1.
- <port> Port number of the VNA. If unspecified, value is set to 1.
- <num> Attenuation value in dB. 0dB or 35dB.

If a number other than these is entered, the analyzer will select the next lower valid value. For example, if 19dB is entered, then 0dB attenuation will be selected.

Examples

```
SENS:SEGM:POW2:ATT:REC:REF 0
sense:segment:power:attenuation:receiver:reference 35
```

Query Syntax SENSE<cnum>:SEGMENT<snum>:POWER<port>:ATTENUATION:RECEIVER:REFERENCE

Return Type Numeric. If querying for the standard port, the return value is 0

Default 35

SENSe<cnum>:SEGMENT<snum>:POWER<port>:ATTENUATION:RECEIVER:TEST <num>

Applicable Models: N522xB, N523xB, N524xB, M9485A

(Read-Write) Sets the attenuation level for the specified test attenuator for each segment.

Parameters

- <cnum> Any existing channel number. If unspecified, value is set to 1.
- <snum> Segment number to modify. Choose any existing segment number. If unspecified, value is set to 1.
- <port> Port number of the VNA. If unspecified, value is set to 1.
- <num> Attenuation value in dB. 0dB or 35dB.

If a number other than these is entered, the analyzer will select the next lower valid value. For example, if 19dB is entered, then 0dB attenuation will be selected.

Examples

```
SENS:SEGM:POW2:ATT:REC:TEST 0
sense:segment:power:attenuation:receiver:test 35
```

Query Syntax SENSE<cnum>:SEGMENT<snum>:POWER<port>:ATTenuation:RECEiver:TEST?

Return Type Numeric. If querying for the standard port, the return value is 0

Default 35

SENSE<cnum>:SEGMENT<snum>:POWER[<port>][:LEVEL] <num>

Applicable Models: All

(Read-Write) Sets the Port Power level for the specified sweep segment. First set SENS:SEGM:POW:CONTROL ON.

When port power is Coupled, setting port power for one port will apply port power for all source ports.

All subsequent segments that are added assume the new Power Level value.

Parameters

- <cnum> Any existing channel number. If unspecified, value is set to 1
- <snum> Segment number to modify. Choose any existing segment number.
- <port> Port number of the source. If unspecified, value is set to 1.
- <num> Power level.

Note: The range of settable power values depends on the VNA model and if source attenuators are installed. To determine the range of values, send SOUR:POW? MAX and SOUR:POW? MIN. (SOUR:POW:ATT:AUTO must be set to ON).

Actual achievable leveled power depends on frequency.

Examples

```
SENS:SEGM:POW 0
sense2:segment2:power1:level -10
```

Query Syntax SENSE<cnum>:SEGMENT<snum>:POWER[<port>][:LEVEL]?

Return Type Numeric

Default 0

SENSE<cnum>:SEGMENT:POWER[:LEVEL]:CONTROL <ON | OFF>

Applicable Models: All

(Read-Write) Specifies whether Power Level can be set independently for each segment.

Parameters

- <num> Any existing channel number. If unspecified, value is set to 1
- <ON | OFF> **ON** (or 1) - turns Power Level control ON. Power level can be set for each segment.
OFF (or 0) - turns Power Level control OFF. Use the channel power level setting.

Examples

```
SENS:SEGM:POW:CONT ON  
sense2:segment:power:level:control off
```

Query Syntax SENSE<num>:SEGMent:POWer[:LEVel]:CONTrol?

Return Type Boolean (1 = ON, 0 = OFF)

Default OFF

SENSE<num>:SEGMent<snum>:SA:DTHReshold <num>

Applicable Models: All

(Read-Write) Sets or returns the SA data threshold for the segment.

Parameters

- <num> Any existing channel number. If unspecified, value is set to 1
- <snum> Segment number to modify. Choose any existing segment number.
- <num> Data threshold (in dBm).

Examples

```
SENS:SEGM:SA:DTHR -60  
sense2:segment2:sa:dthreshold -60
```

Query Syntax SENSE<num>:SEGMent<snum>:SA:DTHReshold?

Return Type Numeric

Default -60 dBm

SENSE<num>:SEGMent<snum>:SA:DTHReshold:CONTrol <ON | OFF>

Applicable Models: All

(Read-Write) Specifies whether SA Data Threshold can be set independently for each segment.

Parameters

- <cnm> Any existing channel number. If unspecified, value is set to 1
- <snum> Segment number to modify. Choose any existing segment number.
- <ON | OFF> **ON** (or 1) - turns SA Data Threshold control ON.
OFF (or 0) - turns SA Data Threshold control OFF.

Examples

```
SENS:SEGM:SA:DTHR:CONT ON  
sense2:segment:sa:dthreshold:control off
```

Query Syntax SENSE<cnm>:SEGMent<snum>:SA:DTHReshold:CONTrol?

Return Type Boolean (1 = ON, 0 = OFF)

Default OFF

SENSE<cnm>:SEGMent<snum>:SA:MTReference <num>

Applicable Models: All

(Read-Write) Sets or returns the SA multitone reference for the segment.

Parameters

- <cnm> Any existing channel number. If unspecified, value is set to 1
- <snum> Segment number to modify. Choose any existing segment number.
- <num> Multitone reference (in dBm).

Examples

```
SENS:SEGM:SA:MTR 0  
sense2:segment2:sa:mtreference 0
```

Query Syntax SENSE<cnm>:SEGMent<snum>:SA:MTReference?

Return Type Numeric

Default 0

SENSE<cnm>:SEGMent<snum>:SA:MTReference:CONTrol <ON | OFF>

Applicable Models: All

(Read-Write) Specifies whether SA Reference Tone can be set independently for each segment.

Parameters

- <cnm> Any existing channel number. If unspecified, value is set to 1
- <snum> Segment number to modify. Choose any existing segment number.
- <ON | OFF> **ON** (or 1) - turns SA Reference Tone control ON.
OFF (or 0) - turns SA Reference Tone control OFF.

Examples

```
SENS:SEGM:SA:MTR:CONT ON  
sense2:segment:sa:mtreference:control off
```

Query Syntax SENSE<cnm>:SEGMent<snum>:SA:MTReference:CONTROL?

Return Type Boolean (1 = ON, 0 = OFF)

Default OFF

SENSe<cnm>:SEGMent<snum>:SA:MTReference:MAX?

Applicable Models: All

(Read-only) Queries the maximum value of the SA Reference Tone, which is the maximum frequency.

Parameters

- <cnm> Any existing channel number. If unspecified, value is set to 1
- <snum> Segment number to modify. Choose any existing segment number.

Examples

```
SENS:SEGM:SA:MTR:MAX?  
sense2:segment:sa:mtreference:max?
```

Return Type Numeric

Default Not Applicable

SENSe<cnm>:SEGMent<snum>:SA:MTReference:MIN?

Applicable Models: All

(Read-only) Queries the minimum value of the SA Reference Tone.

Parameters

- <cnm> Any existing channel number. If unspecified, value is set to 1
- <snum> Segment number to modify. Choose any existing segment number.

Examples

```
SENS:SEGM:SA:MTR:MIN?  
sense2:segment:sa:mtreference:min?
```

Return Type Numeric

Default 0

SENSe<cnm>:SEGMENT<snum>:SA:VAVerage <num>

Applicable Models: All

(Read-Write) Sets or returns the SA vector averaging points for the segment.

Parameters

- <cnm> Any existing channel number. If unspecified, value is set to 1
- <snum> Segment number to modify. Choose any existing segment number.
- <num> Vector average points.

Examples

```
SENS:SEGM:SA:VAV 10  
sense2:segment2:sa:vaverage 10
```

Query Syntax SENSe<cnm>:SEGMENT<snum>:SA:VAVerage?

Return Type Numeric

Default 1

SENSe<cnm>:SEGMENT<snum>:SA:VAVerage:CONTROL <ON | OFF>

Applicable Models: All

(Read-Write) Specifies whether SA Vector Averaging can be set independently for each segment.

Parameters

- <cnm> Any existing channel number. If unspecified, value is set to 1
- <snum> Segment number to modify. Choose any existing segment number.
- <ON | OFF> **ON** (or 1) - turns SA Vector Averaging control ON.
OFF (or 0) - turns SA Vector Averaging control OFF.

Examples

```
SENS:SEGM:SA:VAV:CONT ON  
sense2:segment:sa:vaverage:control off
```

Query Syntax SENSE<cnm>:SEGMent<snum>:SA:VAVerage:CONTrol?

Return Type Boolean (1 = ON, 0 = OFF)

Default OFF

SENSe<cnm>:SEGMent<snum>:SA:VIDeobw <num>

Applicable Models: All

(Read-Write) Sets or returns the SA video bandwidth for the segment.

Parameters

- <cnm> Any existing channel number. If unspecified, value is set to 1
- <snum> Segment number to modify. Choose any existing segment number.
- <num> Video bandwidth (in Hz).

Examples

```
SENS:SEGM:SA:VID 1E6  
sense2:segment2:sa:videobw 1e6
```

Query Syntax SENSE<cnm>:SEGMent<snum>:SA:VIDeobw?

Return Type Numeric

Default 1E6 Hz

SENSe<cnm>:SEGMent<snum>:SA:VIDeobw:CONTrol <ON | OFF>

Applicable Models: All

(Read-Write) Specifies whether SA Video Bandwidth can be set independently for each segment.

Parameters

- <cnum> Any existing channel number. If unspecified, value is set to 1
- <snum> Segment number to modify. Choose any existing segment number.
- <ON | OFF> **ON** (or 1) - turns SA Video Bandwidth control ON.
OFF (or 0) - turns SA Video Bandwidth control OFF.

Examples

```
SENS:SEGM:SA:VID:CONT ON  
sense2:segment:sa:videobw:control off
```

Query Syntax SENSE<cnum>:SEGMENT<snum>:SA:VIDEObw:CONTROL?

Return Type Boolean (1 = ON, 0 = OFF)

Default OFF

SENSe<cnum>:SEGMENT<snum>[:STATe] <ON | OFF>

Applicable Models: All

(Read-Write) Turns the specified sweep segment ON or OFF. At least ONE segment must be ON or Sweep Mode is automatically set to **Linear**.

Parameters

- <cnum> Any existing channel number. If unspecified, value is set to 1
- <snum> Segment number to be turned ON or OFF
- <ON | OFF> **ON** (or 1) - turns segment ON.
OFF (or 0) - turns segment OFF.

Examples

```
SENS:SEGM ON  
sense2:segment2:state off
```

Query Syntax SENSE<cnum>:SEGMENT<snum>[:STATe]?

Return Type Boolean (1 = ON, 0 = OFF)

Default OFF

SENSe<cnum>:SEGMENT<snum>:SHLO

Applicable Models: N522xB, N523xB, N524xB, E5080A

(Read-Write) Sets or returns the Shift LO state of each segment in the segment sweep table for the selected channel.

Notes: The SENS:SEGM:SHLO:CONT command must first be set to ON before using this command.

Parameters

<num> Any existing channel number. If unspecified, value is set to 1

<snm> Any existing segment number.

Examples

```
SENS:SEGM:SHLO  
sense2:segment2:shlo
```

Query Syntax SENSE<num>:SEGMent<snm>:SHLO?

Return Type Numeric

Default Not Applicable

SENSe<num>:SEGMent:<snm>:SOURce<sport>:RECEiver<rport>:GAIN[:VALue] <string>

Applicable Models: M980xA, P50xxA

(Read-Write) Sets the gain settings to a specified port on the specified sweep segment. SENS:SEGM:SOUR:REC:GAIN:CONT should be turned on when you use this. Use SENS:SOUR:REC:GAIN:CAT? to return a list of available gain states for the specified port.

Parameters

<num> Any existing channel number. If unspecified, value is set to 1

<snm> Segment number to modify. Choose any existing segment number. If unspecified, value is set to 1.

<sport> Source port number of the VNA. If unspecified, value is set to 1

<rport> Receiver port number of the VNA. If unspecified, value is set to 1

<string> Receiver gain state. Not case sensitive.

For M980xA, P50xxA choose from:

- Auto
- Low
- High

Examples

```
SENS:SEGM2:SOUR:REC:GAIN:CONT ON
```

```
SENSe:SEGM2:SOUR1:REC2:GAIN "Low" ' Low for S21 measurement in segment
2

sense:segment:source:receiver:control on
sense:segment:source2:receiver2:gain:value "High" ' High for S22
measurement in Segment 1
```

Query Syntax SENSe<cnum>:SEGMENT<snum>:SOURCE<sport>:RECEIVER<rport>:GAIN[:VALUE]

Syntax ?

Return Type String

Default Auto

SENSe<cnum>:SEGMENT:<snum>:SOURCE<sport>:RECEIVER<rport>:GAIN:ALL[:VALUE]
<string>

Applicable Models: M980xA, P50xxA

(Read-Write) Sets the gain settings to all ports on the specified sweep segment. SENS:SEGM:SOUR:REC:GAIN:CONT should be turned on when you use this. Use SENS:SOUR:REC:GAIN:CAT? to return a list of available gain states for the specified port.

Parameters

- <cnum> Any existing channel number. If unspecified, value is set to 1
- <snum> Segment number to modify. Choose any existing segment number. If unspecified, value is set to 1.
- <sport> This parameter is Ignored
- <rport> This parameter is Ignored
- <string> Receiver gain state. Not case sensitive.

For M980xA, P50xxA choose from:

- Auto
- Low
- High

Examples

```
SENS:SEGM2:SOUR:REC:GAIN:CONT ON
SENSe:SEGM2:SOUR:REC:GAIN:ALL "Low" ' Low for all measurements in Segment 2
```

```
sense:segment:source:receiver:control on
sense:segment:source2:receiver2:gain:all:value "High" ' High for all
measurements in Segment 1
```

Query SENSE<cnum>:SEGMENT<snum>:SOURCE<sport>:RECEIVER<rport>:GAIN:ALL[:VALUE
Syntax ?
Return String, "MIXED" is returned when the settings are not the same.
Type
Default Auto

SENSE<cnum>:SEGMENT<snum>:SOURCE<sport>:RECEIVER<rport>:GAIN:CONTROL <bool>

Applicable Models: M980xA, P50xxA

(Read-Write) Sets and read the status of the segment receiver gain setting function. This must be turned ON when SENS:SEGM:SOUR:REC:GAIN or SENS:SEGM:SOUR:REC:GAIN:ALL is used.

Parameters

- <cnum> Any existing channel number. If unspecified, value is set to 1
- <snum> This parameter is Ignored.
- <sport> This parameter is Ignored.
- <rport> This parameter is Ignored.
- <bool> ON or 1 - Turn the segment receiver gain setting function ON
OFF or 0 - Turn the segment receiver gain setting function OFF

Examples

```
SENS:SEGM2:SOUR:REC:GAIN:CONT ON
sense:segment:source:receiver:control on
```

Query SENSE<cnum>:SEGMENT<snum>:SOURCE<sport>:RECEIVER<rport>:GAIN:CONTROL
Syntax ?
Return Boolean
Type
Default OFF

SENSE<cnum>:SEGMENT<snum>:SHLO:CONTROL <bool>

Applicable Models: N522xB, N523xB, N524xB, E5080A

(Read-Write) Turns ON or OFF the individual Shift LO state control in the segment sweep table.

Parameters

- <cnum> Any existing channel number. If unspecified, value is set to 1
- <snum> Any existing segment number.
- <bool> **ON or 1** - Turns ON the individual Shift LO state control.
OFF or 0 - Turns OFF the individual Shift LO state control.

Examples

```
SENS:SEGM:SHLO:CONT ON  
sense2:segment2:shlo:control off
```

Query Syntax SENSE<cnum>:SEGMENT<snum>:SHLO:CONTROL?

Return Type Boolean

Default OFF or 0

SENSE<cnum>:SEGMENT<snum>:SWEep:DELay <num>

Applicable Models: All

(Read-Write) Sets or returns the sweep delay time of the specified sweep segment.

Notes: The SENS:SEGM:SWE:DEL:CONT command must first be set to ON before using this command.

Parameters

- <cnum> Any existing channel number. If unspecified, value is set to 1
- <snum> Any existing segment number.
- <num> Range of sweep delay time is between 0 to 1 and the resolution is 0.001.

Notes: If the specified variable is out of the allowable setup range, the minimum value (if the lower limit of the range is not reached) or the maximum value (if the upper limit of the range is exceeded) is set.

<unit> s (second)

Examples

```
SENS:SEGM:SWE:DEL  
sense2:segment2:sweep:delay
```

Query Syntax SENSE<cnum>:SEGMENT<snum>:SWEep:DELay?

Syntax

Return Type Numeric / Double precision floating point

Default 0

SENSe<cnum>:SEGMENT<snum>:SWEep:DELay:CONTRol <bool>

Applicable Models: All

(Read-Write) Turns ON or OFF the sweep delay time of the specified sweep segment.

Parameters

<cnum> Any existing channel number. If unspecified, value is set to 1

<snum> Any existing segment number.

<bool> **ON or 1** - Turns ON sweep delay time.
OFF or 0 - Turns OFF sweep delay time.

Examples

```
SENS:SEGM:SWE:DEL:CONT ON  
sense2:segment2:sweep:delay:control off
```

Query Syntax SENSe<cnum>:SEGMENT<snum>:SWEep:DELay:CONTRol?

Return Type Boolean

Default OFF or 0

SENSe<cnum>:SEGMENT<snum>:SWEep:DWELI <num>

Applicable Models: All

(Read-Write) Sets or returns the sweep dwell time of the specified sweep segment.

Notes: The SENS:SEGM:SWE:DWELI:CONT command must first be set to ON before using this command.

Parameters

<cnum> Any existing channel number. If unspecified, value is set to 1

<snum> Any existing segment number.

<num> Range of sweep dwell time

Notes: If the specified variable is out of the allowable setup range, the minimum value (if the lower limit of the range is not reached) or the maximum value (if the upper limit of the range is exceeded) is set.

<unit> s (second)

Examples

```
SENS:SEGM:SWE:DWEL  
sense2:segment2:sweep:dwell
```

Query SENSE<cnum>:SEGMENT<snum>:SWEep:DWELI?
Syntax
Return Type Numeric / Double precision floating point
Default 0

SENSe<cnum>:SEGMENT<snum>:SWEep:DWELI:CONTROL <bool>

Applicable Models: All

(Read-Write) Turns ON or OFF the sweep dwell time of the specified sweep segment.

Parameters

<cnum> Any existing channel number. If unspecified, value is set to 1

<snum> Any existing segment number.

<bool> **ON or 1** - Turns ON sweep dwell time.
OFF or 0 - Turns OFF sweep dwell time.

Examples

```
SENS:SEGM:SWE:DWEL:CONT ON  
sense2:segment2:sweep:dwell:control off
```

Query Syntax SENSE<cnum>:SEGMENT<snum>:SWEep:DWELI:CONTROL?

Return Type Boolean

Default OFF or 0

SENSe<cnum>:SEGMENT<snum>:SWEep:GENeration <char>

Applicable Models: All

(Read-Write) Sets or returns the sweep mode of the specified sweep segment.

Notes: The SENS:SEGM:SWE:GEN:CONT command must first be set to ON before using this command.

Parameters

<cnum> Any existing channel number. If unspecified, value is set to 1.

<snum> Any existing segment number.

<char> Select sweep mode from either of the following:

- **"AUTO": Sets the sweep mode to the swept mode.**
- **"STEPped": Sets the sweep mode to the stepped mode.**

Examples

```
SENS:SEGM:SWE:GEN AUTO  
sense2:segment2:sweep:generation stepped
```

Query Syntax SENSE<cnum>:SEGMent<snum>:SWEep:GENeration?

Return Type Character

Default "AUTO"

SENSe<cnum>:SEGMent<snum>:SWEep:GENeration:CONTrol <bool>

Applicable Models: All

(Read-Write) Turns ON or OFF the sweep mode of the specified sweep segment.

Parameters

<cnum> Any existing channel number. If unspecified, value is set to 1.

<snum> Any existing segment number.

<bool> **ON or 1** - Turn ON sweep mode.
OFF or 0 - Turn OFF sweep mode.

Examples

```
SENS:SEGM:SWE:GEN:CONT ON  
sense2:segment2:sweep:generation:control off
```

Query Syntax SENSE<cnum>:SEGMent<snum>:SWEep:GENeration:CONTrol?

Return Type Boolean

Default OFF or 0

SENSe<cnum>:SEGMENT<snum>:SWEep:POINTs <num>

Applicable Models: All

(Read-Write) Sets the number of data points for the specified sweep segment.

Parameters

- <cnum> Any existing channel number. If unspecified, value is set to 1
- <snum> Any existing segment number. If unspecified, value is set to 1
- <num> Number of points in the segment. The total number of points in all segments cannot exceed **20001**. A segment can have as few as 1 point.

Note : This command will accept **MIN** or **MAX** instead of a numeric parameter. See SCPI Syntax for more information.

Examples

```
SENS:SEGM:SWE:POIN 51  
sense2:segment2:sweep:points maximum
```

Query Syntax SENSe<cnum>:SEGMENT<snum>:SWEep:POINTs ?

Return Type Numeric

Default 21

SENSe<cnum>:SEGMENT<snum>:SWEep:POINTs:TOTal? <totalPoints>

Applicable Models: All

(Read-only) Queries the total point count from the active segments or from all segments.

Parameters

- <cnum> Any existing channel number. If unspecified, value is set to 1
- <snum> Any existing segment number.
- <totalPoints> Choose from:

ACTive - Returns the total point count of the active segments.

ALL - Returns the total point count of all segments.

Examples

```
SENS:SEGM:SWE:POIN:TOT? ACT  
sense2:segment:sweep:points:total? all
```

Return Type Numeric

Default 21

SENSe<cnum>:SEGMENT<snum>:SWEep:TIME <num>

Applicable Models: All

(Read-Write) Sets the time the analyzer takes to sweep the specified sweep segment.

Parameters

- <cnum> Any existing channel number. If unspecified, value is set to 1
- <snum> Any existing segment number.
- <num> Sweep time in seconds. Choose a number between **0** and **100**

Note : This command will accept **MIN** or **MAX** instead of a numeric parameter. See SCPI Syntax for more information.

Examples

```
SENS:SEGM:SWE:TIME 1ms  
sense2:segment2:sweep:time .001
```

Query Syntax SENSe<cnum>:SEGMENT<snum>:SWEep:TIME?

Return Type Numeric

Default Not Applicable

SENSe<cnum>:SEGMENT:SWEep:TIME:CONTROL <ON | OFF>

Applicable Models: All

(Read-Write) Specifies whether Sweep Time can be set independently for each sweep segment.

Parameters

- <cnum> Any existing channel number. If unspecified, value is set to 1
- <ON | OFF> **ON** (or 1) - turns Sweep Time control ON. Sweep Time can be set for each segment.
OFF (or 0) - turns Sweep Time control OFF. Uses the channel Sweep Time setting.

Examples

```
SENS:SEGM:SWE:TIME:CONT ON  
sense2:segment:sweep:time:control off
```

Query Syntax SENSe<cnum>:SEGMENT:SWEep:TIME:CONTROL?

Return Type Boolean (1 = ON, 0 = OFF)

Default OFF

SENSe<cnum>:SEGMENT<snum>:SWEep:TIME:TOTAL? <totalTime>

Applicable Models: All

(Read-only) Queries the total sweep time of the active segments or of all segments.

Parameters

<cnum> Any existing channel number. If unspecified, value is set to 1

<snum> Any existing segment number.

<totalTime> Choose from:

ACTive - Returns the total sweep time of the active segments.

ALL - Returns the total sweep time of all segments.

Examples

```
SENS:SEGM:SWE:TIME:TOT? ACT
sense2:segment:sweep:time:total? all
```

Return Type Numeric

Default 0

SENSe<cnum>:SEGMENT:X:SPACing <char>

Applicable Models: All

(Read-Write) Sets X-axis spacing ON or OFF

Parameters

<cnum> Any existing channel number. If unspecified, value is set to 1

<char> **LINear** - turns X-axis point spacing OFF

OBASe - turns X-axis point spacing ON

Examples

```
SENS:SEGM:X:SPACing LIN
sense2:segment:spacing obase
```

Query Syntax SENSe<cnum>:SEGMENT:X:SPACing?

Return Type Character

Default LINear

Sense:Source Command

```
SENSe:SOURce
  | RECeiver
    | GAIN
      | ALL[:VALUE]
        | CATalog
          | LIST
```

- [SCPI Command Tree](#)

SENSe<cnum>:SOURce<sport>:RECeiver<rport>:GAIN[:VALue] <string>

Applicable Models: M980xA, P50xxA, E5080B

(Read-Write) Sets the gain settings to a specified port. Use SENS:SOUR:REC:GAIN:CAT? to return a list of available gain states for the specified port.

Parameters

- <cnum> Any existing channel number. If unspecified, value is set to 1
- <sport> Source port number of the VNA. If unspecified, value is set to 1
- <rport> Receiver port number of the VNA. If unspecified, value is set to 1
- <string> Receiver gain state. Not case sensitive.

choose from:

- Auto
- Low
- High

Examples

```
SENSe:SOUR1:REC2:GAIN "Low" ' Low for S21 measurement
sense:source2:receiver2:gain:value "High" ' High for S22
measurement
```

Query Syntax SENSe<cnum>:SOURce<sport>:RECeiver<rport>:GAIN[:VALue]?

Return Type String

Default Auto

SENSe<cnum>:SOURce<sport>:RECEiver<rport>:GAIN:ALL[:VALue] <string>

Applicable Models: M980xA, P50xxA, E5080B

(Read-Write) Sets the gain settings to all ports. Use SENS:SOUR:REC:GAIN:CAT? to return a list of available gain states for the VNA.

Parameters

<cnum> Any existing channel number. If unspecified, value is set to 1

<sport> Ignored

<rport> Ignored

<string> Receiver gain state. Not case sensitive.

choose from:

- Auto
- Low
- High

Examples

```
SENSe:SOUR1:REC2:ALL:GAIN "Low" ' Low for all measurements  
sense:source2:receiver2:gain:all:value "High" ' High for all  
measurements
```

Query Syntax SENSe<cnum>:SOURce<sport>:RECEiver<rport>:GAIN:ALL[:VALue]?

Return Type String. "MIXED" is returned when the settings are not the same.

Default Auto

SENSe<cnum>:SOURce<sport>:RECEiver<rport>:GAIN:CATalog

Applicable Models: M980xA, P50xxA, E5080B

(Read only) Reads a list of valid state for the receiver gain on the specified port.

Parameters

- <cnun> Any existing channel number. If unspecified, value is set to 1
- <sport> Source port number of the VNA. If unspecified, value is set to 1
- <rport> Receiver port number of the VNA. If unspecified, value is set to 1

Examples

```
SENSe:SOUR1:REC2:GAIN:CAT?  
sense:source2:receiver2:gain:catalog?
```

Query Syntax SENSE<cnun>:SOURce<sport>:RECEiver<rport>:GAIN:CATalog?

Return Type String (Comma-separated list of strings.) ("Auto,Low,High" is returned.)

Default Auto

SENSe<cnun>:SOURce<sport>:RECEiver<rport>:GAIN:LIST?

Applicable Models: M980xA, P50xxA, E5080B

(Read only) Gets the data array for actual gain setting of each measurement points. High: 1, Low: 0. The number of returned data is the same as the NOP.

Parameters

- <cnun> Any existing channel number. If unspecified, value is set to 1
- <sport> Source port number of the VNA. If unspecified, value is set to 1
- <rport> Receiver port number of the VNA. If unspecified, value is set to 1

Examples

```
SENSe:SOUR1:REC2:GAIN:LIST?  
sense:source2:receiver2:gain:list?
```

Query Syntax SENSE<cnun>:SOURce<sport>:RECEiver<rport>:GAIN:LIST?

Return Type Data block

Default Not Applicable

Sense:Sweep Commands

Specifies the sweep functions of the analyzer.

SENSe:SWEEp:

BLOCKed

DWELI

| **AUTO**

| **SDELay**

GENeration

| **POINTsweep**

GROups

| **COUNT**

LFEXtension:STATe

MODE

POINTs

PULSe More commands

SLOCal

| **MAXimum**

| **STATe**

SPEed

SRCPort

STEP

TIME

| **AUTO**

TRIGger

| **DELAY**

| **MODE**

| **POINT**

TYPE

FACW

Click on a keyword to view the command details.

See Also

- [Example Programs](#)
- [Example Triggering the VNA using SCPI](#)
- [Learn about Sweeping](#)
- [Synchronizing the Analyzer and Controller](#)
- [SCPI Command Tree](#)

SENSe<cnum>:SWEep:BLOCKed?

Applicable Models: N522xB, N523xB, N524xB, M937xA, M9485A, P937xA

(Read-only) Reads whether the specified channel is currently 'blocked' from sweeping. Learn more about the [Mechanical Devices](#) dialog.

Parameters

<cnum> Any existing channel number. If unspecified, value is set to 1

Examples

```
SENS : SWE : BLOC?
```

```
sense2 : sweep : blocked?
```

Return Type Boolean

0 - No, the channel is NOT blocked.

1 - Yes, the channel is blocked.

Default N/A

SENSe<cnum>:SWEep:DWELI <num>

Applicable Models: All

(Read-Write) Sets the dwell time between each sweep point.

- Dwell time is **ONLY** available with SENSE:SWEep:GENeration set to **STEPped**; It is **Not** available in **ANALOG**.
- Sending dwell = 0 is the same as setting SENS:SWE:DWEL:AUTO **ON**. Sending a dwell time > 0 sets SENS:SWE:DWEL:AUTO **OFF**.

Parameters

<cnun> Any existing channel number. If unspecified, value is set to 1

<num> Dwell time in seconds.

This command will accept **MIN** or **MAX** instead of a numeric parameter. See [SCPI Syntax](#) for more information.

Examples

```
SENS:SWE:DWEL .1  
sense2:sweep:dwell min
```

Query Syntax SENSE<cnun>:SWEep:DWELI?

Return Type Numeric

Default 0 - (**Note:** dwell time set to 0 is the same as dwell:auto ON)

SENSe<cnun>:SWEep:DWELI:AUTO <ON | OFF>

Applicable Models: All

(Read-Write) Specifies whether or not to automatically calculate and set the minimum possible dwell time. Setting Auto **ON** has the same effect as setting dwell time to **0**.

Parameters

<cnun> Any existing channel number. If unspecified, value is set to 1

<ON | OFF> **ON** (or 1) - turns dwell ON.
OFF (or 0) - turns dwell OFF.

Examples

```
SENS:SWE:DWEL:AUTO ON  
sense2:sweep:dwell:auto off
```

Query Syntax SENSE<cnun>:SWEep:DWELI:AUTO?

Return Type Boolean (1 = ON, 0 = OFF)

Default ON

SENSe<cnum>:SWEep:DWELl:SDELay <num>

Applicable Models: All

(Read-Write) Specifies the time to wait just before acquisition begins for each sweep. This delay is in addition to **Dwell Time** and the following two External Trigger delays if enabled.

- **Trig:Delay** (global scope)
- **Sens:Swe:Trig:Delay** (channel scope)

Parameters

<cnum> Any existing channel number. If unspecified, value is set to 1

<num> Sweep delay in seconds.

This command will accept **MIN** or **MAX** instead of a numeric parameter. See **SCPI Syntax** for more information.

Examples

```
SENS:SWE:DWEL:SDEL .1  
sense2:sweep:dwel:sdelay .5
```

Query Syntax SENSe<cnum>:SWEep:DWELl:SDELay?

Return Type Numeric

Default 0

SENSe<cnum>:SWEep:GENERation <char>

Applicable Models: N522xB, N523xB, N524xB, M937xA, P937xA

(Read-Write) Sets sweep as Stepped or Analog.

Parameters

<cnum> Any existing channel number. If unspecified, value is set to 1

<char> Choose from:

STEPped - source frequency is CONSTANT during measurement of each displayed point. More accurate than ANALog. Dwell time can be set in this mode.

ANALog - source frequency is continuously RAMPING during measurement of each displayed point. Faster than STEPped. Sweep time (not dwell time) can be set in this mode.

Examples `SENS:SWE:GEN STEP`
`sense2:sweep:generation analog`

Query Syntax `SENSe<cnum>:SWEep:GENeration?`

Return Type Character

Default Analog

SENSe<cnum>:SWEep:GENeration:POINTsweep <bool>

Applicable Models: N522xB, N523xB, N524xB, M937xA, P937xA

(Read-Write) Turns ON and OFF point sweep mode. When enabled, the VNA measures both the forward and reverse parameters at each frequency point before stepping to the next frequency. [Learn more.](#)

Parameters

<cnum> Any existing channel number. If unspecified, value is set to 1

<char> Choose from:

ON or **(1)** - Enable point sweep mode.

OFF or **(0)** - Disable point sweep mode.

Examples `SENS:SWE:GEN:POIN 1`

`sense2:sweep:generation:pointsweep off`

Query Syntax `SENSe<cnum>:SWEep:GENeration:POINTsweep?`

Return Type Boolean

Default OFF

SENSe<cnum>:SWEep:GROups:COUNT <num>

Applicable Models: All

(Read-Write) Sets the trigger count (groups) for the specified channel. Set trigger mode to group after setting this count.

Parameters

- <cnm> Any existing channel number. If unspecified, value is set to 1
- <num> Count (groups) number. Choose any number between: **1** and **2e6** (1 is the same as single trigger)

Examples

```
SENS:SWE:GRO:COUN 10  
sense2:sweep:groups:count 50
```

Query Syntax SENSE<cnm>:SWEep:GROups:COUNT?

Return Type Numeric

Default 1

SENSe<cnm>:SWEep:LFEXtension:STATe <bool>

Applicable Models: N5222B, N5227B, N5242B, N5247B, N5290A, N5291A

(Read-Write) Turns ON or OFF low frequency extension for extending the range down to 1 kHz start frequency.

Parameters

- <cnm> Any existing channel number. If unspecified, value is set to 1
- <bool> Choose from:
 - ON or 1** - Turns ON low frequency extension.
 - OFF or 0** - Turns OFF low frequency extension.

Examples

```
SENS:SWE:LFEX:STAT ON  
sense2:sweep:lfextension:state off
```

Query Syntax SENSE<cnm>:SWEep:LFEXtension:STATe?

Return Type Boolean

Default OFF or 0

SENSe<cnm>:SWEep:MODE <char>

Applicable Models: All

(Read-Write) Sets the number of trigger signals the specified channel will ACCEPT.

See [Triggering the VNA Using SCPI](#).

Parameters

<num> Any existing channel number. If unspecified, value is set to 1

<char> Trigger mode. Choose from:

HOLD - channel will not trigger

CONTInuous - channel triggers indefinitely

GROups - channel accepts the number of triggers specified with the last **SENS:SWE:GRO:COUN** <num>. This is one of the VNA overlapped commands. [Learn more](#).

SINGle - channel accepts ONE trigger, then goes to HOLD.

Note: To perform simple, single-triggering, use **SINGle** which requires that **TRIG:SOURce** remain in the default (internal) setting.

Examples

```
SENS:SWE:MODE CONT  
sense2:sweep:mode hold
```

Query Syntax SENSE<num>:SWEep:MODE?

Return Type Character

Default CONTInuous

SENSe<num>:SWEep:POINts <num>

Applicable Models: All

(Read-Write) Sets the number of data points for the measurement.

Parameters

- <cnum> Any existing channel number. If unspecified, value is set to 1
- <num> Choose any number between 1 and the **VNA maximum number of points**.

This command will accept **MIN** or **MAX** instead of a numeric parameter. See **SCPI Syntax** for more information.

Examples

```
SENS:SWE:POIN 51
sense2:sweep:points max
```

Query Syntax SENSE<cnum>:SWEep:POINts?

Return Type Numeric

Default 201

SENSe<cnum>:SWEep:SLOCAl:MAXimum <num>

Applicable Models: N522xB, N523xB, N524xB, E5080, M9485A, M980xA, P50xA

(Read-Write) Sets the Shift LO maximum frequency for the selected channel.

Parameters

- <cnum> Any existing channel number. If unspecified, value is set to 1
- <num> Range of shift LO maximum frequency is 1.5E8 to Maximum frequency.

Examples

```
SENS:SWE:SCLOC:MAX 1.5E8
sense2:sweep:slocal:maximum 1.5E8
```

Query Syntax SENSE<cnum>:SWEep:SLOCAl:MAXimum?

Return Type Numeric / Double precision floating point

Default Maximum frequency

SENSe<cnum>:SWEep:SLOCAl:STATe <bool>

Applicable Models: N522xB, N523xB, N524xB, E5080, M9485A, M980xA, P50xA

(Read-Write) Turns ON or OFF the Shift LO mode for the selected channel.

Parameters

<num> Any existing channel number. If unspecified, value is set to 1

<bool> Select shift LO mode from either of the following:

ON or 1 - Turns ON the Shift LO mode.

OFF or 0 - Turns OFF the Shift LO mode.

Examples

```
SENS:SWE:SLOC:STAT ON
sense2:sweep:slocal:state off
```

Query Syntax SENSE<num>:SWEep:SLOCal:STATe?

Return Type Boolean

Default OFF or 0

SENSe<num>:SWEep:SRCPort <1 | 2> **Superseded**

Applicable Models: All but M9485A

This command is superseded. The **Calc:Par:Def:Ext** and **Calc:Par:Mod:Ext** can now optionally include the source port.

(Read-Write) Sets the source port when making non S-parameter measurements. Has no effect on S-parameter measurements.

Parameters

<num> Any existing channel number. If unspecified, value is set to 1

<1 | 2> **1** - Source power comes out Port 1

2 - Source power comes out Port 2

Examples

```
SENS:SWE:SRCP 1
sense2:sweep:srcport 2
```

Query Syntax SENSe<num>:SWEep:SRCPort?

Return Type Character

Default 1

SENSe<num>:SWEep:SPEed <char>

Applicable Models: All

(Read-Write) Sets and returns the state of Fast Sweep mode. [Learn more about Fast Sweep.](#)

Parameters

<cnum> Any existing channel number. If unspecified, value is set to 1

<char> Fast Sweep mode. Choose from:

FAST - turns Fast Sweep Mode ON

NORMAL - turns Fast Sweep Mode OFF (Normal Mode).

Examples

```
SENS:SWE:SPE NORM
sense2:sweep:speed fast
```

Query Syntax SENSE<cnum>:SWEep:SPEed?

Return Type Character

Default NORMAL

SENSe<cnum>:SWEep:STEP <num>

Applicable Models: All

(Read-Write) Sets the frequency step size across the selected frequency range. This effectively sets the number of data points. Available **ONLY** when **Sweep Type** = Linear.

Parameters

<cnum> Any existing channel number. If unspecified, value is set to 1

<num> Frequency step size in Hz. Select any value up to the frequency range of the analyzer.

Examples

```
SENS:SWE:STEP 1e6
sense2:sweep:step 1000000
```

Query Syntax SENSE<cnum>:SWEep:STEP?

Return Type Numeric

Default NA

SENSe<cnum>:SWEep:TIME <num>

Applicable Models: All

(Read-Write) Sets the time the analyzer takes to complete one sweep. If sweep time accuracy is critical, use ONLY the values that are attained using the up and down arrows next to the sweep time entry box. [See Sweep Time.](#)

Parameters

<cnm> Any existing channel number. If unspecified, value is set to 1

<num> Sweep time in seconds.

To select the fastest sweep speed, either send MIN as an argument to this command, or send SENS:SWE:TIME:AUTO 1.

This command will accept **MIN** or **MAX** instead of a numeric parameter. See [SCPI Syntax](#) for more information.

The MAX value will change based on point count, IFBW, and dwell time.

Examples

```
SENS:SWE:TIME 1ms
sense2:sweep:time .001
```

Query Syntax SENSE<cnm>:SWEep:TIME?

Return Type Numeric

Default NA

SENSe<cnm>:SWEep:TIME:AUTO <ON | OFF>

Applicable Models: All

(Read-Write) Turns the automatic sweep time function ON or OFF.

Parameters

<cnm> Any existing channel number. If unspecified, value is set to 1

<ON | OFF> **ON** (or 1) - turns the automatic sweep time ON.

OFF (or 0) - turns the automatic sweep time OFF.

Examples

```
SENS:SWE:TIME:AUTO
sense2:sweep:time:auto off
```

Query Syntax SENSE<cnm>:SWEep:TIME:AUTO?

Return Type Boolean (1 = ON, 0 = OFF)

Default ON

SENSe<cnum>:SWEep:TRIGger:DELay <num>

Applicable Models: All

(Read-Write) Sets and reads the trigger delay for all measurements in the specified CHANNEL. This delay is only applied while **TRIG:SOURce EXTeRnal** and **TRIG:SCOP CURRent**. After an external trigger is applied, the start of the sweep is delayed for the specified delay value plus any inherent latency.

To apply a trigger delay for all channels (Global), use **TRIG:DEL**

Parameters

<cnum> Any existing channel number. If unspecified, value is set to 1

<num> Trigger delay value in seconds. Range is from 0 to 3 seconds

Examples

```
SENS:SWE:TRIG:DELay .003
sense2:sweep:trigger:delay 1
```

Query Syntax SENSe<cnum>:SWEep:TRIGger:DELay?

Return Type Numeric

Default 0

SENSe<cnum>:SWEep:TRIGger:MODE <char>

Applicable Models: All

(Read-Write) Sets and reads the trigger mode for the specified channel. This determines what EACH signal will trigger. [Learn more.](#)

Note: Setting Point and Sweep mode forces **Trigger:SCOPE = CURRent**

Parameters

<cnum> Any existing channel number. If unspecified, value is set to 1

<char> Trigger mode. choose from:

- **CHANnel** - Each trigger signal causes **ALL traces** in that channel to be swept.
- **SWEep** - Each Manual or External trigger signal causes **ALL traces that share a source port** to be swept.
- **POINT** -- Each Manual or External trigger signal causes one data point to be measured.
- **TRACe** - Allowed ONLY when **SENS:SWE:GEN:POIN** is enabled. Each trigger signal causes two identical measurements to be triggered separately - one trigger

signal is required for each measurement. Other trigger mode settings cause two identical parameters to be measured simultaneously.

Examples `SENS:SWE:TRIG:MODE SWE`
`sense2:sweep:trigger:mode point`

Query Syntax `SENSe<cnm>:SWEep:TRIGger:MODE?`

Return Type Character

Default Channel

SENSe<cnm>:SWEep:TRIGger:POINT <ON | OFF> **Superseded**

Applicable Models: N522xB, N523xB, N524xB, M937xA, P937xA

This command is replaced with **SENS:SWE:TRIG:MODE POINT**

(Read-Write) Specifies whether the specified channel will measure one point for each trigger or all of the measurements in the channel. Setting any channel to POINT mode will automatically set the **TRIGger:SCOPE = CURRent**.

Parameters

<cnm> Any existing channel number. If unspecified, value is set to 1

<ON | OFF> **ON** (or 1) - Channel measures one data point per trigger.

OFF (or 0) - All measurements in the channel made per trigger.

Examples `SENS:SWE:TRIG:POIN ON`
`sense2:sweep:trigger:point off`

Query Syntax `SENSe<cnm>:SWEep:TRIGger:POINT?`

Return Type Boolean (1 = Point, 0 = Measurement)

Default 0 - Measurement

SENSe<cnm>:SWEep:TYPE <char>

Applicable Models: All

(Read-Write) Sets the type of analyzer sweep mode. First set sweep type, then set sweep parameters such as frequency or power settings.

See Also: [FCA Segment Sweep commands](#)

Parameters

<cnum> Any existing channel number. If unspecified, value is set to 1

<char> Choose from:

LINear | LOGarithmic | POWer | CW | SEGMENT

Note: SWEep TYPE cannot be set to SEGMENT if there are no segments turned ON. A segment is automatically turned ON when the analyzer is started.

Examples

```
SENS:SWE:TYPE LIN
sense2:sweep:type segment
```

Query Syntax SENSE<cnum>:SWEep:TYPE?

Return Type Character

Default LINear

SENSe<cnum>:SWEep:TYPE:FACW <num>

Applicable Models: N522xB, N524xB, M937xA, P937xA

(Read-Write) Enables Fast CW sweep and sets the number of data points for the channel. **Sweep Type** must already be set to CW and FIFO must already be enabled.

See Also

[FIFO commands](#)

Example program

N5264B Measurement Receiver

Parameters

<cnum> Any existing channel number. If unspecified, value is set to 1

<num> Number of data points to measure in Fast CW mode. This setting overwrites the standard number of points setting for the channel. The minimum value is 1. The maximum value is $2^{32} - 1 = 2,147,483,647$. The "-1" indicates infinite

point count (i.e., go forever). Any other value will produce invalid results.

If the data acquisition rate exceeds 400,000 points per second, the upper limit on the number of points is 11e6. The following are conditions that can cause the higher data rate:

- IFBW's \geq 1 MHz and internally triggered.
- fastCW sweeps that are externally triggered at a rate faster than 400,000 points per second.

Set to 0 to disable Fast CW.

Examples

```
SENS:SWE:TYPE:FACW 1e6  
sense2:sweep:type facw 1e3
```

Query Syntax SENSE<cnum>:SWEep:TYPE:FACW?

Return Type Numeric

Default 0 - Disabled

Sense Switch

When you use the M9485A and M937xA, you can control the M9161D switch through the VNA firmware. The following commands are available when the launcher includes the M9161D.

```
SENSe:SWITCh:M9161
| COUNT?
| MODUle
| :CHASsis
| :CONTRol[:STATe]
| :RESet:IMMediate
| :SLOT
| :SWITCh:PATH
```

Click on a keyword to view the command details.

SENSe<cnum>:SWITCh:M9161:COUNT?

Applicable Models: All PXIe VNAs

(Read-only) Returns the total number of M9161D switch modules that are connected to the VNA firmware.

Parameters

<cnum> Any existing channel number; if unspecified, value is set to 1. This command is common for all channels and the setting is ignored.

Examples

```
SENS:SWIT:M9161:COUN?
sense:switch:m9161:count
```

Return Type Numeric

Default Not applicable

SENSe<cnum>:SWITCh:M9161:MODUle<mod>:CHASsis?

Applicable Models: All PXIe VNAs

(Read Only) Returns the chassis number where the specified M9161D module is located.

Parameters

- <cnum> Any existing channel number; if unspecified, value is set to 1. This command is common for all channels and the setting is ignored.
- <mod> Module number of M9161D. The number starts from 1 for the left most module of M9161D.

Examples

```
SENS:SWIT:M9161:MOD1:CHAS?  
  
sense:SWITch:m9161:module2:chassis?
```

Return Type Numeric

Default Not applicable

```
SENSe<cnum>:SWITch:M9161:MODule<mod>:CONTrol[:STATe] <bool>
```

Applicable Models: All PXIe VNAs

(Read-Write) Sets and reads the status of M9161D control.

Parameters

- <cnum> Any existing channel number; if unspecified, value is set to 1.
- <mod> Module number of M9161D. The number starts from 1 for the leftmost module of M9161D.
- <bool> Module control state. Choose from:
 - 0** or **OFF** - Skips to control the M9161D at the specified channel.
 - 1** or **ON** - Enables to control the M9161D at the specified channel.

Examples

```
SENS:SWIT:M9161:MOD1:CONT ON  
  
sense2:SWITch:M9161:module2:control 0
```

Query Syntax SENSe<cnum>:SWITch:M9161:MODule<mod>:CONTrol[:STATe]?

Return Type Boolean

Default 1 or ON

```
SENSe<cnum>:SWITch:M9161:MODule<mod>:RESet:IMMediate
```

Applicable Models: All PXIe VNAs

(Write Only) Resets the switches in the specified module to "All Open" state immediately.

Parameters

- <cnum> Any existing channel number; if unspecified, value is set to 1. This command is common for all channels and the setting is ignored.
- <mod> Module number of M9161D. The number starts from 1 for the leftmost module of M9161D.

Examples

```
SENS:SWIT:M9161:MOD1:RES:IMM  
sense:SWITch:M9161:module2:reset:immediate
```

Query Syntax Not applicable

Return Type Not applicable

Default Not applicable

SENSe<cnum>:SWITch:M9161:MODule<mod>:SLOT?

Applicable Models: All PXIe VNAs

(Read Only) Reads the slot number where the specified M9161D is located.

Parameters

- <cnum> Any existing channel number; if unspecified, value is set to 1. This command is common for all channels and the setting is ignored.
- <mod> Module number of M9161D. The number starts from 1 for the leftmost module of M9161D.

Examples

```
SENS:SWIT:M9161:MOD1:SLOT?  
sense:SWITch:M9161:module2:slot?
```

Return Type Numeric

Default Not applicable

SENSe<cnum>:SWITch:M9161:MODule<mod>:SWITch:PATH <char>

Applicable Models: All PXIe VNAs

(Read-Write) Sets and reads the path for the M9161D switch

Parameters

- <num> Any existing channel number; if unspecified, value is set to 1.
- <mod> Module number of M9161D. The number starts from 1 for the left most module of M9161D.
- <char> Path. Choose from:
 - STATe1** to **STATe4** - State 1 to 4
 - NFSource** - NF source switch (NF measurement only)
 - NFLO** - NF LO switch (Option 720 only)
 - NFReceiver** - NF receiver switch (NF measurement only)

Examples

```
SENS:SWIT:M9161:MOD1:SWIT:PATH STAT1  
sense2:SWITch:M9161:module2:switch:path state4
```

Query Syntax SENSE<num>:SWITch:M9161:MODule<mod>:SWITch:PATH?

Return Type <char>

Default STATe1

X Values Command

SENSe<cnum>:X[:VALues]? - Superseded

Applicable Models: N522xB, N523xB, N524xB, M937xA, P937xA

Replaced with **CALC:X?**

(Read-only) Returns the stimulus values for the specified channel. If the channel is sweeping the source backwards, the values will be in descending order.

Note: To avoid frequency rounding errors, specify **FORM:DATA** <Real,64> or <ASCIi, 0>

Parameters

<cnum> Any existing channel number; if unspecified, value is set to 1.

Examples

```
SENS:X?  
sense2:x:values?
```

Return Type Depends on **FORM:DATA** command

Default Not applicable

Service Commands

Controls and queries settings related with Service.

SERVice: :LOGGing:CLEAR
--

SERVice:LOGGing:CLEAr

Applicable Models: E5080, M9485A, M980xA, P50xxA

(Write-only) Delete the service error log files stored in the modules and PC. See [Error Log](#).

Parameters

Examples

```
SERV:LOGG:CLE  
service:logging:clear
```

Return Type N/A

Default Not Applicable

Source Commands

Controls the power delivered to the DUT and turn pulse on and off with an external source.

SOURce:

CATalog?

DC - More commands

MODulation - More commands

PHASe - More commands

POWer

| **ALC:MODE**

| **CATalog?**

| **RECeiver - More commands**

| **ATTenuation**

| **AUTO**

| **RECeiver**

| **REFerence**

| **TEST**

| **CENTer**

| **CORRection - More commands**

| **COUPlE**

| **DETector**

| **[LEVe]**

| **[IMMediate][AMPLitude]**

| **SLOPe**

| **STATe**

| **MODE**

| **PORT**

| **STARt**

| **STOP**

| **SPAN**

| **STARt**

| **STOP**

PULSe

| **MODulator**

| **[:STATe]**

| **EXISts?**

TDR - More Commands

Click on a keyword to view the command details.

See Also

- [Example Programs](#)
 - [Learn about Power Settings](#)
 - [Synchronizing the Analyzer and Controller](#)
 - [SCPI Command Tree](#)
 - [Remotely Specifying a Source Port](#)
-

SOURce<cnum>:CATalog?

Applicable Models: All

(Read-only) Returns a list of valid port names that can be controlled. Some ports only have string names, NOT numbers. All commands that require a port argument have provisions for specifying either a port number OR a string name.

See also: [Remotely Specifying a Source Port](#).

Parameters

<cnum> Any existing channel number. If unspecified, value is set to 1

Examples

```
SOUR:CAT?  
source:catalog  
  
'Some PNA-X models return  
"Port 1,Port 2,Port 3,Port 4,Port 1 Src2"'
```

Return Type Comma-separated list of strings.

Default Not applicable

SOURce<cnum>:PORT:NUM? <string>

Applicable Models: N522xB, N523xB, N524xB

(Read-only) Returns a port number for a named source.

All source ports have string names: "Port 1", "Port 2", etc. All external sources have customized names.

To convert a string name to a port number use this query.

Parameters

<cnum> Any existing channel number. If unspecified, value is set to 1

<string> String names.

Examples

```
SOUR:PORT:NUM? "MVG"  
source:port:num "port 1"
```

Return Type String

Default Not Applicable

SOURce<cnum>:POWER<port>:ALC[:MODE] <char>, [src]

Applicable Models: N522xB, N523xB, N524xB, M9485A

(Read-Write) Sets and returns the ALC mode for the specified channel and port. Use **SOUR:POW:ALC:MODE:CAT?** to return a list of valid ALC modes for the VNA.

[Learn more about ALC mode.](#)

Parameters

<cnum> Any existing channel number. If unspecified, value is set to 1

<port> Source port number of the VNA. If unspecified, value is set to 1. To make settings for ports that are not simple numbers, use the [src] argument.

<char> ALC Mode.

For the PNA-X choose from:

- **INTERNAL** Standard ALC loop
- **OPENloop** No ALC loop

To set Leveling Mode to Receiver Leveling, use the [Receiver Leveling commands](#).

[src] **String**. (NOT case sensitive). Source port. Optional. Use **SOUR:CAT?** to return a list of valid port names.

While this argument can be used to make settings for ALL ports, it is designed to access ports such as an **external source**, true mode balanced port, or one of the Source 2 outputs on the 2-port 2-source PNA-X model such as "Port 1 Src2". Otherwise, the <port> argument performs the same function. If both arguments are specified, [src] takes priority.

Examples

```
SOUR:POW:ALC INT  
  
source2:power2:alc:mode openloop  
  
source:power:alc:mode openloop,"Port 1 Src2"
```

Query Syntax SOURce<cnum>:POWER<port>:ALC:MODE? [src]

Return Type Character

Default INTERNAL

SOURce<cnum>:POWER<port>:ALC[:MODE]:CATalog? [src]

Applicable Models: N522xB, N523xB, N524xB, M9485A

(Read-only) Returns a list of valid ALC modes for the specified channel and port number. Use the returned values to set **SOUR:POW:ALC:MODE**.

Parameters

<cnum> Any existing channel number. If unspecified, value is set to 1

<port> Source port number of the VNA. If unspecified, value is set to 1. To make settings for ports that are not simple numbers, use the [src] argument.

[src] **String**. (NOT case sensitive). Source port. Optional. Use **SOUR:CAT?** to return a list of valid port names.

While this argument can be used to make settings for ALL ports, it is designed to access ports such as an **external source**, true mode balanced port, or one of the Source 2 outputs on the 2-port 2-source PNA-X model such as "Port 1 Src2". Otherwise, the <port> argument performs the same function. If both arguments are specified, [src] takes priority.

Examples

```
SOUR:POW:ALC:CAT?  
  
source2:power2:alc:mode:catalog?  
  
source:power:alc:mode:catalog? "Port 1 Src2"
```

Return Type Comma-separated list of strings.

Default Not applicable

SOURce<cnum>:POWER<port>:ATTenuation <num>, [src]

Applicable Models: All

(Read-Write) Sets the attenuation level for the selected channel. Sending this command turns automatic attenuation control (SOUR:POW:ATT:AUTO) to OFF. If the ports are coupled, changing the attenuation on one port will also change the attenuation on all other ports. To turn port coupling OFF use **SOURce:POWER:COUPlE OFF**.

Note: Attenuation cannot be set with **Sweep Type** set to **Power**

See **Sens:Power:ATT** to change receiver attenuation.

Parameters

- <cnum> Any existing channel number. If unspecified, value is set to 1
- <port> Source port number of the VNA. If unspecified, value is set to 1. To make settings for ports that are not simple numbers, use the [src] argument.
- <num> Attenuation value. The range of settable values depends on the VNA model. To determine the valid settings, do one of the following:
 - See **VNA models and options** to see the range and step size for each model / option.
 - Perform a query using MAX, then MIN, as an argument. Example:
SOURce:POWER:ATT? Max However, this will not tell you the attenuation step size.

If an invalid attenuation setting is entered, the VNA will select the next lower valid value. For example, if 19 is entered, then for an E8361A, 10 dB attenuation will be selected.

Note: This command will accept **MIN** or **MAX** instead of a numeric parameter. See **SCPI Syntax** for more information.

[src] **String**. (NOT case sensitive). Source port. Optional. Use **SOUR:CAT?** to return a list of valid port names.

While this argument can be used to make settings for ALL ports, it is designed to access ports such as an **external source**, true mode balanced port, or one of the Source 2 outputs on the 2-port 2-source PNA-X model such as "Port 1 Src2". Otherwise, the <port> argument performs the same function. If both arguments are specified, [src] takes priority.

Examples

```
SOUR:POW:ATT 10

source2:power2:attenuation maximum

source:power:att 20, "Port 1 Src2"
```

Query Syntax SOURce<cnum>:POWer<port>:ATTenuation? [min/max] [src]
[min/max,src]

Return Type Numeric

Default 0

SOURce<cnum>:POWer<port>:ATTenuation:AUTO <bool>, [src]

Applicable Models: N522xB, N523xB, N524xB, M937xA, P937xA

(Read-Write) Turns automatic attenuation control ON or OFF. Setting an attenuation value (using SOURce:POWer:ATTenuation <num>) sets **AUTO OFF**.

Parameters

<cnum> Any existing channel number. If unspecified, value is set to 1.

<port> Source port number of the VNA. If unspecified, value is set to 1. To make settings for ports that are not simple numbers, use the [src] argument.

<bool> **ON** (or 1) - turns coupling ON. The analyzer automatically selects the appropriate attenuation level to meet the specified power level.

OFF (or 0) - turns coupling OFF. Attenuation level must be set using SOURce:POWer:ATTenuation <num>.

[src] **String**. (NOT case sensitive). Source port. Optional. Use **SOUR:CAT?** to return a list of valid port names.

While this argument can be used to make settings for ALL ports, it is designed to access ports such as an **external source**, true mode balanced port, or one of the Source 2 outputs on the 2-port 2-source PNA-X model such as "Port 1 Src2". Otherwise, the <port> argument performs the same function. If both arguments are specified, [src] takes priority.

Examples

```
SOUR:POW2:ATT:Auto On

source2:power:attenuation:auto off

sour:pow:att:auto 1, "Port 1 Src2"
```

Query Syntax SOURce<cnum>:POWer:ATTenuation:Auto? [src]

Return Type Boolean (1 = ON, 0 = OFF)

Default ON

SOURce<cnum>:POWER<port>:ATTenuation:RECEiver:REFerence <num>

Applicable Models: N522xB, N523xB, N524xB, M9485A

(Read-Write) Sets the attenuation level for the specified reference attenuator/port.

Parameters

<cnum> Any existing channel number. If unspecified, value is set to 1.

<port> Port number of the VNA. If unspecified, value is set to 1.

<num> Attenuation value in dB. 0dB (Low) or 35dB (High)

If a number other than these is entered, the analyzer will select the next lower valid value. For example, if 19dB is entered, then 0dB attenuation will be selected.

Examples

```
SOUR:POW2:ATT:REC:REF 0
```

```
source:power:attenuation:receiver:reference 35
```

Query Syntax SOURce<cnum>:POWER<port>:ATTenuation:RECEiver:REFerence?

Return Type Numeric. If querying for the standard port, the return value is 0

Default 35

SOURce<cnum>:POWER<port>:ATTenuation:RECEiver:TEST <num>

Applicable Models: N522xB, N523xB, N524xB, M9485A, M980xA and P50xxA with option S9x090A

(Read-Write) Sets the attenuation level for the specified test attenuator/port.

Note: On M980xA and P50xxA, this command works only for Spectrum Analyzer channels. For S-parameter channels, use the **Receiver Gain dialog** or **SENSe:SOURce:RECEiver:GAIN:*** commands.

Parameters

<cnum> Any existing channel number. If unspecified, value is set to 1.

<port> Source port number of the VNA. If unspecified, value is set to 1.

<num> Attenuation value in dB. 0dB (Low) or 35dB (High) / 20dB (High) for M980xA and P50xxA.

If a number other than these is entered, the analyzer will select the next lower valid value. For example, if 19dB is entered, then 0dB attenuation will be selected.

Examples

```
SOUR:POW2:ATT:REC:TEST 0
source:power:attenuation:receiver:test 35
```

Query Syntax SOURce<cnum>:POWer<port>:ATTenuation:RECeiver:TEST?

Return Type Numeric. If querying for the standard port, the return value is 0

Default 35 or 0 (for M980xA and P50xxA)

SOURce<cnum>:POWer<port>:CENTer <num>

Applicable Models: All

(Read-Write) Sets the power sweep center power. Must also set: SENS:SWE:TYPE POWER and SOURce:POWer:SPAN <num>.

Parameters

- <cnum> Any existing channel number. If unspecified, value is set to 1
- <num> Center power. Actual achievable leveled power depends on frequency.
- <port> If provided, this argument is **ignored** by the VNA.

Examples

```
SOUR:POW:CENT -15
source2:power:center -7
```

Query Syntax SOURce<cnum>:POWer:CENTer?

Return Type Numeric

Default 0 dBm

SOURce<cnum>:POWer<port>:COUPlE <ON | OFF>

Applicable Models: All

(Read-Write) Turns Port Power Coupling ON or OFF.

Parameters

<cnum> Any existing channel number. If unspecified, value is set to 1

<ON | OFF> **ON** (or 1) - turns coupling ON. The same power level is used for both source ports.

OFF (or 0) - turns coupling OFF. Power level can be set individually for each source port.

Examples

```
SOUR:POW:COUP ON
source2:power:couple off
```

Query Syntax SOURce<cnum>:POWer:COUPle?

Return Type Boolean (1 = ON, 0 = OFF)

Default ON

SOURce<cnum>:POWer:DETector <char> **OBSOLETE**

(Read-Write) The VNA models with external leveling are now OBSOLETE.

Sets the source leveling loop as Internal or External.

Parameters

<cnum> Any existing channel number. If unspecified, value is set to 1

<char> **INTernal** - Internal leveling is applied to the source

EXTernal - External leveling is applied to the source through a rear-panel connector. ONLY provided on 3 GHz, 6 GHz, and 9 GHz VNA models.

Examples

```
SOUR:POW:DET INT
source2:power:detector external
```

Query Syntax SOURce<cnum>:POWer:DETector?

Return Type Character

Default INTernal

SOURce<cnum>:POWer<port>[:LEVel][:IMMEDIATE][:AMPLitude] <num>, [src]

Applicable Models: All

(Read-Write) Sets the RF power output level.

Parameters

- <cnm> Any existing channel number. If unspecified, value is set to 1
- <port> Source port number of the VNA. If unspecified, value is set to 1. To make settings for ports that are not simple numbers, use the [src] argument.
- <num> Source power in dBm.

Note: The range of settable power values depends on the VNA model and if source attenuators are installed. To determine the range of values, perform a query using MAX, then MIN, as an argument. (SOUR:POW:ATT:AUTO must be set to ON) Example: SOURce:POWer? Max

Actual achievable leveled power depends on frequency.

- [src] **String.** (NOT case sensitive). Source port. Optional. Use SOUR:CAT? to return a list of valid port names.

While this argument can be used to make settings for ALL ports, it is designed to access ports such as an external source, true mode balanced port, or one of the Source 2 outputs on the 2-port 2-source PNA-X model such as "Port 1 Src2". Otherwise, the <port> argument performs the same function. If both arguments are specified, [src] takes priority.

Examples

```
SOUR:POW1 5
source2:power:level:immediate:amplitude maximum

sour:pow 5, "Port 1 Src2"
```

Query Syntax SOURce<cnm>:POWer[:LEVel][:IMMediate][:AMPLitude]? [src]

Return Type Numeric

Default 0 dBm

SOURce<cnm>:POWer<port>[:LEVel]:SLOPe <num>

Applicable Models: All

(Read-Write) Sets the RF power slope value.

Also enable the slope state using **SOUR:POW:SLOP:STAT ON**.

Parameters

- <cnun> Any existing channel number. If unspecified, value is set to 1
- <num> Slope value in db/GHz. Choose any value between **-2** and **2** (0 is no slope).
- <port> If provided, this argument is **ignored** by the VNA.

Examples

```
SOUR:POW:SLOP .5234434  
source2:power:level slope -1.345
```

Query Syntax SOURce<cnun>:POWer[:LEVel]:SLOPe?

Return Type Numeric

Default 0

SOURce<cnun>:POWER<port>[:LEVel]:SLOPe:STATe <ON | OFF>

Applicable Models: All

(Read-Write) Turns Power Slope ON or OFF. Set the slope using **SOUR:POW:SLOP**.

Parameters

- <cnun> Any existing channel number. If unspecified, value is set to 1
- <ON|OFF> **ON** (or 1) - turns slope ON.
OFF (or 0) - turns slope OFF.
- <port> If provided, this argument is **ignored** by the VNA.

Examples

```
SOUR:POW:SLOP:STAT ON  
source2:power:slope:state off
```

Query Syntax SOURce<cnun>:POWER[:LEVel]:SLOPe:STATe?

Return Type Boolean (1 = ON, 0 = OFF)

Default OFF

SOURce<cnun>:POWER<port>:MODE <state>, [src]

Applicable Models: All

(Read-Write) Sets the state of VNA source for the specified port.

Parameters

- <num> Any existing channel number. If unspecified, value is set to 1
- <port> Source port number of the VNA. If unspecified, <port> is set to 1. To make settings for ports that are not simple numbers, use the [src] argument.
- <state> Source state. Choose from:
- **AUTO** Source power is turned ON when required for a measurement.
 - **ON** Source power is always ON regardless of the measurement.
 - **OFF** Source power is always OFF regardless of the measurement.
 - **NOCTL** Do not send OFF commands to the external sources. If an external source is in the OFF state, this option is used to stop sending OFF commands to the external source to increase sweep speed.
- [src] **String**. (NOT case sensitive). Source port. Optional. Use **SOUR:CAT?** to return a list of valid port names.

While this argument can be used to make settings for ALL ports, it is designed to access ports such as an **external source**, true mode balanced port, or one of the Source 2 outputs on the 2-port 2-source PNA-X model such as "Port 1 Src2". Otherwise, the <port> argument performs the same function. If both arguments are specified, [src] takes priority.

Examples

```
SOUR:POW:MODE ON  
  
source2:power4:mode OFF  
  
sour:pow:mode on, "Port 1 Src2"
```

Query Syntax SOURce<num>:POWER<port>:MODE? [src]

Return Type Character

Default Auto

SOURce<num>:POWER<port>:PORT:START <num>, [src]

Applicable Models: All

(Read-Write) Sets and reads the power sweep start power value for a specific port. This allows uncoupled forward and reverse power sweep ranges. Must also set **SENS:SWE:TYPE POWER** and **SOUR:POW:COUPlE OFF**.

Parameters

- <num> Any existing channel number. If unspecified, value is set to 1
- <port> Source port number of the VNA. If unspecified, <port> is set to 1. To make settings for ports that are not simple numbers, use the [src] argument.
- <num> Start power in dBm.

Note: The range of settable power values depends on the VNA model and if source attenuators are installed. To determine the range of values, perform a query using MAX, then MIN, as an argument. (**SOUR:POW:ATT:AUTO** must be set to ON) Example: **SOURce:POWer:STARt? MIN**

Actual achievable leveled power depends on frequency.

- [src] **String**. (NOT case sensitive). Source port. Optional. Use **SOUR:CAT?** to return a list of valid port names.

While this argument can be used to make settings for ALL ports, it is designed to access ports such as an **external source**, true mode balanced port, or one of the Source 2 outputs on the 2-port 2-source PNA-X model such as "Port 1 Src2". Otherwise, the <port> argument performs the same function. If both arguments are specified, [src] takes priority.

Examples

```
SOUR:POW1:PORT:STAR -15
source2:power:port:start 5, "bal port 1"
```

Query Syntax SOURce<num>:POWer<port>:PORT:STARt? [src]

Return Type Numeric

Default -10 dBm

SOURce<num>:POWer<port>:PORT:STOP <num>, [src]

Applicable Models: All

(Read-Write) Sets and reads the power sweep stop power value for a specific port. This allows uncoupled forward and reverse power sweep ranges. Must also set **SENS:SWE:TYPE POWER** and **SOUR:POW:COUPlE OFF**.

Parameters

- <num> Any existing channel number. If unspecified, value is set to 1
- <port> Source port number of the VNA. If unspecified, <port> is set to 1. To make settings for ports that are not simple numbers, use the [src] argument.
- <num> Stop power in dBm.

Note: The range of settable power values depends on the VNA model and if source attenuators are installed. To determine the range of values, perform a query using MAX, then MIN, as an argument. (**SOUR:POW:ATT:AUTO** must be set to ON) Example: **SOURce:POWer:STARt? MIN**

Actual achievable leveled power depends on frequency.

- [src] **String.** (NOT case sensitive). Source port. Optional. Use **SOUR:CAT?** to return a list of valid port names.

While this argument can be used to make settings for ALL ports, it is designed to access ports such as an **external source**, true mode balanced port, or one of the Source 2 outputs on the 2-port 2-source PNA-X model such as "Port 1 Src2". Otherwise, the <port> argument performs the same function. If both arguments are specified, [src] takes priority.

Examples

```
SOUR:POW1:PORT:STOP -15
source2:power:port:stop 5, "bal port 1"
```

Query Syntax **SOURce<num>:POWer<port>:PORT:STOP?** [src]

Return Type Numeric

Default 0 dBm

SOURce<num>:POWer<port>:SPAN <num>

Applicable Models: All

(Read-Write) Sets the power sweep span power. Must also set:

SENS:SWE:TYPE POWER and **SOURce:POWer:CENTer <num>**.

Parameters

- <num> Any existing channel number. If unspecified, value is set to 1.
- <num> Span power. Actual achievable leveled power depends on frequency.
- <port> If provided, this argument is **ignored** by the VNA.

Examples

```
SOUR:POW:SPAN -15  
source2:power:span -7
```

Query Syntax SOURce<num>:POWer:SPAN?

Return Type Numeric

Default 0 dBm

SOURce<num>:POWer<port>:START <num>

Applicable Models: All

(Read-Write) Sets the power sweep start power for ALL ports being used by the specified channel. Must also set:

SENS:SWE:TYPE POWER and **SOURce:POWer:STOP <num>**.

To set start power for a specific port, use **SOUR:POW:PORT:START**.

Parameters

- <num> Any existing channel number. If unspecified, value is set to 1
- <num> Start power.

Note: The range of settable power values depends on the VNA model and if source attenuators are installed. To determine the range of values, perform a query using MAX, then MIN, as an argument. (**SOUR:POW:ATT:AUTO** must be set to ON) Example: SOURce:POWer:START? MIN

Actual achievable leveled power depends on frequency.

- <port> If provided, this argument is **ignored** by the VNA.

Examples SOUR:POW:STAR -15
source2:power:start -7

Query Syntax SOURce<cnum>:POWer:STARt?

Return Type Numeric

Default 0 dBm

SOURce<cnum>:POWer<port>:STOP <num>

Applicable Models: All

(Read-Write) Sets the power sweep stop power for ALL ports being used by the specified channel.. Must also set: **SENS:SWE:TYPE POWER** and **SOURce:POWer:START <num>**.

To set start power for a specific port, use **SOUR:POW:PORT:STOP**.

Parameters

<cnum> Any existing channel number. If unspecified, value is set to 1

<num> Stop power.

Note: The range of settable power values depends on the VNA model and if source attenuators are installed. To determine the range of values, perform a query using MAX, then MIN, as an argument. (**SOUR:POW:ATT:AUTO** must be set to ON) Example: SOURce:POWer:STOP? MAX

Actual achievable leveled power depends on frequency.

<port> If provided, this argument is **ignored** by the VNA.

Examples SOUR:POW:STOP -15
source2:power:stop -7

Query Syntax SOURce<cnum>:POWer:STOP?

Return Type Numeric

Default 0 dBm

SOURce<cnum>:PULSe<port>:MODUlator[:STATe] <ON | OFF>,[src]

Applicable Models: All

(Read-Write) Turns pulse on and off with an external modulation source.

Parameters

<num> Any existing channel number. If unspecified, value is set to 1

<ON|OFF> **ON** (or 1) - turns pulse ON.

OFF (or 0) - turns pulse OFF.

<port> Source port number of the VNA. If unspecified, <port> is set to 1.

[src] **String**. (NOT case sensitive). Source port. Optional. Use **SOUR:CAT?** to return a list of valid port names.

While this argument can be used to make settings for ALL ports, it is designed to access ports such as an **external source**, true mode balanced port, or one of the Source 2 outputs on the 2-port 2-source PNA-X model such as "Port 1 Src2". Otherwise, the <port> argument performs the same function. If both arguments are specified, [src] takes priority.

Examples

```
SOUR:PULS:MOD:STAT ON,"MyMxg"  
source2:pulse1:modulator:state off
```

Query Syntax SOURce<num>:PULSe<port>:MODulator[:STATe]?

Return Type Boolean (1 = ON, 0 = OFF)

Default OFF

SOURce<num>:PULSe:MODulator:EXISTS? [src]

Applicable Models: All

(Read-only) Checks if pulse source exists.

Parameters

Examples

```
SOUR:PULS:MOD:EXIS?  
source:pulse:modulator:exists? "MyMxg"
```

[src] **String**. (NOT case sensitive). Source port. Optional. Use **SOUR:CAT?** to return a list of valid port names.

While this argument can be used to make settings for ALL ports, it is designed to access ports such as an **external source**, true mode balanced port, or one of the Source 2 outputs on the 2-port 2-source PNA-X model such as "Port 1 Src2". Otherwise, the <port> argument performs the same function. If both arguments

are specified, [src] takes priority.

Return Type String

Default Not applicable

Source:Power:Correction Commands

Used to perform source power calibration on internal and external sources.

Note: Only ONE Source Power Cal can be performed at a time.

SOURce:POWer:CORRection

COLLect

- | **ABORt**
 - | **ACQuire**
 - | **AVERage**
 - | **[COUNT]**
 - | **NTOLerance**
 - | **DISPlay**
 - | **[STATe]**
 - | **FCHeck]**
 - | **[STATe]**
 - | **ITERation**
 - | **[COUNT]**
 - | **NTOLerance**
 - | **METHod**
 - | **SAVE**
 - | **SENSor**
 - | **[FRANge]**
 - | **RCFactor**
 - | **SElect**
 - | **TABLE**
 - | **DATA**
 - | **FREQuency**
 - | **LOSS**
 - | **[STATe]**
 - | **POINTs?**
 - | **[SElect]**
 - | **WARN**
- DATA**
- | **PRIor**

LEVel [AMPlitude] OFFSet [MAGNitude] [STATe]

Click on a keyword to view the command details.

Blue commands are superseded.

See Also

- Example program using these commands.
- Template for creating your own Power Meter Driver
- [Learn about Source Power Cal](#)
- Synchronizing the Analyzer and Controller
- SCPI Command Tree

Note : The `SOURce:POWer:CORRection:COLLect:ACQuire` command, used to step the VNA and read a power meter, cannot be sent over the GPIB unless the power meter is connected to a different GPIB interface. See the alternative methods described in the command details.

`SOURce<ch>:POWer<port>:CORRection:COLLect:ABORt`

Applicable Models: N522xB, N523xB, N524xB, E5080, M980xA, P50xxA, M9485A

(Write-only) Aborts a source power calibration sweep that is in progress.

To use this `ABORt` command, you **MUST** use the **ASYNchronous** argument with `SOUR:POW:CORR:COLL:ACQ`

After aborting, this message appears in the error log: **+243,"Requested operation was canceled".**

Parameters

- <ch> Channel number of the source power cal. If unspecified, value is set to 1
- <port> Port number to correct for source power. If unspecified, value is set to 1.

Examples

```
SOUR:POW:CORR:COLL:ABOR  
source1:power2:correction:collect:abort
```

Query Syntax Not Applicable

Default Not Applicable

SOURce<ch>:POWER<port>:CORRection:COLLect[:ACQuire] <char>,<id>[,src][,sync]

Applicable Models: N522xB, N523xB, N524xB, E5080, M980xA, P50xxA, M9485A

(Write-only) Initiates a source power cal acquisition sweep using the power sensor attached to the specified channel (A or B) on the power meter, using a USB power sensor, or using the specified VNA receiver.

For source power cal, the power meter can NOT be controlled by the VNA using the GPIB Talker/Listener interface. Instead use one of the following methods:

- If present, use the GPIB dedicated controller port.
- Connect the power meter to the VNA using a USB / GPIB interface (Keysight 82357A).
- SCPI programming of the VNA using a LAN Client interface (see example).
- Send SCPI commands through the COM interface using the SCPI String Parser object.
- Directly control the Power Meter and VNA to step frequency; then acquire and store the Power reading. (see example).
- Configure the Power Meter/Sensor as a PMAR Device. Learn how . See SCPI commands .

Parameters

<ch> Channel number of the source power cal. If unspecified, value is set to 1

<port> Port number to correct for source power. If unspecified, value is set to 1.

<char> Acquisition Choose from:

- **PMETer** - Power Meter is used for all readings.
- **PMREceiver** - Power meter for the first iteration; then use the reference receiver for remaining readings if necessary (same as "fast iteration" box checked on dialog box)
- **RECeiver** - Use VNA measurement receiver for all readings.

<id> **String** (Not case sensitive). The power sensor or VNA receiver to use for measuring power.

For **PMETer** or **PMRECeiver** , choose from:

- **"ASENSOR"** or **"BSENSOR"** . For U series USB sensors, always specify **"ASENSOR"**

For **RECeiver** , choose from:

- Any VNA receiver to acquire readings using physical or logical receiver notation .
- Any configured PMAR device name. Learn more about PMAR Devices . See PMAR commands .

[src] Optional argument. **String** . (NOT case sensitive). Source port. Use SOUR:CAT? to return a list of valid port names.

While this argument can be used to make settings for ALL ports, it is designed to access ports that are not simple numbers, such as "Port 1 Src2". Otherwise, the <port> argument performs the same function. If both arguments are specified, [src] takes priority.

[sync] If this argument is specified, must also specify [src].

Choose from:

- **SYNChronous** - Blocks SCPI commands during standard measurement (default behavior).
- **ASYNchronous** - Does NOT block SCPI commands during standard measurement.

Learn more about this argument

Examples

```
SOUR:POW:CORR:COLL PMET,"ASENSOR","Port 1",ASYN 'acquires power
meter readings using the A sensor, source port 1, asynchronous.
source1:power2:correction:collect:acquire receiver,"a1"
'acquires source cal readings using the reference receiver for
port 1.
```

Query Syntax Not Applicable

Default Not Applicable

SOURce:POWer<port>:CORRection:COLLect:AVERAge[:COUNT] <num>

Applicable Models: N522xB, N523xB, N524xB, E5080, M980xA, P50xxA, M9485A

(Read-Write) This command, along with SOUR:POW:CORR:COLL:AVER:NTOLerance , allows for settling of the power sensor READINGS.

Note: This command is global and does not depend on a specific channel number.

Sets the maximum number of acquisitions that will be used to acquire one **settled reading** from the power meter.

These settings affect every use of the power meter (PMAR and source power cal).

This setting and corresponding SOUR:POW:CORR:COLL:AVER:NTOLerance command only effect the settled reading of the currently selected legacy power meter.

Note: To set the COUNT/NTOLerance of a specific PMAR, use the SYST:CONF:EDEV:PMAR:READ:COUNT and SYST:CONF:EDEV:PMAR:READ:NTOLerance commands.

Users may want to adjust this number if they know the signal is noisy as these settings set a threshold that determines when the power meter reading is done.

Each reading is averaged with the previous readings. When this average meets the Average:NTOLerance value or this number of readings has been made, the average is returned as the valid reading.

Learn more.

Parameters

- <port> If provided, this argument is **ignored** by the VNA.
- <num> Maximum number of readings to make to allow for settling. Choose any number between 3 and 1000.

Examples

```
// configure the power meter settling (up to 2 acquisitions to
produce one settled meter reading)

SOUR:POW:CORR:COLL:AVER 2
SOUR:POW:CORR:COLL:AVER:NTOL .05

// configure the number of (settled) readings to acquire at each
frequency point.

// 3 settled readings are averaged to produce one bucket of data
per frequency

SOUR:POW:CORR:COLL:ITER 3
SOUR:POW:CORR:COLL:ITER:NTOL .005
```

Query Syntax SOURce:POWer:CORRection:COLLect:AVERAge[:COUNT]?

Return Type Numeric

Default 3

SOURce:POWer<port>:CORRection:COLLect:AVERAge:NTOLerance <num>

Applicable Models: N522xB, N523xB, N524xB, E5080, M980xA, P50xxA, M9485A

(Read-Write) This command, along with SOUR:POW:CORR:COLL:AVER:COUNT , allows for settling of the power sensor READINGS.

Note: This command is global and does not depend on a specific channel number.

This setting and corresponding SOUR:POW:CORR:COLL:AVER:COUNT command only effect the settled reading of the currently selected legacy power meter.

Note: To set the COUNT/NTolerance of a specific PMAR, use the SYST:CONF:EDEV:PMAR:READ:COUNT and SYST:CONF:EDEV:PMAR:READ:NTolerance commands.

Each power reading is averaged with the previous readings. When the average meets this nominal tolerance value or the max number of readings has been made, the average is returned as the valid reading.

Learn more.

Parameters

- <port> If provided, this argument is **ignored** by the VNA.
- <num> Power measurement settling tolerance value in dB. Choose any number between 0 and 5.

Examples

```
// configure the power meter settling (up to 2 acquisitions to
produce one settled meter reading)

SOUR:POW:CORR:COLL:AVER 2
SOUR:POW:CORR:COLL:AVER:NTOL .05

// configure the number of (settled) readings to acquire at each
frequency point.

// 3 settled readings are averaged to produce one bucket of data
per frequency

SOUR:POW:CORR:COLL:ITER 3
SOUR:POW:CORR:COLL:ITER:NTOL .005
```

Query Syntax SOURce:POWer:CORRection:COLLect:AVERAge:NTOLerance?

Return Type Numeric

Default .050 dBm

SOURce<ch>:POWer<port>:CORRection:COLLect:DISPlay[:STATe] <ON | OFF>

Applicable Models: N522xB, N523xB, N524xB, E5080, M980xA, P50xxA, M9485A

(Read-Write) Enables and disables the display of power readings on the VNA screen. Send this command BEFORE you begin a source power cal acquisition. After the source power cal data is acquired, this setting is reset to ON.

Parameters

- <ch> Channel number of the source power cal. If unspecified, value is set to 1
- <port> If provided, this argument is **ignored** by the VNA.
- <ON|OFF> **ON (1)** Source power calibration dialog box is shown on the VNA screen. Power readings are plotted against the Tolerance value as limit lines.
OFF (0) - Source power calibration dialog box is NOT shown on the VNA screen.

Examples

```
SOUR:POW:CORR:COLL:DISP ON  
source1:power2:correction:collect:display:state off
```

Query Syntax SOURce:POWer:CORRection:COLLect:DISPlay[:STATe]?

Return Type Boolean (1 = ON, 0 = OFF)

Default ON (1)

SOURce<ch>:POWer<port>:CORRection:COLLect:FCHeck[:STATe] <ON | OFF>

Applicable Models: N522xB, N523xB, N524xB, E5080, M980xA, P50xxA, M9485A

(Read-Write) Enables and disables frequency checking of source power cal acquisition sweeps. ONLY use when you have more than one power sensor.

Parameters

- <ch> Channel number of the source power cal. If unspecified, value is set to 1
- <port> If provided, this argument is **ignored** by the VNA.
- <ON|OFF> **ON (1)** turns source power cal frequency checking ON. A requested acquisition will only succeed for those frequency points which fall within a frequency range specified for the power sensor being used. An acquisition will pause in mid-sweep if the frequency is about to exceed the maximum frequency limit specified for that sensor. When the sweep is paused in this manner, a sensor connected to the other channel input of the power meter can be connected to the measurement port in place of the previous sensor, and used to complete the sweep. However, the maximum frequency specified for the

second sensor would need to be sufficient for the sweep to complete. Frequency limits are specified using the SOUR:POW:CORR:COLL:SEN command.

OFF (0) - turns source power cal frequency checking OFF. An acquisition will use just one power sensor for the entire sweep, regardless of frequency.

Examples

```
SOUR:POW:CORR:COLL:FCH ON
source1:power2:correction:collect:fcheck:state off
```

Query Syntax SOURce:POWer:CORRection:COLLect:FCHeck[:STATE]?

Return Type Boolean (1 = ON, 0 = OFF)

Default OFF (0)

SOURce<ch>:POWer<port>:CORRection:COLLect:ITERation[:COUNT] <num>

Applicable Models: N522xB, N523xB, N524xB, E5080, M980xA, P50xxA, M9485A

(Read-Write) This command, along with SOUR:POW:CORR:COLL:ITER:NTOL control the number of settled readings taken to produce a single power point during source power cal.

The source power cal reads the power (performed by SOUR:POW:CORR:COLL:AVER:COUNT and SOUR:POW:CORR:COLL:AVER:NTOLerance) and makes internal adjustments to set the power to a desired level. These settings determine how many attempts (COUNT) the analyzer will make in an attempt to get close enough (NTOLerance) to the target power level.

Learn more.

Parameters

- <ch> If provided, this argument is **ignored** by the VNA.
- <port> If provided, this argument is **ignored** by the VNA.
- <num> Maximum number of readings. Choose any number between 1 and 1000.

Examples

```
// configure the power meter settling (up to 2 acquisitions to
produce one settled meter reading)

SOUR:POW:CORR:COLL:AVER 2
SOUR:POW:CORR:COLL:AVER:NTOL .05

// configure the number of (settled) readings to acquire at each
frequency point.

// 3 settled readings are averaged to produce one bucket of data
per frequency

SOUR:POW:CORR:COLL:ITER 3
```

```
SOUR:POW:CORR:COLL:ITER:NTOL .005
```

Query Syntax SOURce:POWer:CORRection:COLLect:ITERation[:COUNT]?

Return Type Numeric

Default 1

SOURce<ch>:POWER<port>:CORRection:COLLect:ITERation:NTOLerance <num>

Applicable Models: N522xB, N523xB, N524xB, E5080, M980xA, P50xxA, M9485A

(Read-Write) This command, along with SOUR:POW:CORR:COLL:ITER:COUNT describes the number of adjustments to make to the source power.

Sets the maximum desired deviation from the sum of the test port power and the offset value. Power READINGS (performed by SOUR:POW:CORR:COLL:AVER:COUNT and SOUR:POW:CORR:COLL:AVER:NTOLerance) will continue to be made, and source power adjusted, until a measurement is within this tolerance value or the max number of measurements has been met. The last value is the valid measurement for that data point.

Learn more.

Parameters

- <ch> If provided, this argument is **ignored** by the VNA.
- <port> If provided, this argument is **ignored** by the VNA.
- <num> Tolerance value in dBm. Choose any number between 0 and 5

Examples

```
// configure the power meter settling (up to 2 acquisitions to
produce one settled meter reading)

SOUR:POW:CORR:COLL:AVER 2
SOUR:POW:CORR:COLL:AVER:NTOL .05

// configure the number of (settled) readings to acquire at each
frequency point.

// 3 settled readings are averaged to produce one bucket of data
per frequency

SOUR:POW:CORR:COLL:ITER 3
SOUR:POW:CORR:COLL:ITER:NTOL .005
```

Query Syntax SOURce:POWer:CORRection:COLLect:ITERation:NTOLerance?

Return Type Numeric

SOURce<ch>:POWER<port>:CORRection:COLLect:METhod <char> **Superseded**

Applicable Models: N522xB, N523xB, N524xB

This command is replaced with SOUR:POW:CORR:COLLect[:ACQuire] which now specifies the method **and** the device. The only parameter required by that command was either **ASENSor** or **BSENSor** which are still supported but not documented.

(Read-Write) Selects the calibration method to be used for the source power cal acquisition.

Parameters

- <ch> Channel number of the source power cal. If unspecified, value is set to 1
- <port> Port number to correct for source power. If unspecified, value is set to 1.
- <char> Choose from:

NONE - No Cal method

PMETer - Power Meter is used for all readings. (same as "fast iteration" box not checked on dialog box)

PMReceiver - Power meter for the first iteration; then use the reference receiver for remaining readings if necessary (same as "fast iteration" box checked on dialog box)

Examples

```
SOUR:POW:CORR:COLL:METh PMET
source1:power2:correction:collect:method pmreceiver
```

Query Syntax SOURce:POWER:CORRection:COLLect:METhod?

Return Type Character

Default NONE

SOURce<ch>:POWER<port>:CORRection:COLLect:SAVE [<RREC>]

Applicable Models: N522xB, N523xB, N524xB, E5080, M980xA, P50xxA, M9485A

(Write-only) Applies the array of correction values after a source power calibration sweep has completed. The source power correction will then be active on the specified source port for channel <ch>. This command does NOT save the correction values. To save correction values, save an instrument / calibration state (*.cst file) after performing a source power cal.

Parameters

- <ch> If provided, this argument is **ignored** by the VNA.
- <port> If provided, this argument is **ignored** by the VNA.
- <RREC> Optional argument.

RRECeiver In addition to a source Power Cal, perform a calibration of the reference receiver used in the measurement. ONLY the Reference Receiver calibration is then saved to a Cal Set or Cal Register as specified by the current setting of SENS:CORR:PREF:CSET:SAVE .

This argument only applies to standard S-parameter channels.

Examples

```
SOUR:POW:CORR:COLL:SAVE
source:power:correction:collect:save rreceiver
```

Query Syntax Not Applicable

Default Not Applicable

SOURce<ch>:POWER<port>:CORREction:COLLEct:<pmChan>SENSor[:FRANge]
<num1>,<num2>

Applicable Models: N522xB, N523xB, N524xB, E5080, M980xA, P50xxA, M9485A

(Read-Write) Specifies the frequency range over which the power sensors connected to the specified channels (A and B) of the power meter can be used (minimum frequency, maximum frequency). If the power meter has only a single channel, that channel is considered channel A.

Parameters

- <ch> Channel number of the source power cal. If unspecified, value is set to 1
- <port> If provided, this argument is **ignored** by the VNA. (It is required for query).
- <pmChan> Power Meter channel. Choose from:
 - A** - Channel A
 - B** - Channel B

- <num1> Minimum frequency for the sensor. If a frequency unit is not specified, Hz is assumed.
- <num2> Maximum frequency for the sensor. If a frequency unit is not specified, Hz is assumed.

Examples

```
SOUR:POW:CORR:COLL:ASEN 100E3, 3E9
source1:power:correction:collect:bsensor:frange 10 MHz, 18 GHz
```

Query Syntax

```
SOURce<ch>:POWer<port>:CORRection:COLLEct:ASENsor[:FRANge]?
SOURce<ch>:POWer<port>:CORRection:COLLEct:BSENsor[:FRANge]?
```

Return Type

Numeric

Default

0,0

SOURce<ch>:POWer<port>:CORRection:COLLEct:<pmChan>SENsor:RCFactor <num>

Applicable Models: N522xB, N523xB, N524xB, E5080, M980xA, P50xxA, M9485A

(Read-Write)) Specifies the reference cal factor for the power sensor connected to channel A or B of the power meter. If the power meter has only a single channel, that channel is considered channel A.

Note : If the sensor connected to the specified channel of the power meter contains cal factors in EPROM (such as the Keysight E-series power sensors), those will be the cal factors used during the calibration sweep. The reference cal factor value associated with this command, and any cal factors entered into the VNA for that sensor channel, will not be used.

Parameters

- <ch> Channel number of the source power cal. If unspecified, value is set to 1
- <port> If provided, this argument is **ignored** by the VNA.
- <pmChan> Power Meter channel. Choose from:
 - A** - Channel A
 - B** - Channel B
- <num> Reference cal factor in percent. Choose any number between 1 and 150.

Examples

```
SOUR:POW:CORR:COLL:ASEN:RCF 98.7
source1:power2:correction:collect:bsensor:rcfactor 105
```

Query Syntax

```
SOURce:POWer:CORRection:COLLEct:ASENsor:RCFactor?
SOURce:POWer:CORRection:COLLEct:BSENsor:RCFactor?
```

Return Type

Numeric

SOURce<ch>:POWER<port>:CORRection:COLLect:<pmChan>SENSor:SELEct

Applicable Models: N522xB, N523xB, N524xB, E5080, M980xA, P50xxA, M9485A

(Read-Write) Sets and returns the power sensor channel (A or B) to be used. This performs the same function as the **Use this sensor only** checkbox in the Power Sensor Settings dialog .

Notes:

- This command is NOT necessary when performing a Guided Power Cal using Multiple Sensors.
- This command can be used with Application channels .

Parameters

- <ch> Channel number of the source power cal. If unspecified, value is set to 1
- <port> If provided, this argument is **ignored** by the VNA.
- <pmChan> Power Meter channel. Choose from:
 - A - Channel A

B - Channel B

Examples

```
SOUR:POW:CORR:COLL:<pmChan>SEN:SEL 'Write
source1:power2:correction:collect:bsensor:select? 1e9 'Read
```

Query Syntax SOURce:POWER:CORRection:COLLect:ASENSor:SELEct? <Frequency>
 SOURce:POWER:CORRection:COLLect:BSENSor:SELEct? <Frequency>

Returns a boolean 1 or 0 (ON or OFF) indicating whether the sensor is to be used at the specified frequency.

If frequency checking is OFF, then the <Frequency> parameter is ignored. The query returns if the sensor is selected for ALL frequencies.

Return Type Numeric

Default Not Applicable

SOURce<ch>:POWER<port>:CORRection:COLLect:TABLE:DATA <data>

Applicable Models: N522xB, N523xB, N524xB, E5080, M980xA, P50xxA, M9485A

(Read-Write) Read or write data into the selected table. Use SOUR:POW:CORR:COLL:TABL:SElect to select a table.

- When the power sensor table is selected, the data is interpreted as cal factors in **percent** .
- When the loss table is selected, POSITIVE values in dB are interpreted as LOSS. To compensate for gain, use negative values.
- Each table can contain up to 9999 segments. Values can be loaded using the Characterize Adapter macro.
- Learn more about Power Loss Compensation .

Parameters

- <ch> Channel number of the source power cal. If unspecified, value is set to 1
- <port> If provided, this argument is **ignored** by the VNA.
- <data> Data to write into the selected table.

Examples

```
SOURce:POWer:CORRection:COLLect:TABLE:DATA 0.12, 0.34, 0.56
```

Query Syntax

SOURce<ch>:POWer:CORRection:COLLect:TABLE:DATA?

If the selected table is currently empty, no data is returned.

Return Type

Numeric - one number per table segment.

Default

Not Applicable

SOURce<ch>:POWer<port>:CORRection:COLLect:TABLE:FREQuency <data>

Applicable Models: N522xB, N523xB, N524xB, E5080, M980xA, P50xxA, M9485A

(Read-Write) Read or write frequency values for the selected table (cal factor table for a power sensor, or the loss compensation table). Use SOUR:POW:CORR:COLL:TABL:SElect to select a table.

Parameters

- <ch> Channel number of the source power cal. If unspecified, value is set to 1
- <port> If provided, this argument is **ignored** by the VNA.
- <data> Frequency data to write into the selected table.

Examples

```
SOURce:POWer:CORRection:COLLect:TABLE:FREQuency 10E6, 1.5E9, 9E9
```

Query Syntax

SOURce<ch>:POWer:CORRection:COLLect:TABLE:FREQuency?

If the selected table is currently empty, no data is returned.

Return Type Numeric - one number per table segment

Default Not Applicable

SOURce<ch>:POWER<port>:CORRection:COLLect:TABLE:LOSS[:STATe] <ON | OFF>

Applicable Models: N522xB, N523xB, N524xB, E5080, M980xA, P50xxA, M9485A

(Read-Write) Indicates whether or not to adjust the power readings using the values in the loss table during a source power cal sweep. Learn more about Power Loss Compensation .

Parameters

- <ch> Channel number of the source power cal. If unspecified, value is set to 1
- <port> If provided, this argument is **ignored** by the VNA.
- <ON|OFF> **ON (or 1)** - turns use of the loss table ON.
OFF (or 0) - turns use of the loss table OFF.

Examples

```
SOUR:POW:CORR:COLL:TABL:LOSS ON
source1:power2:correction:collect:table:loss:state off
```

Query Syntax SOURce:POWER:CORRection:COLLect:TABLE:LOSS[:STATe]?

Return Type Boolean (1 = ON, 0 = OFF)

Default OFF (0)

SOURce<ch>:POWER<port>:CORRection:COLLect:TABLE:POINTS?

Applicable Models: N522xB, N523xB, N524xB, E5080, M980xA, P50xxA, M9485A

(Read-only) Returns the number of segments that are currently in the selected table.

Parameters

- <ch> Channel number of the source power cal. If unspecified, value is set to 1
- <port> If provided, this argument is **ignored** by the VNA.

Examples

```
SOUR:POW:CORR:COLL:TABL:POIN?
source1:power2:correction:collect:table:points?
```

Return Type Numeric

Default 0

SOURce<ch>:POWER<port>:CORRection:COLLect:TABLE[:SElect] <char>

Applicable Models: N522xB, N523xB, N524xB, E5080, M980xA, P50xxA, M9485A

(Read-Write) Selects which table you want to write to or read from. Read or write using SOURce:POWer:CORRection:COLLect:TABLE:FREQUency and SOURce:POWer:CORRection:COLLect:TABLE:DATA

Parameters

- <ch> Channel number of the source power cal. If unspecified, value is set to 1
- <port> If provided, this argument is **ignored** by the VNA.
- <char> Choose from:

NONE - No table selected

ASENSor - Cal Factor table for Power Sensor A

BSENSor - Cal Factor table for Power Sensor B

LOSS - Loss compensation table

Examples

```
SOUR:POW:CORR:COLL:TABLE:ASEN
source1:power2:correction:collect:table:select bsensor
```

Query Syntax SOURce:POWer:CORRection:COLLect:TABLE[:SElect]?

Return Type Character

Default NONE

SOURce<ch>:POWer<port>:CORRection:COLLect:WARN <bool>

Applicable Models: N522xB, N523xB, N524xB, E5080, M980xA, P50xxA, M9485A

(Read-Write) Enables/disables the use of error messages during a source calibration if the calibration fails to achieve the desired power level at the power sensor.

This property affects error reporting during the acquisition of a source power calibration.

When the power calibration sweep occurs, the tolerance set by “ SOUR:POW:CORR:COLL:ITER:NTOL “ is indicated by a set of limit lines.

When those limits fail and SOUR:POW:CORR:COLL:WARN is set to OFF, the failure is not reported. This is the default.

When those limits fail and SOUR:POW:CORR:COLL:WARN is set to ON, the failure is reported to the SCPI error queue.

Parameters

- <ch> Channel number of the source power cal. If unspecified, value is set to 1
- <port> If provided, this argument is **ignored** by the VNA.
- <bool> **ON (or 1)** - enables SCPI error on source power calibration failure.
OFF (or 0) - disables SCPI error on source power calibration failure.

Examples

```
SOUR:POW:CORR:COLL:WARN ON  
source1:power2:correction:collect:warn off
```

Query Syntax SOURce:POWer:CORRection:COLLect:WARN?

Return Type Boolean (1 = ON, 0 = OFF)

Default OFF (0)

SOURce<ch>:POWer<port>:CORRection:DATA <data>[,src]

Applicable Models: All

(Read-Write) Writes and reads source power calibration data.

The effect from this command on the channel is immediate. Do NOT send SOUR:POW:CORR:COLL:SAVE after this command as it may invalidate the uploaded data.

When querying source power calibration data, if no source power cal data exists for the specified channel and source port, then no data is returned.

If a change in the instrument state causes interpolation and/or extrapolation of the source power cal, the correction data associated with this command correspond to the new instrument state (interpolated and/or extrapolated data).

If the channel is sweeping the source backwards, then the first data point is the highest frequency value; the last data point is the lowest. Use the SENS:X:VALues? command to return the X-axis values in the displayed order.

Parameters

- <ch> Channel number of the source power cal. If unspecified, value is set to 1
- <port> Port number to correct for source power. If unspecified, value is set to 1.
- <data> Correction Data
- [src] **String** . (NOT case sensitive). Source port. Optional. Use SOUR:CAT? to return a list of valid port names.

While this argument can be used to make settings for ALL ports, it is designed to access ports that are not simple numbers, such as "Port 1 Src2". Otherwise, the <port> argument performs the same function. If both arguments are specified, [src] takes priority.

Examples

```
SOURce1:POWer2:CORRection:DATA 0.12, -0.34, 0.56
```

Query Syntax

SOURce<ch>:POWer<port>:CORRection:DATA? [src]

Return Type

Depends on FORMat:DATA command

Default

Not Applicable

SOURce<ch>:POWer<port>:CORRection:DATA:PRIor <data>[,src]

Applicable Models: N522xB, N523xB, N524xB, E5080, M980xA, P50xxA, M9485A

(Read-Write) Writes and reads power correction values from the previous iteration of the source power cal. Data for which the first power meter reading were within the tolerance limit, the prior correction value is 0.

In all other respects, this command is the same as SOUR:POW:CORR:DATA .

This command can be used to determine the final power reading at each point of the power cal, for a cal that did not pass tolerance limits. The formula for determining the power reading (in dB):

Power reading = Target power at the source port + specified power cal offset value + prior iteration corr value actual power corr value.

The "actual" value in this equation is returned with SOUR:POW:CORR:DATA?

Parameters

<ch> Channel number of the source power cal. If unspecified, value is set to 1

<port> Port number to correct for source power. If unspecified, value is set to 1.

<data> Correction Data

[src] **String** . (NOT case sensitive). Source port. Optional. Use SOUR:CAT? to return a list of valid port names.

While this argument can be used to make settings for ALL ports, it is designed to access ports that are not simple numbers, such as "Port 1 Src2". Otherwise, the <port> argument performs the same function. If both arguments are specified, [src] takes priority.

Examples

```
SOURce1:POWer2:CORRection:DATA:PRIor 0.12, -0.34, 0.56
```

Query Syntax	SOURce<ch>:POWer<port>:CORRection:DATA:PRIor? [src]
Return Type	Depends on FORMat:DATA command
Default	Not Applicable

SOURce<ch>:POWer<port>:CORRection:LEVel[:AMPLitude] <num>[,src]

Applicable Models: N522xB, N523xB, N524xB, E5080, M980xA, P50xxA, M9485A

(Read-Write) Specifies the power level that is expected at the desired reference plane (DUT input or output). This is not used for segment sweep with independent power levels or power sweeps .

Note: Although this command still works, it is recommended that you specify cal power by setting the test port power and offset value.

Parameters

- <ch> Channel number of the source power cal. If unspecified, value is set to 1
- <port> Port number to correct for source power. If unspecified, value is set to 1.
- <num> Cal power level in dBm. Because this could potentially be at the output of a device-under-test, no limits are placed on this value here. It is realistically limited by the specifications of the device (power sensor) that will be used for measuring the power. The power delivered to the VNA receiver must never exceed VNA specifications for the receiver!
- [src] **String** . (NOT case sensitive). Source port. Optional. Use SOUR:CAT? to return a list of valid port names.

While this argument can be used to make settings for ALL ports, it is designed to access ports that are not simple numbers, such as "Port 1 Src2". Otherwise, the <port> argument performs the same function. If both arguments are specified, [src] takes priority.

Examples

```
SOUR:POW:CORR:LEV 10
source1:power2:correction:level:amplitude 0 dbm
```

Query Syntax	SOURce:POWer:CORRection:LEVel[:AMPLitude]? [src]
Return Type	Numeric
Default	0 dBm

SOURce<ch>:POWer<port>:CORRection:OFFSet[:MAGNitude] <num>[,src]

Applicable Models: N522xB, N523xB, N524xB, E5080, M980xA, P50xxA, M9485A

(Read-Write) Sets or returns a power level offset from the VNA test port power. This can be a gain or loss value (in dB) to account for components you connect between the source and the reference plane of your measurement. For example, specify 10 dB to account for a 10 dB amplifier at the input of your DUT.

Cal power is the sum of the test port power setting and this offset value. Following the calibration, the VNA power readouts are adjusted to the cal power.

Parameters

- <ch> Channel number of the source power cal. If unspecified, value is set to 1
- <port> Port number to correct for source power. If unspecified, value is set to 1.
- <num> Gain or loss value in dB. Choose a value between -200 and 200
- [src] **String** . (NOT case sensitive). Source port. Optional. Use SOUR:CAT? to return a list of valid port names.

While this argument can be used to make settings for ALL ports, it is designed to access ports that are not simple numbers, such as "Port 1 Src2". Otherwise, the <port> argument performs the same function. If both arguments are specified, [src] takes priority.

Examples

```
SOUR:POW:CORR:OFFS 10  
source1:power2:correction:offset:magnitude -3
```

Query Syntax SOURce:POWer:CORRection:OFFSet[:MAGNitude]? [src]

Return Type Numeric

Default 0 dB

SOURce<ch>:POWer<port>:CORRection[:STATe] <bool>[,src]

Applicable Models: N522xB, N523xB, N524xB, E5080, M980xA, P50xxA, M9485A

(Read-Write) Enables and disables source power correction for the specified port on the specified channel.

Parameters

- <ch> Channel number of the source power cal. If unspecified, value is set to 1
- <port> Port number to correct for source power. If unspecified, value is set to 1.
- <bool> ON (or 1) turns source power correction ON.
OFF (or 0) - turns source power correction OFF.
- [src] **String** . (NOT case sensitive). Source port. Optional. Use SOUR:CAT? to return a list of valid port names.

While this argument can be used to make settings for ALL ports, it is designed to access ports that are not simple numbers, such as "Port 1 Src2". Otherwise, the <port> argument performs the same function. If both arguments are specified, [src] takes priority.

Examples

```
SOUR:POW:CORR ON  
source1:power2:correction:state off, "MXG N5183A"
```

Query Syntax SOURce:POWer:CORRection[:STATe]? "MXG N5183A"

Return Type Boolean (1 = ON, 0 = OFF)

Default OFF (0)

Status Register Commands

The status registers enable you to query the state of selected events that occur in the analyzer.

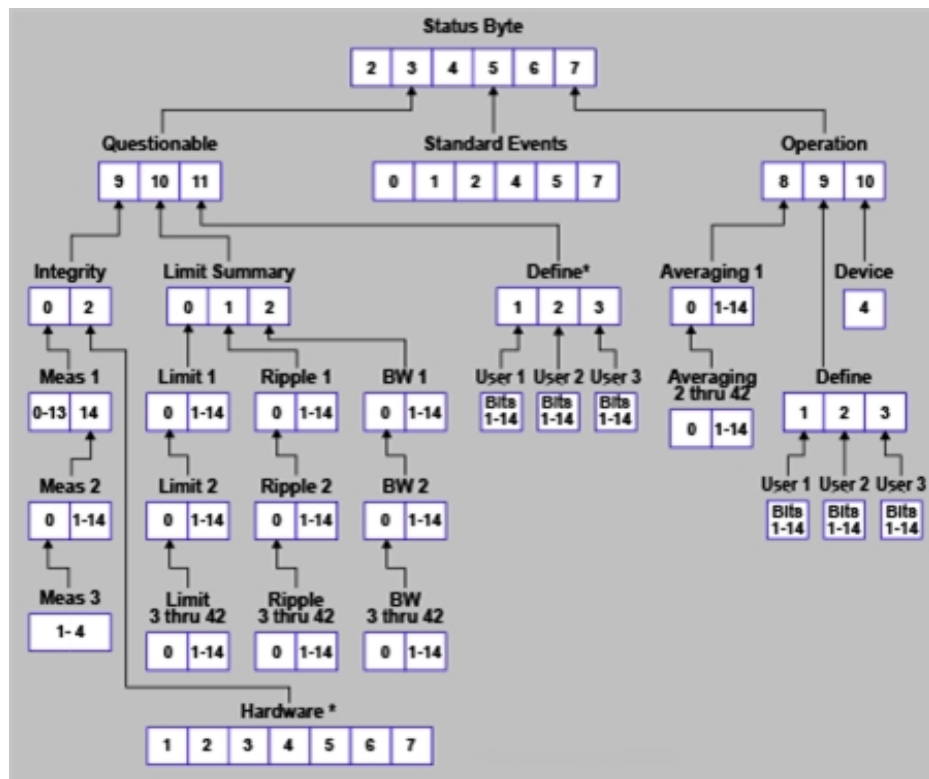

Note: This documentation requires familiarity with the "Standard Status Data Structure - Register Model" as defined in IEEE Std 488.2-1992. Also, first read [Learn about Status Registers](#)

STATUS:

OPERation

| AVERaging

| DEFine

| USER

| DEVice

PRESet

QUESTionable

| DEFine

USER
INTegrity
HARDware
MEASurement
LIMit
LSUMmary
BLIMit
LIMit
RLIMit
Standard Events
Status Byte

Click on a [red](#) keyword to view the command details.

See Also

- [Example Programs](#)
- [Learn about Status Registers](#)
- [Synchronizing the Analyzer and Controller](#)
- [SCPI Command Tree](#)

Notes:

- Any bit not shown in the registers is not used but may be reserved for future use.
- The SCPIStringParser can NOT be used with SCPI Status Reporting. However, the *OPC? will work.

STATus:OPERation<keyword>

Applicable Models: All

Summarizes conditions in the Averaging and Operation:Define:User<1|2|3> event registers.

<keyword> **Example**

:CONDition? STAT:OPER:COND?

:ENABle <bits> STAT:OPER:ENAB 1024

[:EVENT]? STAT:OPER?

:NTRansition <bits> STAT:OPER:NTR 1024

:PTRansition <bits> STAT:OPER:PTR 0

Bit	Weight	Description	Bit is set to 1 when the following conditions exist:
8	256	Averaging summary	either enabled bit in the Averaging summary event register is set to 1
9	512	User Defined summary	
10	1024	Device summary	either enabled bit in the Device summary event register is set to 1

STATus:OPERation:AVERaging<n> <keyword>

Applicable Models: All

Monitors and summarizes the status of Averaging on traces 1 to 580. When averaging for a trace is complete, the representative bit is set to 1.

Bit 0 is used to summarize the status in the registers that follow. For example, Average Register 3, bit 0, summarizes the status from registers 4 through 42.

All enable bits are set to 1 by default.

To find the measurement number, use **Calc:Par:Mnum**.

<n> Averaging Register. Choose from 1 to 42

<keyword> **Example**

:CONDition? STAT:OPER:AVER1:COND?

:ENABle <bits> STAT:OPER:AVER1:ENAB 1024

[:EVENTt]? STAT : OPER : AVER1 ?

:NTRansition <bits> STAT : OPER : AVER1 : NTR 1024

:PTRansition <bits> STAT : OPER : AVER1 : PTR 0

		Averaging Register <n>											
Bit	Weight	1	2	3	4	5	6	7	8	...	41	42	Bit is set to 1 when the following conditions exist:
0	1	2-42	3-42	4-42	5-42	6-42	7-42	8-42	9-42	...	42	--	Summary Bit - If any bit from that register fails, it propagates to the previous register, bit 0.
		Trace Numbers											
1	2	1	15	29	43	57	71	85	99	...	561	575	Averaging on this trace is complete
2	4	2	16	30	44	58	72	86	100	...	562	576	Averaging on this trace is complete
3	8	3	17	31	45	59	73	87	101	...	563	577	Averaging on this trace is complete
4	16	4	18	32	46	60	74	88	102	...	564	578	Averaging on this trace is complete
5	32	5	19	33	47	61	75	89	103	...	565	579	Averaging on this trace is complete
6	64	6	20	34	48	62	76	90	104	...	566	580	Averaging on this trace is complete
7	128	7	21	35	49	63	77	91	105	...	567	--	Averaging on this trace is complete
8	256	8	22	36	50	64	78	92	106	...	568	--	Averaging on this trace is complete
9	512	9	23	37	51	65	79	93	107	...	569	--	Averaging on this trace is complete
10	1024	10	24	38	52	66	80	94	108	...	570	--	Averaging on this trace is complete
11	2048	11	25	39	53	67	81	95	109	...	571	--	Averaging on this trace is complete

12	4096	12	26	40	54	68	82	96	110	...	572	--	Averaging on this trace is complete
13	8192	13	27	41	55	69	83	97	111	...	573	--	Averaging on this trace is complete
14	16384	14	28	42	56	70	84	98	112	...	574	--	Averaging on this trace is complete

To determine Register, Bit number, and Weight for trace numbers between 113 and 560 (not shown in the above table) use the following calculations.

The averaging status for trace numbers higher than 580 can NOT be tracked.

The following example calculates the Register, Bit number, and Bit Weight for trace # 400:

- To determine **Register** number, use $((\text{Trace \#} - 1) / 14) + 1$.
- To determine **Bit Number**, use the **remainder** +1 of the above calculation.
- $((400-1)/14) + 1 = \text{Register\# } r+1\text{Bit}$
 - $399/14 = 28 \text{ r}7$
 - $28+1= \text{Register } 29$
 - $7+1= \text{Bit number } 8$
- To determine **Bit Weight**: Use above table. For example: Bit 8 = **256**

STATus:OPERation:DEFine<keyword>

Applicable Models: N522xB, N523xB, N524xB, M937xA, P937xA

Summarizes conditions in the OPERation:Define:User<1|2|3> event registers.

<keyword>	Example
:CONDition?	STAT:OPER:DEF:COND?
:ENABle <bits>	STAT:OPER:DEF:ENAB 12
[:EVENTt]?	STAT:OPER:DEF?
:NTRansition <bits>	STAT:OPER:DEF:NTR 12
:PTRansition <bits>	STAT:OPER:DEF:PTR 0

Bit	Weight	Description	Bit is set to 1 when the following conditions exist:
1	2	USER1	any bit in the USER1 event register is set to 1
2	4	USER2	any bit in the USER2 event register is set to 1
3	8	USER3	any bit in the USER3 event register is set to 1

STATus:OPERation:DEFine:USER<1|2|3><keyword>

Applicable Models: N522xB, N523xB, N524xB, M937xA, P937xA

Monitors conditions that you define and map in any of the three OPER:DEF:USER event registers.

<keyword>	Example
:CONDition?	STAT:OPER:DEF:USER1:COND?
:ENABle <bits>	STAT:OPER:DEF:USER1:ENAB 1024
[:EVENT]?	STAT:OPER:DEF:USER1?
:MAP <bit>,<error>	STAT:OPER:DEF:USER1:MAP 0,-113 'when error -113 occurs, bit 0 in USER1 will set to 1.'
:NTRansition <bits>	STAT:OPER:DEF:USER1:NTR 12
:PTRansition <bits>	STAT:OPER:DEF:PTR 0

Bit	Weight	Description	Bit is set to 1 when the following conditions exist:
0	1	for user	user defined
1	2	for user	user defined
2	4	for user	user defined
3	8	for user	user defined
4	16	for user	user defined
5	32	for user	user defined
6	64	for user	user defined
7	128	for user	user defined
8	256	for user	user defined
9	512	for user	user defined
10	1024	for user	user defined
11	2048	for user	user defined

12	4096	for user	user defined
13	8192	for user	user defined
14	16384	for user	user defined

STATus:OPERation:DEVIce<keyword>

Applicable Models: All

Summarizes conditions in the OPERation:DEVIce event registers.

<keyword>	Example
:CONDition?	STAT:OPER:DEV:COND?
:ENABle <bits>	STAT:OPER:DEV:ENAB 16
[:EVENT]?	STAT:OPER:DEV?
:NTRansition <bits>	STAT:OPER:DEV:NTR 16
:PTRansition <bits>	STAT:OPER:DEV:PTR 0

Bit	Weight	Description	Bit is set to 1 when the following conditions exist:
0	1	Unused	
1	2	Unused	
2	4	Unused	
3	8	Unused	
4	16	Sweep Completed	When sweep is complete
5	32	Unused	
6	64	Unused	
7	128	Unused	
8	256	Unused	
9	512	Unused	
10	1024	Unused	
11	2048	Unused	
12	4096	Unused	
13	8192	Unused	
14	16384	Unused	

STATus:PRESet

Applicable Models: All

(Write-only) Initializes all the status registers.

Example `STAT:PRES`

STATus:QUESTIONable:<keyword>

Applicable Models: All

Summarizes conditions that monitor the quality of measurement data.

<keyword> **Example**

:CONDition? `STAT:QUES:COND?`

:ENABle `STAT:QUES:ENAB 1024`
<bits>

[:EVENT]? `STAT:QUES?`

:NTRansition `STAT:QUES:NTR 1024`
<bits>

:PTRansition `STAT:QUES:PTR 0`
<bits>

Bit	Weight	Description	Bit is set to 1 when the following conditions exist:
9	512	Integrity Reg summary	any enabled bit in the Integrity event register is set to 1
10	1024	Limit Registers summary	any enabled bit in the Limit event registers is set to 1
11	2048	Define Registers summary	any enabled bit in the Define event registers is set to 1

STATus:QUEStionable:DEFine<keyword>

Applicable Models: N522xB, N523xB, N524xB, M937xA, P937xA

Summarizes conditions in the Questionable:Define:User<1|2|3> event registers.

<keyword>	Example
:CONDition?	STAT:QUES:DEF:COND?
:ENABle <bits>	STAT:QUES:DEF:ENAB 1024
[:EVENT]?	STAT:QUES:DEF?
:NTRansition <bits>	STAT:QUES:DEF:NTR 1024
:PTRansition <bits>	STAT:QUES:DEF:PTR 0

Bit	Weight	Description	Bit is set to 1 when the following conditions exist:
1	2	USER1	any bit in the USER1 event register is set to 1
2	4	USER2	any bit in the USER2 event register is set to 1
3	8	USER3	any bit in the USER3 event register is set to 1

STATus:QUEStionable:DEFine:USER<1|2|3><keyword>

Applicable Models: N522xB, N523xB, N524xB, M937xA, P937xA

Monitors conditions that you define and map in any of the three QUES:DEF:USER event registers.

<keyword>	Example
:CONDition?	STAT:QUES:DEF:USER1:COND?
:ENABle <bits>	STAT:QUES:DEF:USER1:ENABle 1024
[:EVENT]?	STAT:QUES:DEF:USER1?
:MAP <bit>,<error>	STAT:QUES:DEF:USER1:MAP 0,-113 'when error -113 occurs, bit 0 in USER1 will set to 1.'
:NTRansition <bits>	STAT:QUES:DEF:USER1:NTR 1024
:PTRansition <bits>	STAT:QUES:DEF:USER1:PTR 0

Bit	Weight	Description	Bit is set to 1 when the following conditions exist:
0	1	for user	user defined
1	2	for user	user defined
2	4	for user	user defined
3	8	for user	user defined
4	16	for user	user defined
5	32	for user	user defined
6	64	for user	user defined
7	128	for user	user defined
8	256	for user	user defined
9	512	for user	user defined
10	1024	for user	user defined
11	2048	for user	user defined
12	4096	for user	user defined
13	8192	for user	user defined
14	16384	for user	user defined

STATus:QUEStionable:INTegrity <keyword>

Applicable Models: All

Summarizes conditions in the Measurement Integrity register.

<keyword>	Example
:CONDition?	STAT:QUES:INT:COND?
:ENABle <bits>	STAT:QUES:INT:ENAB 1024
[:EVENT]?	STAT:QUES:INT?
:NTRansition <bits>	STAT:QUES:INT:NTR 1024
:PTRansition <bits>	STAT:QUES:INT:PTR 0

Bit	Weight	Description	Bit is set to 1 when the following conditions exist:
0	1	Measurement Summary	any bit in the Measurement Integrity event register is set to 1
2	4	Hardware Summary	any bit in the Hardware event register is set to 1

STATus:QUESTionable:INTEGRity:HARDware<keyword>

Applicable Models: N522xB, N523xB, N524xB, M937xA, P937xA

Monitors the status of hardware failures.

<keyword>	Example
:CONDition?	STAT:QUES:INT:HARD:COND?
:ENABle <bits>	STAT:QUES:INT:HARD:ENAB 1024
[:EVENT]?	STAT:QUES:INT:HARD?
:NTRansition <bits>	STAT:QUES:INT:HARD:NTR 1024
:PTRansition <bits>	STAT:QUES:INT:HARD:PTR 0

Bit	Weight	Description	Bit is set to 1 when the following conditions exist:
1	2	Phase Unlock	the source has lost phaselock, possibly caused by a reference channel open or a hardware failure.
2	4	Unleveled	the source power is unleveled. This could be caused by a source set for more power than it can deliver at the tuned frequency. Or it could be caused by a hardware failure.
3	8	Not used	N/A
4	16	EE Write Failed	an attempted write to the EEPROM has failed, possibly caused by a hardware failure.
5	32	Not used	N/A
6	64	Ramp Cal Failed	the analyzer was unable to calibrate the analog ramp generator due to a possible hardware failure.
7	128	Not used	N/A

STATus:QUESTIONable:INTEgrity:MEASurement<n> <keyword>

Applicable Models: All

Note: This register can be used ONLY with standard S-parameter measurements.

Monitors the lag between changing a channel setting and when the data is ready to query.

When you change the channel state (start/stop freq, bandwidth, and so forth), then the questionable bit for that channel is set. This indicates that your desired channel state does not yet match the data you would get if querying a data trace. When the next sweep is complete (without aborting in the middle), and the data trace matches the channel state that produced it, the bit is cleared for that channel.

<n> Measurement register number. Choose from 1 to 3

<keyword> **Example**

:CONDition?	STAT:QUES:INT:MEAS1:COND?
:ENABle <bits>	STAT:QUES:INT:MEAS2:ENAB 1024
[:EVENT]?	STAT:QUES:INT:MEAS3?
:NTRansition <bits>	STAT:QUES:INT:MEAS2:NTR 1024
:PTRansition <bits>	STAT:QUES:INT:MEAS1:PTR 0

		Measurement Register <n>			
Bit	Weight	1	2	3	Bit is set to 1 when the following conditions exist:
0	1	1	Summary from Meas Reg 3		a setting change on this channel has occurred and the data does not yet reflect that change.
1	2	2	15	29	a setting change on this channel has occurred and the data does not yet reflect that change.
2	4	3	16	30	a setting change on this channel has occurred and the data does not yet reflect that change.
3	8	4	17	31	a setting change on this channel has occurred and the data does not yet reflect that change.
4	16	5	18	32	a setting change on this channel has occurred and the data does not yet reflect that change.
5	32	6	19		a setting change on this channel has occurred and the data does not yet reflect that change.

6	64	7	20		a setting change on this channel has occurred and the data does not yet reflect that change.
7	128	8	21		a setting change on this channel has occurred and the data does not yet reflect that change.
8	256	9	22		a setting change on this channel has occurred and the data does not yet reflect that change.
9	512	10	23		a setting change on this channel has occurred and the data does not yet reflect that change.
10	1024	11	24		a setting change on this channel has occurred and the data does not yet reflect that change.
11	2048	12	25		a setting change on this channel has occurred and the data does not yet reflect that change.
12	4096	13	26		a setting change on this channel has occurred and the data does not yet reflect that change.
13	8192	14	27		a setting change on this channel has occurred and the data does not yet reflect that change.
14	16384	Summary from Meas Reg 2	28		a setting change on this channel has occurred and the data does not yet reflect that change.

STATus:QUEStionable:LIMit<n> <keyword>

Applicable Models: N522xB, N523xB, N524xB, M937xA, P937xA

Monitors and summarizes the status of limit line failures. When a trace fails, the representative bit is set to 1.

Bit 0 is used to summarize failures in the registers that follow. For example, Limit Register 3, bit 0, summarizes the failures from registers 4 through 42.

All enable bits are set to 1 by default.

To find the measurement number, use **Calc:Par:Mnum**

<n> Limit register: Choose from 1 to 42.

<keyword> **Example**

:CONDition? **STAT:QUES:LIM4:COND?**

:ENABLE <bits> **STAT:QUES:LIM1:ENAB 1024**

[:EVENT]?	STAT : QUES : LIM3 ?
:NTRansition <bits>	STAT : QUES : LIM2 : NTR 1024
:NTRansition?	STAT : QUES : LIM1 : NTR ?
:PTRansition <bits>	STAT : QUES : LIM5 : PTR 0
:PTRansition?	STAT : QUES : LIM1 : PTR ?

		Limit Register <n>											Bit is set to 1 when the following conditions exist:
Bit	Weight	1	2	3	4	5	6	7	8	...	41	42	
0	1	2-42	3-42	4-42	5-42	6-42	7-42	8-42	9-42	...	42	--	Summary Bit - If any bit from that register fails, it propagates to the previous register, bit 0.
		Trace Numbers											
1	2	1	15	29	43	57	71	85	99	...	561	575	any point on trace fails the limit test
2	4	2	16	30	44	58	72	86	100	...	562	576	any point on trace fails the limit test
3	8	3	17	31	45	59	73	87	101	...	563	577	any point on trace fails the limit test
4	16	4	18	32	46	60	74	88	102	...	564	578	any point on trace fails the limit test
5	32	5	19	33	47	61	75	89	103	...	565	579	any point on trace fails the limit test
6	64	6	20	34	48	62	76	90	104	...	566	580	any point on trace fails the limit test
7	128	7	21	35	49	63	77	91	105	...	567	--	any point on trace fails the limit test
8	256	8	22	36	50	64	78	92	106	...	568	--	any point on trace fails the limit test
9	512	9	23	37	51	65	79	93	107	...	569	--	any point on trace fails the limit test
10	1024	10	24	38	52	66	80	94	108	...	570	--	any point on trace fails the limit test

11	2048	11	25	39	53	67	81	95	109	...	571	--	any point on trace fails the limit test
12	4096	12	26	40	54	68	82	96	110	...	572	--	any point on trace fails the limit test
13	8192	13	27	41	55	69	83	97	111	...	573	--	any point on trace fails the limit test
14	16384	14	28	42	56	70	84	98	112	...	574	--	any point on trace fails the limit test

To determine Register, Bit number, and Weight for trace numbers between 113 and 560 (not shown in the above table) use the following calculations.

The limit status for trace numbers higher than 580 can NOT be tracked.

The following example calculates the Register, Bit number, and Bit Weight for trace # 400:

- To determine Limit **Register** number, use $((\text{Trace \#} - 1) / 14) + 1$.
- To determine Limit **Bit Number**, use the **remainder** +1 of the above calculation.
- $((400-1)/14) + 1 = \text{Register\# r+1Bit}$
 - $399/14 = 28 \text{ r}7$
 - $28+1= \text{Register } 29$
 - $7+1= \text{Bit number } 8$
- To determine Limit **Bit Weight**: Use above table. For example: Bit 8 = **256**

STATus:QUEStionable:LSUMmary:<keyword>

Applicable Models: All

Summary register of limit test, ripple test and bandwidth test. bit 0: summary bit for the limit test. bit 1: summary bit for the ripple limit test. bit 2: summary bit for the bandwidth limit test.

<keyword>	Example
:CONDition?	STAT:QUES:LSUM:COND?
:ENABle <bits>	STAT:QUES:LSUM:ENAB 8
[:EVENT]?	STAT:QUES:LSUM?
:NTRansition <bits>	STAT:QUES:LSUM:NTR 8
:PTRansition <bits>	STAT:QUES:LSUM:PTR 0

STATus:QUESTionable:LSUMmary:BLIMit <n>:<keyword>

Applicable Models: All

Monitors and summarizes the status of bandwidth limit line failures. When a trace fails, the representative bit is set to 1.

Bit 0 is used to summarize failures in the registers that follow. Refer the STATus:QUESTionable:LSUMmary:LIMit for the trace number information.

All enable bits are set to 1 by default.

To find the measurement number, use [Calc:Par:Mnum](#)

<n> Bandwidth Limit register. Choose from 1 to 42..

<keyword> **Example**

:CONDition? STAT:QUES:LSUM:BLIM:COND?

:ENABLE <bits> STAT:QUES:LSUM:BLIM:ENAB 1024

[[:EVENT]?) STAT:QUES:LSUM:BLIM?

:NTRansition <bits> STAT:QUES:LSUM:BLIM:NTR 1024

:PTRansition <bits> STAT:QUES:LSUM:BLIM:PTR 0

STATus:QUESTionable:LSUMmary:LIMit<n>: <keyword>

Applicable Models: All

Monitors and summarizes the status of limit line failures. When a trace fails, the representative bit is set to 1.

Bit 0 is used to summarize failures in the registers that follow. For example, Limit Register 3, bit 0, summarizes the failures from registers 4 through 42.

All enable bits are set to 1 by default.

To find the measurement number, use [Calc:Par:Mnum](#)

<n> Limit register. Choose from 1 to 42.

<keyword> **Example**

:CONDition? STAT:QUES:LSUM:LIM4:COND?

:ENABLE <bits> STAT:QUES:LSUM:LIM1:ENAB 1024

[[:EVENT]?) STAT:QUES:LSUM:LIM3?

:NTRansition <bits> STAT:QUES:LSUM:LIM2:NTR 1024

:NTRansition? STAT:QUES:LSUM:LIM1:NTR?

:PTRansition <bits> STAT:QUES:LSUM:LIM5:PTR 0

:PTRansition? STAT:QUES:LSUM:LIM1:PTR?

		Limit Register <n>											
Bit	Weight	1	2	3	4	5	6	7	8	...	41	42	Bit is set to 1 when the following conditions exist:
0	1	2-42	3-42	4-42	5-42	6-42	7-42	8-42	9-42	...	42	--	Summary Bit - If any bit from that register fails, it propagates to the previous register, bit 0.
		Trace Numbers											
1	2	1	15	29	43	57	71	85	99	...	561	575	any point on trace fails the limit test
2	4	2	16	30	44	58	72	86	100	...	562	576	any point on trace fails the limit test
3	8	3	17	31	45	59	73	87	101	...	563	577	any point on trace fails the limit test
4	16	4	18	32	46	60	74	88	102	...	564	578	any point on trace fails the limit test
5	32	5	19	33	47	61	75	89	103	...	565	579	any point on trace fails the limit test
6	64	6	20	34	48	62	76	90	104	...	566	580	any point on trace fails the limit test
7	128	7	21	35	49	63	77	91	105	...	567	--	any point on trace fails the limit test
8	256	8	22	36	50	64	78	92	106	...	568	--	any point on trace fails the limit test
9	512	9	23	37	51	65	79	93	107	...	569	--	any point on trace fails the limit test
10	1024	10	24	38	52	66	80	94	108	...	570	--	any point on trace fails the limit test

11	2048	11	25	39	53	67	81	95	109	...	571	--	any point on trace fails the limit test
12	4096	12	26	40	54	68	82	96	110	...	572	--	any point on trace fails the limit test
13	8192	13	27	41	55	69	83	97	111	...	573	--	any point on trace fails the limit test
14	16384	14	28	42	56	70	84	98	112	...	574	--	any point on trace fails the limit test

To determine Register, Bit number, and Weight for trace numbers between 113 and 560 (not shown in the above table) use the following calculations.

The limit status for trace numbers higher than 580 can NOT be tracked.

The following example calculates the Register, Bit number, and Bit Weight for trace # 400:

- To determine Limit **Register** number, use $((\text{Trace \#} - 1) / 14) + 1$.
- To determine Limit **Bit Number**, use the **remainder** +1 of the above calculation.
- $((400-1)/14) + 1 = \text{Register\# r+1Bit}$
 - $399/14 = 28 \text{ r}7$
 - $28+1= \text{Register } 29$
 - $7+1= \text{Bit number } 8$
- To determine Limit **Bit Weight**: Use above table. For example: Bit 8 = **256**

STATus:QUESTIONable:LSUMmary:RLIMit <cnum>:<keyword>

Applicable Models: All

Monitors and summarizes the status of ripple limit line failures. When a trace fails, the representative bit is set to 1.

Bit 0 is used to summarize failures in the registers that follow. Refer the STATus:QUESTIONable:LSUMmary:LIMit for the trace number information.

All enable bits are set to 1 by default.

To find the measurement number, use **Calc:Par:Mnum**

<n> Ripple limit channel status register. Choose from 1 to 42.

<keyword> **Example**

:CONDition?	STAT:QUES:LSUM:RLIM:COND?
:ENABle <bits>	STAT:QUES:LSUM:RLIM:ENAB 1024
[:EVENT]?	STAT:QUES:LSUM:RLIM?
:NTRansition <bits>	STAT:QUES:LSUM:RLIM:NTR 1024
:PTRansition <bits>	STAT:QUES:LSUM:RLIM:PTR 0

Standard Event Status Register

Applicable Models: All

Monitors "standard" events that occur in the analyzer. This register can only be cleared by:

- a Clear Command (*CLS).
- reading the Standard Enable Status Register (*ESE?).
- a power-on transition. The analyzer clears the register and then records any transitions that occur, including setting the Power On bit (7).

Commands	Description
----------	-------------

*ESE?	Reads the settings of the standard event ENABLE register.
*ESE <bits>	Sets bits in the standard event ENABLE register. The current setting is saved in non-volatile memory. <bits> The sum of weighted bits in the register. Use *ESE 0 to clear the enable register.
*ESR?	Reads and clears the EVENT settings in the Standard Event Status register.
*OPC	Sets bit 0 when the overlapped command is complete. (see Understanding Command Synchronization / OPC).
*OPC?	Operation complete query - read the Operation Complete bit (0).

Bit	Weight	Description	Bit is set to 1 when the following conditions exist:
0	1	Operation Complete	the two following events occur in order : <ol style="list-style-type: none"> 1. the *OPC command is sent to the analyzer 2. the analyzer completes all pending overlapped commands
1	NA	Request Control	Not Supported - the analyzer application is not configured to control GPIB operation
2	4	Query Error	a query error is detected indicating: - an attempt to read data from the output queue when no data was present OR - data in the output queue was lost, as in an overflow
3	8	Instrument Dependent Error	Set to "1" when an error has occurred and the error is not a command, query, or execution error.
4	16	Execution Error	an execution error is detected indicating: - a <PROGRAM DATA> element was outside the legal range or inconsistent with the operation of the analyzer OR - the analyzer could not execute a valid command due to some internal condition
5	32	Command Error	a command error is detected indicating that the analyzer received a command that: <ul style="list-style-type: none"> • did not follow proper syntax • was misspelled • was an optional command it does not implement
6	64	Not used	Always 0
7	128	Power ON	Power to the analyzer has been turned OFF and then ON since the last time this register was read.

Status Byte Register

Applicable Models: All

Summarizes the states of the other registers and monitors the VNA output queue. It also generates **service requests**. The Enable register is called the Service Request Enable Register.

Commands	Description
*CLS	Clears ALL "event" registers and the SCPI Error / Event queue. The corresponding ENABLE registers are unaffected.
*STB?	Reads the value of the analyzer's status byte. The byte remains after being read.
*SRE?	Reads the current state of the Service Request Enable Register.
*SRE <num>	Sets bits in the Service Request Enable register. The current setting of the SRE register is stored in non-volatile memory. Use *SRE 0 to clear the enable.
	<num> Combined value of the weights for bits to be set.

Bit	Weight	Description	Bit is set to 1 when the following conditions exist:
2	4	Error / Event queue Summary (EAV)	the Error / Event queue is not empty. To read the error message, use SYST:ERR?
3	8	Questionable Register Summary	any enabled bit in the questionable event status register is set to 1
4	16	Message Available	the output queue is not empty
5	32	Standard Event Register Summary	any enabled bit in the standard event status register is set to 1
6	64	Request Service	any of the other bits in the status byte register is set to 1 (used to alert the controller of a service request within the analyzer). This bit cannot be disabled.
7	128	Operation Register Summary	any enabled bit in the standard operation event status register is set to 1

System Commands

Controls and queries settings that affect the VNA system.

```
SYSTem:  
ABORt:THReshold  
ACTive  
  | CHANnel  
  | MEASurement  
    | NUMBer?  
  | SHEet?  
BEEPer  
  | COMPLete:IMMediate  
  | STATe  
  | VOLume  
  | WARning:IMMediate  
CAL:ALL More commands  
CAL:PHASe More commands  
CAPability More commands  
CHANnels  
  | CATalog?  
  | COUPl[:STATe]  
  | COUPl:GROup  
  | COUPl:PARallel[:ENABLE]  
  | COUPl:PARallel:STATe?  
  | NOISe:PARallel[:ENABLE]  
  | NOISe:PARallel:GROup  
  | NOISe:PARallel:GROup:LIST  
  | NOISe:PARallel:STATe?  
  | DELete  
  | HOLD  
  | RESume  
  | SINGle  
    | SINGle:COMBine  
CLOCK[:STATe]  
COMMunicate More commands  
CONFigure  
  | BIT?  
  | DIRectory  
  | MWAVE More commands  
  | REVision  
    | CPU?  
    | DSP?  
    | DSPFpga?  
CONFfiguration:EDEVice More commands
```

CORRection
| **INTerpolate:LINear More commands**
| **WIZard[:IMMediate]**

DATE?
DISK:REVision?
ERRor?
| **COUNt?**
| **REPort**
| **SUNLeveled**

FCORrection:CHANnel:COUPler[:STATe]

FIFO More commands
FPReset
ISPControl
| **[:STATe]**

MACRO:COPI
| **CHANnel[:TO]**
| **SOURce**
| **CHANnel**
| **STATe**

MCLass
| **CATalog?**
| **PARAmeter:CATalog?**

MEASure
| **CATalog?**
| **NAME?**
| **TRACe?**
| **WINDow?**

PERSONa
| **MANufacturer**
| **DEFault**
| **MODEl**
| **DEFault**

POFF
POWER:
| **LIMit**
| **LOCK**
| **STATe**

PREFerences More commands
PRESet
SECurity
| **[LEVel]**

SET
SHEets:CATalog?
SHORteut
| **ARGuments**
| **DELeTe**
| **EXECute**
| **PATH**

TITLE TIME? TOUCHscreen[:STATe] UNCertainty More commands UPReset FPANel[:STATe] LOAD[:FILE] SAVE[:STATe] WINDows CATalog?
--

Click on a **red** keyword to view the command details.

See Also

- Referring to Traces Channels Windows and Meas Using SCPI
- Learn about VNA Preferences
- Example Programs
- Synchronizing the Analyzer and Controller
- SCPI Command Tree

SYSTEM:ABORt:THReshold <value>

Applicable Models: All

(Read-Write) When a VNA setting is made while a sweep is in progress, the sweep is immediately aborted by default. This command allows you to change that behavior by specifying a time threshold. When a setting change is made during a sweep and if the total sweep time is less than the threshold time, then the sweep is allowed to finish instead of immediately aborting.

In general, VNA setting changes that could cause an aborted sweep are changes that affect how a measurement is made, such as changes in stimulus conditions.

For example, with a threshold setting of 60 seconds:

- Sweeps that require 60 seconds or less from start to finish will be allowed to complete if a VNA setting change is made at any time during the sweep.
- Sweeps that require MORE than 60 seconds from start to finish will be immediately aborted when a VNA

setting change is made at any time during the sweep.

Notes:

- Preset clears this setting.
- Save state saves this setting.
- Sweep times are estimated.
- This setting affects ALL channels.

Parameters

<value> Threshold time in seconds. Set to 0 to immediately abort a sweep when a VNA setting is made.

Examples

```
SYST:ABOR:THR 10
```

```
'When a setting is made during a sweep, if that sweep requires less than 10 seconds more to complete, it will be allowed to finish instead of aborting.'
```

Query Syntax SYSTem:ABORT:THReshold?

Default 0 - No threshold time; all sweeps are immediately aborted.

SYSTem:ACTive:CHANnel?

Applicable Models: All

(Read-only) Returns the number of the active channel. The active channel is the channel number that contains the active measurement. The active measurement is the trace that has a highlighted **Tr#** in the Trace Status area.

If there is no active channel, 0 is returned.

Examples

```
SYST:PRES
```

```
SYST:ACT:CHAN?
```

```
'Returns 1'
```

Return Type Integer

Default Not Applicable

SYSTem:ACTive:MEASurement?

Applicable Models: All

(Read-only) Returns the name of the active measurement. While looking at the VNA display, the active measurement is the trace that has a highlighted **Tr#** in the Trace Status area. Only displayed measurements can be active.

If there is no active measurement, " " (empty string) is returned.

Examples

```
SYST:PRES
SYST:ACT:MEAS?

'Returns "CH1_S11_1"
```

Return Type String

Default Not Applicable

SYSTem:ACTive:MEASurement:NUMBer? <mnum>

Applicable Models: All

(Read-only) Returns the active measurement number.

Parameters

<mnum> Measurement number for each measurement. There must be a selected measurement on the trace. If unspecified, <mnum> is set to 1.

Examples

```
SYST:PRES
SYST:ACT:MEAS:NUMB?
```

Return Type Integer

Default 1

SYSTem:ACTive:SHEet?

Applicable Models: E5080A

(Read-only) Returns the active sheet number.

Examples

```
SYST:ACT:SHE?

'Returns "1"
```

Return Type String

Default 1

SYSTem:BEEPer:COMPLete:IMMEdiate

Applicable Models: All

(Write-only) This command generates a beep for the notification of the completion of an operation.

Parameters None

Examples `SYST:BEEP:COMP:IMM`

Query Syntax Not Applicable

Default Not Applicable

SYSTem:BEEPer:STATe <num>

Applicable Models: All

(Read-Write) Sets the beeper on or off.

Parameters

<bool> ON (1) or OFF (0).

Examples `SYST:BEEP:STAT 1`

Query Syntax SYSTem:BEEPer:STAT?

Default 0

SYSTem:BEEPer:VOLUme <num>

Applicable Models: N522xB, N523xB, N524xB, M937xA, M9485A, P937xA

(Read-Write) Sets and reads the volume of the internal speaker.

Parameters

<num> Relative volume of the internal speaker.

Choose a volume between 0 (off) and 100.

Examples `SYST:BEEP:VOL 5`

`system:beeper:volume`

Query Syntax SYSTem:BEEPer:VOLUme?

Default 0

SYSTem:BEEPer:WARNIng:IMMEdiate

Applicable Models: All

(Write-only) This command generates a beep for the notification of warning/limit test results.

Parameters None

Examples `SYST:BEEP:WARN:IMM`

Query Syntax Not Applicable

Default Not Applicable

SYSTem:CHANnels:CATalog?

Applicable Models: All

(Read-only) Returns the channel numbers currently in use.

Examples

```
SYST:CHAN:CAT?  
  
system:channels:catalog?  
  
'Returns:  
  
"1,2,3"
```

Return Type String of comma-separated numbers

Default Not Applicable

SYSTem:CHANnels:COUPl[e]:STATe] <bool>

Applicable Models: All

(Read-Write) Sets and reads the state of channel coupling. This causes the VNA to emulate Keysight 8720 channel coupling.

When set to ON, all existing S-parameter channels receive the stimulus settings of the active channel. Subsequent changes made to any coupled channel are changed on all coupled channels.

Channels with applications such as SMC, VMC, GCA, Noise, IMD are not affected.

Coupling is primarily aimed at stimulus settings (such as start, stop, points, power) but also applies to many trigger settings and to Cal Set pointers.

Parameters

<bool> **ON** (or 1) Channels are coupled

OFF (or 0) Channels are NOT coupled

Examples `SYST:CHAN:COUP 1`

`system:channels:couple:state OFF`

Query Syntax `SYSTem:CHANnels:COUPle[:STATe]?`

Default OFF

SYSTem:CHANnels:COUPle:GROup <iarray>

Applicable Models: N522xB, N523xB, N524xB, M937xA, M9485A, P937xA

(Read-Write) Sets and reads the group of channels for the mult-DUT parallel measurement.

Parameters

<array> {<number of group>, <start channel No.>, <end channel No.>, ... }

The first item means number or groups.

Next pairs show start/end channel numbers of the group. 1 pair for 1 group.

Example:

{0} Global coupling (default setting)

{1, 1,4} Couples channel 1-4

{2, 1,3, 5,7} Couples channel 1-3 and 5-7 independently

Examples `SYST:CHAN:COUP:GRO 2,1,3,5,7`

`system:channels:couple:group 1,1,4`

Query Syntax `SYSTem:CHANnels:COUPle:GROup?`

Default 0

SYSTem:CHANnels:COUPle:PARAllel[:ENABLE] <bool>

Applicable Models: N522xB, N523xB, N524xB, M937xA, M9485A, P937xA

(Read-Write) Sets and reads the Multi DUT parallel measurement state. SYST:CHAN:COUP should be also turned on when Multi DUT parallel measurement is performed.

Parameters

<bool> **ON** (or 1) Multi DUT parallel measurement are enabled

OFF (or 0) Multi DUT parallel measurement are NOT enabled

Examples

```
SYST:CHAN:COUP:PAR 1
```

```
system:channels:couple:parallel OFF
```

Query Syntax SYSTem:CHANnels:COUPle:PARallel[:ENABLE]?

Default OFF

SYSTem:CHANnels:COUPle:PARallel:STATe? <value>

Applicable Models: N522xB, N523xB, N524xB, M937xA, M9485A, P937xA

(Read Only) Gets the information if the parallel measurement is executed in the last sweep, for the targeted channel.

Parameters

<value> Channel number

Examples

```
SYST:CHAN:COUP:PAR:STAT? 1
```

```
system:channels:couple:parallel:state? 2
```

Query Syntax SYSTem:CHANnels:COUPle:PARallel:STATe?

Default Not Applicable

SYSTem:CHANnels:NOISe:PARallel[:ENABLE] <bool>

Applicable Models: M9485A

(Read-Write) Sets and reads the Noise Figure Dual-band Parallel Measurement state. SYST:CHAN:COUP should be also turned on when Noise Figure Dual-band Parallel Measurement is performed. This function is supported only for M9385A which has options both 028 and 720.

Parameters

- <bool> **ON** (or 1) Noise Figure Dual-band parallel measurement are enabled
- OFF** (or 0) Noise Figure Dual-band parallel measurement are NOT enabled

Examples

```
SYST:CHAN:NOIS:PAR 1
system:channels:noise:parallel OFF
```

Query Syntax SYSTem:CHANnels:NOISe:PARAllel[:ENABLE]?

Default OFF

SYSTem:CHANnels:NOISe:PARAllel:GROup <iarray>

Applicable Models: M9485A

(Read-Write) Sets and reads the group of channels for the Noise Figure Dual-band Parallel Measurement. This function is supported only for M9385A which has options both 028 and 720.

Parameters

- <iarray> <num of groups>, <first channel of group #1>, <second channel of group #1>, <first channel of group #2>, <second channel of group #2>, ... , <first channel of group #n>, <second channel of group #n>

Two consecutive channels can be assigned into one group.

Example:

- {1, 1,2} measures NF channels 1 and 2 in parallel.
- {2, 3,4, 8,9} measures NF channels 3 and 4, then 8 and 9 in parallel.

Examples

```
SYST:CHAN:NOIS:PAR:GRO 1,1,2
system:channels:noise:parallel:group 1,1,2
```

Query Syntax SYSTem:CHANnels:NOISe:PARAllel:GROup?

Default 0

SYSTem:CHANnels:NOISe:PARAllel:GROup:LIST <iarray>

Applicable Models: M9485A

(Read-Write) Sets and reads the group of channels for the Noise Figure Dual-band Parallel Measurement. This command allows you to setup any two channels in one group. This function is supported only for M9385A which has options both 028 and 720.

Parameters

<iarray> <num of groups>,
<num of channels in group #1>, <channel>, <channel>,...
<num of channels in group #2>, <channel>, <channel>,...

Several channels can be assigned to one group

Example:

{1, 2,1,3} measures NF channels 1 and 3 in parallel.
{2, 2,1,3, 2,5,7} measures NF channels 1 and 3, then 5 and 7 in parallel.

Examples

```
SYST:CHAN:NOIS:GRO:PAR:LIST 2,3,1,3,2,5,7
```

```
system:channels:noise:parallel:group:list 2,2,1,3,2,5,7
```

Query Syntax SYSTem:CHANnels:NOISe:PARAllel:GROup:LIST?

Default 0

SYSTem:CHANnels:NOISe:PARAllel:STATe? <value>

Applicable Models: M9485A

(Read Only) Gets the information if the parallel measurement is executed in the last sweep, for the targeted channel. This function is supported only for M9385A which has options both 028 and 720.

Parameters

<value> Channel number

Examples

```
SYST:CHAN:NOIS:PAR:STAT? 1
```

```
system:channels:noise:parallel:state? 2
```

Query Syntax SYSTem:CHANnels:NOISe:PARAllel:STATe?

Default Not Applicable

SYSTem:CHANnels:DELeTe <value>

Applicable Models: All

(Write-only) Deletes the specified channel.

Parameters

<value> Channel number to delete

Examples SYST:CHAN:DEL 2

Query Syntax Not Applicable

Default Not Applicable

SYSTem:CHANnels:HOLD

Applicable Models: All

(Write-only) Places all channels in hold mode. To place a single channel in hold mode, use SENS:SWE:MODE .

Examples SYST:CHAN:HOLD

Query Syntax Not Applicable

Default Not Applicable

SYSTem:CHANnels:RESume

Applicable Models: All

(Write-only) Resumes the trigger mode of all channels that was in effect before sending SYSTem:CHANnels:HOLD (must be sent before SYST:CHAN:RESume).

Examples SYST:CHAN:RES

Query Syntax Not Applicable

Default Not Applicable

SYSTem:CHANnels:SINGle <chanNums>

Applicable Models: N522xB, N523xB, N524xB, M937xA, P937xA

(Write-only) Sets up multiple channels for manual trigger and provides a method of triggering multiple channels using manual trigger. There are several prerequisites for using this command:

- Manual trigger mode must be used (INIT:CONT OFF)
- All channels in HOLD (SENS:SWE:MODE HOLD), not just the channels being triggered
- No acquisitions currently running (instrument is NOT sweeping - see ABORT:THReshold)
- All specified channels must exist

If the above conditions are not met, then the command will generate an error which describes what is at fault. If the above conditions are met, then the trigger count for the specified channels is set to 1. Issuing an *OPC? query will indicate when the first channel is armed (ready for manual trigger). It is not necessary to wait for *OPC? before sending INIT:IMM to trigger the first channel. After the first channel is triggered, *OPC? will indicate when all armed channels have finished acquiring data.

Channels will be sorted by channel number, and acquire in order from lowest channel number first to highest channel number last.

Parameters

<chanNums> Existing comma separated list of channel numbers.

Examples

```
SYST:CHAN:SING 1,3,4
System:channels:single 1,3,4
```

Query Syntax Not Applicable

Default Not Applicable

SYSTEM:CHANNELS:SINGLE:COMBine <chanNums>

Applicable Models: M937xA, P937xA

(Write-only) Sets the trigger count on the list of channels to ONE, and then combines the channels into a single efficient acquisition. The index line stays high during the entire acquisition.

Parameters

<chanNums> Existing comma separated list of channel numbers to combine.

Examples

```
SYST:CHAN:SING:COMB 1,3,4
System:channels:single:combine 1,3,4
```

Query Syntax Not Applicable

Default Not Applicable

SYSTem:CLOCK[:STATe] <bool>

Applicable Models: All

(Read-Write) Sets and reads the clock visibility state in the VNA status bar.

Parameters

<bool> **ON** (or 1) Clock is visible in the VNA status bar.

OFF (or 0) Clock is NOT visible in the VNA status bar.

Examples

```
SYST:CLOC 1
system:clock:state OFF
```

Query Syntax SYSTem:CLOCK[:STATe]?

Default ON

SYSTem:CONFigure <model>,<address>

Applicable Models: N522xB, N523xB, N524xB, M937xA, P937xA

(Write-only) Restarts as an "N-port" VNA using the specified multiport test set.

Learn more about VNA Multiport capability.

See other commands to configure multiport test sets.

Parameters

<model> String - Model of the test set with which to restart.

Use "Native" to restart without a test set.

To see a list of supported test sets, use SENS:MULT:CAT?

<address> Numeric - GPIB Address of the test set. Ignored when model = "Native".

Examples

```
SYST:CONF "NATIVE",0
system:configure "N44xx",18
```

Query Syntax Not Applicable

Default Not Applicable

SYSTem:CONFigure:BIT?

Applicable Models: All

(Read-only) Returns whether VNA FW is 32 bit application or 64 bit application. Returns the word size (32 or 64).

Parameters None

Examples SYST:CONF:BIT?

Return Type String

Default Not Applicable

SYSTEM:CONFigure:DIRectory? <char>

Applicable Models: All

(Read-only) Returns the directory path location for the specified file type.

Parameters None

<char> Type of file. Choose from:

STATE - This is the location for the storage of state files.

APPLication - This is the location of the VNA firmware executable files.

SUPPort - This is the location of private support files for the VNA firmware.

See these file locations .

Example SYST:CONF:DIR? SUPP

Return Type String

Default Not applicable

SYSTEM:CONFigure:REVision:CPU?

Applicable Models: N522xB, N523xB, N524xB, M937xA, E5080A, P937xA

(Read-only) Returns a number that corresponds to the VNA CPU speed that is visible in the Help, About Network Analyzer dialog box. Learn more.

Use the following table to learn the clock speed using the returned value.

Reported CPU version - Clock speed

1.0 - 266 MHz (PNA), 2.53 GHz dual core (E5080A)

2.0 - 500 MHz

3.0 - 1100 MHz

4.0 - 1600 MHz

5.0 - 2000 MHz

6.0 - 2000 MHz dual core

7.0 - 2200 MHz dual core

Parameters None

Example `SYST:CONF:REV:CPU?`

Return Type String

Default Not applicable

SYSTem:CONFigure:REVision:DSP?

Applicable Models: N522xB, N523xB, N524xB, M937xA, P937xA

(Read-only) Returns the DSP Revision number that is visible in the Help, About Network Analyzer dialog box. Learn more.

Parameters None

Example `SYST:CONF:REV:DSP?`

Return Type String

Default Not applicable

SYSTem:CONFigure:REVision:DSPFpga?

Applicable Models: N522xB, N523xB, N524xB, M937xA, P937xA

(Read-only) Returns the DSP FPGA Revision number that is visible in the Help, About Network Analyzer dialog box. Learn more.

Parameters None

Example `SYST:CONF:REV:DSPF?`

Return Type String

Default Not applicable

SYSTem:CORRection:WIZard[:IMMediate] <char>

Applicable Models: All

(Write-only) Launches either the Calibration Wizard or the Version 2 Calibration Kit File Manager dialog box.

Remote operation returns immediately after the dialog is launched. This is done to avoid timeout issues with I/O protocols such as VISA. Although it is possible to send commands to the VNA while the dialog is open, this is not encouraged. Application programs should wait until the dialog is closed before resuming remote operations.

Parameters

<char> Choose from:

MAIN - Launches the Calibration Wizard which matches the current channel, such as standard S-params, NoiseFigure, GCA, and so forth.

CKIT - Launches the Version 2 Calibration Kit File Manager dialog box.

RESP - Launches the Response Cal Type Selection.

BASic - Launches the Basic Cal dialog.

CALL - Launches the Calibrate All Selected Channels dialog.

These display on the VNA screen.

Examples `SYST:CORR:WIZ MAIN`
`system:correction:wizard:immediate ckit`

Query Syntax Not Applicable

Default MAIN

SYSTEM:DATE?

Applicable Models: All

(Read-only) Returns the system date.

Parameters None

Example SYST:DATE?

Return Type Comma separated numbers representing year, month, day.

Default Not applicable

SYSTEM:DISK:REVISION?

Applicable Models: N522xB, N523xB, N524xB, P937xA, E5080A

(Read-only) Returns the disk drive version. The format is S.XX.YY.ZZ.

Parameters None

Example SYST:DISK:REV?

Return Type Comma separated numbers representing year, month, day.

Default Not applicable

SYSTEM:ERROR?

Applicable Models: All

(Read-only) Returns the next error in the error queue. Each time the analyzer detects an error, it places a message in the error queue. When the SYSTEM:ERROR? query is sent, one message is moved from the error queue to the output queue so it can be read by the controller. Error messages are delivered to the output queue in the order they were received. The error queue is cleared when any of the following conditions occur:

- When the analyzer is switched ON.
- When the *CLS command is sent to the analyzer.
- When all of the errors are read.

If the error queue overflows, the last error is replaced with a "Queue Overflow" error . The oldest errors remain in the queue and the most recent error is discarded.

See list of all SCPI Errors.

Examples `SYST:ERR?`
`system:error?`

Default Not Applicable

SYSTEM:ERROR:COUNT?

Applicable Models: All

(Read-only) Returns the number of errors in the error queue. Use SYST:ERR? to read an error.

See list of all SCPI Errors.

Examples `SYST:ERR:COUN?`
`system:error:count?`

Default Not Applicable

SYSTEM:ERROR:REPORT:SUNLeveled <bool>

Applicable Models: All

(Read-Write) Specifies whether or not to report Source Unleveled errors to the SCPI system error buffer.

This setting will NOT revert to the default (OFF) setting on Instrument Preset. Use the SYSTEM:PREFERENCES:DEFAULT command to reset the preferences to their default settings.

Parameters

<bool> **ON** (or 1) Report Source Unleveled Errors. Read errors from the system error buffer using SYST:ERR?

OFF (or 0) Do NOT report Source Unleveled Errors.

Examples `SYST:ERR:REP:SUNL 1`
`system:error:report:sunleveled ON`

Query Syntax SYSTEM:ERROR:REPORT:UNLeveled?

Default OFF

SYSTEM:FCORrection:CHANNEL<cnum>:COUPLer[:STATE] <char>

Applicable Models: All

(Read-Write) (PNA, M937xA/P937xA) Sets and returns the coupler state. This command is not effective for SMC class. (E5080B, M980xA, P50xxA, M9485A) Turn off the system calibration.

Parameters

<char> Choose from:

OFF

AUTO

Examples

```
SYST:FCOR:CHAN:COUP AUTO
system:fcorrection:channel1:coupler OFF
```

Query Syntax SYSTem:FCORrection:CHANnel<num>:COUPler[:STATe]?

Return Type Character

Default AUTO

SYSTem:FPRreset

Applicable Models: All

(Write-only) Performs a standard Preset , then deletes the default trace, measurement, and window. The VNA screen becomes blank.

Examples

```
SYST:FPR
system:fpreset
```

Default Not applicable

SYSTem:ISPContol[:STATe] <bool>

Applicable Models: All

(Read-Write) Sets and reads the status of the Initial Source Port Control feature (to switch the stimulus output in the trigger hold state to a test port).

Parameters

<bool> **ON** (or 1) Source is outputted only when measurement is done .Source is not outputted during hold state.

OFF (or 0) Source is always outputted.

Examples

```
SYST:ISPC 1
```

```
system:ispcontrol OFF
```

Query Syntax SYSTem:ISPControl[:STATe]?

Default ON (E5080A), OFF(PNA, P50xxA, M980xA, E5080B)

SYSTem:MACRo:COPIY:CHANnel<cnum>[:TO] <num>

Applicable Models: All

(Write-only) Copies ALL settings from <cnum> channel to <num> channel. Learn more about copy channels.

Use SENS:PATH:CONF:COPY to copy ONLY mechanical switch and attenuator settings.

Parameters

<cnum> Channel number to copy settings from. If unspecified, value is set to 1.

<num> Channel number to copy settings to.

Examples

```
SYST:MACR:COPIY:CHAN1 2
```

```
system:macro:copy:channel12:to 3
```

Query Syntax Not Applicable

Default Not Applicable

**SYSTem:MACRo:COPIY:CHANnel<fromChannel>:STATe
<toChannel>,<toWindow>,[<copyScope>]**

Applicable Models: All

(Write-only) Copies settings only, or settings and measurements, traces, markers, and limit lines from an existing channel, <fromChannel>, to a new channel, <toChannel>. Traces can be copied into the Active Window, a user specified window, or a new (next available) window. .

Parameters

- <fromChannel> Channel number to copy settings from. If unspecified, value is 1.
- <toChannel> 0 for next available channel, or N for channel number to copy settings to.
- <toWindow> -1 will create a new window, 0 will use the active window, and N will use the specified window N. <toWindow> is ignored when <copyScope> is "stimulus"
- <copyScope> must be "stimulus" which copies only settings, or "state" which copies settings, measurements, traces, markers, and limit lines.

Examples

```
SYST:MACR:COPY:CHAN1:STAT 2,0,"stimulus"
```

Copies only settings from channel #1 to channel #2. This is equivalent to SYST:MACR:COPY:CHAN1 2

```
SYST:MACR:COPY:CHAN1:STAT 2,-1,"state"
```

Copies settings, measurements, traces, etc. from channel #1 to channel #2. Traces are placed into a new window (next available window), and additional windows will be created as necessary so that all traces are copied.

```
SYST:MACR:COPY:CHAN1:STAT 0,-1
```

Copies settings, measurements, etc. from channel #1 to the next available channel and places traces into the next available new window.

Query Syntax Not Applicable

Default Not Applicable

SYSTem:MACRo:COpy:CHANnel<fromChan>:SOURce <fromPort>,<toChan>,<toPort>

Applicable Models: N522xB, N523xB, N524xB, E5080A, M9485A, P937xA

(Write-only) Copies and applies an existing Source Power Calibration to another channel. Learn more about source power calibration .

Parameters

- <fromChan> Channel number of the existing source power correction.
- <fromPort> Port number of the existing source power correction.
- <toChan> Channel number to which the source power correction will be copied.
- <toPort> Port number to which the source power correction will be applied.

Examples

```
SYST:MACR:COPY:CHAN1:SOUR 1,2,1  
system:macro:copy:channel2:source 2,1,2
```

Query Syntax Not Applicable

Default Not Applicable

SYSTem:MCLass:CATalog?

Applicable Models: All

(Read-only) Returns measurement classes available on the VNA. Learn more about Measurement Classes .

Parameters None

Examples

```
SYST:MCLass:CAT?
```

Return Type String of comma-separated measurement class names. See the complete list of measurement class names .

Default Not Applicable

SYSTem:MCLass:PARAmeter:CATalog? <name>

Applicable Models: All

(Read-only) Returns ALL parameters that are supported by the specified measurement class.

Parameters

<name> String. Measurement Class name. See the complete list of measurement class names .

Examples

```
'Returns all parameters for Gain Compression.  
SYST:MCL:PAR:CAT? "Gain Compression"  
  
Return:  
"S11,S12,S13,S14,S21,S22,S23,S24,S31,S32,S33,S34,S41,S42,S43,S44,A,B,C,D,R,
```

Return Type String of comma-separated parameters

Default Not Applicable

SYSTEM:MEASurement:CATalog? [chan]

Applicable Models: All

(Read-only) Returns ALL measurement numbers, or measurement numbers from a specified channel.

Parameters

[chan] Optional. Channel number to catalog. If not specified, all measurement numbers are returned.

Examples

```
'Returns all measurement numbers  
SYST:MEAS:CAT?  
  
'Returns the measurement numbers on channel 2  
system:measurement:catalog? 2
```

Return Type String of comma-separated numbers
For example: "1,2"

Default Not Applicable

SYSTEM:MEASurement<n>:NAME?

Applicable Models: All

(Read-only) Returns the name of the specified measurement.

Parameters

<n> Measurement number for which to return the measurement name. If unspecified, value is set to 1.

Examples

```
'Returns the name of measurement 2  
SYST:MEAS2:NAME?
```

Return Type String

Default Not Applicable

SYSTEM:MEASurement<n>:TRACe?

Applicable Models: All

(Read-only) Returns the trace number of the specified measurement number. Trace numbers restart for each window while measurement numbers are always unique.

Parameters

<n> Measurement number for which to return the trace number. If unspecified, value is set to 1.

Examples

```
'Returns the trace number of measurement 1  
SYST:MEAS1:TRAC?
```

Return Type Numeric

Default Not Applicable

SYSTEM:MEASure<n>:WINDow?

Applicable Models: All

(Read-only) Returns the window number of the specified measurement number.

Parameters

<n> Measurement number for which to return the window number. If unspecified, value is set to 1.

Examples

```
'Returns the window number of measurement 2
```

```
SYST:MEAS2:WIND?
```

Return Type Numeric

Default Not Applicable

SYSTem:PERSONa:MANufacturer <string>

Applicable Models: All

(Read-Write) This command allows you to modify the manufacturer name returned by the instrument's *IDN query response. This is intended to be used for Agilent backward identity compatibility. For example, "Agilent Technologies" or "Agilent". However, it could be used for other purposes such as emulation of another vendor's instrument.

The change to the manufacturer string will not take effect until after an instrument reboot.

The manufacturer string does not allow commas in the name. If a comma is detected an error is returned. Also, if an invalid manufacturer is detected, an error is returned.

The manufacturer string used for Keysight is "Keysight Technologies".

Parameters

<string> Name of the manufacturer.

Examples

```
SYST:PERS:MAN "Keysight Technologies"
```

Query Syntax SYSTem:PERSONa:MANufacturer?

Return Type String

Default Not Applicable

SYSTem:PERSONa:MANufacturer:DEFault

Applicable Models: All

(Read-Write) Sets and returns the instrument's original manufacturer identification state following the next instrument reboot.

Parameters None

Examples `SYST:PERS:MAN:DEF`

Query Syntax `SYSTem:PERSONa:MANufacturer:DEFault?`

Return Type String

Default Not Applicable

SYSTem:PERSONa:MODEL <string>

Applicable Models: All

(Read-Write) This command allows you to modify the product model returned by the instrument's *IDN query response. This is intended to be used for model compatibility. If not specified, the default model of the instrument is used.

The change to the model string will not take effect until after an instrument reboot.

The model string does not allow commas in the name. If a comma is detected an error is returned. Also, if an invalid model is detected, an error is returned.

Parameters

<string> Product model name.

Examples `SYST:PERS:MOD "33220A"`

Query Syntax `SYSTem:PERSONa:MANufacturer?`

Return Type String

Default Not Applicable

SYSTem:PERSONa:MODEL:DEFault

Applicable Models: All

(Read-Write) Sets and returns the instrument's original product model name following the next instrument reboot.

Parameters None

Examples `SYST:PERS:MOD:DEF`

Query Syntax `SYSTem:PERSONa:MODEl:DEFault?`

Return Type String

Default Not Applicable

SYSTem:POFF

Applicable Models: All

(Write-only) Shuts down the system.

Parameters

<n> Shutdown or restart. Choose from:

1 - Restart.

0 - Shutdown .

Examples `'Shuts down the system`

`SYST:POFF`

Default 0 (Shutdown)

SYSTem:POWER<pnum>:LIMit <value>

Applicable Models: All

(Read-Write) Sets and returns the power limit for the specified port. Learn more about Power Limit.

Parameters

<pnum> Port number. Choose any VNA port.

<value> Power limit in dBm

Examples

```
SYST:POW1:LIM 5  
system:power2:limit 0
```

Query Syntax SYSTem:POWer<pnum>:LIMit?

Return Type Numeric

Default 100 dBm

SYSTem:POWer:LIMit:LOCK <bool>

Applicable Models: All

(Read-Write) Enables or disables the ability to change the power limit values through the user interface. Learn more about Power Limit.

Parameters

<bool> Power limit lock. Choose from:

ON or **1** - Disables the ability to change the power limit values from the user interface.

OFF or **0** - Enables the ability to change the power limit values from the user interface.

Examples

```
SYST:POW:LIM:LOCK 1  
system:power:limit:lock OFF
```

Query Syntax SYSTem:POWer:LIMit:LOCK?

Return Type Boolean

Default OFF

SYSTem:POWer<pnum>:LIMit:STATE <bool>

Applicable Models: All

(Read-Write) Enables or disables the power limit for the specified port. Learn more about Power Limit.

Parameters

<pnum> Port number. Choose any VNA port.

<value> Power limit state. Choose from:

ON or 1 Enables the power limit for the port<pnum>.

OFF or 0 Disables the power limit for the port<pnum>.

Examples

```
SYST:POW1:LIM:STAT ON
```

```
system:power2:limit:state 0
```

Query Syntax SYSTem:POWer<pnum>:LIMit:STATe?

Return Type Boolean

Default OFF

SYSTem:PRESet

Applicable Models: All

(Write-only) Deletes all traces, measurements, and windows. In addition, resets the analyzer to factory defined default settings and creates a S11 measurement named "CH1_S11_1". For a list of default settings, see Preset .

Regardless of the state of the User Preset Enable checkbox, the SYST:PRESet command will always preset the VNA to the factory preset settings, and SYST:UPreset will always perform a User Preset.

If the VNA display is disabled with DISP:ENAB OFF then SYST:PRES will NOT enable the display.

This command performs the same function as *RST with one exception: Syst:Preset does NOT reset Calc:FORMAT to ASCII as does *RST.

Examples

```
SYST:PRES
```

```
system:preset
```

Default Not applicable

SYSTem:SECurity[:LEVel] <char>

Applicable Models: All

(Read-Write) Sets and returns the display of frequency information on the VNA screen and printouts.

Learn more about security level.

Parameters

<char> Choose from:

NONE - ALL frequency information is displayed.

LOW - NO frequency information is displayed. Frequency information can be redisplayed using the Security Setting dialog box or this command.

HIGH - LOW setting plus GPIB console is disabled. Frequency information can be redisplayed **ONLY** by performing a Preset, recalling an instrument state with None or Low security settings, or using this command.

EXTRa - HIGH setting plus:

- ASCII data saving is disabled. Same method to redisplay frequency information as HIGH setting.
- Mixer setup files (*.mxr) can NOT be saved.

Examples

```
SYST:SEC LOW  
system:security:level high
```

Query Syntax SYSTem:SECurity[:LEVel]?

Return Type Character

Default None

SYSTem:SET <block>

Applicable Models: All

(Read-Write) Sends a definite-length binary block Instrument state and sets the VNA with those settings. This command does the same as saving a *.sta file to the VNA (MMEM:STOR STATE) and then MMEM:TRAN to transfer the file to the computer.

Parameters

<block> The Instrument state file as definite-length arbitrary binary block.

Examples `SYST:SET <block>`

Query Syntax SYSTem:SET? (This saves the instrument state file to the remote computer.)

Return Type Definite-length arbitrary binary block.

Default Not Applicable

SYSTem:SHEets:CATalog?

Applicable Models: N522xB, N523xB, N524xB, E5080A, M937xA, P937xA

(Read-only) Returns comma separated list of visible sheets.

Parameters

Examples `SYST:SHE:CAT?`

'Returns:

`"1,2,3"`

Return Type String of comma-separated numbers

Default 1

SYSTem:SHORtcut<n>:ARGuments<string>

Applicable Models: All

(Read-Write) Reads and writes the arguments for the specified macro. On the Edit Macro Dialog, this is called the "Macro run string parameters".

Parameters

<n> Numeric. Number of the macro that is stored in the VNA.

To find the number of a macro, either open the Macro Setup dialog and count the line number of the desired macro, or query the titles of all of the macros for the desired macro title.

<string> Arguments for the specified macro.

Examples

```
SYST:SHOR1:ARG  
"http://na.support.keysight.com/pna/help/PNAWebHelp/help.htm"
```

Query Syntax SYSTem:SHORtcut<n>:ARGuments?

Default Not Applicable

SYSTem:SHORtcut<n>:DELeTe

Applicable Models: All

(Write-only) Removes the specified macro from the list of macros in the VNA. Does not delete the macro executable file.

Parameters

<n> Numeric. Number of the macro that is stored in the VNA.

To find the number of a macro, either open the Macro Setup dialog and count the line number of the desired macro, or query the titles of all of the macros for the desired macro title.

Examples

```
SYST:SHOR1:DEL
```

Query Syntax Not Applicable

Default Not Applicable

SYSTem:SHORtcut<n>:EXECute

Applicable Models: All

(Write-only) Executes (runs) the specified Macro (shortcut) that is stored in the VNA.

Parameters

<n> Numeric. Number of the macro that is stored in the VNA.

To find the number of a macro, either open the Macro Setup dialog and count the line number of the desired macro, or query the titles of all of the macros for the desired macro title.

Examples

```
SYST:SHOR1:EXEC
```

Query Syntax Not Applicable

Default Not Applicable

SYSTem:SHORtcut<n>:PATH <string>

Applicable Models: All

(Read-Write) Defines a Macro (shortcut) by linking a path and file name to the Macro number. To be executed, the executable file must be put in the VNA at the location indicated by this command.

Parameters

<n> Numeric. Number of the macro to be stored in the analyzer. If the index number already exists, the existing macro is replaced with the new macro.

<string> Full path, file name, and extension, of the existing macro "executable" file.

To find the number of a macro, either open the Macro Setup dialog and count the line number of the desired macro, or query the titles of all of the macros for the desired macro title.

Examples

```
SYST:SHOR1:PATH "C:/Program Files/Keysight/Network Analyzer/Documents/unguideMultiple.vbs"
```

Query Syntax SYSTem:SHORtcut<n>:PATH?

Default Not Applicable

SYSTem:SHORtcut<n>:TITLe<string>

Applicable Models: All

(Read-Write) Reads and writes the name of the specified macro.

Parameters

<n> Numeric. Number of the macro that is stored in the VNA.

To find the number of a macro, either open the Macro Setup dialog and count the line number of the desired macro, or query the titles of all of the macros for the desired macro title.

<string> The name to be assigned to the macro.

Examples `SYST:SHOR1:TITL "Guided 4-Port Cal"`

Query Syntax `SYSTem:SHORtcut<n>:TITLe?`

Default Not Applicable

SYSTem:TIME?

Applicable Models: All

(Read-only) Returns the system time.

Parameters None

Example `SYST:TIME?`

Return Type Comma separated numbers representing hours, minutes, seconds.

Default Not applicable

SYSTem:TOUCHscreen[:STATe] <bool>

Applicable Models: N522xB, N523xB, N524xB, E5080A/B

(Read-Write) Enables and disables the touchscreen.

This setting remains until changed again from the front-panel or remotely, or until the hard drive is changed or reformatted.

Parameters

<bool> Choose from:

ON (1) Enables the touchscreen.

OFF (0) Disables the touchscreen.

Examples

```
SYST:TOUC 1
system:touchscreen:state OFF
```

Query Syntax SYSTem:TOUCHscreen[:STATe]?

Return Type Boolean

Default ON when shipped from factory.

SYSTem:UPReset

Applicable Models: N522xB, N523xB, N524xB, E5080A, M9485A, P937xA

(Write-only) Performs a User Preset. There must be an active User Preset state file (see Load and Save) or an error will be returned. Learn more about User Preset.

Regardless of the state of the User Preset Enable checkbox, the SYST:PRESet command will always preset the VNA to the factory preset settings, and SYST:UPReset will always perform a User Preset.

Examples

```
SYST:UPReset
system:upreset
```

Query Syntax Not Applicable

Default Not Applicable

SYSTem:UPReset:FPANel[:STATe] <bool>

Applicable Models: N522xB, N523xB, N524xB, E5080A, M9485A, P937xA

(Read-Write) 'Checks' and 'clears' the enable box on the User Preset dialog box . This only affects subsequent Presets from the front panel user interface.

Regardless of the state of the User Preset Enable checkbox, the SYST:PRESet command will always preset the VNA to the factory preset settings, and SYST:UPReset will always perform a User Preset.

Parameters

<bool> Front Panel User Preset State. Choose from:

0 User Preset OFF

1 User Preset ON

Examples

```
SYST:UPR:FPAN 1
```

```
system:upreset:fpanel:state 0
```

Query Syntax SYSTem:UPREset:FPANel[:STATe]?

Return Type Boolean

Default 0

SYSTem:UPReset:LOAD[:FILE] <file>

Applicable Models: N522xB, N523xB, N524xB, E5080A, M9485A, P937xA

(Write-only) Loads an existing instrument state file (.sta or .cst) to be used for User Preset. Subsequent execution of SYSTem:UPReset will cause the VNA to assume this instrument state.

Regardless of the state of the User Preset Enable checkbox, the SYST:PRESet command will always preset the VNA to the factory preset settings, and SYST:UPReset will always perform a User Preset.

Learn more about User Preset.

Parameters

<file> String - Name of the file to be loaded. The default folder "C:/Program Files/Keysight/Network Analyzer/Documents" is used if unspecified. Change the default folder name using MMEMory:CDIRectory .

Examples

```
SYST:UPR:LOAD '1MHzto20GHzUserPreset.cst'
```

```
system:upreset:load:file 'C:/Documents and Settings/Administrator/My Documents/NewUserPreset.cst'
```

Query Syntax Not Applicable

Default Not Applicable

SYSTem:UPReset:SAVE[:STATe]

Applicable Models: N522xB, N523xB, N524xB, E5080A, M9485A, P937xA

(Write-only) Saves the current instrument settings as UserPreset.sta. Subsequent execution of SYSTem:UPReset will cause the VNA to assume this instrument state.

Regardless of the state of the User Preset Enable checkbox, the SYST:PRESet command will always preset the VNA to the factory preset settings, and SYST:UPReset will always perform a User Preset.

Learn more about User Preset.

Examples

```
SYST:UPR:SAVE
system:upreset:save:state
```

Query Syntax Not Applicable

Default Not Applicable

SYSTem:WINDows:CATalog?

Applicable Models: All

(Read-only) Returns the window numbers that are currently being used.

Examples

```
SYST:WIND:CAT?
system:windows:catalog?
```

Return Type String of comma-separated numbers.
For example: "1,2"

Default Not Applicable

SYSTem:CALibrate:ALL Commands

Contains the settings to configure a "Cal All" Calibration.

Use the Guided Cal interface to perform the calibration.

SYSTem:CALibrate:ALL:

CHANnel:

| PORTs[:SElect]

CSET:

| CATalog?

| PREFix

GUIDed:

| CHANnel:LIST?

| CHANnel[:VALue]?

| PORTs?

IFBW

INdependent:

| SOURce:

| CALibrate:

| CATalog?

| RANGE:

| ADD

| CLEar

| COUNT

| PONts

| STARt

| STOP

MClass:

| PROPerTy:

| NAME:CATalog?

| VALue:

| CATalog?

| [STATe]

PATH:

| CONFigure:

<p> ELEment</p> <p>PORT<n>:</p> <p> RECeiver:ATTen</p> <p> SOURce:POWer:</p> <p> ATTen</p> <p> OFFS et</p> <p> [VALue]</p> <p>RESet</p> <p>SElect</p>
--

Click on a **red** keyword to view the command details.

See Also

- About Calibrate All Channels
- Example Programs
- Guided Cal commands
- Synchronizing the Analyzer and Controller
- SCPI Command Tree

SYSTem:CALibrate:ALL[1-250]:CHANnel<ch>:PORTs[:SElect] <value>

Applicable Models: All

(Write-Read) For each channel to be calibrated, sets and returns the ports to be calibrated. Specify port numbers ONLY for standard channels. Application channels are not necessary because they have designated input/output/LO ports.

Parameters

- [1-250] Calibration number. The default is 1.
- <ch> Channel number to be calibrated.
- <value> Ports to be calibrated for the specified channel. Select any of the native VNA ports (1,2,3,4).

Examples

```
SYST:CAL:ALL:CHAN2:PORT 1,2,3
```

Query Syntax SYSTem:CALibrate:ALL:CHANnel<ch>:PORTs[:SElect]?

Return Type Comma-separated port numbers.

Default 1,2

SYSTem:CALibrate:ALL[1-250]:CSET:CATalog?

Applicable Models: All

(Read-only) Returns the User Cal Set or cal register names that were produced by the cal all session.

Parameters

[1-250] Calibration number. The default is 1.

Examples

```
SYST:CAL:ALL:CSET:CATalog?  
  
'returns this format:  
  
"MyCalAll_STD_001, MyCalAll_SMC_002"  
  
See example program
```

Return Type String of comma-separated Cal Set or cal register names

Default Not Applicable

SYSTem:CALibrate:ALL[1-250]:CSET:PREFix<value>

Applicable Models: All

(Write-Read) Sets and returns the prefix to be used when saving User Cal Sets that result from the Cal All session. The Meas Class and channel number are appended to this prefix for each calibrated channel. Use SYST:CAL:ALL:CSET:CATalog? to read the saved cal set names.

- SENS:CORR:COLL:GUID:SAVE:CSET can also be used to set the Cal Set prefix.
- If a Cal Set prefix is NOT set using either command, the cal data for each channel will be saved only to cal registers. Learn about cal registers .

Parameters

[1-250] Calibration number. The default is 1.

<value> (String) User Cal Set prefix.

Examples

```
SYST:CAL:ALL:CSET:PREFix "MyCalAll"
```

Query Syntax SYSTem:CALibrate:ALL:CSET:PREFix?

Return Type String

Default " " (Empty string)

SYSTem:CALibrate:ALL[1-250]:GUIDed:CHANnel:LIST?

Applicable Models: All

(Read-only) Returns all cal all guided calibration channels.

Parameters

[1-250] Calibration number. The default is 1.

Examples

```
chan = SYST:CAL:ALL:GUID:CHAN:LIST?
```

Return Type String of comma-separated channel numbers

Default Not applicable

SYSTem:CALibrate:ALL[1-250]:GUIDed:CHANnel[:VALue]?

Applicable Models: All

(Read-only) Returns the primary guided calibration channel number if more than one channel exists; otherwise, this command returns the one value. Use this value as the <ch> argument for the subsequent Guided:Cal commands.

Parameters

[1-250] Calibration number. The default is 1.

Examples

```
chan = SYST:CAL:ALL:GUID:CHAN:VAL?
```

Return Type Numeric

Default Not applicable

SYSTem:CALibrate:ALL[1-250]:GUIDed:PORTs?

Applicable Models: All

(Read-only) Returns the ports to be calibrated during the Cal All Channels calibration. Specify connectors and cal kits for these ports using the Guided:Cal commands.

Specify the ports to be calibrated for each channel using SYST:CAL:ALL:CHAN<ch>:PORT.

Parameters

[1-250] Calibration number. The default is 1.

Examples `ports = SYST:CAL:ALL:GUID:PORT?`

Return Type Comma-separated list of port numbers

Default Not applicable

SYSTem:CALibrate:ALL[1-250]:IFBW <value>

Applicable Models: All

(Write-Read) Sets and returns the IFBW for a Cal All calibration. Learn more about this setting .

Parameters

[1-250] Calibration number. The default is 1.

<value> IF Bandwidth in Hz. The list of valid IF Bandwidths is different depending on the VNA model. See the list of valid settings . If an invalid number is specified, the VNA will round up to the closest valid setting.

This command supports MIN and MAX as arguments. Learn more .

Examples `SYST:CAL:ALL:IFBW 10e3`

Query Syntax SYSTem:CALibrate:ALL:IFBW?

Return Type Numeric

Default 1 kHz

SYSTem:CALibrate:ALL[1-250]:INdependent:SOURce:CALibrate:CATalog?

Applicable Models: All

(Read-only) Returns available ports for independent power calibration.

Parameters

[1-250] Calibration number. The default is 1.

Examples `SYST:CAL:ALL:IND:SOUR:CAL:CAT?`

Return Type String

Default Not applicable

SYSTem:CALibrate:ALL[1-250]:INDEpendent:SOURce<n>:CALibrate:RANGe:ADD

Applicable Models: All

(Write-only) This command adds a power cal range for a specific port <n>. Note that external sources are valid and specifying a source port is the same as other remote commands. By default this will create a range with the preset start/stop frequency and 201 points. The maximum number of ranges that can be added is 100 (same as the maximum number of segments).

Parameters

[1-250] Calibration number. The default is 1.

<n> Port number

Examples `SYST:CAL:ALL:IND:SOUR3:CAL:RANG:ADD`

Default Not applicable

SYSTem:CALibrate:ALL[1-250]:INDEpendent:SOURce<n>:CALibrate:RANGe:CLEAR

Applicable Models: All

(Write-only) This command resets all ranges for the given source port <n>.

Parameters

[1-250] Calibration number. The default is 1.

<n> Port number

Examples `SYST:CAL:ALL:IND:SOUR3:CAL:RANG:CLEAR`

Default Not applicable

SYSTem:CALibrate:ALL[1-250]:INDePendent:SOURce<n>:CALibrate:RANGe:COUNT?

Applicable Models: All

(Read-only) This command queries how many ranges are included in the calibration for source port <n>.

Parameters

[1-250] Calibration number. The default is 1.

<n> Port number

Examples

```
SYST:CAL:ALL:IND:SOUR3:CAL:RANG:COUNT?
```

Return Type Numeric

Default Not applicable

SYSTem:CALibrate:ALL[1-250]:INDePendent:SOURce<n>:CALibrate:RANGe<m>:POINTs<value>

Applicable Models: All

(Write-Read) This command sets and gets the number of points for range <m> for source port<n>.

Parameters

[1-250] Calibration number. The default is 1.

<n> Port number

<m> Range number

<value> Number of points

Examples

```
SYST:CAL:ALL:IND:SOUR3:CAL:RANG1:POINT 7
```

Query SYSTem:CALibrate:ALL:INDePendent:SOURce<n>:CALibrate:RANGe<m>:POINTs?

Syntax

Return Numeric

Type

Default Not applicable

SYSTem:CALibrate:ALL[1-250]:INDePendent:SOURce<n>:CALibrate:RANGe<m>:START<value>

Applicable Models: All

(Write-Read) This command sets and gets the start frequency for range <m> for source port<n>.

Parameters

- [1-250] Calibration number. The default is 1.
- <n> Port number
- <m> Range number
- <value> Start frequency for range <m>

Examples

```
SYST:CAL:ALL:IND:SOUR3:CAL:RANG1:STAR 20e9
```

Query Syntax SYSTem:CALibrate:ALL:INDEpendent:SOURce<n>:CALibrate:RANGe<m>:STARt?

Return Type Numeric

Default Not applicable

```
SYSTem:CALibrate:ALL[1-250]:INDEpendent:SOURce<n>:CALibrate:RANGe<m>:STOP  
<value>
```

Applicable Models: All

(Write-Read) This command sets and gets the stop frequency for range <m> for source port<n>.

Parameters

- [1-250] Calibration number. The default is 1.
- <n> Port number
- <m> Range number
- <value> Stop frequency for range <m>

Examples

```
SYST:CAL:ALL:IND:SOUR3:CAL:RANG1:STOP 21e9
```

Query Syntax SYSTem:CALibrate:ALL:INDEpendent:SOURce<n>:CALibrate:RANGe<m>:STOP?

Return Type Numeric

Default Not applicable

SYSTem:CAL:ALL[1-250]:MCLass:PROPerTy:NAME:CATalog? [mclass]

Applicable Models: All

(Read-only) Returns the unique, settable properties for the current cal all session.

See a list of valid properties and values for each measurement class .

Parameters

[1-250] Calibration number. The default is 1.

[mclass] Optional argument. String name of the measurement class for which properties are to be returned. See a list of valid measurement class Application names . The measurement class must be included in the current Cal All calibration.

Examples

```
SYST:CAL:ALL:MCL:PROP:NAME:CAT?
```

```
'with NFX app, returns:
```

```
"Noise Cal Method,Noise Tuner,AutoOrient Tuner,Tuner In,Tuner  
Out,Receiver Characterization Method,ENR File,Noise Source  
Connector,Noise Source CalKit"
```

Return Type String of comma-separated properties.

Default Not applicable

SYSTem:CAL:ALL[1-250]:MCLass:PROPerTy:VALue:CATalog? <prop>

Applicable Models: All

(Read-only) Returns the valid property values for a specific property name.

See a list of valid properties and values for each measurement class .

Parameters

[1-250] Calibration number. The default is 1.

<prop> (String) Property name for which valid values are to be returned.

Examples

```
SYST:CAL:ALL:MCL:PROP:VAL:CAT? "Noise Cal Method"
```

```
'with NFX app, returns:
```

```
"Scalar,Vector"
```

Return Type String of comma-separated values

Default Not applicable

SYSTem:CALibrate:ALL[1-250]:MCLass:PROPerTy:VALue[:STATe] <prop>,<value>

Applicable Models: All

(Write-Read) Sets and returns the property value for a specific property name.

See a list of valid properties and values for each measurement class .

Parameters

- [1-250] Calibration number. The default is 1.
- <prop> (String) Property name for which value is to be set or returned.
- <value> Property value. To read a list of valid values, use SYST:CAL:ALL:MCL:PROP:VAL:CAT?

Examples

```
Example 1:  
SYST:CAL:ALL:MCL:PROP:VAL "Noise Cal Method","Noise:Scalar"  
  
Example 2:  
SYST:CAL:ALL:MCL:PROP:VAL "Enable Extra Power Cals","Port 1  
Src2,Port3"  
  
Example 3:  
SYST:CAL:ALL:MCL:PROP:VAL "Port 1 Src2 Cal Power","-20"
```

Query Syntax SYSTem:CALibrate:ALL:MCLass:PROPerTy:VALue[:STATe]? <prop>

Return Type String

Default Varies with the property name.

SYSTem:CALibrate:ALL[1-250]:PATH:CONFIgure:ELEMent[:STATe] <element>,<setting>

Applicable Models: N522xB, N523xB, N524xB

(Write-Read) Sets and returns the Path Configuration settings for a Cal All calibration.

Parameters

- [1-250] Calibration number. The default is 1.
- <element> (String) Path configuration element to be set. See a list of configurable RF Path elements and settings.
- <setting> (String) Path configuration element setting.

Examples

```
SYST:CAL:ALL:PATH:CONFigure:ELEment "Port1NoiseTuner", "Internal"
```

Query Syntax

```
SYSTem:CALibrate:ALL:PATH:CONFigure:ELEment[:STATe]? <element>
```

Return Type

String

Default

Not Applicable

SYSTem:CALibrate:ALL[1-250]:PORT<n>:RECeiver:ATTen<value>[,src]

Applicable Models: All

(Write-Read) Sets and returns the Receiver Attenuator setting for a Cal All calibration.

Parameters

- [1-250] Calibration number. The default is 1.
- <n> Receiver port number.
- <value> Attenuation value in dB for a Cal All calibration. Choose a valid value for the VNA model. See valid settings .
- [src] String. (NOT case sensitive). Source port. Optional. Use SOUR:CAT? to return a list of valid port names.

While this argument can be used to make settings for ALL ports, it is designed to access ports such as an external source, true mode balanced port, or one of the Source 2 outputs on the 2-port 2-source PNA-X model such as "Port 1 Src2". Otherwise, the <port> argument performs the same function. If both arguments are specified, [src] takes priority.

Examples

```
SYST:CAL:ALL:PORT2:REC:ATT 10
```

Query Syntax

```
SYSTem:CALibrate:ALL:PORT<n>:RECeiver:ATTen?
```

Return Type

Numeric

Default

0

SYSTem:CALibrate:ALL[1-250]:PORT<n>:RECeiver:ATTen:REFerence<num>

Applicable Models: N522xB, N523xB, N524xB, M9485A

(Write-Read) Sets and returns the reference attenuator setting for a Cal All calibration.

Parameters

[1-250] Calibration number. The default is 1.

<n> Receiver port number.

<num> Attenuation value in dB for a Cal All calibration. 0dB or 35dB.

If a number other than these is entered, the analyzer will select the next lower valid value. For example, if 19dB is entered, then 0dB attenuation will be selected.

Examples

```
SYST:CAL:ALL:PORT2:REC:ATT:REF 0
```

Query Syntax SYSTem:CALibrate:ALL:PORT<n>:RECeiver:ATTen:REFerence?

Return Type Numeric. If querying for the standard port, the return value is 0

Default 35

SYSTem:CALibrate:ALL[1-250]:PORT<n>:RECeiver:ATTen:TEST<num>

Applicable Models: N522xB, N523xB, N524xB, M9485A

(Write-Read) Sets and returns the test attenuator setting for a Cal All calibration.

Parameters

[1-250] Calibration number. The default is 1.

<n> Receiver port number.

<num> Attenuation value in dB for a Cal All calibration. 0dB or 35dB.

If a number other than these is entered, the analyzer will select the next lower valid value. For example, if 19dB is entered, then 0dB attenuation will be selected.

Examples

```
SYST:CAL:ALL:PORT2:REC:ATT:TEST 0
```

Query Syntax SYSTem:CALibrate:ALL:PORT<n>:RECeiver:ATTen:TEST?

Return Type Numeric. If querying for the standard (M9376A) port, the return value is 0.

SYSTem:CALibrate:ALL[1-250]:PORT<n>:SOURce:POWer:ATTen<value>[,src]

Applicable Models: N522xB, N523xB, N524xB, M937xA, P937xA

(Write-Read) Sets and returns the Source Attenuator setting for the Cal All calibration.

Parameters

[1-250] Calibration number. The default is 1.

<n> Source port number.

<value> Attenuation value in dB for the Cal All calibration. Choose a valid value for the VNA model. See valid settings .

[src] String. (NOT case sensitive). Source port. Optional. Use SOUR:CAT? to return a list of valid port names.

While this argument can be used to make settings for ALL ports, it is designed to access ports such as an external source, true mode balanced port, or one of the Source 2 outputs on the 2-port 2-source PNA-X model such as "Port 1 Src2". Otherwise, the <port> argument performs the same function. If both arguments are specified, [src] takes priority.

Examples

```
SYST:CAL:ALL:PORT2:SOUR:POW:ATT 10
```

Query Syntax SYSTem:CALibrate:ALL:PORT<n>:SOURce:POWer:ATTen?

Return Type Numeric

Default 0

SYSTem:CALibrate:ALL[1-250]:PORT<n>:SOURce:POWer:OFFSet <value>[,src]

Applicable Models: All

(Write-Read) Sets and returns the power offset value for a Cal All calibration.

Power Offset provides a method of compensating port power for added attenuation or amplification in the source path. The result is that power at the specified port reflects the added components.

Parameters

- [1-250] Calibration number. The default is 1.
<n> Source port number.
<value> Power offset value in dB for a Cal All calibration.

- For amplification, use positive offset.
- For attenuation, use negative offset.

[src] String. (NOT case sensitive). Source port. Optional. Use SOUR:CAT? to return a list of valid port names.

While this argument can be used to make settings for ALL ports, it is designed to access ports such as an external source, true mode balanced port, or one of the Source 2 outputs on the 2-port 2-source PNA-X model such as "Port 1 Src2". Otherwise, the <port> argument performs the same function. If both arguments are specified, [src] takes priority.

Examples

```
SYST:CAL:ALL:PORT2:SOUR:POW:OFFS 10
```

Query Syntax SYSTem:CALibrate:ALL:PORT<n>:SOURce:POWer:OFFSet?

Return Type Numeric

Default 0

SYSTem:CALibrate:ALL[1-250]:PORT<n>:SOURce:POWer[:VALue] <value>[,src]

Applicable Models: All

(Write-Read) Sets and returns the power level at which a Cal All calibration is to be performed.

Parameters

- [1-250] Calibration number. The default is 1.
- <n> Source port number.
- <value> Power level at which the calibration is to be performed.
- [src] String. (NOT case sensitive). Source port. Optional. Use SOUR:CAT? to return a list of valid port names.

While this argument can be used to make settings for ALL ports, it is designed to access ports such as an external source, true mode balanced port, or one of the Source 2 outputs on the 2-port 2-source PNA-X model such as "Port 1 Src2". Otherwise, the <port> argument performs the same function. If both arguments are specified, [src] takes priority.

Examples

```
SYST:CAL:ALL:PORT2:SOUR:POW 0
```

Query Syntax SYSTem:CALibrate:ALL:PORT<n>:SOURce:POWER[:VALue]?

Return Type Numeric

Default Preset power of the VNA model.

See the data sheet for the power level for each model .

SYSTem:CALibrate:ALL[1-250]:RESet

Applicable Models: All

(Write-only) Resets all properties associated with the Cal All session to their default values.

Parameters

- [1-250] Calibration number. The default is 1.

Examples

```
SYST:CAL:ALL:RES
```

Query Syntax Not Applicable

Default Not Applicable

SYSTem:CALibrate:ALL[1-250]:SElect <value>

Applicable Models: All

(Write-Read) Sets and returns the list of channels to be calibrated during the Cal All session.

Parameters

[1-250] Calibration number. The default is 1.

<value> Channel numbers to be calibrated. These channels must already exist.

Examples

```
SYST:CAL:ALL:SEL 1,2,3
```

Query Syntax SYSTem:CALibrate:ALL:SElect?

Return Type Comma-separated channel numbers.

Default Existing channels

System:Calibrate:Phase

Contains the settings to perform an SMC Phase Reference Calibration.

SYSTEM:CALibrate:PHASe

CKIT

CONNector

DEEMbed

FREQuency:

| **START**

| **STOP**

GUIDed:

| **CHANnel?**

PORT

POWER:ATTenuator

REFerence:

| **CATalog?**

RESet

UNKNown:

| **INCLude**

| **INPut:POWER**

| **LO**

| **FREQuency**

| **POWER**

Click on a **red** keyword to view the command details.

Important Notes

- It is NOT necessary to create an SMC measurement before performing a **remote** Phase Reference Cal. It is necessary when performed from the user interface.
- Before A..09.90, port selection was made remotely by selecting connectors and Cal Kits for the ports to be included in the SOLT calibration. With A.09.90, port selection is made explicitly with the commands in this node.

See Also

- [Example Program](#)
- [About Phase Reference Cal](#)
- [Guided Cal commands](#)
- [Synchronizing the Analyzer and Controller](#)
- [SCPI Command Tree](#)

SYSTem:CALibrate:PHASe:CKIT <string>

Applicable Models: N522xB, N523xB, N524xB

(Write-Read) Sets and returns the Cal Kit that will be used to perform the S-parameter Cal.

To read a list of valid Cal Kits, use **SENSe:CORR:COLL:GUID:CKIT:CAT?**

Parameters

<string> Cal Kit.

Examples

```
SYST:CAL:PHAS:CKIT "85052D"
```

Query Syntax

```
SYSTem:CALibrate:PHASe:CKIT?
```

Return Type

String

Default

" "

SYSTem:CALibrate:PHASe:CONNector <string>

Applicable Models: N522xB, N523xB, N524xB

(Write-Read) Sets and returns the connector type and gender of your Cal Kit.

To read a list of valid connector types, use **SENS:CORR:COLL:GUID:CONN:CAT?**

Parameters

<string> Connector type.

Examples

```
SYST:CAL:PHAS:CONN "APC 3.5 female"
```

Query Syntax

```
SYSTem:CALibrate:PHASe:CONNector?
```

Return Type

String

Default

" "

SYSTem:CALibrate:PHASe:DEEMbed <bool>

Applicable Models: N522xB, N523xB, N524xB

(Write-Read) Sets and returns the state of de-embedding (reversing) the port 2 coupler.

Parameters

<bool> Port 2 coupler de-embed state. Choose from:

ON (or 1) - Configures the calibration to include additional measurements to de-embed the effects of reversing the coupler. (This is the same as clearing the “Omit Coupler” checkbox.)

OFF (or 0) - Excludes additional measurements for de-embedding the effects of reversing the coupler.

Examples

```
SYST:CAL:PHAS:DEEM 1
```

Query Syntax SYSTem:CALibrate:PHASe:DEEMbed?

Return Type Boolean

Default ON or 1

SYSTem:CALibrate:PHASe:FREQuency:STARt <value>

Applicable Models: N522xB, N523xB, N524xB

(Write-Read) Sets and returns the phase reference cal start frequency.

Parameters

<value> Start frequency. Choose any frequency from 10 MHz to the stop frequency of the VNA.

Examples

```
SYST:CAL:PHAS:FREQ:STAR 17.5e6
```

Query Syntax SYSTem:CALibrate:PHASe:FREQuency:STARt?

Return Type Numeric

Default Start frequency of the VNA

SYSTem:CALibrate:PHASe:FREQuency:STOP <value>

Applicable Models: N522xB, N523xB, N524xB

(Write-Read) Sets and returns the phase reference cal stop frequency.

Parameters

<value> Stop frequency. Choose any frequency within the range of the VNA.

Examples

```
SYST:CAL:PHAS:FREQ:STOP 26.5e9
```

Query Syntax

```
SYSTem:CALibrate:PHASe:FREQuency:STOP?
```

Return Type

Numeric

Default

Stop frequency of the VNA

SYSTem:CALibrate:PHASe:GUIDed:CHANnel?

Applicable Models: N522xB, N523xB, N524xB

(Read-only) Reads the channel number of the Phase Reference Calibration. Use this value as the <ch> argument for the subsequent **Guided:Cal** commands.

Parameters

None

Examples

```
chan = SYST:CAL:PHAS:GUID:CHAN?
```

Return Type

Numeric

Default

Not applicable

SYSTem:CALibrate:PHASe:PORT<n> <bool>

Applicable Models: N522xB, N523xB, N524xB

(Write-Read) Sets and returns the enable state for the specified port.

Parameters

<n> Port number to enable or disable.

<bool> Port enable state. Choose from:

ON (or 1) - Enable port <n>

OFF (or 0) - Disable port <n>

Examples

```
SYST:CAL:PHAS:PORT2 1
```

Query Syntax

```
SYSTem:CALibrate:PHASe:PORT<n>?
```

Return Type Boolean
Default Ports 1 and 2 are enabled.
Ports 3 and 4 (if present) are disabled

SYSTem:CALibrate:PHASe:POWer:ATTenuator <value>

Applicable Models: N522xB, N523xB, N524xB

(Write-Read) Sets and returns the Source Attenuator setting for the Phase Reference calibration.

Note: This setting MUST match the source attenuator setting at the mixer input port for subsequent SMC+Phase measurements.

Parameters

<value> Attenuation value in dB. Choose a valid value for the VNA model. **See valid settings.**

Examples `SYST:CAL:PHAS:POW:ATT 10`

Query Syntax SYSTem:CALibrate:PHASe:POWer:ATTenuator?

Return Type Numeric

Default 10 dB

SYSTem:CALibrate:PHASe:REFerence <string>

Applicable Models: N522xB, N523xB, N524xB

(Write-Read) Sets and returns the Phase Reference ID to be used for the Phase Reference calibration. Use SYST:CAL:PHAS:REF:CAT? to read the phase references currently connected to the VNA USB.

Parameters

<string> Phase reference ID string.

Examples `SYST:CAL:PHAS:REF "MYPRT0001"`

Query Syntax SYSTem:CALibrate:PHASe:REFerence?

Return Type String

Default Not Applicable

SYSTem:CALibrate:PHASe:REFerence:CATalog?

Applicable Models: N522xB, N523xB, N524xB

(Read-only) Reads the ID strings of the phase references that are currently connected to the VNA USB.

Parameters None

Examples `pRef = SYST:CAL:PHAS:REF:CAT?`

Return Type Comma-separated string

Default Not Applicable

SYSTem:CALibrate:PHASe:RESet

Applicable Models: N522xB, N523xB, N524xB

(Write-only) Resets all properties associated with the Phase Reference Cal to their default values.

Parameters None

Examples `SYST:CAL:ALL:PHAS:RES`

Query Syntax Not Applicable

Default Not Applicable

SYSTem:CALibrate:PHASe:UNKNown:INCLude <bool>

Applicable Models: N522xB, N523xB, N524xB

(Write-Read) Sets and returns the state of Unknown Mixer calibration.

Parameters

<bool> Unknown Mixer cal state. Choose from:

ON (or 1) - Enable Unknown Mixer cal. The start frequency becomes 10 MHz and can NOT be changed.

OFF (or 0) - Disable Unknown Mixer cal.

Examples `SYST:CAL:PHAS:UNKN:INCL 1`

Query Syntax SYSTem:CALibrate:PHASe:UNKNown:INCLude?

Return Type Boolean

Default OFF or 0

SYSTem:CALibrate:PHASe:UNKNown:INPut:POWer <value>

Applicable Models: N522xB, N523xB, N524xB

(Write-Read) Sets and returns the input power level to the unknown mixer.

Parameters

<value> Input power level in dBm.

Examples

```
SYST:CAL:PHAS:UNKN:INP:POW -5
```

Query Syntax

SYSTem:CALibrate:PHASe:UNKNown:INPut:POWer?

Return Type

Numeric

Default

-15 dBm

SYSTem:CALibrate:PHASe:UNKNown:LO:FREQUency <value>

Applicable Models: N522xB, N523xB, N524xB

(Write-Read) Sets and returns the LO frequency to the unknown mixer.

Parameters

<value> LO frequency in Hz. Choose a value between 3 GHz and (Max Frequency minus 1GHz).

For a 26.5 GHz VNA, the range is 3 GHz to 25.5 GHz.

For best results, use the default LO frequency. 3.351Ghz. This frequency produces no spurs from the input/LO frequency. And also the Input frequency will have no band breaks.

Examples

```
SYST:CAL:PHAS:UNKN:LO:FREQ 3.351e9
```

Query Syntax

SYSTem:CALibrate:PHASe:UNKNown:LO:FREQUency?

Return Type

Numeric

Default

3.351 GHz

SYSTem:CALibrate:PHASe:UNKNown:LO:POWer <value>

Applicable Models: N522xB, N523xB, N524xB

(Write-Read) Sets and returns the LO power level to the unknown mixer.

Parameters

<value> LO power level in dBm.

Examples

```
SYST:CAL:PHAS:UNKN:LO:POW 10
```

Query Syntax

```
SYSTem:CALibrate:PHASe:UNKNown:LO:POWer?
```

Return Type

Numeric

Default

10 dBm

SYSTem:CAPability Commands

Reads various capabilities of the analyzer.

SYSTem:CAPability:

ALC:POWer:

| MAXimum[:LEVel]?

| MINimum[:LEVel]?

CHANnels:MAXimum[:COUNT]?

DELay

| TRIGger

| MAX?

| MIN?

FOM:EXISts?

FREQuency

| MAXimum?

| MINimum?

HARDware:

| ATTenuator:RECeiver:

| EXISts?

| MAXimum?

| STEP[:SIZE]?

| ATTenuator:SOURce:

| MAXimum?

| STEP[:SIZE]?

| DC:RECeiver

| INTernal:CATalog?

| INTernal:COUNT?

| DC:SOURce

| INTernal:CATalog?

| INTernal:COUNT?

| IF

| MAXimum?

| MINimum?

- | **LFEXtension**
 - | **EXISts?**
- | **PORTs:**
 - | **CATalog?**
 - | **COUNT?**
 - | **INTernal**
 - | **CATalog?**
 - | **COUNT?**
 - | **PNUMber?**
 - | **SOURce**
 - | **CATalog?**
 - | **COUNT?**
 - | **INTernal**
 - | **CATalog?**
 - | **COUNT?**
- | **POWer**
 - | **DISCrete**
 - | **FREQuency**
 - | **LIST**
 - | **MAXimum?**
 - | **LIST?**
 - | **MINimum?**
 - | **LIST?**
 - | **PATH**
 - | **CONFig**
 - | **ELEMent**
 - | **CATalog?**
 - | **[:STATE]**
 - | **VALue**
 - | **CATalog?**
 - | **PORT**
 - | **RANGe**
 - | **FREQuency**

| **START**
| **STOP**
| **MAXimum?**
| **MINimum?**
| **RESet**
| **TYPE**
| **RBSWitch:EXISts?**
| **RECeiver:**
| **INTernal**
| **COUNT?**
| **DACCess?**
| **SOURce:COUNT?**
IFBW:CATalog?
IFBW
| **MAXimum?**
| **MINimum?**
LICenses:
| **CATalog?**
NBW:
| **NOISe:CATalog?**
| **STD:CATalog?**
POINTs:
| **MAXimum?**
| **MINimum?**
PRESet:FREQuency:
| **MAXimum?**
| **MINimum?**
RBW:IMS:CATalog?
RBW:SA:CATalog?
WINDows
| **MAXimum[:COUNT]?**
| **TRACes:MAXimum[:COUNT]?**

Click on a [red](#) keyword to view the command details.

SYSTem:CAPability:HARDware:POWer Commands

These commands provide access to data sheet specified and typical, max and min power levels (in dBm). Max power refers to the maximum leveled source power at the specified port. Min power is calculated by subtracting the power sweep range from the max leveled power. This information is stored by frequency band in a power specification file. These commands provide access to the file's contents and provide an interface to configure the port number and RF signal path of interest.

Power data is available as either the most restrictive value across a range of frequencies (when [SYST:CAP:HARD:POW:RANG:MAX](#) and [SYST:CAP:HARD:POW:RANG:MIN](#) are used) or for discrete CW frequencies (when [SYST:CAP:HARD:POW:DISC:MAX](#) and [SYST:CAP:HARD:POW:DISC:MIN](#) are used).

No measurement of instrument-specific dynamic range is performed; all power levels are equivalent to power data published in device data sheets. Power levels are valid only for measurement configurations where the front panel jumpers are in their standard positions, as originally shipped. Internal source attenuation and any calibrated external path loss/gain due to cables, fixtures, switches or booster amplifiers are not included in the reported min/max leveled power values. It remains the users' responsibility to transform the reported factory power range data to a value corresponding to the specific calibration plane of their setups.

The power range data files contain both specified min/max leveled power values and the corresponding "typical" values. Some paths, that are not part of the specifications of the instrument may only have typical data. Only the "Specified" power range data is guaranteed for an instrument with an up-to-date calibration certificate.

See Also

- [Example Programs](#)
- [Synchronizing the Analyzer and Controller](#)
- [SCPI Command Tree](#)

SYSTem:CAPability:DELay:TRIGger:MAX?

Applicable Models: N522xB, N523xB, N524xB, E5080A

(Read-only) Returns the maximum trigger delay of the analyzer.

Parameters None

Examples `SYST:CAP:DEL:TRIG:MAX?`

Return Type Numeric

Default Not Applicable

SYSTEM:CAPability:DELAy:TRIGger:MIN?

Applicable Models: N522xB, N523xB, N524xB, E5080A

(Read-only) Returns the minimum trigger delay of the analyzer.

Parameters None

Examples `SYST:CAP:DEL:TRIG:MIN?`

Return Type Numeric

Default Not Applicable

SYSTEM:CAPability:ALC:POWER:MAXimum[:LEVel]?

Applicable Models: N522xB, N523xB, N524xB, M937xA, E5080A, P937xA

(Read-only) Returns the maximum leveled source power setting in dB. [Learn more about leveled source power.](#)

Parameters None

Examples `SYST:CAP:ALC:POW:MAX?`

Return Type Numeric

Default Not Applicable

SYSTEM:CAPability:ALC:POWER:MINimum[:LEVel]?

Applicable Models: N522xB, N523xB, N524xB, M937xA, E5080A, P937xA

(Read-only) Returns the minimum leveled source power setting in dB with 0 dB attenuation. [Learn more about leveled source power.](#)

Parameters None

Examples `SYST:CAP:ALC:POW:MIN?`

Return Type Numeric

Default Not Applicable

SYSTem:CAPability:CHANnels:MAXimum[:COUNT]?

Applicable Models: All

(Read-only) Returns the maximum possible number of channels. [Learn more about Channels.](#)

Parameters None

Examples `SYST:CAP:CHAN:MAX?`

Return Type Numeric

Default Not Applicable

SYSTem:CAPability:FOM:EXISts?

Applicable Models: All

(Read-only) Returns whether or not the analyzer has FOM installed. [Learn more.](#)

Parameters None

Examples `SYST:CAP:FOM:EXIS?`

Return Type Boolean

1 - Yes, FOM is installed.

0 - No, FOM is NOT installed.

Default Not Applicable

SYSTem:CAPability:FREQUency:MAXimum?

Applicable Models: All

(Read-only) Returns the maximum frequency of the analyzer, including any over-sweep. Over-sweep frequencies can be set but are not specified.

Parameters None

Examples `SYST:CAP:FREQ:MAX?`

Return Type Numeric

Default Not Applicable

SYSTEM:CAPability:FREQuency:MINimum?

Applicable Models: All

(Read-only) Returns the minimum frequency of the analyzer, including any under-sweep. Under-sweep frequencies can be set but are not specified.

Parameters None

Examples `SYST:CAP:FREQ:MIN?`

Return Type Numeric

Default Not Applicable

SYSTEM:CAPability:HARDware:ATTenuator:RECeiver:EXISts? <portNum>

Applicable Models: N522xB, N523xB, N524xB, M937xA, E5080A, P937xA

(Read-only) Returns whether or not there is a receiver attenuator on the specified port.

Parameters

<portNum> Port number. Choose from the number of test ports on the analyzer.

Examples `SYST:CAP:HARD:ATT:REC:EXIS? 2`

Return Type Boolean

1 - Yes, the test port has a receiver attenuator.

0 - No, the test port does NOT have a receiver attenuator.

Default Not Applicable

SYSTem:CAPability:HARDware:ATTenuator:RECeiver:MAXimum? <portNum>

Applicable Models: N522xB, N523xB, N524xB, M937xA, E5080A, P937xA

(Read-only) Returns the maximum amount of receiver attenuation on the specified port.

Parameters

<portNum> Port number. Choose from the number of test ports on the analyzer.

Examples

```
SYST:CAP:HARD:ATT:REC:MAX? 2
```

Return Type Numeric

Default Not Applicable

SYSTem:CAPability:HARDware:ATTenuator:RECeiver:STEP[:SIZE]? <portNum>

Applicable Models: N522xB, N523xB, N524xB, M937xA, E5080A, P937xA

(Read-only) Returns the step size of the receiver attenuator on the specified port.

Parameters

<portNum> Port number. Choose from the number of test ports on the analyzer.

Examples

```
SYST:CAP:HARD:ATT:REC:STEP? 2
```

Return Type Numeric

Default Not Applicable

SYSTem:CAPability:HARDware:ATTenuator:SOURce:MAXimum? <portNum>

Applicable Models: N522xB, N523xB, N524xB, M937xA, E5080A, P937xA

(Read-only) Returns the maximum amount of source attenuation on the specified port.

Parameters

<portNum> Port number. Choose from the number of test ports on the analyzer.

Examples

```
SYST:CAP:HARD:ATT:SOUR:MAX? 2
```

Return Type Numeric

Default Not Applicable

SYSTem:CAPability:HARDware:ATTenuator:SOURce:STEP[:SIZE]? <portNum>

Applicable Models: N522xB, N523xB, N524xB, M937xA, E5080A, P937xA

(Read-only) Returns the step size of the source attenuator on the specified port.

Parameters

<portNum> Port number. Choose from the number of test ports on the analyzer.

Examples `SYST:CAP:HARD:ATT:SOUR:STEP? 2`

Return Type Numeric

Default Not Applicable

SYSTEM:CAPability:HARDware:DC:RECeiver:INTernal:CATalog?

Applicable Models: N522xB, N523xB, N524xB, M937xA, E5080A/B, P937xA

(Read-only) Returns a list of names of the internal DC receivers.

Parameters None

Examples `SYST:CAP:HARD:DC:REC:INT:CAT?`

Return Type String of internal DC receivers separated by commas.

For example, "AI1,AI2,AIG,AOS1,AOS2"

Default Not Applicable

SYSTEM:CAPability:HARDware:DC:RECeiver:INTernal:COUNt?

Applicable Models: N522xB, N523xB, N524xB, M937xA, E5080A/B, P937xA

(Read-only) Returns the number of internal DC receivers in the analyzer.

Parameters None

Examples `SYST:CAP:HARD:DC:REC:INT:COUN?`

Return Type Numeric

Default Not Applicable

SYSTEM:CAPability:HARDware:DC:SOURce:INTernal:CATalog?

Applicable Models: N522xB, N523xB, N524xB, M937xA, E5080A/B, P937xA

(Read-only) Returns a list of names of the internal DC sources.

Parameters None

Examples `SYST:CAP:HARD:DC:SOUR:INT:CAT?`

Return Type String of internal DC sources separated by commas.

For example, "AO1,AO2"

Default Not Applicable

SYSTem:CAPability:HARDware:DC:SOURce:INTernal:COUNT?

Applicable Models: N522xB, N523xB, N524xB, M937xA, E5080A/B, P937xA

(Read-only) Returns the number of internal DC sources in the analyzer.

Parameters None

Examples `SYST:CAP:HARD:DC:SOUR:INT:COUN?`

Return Type Numeric

Default Not Applicable

SYSTem:CAPability:HARDware:IF:MAXimum?

Applicable Models: N522xB, N523xB, N524xB

(Read-only) Returns the maximum IF frequency the instrument supports.

Parameters None

Examples `SYST:CAP:HARD:IF:MAX?`

Return Type Numeric

Default Not Applicable

SYSTem:CAPability:HARDware:IF:MINimum?

Applicable Models: N522xB, N523xB, N524xB

(Read-only) Returns the minimum IF frequency the instrument supports.

Parameters None

Examples `SYST:CAP:HARD:IF:MIN?`

Return Type Numeric

Default Not Applicable

SYSTem:CAPability:HARDware:LFEXtension:EXISts?

Applicable Models: N5222B, N5227B, N5242B, N5247B, N5290A, N5291A

(Read-only) Returns whether or not the VNA has the low frequency extension (LFE) installed. Learn more.

Parameters None

Examples `SYST:CAP:HARD:LFEX:EXISts?`

Return Type Boolean

Default Not Applicable

SYSTem:CAPability:HARDware:PORTs:CATalog?

Applicable Models: All

(Read-only) Returns a list of test port names including external testset ports.

Parameters None

Examples `SYST:CAP:HARD:PORT:CAT?`

Return Type String of port names separated by commas.

For example, "Port 1,Port 2,Port 3,Port 4".

Default Not Applicable

SYSTem:CAPability:HARDware:PORTs:COUNt?

Applicable Models: All

(Read-only) Returns the number of test ports including external testset ports.

Parameters None

Examples `SYST:CAP:HARD:PORT:COUN?`

Return Type Numeric

Default Not Applicable

SYSTEM:CAPability:HARDware:PORTs:INTernal:CATalog?

Applicable Models: All

(Read-only) Returns a list of internal test port names.

Parameters None

Examples `SYST:CAP:HARD:PORT:INT:CAT?`

Return Type String of port names separated by commas.

For example, "Port 1,Port 2,Port 3,Port 4".

Default Not Applicable

SYSTEM:CAPability:HARDware:PORTs:INTernal:COUNT?

Applicable Models: All

(Read-only) Returns the number of internal test ports.

Parameters None

Examples `SYST:CAP:HARD:PORT:INT:COUN?`

Return Type Numeric

Default Not Applicable

SYSTEM:CAPability:HARDware:PORTs:PNUMBER? <portName>

Applicable Models: All

(Read-only) Returns the port number associated with the specified port name.

Parameters None

<portName> String. Port name. Use **SYST:CAP:HARD:PORT:CAT?** to return a list of valid port names.

Examples `SYST:CAP:HARD:PORT:PNUM? "Port 1"`

Return Type Numeric

Default Not Applicable

SYSTem:CAPability:HARDware:PORTs:SOURce:CATalog?

Applicable Models: All

(Read-only) Returns a list of source port names, including any configured external sources.

Parameters None

Examples `SYST:CAP:HARD:PORT:SOUR:CAT?`

Return Type String of source port names separated by commas.

For example, "Port 1,Port 2,Port 3,Port 4, Port 1 Src 2".

Default Not Applicable

SYSTem:CAPability:HARDware:PORTs:SOURce:COUNt?

Applicable Models: All

(Read-only) Returns the number of source ports, including any configured external sources.

Parameters None

Examples `SYST:CAP:HARD:PORT:SOUR:COUN?`

Return Type Numeric

Default Not Applicable

SYSTem:CAPability:HARDware:PORTs:SOURce:INTernal:CATalog?

Applicable Models: All

(Read-only) Returns a list of internal source port names.

Parameters None

Examples `SYST:CAP:HARD:PORT:SOUR:INT:CAT?`

Return Type String of internal source port names separated by commas.

For example, "Port 1,Port 2,Port 3,Port 4, Port 1 Src 2"

Default Not Applicable

SYSTEM:CAPability:HARDware:PORTs:SOURce:INTernal:COUNT?

Applicable Models: All

(Read-only) Returns the number of internal source ports.

Parameters None

Examples `SYST:CAP:HARD:PORT:SOUR:INT:COUN?`

Return Type Numeric

Default Not Applicable

SYSTEM:CAPability:HARDware:POWer:DISCcrete:FREQUency:LIST <freqList>

Applicable Models: N522xB, N523xB, N524xB

(Read-Write) Sets or returns the list of discrete frequencies corresponding to the powers returned by the discrete min and max power list functions.

Parameters

<freqList> List of frequencies for which power is returned.

Examples `SYST:CAP:HARD:POW:DISC:FREQ:LIST 1e9,2e9,3e9,4e9`
`system:capability:hardware:power:discrete:frequency:list`
`10e6,100e6,1e9,10e9`

Query Syntax SYSTEM:CAPability:HARDware:POWer:DISCcrete:FREQUency:LIST?

Return Type Array

Default Not Applicable

SYSTem:CAPability:HARDware:POWer:DISCrete:MAXimum?

Applicable Models: N522xB, N523xB, N524xB

(Read-only) Returns a single max leveled power value (in dBm) indicating the most restrictive maximum for all discrete maximum powers (the minimum of all max leveled powers).

Parameters None

Examples

```
SYST:CAP:HARD:POW:DISC:MAX?
```

```
system:capability:hardware:power:discrete:maximum?
```

Return Type Double

Default Not Applicable

SYSTem:CAPability:HARDware:POWer:DISCrete:MAXimum:LIST?

Applicable Models: N522xB, N523xB, N524xB

(Read-only) Returns an array of max leveled power values (in dBm), where each element corresponds to the maximum leveled power possible for CW stimulus at the corresponding frequency set by the **SYSTem:CAPability:HARDware:POWer:DISCrete:FREQuency:LIST** command.

Parameters None

Examples

```
SYST:CAP:HARD:POW:DISC:MAX:LIST?
```

```
system:capability:hardware:power:discrete:maximum:list?
```

Return Type Array

Default Not Applicable

SYSTem:CAPability:HARDware:POWer:DISCrete:MINimum?

Applicable Models: N522xB, N523xB, N524xB

(Read-only) Returns a single minimum power value (in dBm) indicating the most restrictive minimum for all discrete minimum powers (the maximum of all minimum powers).

Parameters None

Examples

```
SYST:CAP:HARD:POW:DISC:MIN?
```

```
system:capability:hardware:power:discrete:minimum?
```

Return Type Double

Default Not Applicable

SYSTem:CAPability:HARDware:POWer:DISCrete:MINimum:LIST?

Applicable Models: N522xB, N523xB, N524xB

(Read-only) Returns an array of minimum power values (in dBm), where each element corresponds to the minimum power possible for CW stimulus at the corresponding frequency set by the **SYSTem:CAPability:HARDware:POWer:DISCrete:FREQuency:LIST** command.

Parameters None

Examples

```
SYST:CAP:HARD:POW:DISC:MIN:LIST?
```

```
System:capability:hardware:power:discrete:minimum:list?
```

Return Type Array

Default Not Applicable

SYSTem:CAPability:HARDware:POWer:PATH:CONFIg:ELEMent:CATalog?

Applicable Models: N522xB, N523xB, N524xB

(Read-only) Returns a string with the names of all valid RF path configuration elements.

Parameters None

Examples

```
SYST:CAP:HARD:POW:PATH:CONF:ELEM:CAT?
```

```
system:capability:hardware:power:path:conf:element:catalog?
```

Return Type String

Default Not Applicable

**SYSTem:CAPability:HARDware:POWer:PATH:CONFig:ELEMent[:STATe]
<element>,<setting>**

Applicable Models: N522xB, N523xB, N524xB

(Read-Write) Returns the name of the value for the given path element name or sets the value of a path element.

Parameters

- <element> String - Choose from all path elements listed with **SYST:CAP:HARD:POW:PATH:CONF:ELEM:CAT?**.
- <setting> String - Choose from all element settings listed with **SYST:CAP:HARD:POW:PATH:CONF:ELEM:VAL:CAT?**.

Examples

```
SYST:CAP:HARD:POW:PATH:CONF:ELEM "Src1Out1LowBand", "HiPwr"  
SYST:CAP:HARD:POW:PATH:CONF:ELEM:STAT "Port1Bypass", "Thru"
```

Query Syntax SYSTem:CAPability:HARDware:POWer:PATH:CONFig:ELEMent:STATe?
"Src2Out1LowBand"

Returns the setting for the specified element.

Return Type String
Default Not Applicable

**SYSTem:CAPability:HARDware:POWer:PATH:CONFig:ELEMent:VALue:CATalog?
<PathElementName>**

Applicable Models: N522xB, N523xB, N524xB

(Read-only) Returns all valid values for the given path configuration element.

Parameters

<PathElementName> (String) Chose from all path elements (see **PATH:CONF:ELEM:CAT?**)

Examples

```
SYST:CAP:HARD:POW:PATH:CONF:ELEM:VAL:CAT?  
syst:capability:hardware:power:path:conf:element:value:catalog?
```

Return Type String
Default Not Applicable

SYSTem:CAPability:HARDware:POWer:PORT <portNum>

Applicable Models: N522xB, N523xB, N524xB

(Read-Write) Sets and reads the port number for power range data. When two sources are available in combiner mode, refer to the portNum selections below.

Parameters

- <portNum> Port number. Choose from:
- 1 - Port 1.
 - 2 - Port 2.
 - 3 - Port 3 (4-port instrument) or Src2-Out1 (2-port instrument with option 224).
 - 4 - Port 4 (4-port instrument) or Src2-Out2 (2-port instrument with option 423).
 - 5 - Src2Out1LowBand (2-port with option 224 or 4-port with option 423).

Examples

```
SYST:CAP:HARD:POW:PORT 1
```

Query Syntax SYSTem:CAPability:HARDware:POWer:PORT?

Return Type Integer

Default Not Applicable

```
SYSTem:CAPability:HARDware:POWer:RANGe:FREQUency:STARt <num>
```

Applicable Models: N522xB, N523xB, N524xB

(Read-Write) Sets or returns the lower bound of the frequency range used for range based power min and max.

Parameters

- <num> Start frequency. Choose a number within the frequency limits of the analyzer. Units are Hz.

Examples

```
SYST:CAP:HARD:POW:RANG:FREQ:STAR 1e9
```

```
system:capability:hardware:power:range:frequency:start 1e9
```

Query Syntax SYSTem:CAPability:HARDware:POWer:RANGe:FREQUency:STARt?

Return Type Double

Default Not Applicable

SYSTem:CAPability:HARDware:POWer:RANGe:FREQuency:STOP <num>

Applicable Models: N522xB, N523xB, N524xB

(Read-Write) Sets or returns the upper bound of the frequency range used for range based power min and max.

Parameters

<num> Stop frequency. Choose a number within the frequency limits of the analyzer. Units are Hz.

Examples

```
SYST:CAP:HARD:POW:RANG:FREQ:STOP 2e9
```

Query Syntax

```
SYST:CAP:HARD:POW:RANG:FREQ:STOP?
```

Return Type

Double

Default

Not Applicable

SYSTem:CAPability:HARDware:POWer:RANGe:MAXimum?

Applicable Models: N522xB, N523xB, N524xB

(Read-only) Returns the minimum of all max leveled power values (in dBm) from range start frequency to stop frequency (inclusive).

Parameters None

Examples

```
SYST:CAP:HARD:POW:RANG:MAX?
```

Return Type

Double

Default

Not Applicable

SYSTem:CAPability:HARDware:POWer:RANGe:MINimum?

Applicable Models: N522xB, N523xB, N524xB

(Read-only) The maximum of all min power values (in dBm) from range start frequency to stop frequency (inclusive).

Parameters

Examples

```
SYST:CAP:HARD:POW:RANG:MIN?
```

Return Type

Double

Default

Not Applicable

SYSTem:CAPability:HARDware:POWer:RESet

Applicable Models: N522xB, N523xB, N524xB

(Write-only) Resets all power range properties to default values, as if the instrument had been preset. Power range type is set to SPECified, port number is set to 1 with all path configuration elements in their default states.

Parameters None

Examples

```
SYST:CAP:HARD:POW:RES
```

```
system:capability:hardware:power:reset
```

Default Not Applicable

SYSTem:CAPability:HARDware:POWer:TYPE <enum>

Applicable Models: N522xB, N523xB, N524xB

(Read-Write) Sets and reads the type of power range data (specified or typical) to be returned.

Parameters

<enum> Choose from:

SPECified - Warranted performance.

TYPical - Typical performance.

Examples

```
SYST:CAP:HARD:POW:TYPE SPEC
```

```
system:capability:hardware:power:type typical
```

Query Syntax SYSTem:CAPability:HARDware:POWer:TYPE?

Return Type Enumeration

Default SPECified

SYSTem:CAPability:HARDware:RBSWitch:EXISts? <portNum>

Applicable Models: All

(Read-only) Returns whether or not the specified port number has a reference bypass switch.

Parameters

<portNum> Port number. Choose from the number of test ports on the analyzer.

Examples

```
SYST:CAP:HARD:RBSW:EXIS? 2
```

Return Type

Boolean

1 - Yes, the test port has a reference bypass switch.

0 - No, the test port does NOT have a reference bypass switch.

Default Not Applicable

SYSTEM:CAPability:HARDware:RECeiver:INTernal:COUNT?

Applicable Models: All

(Read-only) Returns the number of receivers in the analyzer.

Parameters None

Examples

```
SYST:CAP:HARD:REC:INT:COUN?
```

Return Type

Numeric

Default Not Applicable

SYSTEM:CAPability:HARDware:RECeiver:DACCess?

Applicable Models: N522xB, N523xB, N524xB, E5080A

(Read-only) Returns whether or not the analyzer has direct receiver access (front-panel jumpers).

Parameters None

<bool> Choose from:

1 - Yes, the analyzer has direct receiver access.

0 - No, the analyzer does NOT have direct receiver access.

Examples `SYST:CAP:HARD:REC:DACC?`

Return Type Boolean

Default Not Applicable

SYSTEM:CAPability:HARDware:SOURce:COUNT?

Applicable Models: All

(Read-only) Returns the number of sources in the analyzer.

Parameters None

Examples `SYST:CAP:HARD:SOUR:COUN?`

Return Type Numeric

Default Not Applicable

SYSTEM:CAPability:IFBW:CATalog?

Applicable Models: All

(Read-only) Returns the list of supported IFBW values.

Parameters None

Examples `SYST:CAP:IFBW:CAT?`

Return Type Variant array of string values

Default Not Applicable

SYSTEM:CAPability:IFBW:MAXimum?

Applicable Models: All

(Read-only) Returns the maximum IFBW for the standard IF filter.

Parameters None

Examples `SYST:CAP:IFBW:MAX?`

Return Type Numeric

Default Not Applicable

SYSTem:CAPability:IFBW:MINimum?

Applicable Models: All

(Read-only) Returns the minimum IFBW for the standard IF filter.

Parameters None

Examples `SYST:CAP:IFBW:MIN?`

Return Type Numeric

Default Not Applicable

SYSTem:CAPability:LICenses:CATalog? <selection>

Applicable Models: All

(Read-only) Returns the list of licenses. See a list of common licenses. See `SYSTem:CAPability:HARDware:MODule:OPT` for options installed in a hardware of PXIe/USB VNAs.

Parameters

<selection> Choose from:

VALID - Return a list of licenses which have enabled VNA software features.

ALL - Return a list of all installed licenses in the Keysight License Manager including the ones not related to the VNA software.

IGNORED - Return a list of VNA software licenses which are either invalid or ignored. This can occur when a transportable license is transported to an instrument that does not support the license feature. In addition, this can occur when multiple licenses for the same base feature are installed and only the least restrictive license is used (the

more restrictive licenses are ignored). For example, when transporting multiple Spectrum Analyzer licenses to the same instrument, the license with the greatest frequency range is used and the other licenses are ignored.

Note: Licenses not related to the VNA software but installed on the instrument are not reported as ignored when using **IGNORED**.

Examples

```
SYST:CAP:LIC:CAT? ALL
```

```
"N5242B-423 ,N5242B-020 ,N5242B-021 ,N5242B-022 ,S93029A/B-1FP"
```

Return Type Variant array of string values

Default Not Applicable

SYSTem:CAPability:NBW:NOISe:CATalog?

Applicable Models: N522xB, N523xB, N524xB, M937xA, P937xA, M980xA, P50xxA

(Read-only) Returns the list of supported Noise Bandwidth values when using a noise receiver (option 029). [Learn more about Opt. 029.](#)

Parameters None

Examples

```
SYST:CAP:NBW:NOIS:CAT?
```

Return Type Variant array of string values

Default Not Applicable

SYSTem:CAPability:NBW:STD:CATalog?

Applicable Models: N522xB, N523xB, N524xB, M937xA, P937xA

(Read-only) Returns the list of supported Noise Bandwidth values when using the NA receiver for noise measurements (option 028). [Learn more about Opt 028.](#)

Parameters None

Examples

```
SYST:CAP:NBW:STD:CAT?
```

Return Type Variant array of string values

Default Not Applicable

SYSTem:CAPability:POINts:MAXimum?

Applicable Models: All

(Read-only) Returns the maximum number of points.

Parameters None

Examples SYST:CAP:POIN:MAX?

Return Type Numeric

Default Not Applicable

SYSTem:CAPability:POINts:MINimum?

Applicable Models: All

(Read-only) Returns the minimum number of points.

Parameters None

Examples SYST:CAP:POIN:MIN?

Return Type Numeric

Default Not Applicable

SYSTem:CAPability:PRESet:FREQuency:MAXimum?

Applicable Models: All

(Read-only) Returns the maximum specified frequency of the analyzer. Does not include any over-sweep. See also: **SYST:CAP:FREQ:MAX?**

Parameters None

Examples SYST:CAP:PRES:FREQ:MAX?

Return Type Numeric

Default Not Applicable

SYSTem:CAPability:PRESet:FREQuency:MINimum?

Applicable Models: All

(Read-only) Returns the minimum specified frequency of the analyzer. Does not include any under-sweep. See also: [SYST:CAP:FREQ:MIN?](#)

Parameters None

Examples `SYST:CAP:PRES:FREQ:MIN?`

Return Type Numeric

Default Not Applicable

SYSTem:CAPability:RBW:IMS:CATalog?

Applicable Models: N522xB, N523xB, N524xB, M937xA, P937xA

(Read-only) Returns the list of supported Resolution BW values for the IMSpectrum channel. Learn more about IMSpectrum.

Parameters None

Examples `SYST:CAP:RBW:IMS:CAT?`

Return Type Variant array of string values

Default Not Applicable

SYSTem:CAPability:RBW:SA:CATalog?

Applicable Models: All with Spectrum Analysis Options (S9x09xxA/B, S9x090A/B)

(Read-only) Returns the list of supported Resolution BW values for the SA channel. [Learn more about the SA application.](#)

Parameters None

Examples `SYST:CAP:RBW:SA:CAT?`

Return Type Variant array of string values

Default Not Applicable

SYSTem:CAPability:WINDows:MAXimum[:COUNT]?

Applicable Models: All

(Read-only) Returns the maximum number of windows. [Learn more.](#)

Parameters None

Examples `SYST:CAP:WIND:MAX?`

Return Type Numeric

Default Not Applicable

SYSTem:CAPability:WINDows:TRACes:MAXimum[:COUNT]?

Applicable Models: All

(Read-only) Returns the maximum number of traces per window. [Learn more.](#)

Parameters None

Examples `SYST:CAP:WIND:TRAC:MAX?`

Return Type Numeric

Default Not Applicable

SYSTem:CAPability:HARDware:MODule Commands

Returns various capabilities of the PXIe/USB VNA.

SYSTem:CAPability:HARDware:MODule:

COUNT?

SERial?

MODEl?

OPT?

FPGA?

| **COUNT?**

Click on a [red](#) keyword to view the command details.

See Also

- [Example Programs](#)
- [Guided Cal commands](#)
- [Synchronizing the Analyzer and Controller](#)
- [SCPI Command Tree](#)

SYSTem:CAPability:HARDware:MODule:COUNT?

Applicable Models: All but M9485A

(Read-only) Returns the number of modules that are part of the current VNA instance. [Learn more about Multiport VNA.](#)

Parameters None

Examples `SYST:CAP:HARD:MOD:COUNT?`

Return Type Numeric

Default Not Applicable

SYSTem:CAPability:HARDware:MODule<n>:SERial?

Applicable Models: All

(Read-only) Returns the serial number of the specified module.

Parameters

<n> Module number. This is the order in which the module appears in the Multiport VNA. This is not the slot number in a chassis. [Learn more about module number.](#)

Examples

```
SYST:CAP:HARD:MOD3:SERial?
```

Return Type String

Default Not Applicable

```
SYSTem:CAPability:HARDware:MODule<n>:MODEl?
```

Applicable Models: All

(Read-only) Returns the model number of the specified module. [See frequency ranges of VNA models.](#)

Parameters

<n> Module number. This is the order in which the module appears in the Multiport VNA. This is not the slot number in a chassis. [Learn more about module number.](#)

Examples

```
SYST:CAP:HARD:MOD3:MODEl?
```

Return Type String

Default Not Applicable

```
SYSTem:CAPability:HARDware:MODule<n>:OPT?
```

Applicable Models: All

(Read-only) Returns the options that are installed in the specified module. See a list of VNA options. See [SYSTem:CAPability:LICenses:CATalog?](#) for software product/options.

Parameters

<n> Module number. This is the order in which the module appears in the Multiport VNA. This is not the slot number in a chassis. [Learn more about module number.](#)

Examples

```
SYST:CAP:HARD:MOD3:OPT?
```

```
'Possible return string: "010,551"
```

Return Type A comma-separated string.

Default Not Applicable

```
SYSTem:CAPability:HARDware:MODule<n>:FPGA:COUNT?
```

Applicable Models: All

(Read-only) Returns the number of FPGA boards in the module.

Parameters

<n> Module number. This is the order in which the module appears in the Multiport VNA. [Learn more about module number.](#)

Examples

```
SYST:CAP:HARD:MOD3:FPGA:COUNT?
```

Return Type Numeric

Default Not Applicable

```
SYSTem:CAPability:HARDware:MODule<n>:FPGA<x>?
```

Applicable Models: All

(Read-only) Returns the version number of specified FPGA board.

Parameters

- <n> Module number. This is the order in which the module appears in the Multiport VNA. [Learn more about module number.](#)
- <x> FPGA board number. Choose from 1 to the value returned by `SYST:CAP:HARD:MOD<n>:FPGA:COUNT?`

Examples

```
SYST:CAP:HARD:MOD3:FPGA2?
```

Return Type String

Default Not Applicable

SYSTem: COMMunicate Commands

Controls and queries settings that affect the VNA system.

SYSTem:COMMunicate:

ECAL

- | [CATalog?](#)
- | [CLISt?](#)
- | [COUNT?](#)
- | [DMEMory](#)
 - | [CLEar](#)
 - | [IMPort](#)
- | [EXPort](#)
 - | [SNP](#)
- | [INFormation?](#)
- | [KNAME:INFormation?](#)
- | [LIST?](#)
- | [PATH:COUNT?](#)

GPIB

- | [PMETer](#)
- | [ADDRes](#)
- | [RDEVice](#)
 - | [CLOSE](#)
 - | [OPEN](#)
 - | [READ?](#)
 - | [RESet](#)
 - | [WBINary](#)
 - | [WBLock](#)
 - | [WRITe](#)

[LAN:HOSTname](#)

[PSENSor](#)

[TCPip:CONTRol?](#)

[USB:PMETer:CAT?](#)

VISA

- | [RDEVice](#)
 - | [CLOSE](#)
 - | [FIND?](#)
 - | [OPEN](#)
 - | [READ?](#)
 - | [RESet](#)
 - | [TIMEout](#)
 - | [WBINary](#)
 - | [WRITe](#)

Click on a keyword to view the command details.

See Also

- [Referring to Traces Channels Windows and Meas Using SCPI](#)
 - [Example Programs](#)
 - [Synchronizing the Analyzer and Controller](#)
 - [SCPI Command Tree](#)
-

SYSTem:COMMunicate:ECAL:CATalog?

Applicable Models: All

(Read-only) Returns the ID string of ECals that are connected to the VNA USB. Use the list to select a Ecal for Ecal calibration.

Parameters

Examples

```
SYST:COMM:ECAL:CAT?  
system:communicate:ecal:catalog?
```

Return Type Comma-delimited strings.

Default Not applicable

SYSTem:COMMunicate:ECAL<mod>:CLIST?

Applicable Models: All

(Read-only) Returns a list of characterizations stored in the specified ECal module.

Parameters

<mod> ECal module from which to read user characterization numbers. Choose from 1 to 50. If unspecified, value is set to 1.

Examples

```
Module 1 contains User Characterizations 1 and 3.  
SYST:COMM:ECAL:CLIST?  
  
'Returns the following (0 always indicates the factory  
characterization):  
  
0,1,3
```

Return Type Numeric list, separated by commas.

Default Not Applicable

SYSTem:COMMunicate:ECAL:COUNT?

Applicable Models: All

(Read-only) Returns the number of installed cal kits.

Examples SYST:COMM:ECAL:COUNT?

Query Syntax SYST:COMM:ECAL:COUNT?

Return Type Numeric

Default Not Applicable

SYSTem:COMMunicate:ECAL:DMEMory:CLEar <kitName>

Applicable Models: All

(Write-only) Deletes user characterizations from VNA disk memory.

Parameters

<kitName> Optional String argument. ECal Model, User Characterization name + " ECal", and serial number of the ECal module, separated by spaces. See examples below.

If unspecified, ALL User Characterizations that are stored in VNA disk memory are deleted.

Examples

'These examples all use "MyUserChar" as the User characterization name.'

'The "My User Char" characterization is deleted from disk memory.'

```
SYST:COMM:ECAL:DMEM:CLE "N4433A MyUserChar ECal 00001"
```

'All User characterizations are deleted from disk memory.'

```
SYST:COMM:ECAL:DMEM:CLE
```

Query Syntax Not Applicable

Default Not Applicable

SYSTem:COMMunicate:ECAL:DMEMory:IMPort <file>

Applicable Models:All

(Write-only) After the VNA disk memory is **Exported** to a file, use this command to Import the file into VNA disk memory, which allows the User Characterization to be used with the VNA and ECal module.

Note: An ECal confidence check can NOT be performed remotely from User Characterizations that are stored on the VNA disk.

Parameters

<file> String. Full path and file name of file that was exported.

Examples

```
SYST:COMM:ECAL:DMEM:IMP "c:\users\public\network analyzer\ECal  
User Characterizations/myDiskUserChar.euc"
```

Query Syntax Not Applicable

Default Not Applicable

SYSTem:COMMunicate:ECAL:EXPort <kit>[,<file>][,<NewName>]]

Applicable Models: All

(Write-only) Saves an existing ECal characterization to a file. Use this command to archive the user characterization or to move the characterization to a different VNA for use with the specified ECal module. After exporting the user characterization, use **SYST:COMM:ECAL:DMEM:IMPort** to make the user characterization available for use.

Parameters

<kit> String. Not case sensitive. ECal Model, User char name + " ECal", and serial number of the ECal module used for the characterization, separated by spaces. See examples below.

If the model and serial number of the module is not found, an error is returned.

[<file>] Optional String argument. Path and filename of the user characterization. If not specified, the file is saved using characterization name + ".euc". If the path is not specified, it is stored in C:/Program Files/Keysight/Network Analyzer/ECal User Characterizations/. The extension ".euc" is appended if one is not specified.

[<NewName>] Optional String argument. This allows you to change the name for the User Characterization. When specified, the new name is saved in the file with the characterization. If unspecified, the existing user characterization name is saved.

Note: If this argument is specified, the second argument (<file>) must also be specified.

Examples

'These examples all use "MyUserChar" as the User characterization name.'

'All parameters specified'

```
SYST:COMM:ECAL:EXP "N4433A MyUserChar ECal  
00001", "myUserChar.euc", "NewUserChar"
```

'First two parameters are specified'

```
system:communicate:ecal:export "N4691B MyUserChar ECal  
00500", "myUserChar.euc"
```

'Only first parameter is specified'

```
SYST:COMM:ECAL:EXP "N4433A MyUserChar ECal 00001"
```

Query Syntax Not Applicable

Default Not Applicable

SYSTEM:COMMunicate:ECAL:EXPort:SNP <kit>,<ecalState>,<snpFileName>

Applicable Models: All

(Write-only) Read S parameter of ECal Thru from the ECal memory and save it as s2p file.

Parameters

<kit> String. Not case sensitive. ECal Model, User char name + " ECal", and serial number of the ECal module used for the characterization, separated by spaces. See examples below.

If the model and serial number of the module is not found, an error is returned.

<ecalState> ECal transmission path. Choose from AB, AC, AD, BA, BC, BD, CA, CB, CD, DA, DB or DC. Not case sensitive.

<snpFileName> Path and filename of the output s2p file name.

Examples

```
SYST:COMM:ECAL:EXP "N4433A ECal 00001", "BC", "D:\ecalthru.s2p"
```

Query Syntax Not Applicable

Default Not Applicable

SYSTem:COMMunicate:ECAL<mod>:INFormation? [<char>]

Applicable Models: All

(Read-only) Reads the identification and characterization information from the specified ECal module.

Note: To read user-characterization information that is stored in VNA disk memory, then use `SYST:COMM:ECAL:KNAM:INF?`

Parameters

<mod> ECal module from which to read characterizations. Choose from 1 through 50. If unspecified, value is set to 1.

Do NOT assume the <mod> number is the order in which ECal modules were connected.

Use `SYST:COMM:ECAL:LIST?` to read a list of <mod> numbers of currently-attached ECal modules.

<char> Optional argument. Specifies which characterization to read information from. If not specified, value is set to CHAR0.

Choose from:

- CHAR0 Factory characterization (data that was stored in the ECal module by Keysight)
- CHAR1 User characterization #1
- CHAR2 User characterization #2
- - through -
- CHAR12 User characterization #12

Examples

```
SYST:COMM:ECAL2:INFormation? char5
```

'Example return string:

```
"ModelNumber: 85092-60007, SerialNumber: 01386, ConnectorType: N5FN5F, PortAConnector: Type N (50) female, PortBConnector: Type N (50) female, MinFreq: 30000, MaxFreq: 9100000000, NumberOfPoints: 250, Calibrated: July 4 2002"
```

Return Type Character

Default Not Applicable

SYSTem:COMMunicate:ECAL:KNAME:INFormation? <kitName>

Applicable Models: All

(Read-only) Reads the identification and characterization information from the specified ECal module or VNA disk memory.

[Learn more about User Characterization in VNA Disk Memory.](#)

Parameters

<kitName> String. ECal model and characterization to read information from, enclosed in quotes, in the following format:

<model> <name> **ECal** <serial number>

Where:

<model>: Always required

<name>:

- For the factory characterization, do not specify.
- For a user-characterization stored in the module, use **User <n>** in the string, where <n> is the user-characterization number. Not case sensitive. Separate User and <n> with a space.
- For a user-characterization stored in VNA disk memory, use <charName> from **SENS:CORR:CKIT:ECAL:CHAR:DMEM:SAVE <charName>**

ECal - not case sensitive

<serial number>: Optional. Include when two or more ECal modules with same model number are attached to the VNA,

Each item is separated with a space.

Examples

```
'For a factory characterization in module memory:  
SYST:COMM:ECAL:KNAM:INF? "N4433A ECal"  
  
'For user characterization in module memory with optional serial  
number:  
SYST:COMM:ECAL:KNAM:INF? "N4433A User 1 ECal 00028"  
  
'For user characterization "foo" in disk memory:  
SYST:COMM:ECAL:KNAM:INF? "N4433A foo ECal 00028"  
  
'Example return string:
```

```
"ModelNumber: N4433A, SerialNumber: 00028, ConnectorType:
N5FN5F, PortAConnector: Type N (50) female, PortBConnector: Type
N (50) female, MinFreq: 30000, MaxFreq: 9100000000,
NumberOfPoints: 250, Calibrated: July 4 2002"
```

Return Type String

Default Not Applicable

SYSTem:COMMunicate:ECAL:LIST?

Applicable Models: All

(Read-only) Returns a list of index numbers for ECal modules that are currently attached to the VNA. Use these numbers (called <mod> in VNAHelp) to refer to the ECal module using SCPI commands.

Examples

```
SYST:COMM:ECAL:LIST?

'If 2 modules are attached to the VNA
'then the returned list will be:

+1,+2

'If NO modules are attached to the VNA
'then the returned list will be:

+0
```

Return Type Numeric list, separated by commas.

Default Not Applicable

SYSTem:COMMunicate:ECAL<n>:PATH:COUNT? <path>

Applicable Models: All

(Read-only) Returns the number of unique states that exist for the specified path name on the selected ECal module.

This command performs exactly the same function as **CONT:ECAL:MOD:PATH:COUNT?**

Use the **CONT:ECAL:MOD:PATH:STAT** command to set the module into one of those states.

Use **SENS:CORR:CKIT:ECAL:PATH:DATA?** to read the data for a state.

Parameters

<n> USB number of the ECal module. Choose from 1 to 50.

If unspecified (only one ECal module is connected to the USB), <n> is set to 1.

If two or more modules are connected, use `SYST:COMM:ECAL:LIST?` to determine how many, and `SYST:COMM:ECAL:INF?` to verify their identities.

<path> Name of the path for which to read number of states. Choose from:

Reflection paths

- **A**
- **B**
- **C** (4-port modules)
- **D** (4-port modules)

Transmission paths

- **AB**
- **AC** (4-port modules)
- **AD** (4-port modules)
- **BC** (4-port modules)
- **BD** (4-port modules)
- **CD** (4-port modules)

Examples

```
SYST:COMM:ECAL:PATH:COUNT?  
system:communicate:ecal:path:count?
```

Return Type Integer

Default Not Applicable

`SYSTem:COMMunicate:GPIB:PMETer[:ADDRess] <num>` **Superseded**

Applicable Models: N522xB, N523xB, N524xB, M937xA, P937xA

Note: This command is replaced with **SYST:COMM:PSEnSor**

(Read-Write) Specifies the GPIB address of the power meter to be used in a source power calibration. When performing a source power cal, the VNA will search VISA interfaces that are configured in the Keysight IO Libraries on the VNA.

Parameters

<num> GPIB address of the power meter. Choose any integer between 0 and 30.

Examples

```
SYST:COMM:GPIB:PMET 13
```

```
system:communicate:gpiib:pmeter:address 14
```

Query Syntax SYSTem:COMMunicate:GPIB:PMETer[:ADDRESS]?

Return Type Numeric

Default 13

SYSTem:COMMunicate:GPIB:RDEvice:CLoSe <ID>

Applicable Models: N522xB, N523xB, N524xB, M937xA, P937xA

(Write only) Closes the remote GPIB session. This command should be sent when ending every successful OPEN session.

Parameters

<ID> Session identification number that was returned with the **OPEN?** command.

Examples

[See an example program](#)

Query Syntax Not Applicable

Default Not Applicable

SYSTem:COMMunicate:GPIB:RDEvice:OPEN <bus>, <addr>, <timeout>

Applicable Models: N522xB, N523xB, N524xB, M937xA, P937xA

(Read-Write) Initiates a GPIB pass-through session. First send this OPEN command, then send the OPEN query to read the session ID number. An existing GPIB pass-through session remains open after an instrument preset.

To learn more about GPIB pass-through capability, see the [example program](#).

Parameters

<bus> Bus ID number.

You can find the USB-GPIB adapter bus number by looking at the dialog that appears when the USB-GPIB device is connected. Error 1073 indicates the bus or address number is incorrect.

Use 0 (zero) when connected using a GPIB cable to the VNA controller port.

<addr> GPIB Address of the device to be controlled

<timeout> The amount of time (in milliseconds) to wait for a response from the remote device after sending a command. A "timeout" error is displayed after this time has passed without a response.

Examples [See an example program](#)

Query Syntax SYSTem:COMMunicate:GPIB:RDEvice:OPEN?

Returns the session identification number that is used when communicating with this device.

Return Type Numeric

Default Not Applicable

SYSTem:COMMunicate:GPIB:RDEvice:READ? <ID>

Applicable Models: N522xB, N523xB, N524xB, M937xA, P937xA

(Read-only) Returns data from the GPIB pass-through device.

Parameters

<ID> Session identification number that was returned with the **OPEN?** command.

Examples [See an example program](#)

Return Type String

Default Not Applicable

SYSTem:COMMunicate:GPIB:RDEvice:RESet

Applicable Models: N522xB, N523xB, N524xB, M937xA, P937xA

(Write-only) Performs the same function as **SYST:COMM:GPIB:RDEV:CLOS** except that ALL pass-through sessions are closed.

Examples `SYST:COMM:GPIB:RDEV:RES`

Query Syntax Not Applicable

Default Not Applicable

SYSTem:COMMunicate:GPIB:RDEvice:WBINary <ID>,<data>

Applicable Models: N522xB, N523xB, N524xB, M937xA, P937xA

(Write-only) Sends data to a GPIB pass-through device. This command requires a header that specifies the size of the data to be written. The header (described below) is not passed along to the device.

Use this command if too many embedded quotes prevent you from using **SYST:COMM:GPIB:RDEV:WRIT**.

Use **SYST:COMM:GPIB:RDEV:OPEN** to open the pass through session.

Parameters

- <ID> Session identification number that was returned with the **OPEN?** command.
- <data> Data to be sent to the GPIB pass-through device. Use the following syntax:

```
#<num digits><byte count><data bytes><NL><END>
```

<num_digits> specifies how many digits are contained in <byte_count>

<byte_count> specifies how many data bytes will follow in <data bytes>

Examples `SYSTem:COMMunicate:GPIB:RDEvice:WBINary 101,#17ABC+XYZ<nl><end>`

- always sent before data.

1 - specifies that the byte count is one digit (7).

7 - specifies the number of data bytes that will follow, not counting <NL><END>.

ABC+XYZ - Data block

<nl><end> - always sent at the end of block data.

The following example sends a line feed at the end.

```
SYST:COMM:GPIB:RDEV:WBIN 1, #210SYST:PRES<EOL>
```

The <EOL> represents your linefeed character.

Query Syntax Not Applicable

Default Not Applicable

SYSTEM:COMMunicate:GPIB:RDEvice:WBLock <ID>,<data>

Applicable Models: N522xB, N523xB, N524xB, M937xA, P937xA

(Write-only) Same as **SYSTEM:COMM:GPIB:RDEV:WBIN** (above) but the header **IS** passed along to the device.

Use this command if too many embedded quotes prevent you from using

SYST:COMM:GPIB:RDEV:WRIT.

Parameters

<ID> Session identification number that was returned with the **OPEN?** command.

<data> Data to be sent to the GPIB pass-through device. **See previous command.**

Examples See previous example.

Query Syntax Not Applicable

Default Not Applicable

SYSTEM:COMMunicate:GPIB:RDEvice:WRITe <ID>,<string>

Applicable Models: N522xB, N523xB, N524xB, M937xA, P937xA

(Write-only) Sends ASCII string data to the GPIB pass-through device.

A line feed is NOT appended to the string data. To send a line feed, see the example in **SYST:COMM:GPIB:RDEV:WBIN**.

Parameters

- <ID> Session identification number that was returned with the **OPEN?** command.
- <string> Commands to be sent to the GPIB pass-through device.

Examples [See an example program](#)

Query Syntax Not Applicable

Default Not Applicable

SYSTem:COMMunicate:LAN:HOSTname?

Applicable Models: All

(Read-only) Returns the LAN hostname that is visible in the Help, About Network Analyzer dialog box. [Learn more](#). This is the same information that is visible on the LXI compliance dialog.

Parameters None

Example `SYST:COMM:LAN:HOSTname?`

Return Type String

Default Not applicable

SYSTem:COMMunicate:PSEnSor <char>, <string>

Applicable Models: All

This command replaces **SYST:COMM:GPIB:PMET:ADDR**.

(Read-Write) Specifies the type and location of the power meter to be used in a source power calibration.

Parameters

<char> Type of power meter/ sensor. Choose from:

- **GPIB** GPIB power meter
- **USB** USB power sensor or USB power sensor
- **LAN** LAN enabled power meter
- **ANY** Any VISA resource string or a visa alias

<string> For **GPIB**, address of the power meter. Choose any integer between 0 and 30.

For **USB**, the ID string of the power meter or power sensor. Use **SYST:COMM:USB:PMET:CAT?** to see a list of ID strings of connected power meters and sensors.

For **LAN**, the hostname or IP address of the power meter.

For **ANY**, any VISA resource string or a visa alias.

Examples

```
SYST:COMM:PSEN gpib, "14"  
  
system:communicate:psensor usb, "Keysight  
Technologies,U2000A,MY12345678"  
  
syst:comm:psen lan, "mymeter.Keysight.com"  
  
syst:comm:psen any, "TCPIP0::mymeter.Keysight.com::5025::SOCKET"
```

Query Syntax SYSTem:COMMunicate:PSEnSor?

Return Type Character / String

Default GPIB

SYSTem:COMMunicate:USB:PMETer:CATalog?

Applicable Models: All

(Read-only) Returns the ID string of power meters / sensors that are connected to the VNA USB. Use the list to select a power sensor for a **source power cal**.

These meter/sensor ID strings can NOT be used as the resource string for configuring a USB-based PMAR (**SYST:CONF:EDEV:IOConfig**).

Parameters

Examples

```
SYST:COMM:USB:PMET:CAT?
```

```
system:communicate:usb:pmeter:catalog?
```

Return Type Comma-delimited strings. Two power sensor strings are separate by a semicolon.

Default Not applicable

SYSTEM:COMMunicate:TCPIp:CONTrol?

Applicable Models: All

(Read-only) Queries the TCP/IP port number to use for opening a TCP/IP socket control connection to the VNA. The control connection is used for two purposes:

1. To perform a Device Clear operation on the VNA
2. To detect when a Service Request (SRQ) event occurs on the VNA.

The port number can range from 5000 to 5099. The VNA will skip over 5025 as it is being used for the primary socket connection.

To detect an SRQ, your program sends the appropriate commands via the regular socket connection to set up for a SRQ event to occur the same sequence of commands as if you were sending them via GPIB. You write your program so that while your program is doing SCPI transactions on the standard socket connection, a second thread of execution in your program detects the SRQ on the control connection and responds to the event. When the SRQ event occurs, the VNA sends a SRQ +xxx/n message on the control connection (where /n is linefeed character, ASCII value 10 decimal). The xxx value in the SRQ +xxx/n string is the IEEE 488.2 status byte at the time the SRQ was generated. So listening for that on the control connection is how your program detects the event. If for your socket communication you're using a software API that provides for asynchronous communication via a callback mechanism (for example, if you're using Microsoft's winsock API, or their .NET Socket class as in the example program below), in that case your listener execution thread is created implicitly for you so your program doesn't have to create one explicitly.

Note: If this SCPI query is sent to the VNA via a SCPI parser other than a TCP/IP socket connection (for example, if sent via GPIB), the query is not applicable in that case and will return value of 0.

Parameters None

Example See example program

Return Type Integer

Default Not applicable

SYSTEM:COMMunicate:VISA:RDEvice:CLOSE <ID>

Applicable Models: N522xB, N523xB, N524xB, E5080A

(Write only) Closes the specified remote VISA session. VISA sessions should always be closed when you are finished communicating with the remote device. Use this command to close (end) each VISA session that was opened successfully using the **OPEN** command. If you have more than one open session, and need to close them all at the same time, it may be faster and easier to use the **RESet** command.

Parameters

<ID> VISA session number (see **SYST:COMM:VISA:RDEV:OPEN[?]**).

Examples

```
SYST:COMM:VISA:RDEV:CLOS 1
```

```
system:communicate:visa:rdevice:close 2
```

Query Syntax Not Applicable

Default Not Applicable

SYSTEM:COMMunicate:VISA:RDEvice:FIND? <VISA regex> [,<ADDRESS|ALIAS>]

Applicable Models: All

(Read-only) Returns a comma separated list of either VISA address strings or aliases.

Parameters

<VISA regex> (String) VISA regular expressions are expressions defined by the user to find devices that have been set up on the VISA interface. The following are examples of VISA regular expressions:

Interface	Expression
GPIB	GPIB[0-9]*::?*INSTR
PXI	PXI?*INSTR
VXI	VXI?*INSTR
GPIB-VXI	GPIB-VXI?*INSTR
GPIB and GPIB-VXI	GPIB?*INSTR
All VXI	?*VXI[0-9]*::?*INSTR
ASRL	ASRL[0-9]*::?*INSTR
All	?*INSTR or ?*

Note that using "INSTR" in the VISA regular expression finds "instruments." To search all interfaces, use "?*".

<ADDRESS|ALIAS> Optional. Determines whether addresses or aliases are returned.

Note: The list of aliases may have less or more entries than the list of addresses because not all addresses will have aliases, and one address can have more than one alias.

Examples

```

SYST:COMM:VISA:RDEV:FIND? "?*",ADDR
system:communicate:visa:rdevice:find? '*INSTR',alias

```

Return Type Variant

Default Addresses returned if no return-type specified

SYSTEM:COMMUNICATE:VISA:RDEVICE:OPEN <addr>, <timeout>

Applicable Models: N522xB, N523xB, N524xB, E5080A

(Read-Write) Initiates a VISA pass-through session for a device. Immediately after successfully sending this command, send an **OPEN?** query to retrieve the unique session ID that is to be used whenever communicating with the device. Pass-through sessions can be closed by using the **CLOSE** command, the **RESet** command, or by properly shutting down the instrument or the analyzer application. Presetting the instrument will not close existing pass-through sessions.

Note: When opening a socket session (addresses of type: “TCPIP[board]::host address::port::SOCKET”), you must use the appropriate VISA Address for the identifier argument. Using an alias to open a socket session is not currently supported. Aliases are allowed for all other types of supported sessions.

Parameters

- <addr> VISA Address or alias name of the device to be controlled
- <timeout> The amount of time (in milliseconds) to wait for a response from the remote device after sending a command. A "timeout" error is displayed after this time has passed without a response.

Examples

```
SYST:COMM:VISA:RDEV:OPEN 'TCPIP0::A-N5242A-10096::hislip1::INSTR',1000  
  
system:communicate:visa:rdevice:open 'MyAliasName',7000
```

Query Syntax

SYSTEM:COMMunicate:VISA:RDEVice:OPEN?

Returns the VISA session identification number to be used when communicating with this device.

Return Type

Numeric

Default

Not Applicable

Applicable Models: N522xB, N523xB, N524xB, E5080A

(Read-only) Returns data from the VISA pass-through device.

Parameters

- <ID> VISA session number (see **SYST:COMM:VISA:RDEV:OPEN[?]**).

Examples

```
SYST:COMM:VISA:RDEV:READ? 1  
  
system:communicate:visa:rdevice:read? 3
```

Return Type

String

Default

Not Applicable

SYSTem:COMMunicate:VISA:RDEvice:RESet

Applicable Models: N522xB, N523xB, N524xB, E5080A

(Write-only) Closes all currently open VISA pass-through sessions. See also **CLOSe** to close only one session at a time.

Examples `SYST:COMM:VISA:RDEV:RES`

Query Syntax Not Applicable

Default Not Applicable

SYSTem:COMMunicate:VISA:RDEvice:TIMEout <ID>, <timeout>

Applicable Models: All

(Read-Write) Sets or returns the timeout value (in milliseconds) for VISA pass-through commands for the specified VISA session ID.

Parameters

- <ID> VISA session number that was returned with the **OPEN?** command.
- <timeout> The amount of time (in milliseconds) to wait for a response from the remote device after sending a command. A "timeout" error is displayed after this time has passed without a response.

Examples `SYST:COMM:VISA:RDEV:TIM 1,6000`

`system:communicate:visa:rdevice:timeout 3,6000`

Query Syntax SYSTem:COMMunicate:VISA:RDEvice:TIMEout? <ID>

Returns the timeout value for the specified session ID.

Return Type Numeric

Default 2000

SYSTem:COMMunicate:VISA:RDEvice:WBINary <ID>,<data>

Applicable Models: N522xB, N523xB, N524xB, E5080A

(Write-only) Sends data to a VISA pass-through device. This command requires a header that specifies the size of the data to be written. The header (described below) is not passed along to the device.

Parameters

- <ID> VISA session number (see **SYST:COMM:VISA:RDEV:OPEN[?]**).
- <data> Data to be sent to the VISA pass-through device. Use the following syntax:

```
#<num digits><byte count><data bytes><NL><END>
```

<num_digits> specifies how many digits are contained in <byte_count>

<byte_count> specifies how many data bytes will follow in <data bytes>

Examples

```
SYSTem:COMMunicate:VISA:RDEvice:WBINary 1,#17ABC+XYZ<nl><end>
```

- always sent before data.

1 - specifies that the byte count is one digit (7).

7 - specifies the number of data bytes that will follow, not counting <NL><END>.

ABC+XYZ - Data block

<nl><end> - always sent at the end of block data.

The following example sends a line feed at the end.

```
SYST:COMM:VISA:RDEV:WBIN 1,#210SYST:PRES<EOL>
```

The <EOL> represents your linefeed character.

Query Syntax Not Applicable

Default Not Applicable

SYSTem:COMMunicate:VISA:RDEvice:WRITe <ID>,<string>

Applicable Models: N522xB, N523xB, N524xB, E5080A

(Write-only) Sends ASCII string data to the VISA pass-through device. If sending a command that returns data, follow with the **READ?** query.

Parameters

<ID> VISA session number (see **SYST:COMM:VISA:RDEV:OPEN[?]**).

<string> Commands to be sent to the VISA pass-through device.

Examples

```
SYST:COMM:VISA:RDEV:WRIT 1, '*IDN?'  
system:communicate:visa:rdevice:write 2, 'SYST:PRES'
```

Query Syntax Not Applicable

Default Not Applicable

SYSTem:CONFigure:MWAVE Commands

Controls and queries settings that affect Millimeter Wave measurements.

Millimeter Module Configuration

Banded Configuration Dialog

	Start	Stop	Multiplier
Multiplier RF IN:	10.000000000 MHz	26.500000000 GHz	1
Multiplier LO IN:	10.000000000 MHz	26.500000000 GHz	1
Test Port Frequency:	10.000000 MHz	26.500000000 GHz	

Broadband Configuration Dialog

SYSTem:CONFigure:M

SYSTem:CONFigure:

SYSTem:CONFigure:MI

SYSTem:CONFigure:M

SYSTem:CONFigure:MWAVE

SYSTem:CONFigure:MWAV

SYSTem:CONFigure:MWAV

SYSTem:CONFigure:MWAV

SYSTem:CONFigure:MWAVE

SYSTem:CONFigure:MWAV

SYSTem:CONFigure:MWAV

SYSTem:CONFigure:MWAV

SYSTem:CONFigure:MW

SYSTem:CONFigure:MW

SYSTem:CONFigure

SYSTem:CONFigure:M

SYSTem:CONFigure:

SYSTem:CONFigure:!

SYSTem:CONFigure:

SYSTem:CONFigure:MW/

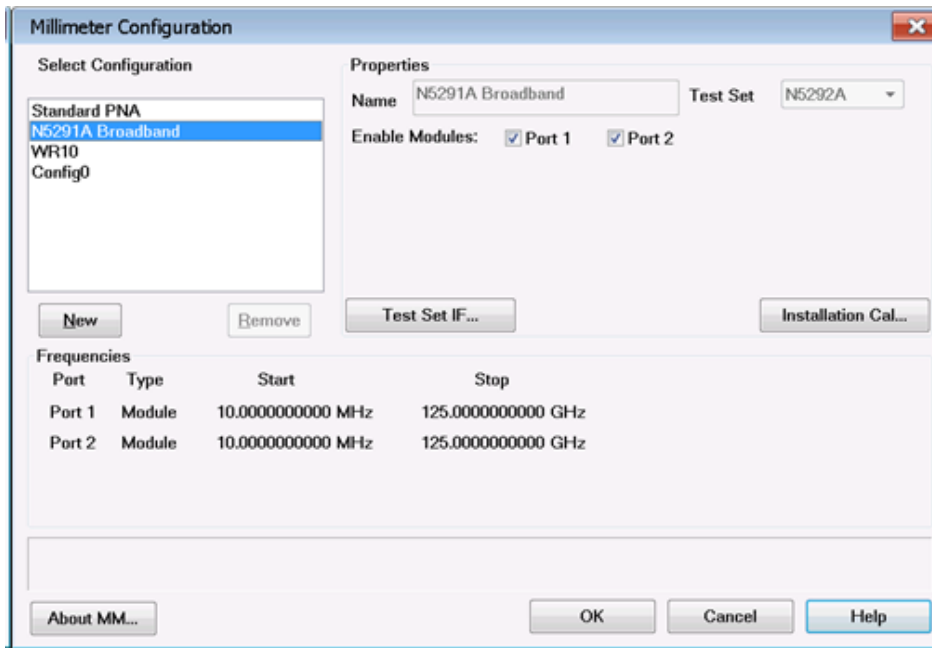

SYSTem:CONFigure:MMWAVE:CONF:ACTive <string>
SYSTem:CONFigure:MMWAVE:CONF:ACTive <string>
SYSTem:CONFigure:MMWAVE:CONF:ACTive <string>
SYSTem:CONFigure:MMWAVE:CONF:ACTive <string>
SYSTem:CONFigure:MMWAVE:CONF:ACTive <string>
SYSTem:CONFigure:MMWAVE:CONF:ACTive <string>
SYSTem:CONFigure:MMWAVE:CONF:ACTive <string>
SYSTem:CONFigure:MMWAVE:CONF:ACTive <string>
SYSTem:CONFigure:MMWAVE:CONF:ACTive <string>
SYSTem:CONFigure:MMWAVE:CONF:ACTive <string>
SYSTem:CONFigure:MMWAVE:CONF:ACTive <string>
SYSTem:CONFigure:MMWAVE:CONF:ACTive <string>
SYSTem:CONFigure:MMWAVE:CONF:ACTive <string>
SYSTem:CONFigure:MMWAVE:CONF:ACTive <string>
SYSTem:CONFigure:MMWAVE:CONF:ACTive <string>
SYSTem:CONFigure:MMWAVE:CONF:ACTive <string>

See Also

- N5251A Millimeter Module Configuration
- N5290A/N5291A Millimeter Module Configuration

SYSTem:CONFigure:MMWAVE:CONF:ACTive <string>

Applicable Models: N5261A, N5262A, N5252A, N5292A

(Read-Write) Set and return the active configuration.

Note: Any changes to configuration settings are not active until the SYSTem:CONFigure:MMWAVE:CONF:ACTive command is executed.

Parameters

<string> The name of the mmWave configuration to activate.

Examples

```
SYST:CONF:MMWAVE:CONF:ACT "N5291A Broadband" 'Set to broadband configuration  
SYST:CONF:MMWAVE:CONF:ACT "WR10" 'Set to banded configuration  
system:configure:mwave:conf:active "Standard PNA" 'Set to
```

standard PNA configuration

Query Syntax SYSTEM:CONFigure:MWAVe:CONF:ACTive?

Return Type String

Default Not applicable

SYSTEM:CONFigure:MWAVe:CONF:ACTive:CALibration:DATE?

Applicable Models: N5293A, N5295A

(Read-only) Return the calibration date of the active configuration's test set. Three integers are returned (year,month,day). All three integers will be 0 if there is no calibration data for the active test set.

Parameters None

Examples

```
SYST:CONF:MWAV:CONF:ACT:CAL:DATE?
```

```
system:onfigure:mwave:conf:active:calibration:date?
```

Return Type Integer

Default Not applicable

SYSTEM:CONFigure:MWAVe:CONF:ACTive:CALibration:TIME?

Applicable Models: N5293A, N5295A

(Read-only) Return the calibration time of the active configuration's test set. Three integers are returned (hour,minute,second). All three integers will be 0 if there is no calibration data for the active test set.

Parameters None

Examples

```
SYST:CONF:MWAV:CONF:ACT:CAL:TIME?
```

```
system:onfigure:mwave:conf:active:calibration:time?
```

Return Type Integer

Default Not applicable

SYSTEM:CONFigure:MWAVe:CONF:ACTive:MODEl?

Applicable Models: N5293A, N5295A

(Read-only) Return the model number of the active test set.

Parameters None

Examples

```
SYST:CONF:MWAV:CONF:ACT:MOD?  
system:onfigure:mwave:conf:active:model?
```

Return Type String

Default Not applicable

SYSTEM:CONF:figure:MWAVE:CONF:ACT:ive:OPT:ion?

Applicable Models: N5293A, N5295A

(Read-only) Return the option number of the active test set.

Parameters None

Examples

```
SYST:CONF:MWAV:CONF:ACT:OPT?  
system:onfigure:mwave:conf:active:option?
```

Return Type String

Default Not applicable

SYSTEM:CONF:figure:MWAVE:CONF:ACT:ive:PORT{1:4}:CAL:ibration:DATE?

Applicable Models: N5293A, N5295A

(Read-only) Return the calibration date of the active configuration's port. Three integers are returned (year,month,day). All three integers will be 0 if there is no calibration data for the active port.

Parameters None

Examples

```
SYST:CONF:MWAV:CONF:ACT:PORT1:CAL:DATE?  
system:onfigure:mwave:conf:active:port1:calibration:date?
```

Return Type Integer

Default Not applicable

SYSTEM:CONF:figure:MWAVE:CONF:ACT:ive:PORT{1:4}:CAL:ibration:TIME?

Applicable Models: N5293A, N5295A

(Read-only) Return the calibration time of the active configuration's port. Three integers are returned (hour,minute,second). All three integers will be 0 if there is no calibration data for the active port.

Parameters None

Examples

```
SYST:CONF:MWAV:CONF:ACT:PORT1:CAL:TIME?
```

```
system:onfigure:mwave:conf:active:port1:calibration:time?
```

Return Type Integer

Default Not applicable

SYSTem:CONFigure:MWAVe:CONF:ACTive:PORT{1:4}:MODEl?

Applicable Models: N5293A, N5295A

(Read-only) Return the model number of the frequency extender module connected to the specified port number.

Parameters None

Examples

```
SYST:CONF:MWAV:CONF:ACT:PORT1:MOD?
```

```
system:onfigure:mwave:conf:active:port1:model?
```

Return Type String

Default Not applicable

SYSTem:CONFigure:MWAVe:CONF:ACTive:PORT{1:4}:OPTion?

Applicable Models: N5293A, N5295A

(Read-only) Return the option number of the frequency extender module connected to the specified port number.

Parameters None

Examples

```
SYST:CONF:MWAV:CONF:ACT:PORT1:OPT?
```

```
system:onfigure:mwave:conf:active:port1:option?
```

Return Type String

Default Not applicable

SYSTem:CONFigure:MWAVe:CONF:ACTive:PORT{1:4}:SERial?

Applicable Models: N5293A, N5295A

(Read-only) Return the serial number of the frequency extender module connected to the specified port number.

Parameters None

Examples

```
SYST:CONF:MWAV:CONF:ACT:PORT1:SER?  
system:onfigure:mwave:conf:active:port1:serial?
```

Return Type String

Default Not applicable

SYSTem:CONFigure:MWAVe:CONF:ACTive:SERial?

Applicable Models: N5292A

(Read-only) Return the serial number of the test set.

Parameters None

Examples

```
SYST:CONF:MWAV:CONF:ACT:SER?  
system:onfigure:mwave:conf:active:serial?
```

Return Type String

Default Not applicable

SYSTem:CONFigure:MWAVe:CONF:ADD <string>

Applicable Models: N5261A, N5262A, N5252A, N5292A

(Read-Write) Add a banded mmWave configuration.

Parameters

<string> The name of the mmWave configuration to add.

Examples

```
SYST:CONF:MWAV:CONF:ADD "WR10"  
system:configure:mwave:conf:add "wr10"
```

Query Syntax SYSTem:CONFigure:MWAVe:CONF:ADD?

Return Type String

Default Not applicable

SYSTem:CONFigure:MWAVe:CONF:CATalog?

Applicable Models: N5261A, N5262A, N5252A, N5292A

(Read-only) Returns the list of mmWave configurations.

Parameters

Examples

```
SYST:CONF:MWAV:CONF:CAT?
```

```
system:configure:mwave:config:catalog?
```

Return Type Comma-delimited string.

Default Not applicable

SYSTem:CONFigure:MWAVe:CONF:REMOve <string>

Applicable Models: N5261A, N5262A, N5252A, N5292A

(Write-only) Remove a mmWave configuration.

Parameters

<string> The name of the mmWave configuration to remove.

Examples

```
SYST:CONF:MWAV:CONF:REM "WR10"
```

```
system:configure:mwave:conf:remove "wr10"
```

Return Type Not applicable

Default Not applicable

SYSTem:CONFigure:MWAVe:FREQuency:LO:MULTIplier <string>,<value>

Applicable Models: N5261A, N5262A, N5252A, N5292A

(Read-Write) Set and read the LO multiplier value for the specified configuration. The LO Frequency Range multiplied by this value equals the test port frequency. Learn more about frequency settings.

Note: Any changes to configuration settings are not active until the `SYSTem:CONFigure:MWAVe:CONF:ACTive` command is executed.

Parameters

<string> The name of the mmWave configuration.

<value> Choose a value within the range of the analyzer.

Examples

```
SYST:CONF:MWAV:FREQ:LO:MULT "WR10",8
```

```
system:onfigure:mwave:frequency:lo:multiplier "WR10",8
```

Query Syntax `SYSTem:CONFigure:MWAVe:FREQuency:LO:MULTiplier? "WR10"`

Return Type Integer

Default 1

`SYSTem:CONFigure:MWAVe:FREQuency:LO:SOURce <string>,<source>`

Applicable Models: N5261A, N5262A, N5292A

(Read-Write) Set and read the LO source for the specified configuration. Learn more.

Note: Any changes to configuration settings are not active until the `SYSTem:CONFigure:MWAVe:CONF:ACTive` command is executed.

Parameters

<string> The name of the mmWave configuration.

<source> The name of the LO source.

Examples

```
SYST:CONF:MWAV:FREQ:LO:SOUR "WR10","LO_Source"
```

```
system:onfigure:mwave:frequency:lo:source "WR10","LO_Source"
```

Query Syntax `SYSTem:CONFigure:MWAVe:FREQuency:LO:SOURce? "WR10"`

Return Type String

Default Internal LO source

`SYSTem:CONFigure:MWAVe:FREQuency:LO:STARt? <string>`

Applicable Models: N5261A, N5262A, N5252A, N5292A

(Read-only) Return the calculated LO start frequency using the LO multiplier for the specified configuration. Learn more about frequency settings.

Parameters

<string> The name of the mmWave configuration.

Examples

```
SYST:CONF:MWAV:FREQ:LO:STAR? "WR10"  
system:onfigure:mwave:frequency:lo:start? "WR10"
```

Return Type Double

Default Dependent on the range of the analyzer

SYSTem:CONFigure:MWAVe:FREQuency:LO:STOP? <string>

Applicable Models: N5261A, N5262A, N5252A, N5292A

(Read-only) Return the calculated LO stop frequency using the LO multiplier for the specified configuration. Learn more about frequency settings.

Parameters

<string> The name of the mmWave configuration.

Examples

```
SYST:CONF:MWAV:FREQ:LO:STOP? "WR10"  
system:onfigure:mwave:frequency:lo:stop? "WR10"
```

Return Type Double

Default Dependent on the range of the analyzer

SYSTem:CONFigure:MWAVe:FREQuency:RF:MULTIplier <string>,<value>

Applicable Models: N5261A, N5262A, N5252A, N5292A

(Read-Write) Set and read the RF multiplier value for the specified configuration. The RF Frequency Range multiplied by this value equals the test port frequency range. Learn more about frequency settings.

Note: Any changes to configuration settings are not active until the `SYSTem:CONFigure:MWAVe:CONF:ACTive` command is executed.

Parameters

- <string> The name of the mmWave configuration.
- <value> Choose a value within the range of the analyzer.

Examples

```
SYST:CONF:MWAV:FREQ:RF:MULT "WR10",6  
system:onfigure:mwave:frequency:rf:multiplier "WR10",6
```

Query Syntax `SYSTem:CONFigure:MWAVe:FREQuency:RF:MULTiplier? "WR10"`

Return Type Integer

Default 1

`SYSTem:CONFigure:MWAVe:FREQuency:RF:SOURce <string>,<source>`

Applicable Models: N5261A, N5262A, N5292A

(Read-Write) Set and read the RF source for the specified configuration. Learn more.

Note: Any changes to configuration settings are not active until the `SYSTem:CONFigure:MWAVe:CONF:ACTive` command is executed.

Parameters

- <string> The name of the mmWave configuration.
- <source> The name of the RF source.

Examples

```
SYST:CONF:MWAV:FREQ:RF:SOUR "WR10","RF_Source"  
system:onfigure:mwave:frequency:rf:source "WR10","RF_Source"
```

Query Syntax `SYSTem:CONFigure:MWAVe:FREQuency:RF:SOURce? "WR10"`

Return Type String

Default Internal RF source

`SYSTem:CONFigure:MWAVe:FREQuency:RF:STARt? <string>`

Applicable Models: N5261A, N5262A, N5252A, N5292A

(Read-only) Return the calculated RF start frequency using the RF multiplier for the specified configuration. Learn more about frequency settings.

Parameters

<string> The name of the mmWave configuration.

Examples

```
SYST:CONF:MWAV:FREQ:RF:STAR? "WR10"  
system:onfigure:mwave:frequency:rf:start? "WR10"
```

Return Type Double

Default Dependent on the range of the analyzer

SYSTem:CONFigure:MWAVe:FREQuency:RF:STOP? <string>

Applicable Models: N5261A, N5262A, N5252A, N5292A

(Read-only) Return the calculated RF stop frequency using the RF multiplier for the specified configuration. Learn more about frequency settings.

Parameters

<string> The name of the mmWave configuration.

Examples

```
SYST:CONF:MWAV:FREQ:RF:STOP? "WR10"  
system:onfigure:mwave:frequency:rf:stop? "WR10"
```

Return Type Double

Default Dependent on the range of the analyzer

SYSTem:CONFigure:MWAVe:FREQuency:STARt <string>,<value>

Applicable Models: N5261A, N5262A, N5252A, N5292A

(Read-Write) Set and read the start frequency for the specified configuration. Learn more about frequency settings.

Note: Any changes to configuration settings are not active until the `SYSTem:CONFigure:MWAVe:CONF:ACTive` command is executed.

Parameters

<string> The name of the mmWave configuration.

<value> The start frequency.

Examples

```
SYST:CONF:MWAV:FREQ:STAR "WR10",75e9
```

```
system:onfigure:mwave:frequency:start "WR10",75e9
```

Query Syntax `SYSTem:CONFigure:MWAVe:FREQuency:STAR? "WR10"`

Return Type Double

Default Dependent on the range of the analyzer

`SYSTem:CONFigure:MWAVe:FREQuency:STOP <string>,<value>`

Applicable Models: N5261A, N5262A, N5252A, N5292A

(Read-Write) Set and read the stop frequency for the specified configuration. Learn more about frequency settings.

Note: Any changes to configuration settings are not active until the `SYSTem:CONFigure:MWAVe:CONF:ACTive` command is executed.

Parameters

<string> The name of the mmWave configuration.

<value> The stop frequency.

Examples

```
SYST:CONF:MWAV:FREQ:STOP "WR10",110e9
```

```
system:onfigure:mwave:frequency:stop "WR10",110e9
```

Query Syntax `SYSTem:CONFigure:MWAVe:FREQuency:STOP? "WR10"`

Return Type Double

Default Dependent on the range of the analyzer

`SYSTem:CONFigure:MWAVe:SERial?`

Applicable Models: N5290A, N5291A

(Read-only) Return the serial number of the mmWave system.

Parameters None

Examples

```
SYST:CONF:MWAV:SER?  
  
system:onfigure:mwave:serial?  
  
"M42147691962"
```

Return Type String

Default Not applicable

SYSTEM:CONFigure:MWAVe:TSET:ALC <string>,<bool>

Applicable Models: N5261A, N5262A

(Read-Write) Enable or disable automatic power leveling for the specified configuration. Learn more about test set properties.

Note: Any changes to configuration settings are not active until the SYSTEM:CONFigure:MWAVe:CONF:ACTive command is executed.

Parameters

<string> The name of the mmWave configuration.

<bool> Choose from:

0 - OFF - Disable automatic power leveling control.

1 - ON - Enable automatic power leveling control.

Examples

```
SYST:CONF:MWAV:TSET:ALC "WR10",1  
  
system:onfigure:mwave:tset:alc "WR10",1
```

Query Syntax SYSTEM:CONFigure:MWAVe:TSET:ALC? "WR10"

Return Type Boolean

Default 1

SYSTEM:CONFigure:MWAVe:TSET:CATalog?

Applicable Models: N5261A, N5262A, N5292A

(Read-only) Returns the list of available test set names.

Parameters

Examples

```
SYST:CONF:MWAV:TSET:CAT?  
  
system:configure:mwave:tset:catalog?
```

Return Type Comma-delimited string.

Default Not applicable

SYSTem:CONFigure:MWAVe:TSET:MIXer <string>,<bool>

Applicable Models: N5261A, N5262A, N5292A

(Read-Write) Enable or disable mmWave mixer mode to allow mixer testing using the specified configuration. Learn more about test set properties.

Note: Any changes to configuration settings are not active until the SYSTem:CONFigure:MWAVe:CONF:ACTive command is executed.

Parameters

<string> The name of the mmWave configuration.

<bool> Choose from:

0 - OFF - Disable mmWave mixer mode.

1 - ON - Enable mmWave mixer mode.

Examples

```
SYST:CONF:MWAV:TSET:MIXer "WR10",0  
  
system:configure:mwave:tset:mixer "WR10",0
```

Query Syntax SYSTem:CONFigure:MWAVe:TSET:MIXer? "WR10"

Return Type Boolean

Default 0

SYSTem:CONFigure:MWAVe:TSET:NAME <string>,<name>

Applicable Models: N5261A, N5262A, N5292A

(Read-Write) Set and read the test set name for the specified configuration.

Note: Any changes to configuration settings are not active until the `SYSTEM:CONFigure:MWAVE:CONF:ACTive` command is executed.

Setting the test set name may reset the test set properties to default values, which includes the following:

- Enabled Modules
- Mixer Mode
- IF Gain
- Route to Rear Panel
- ALC Enabled
- Power Limit
- Power Offset
- Power Slope

Parameters

<string> The name of the mmWave configuration.

<name> The name of the test set.

Examples

```
SYST:CONF:MWAV:TSET:NAME "WR10","N5262A"
```

```
system:onfigure:mwave:tset:name "WR10","N5262A"
```

Query Syntax `SYSTEM:CONFigure:MWAVE:TSET:NAME? "WR10"`

Return Type String

Default Not applicable

`SYSTEM:CONFigure:MWAVE:TSET:PORT<port> <configuration>,<val>`

Applicable Models: N5261A, N5262A, N5292A

(Read-Write) This command enables or disables modules for individual ports on a particular configuration. If an N5292A test set is attached it will detect if a module is physically present and only allow this command on those ports.

Note: Any changes to configuration settings are not active until the `SYSTEM:CONFigure:MWAVE:CONF:ACTive` command is executed.

Parameters

- <port> Test set port number.
- <configuration> The name of the mmWave configuration. Use `SYSTEM:CONFigure:MWAVE:CONF:CATalog?` for a list of configuration names.
- <val> Enable/disable test set port. Choose from:
- 0 - OFF** - Disable test set port.
 - 1 - ON** - Enable test set port.

Examples

```
SYST:CONF:MWAV:TSET:PORT1 "WR10",1  
system:onfigure:mwave:tset:port1 "WR10",1
```

Query Syntax `SYSTEM:CONFigure:MWAVE:TSET:PORT1? "N5291A Broadband"`

Return Type Boolean

Default 0

`SYSTEM:CONFigure:MWAVE:TSET:PORT:COUNT? <string>`

Applicable Models: N5261A, N5262A, N5292A

(Read-only) Return the number of ports on a test set. Only the test set ports having frequency extenders attached are detected.

Parameters

- <string> The name of the mmWave configuration.

Examples

```
SYST:CONF:MWAV:TSET:PORT:COUNT? "N5291A Broadband"  
system:onfigure:mwave:tset:port:count? "N5291A Broadband"
```

Return Type Integer

Default Not applicable

SYSTem:CONFigure:MWAVe:TSET:POWer:LIMit <string>,<value>

Applicable Models: N5261A, N5262A, N5252A, N5292A

(Read-Write) Set and read the test set power limit for the specified configuration. Learn more about test set properties.

Note: Any changes to configuration settings are not active until the SYSTem:CONFigure:MWAVe:CONF:ACTive command is executed.

Parameters

- <string> The name of the mmWave configuration.
- <value> The power limit. Choose a value between -90 and +13 dBm.

Examples

```
SYST:CONF:MWAV:TSET:POW:LIM "WR10",11  
system:onfigure:mwave:tset:power:limit "WR10",11
```

Query Syntax SYSTem:CONFigure:MWAVe:TSET:POWer:LIMit? "WR10"

Return Type Double
Default 11 dBm

SYSTem:CONFigure:MWAVe:TSET:POWer:OFFSet <string>,<value>

Applicable Models: N5261A, N5262A, N5252A, N5292A

(Read-Write) Set and read the test set power offset for the specified configuration. Learn more about test set properties.

Note: Any changes to configuration settings are not active until the SYSTem:CONFigure:MWAVe:CONF:ACTive command is executed.

Parameters

- <string> The name of the mmWave configuration.
- <value> The power offset. Choose a value between -30 and +30 dB.

Examples

```
SYST:CONF:MWAV:TSET:POW:OFFS "WR10",0  
system:onfigure:mwave:tset:power:offset "WR10",0
```

Query Syntax SYSTem:CONFigure:MWAVe:TSET:POWer:OFFSet? "WR10"

Return Type Double
Default 0 dB

SYSTem:CONFigure:MWAVe:TSET:POWer:SLOPe <string>,<value>

Applicable Models: N5261A, N5262A, N5252A, N5292A

(Read-Write) Set and read the test set power slope for the specified configuration. Learn more about test set properties.

Note: Any changes to configuration settings are not active until the SYSTem:CONFigure:MWAVe:CONF:ACTive command is executed.

Parameters

- <string> The name of the mmWave configuration.
- <value> The power slope. Choose a value between -2 dB/GHz and +2 dB/GHz.

Examples

```
SYST:CONF:MWAV:TSET:POW:SLOP "WR10",.113  
system:onfigure:mwave:tset:power:slope "WR10",.113
```

Query Syntax SYSTem:CONFigure:MWAVe:TSET:POWer:SLOPe? "WR10"

Return Type Double

Default 0.113 dB/GHz

SYSTem:CONFigure:MWAVe:TSET:RPANel <string>,<bool>

Applicable Models: N5261A, N5262A

(Read-Write) Set and read the status of the RF power routing to the rear panel "SW SRC OUT" connector for the specified configuration.

Note: Any changes to configuration settings are not active until the SYSTem:CONFigure:MWAVe:CONF:ACTive command is executed.

Parameters

- <string> The name of the mmWave configuration.
- <bool> Choose from:
 - 0 - OFF** - Disable RF power routing to rear panel.
 - 1 - ON** - Enable RF power routing to rear panel "SW SRC OUT" connector.

Examples

```
SYST:CONF:MWAV:TSET:RPAN "WR10",1  
system:onfigure:mwave:tset:rpanel "WR10",1
```

Query Syntax SYSTem:CONFigure:MWAVe:TSET:RPANel? "WR10"

Return Type Boolean

Default 1

External Device Commands

Configures and makes settings for an external device.

SYSTem:CONFigure:EDEvice:

- | **ADD**
- | **CAT?**
- | **DRIVer**
- | **DTYPe**
- | **EXISts?**
- | **IOConfig**
- | **IOENable**
- | **LOAD**
- | **REMOve**
- | **SAVE**
- | **STATe**
- | **TOUT**

- | **DC More commands**
- | **PMAR More commands**
- | **PULSe More commands**

- | **SOURce:**
 - | **DPP**
 - | **MODulation**
 - | **CONTRol**
 - | **:STATe**
 - | **TMODe**
 - | **TPORt**

Click on a **red** keyword to view the command details.

See Also

- Learn about: [Configure an External Source](#)
- Learn about: [Configure a PMAR Device](#)
- Example: [Configure an External Source](#)
- Example: [Configure a PMAR Device](#)

- **SYST:PREF:ITEM:EDEV:DPOL** - Determines whether external devices remain activated or are de-activated when the VNA is Preset or when a Instrument State is recalled.
- [Synchronizing the Analyzer and Controller](#)
- [SCPI Command Tree](#)

SYSTem:CONFigure:EDEvice:ADD <name>

Applicable Models: All

(Write-only) Adds an external device to the list of configured devices. This is the same as pressing **New** on the [Select an external device](#) dialog.

Upon creation, all settings on the new device are set to the defaults. The device is not active until set using **SYST:CONF:EDEV:STAT**

Parameters

<name> String - Model and type of the external device.

To see a list of configured external devices, use **SYST:CONF:EDEV:CAT?**

Examples

```
SYST:CONF:EDEV:ADD "myDevice"
system:configure:edev:add "myDevice"
```

Query Syntax Not Applicable

Default Not Applicable

SYSTem:CONFigure:EDEvice:CAT?

Applicable Models: All

(Read-only) Returns a list of names of all configured devices. These are devices that appear in the [external devices](#) dialog.

Use **SENS:FOM:CAT?** to report all **active** devices.

Use **Source:CAT?** to report all **active** sources.

Parameters None

Example

```
SYST:CONF:EDEV:CAT?
system:configure:edev:cat
```

Return Type String of comma-separated devices. "Device0:Driver0, Device1:Driver1"

Default Not applicable

SYSTEM:CONFigure:EDEvice:DRIVER <name>,<value>

Applicable Models: All

(Read-Write) Sets and returns the external device driver (model).

Parameters

- <name> String - Name of the device.
- <value> String - External device driver (model). Choose from the following:
 - "AGPM" for all power meters.
 - "AGPULSEGEN" for supported pulse generators.
 - "DCSource" for all supported DC Sources
 - "DCMeter" for all supported DC Meters

[See a list of supported external source drivers.](#)

Examples

```
SYST:CONF:EDEV:DRIV "myDevice", "AGPM"  
system:configure:edev:driver "myDevice", "AGESG"
```

Query Syntax SYSTEM:CONFigure:EDEvice:DRIVER? <name>

Return Type String

Default "AGGeneric"

SYSTEM:CONFigure:EDEvice:DTYPE <name>,<type>

Applicable Models: All

(Read-Write) Sets and returns the Device Type for the external device.

Parameters

- <name> String - Name of the device to modify.
- <type> String - Device type - not case sensitive. Choose from:
- "None"**
 - "Source"** - external source
 - "Power Meter"** - power meter
 - "DC Meter"** - DC voltmeter
 - "DC Source"** - DC power supply
 - "Pulse Generator"** - external pulse generator
 - "SMU"** - Source Measure Unit

Examples

```
SYST:CONF:EDEV:DTYP "myDevice","Power Meter"  
system:configure:edev:dtype "myDevice","Source"
```

Query Syntax SYSTem:CONFigure:EDEVice:DTYPe? <name>

Return Type String

Default Source

SYSTem:CONFigure:EDEVice:EXISts? <string>

Applicable Models: All

(Read-only) Returns whether the named device is present on the bus for which it is configured.

Parameters

<string> Name of the external device.

Example `SYST:CONF:EDEV:EXIS? "MyPowerMeter"`

Return Type Boolean

- **0** - The device is not in the collection or the device fails to respond and times out when communication is attempted.
- **1** - The device responds when communication is attempted.

Default Not applicable

SYSTEM:CONFigure:EDEvice:IOConfig <name>,<value>

Applicable Models: All

(Read-Write) Sets and return the configuration path for the specified external device.

Parameters

<name> String - Name of the device.

<value> String - Configuration path. Any valid VISA resource shown in the IO Configuration field of the **external devices dialog**, enclosed in quotes.

Do NOT use the ID string of a PMAR USB power sensor as the resource string. The ID string is returned by `SYST:COMM:USB:PMET:CAT?`

Examples `SYST:CONF:EDEV:IOC "myDevice","GPIB0::13::INSTR"`

`system:configure:edev:ioconfig "myDevice","GPIB0::13::INSTR"`

Query Syntax `SYSTEM:CONFigure:EDEvice:IOConfig? <name>`

Return Type String

Default " " Empty String

SYSTEM:CONFigure:EDEvice:IOENable <name>,<value>

Applicable Models: All

(Read-Write) Enable or disable communication with an external device.

When disabled (OFF), the VNA will NOT attempt to connect to the external device regardless of the instrument state command (**SYST:CONF:EDEV:STATE**). Therefore, no errors will be produced if the device is not connected.

This command is useful for debugging and testing states when the external device is not connected. This command is unnecessary in ordinary operation (when the device is connected).

Parameters

<name> String - Name of the device.

<value> Boolean - Choose from:

OFF or **0** - Device communication disabled

ON or **1** - Device communication enabled

Examples

```
SYST:CONF:EDEV:IOEN "myDevice", ON  
system:configure:edev:ioenable "myDevice", 0
```

Query Syntax SYSTem:CONFigure:EDEVice:IOENable? <name>

Return Type Boolean

Default ON

SYSTem:CONFigure:EDEVice:LOAD <file>,<name>

Applicable Models: All

(Write-only) Recalls an external device configuration file from the VNA hard drive.

Currently, only DC Supply and DC Meter configuration files are supported. See more [DC Device commands](#).

Use **SYST:CONF:EDEV:SAVE** to save a configuration file.

Parameters

<file> String - Filename of the external device configuration file.

1. If <file> is not a full path, it is assumed to be a relative path based at "D:\Drivers".
2. The file specified using <file> cannot be the same file as "D:\Drivers\<name>.xml".

<name> String - Name of the external device. Currently, only DC Supply and DC Meter configuration files are supported.

Examples `SYST:CONF:EDEV:LOAD "D:\Drivers\MyConfigFile.xml", "MyDevice"`

Query Syntax Not Applicable

Default Not Applicable

SYSTem:CONFIgure:EDEVice:REMOve <name>

Applicable Models: All

(Write-only) Removes the specified device from the list of configured devices. If the device is a Source and both Active and I/O Enabled is checked (ON), then the RF power state is set to OFF. [Learn more.](#)

Parameters

<name> String - Name of the device. Not case sensitive. Use `SYST:CONF:EDEV:CAT?` to return a list of configured devices.

Examples `SYST:CONF:EDEV:REM "myDevice"`
`system:configure:edev:remove "myDevice"`

Query Syntax Not Applicable

Default Not Applicable

SYSTem:CONFIgure:EDEVice:SAVE <file>,<name>

Applicable Models: All

(Write-only) Saves an external device configuration file to the VNA hard drive.

Currently, only DC Supply and DC Meter configuration files are supported. See more [DC Device commands](#).

Use `SYST:CONF:EDEV:LOAD` to recall a configuration file.

Parameters

<file> String - Filename of the external device configuration file.

<name> String - Name of the external device. Currently, only DC Supply and DC Meter configuration files are supported.

Examples `SYST:CONF:EDEV:SAVE "myDevice.xml", "MyDCSupply"`

Query Syntax Not Applicable

Default Not Applicable

SYSTem:CONFigure:EDEvice:STATe <name>,<state>

Applicable Models: All

(Read-Write) Set and return the state of activation of the device. When **SYST:CONF:EDEV:IOEN** = ON, and this command is set to ON, the VNA will attempt communication with the external device.

Send this command **AFTER** sending other external device settings (especially **SYST:CONF:EDEV:DTYP**) to avoid communicating with the device before it has been fully configured.

See Also: **SYST:PREF:ITEM:EDEV:DPOL** - Determines whether external devices remain activated or are de-activated when the VNA is Preset or when a Instrument State is recalled.

Parameters

- <name> String - Name of the device.
- <state> Boolean - Choose from:
 - OFF** or **0** - Device is NOT activated
 - ON** or **1** - Device is activated.

Examples

```
SYST:CONF:EDEV:STAT "myDevice", ON
system:configure:edev:state "myDevice", 0
```

Query Syntax SYSTem:CONFigure:EDEvice:STATe? <name>

Return Type Boolean

Default OFF - When configured using the front panel user interface, the device is ON (activated) by default.

SYSTem:CONFigure:EDEvice:TOUT <name>,<value>

Applicable Models: All

(Read-Write) Set and return the time out value for the specified external device. This is the time allowed for communication with the device before an error is generated.

Parameters

<name> String - Name of the device.

<value> Time out value in seconds.

Examples

```
SYST:CONF:EDEV:TOUT "myDevice",2  
system:configure:edevicetout "myDevice",5
```

Query Syntax SYSTem:CONFigure:EDEVice:TOUT? <name>

Return Type Numeric

Default 20

SYSTem:CONFigure:EDEVice:SOURce:DPP <name>,<value>

Applicable Models: All

(Read-Write) Sets and returns the amount of time the VNA should wait after for an external source to settle before making a measurement at each data point. This setting applies to all channels that use this external source.

Parameters

<name> String - Name of the device.

<value> Dwell time in seconds.

Examples

```
SYST:CONF:EDEV:SOUR:DPP "myDevice",2  
system:configure:edevicetout "myDevice",.1
```

Query Syntax SYSTem:CONFigure:EDEVice:SOURce:DPP? <name>

Return Type Numeric

Default 3.114 e-3

SYSTem:CONFigure:EDEVice:SOURce:MODulation:CONTrol:STATe <name>,<state>

Applicable Models: N522xB, N523xB, N524xB, M937xA, E5080A

(Read-Write) Sets and reads the state of the modulation control. Modulation control must be ON to control the modulation of an external source.

Parameters

- <name> String - Name of the device.
- <state> **ON** (or 1) Enable control of external modulation.
OFF (or 0) Disable control of external modulation.

[Learn about these settings](#) and about [adding an external source](#).

Examples

```
SYST:CONF:EDEV:SOUR:MOD:CONT:STAT "qasmxg",1  
system:configure:edev:source:modulation:control:state  
"qasmxg",OFF
```

Query Syntax SYSTEM:CONF:igure:EDEV:ice:SOUR:ce:MOD:ulation:CONT:rol:STATe?
"qasmxg"

Default OFF

SYSTEM:CONF:igure:EDEV:ice:SOUR:ce:TMODe <name>,<value>

Applicable Models: All

(Read-Write) Sets and returns the trigger mode for an external source. [Learn more](#).

Parameters

- <name> String - Name of the device.
- <value> Trigger Mode. Choose from:
CW - Software CW mode
HW - Hardware list mode

Examples

```
SYST:CONF:EDEV:SOUR:TMOD "myDevice",CW  
system:configure:edev:source:tmode "myDevice",hw
```

Query Syntax SYSTEM:CONF:igure:EDEV:ice:SOUR:ce:TMODe? "myDevice"

Return Type Character

Default Depends on Source and VNA Model

SYSTem:CONFigure:EDEVice:SOURce:TPORt <name>,<value>

Applicable Models: N522xB, N523xB, N524xB, M937xA, M9485A, E5080A

(Read-Write) Sets and returns the VNA port through which an external source is to be triggered.

Parameters

<name> String - Name of the device.

<value> Trigger Port. Choose from **aux1** or **aux2**

Examples

```
system:configure:edevic:source:tport "myDevice",aux1
```

Query Syntax SYSTem:CONFigure:EDEVice:SOURce:TPORt? <name>

Return Type Character

Default **aux1**

SYSTem:CONF:EDEvice:DC Commands

Configures external SMU, DC Meter, and DC Source properties.

SYST:CONF:EDEvice:DC

| COMMand

| EXIT

| INIT

| LIMit

| POINt

| SET

| SWEep

| ABORt

| AFTer

| BEFore

| CORRection

| DPOint

| DSWeep

| LIMit

| CURRent

| VOLTage

| MAX

| [:STATe]

| VALue

| MIN

| [:STATe]

| VALue

| OFFSet

| QUERy

| ERRor

| ID

| SCALe

| TYPE

Click on a [red](#) keyword to view the command details.

See Also

- All [SYST:CONF:EDEV](#) commands
- [SOURce:DC](#) commands (make DC sweep settings)
- Learn about: [Configure an External DC Device](#)
- Learn about [Configure an External Device](#)
- [SYST:PREF:ITEM:EDEV:DPOL](#) - Determines whether External Devices remain activated or are de-activated when the VNA is Preset or when a Instrument State is recalled.
- [Synchronizing the Analyzer and Controller](#)
- [SCPI Command Tree](#)

SYSTem:CONFigure:EDEvice:DC:COMMand:EXIT <name>,<value>

Applicable Models: N522xB, N523xB, N524xB, M937xA, P937xA

(Read-Write) Sets and returns the Disable I/O command for an external DC Source and an external DC Meter.

Parameters

<name> String - Name of the device.

<value> String - The SCPI command used to disable the DC Source and DC Meter.

Examples

```
SYST:CONF:EDEV:DC:COMM:EXIT "myDCDevice", "OUTP OFF"
```

```
system:configure:edev:dc:command:exit "myDCDevice", "OUTP OFF"
```

Query Syntax SYSTem:CONFigure:EDEvice:DC:COMMand:EXIT? <name>

Return Type String

Default " " Empty String

SYSTem:CONFigure:EDEvice:DC:COMMand:INIT <name>,<value>

Applicable Models: N522xB, N523xB, N524xB, M937xA, P937xA

(Read-Write) Sets and returns the Enable I/O command for an external DC Source and an external DC Meter.

Parameters

- <name> String - Name of the device.
- <value> String - The SCPI command used to enable the DC Source and DC Meter.

Examples

```
SYST:CONF:EDEV:DC:COMM:INIT "myDCDevice", "OUTP ON"  
system:configure:edev:dc:command:init "myDCDevice", "OUTP ON"
```

Query Syntax SYSTem:CONFigure:EDEVice:DC:COMMand:INIT? <name>

Return Type String

Default " " Empty String

SYSTem:CONFigure:EDEVice:DC:COMMand:LIMit <name>, <cmd>

Applicable Models: N522xB, N523xB, N524xB, M937xA, P937xA

(Read-Write) Sets and returns a user-defined command string that is used to set the DC limit of the external DC source. The actual limit value is set using either the **SYST:CONF:EDEV:DC:LIM:VOLT** (voltage) or **SYST:CONF:EDEV:DC:LIM:CURR** (current). The limit command is sent to the external DC source at the beginning of a sweep for each channel. The firmware automatically selects the current or voltage limit value depending on the external DC source type.

Parameters

- <name> String - Name of the device.
- <cmd> String - User-defined command name: Include `{%f}` in the command string which will be substituted by the actual limit value.

Examples

```
SYST:CONF:EDEV:DC:COMM:LIM "myDCDevice", "Limit Command {%f}"  
system:configure:edev:dc:command:limit "myDCDevice", "Limit  
Command {%f}"
```

Query Syntax SYSTem:CONFigure:EDEVice:DC:COMMand:LIMit? <name>

Return Type String

Default Not Applicable

SYSTem:CONFigure:EDEVice:DC:COMMand:POINT:SET <name>,<value>

Applicable Models: N522xB, N523xB, N524xB, M937xA, P937xA

(Read-Write) Sets and returns the Point Read Commands for an external DC Meter or Point Set Commands for an external DC Source.

Parameters

<name> String - Name of the device.

<value> String -

For DC Source, sets the Point Set Commands. Use {%f} to specify a double value and {%d} to specify an integer.

For DC Meter, sets the Point Read Commands (for example, meas:volt?).

Examples

```
SYST:CONF:EDEV:DC:COMM:POIN:SET "myDCDevice","sour1:volt {%f}"  
  
system:configure:edev:dc:command:point:set  
"myDCDevice","meas:volt?"
```

Query Syntax SYSTem:CONFigure:EDEVice:DC:COMMand:POINt:SET? <name>

Return Type String

Default " " Empty String

SYSTem:CONFigure:EDEVice:DC:COMMand:SWEep:ABORt <name>,<value>

Applicable Models: N522xB, N523xB, N524xB, M937xA, P937xA

(Read-Write) Sets and returns the Abort Sweep command for an external DC Source and an external DC Meter.

Parameters

<name> String - Name of the device.

<value> String - The SCPI command used to abort or reset the DC Source or DC Meter.

Examples

```
SYST:CONF:EDEV:DC:COMM:SWE:ABOR "myDCDevice","ABORt"  
  
system:configure:edev:dc:command:sweep:abort  
"myDCDevice","ABORt"
```

Query Syntax SYSTem:CONFigure:EDEVice:DC:COMMand:SWEep:ABORt? <name>

Return Type String

Default " " Empty String

SYSTem:CONFigure:EDEvice:DC:COMManD:SWEep:AFTer <name>,<value>

Applicable Models: N522xB, N523xB, N524xB, M937xA, P937xA

(Read-Write) Sets and returns the After Sweep command for an external DC Source and an external DC Meter.

Parameters

- <name> String - Name of the device.
- <value> String - The SCPI command to be sent at the end of a sweep.

Examples

```
SYST:CONF:EDEV:DC:COMM:SWE:AFT "myDCDevice", "OUTP OFF"  
  
system:configure:edev:dc:command:sweep:after  
"myDCDevice", "OUTP OFF"
```

Query Syntax SYSTem:CONFigure:EDEvice:DC:COMManD:SWEep:AFTer? <name>

Return Type String

Default " " Empty String

SYSTem:CONFigure:EDEvice:DC:COMManD:SWEep:BEFore <name>,<value>

Applicable Models: N522xB, N523xB, N524xB, M937xA, P937xA

(Read-Write) Sets and returns the Before Sweep command for an external DC Source and an external DC Meter.

Parameters

- <name> String - Name of the device.
- <value> String - The SCPI command to be sent at the beginning of a sweep.

Examples

```
SYST:CONF:EDEV:DC:COMM:SWE:BEF "myDCDevice", "OUTP ON"  
  
system:configure:edev:dc:command:sweep:before  
"myDCDevice", "OUTP ON"
```

Query Syntax SYSTem:CONFigure:EDEvice:DC:COMManD:SWEep:BEFore? <name>

Return Type String

Default " " Empty String

SYSTem:CONFigure:EDEvice:DC:CORRection <name>,<value>

Applicable Models: N522xB, N523xB, N524xB, M937xA, P937xA

(Read-Write) Sets and returns the correction ON/OFF state for a DC Meter and a DC Source.

Parameters

- <name> String - Name of the device.
- <value> Correction ON/OFF state. Choose from:
 - ON or 1** - Turn Correction ON
 - OFF or 0** - Turn Correction OFF

Examples

```
SYST:CONF:EDEV:DC:CORR "myDCDevice",1
system:configure:edev:dc:correction "myDCDevice",OFF
```

Query Syntax SYSTem:CONFigure:EDEVice:DC:CORRection? <name>

Return Type Boolean

Default OFF

SYSTem:CONFigure:EDEVice:DC:DPOint <name>,<value>

Applicable Models: N522xB, N523xB, N524xB, M937xA, P937xA

(Read-Write) Sets and returns the "Dwell Before/After Point" value for an external DC Device which can be configured as either a DC Meter or a DC Source.

Parameters

- <name> String - Name of the device.
- <value> For DC Meter, the dwell time (in seconds) before making a data point measurement.

For DC Source, the dwell time (in seconds) after making a data point setting.

Examples

```
SYST:CONF:EDEV:DC:DPO "myDCDevice",10e-3
system:configure:edev:dc:dpoint "myDCDevice",.01
```

Query Syntax SYSTem:CONFigure:EDEVice:DC:DPOint? <name>

Return Type Numeric

Default 3 milliseconds

SYSTem:CONFigure:EDEVice:DC:DSWeep <name>,<value>

Applicable Models: N522xB, N523xB, N524xB, M937xA, P937xA

(Read-Write) Sets and returns the "Dwell Before Sweep" value for an external DC Device which can be configured as either a DC Meter or a DC Source.

Parameters

<name> String - Name of the device.

<value> The dwell time (in seconds) before making a new sweep.

Examples

```
SYST:CONF:EDEV:DC:DSW "myDCDevice",10e-3
system:configure:edev:dc:dswEEP "myDCDevice",.01
```

Query Syntax SYSTem:CONFigure:EDEVice:DC:DSWEEP? <name>

Return Type Numeric

Default 1 millisecond

SYSTem:CONFigure:EDEVice:DC:LIMit:CURRent <name>, <value>

Applicable Models: N522xB, N523xB, N524xB, M937xA, P937xA

(Read-Write) Sets and returns the maximum output current value of the external DC Source. This command supports Keysight B2900A and N6700 series devices only.

Parameters

<name> String - Name of the device.

<value> Current limit value.

Examples

```
SYST:CONF:EDEV:DC:LIM:CURR "myDCDevice",4
system:configure:edev:dc:limit:current "myDCDevice",1.25
```

Query Syntax SYSTem:CONFigure:EDEVice:DC:LIMit:CURRent? <name>

Return Type Double

Default 0

SYSTem:CONFigure:EDEVice:DC:LIMit:VOLTage <name>, <value>

Applicable Models: N522xB, N523xB, N524xB, M937xA, P937xA

(Read-Write) Sets and returns the maximum output voltage value of the external DC Source. This command supports Keysight B2900A and N6700 series devices only.

Parameters

<name> String - Name of the device.

<value> Voltage limit value.

Examples

```
SYST:CONF:EDEV:DC:LIM:VOLT "myDCDevice",4  
system:configure:edev:dc:limit:voltage "myDCDevice",1.25
```

Query Syntax SYSTem:CONFigure:EDEVice:DC:LIMit:VOLTage? <name>

Return Type Double

Default 0

SYSTem:CONFigure:EDEVice:DC:MAX[:STATe] <name>,<value>

Applicable Models: N522xB, N523xB, N524xB, M937xA, P937xA

(Read-Write) Sets and returns the "Define Max As" ON/OFF state for an external DC Source.

Parameters

<name> String - Name of the device.

<value> "Define Max As" ON/OFF state. Choose from:

ON or 1 - Turn "Define Max As" ON

OFF or 0 - Turn "Define Max As" OFF

Examples

```
SYST:CONF:EDEV:DC:MAX "myDCDevice",1  
system:configure:edev:dc:max:state "myDCDevice",OFF
```

Query Syntax SYSTem:CONFigure:EDEVice:DC:MAX:STATe? <name>

Return Type Boolean

Default ON

SYSTem:CONFigure:EDEVice:DC:MAX:VALue <name>,<value>

Applicable Models: N522xB, N523xB, N524xB, M937xA, P937xA

(Read-Write) Sets and returns the "Define Max As" value for an external DC Source.

Parameters

- <name> String - Name of the device.
- <value> Maximum value for the external DC Source (in volts).

Examples

```
SYST:CONF:EDEV:DC:MAX:VAL "myDCDevice",10
system:configure:edev:dc:max:value "myDCDevice",10
```

Query Syntax SYSTem:CONFIgure:EDEVice:DC:MAX:VALue? <name>

Return Type Double

Default 10

SYSTem:CONFIgure:EDEVice:DC:MIN[:STATe] <name>,<value>

Applicable Models: N522xB, N523xB, N524xB, M937xA, P937xA

(Read-Write) Sets and returns the "Define Min As" ON/OFF state for an external DC Source.

Parameters

- <name> String - Name of the device.
- <value> "Define Min As" ON/OFF state. Choose from:

ON or 1 - Turn "Define Min As" ON

OFF or 0 - Turn "Define Min As" OFF

Examples

```
SYST:CONF:EDEV:DC:MIN "myDCDevice",1
system:configure:edev:dc:min:state "myDCDevice",OFF
```

Query Syntax SYSTem:CONFIgure:EDEVice:DC:MIN:STATe? <name>

Return Type Boolean

Default ON

SYSTem:CONFIgure:EDEVice:DC:MIN:VALue <name>,<value>

Applicable Models: N522xB, N523xB, N524xB, M937xA, P937xA

(Read-Write) Sets and returns the "Define Min As" value for an external DC Source.

Parameters

- <name> String - Name of the device.
- <value> Minimum value for the external DC Source (in volts).

Examples

```
SYST:CONF:EDEV:DC:MIN:VAL "myDCDevice",-10  
system:configure:edev:dc:min:value "myDCDevice",-10
```

Query Syntax SYSTem:CONFIgure:EDEVice:DC:MIN:VALue? <name>

Return Type Double

Default -10

SYSTem:CONFIgure:EDEVice:DC:OFFSet <name>,<value>

Applicable Models: N522xB, N523xB, N524xB, M937xA, P937xA

(Read-Write) Sets and returns the offset correction value for an external DC Device which can be configured as either a DC Meter or a DC Source.

Parameters

- <name> String - Name of the device.
- <value> DC offset value.

The VNA will display readings from a DC Meter as:

$$\text{Display} = (\text{Meas'd value} - \text{Offset}) * \text{Scale}$$

The VNA will adjust the output from a DC Source as:

$$\text{Output} = (\text{Set value} - \text{Offset}) * \text{Scale}$$

Examples

```
SYST:CONF:EDEV:DC:OFFS "myDCDevice",4  
system:configure:edev:dc:offset "myDCDevice",1.25
```

Query Syntax SYSTem:CONFIgure:EDEVice:DC:OFFSet? <name>

Return Type Numeric

Default 0

SYSTem:CONFIgure:EDEVice:DC:QUERy:ERRor <name>,<value>

Applicable Models: N522xB, N523xB, N524xB, M937xA, P937xA

(Read-Write) Sets and returns the Error Query command for an external DC Source and an external DC Meter.

Parameters

- <name> String - Name of the device.
- <value> String - The SCPI command for returning DC Source and DC Meter errors.

Examples

```
SYST:CONF:EDEV:DC:QUER:ERR "myDCDevice", "SYST:ERR?"  
system:configure:edev:dc:query:error "myDCDevice", "SYST:ERR?"
```

Query Syntax SYSTem:CONFIgure:EDEVice:DC:QUERy:ERRor? <name>

Return Type String

Default "SYST:ERR?"

SYSTem:CONFIgure:EDEVice:DC:QUERy:ID <name>,<value>

Applicable Models: N522xB, N523xB, N524xB, M937xA, P937xA

(Read-Write) Sets and returns the ID Query command for an external DC Source and an external DC Meter.

Parameters

- <name> String - Name of the device.
- <value> String - The SCPI command for returning DC Source and DC Meter ID string.

Examples

```
SYST:CONF:EDEV:DC:QUER:ID "myDCDevice", "*IDN?"  
system:configure:edev:dc:query:error "myDCDevice", "*IDN?"
```

Query Syntax SYSTem:CONFIgure:EDEVice:DC:QUERy:ID? <name>

Return Type String

Default "*IDN?"

SYSTem:CONFIgure:EDEVice:DC:SCALE <name>,<value>

Applicable Models: N522xB, N523xB, N524xB, M937xA, P937xA

(Read-Write) Sets and returns the scale correction value for an external DC Device which can be configured as either a DC Meter or a DC Source.

Parameters

<name> String - Name of the device.

<value> DC Scale value.

The VNA will display readings from a DC Meter as:

```
Display = (Meas'd value - Offset) * Scale
```

The VNA will adjust the output from a DC Source as:

```
Output = (Set value - Offset) * Scale
```

Examples

```
SYST:CONF:EDEV:DC:SCAL "myDCDevice",1.2
```

```
system:configure:edev:dc:scale "myDCDevice",.5
```

Query Syntax SYSTem:CONFigure:EDEVice:DC:SCALE? <name>

Return Type Numeric

Default 1

SYSTem:CONFigure:EDEVice:DC:TYPE <name>,<value>

Applicable Models: N522xB, N523xB, N524xB, M937xA, P937xA

(Read-Write) Sets and returns the DC Type for an external DC Device which can be configured as either a DC Meter or a DC Source. This setting is used as the units for display on the VNA X-axis.

Parameters

<name> String - Name of the device.

<value> DC type. Choose from:

"dBm", "A", "V", "W", "K", "F", "C"

Examples

```
SYST:CONF:EDEV:DC:TYPE "myDCDevice","A"
```

```
system:configure:edev:dc:type "myDCDevice","w"
```

Query Syntax SYSTem:CONFigure:EDEVice:DC:TYPE? <name>

Return Type String

Default "V"



SYST:CONF:EDEvice:PMAR Commands

Configures and makes settings for an external Power Meter as Receiver.

SYSTem:CONFigure:EDEvice:PMAR

- | **CALibrate**
- | **FLIMit**
- | **FMAXimum**
- | **FMINimum**
- | **CFACtors**
 - | **STATe**
- | **READING:**
 - | **COUNT**
 - | **NTOLerance**
- | **SENSor**
 - | **CATalog?**
- | **TABLE:**
 - | **CFAC:**
 - | **DATA**
 - | **FREQuency**
 - | **LOSS:**
 - | **DATA**
 - | **FREQuency**
 - | **STATe**
 - | **RFACTOR**
- | **UNCertainty**
 - | **CATalog?**
 - | **FILE**
 - | **MODEl**
 - | **PLEVel?**
 - | **READ?**
- | **ZERO**

Click on a keyword to view the command details.

See Also

- Learn about: [Configure a Power Meter As Receiver](#)
- See root [SYST:CONF:EDEV](#) commands

- Learn about [Configure and External Device](#)
 - [SYST:PREF:ITEM:EDEV:DPOL](#) - Determines whether External Devices remain activated or are de-activated when the VNA is Preset or when a Instrument State is recalled.
 - [Synchronizing the Analyzer and Controller](#)
 - [SCPI Command Tree](#)
-

SYSTem:CONFigure:EDEVice:PMAR:CALibrate <name>

Applicable Models: All

(Write-only) Performs a calibration of the power sensor. Calibration usually involves connecting the power sensor to the meter's 1 mW reference.

- Keysight P-Series sensors have an internal reference so you can calibrate them using this command without connecting to the meters reference port.
- Keysight USB power sensors do not require calibrating.
- For other sensors, refer to the documentation to determine if it has calibration capability.

This command is always synchronous, so *OPC? is the only way to determine that the operation is complete. Set an I/O timeout of at least 20 seconds.

Parameters

<name> String - Name of the power meter.

Examples

```
SYST:CONF:EDEV:PMAR:CAL "myDevice"
system:configure:edev:pmar:calibrate "myDevice"
```

Query Syntax Not Applicable

Default Not Applicable

SYSTem:CONFigure:EDEVice:PMAR:FLIMit <name>,<value>

Applicable Models: All

(Read-Write) Enable or disable the power meter min and max frequencies.

Parameters

<name> String - Name of the power meter.

<value> Boolean. State of min and max frequency. Choose from:

OFF or **0** - Min and max frequencies disabled.

ON or **1** - Min and max frequencies enabled.

Examples

```
SYST:CONF:EDEV:PMAR:FLIM "myDevice", 0
```

```
system:configure:edevic:pmar:flimit "myDevice", ON
```

See example program

Query Syntax SYSTem:CONFIgure:EDEVice:PMAR:FLIMit? <name>

Return Type Boolean

Default OFF

SYSTem:CONFIgure:EDEVice:PMAR:FMAXimum <name>,<value>

Applicable Models: All

(Read-Write) Set and return the maximum frequency of the power meter.

Parameters

<name> String - Name of the power meter.

<value> Numeric - Max frequency in Hz.

Examples

```
SYST:CONF:EDEV:PMAR:FMAX "myDevice", 1e10
```

```
system:configure:edevic:pmar:fmaximum "myDevice", 3e9
```

See example program

Query Syntax SYSTem:CONFIgure:EDEVice:PMAR:FMAXimum? <name>

Return Type Numeric

Default Not Applicable

SYSTem:CONFIgure:EDEVice:PMAR:FMINimum <name>,<value>

Applicable Models: All

(Read-Write) Set and return the minimum frequency of the power meter.

Parameters

<name> String - Name of the power meter.

<value> Numeric - Min frequency in Hz.

Examples

```
SYST:CONF:EDEV:PMAR:FMIN "myDevice", 1e10  
system:configure:edevic:pmar:fminumum "myDevice", 3e9  
See example program
```

Query Syntax SYSTEM:CONF:igure:EDEV:ic:PMAR:FMAXimum? <name>

Return Type Numeric

Default Not Applicable

SYSTEM:CONF:igure:EDEV:ic:PMAR:CFACTors:STATe<name> <bool>

Applicable Models: All

(Read-Write) Enables/disables use of internal calibration factors for power sensors with built-in calibration factors and reads the current state.

Parameters

<name> String - Name of the power meter.

<bool> Choose from:

0 - OFF - Disables the use of internal calibration factors.

1 - ON - Enables the use of internal calibration factors.

[Learn about these settings.](#)

Examples

```
' This example script demonstrates the SCPI set/get of the "Use  
Internal Cal Factors" property  
  
' for an existing PMAR named 'MyPMAR'.  
  
Option Explicit  
  
dim app  
  
Set app = CreateObject("AgilentPNA835x.Application")  
  
dim scpi
```

```

Set scpi = app.ScpiStringParser

Dim opcReply

opcReply = scpi.Parse("SYST:PRES;*OPC?")

opcReply = scpi.Parse("SENS1:SWE:MODE HOLD;*OPC?")

scpi.Parse "SENS1:FREQ:CW 1E9"

scpi.Parse "SENS1:SWE:TYPE CW"

scpi.Parse "SENS1:SWE:POIN 3"

' Activate the PMAR and change the default trace to measure that
PMAR connected to port 3

scpi.Parse "SYST:CONF:EDEV:STAT 'MyPMAR', ON"

scpi.Parse "CALC1:PAR:SEL 'CH1_S11_1'"

scpi.Parse "CALC1:PAR:MOD:EXT 'MyPMAR,3'"

scpi.Parse "CALC1:FUNC:TYPE MEAN"

' Disable use of the sensor's internal cal factors, take a sweep
and report the Mean

scpi.Parse "SYST:CONF:EDEV:PMAR:CFAC:STAT 'MyPMAR', OFF"

scpi.Parse "SYST:CONF:EDEV:IOENable 'MyPMAR', ON"

opcReply = scpi.Parse("SENS1:SWE:MODE SING;*OPC?")

MsgBox "Use Internal Cal Factors = " &
scpi.Parse("SYST:CONF:EDEV:PMAR:CFAC:STAT? 'MyPMAR'") & ", Mean
measured val = " & scpi.Parse("CALC1:FUNC:EXEC;DATA?")

' Enable use of the sensor's internal cal factors, take another
sweep and report the Mean again

scpi.Parse "SYST:CONF:EDEV:IOENable 'MyPMAR', OFF"

scpi.Parse "SYST:CONF:EDEV:PMAR:CFAC:STAT 'MyPMAR', ON"

scpi.Parse "SYST:CONF:EDEV:IOENable 'MyPMAR', ON"

opcReply = scpi.Parse("SENS1:SWE:MODE SING;*OPC?")

MsgBox "Use Internal Cal Factors = " &
scpi.Parse("SYST:CONF:EDEV:PMAR:CFAC:STAT? 'MyPMAR'") & ", Mean
measured val = " & scpi.Parse("CALC1:FUNC:EXEC;DATA?")

```

Query Syntax SYSTEM:CONFigure:EDEvice:PMAR:CFACtors:STATE?

Return Type Boolean

Default 1

SYSTem:CONFigure:EDEVice:PMAR:READing:COUNT <name>,<value>

Applicable Models: All

(Read-Write) This command, along with SYST:CONF:EDEV:PMAR:READ:NTOL, allows for settling of the power sensor READINGS.

Set and return the maximum number of power readings that are taken at each stimulus point to allow for measurement settling. Each reading is averaged with the previous readings at that stimulus point.

When this average meets the Average:NTOLerance value or this number of readings has been made, the average is returned as the valid reading.

Parameters

<name> String - Name of the power meter.

<value> Number of readings. Choose a value between 1 and 1000

Examples

```
SYST:CONF:EDEV:PMAR:READ:COUN "myDevice", 20
```

```
system:configure:edev:pmar:reading:count "myDevice", 10
```

See example program

Query Syntax SYSTem:CONFigure:EDEVice:PMAR:READing:COUNT? <name>

Return Type Numeric

Default 3

SYSTem:CONFigure:EDEVice:PMAR:READing:NTOLerance <name>,<value>

Applicable Models: All

(Read-Write) This command, along with SYST:CONF:EDEV:PMAR:READ:COUN, allows for settling of the power sensor READINGS.

Each power reading is averaged with the previous readings at each stimulus point. When the average meets this nominal tolerance value, or the max number of readings has been made, the average is returned as the valid reading.

Parameters

- <name> String - Name of the power meter.
- <value> Power measurement settling tolerance value in dB. Choose any number between 0 and 5.

Examples

```
SYST:CONF:EDEV:PMAR:READ:NTOL "myDevice", .5
system:configure:edevic:pmar:reading:ntolerance "myDevice",.01
See example program
```

Query Syntax SYSTem:CONFigure:EDEVice:PMAR:READING:NTOLerance? <name>

Return Type Numeric

Default .05

SYSTem:CONFigure:EDEVice:PMAR:SENSor <name>,<value>

Applicable Models: All

(Read-Write) Sets and returns the power sensor channel (1 or 2) to be used. This performs the same function as the **Use this sensor only** checkbox.

Parameters

- <name> String - Name of the power meter.
- <value> Power Meter channel.
 - 1 - Channel A
 - 2 - Channel B

Examples

```
SYST:CONF:EDEV:PMAR:SENS "myDevice",2
system:configure:edevic:pmar:sensor "myDevice",1
See example program
```

Query Syntax SYSTem:CONFigure:EDEVice:PMAR:SENSor? <name>

Return Type Numeric

Default 1

SYSTem:CONFigure:EDEVice:PMAR:SENSor:CATalog? <name>

Applicable Models: All

(Read-only) Returns the power sensor channel assignment of the specified power meter.

Parameters

<name> String - Name of the power meter.

Examples

```
SYST:CONF:EDEV:PMAR:SENS:CAT? "myDevice"
```

```
system:configure:edevic:pmar:sensor:catalog? "myDevice"
```

Return Type Numeric

Default 1

SYSTem:CONFigure:EDEVice:PMAR:TABLE:CFAC:DATA <name>,<value>[,value]

Applicable Models: All

(Read-Write) Sets and returns the cal factor data for the power sensor.

Parameters

<name> String - Name of the power meter.

<value>[,value] Cal factor data in percent. For each frequency used with SYST:CONF:EDEV:PMAR:TABL:CFAC:FREQ, enter a cal factor number between 1 and 100.

Examples

```
SYST:CONF:EDEV:PMAR:TABL:CFAC:DATA "myDevice", 98,99,99
```

```
system:configure:edevic:pmar:table:cfac:data "myDevice",  
97,97,97
```

See example program

Query Syntax SYSTem:CONFigure:EDEVice:PMAR:TABLE:CFAC:DATA? <name>

Return Type Numeric - one number per table segment.

Default Not Applicable

SYSTem:CONFigure:EDEvice:PMAR:TABLE:CFAC:FREQuency <name>,<value>[,value]

Applicable Models: All

(Read-Write) Sets and returns the cal factor frequencies for the power sensor.

Parameters

<name> String - Name of the power meter.

<value>[,value] Cal factor frequencies in Hz.

Examples

```
SYST:CONF:EDEV:PMAR:TABL:CFAC:FREQ "myDevice", 1e7,1e8,1e9  
  
system:configure:edevic:pmar:table:cfac:frequency "myDevice",  
5e7,5e8,5e9  
  
See example program
```

Query Syntax SYSTem:CONFigure:EDEvice:PMAR:TABLE:CFAC:FREQuency?<name>

Return Type Numeric - one number per table segment.

Default Not Applicable

SYSTem:CONFigure:EDEvice:PMAR:TABLE:LOSS:DATA <name>,<value>[,value]

Applicable Models: All

(Read-Write) Sets and returns the power loss data for the power sensor.

Each table can contain up to 9999 segments. Values can also be loaded using the Characterize Adapter macro.

Parameters

<name> String - Name of the power meter.

<value>[,value] Loss data in dB. POSITIVE values in dB are interpreted as LOSS. To compensate for gain, use negative values.

For each frequency used with SYST:CONF:EDEV:PMAR:TABL:LOSS:FREQ, enter a cal factor number between 1 and 100.

Examples

```
SYST:CONF:EDEV:PMAR:TABL:LOSS:DATA "myDevice", .01, .02, .03  
  
system:configure:edevic:pmar:table:loss:data "myDevice",  
.04, .05, .06  
  
See example program
```

Query Syntax SYSTem:CONFigure:EDEVice:PMAR:TABLE:CFAC:DATA? <name>
Return Type Numeric - one number per table segment.
Default Not Applicable

SYSTem:CONFigure:EDEVice:PMAR:TABLE:LOSS:FREQuency <name>,<value>[,value]

Applicable Models: All

(Read-Write) Sets and returns frequencies for the power loss data.

Parameters

<name> String - Name of the power meter.
<value>[,value] Power Loss frequencies in Hz.

Examples

```
SYST:CONF:EDEV:PMAR:TABL:LOSS:FREQ "myDevice",1e7,1e8,1e9  
  
system:configure:edevic:pmar:table:loss:frequency  
"myDevice",5e7,5e8,5e9  
  
See example program
```

Query Syntax SYSTem:CONFigure:EDEVice:PMAR:TABLE:LOSS:FREQuency? <name>
Return Type Numeric - one number per table segment.
Default Not Applicable

SYSTem:CONFigure:EDEVice:PMAR:TABLE:LOSS:STATe <name>,<value>

Applicable Models: All

(Read-Write) Sets and returns whether to use the power loss table.

Parameters

<name> String - Name of the power meter.
<value> Boolean. State of the power loss table. Choose from:
OFF or **0** - Power loss table not used.
ON or **1** - Power loss table used.

Examples

```
SYST:CONF:EDEV:PMAR:TABL:LOSS:STAT "myDevice",1  
system:configure:edevic:pmar:table:loss:state "myDevice",1  
See example program
```

Query Syntax SYSTem:CONFigure:EDEVice:PMAR:TABLE:LOSS:STATe? <name>

Return Type Boolean

Default OFF

SYSTem:CONFigure:EDEVice:PMAR:TABLE:RFACtor <name>,<value>

Applicable Models: All

(Read-Write) Sets and returns the reference cal factor for the power sensor.

Note: If the sensor connected to the power meter contains cal factors in EPROM (such as the Keysight E-series power sensors), those will be the cal factors used. The reference cal factor value associated with this command, and any cal factors entered into the VNA for that sensor channel, will not be used.

Parameters

<name> String - Name of the power meter.

<value> Reference cal factor in percent. Choose any number between 1 and 150.

Examples

```
SYST:CONF:EDEV:PMAR:TABL:RFAC "myDevice", 1  
system:configure:edevic:pmar:table:rfactor "myDevice", 1  
See example program
```

Query Syntax SYSTem:CONFigure:EDEVice:PMAR:TABLE:RFACtor? <name>

Return Type Numeric

Default 100

SYSTem:CONFigure:EDEVice:PMAR:UNCertainty:CATalog?

Applicable Models: N522xB, N523xB, N524xB (requires Option S93015A)

(Read-only) Returns a list of available power meters that have power uncertainty.

Parameters

<name> String - Name of the device used as power meter which has uncertainty data available from the external device list.

Examples

```
SYST:CONF:EDEV:PMAR:UNC:CAT?  
system:configure:edevic:pmar:uncertainty:catalog?
```

Return Type Comma separated string

Default Not Applicable

SYSTEM:CONFigure:EDEVice:PMAR:UNCertainty:FILE <name>,<FilePath>

Applicable Models: N522xB, N523xB, N524xB (requires Option S93015A)

(Read-Write) Sets and returns a custom model uncertainty file containing all of the power meter uncertainty properties. When this command is executed, the model name is automatically set to "CustomFile".

Parameters

<name> String - Name of the device used as the power meter.

<FilePath> Full path to the custom file.

Examples

```
SYST:CONF:EDEV:PMAR:UNC:FILE  
"myDevice", "C:\U8485A_MY55140018.dat"  
system:configure:edevic:pmar:uncertainty:file  
"myDevice", "C:\U8485A_MY55140018.dat"
```

Query Syntax SYSTEM:CONFigure:EDEVice:PMAR:UNCertainty:FILE? <name>

Return Type String

Default Not Applicable

SYSTEM:CONFigure:EDEVice:PMAR:UNCertainty:MODEL <name>,<PwrMtrModel>

Applicable Models: N522xB, N523xB, N524xB (requires Option S93015A)

(Read-Write) Sets and returns the name assigned to a specific power meter model among those available for uncertainty (see **SYSTem:CONFigure:EDEVice:PMAR:UNC:CAT?**).

Parameters

- <name> String - Name of the device used as the power meter.
- <PwrMtrModel> String - Specific power meter model.

Examples

```
SYST:CONF:EDEV:PMAR:UNC:MOD "myPowerMeter", "N8488A"  
  
system:configure:edevic:pmar:uncertainty:model  
"myPowerMeter", "N8488A"
```

Query Syntax SYSTem:CONFigure:EDEVice:PMAR:UNCertainty:MODEl? <name>

Return Type String

Default Not Applicable

SYSTem:CONFigure:EDEVice:PMAR:UNCertainty:PLEVel? <name>

Applicable Models: N522xB, N523xB, N524xB (requires Option S93015A)

(Read-only) Returns the power level associated with the best accuracy for a specific power meter.

Note: This is typically the level where the calfactor was obtained.

Parameters

- <name> String - Name of the device used as the power meter.

Examples

```
SYST:CONF:EDEV:PMAR:UNC:PLEV? "myDevice"  
  
system:configure:edevic:pmar:uncertainty:plevel? "myDevice"
```

Return Type Double (dBm)

Default Not Applicable

SYSTem:CONFigure:EDEVice:PMAR:UNCertainty:READing? <name>,<frequency>,<power>

Applicable Models: N522xB, N523xB, N524xB (requires Option S93015A)

(Read-only) Returns the power uncertainty associated with the specific power meter at the specified frequency and power. The returned value is the variance of the power expressed in $[mW]^2$.

Parameters

<name> String - Name of the device used as the power meter.

<frequency> Frequency (Hz).

<power> Power (dBm).

Examples

```
SYST:CONF:EDEV:PMAR:UNC:READ? "myDevice",10e9,0.0  
  
system:configure:edevic:pmar:uncertainty:read?  
"myDevice",10e9,0.0
```

Return Type Double (W^2)

Default Not Applicable

SYSTem:CONFigure:EDEVice:PMAR:ZERO <name>[,SYNC,<value>]

Applicable Models: All

(Write-only) Performs a zeroing of the PMAR device.

This command is always synchronous, so *OPC? is the only way to determine that the operation is complete. Set an I/O timeout of at least 20 seconds.

Keysight P-Series sensors do ONLY Internal zeroing. These, and Keysight USB power sensors when Internal is selected, do NOT require disconnecting from the measurement path before zeroing.

All other Keysight sensors do ONLY External zeroing.

Parameters

<name> String - Name of the power meter.

[,SYNC,<value>] Optional argument for use with power sensors that support both internal and external types of zeroing such as Keysight USB power sensors.

Choose from:

SYNC,INTernal - Internal zeroing. Power is automatically removed from the sensor input before zeroing occurs (Default setting).

SYNC,EXTernal - External zeroing. First remove the sensor input, then send this command. External zeroing is recommended for powers below -30 dBm with the U2000-Series sensors (-20 dBm for the H models).

Examples

```
SYST:CONF:EDEV:PMAR:ZERO "myDevice"
```

```
system:configure:edevic:pmar:zero "myDevice",sync,internal
```

Query Syntax Not Applicable

Default Not Applicable

SYSTem:CONF:EDEVice:PULSe Commands

Configures and makes settings for an external Keysight 81110A Pulse Generator.

SYST:CONF:EDEVice:PULSe

- | [CHAN](#)
- | [HAMP](#)
- | [LAMP](#)
- | [LIMP](#)
- | [MMODE](#)
- | [SIMP](#)

Click on a keyword to view the command details.

See Also

- Root [SYST:CONF:EDEV](#) commands
- All [Integrated Pulse App](#) commands
- Learn about: [Configure an External Pulse Generator](#)
- Learn about [Configure and External Device](#)
- [SYST:PREF:ITEM:EDEV:DPOL](#) - Determines whether External Devices remain activated or are de-activated when the VNA is Preset or when a Instrument State is recalled.
- [Synchronizing the Analyzer and Controller](#)
- [SCPI Command Tree](#)

SYSTem:CONF:igure:EDEVice:PULSe:CHAN <name>,<value>

Applicable Models: All

(Read-Write) Sets and returns the output channel of the pulse generator.

Parameters

- <name> String - Name of the external pulse generator.
- <value> Pulse Generator output port. Choose from 1 or 2.

Examples

```
SYST:CONF:EDEV:PULS:CHAN "81110",1  
system:configure:edev:pulse:chan "myPG",2
```

Query Syntax SYSTem:CONFigure:EDEVice:DC:PULSe:CHAN? <name>

Return Type Numeric

Default 1

SYSTem:CONFigure:EDEVice:PULSe:HAMP <name>,<value>

Applicable Models: All

(Read-Write) Sets and returns the High amplitude (voltage) of the pulse generator.

Parameters

- <name> String - Name of the external pulse generator.
- <value> Pulse Generator high amplitude voltage.

Examples

```
SYST:CONF:EDEV:PULS:HAMP "81110",3  
system:configure:edev:pulse:HAMP "myPG",4
```

Query Syntax SYSTem:CONFigure:EDEVice:DC:PULSe:HAMP? <name>

Return Type Numeric

Default 5

SYSTem:CONFigure:EDEVice:PULSe:LAMP <name>,<value>

Applicable Models: All

(Read-Write) Pulse Generator low amplitude voltage.

Parameters

<name> String - Name of the external pulse generator.

<value> Pulse Generator low amplitude voltage.

Examples

```
SYST:CONF:EDEV:PULS:LAMP "81110",.2  
system:configure:edev:pulse:lamp "myPG",1
```

Query Syntax SYSTem:CONFIgure:EDEVice:DC:PULSe:LAMP? <name>

Return Type Numeric

Default 0

SYSTem:CONFIgure:EDEVice:PULSe:LIMP <name>,<value>

Applicable Models: All

(Read-Write) Sets and returns the load impedance of the pulse generator.

Parameters

<name> String - Name of the external pulse generator.

<value> Pulse generator load impedance.

Examples

```
SYST:CONF:EDEV:PULS:LIMP "81110",52  
system:configure:edev:pulse:limp "myPG",49
```

Query Syntax SYSTem:CONFIgure:EDEVice:DC:PULSe:LIMP? <name>

Return Type Numeric

Default 50

SYSTem:CONFIgure:EDEVice:PULSe:MMODE <name>,<bool>

Applicable Models: All

(Read-Write) Sets and returns the Master (On/Off) setting of the external pulse generator. The ON setting allows the external pulse generator to set the master clock frequency for the other pulse generators.

Parameters

<name> String - Name of the external pulse generator.

<bool> Master setting. Choose from:

ON or **1** - Use the external pulse generator becomes the master clock frequency.

OFF or **0** - Use the internal pulse generator as the master clock frequency.

Examples

```
SYST:CONF:EDEV:PULS:MMOD "81110",OFF
```

```
system:configure:edev:pulse:mmode "myPG",1
```

Query Syntax SYSTem:CONFIgure:EDEVice:DC:PULSe:MMODE? <name>

Return Type Boolean

Default OFF or 0

SYSTem:CONFIgure:EDEVice:PULSe:SIMP <name>,<value>

Applicable Models: All

(Read-Write) Sets and returns the source impedance of the pulse generator.

Parameters

<name> String - Name of the external pulse generator.

<value> Pulse generator source impedance.

Examples

```
SYST:CONF:EDEV:PULS:SIMP "81110",52
```

```
system:configure:edev:pulse:simp "myPG",49
```

Query Syntax SYSTem:CONFIgure:EDEVice:DC:PULSe:SIMP? <name>

Return Type Numeric

Default 50

System:FIFO Commands

The 4 GB FIFO data buffer is available with Option S93118A/B or Option S930900A/B on the [VNA](#) and [N5264B](#). These commands control data in and out of FIFO data buffer. The FIFO can be emptied as it is being filled, which means that the VNA can be used to acquire an infinite amount of data.

The data placed into the FIFO is the raw data after averaging and ratioing has been applied, but prior to any calibration, formatting, or data analysis functions.

```
SYSTem:FIFO
  DATA
    | BYTe?
    | COUNT?
    | CLear
    | COUNT?
  [:STATe]
```

Click on a [red](#) keyword to view the command details.

See Also

- [FIFO and other Antenna Features](#)
- [Fast CW command](#)
- [FIFO Example Program](#)
- [Synchronizing the Analyzer and Controller](#)
- [SCPI Command Tree](#)

SYSTem:FIFO:DATA? <dpoints>

Applicable Models: N522xB, N524xB

(Read-only) Reads the next specified number of data points from the FIFO buffer. Each data point is returned as a real/imaginary pair. Data is cleared as it is read.

Parameters

<dPoints> Number of data points to read. An error is returned if the amount of requested data is larger than the available data.

Examples

```
SYST:FIFO:DATA? 1e6
system:fifo:data? 1e3
```

Return Type Use **FORMat:DATA** to change the data type (<REAL,32>, <REAL,64> or <ASCIi,0>). For best results, use REAL,32

Use **FORMat:BORDER** to change the byte order. Use “NORMAL” when transferring a binary block from LabView or Vee. For other programming languages, you may need to "SWAP" the byte order.

Each data point is returned as a real/imaginary pair.

Default Not applicable

SYSTem:FIFO:DATA:BYTe? <X>

Applicable Models: N522xB, N524xB

(Read-only) Returns a specific number of bytes to read.

Parameters

<X> Number of bytes to read.

Examples

```
SYST:FIFO:DATA:BYTe? 4096
system:fifo:data:byte? 4096
```

Return Type IEEE binary block

Default Not applicable

SYSTem:FIFO:DATA:BYTe:COUNT?

Applicable Models: N522xB, N524xB

(Read-only) Returns a specific number of bytes to read.

Parameters

Examples `SYST:FIFO:DATA:BYTe:COUnT?`
`system:fifo:data:byte:count?`

Return Type Integer

Default Not applicable

SYSTem:FIFO:DATA:CLEAr

Applicable Models: N522xB, N524xB

(Write-only) Clears the data from the FIFO buffer.

Parameters None

Examples `SYST:FIFO:DATA:CLE`
`system:fifo:data:clear`

Return Type None

Default Not applicable

SYSTem:FIFO:DATA:COUnT?

Applicable Models: N522xB, N524xB

(Read-only) Returns the total number of data points in the FIFO buffer.

Parameters None

Examples `SYST:FIFO:DATA:COUnT?`
`' returns 5.07e6`

Return Type Numeric

Default Not applicable

SYSTem:FIFO[:STATe] <bool>

Applicable Models: N522xB, N524xB

(Write-Read) Sets and returns the state of data storage to the FIFO buffer. Syst:Preset or an instrument state recall also ends storage to the FIFO buffer. The FIFO buffer is cleared when set to OFF.

Parameters

<bool> FIFO buffer state. Choose from:

ON or 1 Data is stored in the FIFO buffer.

OFF or 0 Data is NOT stored in the FIFO buffer.

Examples

```
SYST:FIFO 1
```

```
system:fifo:state off
```

Query Syntax SYSTem:FIFO[:STATE]?

Return Type Boolean

Default 0 OFF

System Preferences Commands

Sets and reads the VNA Preferences settings.

```
SYSTem:PREFerences
| DEFault
| ITEM
| ASMRamp
| EEXTrapolate
| EDEV: DPOLicy
| GDELay:TWOPoint
| KEYS
| MARKer:BANDwidth:SEARch
| MARKer:SINGLE
| MCControl
| MCMethod
| MCPreset
| MINTerpolate
| MRU
| OFFSet
| RCV
| SRC
| OPTimize:MEMory
| PRESet:CONFirm
| PRESet:POWer:STATe
| PSRTrace
| QStart
| RECeivers
| CERRor
| OVERload:POWer
| REDLimits
| REFMarker
| RETRace:POWer
| RTOF
| SOFTkeys:NAVigation
| SWITch:DEF
```

Click on a keyword to view the command details.

See Also

- [SENS:CORRection:PREFerences](#)
 - [Learn about VNA Preferences](#)
 - [Example Programs](#)
 - [Synchronizing the Analyzer and Controller](#)
 - [SCPI Command Tree](#)
-

SYSTem:PREFerences:ITEM:ASMRamp <bool>

Applicable Models: N522xB, N523xB, N524xB, E5080A/B

(Read-Write) Set and return whether ramp sweep is used whenever possible when sweep mode is in Auto.

Parameters

<bool> Choose from:

ON (1) Enable ramp sweep.

OFF (0) Disable ramp sweep.

Examples

```
SYST:PREF:ITEM:ASMR 1  
system:preferences:item:asmramp OFF
```

Query Syntax SYSTem:PREFerences:ITEM:ASMRamp?

Return Type Boolean

Default OFF

SYSTem:PREFerences:DEFault

Applicable Models: All

(Write-only) Resets the VNA preferences to their default settings. Some default settings vary depending on the VNA Model. [Learn more about VNA Preferences.](#)

Examples `SYST: PREF: DEF`
`system: preferences: default`

Query Syntax Not Applicable

Default Not Applicable

SYSTem:PREFErences:ITEM:EDEV:DPOLicy <bool>

Applicable Models: All

(Read-Write) Set and return whether External Devices remain activated or are de-activated when the VNA is Preset or when a Instrument State is recalled.

This setting remains until changed again using this command, or until the hard drive is changed or reformatted.

Parameters

<bool> Choose from:

OFF (0) External devices **remain active** when the VNA is Preset or when a Instrument State is recalled.

ON (1) External devices are **de-activated** (`SYST:CONF:EDEV:STAT` to OFF) when the VNA is Preset or when a Instrument State is recalled.

Examples `SYST: PREF: ITEM: EDEV: DPOL 1`
`system: preferences: item: edev: dpolicy OFF`

Query Syntax SYSTem:PREFErences:ITEM:EDEV:DPOLicy?

Return Type Boolean

Default ON or 1

SYSTem:PREFErences:ITEM:EEXTrapolate <bool>

Applicable Models: All

(Read-Write) Sets whether a Swept IMD or IMDx calibration can exceed the stop frequency limit of an ECal module. [Learn more.](#)

Parameters

<bool> Choose from:

ON (1) Allow extrapolation.

OFF (0) Do NOT allow extrapolation.

Examples

```
SYST:PREF:ITEM:EEXT 1
```

```
system:preferences:item:eextrapolate OFF
```

Query Syntax SYSTem:PREFerences:ITEM:EEXTrapolate?

Return Type Boolean

Default OFF

SYSTem:PREFerences:ITEM:GDElay:TWOPoint <bool>

Applicable Models: All

(Read-Write) Sets the default group delay aperture setting. [Learn more about group delay aperture.](#)

Parameters

<bool> Choose from:

ON (1) Sets default group delay aperture to 2 points.

OFF (0) Sets default group delay aperture to 11 points.

Examples

```
SYST:PREF:ITEM:GDElay:TWOPoint 1
```

```
system:preferences:item:gdelay:twopoint OFF
```

Query Syntax SYSTem:PREFerences:ITEM:GDElay:TWOPoint?

Return Type Boolean

Default OFF

SYSTem:PREFerences:ITEM:KEYS <bool>

Applicable Models: N522xB, N523xB, N524xB, M937xA, P937xA

(Read-Write) Set and return whether the keys are displayed or not.

Parameters

<bool> Choose from:

ON (1) – Turn keys on.

OFF (0) – Turn keys off.

Examples

```
SYST: PREF: ITEM: KEYS 1
```

```
system: preferences: item: keys OFF
```

Query Syntax SYSTem:PREFErences:ITEM:KEYS?

Return Type Boolean

Default OFF (0)

SYSTem:PREFErences:ITEM:MARKer:BANDwidth:SEARch <char>

Applicable Models: All

(Read-Write) Sets the bandwidth search preference to start a bandwidth or notch search in either peak or marker mode.

Parameters

<char> Choose from:

MARKer - BW/Notch marker search reference is set to current marker position after Preset. .

PEAK - BW/Notch marker search reference is set to peak after Preset.

Examples

```
SYST: PREF: ITEM: MARK: BAND: SEAR MARK
```

```
system: preferences: item: marker: bandwidth: search PEAK
```

Query Syntax SYSTem:PREFErences:ITEM:MARKer:BANDwidth:SEARch?

Return Type Character

Default MARK (E5080A/B), PEAK (Others)

SYSTem:PREFErences:ITEM:MARKer:SINGle <bool>

Applicable Models:All

(Read-Write) Set and return whether to use one marker for marker search.

Enabled behavior:

- Only one marker is used for bandwidth, notch, PNOP, and PSAT marker searches. The points of interest are marked with a notational UI element, i.e. a small triangle.
- Bandwidth, notch, PNOP, and PSAT marker searches are always tracking. Tracking cannot be disabled.
- One basic search and one advanced search may be set per marker.
- The advanced search is enabled until the user disables the search or a multi-peak or multi-target search is executed.

Disabled behavior:

- Bandwidth, notch, PSAT, and PNOP marker searches use multiple markers.
- One advanced marker search is allowed per trace.
- A marker may only perform a basic search or be part of an advanced search. Not both.
- If an advanced marker search is enabled on a trace and then the user performs a basic search, the advanced search is automatically disabled.
- Advanced searches may enable or disable tracking. Only one search may be tracked.

Parameters

<bool> Choose from:

ON (1) Enable single marker search.

OFF (0) Disable single marker search.

Examples

```
SYST:PREF:ITEM:MARK:SING 1
system:preferences:item:marker:single OFF
```

Query Syntax SYSTem:PREFErences:ITEM:MARKer:SINGle?

Return Type Boolean

Default ON

SYSTem:PREFErences:ITEM:MCControl <bool>

Applicable Models: All

(Read-Write) Set and return whether the Coupled Markers setting controls the ON|OFF state of markers that are coupled. [Learn more about Coupled Markers](#). Refer also to [CALC:MEAS:MARK:COUP:STATe ON](#).

Parameters

<bool> Choose from:

ON (1) – With Coupled Markers ON, when a marker is turned on, the same-numbered marker on all coupled traces will also be turned on. Likewise, turning off a marker will turn it off on all coupled traces.

OFF (0) – Turning a marker on or off will have no effect on the markers on other traces.

Examples

```
SYST:PREF:ITEM:MCC 1
```

```
system:preferences:item:mcccontrol OFF
```

Query Syntax SYSTem:PREFerences:ITEM:MCControl?

Return Type Boolean

Default OFF (0)

SYSTem:PREFerences:ITEM:MCMMethod <bool>

Applicable Models: All

(Read-Write) Set and return whether Coupled Markers is set to Channel or All after Preset. [Learn more about Coupled Markers](#). Refer also to [CALC:MEAS:MARK:COUP:STATe ON](#) and [SYST:PREF:ITEM:MCPR ON](#).

Parameters

<bool> Choose from:

ON (1) – Marker Coupling Method is set to Channel after Preset.

OFF (0) – Marker Coupling Method is set to ALL after Preset.

Examples

```
SYST:PREF:ITEM:MCM 1
```

```
system:preferences:item:mcmethod OFF
```

Query Syntax SYSTem:PREFerences:ITEM:MCMMethod?

Return Type Boolean

Default OFF (0)

SYSTem:PREFerences:ITEM:MCPRest <bool>

Applicable Models: All

(Read-Write) Set and return whether Coupled Markers is set to ON or OFF after Preset. [Learn more about Coupled Markers.](#)

Parameters

<bool> Choose from:

OFF (0) – Coupled Markers is OFF after Preset.

ON (1) – Coupled Markers is ON after Preset.

Examples

```
SYST:PREF:ITEM:MCPR 1
```

```
system:preferences:item:mcpreset OFF
```

Query Syntax SYSTem:PREFerences:ITEM:MCPRest?

Return Type Boolean

Default OFF (0)

SYSTem:PREFerences:ITEM:MINTerpolate <bool>

Applicable Models: N522xB, N523xB, N524xB

(Read-Write) Sets and reads the state of the memory data interpolation default preference. The PNA will return to the default interpolation state after a Preset, creating a new trace, or closing the PNA application. [Learn more.](#)

Parameters

<bool> Choose from:

0 - OFF - Set memory interpolation to OFF as the default.

1 - ON - Set memory interpolation to ON as the default.

Examples

```
SYST:PREF:ITEM:MINT 1
```

Query Syntax SYSTem:PREFerences:ITEM:MINTerpolate?

Return Type Boolean

Default 0

SYSTem:PREFerences:ITEM:MRU <bool>

Applicable Models: All

(Read-Write) Set and return whether to list files for recall on softkeys by most-recently used or alphabetically.

Parameters

<bool> Choose from:

ON (1) – Recall softkeys show most recently-used files.

OFF (0) – Recall softkeys show alphabetically-ordered files.

Examples

```
SYST:PREF:ITEM:MRU 1
```

```
system:preferences:item:mru OFF
```

Query Syntax SYSTem:PREFerences:ITEM:MRU?

Return Type Boolean

Default OFF (0)

SYSTem:PREFerences:ITEM:OFFSet:RCV <bool>

Applicable Models: All

(Read-Write) Set and return whether to offset the test port receivers by the amount of receiver attenuation. [Learn more.](#)

To send this command using the VNA front panel, open the [GPIB Command Processor Console](#), then type either of the following examples at the command prompt. Then type the Query Syntax and press enter to be sure the VNA took the command.

This setting remains until changed again using this command, or until the hard drive is changed or reformatted.

Parameters

<bool> Choose from:

ON (1) Offset the test port receivers

OFF (0) Do NOT offset the test port receivers

Examples

```
SYST:PREF:ITEM:OFFS:RCV 1
```

```
system:preferences:item:offset:rcv OFF
```

Query Syntax SYSTem:PREFerences:ITEM:OFFSet:RCV?
Return Type Boolean
Default PNA-L and E836xB: **OFF** (does NOT offset the display).
PNA-X: **ON** (offsets the display).

SYSTem:PREFerences:ITEM:OFFSet:SRC <bool>

Applicable Models: All

(Read-Write) Set and return whether to offset the reference receiver by the amount of source attenuation. [Learn more.](#)

To send this command using the VNA front panel, open the [GPIB Command Processor Console](#), then type either of the following examples at the command prompt. Then type the Query Syntax and press enter to be sure the VNA took the command.

This setting remains until changed again using this command, or until the hard drive is changed or reformatted.

Parameters

<bool> Choose from:

ON (1) Offset the reference receivers.

OFF (0) Do NOT Offset the reference receivers.

Examples

```
SYST:PREF:ITEM:OFFS:SRC 1  
system:preferences:item:offset:src OFF
```

Query Syntax SYSTem:PREFerences:ITEM:OFFSet:SRC?

Return Type Boolean

Default All models: **ON** (offset the display).

SYSTem:PREFerences:ITEM:OPTimize:MEMory <bool>

Applicable Models: M9485A

(Read-Write) Set and return the memory optimization function status. This extends the maximum number of channel. However, this causes slow measurement.

Parameters

<bool> Choose from:

ON (1) Memory optimization on (more channels, but slower speed)

OFF (0) Memory optimization off

Examples

```
SYST: PREF: ITEM: OPT: MEM 1
system: preferences: item: optimize: memory OFF
```

Query Syntax SYSTem:PREFErences:ITEM:OPTimize:MEMory?

Return Type Boolean

Default OFF

SYSTem:PREFErences:ITEM:PRESet:CONFirm <bool>

Applicable Models: All

(Read-Write) Set and return preset confirmation. If preset confirmation is OFF, pressing the green PRESET key presets the instrument and opens the Preset softkey menu. If preset confirmation is ON, pressing the green PRESET causes the Preset menu to appear.

Parameters

<bool> Choose from:

ON (1) Enable preset confirmation.

OFF (0) Disable preset confirmation.

Examples

```
SYST: PREF: ITEM: PRES: CONF 1
system: preferences: item: preset: confirm OFF
```

Query Syntax SYSTem:PREFErences:ITEM:PRESet:CONFirm?

Return Type Boolean

Default ON

SYSTem:PREFErences:ITEM:PRESet:POWER[:STATE] <char>

Applicable Models: All

(Read-Write) Set and return the Preset Power ON/OFF state. [Learn more.](#)

This setting remains until changed again using this command, or until the hard drive is changed or reformatted.

Parameters

<char> Choose from:

ON - Instrument Preset always turns RF power ON.

AUTO - When the current power setting is OFF, leave power OFF after Preset. When the current power setting is ON, turn power ON after Preset.

Examples

```
SYST:PREF:ITEM:PRE:POW ON
system:preferences:item:preset:power:state auto
```

Query Syntax SYSTem:PREFErences:ITEM:PREset:POWer[:STATe]?

Return Type Character

Default ON

SYSTem:PREFErences:ITEM:PSRTrace <char>

Applicable Models: All

(Read-Write) At the end of a power sweep, while waiting to trigger the next sweep, maintain source power at either the start power level or at the stop power level.

To send this command using the VNA front panel, open the [GPIB Command Processor Console](#), then type either of the following examples at the command prompt. Then type the Query Syntax and press enter to be sure the VNA took the command.

This setting remains until changed again using this command, or until the hard drive is changed or reformatted.

Parameters

<char> Choose from:

START - Maintain source power at the start power level.

STOP - Maintain source power at the stop power level.

Examples

```
SYST:PREF:ITEM:PSRT STOP
system:preferences:item:psrtrace start
```

Query Syntax SYSTem:PREFerences:ITEM:PSRTrace?
Return Type Character
Default STARt

SYSTem:PREFerences:ITEM:QSTart <bool>

Applicable Models: All

(Read-Write) This command controls the on/off state of the preference, "On PRESET show Quick Start dialog".

Parameters

<bool> Choose from:

ON (1) Display the Quick Start dialog on PRESET.

OFF (0) Do not display the Quick Start dialog on PRESET.

Examples

```
SYST:PREF:ITEM:QST 1  
system:preferences:item:qstart OFF
```

Query Syntax SYSTem:PREFerences:ITEM:QST?

Return Type Boolean

Default OFF

SYSTem:PREFerences:ITEM:RECeivers:CERRor[:STATe] <bool>

Applicable Models: All

(Read-Write) Set and return whether to display receiver overload warnings. [Learn more.](#)

Parameters

<bool> Choose from:

ON (1) Display overload warnings,

OFF (0) Do NOT display overload warnings.

Examples

```
SYST:PREF:ITEM:REC:CERR 1  
system:preferences:item:receivers:cerror:state OFF
```

Query Syntax SYSTem:PREFerences:ITEM:RECeivers:CERRor[:STATe]?

Return Type Boolean

Default ON

SYSTem:PREFerences:ITEM:RECEivers:OVERload:POWER[:STATe] <bool>

Applicable Models: All

(Read-Write) Set and return whether to turn source power OFF when a receiver is overloaded. [Learn more.](#)

Parameters

<bool> Choose from:

ON (1) Turn OFF source power to ALL ports when a receiver is overloaded.

OFF (0) Power remains ON when a receiver is overloaded.

Examples

```
SYST: PREF: ITEM: REC: OVER: POW 1
```

```
system:preferences:item:receivers:overload:power:state OFF
```

Query Syntax SYSTem:PREFerences:ITEM:RECEivers:OVERload:POWER[:STATe]?

Return Type Boolean

Default OFF (0)

SYSTem:PREFerences:ITEM:REDLimits <bool>

Applicable Models: N522xB, N523xB, N524xB, M937xA, P937xA

(Read-Write) Set and return whether to draw limits lines in Red or the trace color.

Parameters

<bool> Choose from:

ON (1) All Limit lines are drawn in Red.

OFF (0) Limit lines are drawn the same color as the trace.

Examples

```
SYST: PREF: ITEM: REDL 1
```

```
system:preferences:item:redlimits OFF
```

Query Syntax SYSTem:PREFerences:ITEM:REDLimits?

Return Type Boolean

Default OFF

SYSTem:PREFerences:ITEM:REFMarker <bool>

Applicable Models: N522xB, N523xB, N524xB, M937xA, P937xA

(Read-Write) Set and return whether to treat marker 10 as a reference marker. [Learn more.](#)

Parameters

<bool> Choose from:

ON (1) Marker 10 is always a reference marker (Pre A.10.40 behavior).

OFF (0) Marker 10 is just another marker. See [Reference Marker commands](#)

Examples

```
SYST:PREF:ITEM:REFM 1
```

```
system:preferences:item:refmarker OFF
```

Query Syntax SYSTem:PREFerences:ITEM:REFMarker?

Return Type Boolean

Default OFF

SYSTem:PREFerences:ITEM:RETRace:POWER <char>

Applicable Models: All

(Read-Write) For single-band frequency or segment sweeps ONLY, specify whether to turn RF power ON or OFF during a retrace. [Learn more about RF power during sweep retrace.](#)

To send this command using the VNA front panel, open the [GPIB Command Processor Console](#), then type either of the following examples at the command prompt. Then type the Query Syntax and press enter to be sure the VNA took the command.

This setting remains until changed using this command, or until the hard drive is changed or reformatted.

Parameters

<char> Choose from:

AUTO: Power is left ON during retrace of single-band frequency or segment sweeps ONLY.

OFF: Power is turned OFF during retrace of single-band frequency or segment sweeps ONLY.

Examples `SYST: PREF: ITEM: RETR: POW OFF`

`system: preferences: item: retrace: power auto`

Query Syntax `SYSTem: PREFerences: ITEM: RETRace: POWer?`

Return Type Character

Default AUTO

SYSTem: PREFerences: ITEM: RTOF <bool>

Applicable Models: All

(Read-Write) Set and return whether to display limit line failures as red trace segments or red data points (dots). [Learn more.](#)

Parameters

<bool> Choose from:

ON (1) Display failures as red trace segments. (Red Trace On Fail).

OFF (0) Display failures as red data points (dots).

Examples `SYST: PREF: ITEM: RTOF 1`

`system: preferences: item: rtof OFF`

Query Syntax `SYSTem: PREFerences: ITEM: RTOF?`

Return Type Boolean

Default OFF

SYSTem: PREFerences: ITEM: SOFTkeys: NAVigation <bool>

Applicable Models: N522xB, N523xB, N524xB, M937xA, P937xA

(Read-Write) This command controls the on/off state of the preference, "Use keyboard to navigate softkeys".

Parameters

<bool> Choose from:

ON (1) Enable softkey navigation with keyboard.

OFF (0) Disable softkey navigation with keyboard.

Examples

```
SYST:PREF:ITEM:SOFT:NAV 1
system:preferences:item:softkeys:navigation OFF
```

Query Syntax SYSTem:PREFerences:ITEM:SOFTkeys:NAVigation?

Return Type Boolean

Default OFF

SYSTem:PREFerences:ITEM:SWITCh:DEF <string>, <int>

Applicable Models: All

(Read-Write) Sets the default setting for the Noise Tuner switch. This is the setting that occurs when a new channel is created. [Learn more.](#)

This command will return an error on VNA models with a built-in Noise tuner.

To send this command using the VNA front panel, open the [GPIB Command Processor Console](#), then type either of the following examples at the command prompt. Then type the Query Syntax and press enter to be sure the VNA took the command.

This setting remains until changed using this command, or until the hard drive is changed or reformatted.

Parameters

<string> Name of the switch to set. Choose from:

- **"Port1NoiseTuner"**

<int> Value to set. Choose from:

0 Sets the default (preset) to INTERNAL

1 Sets the default (preset) to EXTERNAL

Examples

```
SYST:PREF:ITEM:SWIT:DEF "Port1NoiseTuner" 1 'Write  
system:preferences:item:switch:def? "Port1NoiseTuner" 'Read
```

Query Syntax SYSTem:PREFerences:ITEM:SWITch:DEF? <switch>

Return Type Integer

Default 1 (External)

PXI Shared Memory Data Transfer

The fastest way to transfer data out of a PXIe VNA is to use shared memory. Due to the nature of shared memory, these commands can ONLY be used to transfer data between your program and the VNA when your program runs locally on the same computer as the VNA.

Shared Memory Background: Usually, each process has its own memory, and anything saved in one process isn't visible to another process. With shared memory, both processes actually connect to the same memory, so what happens in one process is now visible to another process.

How to setup Shared Memory

1. Send `SYST:DATA:MEM:INITialize`. This tells the VNA to prepare for the creation of shared memory.
2. Decide which measurements to include in the shared memory. For each of those measurements, send `SYST:DATA:MEM:ADD`. This adds a request to copy the contents of those measurements into the shared memory. This does not start adding data.
3. Send `SYST:DATA:MEM:COMMit`. This command tells the VNA to create the Windows shared memory resource and to give that shared memory resource a name.
4. You can now create a handle to the shared memory and start reading the data from that shared memory. Once setup, the VNA remembers the setup, and the shared memory will be filled on each sweep. You do not send any more SCPI commands unless you need to change the list of requested measurements to include in the shared memory.

[See C# example](#)

SYSTEM: DATA:MEMory Commands

Controls Shared Memory.

The commands are listed in order of recommended use.

SYSTem:DATA:MEMory:

[INITialize](#)

[ADD](#)

[OFFSet?](#)

[NAME?](#)

[COMMit](#)

[SIZE?](#)

[DELete](#)

[RESet](#)

Click on a keyword to view the command details.

See Also

- [SCPI Command Tree](#)

SYSTem:DATA:MEMory:INITialize

Applicable Models: All PXIe/USB VNAs

(Write only) Initializes the shared memory setup buffers.

Parameters None

Examples [See an example program](#)

Query Syntax Not Applicable

Default Not Applicable

SYSTem:DATA:MEMory:ADD <string>

Applicable Models: All PXIe/USB VNAs

(Write only) Add a request to copy the contents of the specified measurement into shared memory. Call this command once for each measurement definition. Once the shared memory is setup, there is no need to send more SCPI commands. The shared memory is filled automatically on every sweep.

Parameters

<string> The following elements separated with colons (:).

<Ch>:<MeasNum>:<dataFormat>:<numPoints>

where:

- <Ch> - Channel number of the measurement to share memory. Use **SYST:ACTive:CHAN** to return the active channel number. Use **SYST:CHAN:CAT?** to return the channel numbers in use.
- <MeasNum> - Measurement (**Tr**) number to share memory. Use **CALC<ch>:PAR:MNUM?** just after the trace is created to read the measurement number. See also: [Referring to Traces, Measurements, Channels, and Windows Using SCPI](#).
- <dataFormat> - Choose from:
 - **SDATA** - Complex measurement data.
 - **Reads** data from **Apply Error Terms** (access point 1). Returns TWO numbers per data point. Corrected data is returned when correction is ON. Uncorrected data is returned when correction is OFF.
 - **FDATA** - Formatted **measurement** data to or from **Data Access Map** location **Display** (access point 2).
 - Corrected data is returned when correction is ON.
 - Uncorrected data is returned when correction is OFF.
 - Returns one number per data point for all other formats.
 - Format of the read data is same as the displayed format.
 - **CAL** - Access the entire set of calibrated SParameter measurements.
 - Only functional if an SParameter calibration is applied to the channel.
 - Always returns all the SParameters.
 - SParameters are in the following order for a 3 port cal:
 - {S11, S21, S31, S12, S22, S32, S13, S23, S33}
- <numPoints> - Number of data points in the measurement trace.

Examples

```
SYSTem:DATA:MEMory:ADD "2:3:SDATA:201"
```

'copies the data for channel #2, measurement #3, complex data, 201 points into the shared memory buffer.

[See an example program](#)

Query Syntax Not Applicable

Default Not Applicable

SYSTem:DATA:MEMory:OFFSet?

Applicable Models: All PXIe/USB VNAs

(Read only) The shared memory is a contiguous block of memory. Each measurement takes up a subset of this contiguous block. This command returns the offset (in bytes) into the shared memory for the most recently added parameter. The offset is a number that specifies the starting index (in bytes) of the data.

This query can be sent after sending **SYST:DATA:MEM:ADD**.

Parameters None

Examples [See an example program](#)

Return Type Numeric

Default Not Applicable

SYSTem:DATA:MEMory:NAME?

Applicable Models: All PXIe/USB VNAs

(Read only) Returns a unique, auto-generated name that can be used in the **COMMI**t command. By using this generated name, a client can be sure not to conflict with any other used shared memory regions.

Parameters None

Examples [See an example program](#)

Return Type String

Default Not Applicable

SYSTem:DATA:MEMory:COMMIt <memName>

Applicable Models: All PXIe/USB VNAs

(Write only) Allocates the memory mapped buffer.

Parameters

<memName> String. Name of the memory mapped buffer. This must be a unique name, and cannot conflict with other shared memory buffer names. Use this command in your program when connecting to the shared memory.

See [SYSTem:DATA:MEMory:NAME?](#)

Examples [See an example program](#)

Query Syntax Not Applicable

Default Not Applicable

SYSTem:DATA:MEMory:SIZE?

Applicable Models: All PXIe/USB VNAs

(Read only) Returns the size of the memory mapped region. Send this immediately after [SYST:DATA:MEM:COMMit](#). The result is the total size (in bytes) of all the measurements in the shared memory region.

Parameters None

Examples [See an example program](#)

Return Type Numeric

Default Not Applicable

SYSTem:DATA:MEMory:CATalog?

Applicable Models: All PXIe/USB VNAs

(Read only) Returns a list of all the allocated shared memory buffers

Parameters None

Examples [See an example program](#)

Return Type String

Default Not Applicable

SYSTem:DATA:MEMory:RESet

Applicable Models: All PXIe/USB VNAs

(Write only) Deletes all allocated shared memory buffers

Parameters None

Examples [See an example program](#)

Query Syntax Not Applicable

Default Not Applicable

SYSTem:DATA:MEMory:DELeTe <memName>

Applicable Models: All PXIe/USB VNAs

(Write only) Allocates the specified memory mapped buffer.

Parameters

<memName> String. Name of the memory mapped buffer. This is the unique name that is used in the **COMMit** command.

Examples [See an example program](#)

Query Syntax Not Applicable

Default Not Applicable

Example Program

```
static void Main(string[] args)
{
    // Connect to the hislip VISA address of localhost
    ResourceManager resourceManager = new ResourceManager();
    FormattedIO488 formattedIO = new FormattedIO488();
    formattedIO.IO =
(IMessage)resourceManager.Open("TCPIP0::localhost::hislip0::INSTR");

    // Destroy all measurements and add a window
```

```

formattedIO.WriteString("SYST:FPR\n");
formattedIO.WriteString("DISP:WIND:STAT 1");

// initialize memory mapped structures in VNA
formattedIO.WriteString("SYST:DATA:MEM:INIT\n");

// Create 4 SParameters
string[] parameters = new string[] { "S11", "S21", "S12", "S22" };
int[] offsets_for_complex_data = new int[parameters.Length];
int[] offsets_for_formatted_data = new int[parameters.Length];
for (int i = 0; i < parameters.Length; i++)
{
    // Create a new parameter
    formattedIO.WriteString("CALC:PAR:DEF '" + parameters[i] + "'," +
parameters[i]);
    formattedIO.WriteString("DISP:WIND:TRAC" + (i + 1).ToString() + ":FEED '" +
parameters[i] + "'");

    // Configure a new section of the memory map to monitor the complex data of
this parameter
    formattedIO.WriteString("SYST:DATA:MEM:ADD '1:" + (i + 1).ToString() +
":SDATA:201'"); // add parameter to memory mapped
    formattedIO.WriteString("SYST:DATA:MEM:OFFSet?");
    offsets_for_complex_data[i] = int.Parse(formattedIO.ReadString());

    // Configure a new section of the memory map to monitor the formatted data of
this parameter
    formattedIO.WriteString("SYST:DATA:MEM:ADD '1:" + (i + 1).ToString() +
":FDATA:201'"); // add parameter to memory mapped
    formattedIO.WriteString("SYST:DATA:MEM:OFFSet?");
    offsets_for_formatted_data[i] = int.Parse(formattedIO.ReadString());
}

```

```

}

// Tell the VNA to allocate the memory map. Name it "VNA_MemoryMap"
formattedIO.WriteString("SYST:DATA:MEM:COMM 'VNA_MemoryMap'");

// Query the size of the memory map
formattedIO.WriteString("SYST:DATA:MEM:SIZE?");
int size = int.Parse(formattedIO.ReadString());

// Create the memory map in C#. This requires .NET 4.5 framework
MemoryMappedFile mappedFile = MemoryMappedFile.CreateOrOpen("VNA_MemoryMap", size);
MemoryMappedViewAccessor mappedFileView = mappedFile.CreateViewAccessor();

// Trigger a single sweep, and wait for it to complete
formattedIO.WriteString("SENS:SWE:MODE SING");
formattedIO.WriteString("*OPC?");
formattedIO.ReadString();

// Allocate buffers to hold the output data
float[][] complexData = new float[parameters.Length][];
for (int i = 0; i < complexData.Length; i++)
{
    complexData[i] = new float[402];
}

float[][] formattedData = new float[parameters.Length][];
for (int i = 0; i < formattedData.Length; i++)
{

```

```

        formattedData[i] = new float[201];
    }

    // Copy the data from the memory map into the output buffers
    // These copy the data from the in-process memory map.
    // This runs very fast - and is just a "memcpy" under the hood
    for (int i = 0; i < parameters.Length; i++)
    {
        ReadBytes(mappedFileView, offsets_for_complex_data[i], 402, complexData[i]);
        ReadBytes(mappedFileView, offsets_for_formatted_data[i], 201,
formattedData[i]);
    }

    // Output some data to show that it worked
    System.Console.WriteLine(complexData[0][0].ToString()); // Output first point of
S11 in complex
    System.Console.WriteLine(formattedData[3][200].ToString()); // Output last point of
S22 as formatted
    }

    static public unsafe void ReadBytes(MemoryMappedViewAccessor mappedFileView,
        int offset, int num, float[] arr)
    {
        // This is equivalent to:
        //      //m_mappedFileView.ReadArray<float>(m_sharedMemoryOffsets[i-1],
complexArray, 0, points*2);
        // But, using this "unsafe" code is 30 times faster. 100usec versus 3ms
        byte* ptr = (byte*)0;
        mappedFileView.SafeMemoryMappedViewHandle.AcquirePointer(ref ptr);
    }

```

```
        System.Runtime.InteropServices.Marshal.Copy(IntPtr.Add(new IntPtr(ptr), offset),
arr, 0, num);
        mappedFileView.SafeMemoryMappedViewHandle.ReleasePointer();
    }
}
```

SYSTem:TDR Commands

SYSTem:TDR

TDR:CAPability:FREQuency:

| MAXimum

| MINimum

PRESet

Click on a [red](#) keyword to view the command details.

See Also

- [Synchronizing the Analyzer and Controller](#)
- [SCPI Command Tree](#)

SYSTem:TDR:CAPability:FREQuency:MINimum <freq>

Applicable Models: All with TDR Options (S9x011A/B)

(Read-Write) Set/Get stop limit frequency in TDR app. The value change gets effective after TDR preset.

Parameters

<freq> Stop limit frequency

Examples

```
SYST:TDR:CAP:FREQ:MAX 9E6  
system:tdr:capability:frequency:maximum?
```

Query Syntax SYSTem:TDR:CAPability:FREQuency:MAXimum]?

Return Type Numeric

Default Same as the product default stop frequency

SYSTem:TDR:CAPability:FREQuency:MINimum <freq>

Applicable Models: All with TDR Options (S9x011A/B)

(Read-Write) Set/Get start limit frequency in TDR app. The value change gets effective after TDR preset.

Parameters

<freq> Start limit frequency

Examples

```
SYST:TDR:CAP:FREQ:MIN 9E3
system:tdr:capability:frequency:minimum?
```

Query Syntax SYSTem:TDR:CAPability:FREQuency:MINimum]?

Return Type Numeric

Default Same as the product default start frequency

SYSTem:TDR:PRESet

Applicable Models: All with TDR Options (S9x011A/B)

(Write-only) This command executes a TDR preset.

Examples

```
SYST:TDR:PRES
system:tdr:preset
```

Default Not Applicable

SYSTem:UNCertainty

Contains the settings to create and control Dynamic Uncertainty for S-Parameters (Opt. S93015A/B).

Setup Options

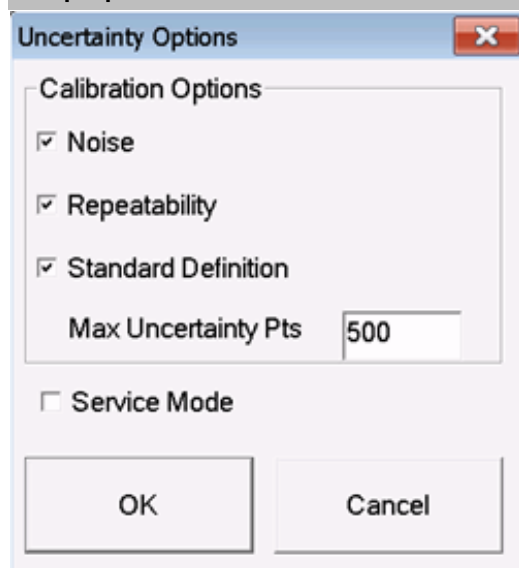

SYST:UNC:ETER:NOIS:ENAB

SYST:UNC:ETER:CABL:REP

SYST:UNC:ETER:SDEF

SYST:UNC:POIN:MAX

Noise Characterization

Clear noise data on specified port

SYST:UNC:PORT<p>:NOISe:RESet

Clear noise data on all ports

SYST:UNC:PORT:NOISe:RESet

Copy noise from a port to all ports

SYST:UNC:PORT:NOISe:ALL:COPI

Start Noise char

SENS:CORR:COLL:GUIDed:UNC:CHAR:NOISe

Cables Characterization

List cables

SYST:UNC:CABLe:CATalog?

Assign Cable to all ports

SYST:UNC:PORT:CABLe:ALL

Assign Cable to specified port

SYST:UNC:PORT<p>:CABLe

Reset repeatability

SYST:UNC:CABL:REP:RES

Start Cable char

SENS:CORR:COLL:GUIDed:UNC:CHAR:CABLe

Uncertainty workspace

Load workspace

SYST:UNC:LOAD

Save workspace

SYST:UNC:STORe

Enable a Guided Cal to include Uncertainties

Checkbox on **Guided Cal Select Ports** page

SENS:CORR:COLL:GUID:UNC

Trace Properties

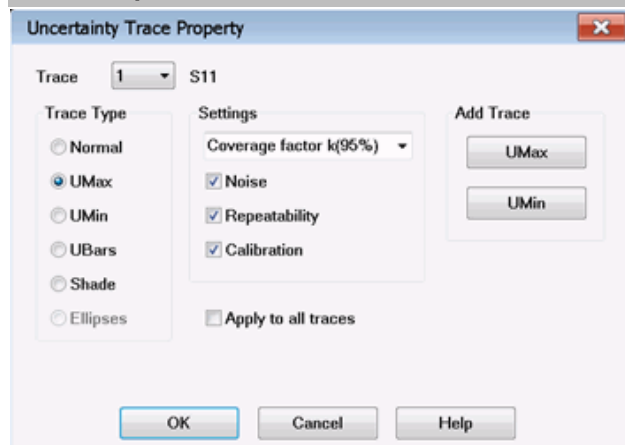

CALC:MEAS:UNC:DISP:TYPE

CALC:MEAS:UNC:DISP:CFAC

CALC:MEAS:UNC:MOD:NOIS

CALC:MEAS:UNC:MODE:CABL:REP

CALC:MEAS:UNC:MOD:ETER

Apply to all traces

None

Add Trace

None

Save uncertainty data

CALC:MEAS:UNC:SAVE

Limitations

- Calibrations can be performed for ONLY ONE channel at a time.
- Putting Error Term data into Uncertainty Cal Sets using **remote commands** is NOT supported.

See Also

- Trace Commands for Dynamic Uncertainty
- Learn more about Dynamic Uncertainty
- Example Program
- **Guided Cal commands**
- **Synchronizing the Analyzer and Controller**
- **SCPI Command Tree**

SYSTEM:UNCertainty:CABLE:CATalog?

Applicable Models: N522xB, N523xB, N524xB

(Read-only) Returns a comma-delimited list of names of cables that are defined in the Uncertainty Manager application.

Parameters None

Examples `SYST:UNC:CABL:CAT?`

Return Type Comma-delimited string

Default Not Applicable

SYSTEM:UNCertainty:CABLE:REPeat:RESet <cablename>

Applicable Models: N522xB, N523xB, N524xB

(Write-only) Resets (clears) the characterized repeatability data associated with the specified cable.

Parameters

<cablename> String. Name of the cable for which data is to be reset.

Examples `SYST:UNC:CABL:REP:RES "MyCable"`

Query Syntax Not Applicable

Default Not Applicable

SYSTEM:UNCertainty:PORT:CABLE:ALL[:SElect] <cablename>

Applicable Models: N522xB, N523xB, N524xB

(Write-only) Sets the name of the cable to be associated with all the ports currently enabled on the VNA

Parameters

<cablename> String. Name of the cable.

Examples `SYST:UNC:PORT:CABL:ALL "MyCable"`

Query Syntax Not Applicable

Default Not Applicable

SYSTEM:UNCertainty:PORT<pNum>:CABLE[:SElect] <cablename>

Applicable Models: N522xB, N523xB, N524xB

(Write-Read) Sets and returns the name of the cable to be associated with the specified port number on the VNA

Parameters

<pNum> VNA port number.

<cableName> String. Name of the cable.

Examples `SYST:UNC:PORT3:CABL "MyCable"`

Query Syntax `SYSTEM:UNCertainty:PORT<pNum>:CABLE[:SElect]?`

Return Type String

Default Not Applicable

SYSTEM:UNCertainty:PORT:NOISe:ALL:COpy <pNum>

Applicable Models: N522xB, N523xB, N524xB

(Write-only) Copies the characterized noise data associated with the specified port, to all the other ports

Parameters

<pNum> VNA port number for which noise data will be copied.

Examples `SYST:UNC:PORT:NOIS:ALL:COpy 2`

Query Syntax Not Applicable

Default Not Applicable

SYSTEM:UNCertainty:PORT:NOISe:ALL:RESet

Applicable Models: N522xB, N523xB, N524xB

(Write-only) Resets (clears) the characterized noise data for all currently enabled VNA ports.

Parameters None

Examples `SYST:UNC:PORT:NOIS:ALL:RESet`

Query Syntax Not Applicable

Default Not Applicable

SYSTem:UNCertainty:PORT<pNum>:NOISe:RESet

Applicable Models: N522xB, N523xB, N524xB

(Write-only) Resets (clears) the characterized noise data for the specified VNA port.

Parameters None

<pNum> VNA port number for which noise data will be reset.

Examples `SYST:UNC:PORT2:NOIS:RESet`

Query Syntax Not Applicable

Default Not Applicable

SYSTem:UNCertainty:LOAD <filename>

Applicable Models: N522xB, N523xB, N524xB

(Write-only) Loads an uncertainty 'workspace' (*.ml4) file into the Uncertainty Manager.

Parameters None

<filename> String. Full path, filename, and extension of the uncertainty workspace file, enclosed in quotes.

Examples `SYST:UNC:LOAD "C:\MyUncert.ml4"`

Query Syntax Not Applicable

Default Not Applicable

SYSTem:UNCertainty:STORe [filename]

Applicable Models: N522xB, N523xB, N524xB

(Write-only) Saves the current uncertainty 'workspace' of the Uncertainty Manager to a (.ml4) file.

Parameters None

<filename> String. Optional argument. Full path, filename, and extension of the uncertainty workspace file, enclosed in quotes.

If filename is not specified, the current workspace is saved to the default workspace (*.ml4) file.

Examples `SYST:UNC:STORE "C:\MyUncert.ml4"`

Query Syntax Not Applicable

Default Not Applicable

SYSTEM:UNCertainty:POINTs:MAXimum <num>

Applicable Models: N522xB, N523xB, N524xB

(Write-Read) Sets and returns the maximum number of points ("decimation value") for which uncertainties are to be computed for subsequent calibrations that are performed using Dynamic Uncertainty for S-Parameters.

Parameters

<num> Max number of points. Specify an integer between 0 and 501.

Examples `SYST:UNC:POIN:MAX 201`

Query Syntax SYSTEM:UNCertainty:POINTs:MAXimum?

Return Type Numeric

Default 500

SYSTEM:UNCertainty:ETERm:NOISe:ENABLE <bool>

Applicable Models: N522xB, N523xB, N524xB

(Write-Read) Sets and returns the ON/OFF state of allowing noise data to contribute to the uncertainty of a calibration performed using Dynamic Uncertainty for S-Parameters. Noise data must also be present for the ports at the time the calibration is performed.

Parameters

<bool> Enable ON/OFF state. Choose from:

ON or **1** - Noise uncertainty ON.

OFF or **0** - Noise uncertainty OFF.

Examples

```
SYST:UNC:ETER:NOIS:ENAB ON
```

Query Syntax SYSTem:UNCertainty:ETERm:NOISe:ENABLE?

Return Type Boolean

Default ON

SYSTem:UNCertainty:ETERm:CABLe:REPeat[:ENABLE] <bool>

Applicable Models: N522xB, N523xB, N524xB

(Write-Read) Sets and returns the ON/OFF state of allowing cable repeatability data to contribute to the uncertainty of a calibration performed using Dynamic Uncertainty for S-Parameters. Repeatability data must also be present for the ports at the time the calibration is performed.

Parameters

<bool> Enable ON/OFF state. Choose from:

ON or **1** - Cable repeatability uncertainty ON.

OFF or **0** - Cable repeatability uncertainty OFF.

Examples

```
SYST:UNC:ETER:CABL:REP ON
```

Query Syntax SYSTem:UNCertainty:ETERm:CABLe:REPeat[:ENABLE]?

Return Type Boolean

Default ON

SYSTem:UNCertainty:ETERm:SDEFinitions[:ENABLE] <bool>

Applicable Models: N522xB, N523xB, N524xB

(Write-Read) Sets and returns the ON/OFF state of allowing the uncertainty associated with the standard definitions in the cal kits to contribute to the uncertainty of a calibration performed using Dynamic Uncertainty for S-Parameters. The uncertainty data for the Cal standards must also be present at the time the calibration is performed.

Parameters

<bool> Enable ON/OFF state. Choose from:

ON or **1** - Standard definition uncertainty ON.

OFF or **0** - Standard definition uncertainty OFF.

Examples

```
SYST:UNC:ETER:SDEF ON
```

Query Syntax SYSTem:UNCertainty:ETERm:SDEFinitions[:ENABLE]?

Return Type Boolean

Default ON

SYSTem:SERVice:PVERify Commands

Controls and queries settings for editing the Instrument Calibration Verification field on the Help About dialog. [Learn more](#).

```
SYSTem:SERVice:PVERify
INTerval
LAST
NEXT
```

Click on a keyword to view the command details.

see Also

- [SCPI Command Tree](#)
-

SYSTem:SERVice:PVERify:INTerval <days>,<mod>

Applicable Models: All PXIe/USB VNAs

(Read-Write) Sets and reads the interval between Instrument Calibrations. One year (365 days) is recommended.

Parameters

<days> (Integer) Interval in days.

<mod> (Integer) Slot number in which the module resides.

Examples

```
'Set 1 year interval
SYST:SERV:PVER:INT 365,1
```

Query Syntax SYSTem:SERVice:PVERify:INTerval? <mod>

Return Type Numeric

Default 0

SYSTem:SERVice:PVERify:LAST <date>,<mod>

Applicable Models: All PXIe/USB VNAs

(Read-Write) Sets and reads the date of the last Instrument Calibration.

Parameters

- <date> Date in the form: yyyy,mm,dd
- <mod> (Integer) Slot number in which the module resides.

Examples

```
'The following sets the date of the last calibration for the
module in slot 1 to July 19, 2014

SYST:SERV:PVER:LAST 2014,07,19,1

The following reads the previous setting

SYST:SERV:PVER:LAST? 1

'2014,7,9
```

Query Syntax SYSTem:SERVice:PVERify:LAST? <mod>

Return Type Comma-separated integers

Default 0,0,0 (not set)

SYSTem:SERVice:PVERify:NEXT? <mod>

Applicable Models: All PXIe/USB VNAs

(Read-only) Reads the due date of the next Instrument Calibration.

Parameters

- <mod> (Integer) Slot number in which the module resides.

Examples

```
SYST:SERV:PVER:NEXT? 1

'returns: 2015,7,9
```

Return Type Numeric in the form: yyyy,mm,dd

Default Not Applicable

Trigger Commands

Controls External Triggering.

TRIGger:

AUXiliary

| **COUNT**

CHANnel:AUXiliary

| **DELay**

| **DURation**

| **[ENABLE]**

| **HANDshake**

| **INTerval**

| **IPOLarity**

| **OPOLarity**

| **POSition**

| **TYPE**

DELay

PREFerence

| **AIGLobal**

READY:POLarity

[SEQuence]

| **LEVeL**

| **ROUTE**

| **INPut**

| **READY**

| **SCOPE**

| **SOURce**

| **SLOPe**

<p> TYPE</p> <p>STATus</p> <p> READy?</p>

Click on a keyword to view the command details.

[Blue](#) commands are superseded.

See Also

- [Example program Triggering the VNA](#)
- [See other SCPI Triggering commands](#)
- [Learn about External / Aux Triggering](#)
- [Synchronizing the Analyzer and Controller](#)
- [SCPI Command Tree](#)

TRIGger:AUXiliary:COUNT?

Applicable Models: N522xB, N523xB, N524xB, E5080A, M937xA, M9485A, P937xA

(Read-only) Returns the number of AUX trigger input / output connector pairs in the instrument.

Parameters

Examples

```
TRIG:AUX:COUN?
trigger:auxiliary:count?
```

Return Type Numeric

Default Not Applicable

TRIGger:CHANnel<ch>:AUXiliary<n>:DELay <num>

Applicable Models: N522xB, N523xB, N524xB, M937xA, P937xA

(Read-Write) Specifies the delay that should be applied by the VNA after the Aux trigger input is received and before the acquisition is made.

Parameters

<ch> Any existing channel number. If unspecified, value is set to 1.

<n> AUX Trigger connector used to send or receive signals.

Choose from **1 (AUX TRIG 1)** or **2 (AUX TRIG 2)**

If unspecified, value is set to 1.

<num> Delay value in seconds. Choose a value between 0 and 3.0 seconds.

Examples

```
TRIG:CHAN:AUX:DEL .5  
trigger:channel12:aux2:delay 1.5
```

Query Syntax TRIGger:CHANnel<ch>:AUXiliary<n>:DELay?

Return Type Numeric

Default 0

TRIGger:CHANnel<ch>:AUXiliary<n>:DURation <num>

Applicable Models: N522xB, N523xB, N524xB, E5080A, M937xA, M9485A, P937xA

(Read-Write) Specifies the width of the output pulse, which is the time that the Aux trigger output will be asserted.

Parameters

<ch> Any existing channel number. If unspecified, value is set to 1.

<n> AUX Trigger connector used to send or receive signals.

Choose from **1 (AUX TRIG 1)** or **2 (AUX TRIG 2)**

If unspecified, value is set to 1.

<num> Duration value in seconds. Choose a value between 1us (1E-6) and 1

Examples

```
TRIG:CHAN:AUX:DUR .1  
trigger:channel12:aux2:duration .01
```

Query Syntax TRIGger:CHANnel<ch>:AUXiliary<n>:DURation?

Return Type Numeric

Default 1E-6

TRIGger:CHANnel<ch>:AUXiliary<n>[:ENABLE] <bool>

Applicable Models: N522xB, N523xB, N524xB, E5080A, M937xA, M9485A, P937xA

(Read-Write) Turns ON / OFF the trigger output.

Parameters

<ch> Any existing channel number. If unspecified, value is set to 1.

<n> AUX Trigger connector used to send or receive signals.

Choose from **1 (AUX TRIG 1)** or **2 (AUX TRIG 2)**

If unspecified, value is set to 1.

<bool> **ON** (or 1) - turns trigger output ON.

OFF (or 0) - turns trigger output OFF.

Examples

```
TRIG:CHAN:AUX 1
```

```
trigger:channel12:aux2:enable off
```

Query Syntax TRIGger:CHANnel<ch>:AUXiliary<n>[:ENABLE]?

Return Type Boolean

Default OFF

TRIGger:CHANnel<ch>:AUXiliary<n>:HANDshake <bool>

Applicable Models: N522xB, N523xB, N524xB, M937xA, P937xA

(Read-Write) Turns handshake ON / OFF.

To enable handshake, the main trigger enable must also be set using **TRIG:CHAN:AUX:ENAB**.

When ON, VNA waits indefinitely for the input line to be asserted before continuing with the acquisition. When OFF, the VNA acquires data without waiting.

Parameters

<ch> Any existing channel number. If unspecified, value is set to 1.

<n> AUX Trigger connector used to send or receive signals.

Choose from **1 (AUX TRIG 1)** or **2 (AUX TRIG 2)**

If unspecified, value is set to 1.

<bool> **ON** (or 1) - turns handshaking ON.

OFF (or 0) - turns handshaking OFF.

Examples

```
TRIG:CHAN:AUX:HAND 1
```

```
trigger:channel12:aux2:handshake off
```

Query Syntax TRIGger:CHANnel<ch>:AUXiliary<n>:HANDshake?

Return Type Boolean

Default OFF

TRIGger:CHANnel<ch>:AUXiliary<n>:INTerval <char>

Applicable Models: N522xB, N523xB, N524xB, E5080A, M937xA, M9485A, P937xA

(Read-Write) Specifies how often a trigger output signal is sent.

Parameters

<ch> Any existing channel number. If unspecified, value is set to 1.

<n> AUX Trigger connector used to send or receive signals.

Choose from **1** (AUX TRIG 1) or **2** (AUX TRIG 2)

If unspecified, value is set to 1.

<char> Choose from:

- **POINT** Trigger signal is sent every data point. (effectively the same as **Point sweep**)
- **SWEep** Trigger signal is sent once every sweep.

Examples

```
TRIG:CHAN:AUX:INT POI  
trigger:channel12:aux2:interval sweep
```

Query Syntax TRIGger:CHANnel<ch>:AUXiliary<n>:INTerval?

Return Type Character

Default SWEep

TRIGger:CHANnel<ch>:AUXiliary<n>:IPOLarity <char>

Applicable Models: N522xB, N523xB, N524xB, M937xA, P937xA

(Read-Write) Specifies the polarity of the trigger IN signal to which the VNA will respond.

Parameters

<ch> Any existing channel number. If unspecified, value is set to 1.

<n> AUX Trigger connector used to send or receive signals.

Choose from **1** (AUX TRIG 1) or **2** (AUX TRIG 2)

If unspecified, value is set to 1.

<char> Choose from:

- **POSitive** VNA responds to leading edge or HIGH level

- **NEGative** VNA responds to trailing edge or LOW level.

Set Edge or Level triggering using **TRIG:CHAN:AUX:TYPE**

Examples

```
TRIG:CHAN:AUX:IPOL POS
```

```
trigger:channel2:aux2:ipolarity negative
```

Query Syntax TRIGger:CHANnel<ch>:AUXiliary<n>:IPOLarity?

Return Type Character

Default NEGative

TRIGger:CHANnel<ch>:AUXiliary<n>:OPOLarity <char>

Applicable Models: N522xB, N523xB, N524xB, E5080A, M937xA, M9485A, P937xA

(Read-Write) Specifies the polarity of the Aux Output signal being supplied by the VNA.

Parameters

<ch> Any existing channel number. If unspecified, value is set to 1.

<n> AUX Trigger connector used to send or receive signals.

Choose from **1** (AUX TRIG 1) or **2** (AUX TRIG 2)

If unspecified, value is set to 1.

<char> Choose from:

- **POSitive** VNA sends positive going pulse.
- **NEGative** VNA sends negative going pulse.

Examples

```
TRIG:CHAN:AUX:OPOL NEG
```

```
trigger:channel2:aux2:opolarity positive
```

Query Syntax TRIGger:CHANnel<ch>:AUXiliary<n>:OPOLarity?

Return Type Character

Default NEGative

TRIGger:CHANnel<ch>:AUXiliary<n>:POSition <char>

Applicable Models: N522xB, N523xB, N524xB, E5080A, M937xA, M9485A, P937xA

(Read-Write) Specifies whether the aux trigger out signal is sent **BEFORE** or **AFTER** the acquisition.

Parameters

<ch> Any existing channel number. If unspecified, value is set to 1.

<n> AUX Trigger connector used to send or receive signals.

Choose from **1 (AUX TRIG 1)** or **2 (AUX TRIG 2)**

If unspecified, value is set to 1.

<char> Choose from:

- **BEFORE** Use if the external device needs to be triggered before the data is acquired, such as a power meter.
- **AFTER** Use if the external device needs to be triggered just after data has been acquired, such as an external source. This could be more efficient since it allows the external device to get ready for the next acquisition at the same time as the VNA.

Examples

```
TRIG:CHAN:AUX:POS BEF
```

```
trigger:channel12:aux2:position after
```

Query Syntax TRIGger:CHANnel<ch>:AUXiliary<n>:POSition?

Return Type Character

Default AFTer

TRIGger:CHANnel<ch>:AUXiliary<n>:TYPE <char>

Applicable Models: N522xB, N523xB, N524xB, E5080A, M937xA, P937xA

(Read-Write) Specifies the type of Aux input detection that the VNA will employ.

Parameters

<ch> Any existing channel number. If unspecified, value is set to 1.

<n> AUX Trigger connector used to send or receive signals.

Choose from **1** (AUX TRIG 1) or **2** (AUX TRIG 2)

If unspecified, value is set to 1.

<char> Choose from:

EDGE VNA responds to the leading edge of a signal

LEVEl VNA responds to the level (HIGH or LOW) of a signal

Examples

```
TRIG:CHAN:AUX:TYPE EDGE
```

```
trigger:channel12:aux2:type level
```

Query Syntax TRIGger:CHANnel<ch>:AUXiliary<n>:TYPE?

Return Type Character

Default EDGE

TRIGger:DELay <num>

Applicable Models: All

(Read-Write) Sets and reads the trigger delay for ALL channels (globally). This delay is only applied while **TRIG:SOURce** = **EXTernal** and **TRIG:SCOP** = **ALL**. After an external trigger is applied, the start of the sweep is held off for an amount of time equal to the delay setting plus any inherent latency.

To apply a trigger delay for the specified channel ONLY, use **SENS:SWE:TRIG:DELay**

Parameters

<num> Delay value in seconds. Choose from 0 to 3.

Examples

```
TRIG:DEL .0003
```

Sets the trigger delay to 300 microseconds. The sweep will not start until approximately 300 microseconds after an external trigger is applied.

Query Syntax TRIGger:DELay?

Return Type Numeric

Default 0

TRIGger:PREFerence:AIGLobal <bool>

Applicable Models: N522xB, N523xB, N524xB, E5080A, M937xA, M9485A, P937xA

(Read-Write) Sets the Trigger OUT behavior to either Global or Channel. [Learn more about this setting.](#)

This command will cause the VNA to Preset.

This setting remains until changed again using this command, or until the hard drive is changed or reformatted.

To send this command using the VNA GUI, open the [GPIB Command Processor Console](#), then type either of the following examples at the command prompt. Then type the Query Syntax and press enter to be sure the VNA took the command.

Parameters

<bool> Choose from:

- **ON** (or 1) - Trigger properties apply to ALL channels (Global).
 - Allows use of **CONT:SIGNal** command to configure the external trigger properties.
 - "Per Point" trigger property is not settable. Use the channel's **Point trigger** setting.
- **OFF** (or 0) - External Trigger properties apply to each channel independently.
 - Must use **TRIG:CHAN:AUX** commands to configure the external trigger properties. **CONT:SIGNal** will NOT work.
 - "Per Point" trigger output property is set using the channel's **Point trigger** setting **AND** **TRIG:CHAN:AUX:INTerval**.

Examples

```
TRIG:PREF:AIGL 1  
trigger:preference:aiglobal 0
```

Query Syntax TRIGger:PREFerence:AIGLobal?

Return Type Boolean

Default 0

TRIGger:READy:POLarity <char>

Applicable Models: N522xB, N523xB, N524xB, E5080A, M937xA, P937xA

(Read-Write) Specifies the polarity of Ready for Trigger output.

All existing Ready for Trigger outputs are configured simultaneously with this command.

Parameters

<char> **LOW** - Outputs a TTL low when the VNA is ready for trigger.

HIGH - Outputs a TTL high when the VNA is ready for trigger.

Examples

```
TRIG:READ:POL HIGH
```

```
trigger:ready:polarity low
```

Query Syntax TRIGger:READy:POLarity?

Return Type Character

Default Low

TRIGger[:SEQuence]:LEVel <char> - **Superseded**

This command is replaced with **CONTRol:SIGNal**

(Read-Write) Triggers either on a **High or Low** level trigger signal. This setting only has an effect when **TRIG:SOURce EXTernal** is selected.

Parameters

<char> Choose from:

- **HIGH** - analyzer triggers on TTL **High**
- **LOW** - analyzer triggers on TTL **Low**

Examples

```
TRIG:LEV HIGH
```

```
trigger:sequence:level low
```

Query Syntax TRIGger[:SEQuence]:LEVel?

Return Type Character

Default LOW

TRIGger[:SEQuence]:ROUTE:INPut <char>

Applicable Models: All

(Read-Write) Specifies the connector to use for the external trigger input.

Parameters

<char> Choose from:

MATH - handler I/O Pin 18 on M9341A

PULSE3 - Internal routing of pulse 3 output to the MEAS TRIG IN on the rear panel (M9385A)

SMB – Meas Trig In SMB

(The M9370A/71A/72A/73A/74A/75A support the following parameters for backplane trigger.)

DSTARB – Backplane Trigger Lines (PXIe DSTARB)

STAR – Backplane Trigger Lines (PXI STAR)

TRIG0 – Backplane Trigger Lines (PXI TRIG0)

TRIG1 – Backplane Trigger Lines (PXI TRIG1)

TRIG2 – Backplane Trigger Lines (PXI TRIG2)

TRIG3 – Backplane Trigger Lines (PXI TRIG3)

TRIG4 – Backplane Trigger Lines (PXI TRIG4)

TRIG5 – Backplane Trigger Lines (PXI TRIG5)

TRIG6 – Backplane Trigger Lines (PXI TRIG6)

TRIG7 – Backplane Trigger Lines (PXI TRIG7)

Examples

```
TRIG:ROUTE:INP SMB
```

```
trigger:sequence:route:input smb
```

Query Syntax TRIGger[:SEquence]:ROUTE:INPut?

Return Type Character

Default SMB

TRIGger[:SEquence]:ROUTE:READY <char>

Applicable Models: N522xB, N523xB, N524xB, M937xA, P937xA

(Read-Write) Specifies the connector to use for the trigger OUT ready line.

Note: (M9341A) The trigger signal is always outputted from the receiver SMB connector if trigger source is set at external (:TRIG:SOUR) despite this setup. When you use handler pin 21 on M9341A, the **SMB cable connection** is required.

Parameters

<char> Choose from:

SMB: Meas Trigger in SMB connector

MATH - **handler pin 21** on M9341A/B

Examples

```
TRIG:ROUTE:READ MATH
```

```
trigger:sequence:route:ready math
```

Query Syntax TRIGger[:SEquence]:ROUTE:READY?

Return Type Character

Default SMB

TRIGger[:SEquence]:SCOPE <char>

Applicable Models: All

(Read-Write) Specifies whether a trigger signal is sent to all channels or only the current channel.

See [Triggering the VNA using SCPI](#).

Parameters

<char> Choose from:

- **ALL** - trigger signal is sent to all channels. Also sets **SENS:SWEep:TRIG:POINT OFF** on **ALL** channels.
- **CURRent** - trigger signal is sent to only one channel at a time. With each trigger signal, the channel is incremented to the next triggerable channel.
- **ACTive** - trigger signal is sent to active channel only.

Examples

```
TRIG:SCOP ALL
```

```
trigger:sequence:scope current
```

Query Syntax TRIGger[:SEquence]:SCOPE?

Return Type Character

Default ALL

TRIGger[:SEQuence]:SLOPe <char>

Applicable Models: All

(Read-Write) Specifies the polarity expected by the external trigger input circuitry. Also specify TRIG:TYPE (Level|Edge).

See [Triggering the VNA using SCPI](#).

Parameters

<char> Choose from:

- **POSitive** (rising Edge) or High Level
- **NEGative** (falling Edge) or Low Level

Examples

```
TRIG:SLOP NEG  
trigger:sequence:slope positive
```

Query Syntax TRIGger[:SEQuence]:SLOPe?

Return Type Character

Default POSitive

TRIGger[:SEQuence]:SOURce <char>

Applicable Models: All

(Read-Write) Sets the source of the sweep trigger signal. This command is a super-set of INITiate:CONTinuous which can NOT set the source to External.

See [Triggering the VNA using SCPI](#).

Parameters

<char> Choose from:

- **EXTernal** - external (rear panel) source.
- **IMMediate** - internal source sends continuous trigger signals
- **MANual** - sends one trigger signal when manually triggered from the front panel or INIT:IMM is sent.

Examples TRIG:SOUR EXT
trigger:sequence:source immediate

Query Syntax TRIGger[:SEQuence]:SOURce?

Return Type Character

Default IMMEDIATE

TRIGger[:SEQuence]:TYPE <char>

Applicable Models: All

(Read-Write) Specifies the type of EXTERNAL trigger input detection used to listen for signals on the Meas Trig IN connectors. Edge triggers are most commonly used.

Parameters

<char> Choose from:

EDGE VNA responds to the rising and falling edge of a signal.

LEVel VNA responds to a level (HIGH or LOW).

Use **TRIG:SLOPe** to specify Rising or falling - High or Low.

Examples TRIG:TYPE EDGE
trigger:sequence:type level

Query Syntax TRIGger[:SEQuence]:TYPE?

Return Type Character

Default LEVel

TRIGger:STATus:READy? <char>

Applicable Models: N522xB, N523xB, N524xB, M9485A, E5080A

(Read-only) Checks if the VNA is ready for a hardware trigger.

This command is not intended to be used in a dynamic triggering situation where the ready status is constantly changing. Instead, the expected use is a more static situation where you are expecting the VNA to transition from not ready to ready, and then wait for a trigger. The VNA is polled until it becomes ready and then an operation that triggers the VNA is performed.

Parameters

- <char> **ANY** - Check if the VNA is ready for any of the following hardware triggers.
 - MEAS** - Check if the VNA is ready for an External trigger from the Meas Trig In BNC, Handler IO Pin 18, or Pulse 3 line.
 - AUX1** - Check if the VNA is ready for a trigger from the AUX TRIG 1 IN on the rear panel. (PNA, ENA)
 - AUX2** - Check if the VNA is ready for a trigger from the AUX TRIG 2 IN on the rear panel. (PNA, ENA)

Examples

```
TRIG:STAT:READ? MEAS  
trigger:status:ready? aux1
```

Return Type Boolean

Default Not applicable

SCPI Example Programs

Setup Measurements	Environment
Catalog Measurements	Visual Basic
Create an S-parameter Measurement	VBScript
Create a Balanced Measurement	VBScript
Create an FOM Measurement	
Channels, Windows, and Measurements	VBScript
Setup Sweep Parameters	Visual Basic
Setup the Display	Visual Basic
Setup a Measurement	Visual C++
Triggering the Analyzer	VBScript
Setup Markers	VBScript
Setup PNOP and PSAT Markers	VBScript
Calibrations	See Calibrating the VNA Using SCPI
Calibrate All Channels	VBScript
Guided 2-Port or 4-Port Cal	VBScript
Guided 2-Port Comprehensive Cal	VBScript
Guided ECal	VBScript
Guided Mechanical	VBScript
Guided 1-port Mechanical Cal on Port 2	VBScript
Guided TRL	VBScript
Guided Unknown Thru or TRL Cal (apply Delta Match Cal)	VBScript
Perform a Guided QSOLT Cal	VBScript
Unguided ECal	VBScript
Unguided 2-port Mechanical Cal	VBScript
Unguided 1-port Mechanical Cal on Port 2	VBScript
Unguided 2-port Cal on a 4-Port VNA	Visual Basic
Unguided Thru Response Cals	VBScript
Perform a CalAllChannels Calibration	VBScript
Perform Unguided Cal on Multiple Channels	VBScript
Perform an ECal User Characterization	VBScript
Perform an ECAL Confidence Check	Visual Basic
Perform a Sliding Load Cal	Visual Basic
Load Error Terms during a Cal Sequence	None
Create a New Cal Kit	RMB
Modify a Calibration Kit	Visual Basic

Create and Cal a Noise Figure Measurement
Setup Noise Figure Port Mapping
Create and Cal a GCA Measurement
Create a Spectrum Analyzer Measurement

FCA

Create and Cal a VMC Measurement
Perform a VMC Mixer Characterization
Setup an FCA Segment Sweep
Create and Cal Multiple SMC Channels
Use an Existing Power Cal During an SMC Cal
Create a Pulse Profile Measurement
Create a Wideband Pulse Measurement

Automatic Fixture Removal (AFR)

AFR Using One Differential 2X THRU
AFR Using One Differential OPEN
AFR Using One Single-Ended 2X THRU
AFR Using One Single-Ended OPEN

Source Modulation

Miscellaneous

*ESR? Sweep Complete	VBScript
Getting and Putting Data	Visual Basic
Getting and Putting Data (Definite Block Transfers)	RMB
Transfer Data using MMEM:TRANSfer	RMB
Establish a VISA Session	Visual Basic
Status Reporting	Visual Basic
GPIO Pass-Through	VBScript
VNA as Controller and Talker/Listener	Visual Basic
Upload and Download a Segment List	VBScript
Set ECal States	VBScript

See more programming information and examples at:<http://na.support.keysight.com/pna/programming/>

AFR Using One Differential 2X THRU

This VBScript program performs AFR using one differential 2X THRU, saves the fixture data to a file, then performs deembedding.

Each VBScript (*.vbs) program can be run as a macro in the PNA. To do this, copy the code into a text editor file, such as Notepad, and save it on the PNA hard drive as *.vbs.

[Learn how to setup and run the macro.](#)

See Other SCPI Example Programs

```
Dim app
Dim scpi
Set app = CreateObject("AgilentPNA835x.Application")
Set scpi = app.ScpiStringParser

'The 2X THRU data file should already exist
thruFile = "S:\case_02\AA.s4p"
'Fixture A and B data file will be created or overwritten
fixaFile = "S:\case_02\_demo_fix_a.s4p"
fixbFile = "S:\case_02\_demo_fix_b.s4p"

'AFR extracts fixture files
scpi.Execute("AFR:INITIALize")
scpi.Execute("AFR:FIXTure:INPutS DIFFerential")
scpi.Execute("AFR:FIXTure:MEASurement 4")
scpi.Execute("AFR:STANDard:USE THRU,1")
scpi.Execute("AFR:STANDard:LOAD THRU," & Q(thruFile))
scpi.Execute("AFR:SAVE:PORTs VNA")
scpi.Execute("AFR:SAVE:FILEname " & Q(fixaFile) & "," & Q(fixbFile))
opc = scpi.Execute("*OPC?")

'Deembedding
scpi.Execute("CALC:FSIM:EMB:TYPE C")
scpi.Execute("CALC:FSIM:EMB:TOP:C:PORT 1,2,3,4")
scpi.Execute("CALC:FSIM:EMBed:NETWork1:FILEname " & Q(fixaFile))
scpi.Execute("CALC:FSIM:EMBed:NETWork1:PMAP 1,2,3,4")
scpi.Execute("CALC:FSIM:EMBed:NETWork1:TYPE DEEMbed")
scpi.Execute("CALC:FSIM:EMBed:NETWork2:FILEname " & Q(fixbFile))
scpi.Execute("CALC:FSIM:EMBed:NETWork2:PMAP 1,2,3,4")
scpi.Execute("CALC:FSIM:EMBed:NETWork2:TYPE DEEMbed")
scpi.Execute("CALC:FSIM:EMBed:STATe ON")
scpi.Execute("CALC:FSIM:STATe ON")
opc = scpi.Execute("*OPC?")

Set scpi = Nothing
Set app = Nothing
```

```
'Add double quotation marks to a string  
Function Q(s)  
  Q = Chr(34) & s & Chr(34)  
End Function
```

AFR Using One Differential OPEN

This VBScript program performs AFR using one differential OPEN, saves the fixture data to a file, then performs deembedding.

Each VBScript (*.vbs) program can be run as a macro in the PNA. To do this, copy the code into a text editor file, such as Notepad, and save it on the PNA hard drive as *.vbs.

[Learn how to setup and run the macro.](#)

See Other SCPI Example Programs

```
Dim app
Dim scpi
Set app = CreateObject("AgilentPNA835x.Application")
Set scpi = app.ScpiStringParser

'The AOpen data file should already exist
aopenFile = "S:\case_07\AOpen.s2p"
'Fixture data file will be created or overwritten
fixaFile = "S:\case_07\_demo_fix_a.s4p"

'AFR extracts fixture files
scpi.Execute("AFR:INITialize")
scpi.Execute("AFR:FIXTure:INPutS DIFF")
scpi.Execute("AFR:FIXTure:MEASurement 2")
scpi.Execute("AFR:STANdard:USE AOP,ON")
scpi.Execute("AFR:STANdard:LOAD AOP," & Q(aopenFile))
scpi.Execute("AFR:SAVE:PORTs VNA")
scpi.Execute("AFR:SAVE:FILEname " & Q(fixaFile))
opc = scpi.Execute("*OPC?")

' deembedding
scpi.Execute("CALC:FSIM:EMB:TYPE C")
scpi.Execute("CALC:FSIM:EMB:TOP:C:PORT 1,2,3,4")
scpi.Execute("CALC:FSIM:EMBed:NETWork1:FILEname " & Q(fixaFile))
scpi.Execute("CALC:FSIM:EMBed:NETWork1:PMAp 1,2,3,4")
scpi.Execute("CALC:FSIM:EMBed:NETWork1:TYPE DEEMbed")
scpi.Execute("CALC:FSIM:EMBed:STATe ON")
scpi.Execute("CALC:FSIM:STATe ON")
opc = scpi.Execute("*OPC?")

Set scpi = Nothing
Set app = Nothing

'Add double quotation marks to a string
Function Q(s)
    Q = Chr(34) & s & Chr(34)
```

End Function

AFR Using One Single_Ended 2X THRU

This VBScript program performs AFR using one single-ended 2X THRU, saves the fixture data to a file, then performs deembedding.

Each VBScript (*.vbs) program can be run as a macro in the PNA. To do this, copy the code into a text editor file, such as Notepad, and save it on the PNA hard drive as *.vbs.

[Learn how to setup and run the macro.](#)

See Other SCPI Example Programs

```
Dim app
Dim scpi
Set app = CreateObject("AgilentPNA835x.Application")
Set scpi = app.ScpIStringParser

'The 2X THRU data file should already exist
thruFile = "S:\case_01\AA.s2p"
'Fixture A and B data file will be created or overwritten
fixaFile = "S:\case_01\_demo_fix_a.s2p"
fixbFile = "S:\case_01\_demo_fix_b.s2p"

'AFR extracts fixture files
scpi.Execute("AFR:INITialize")
scpi.Execute("AFR:STANdard:USE THRU,1")
scpi.Execute("AFR:STANdard:LOAD THRU," & Q(thruFile))
scpi.Execute("AFR:SAVE:PORTs VNA")
scpi.Execute("AFR:SAVE:FILEname " & Q(fixaFile) & "," & Q(fixbFile))
opc = scpi.Execute("*OPC?")

'Deembedding
scpi.Execute("CALC:FSIM:SEND:DEEM:PORT1:USER:FILEname " & Q(fixaFile))
scpi.Execute("CALC:FSIM:SEND:DEEM:PORT1:TYPE USER")
scpi.Execute("CALC:FSIM:SEND:DEEM:PORT2:USER:FILEname " & Q(fixbFile))
scpi.Execute("CALC:FSIM:SEND:DEEM:PORT2:TYPE USER")
scpi.Execute("CALC:FSIM:SEND:DEEM:STATE ON")
scpi.Execute("CALC:FSIM:STATE ON")
opc = scpi.Execute("*OPC?")

Set scpi = Nothing
Set app = Nothing

'Add double quotation marks to a string
Function Q(s)
    Q = Chr(34) & s & Chr(34)
End Function
```

AFR Using One Single-Ended OPEN

This VBScript program performs AFR using one single-ended OPEN, saves the fixture data to a file, then performs deembedding.

Each VBScript (*.vbs) program can be run as a macro in the PNA. To do this, copy the code into a text editor file, such as Notepad, and save it on the PNA hard drive as *.vbs.

[Learn how to setup and run the macro.](#)

See Other SCPI Example Programs

```
Dim app
Dim scpi
Set app = CreateObject("AgilentPNA835x.Application")
Set scpi = app.ScpiStringParser

'The AOpen data file should already exist
aopenFile = "S:\case_05\AOpen.s1p"
'Fixture data file will be created or overwritten
fixaFile = "S:\case_05\_demo_fix_a.s2p"

'AFR extracts fixture files
scpi.Execute("AFR:INITialize")
scpi.Execute("AFR:FIXTure:MEASurement 1")
scpi.Execute("AFR:STANdard:USE AOPen")
scpi.Execute("AFR:STANdard:LOAD AOPen," & Q(aopenFile))
scpi.Execute("AFR:SAVE:PORTs VNA")
scpi.Execute("AFR:SAVE:FILEname " & Q(fixaFile))
opc = scpi.Execute("*OPC?")

' deembedding
scpi.Execute("CALC:FSIM:SEND:DEEM:PORT1:USER:FILEname " & Q(fixaFile))
scpi.Execute("CALC:FSIM:SEND:DEEM:PORT1:TYPE USER")
scpi.Execute("CALC:FSIM:SEND:DEEM:STATe ON")
scpi.Execute("CALC:FSIM:STATe ON")
opc = scpi.Execute("*OPC?")

Set scpi = Nothing
Set app = Nothing

'Add double quotation marks to a string
Function Q(s)
    Q = Chr(34) & s & Chr(34)
End Function
```

*ESR? Sweep Complete

This VBScript program polls for the completion of a sweep.

How to run this program:

This VBScript (*.vbs) program can be run as a macro in the analyzer. To do this, copy the following code into a text editor file such as Notepad and save it on the analyzer hard drive as NewMeas.vbs.

[Learn how to setup and run the macro.](#)

See Other SCPI Example Programs

```
sub SweepAndPoll
Write "SYST:PRES"          ' Preset
Write "SENS:SWE:MODE HOLD" ' Put the channel into hold mode
Write "*ESE 1"             ' Turn on the *ESR? bit
Write "*CLS"               ' Clear any pending status
Write "SENS:SWE:TIME 2"   ' Set the sweep time to 2 seconds
Write "SENS:SWE:MODE SING" ' Initiate a sweep, but don't wait for
complete
Write "*OPC"               ' Request notification on sweep
complete
done = 0
count = 0
while (done <> 1)
    Write "*ESR?"          ' Check if sweep is complete
    done = Read()
    count = count + 1
    wscript.echo "Sweep not completed. Try#:" & count
    wscript.sleep 100 ' Wait for 100 ms
wend
```

```
wscript.echo "Sweep Completed. Try#: " & count
end Sub

' Infrastructure to setup the Write/Read functions
dim LastReadBuffer
Sub Write(command)
LastReadBuffer = s.Execute(command)
end sub

Function Read()
Read = LastReadBuffer
end function

' Setup and Call SweepAndPoll
set app = CreateObject("Agilentpna835x.application")
set s = app.scpistringparser
SweepAndPoll
```

Perform a Cal All Channels Calibration

There are two sets of commands used to automate a Cal All Channels Calibration: **SYST:CAL:ALL** <commands> and **SENS<chan>:CORR:COLL:GUIDed** <commands>.

SYST:CAL:ALL <commands>

The general sequence for setting up the Cal All session is as follows:

1. Select the channels to calibrate using the **SYST:CAL:ALL:SEL** command.
2. Select the ports to calibrate using the **SYST:CAL:ALL:CHAN:PORTs** command.
3. Set the properties that are available in Cal All that are relevant to the channels you are calibrating using the **SYST:CAL:ALL:MClass:PROP:VAL** <name>,<val> command. For example, setting <name> to "Include Power Calibration" and <val> to "true" will include a source and receiver power calibration in the Cal All calibration.
4. Query the channel number to use for the remaining cal commands. This channel is used for the sole purpose of acquiring cal data and finds the highest available channel number.

Note: You must query this number – do not assume that it will always be a particular value. For example:
a.chan = SYST:CAL:ALL:GUIDed:CHAN?

SENS<chan>:CORR:COLL:GUIDed <commands>

These commands are identical to the command used for a single channel calibration. However, the number used for the SENSE header is determined by the **SYST:CAL:ALL:GUIDed:CHAN?** command. The general sequence is as follows:

1. Set up the power sensor using the **SENS:CORR:COLL:GUID:PSEnS** commands if you will be performing a power calibration (source and receiver power cal).
2. Set up the connector family and gender per port using the **SENS:CORR:COLL:GUID:CONN:PORT** command.
3. Set up the cal kit per port using the **SENS:CORR:COLL:GUID:CKIT:PORT** command.
4. Initialize the session using the **SENS:CORR:COLL:GUID:INIT** command.
5. Query the number of steps using the **SENS:CORR:COLL:GUID:STEPs?** command.
6. Acquire each step using the **SENS:CORR:COLL:GUID:ACQ** command.
7. Save the calset using the **SENS:CORR:COLL:GUID:SAVE** command.

Cal All Examples

[1-Port, 1-Channel, no Power Cal, with ECal Module](#)

[2-Port, 1-Channel, no Power Cal, with ECal Module](#)

[2-Port, 1-Channel, with Power Cal, with ECal Module](#)

[2-Port, 2-Channel, with Power Cal, with ECal Module](#)

[Noise Figure Cal All](#)

[SMC Cal All](#)

[Cal All for Mixer Channel](#)

[Independent Power Calibration](#)

Each VBScript (*.vbs) program can be run as a macro in the VNA. To do this, copy the code into a text editor file, such as Notepad, and save it on the VNA hard drive as *.vbs.

[Learn how to setup and run the macro.](#)

[See CalAll SCPI commands](#)

[Learn about Cal All](#)

[See Other SCPI Example Programs](#)

Catalog Measurements using SCPI

This Visual Basic Program does the following:

- Catalogs the currently defined measurements, windows, and traces
- Selects a measurement for further definition

- Adds a Title to the window

To run this program, you need:

- An established [GPIB interface connection](#)

See Other SCPI Example Programs

```
Dim Meas as String
Dim Win as String
Dim Trace as String

'Read the current measurements in Channel 1
GPIB.Write "CALCulate1:PARAMeter:CATalog?"
Meas = GPIB.Read
MsgBox ("Ch1 Measurments: " & Meas)

'Read the current windows
GPIB.Write "DISPlay:CATalog?"
Win = GPIB.Read
MsgBox ("Windows: " & Win)

'Read current traces in window 1
GPIB.Write "DISPlay:WINDow1:CATalog?"
Trace = GPIB.Read
MsgBox ("Traces in Window1: " & Win)
```

Channels, Windows, and Measurements using SCPI

This VBScript program does the following:

- Presets the analyzer, deleting the default trace
- Create 2 windows
- Create 2 Measurements
- Feed the measurements to windows / traces
- Change frequency ranges for channels
- Select both measurements
- Turn marker 1 ON for each measurement

The following notes explain the basic structure of the SCPI tree on the analyzer:

- **SOURCE:** and most **SENSE:** commands act on the **channel** that is specified in the command. Channel 1 is default if not specified.
- Most **DISPLAY:** commands act on the **window and trace** specified in the command. Window1 and Trace1 are default if not specified.
- **CALCulate:** commands act on the **selected measurement** in the specified channel. Select the measurement for each channel using `CALCulate<channel number>:PARAmeter:SElect <meas name>`. You can select one measurement in each channel.

See [Traces, Channels, and Windows on the Analyzer](#)

How to run this program:

The SCPI commands in this example are sent over a COM interface using the SCPIStringParser object. You do NOT need a GPIB connection to run this example.

This VBScript (*.vbs) program can be run as a macro in the analyzer. To do this, copy the following code into a text editor file such as Notepad and save it on the analyzer hard drive as NewMeas.vbs.

[Learn how to setup and run the macro.](#)

[See Other SCPI Example Programs](#)

```

Dim app

Dim scpi

' Create / Get the VNA application.

Set app = CreateObject("AgilentPNA835x.Application")

Set scpi = app.ScpiStringParser

'Preset the analyzer

'This command also deletes the default trace

scpi.execute "SYSTEM:FPReset"

'Create Measurements

scpi.execute "CALCulate1:PARAMeter:DEFine:EXT 'Meas1','S11'"

scpi.execute "CALCulate2:PARAMeter:DEFine:EXT 'Meas2','S21'"

' Turn on windows - creates if new

scpi.execute "DISPlay:WINDow1:STATE ON"

scpi.execute "DISPlay:WINDow2:STATE ON"

'Associate ("FEED") the measurement name('Meas1') to WINDow(1), and give the new
TRACe a number(1).

scpi.execute "DISPlay:WINDow1:TRACe1:FEED 'Meas1'"

scpi.execute "DISPlay:WINDow2:TRACe2:FEED 'Meas2'"

'Change each channel's frequency range

scpi.execute "SENSe1:FREQuency:SPAN 1e9"

scpi.execute "SENSe2:FREQuency:SPAN 2e9"

'Select both measurements

scpi.execute "CALCulate1:PARAMeter:SElect 'Meas1'"

scpi.execute "CALCulate2:PARAMeter:SElect 'Meas2'"

'Turn marker 1 ON for each measurement

scpi.execute "CALCulate1:MARKer:STATE ON"

scpi.execute "CALCulate2:MARKer:STATE ON"

```

```
 GPIB.Write "SYSTEM:PRReset"

'Create two windows
 GPIB.Write ":DISPLAY:SPLIT 2"

'Create one trace on each window
 GPIB.Write ":CALCulate1:PARAMeter:COUNT 1"
 GPIB.Write ":CALCulate2:PARAMeter:COUNT 1"

'Define the parameter for each trace
 GPIB.Write ":CALCulate1:MEASure1:PARAMeter 'S21'"
 GPIB.Write ":CALCulate2:MEASure2:PARAMeter 'S12'"

'Change each channel's frequency range
 GPIB.Write "SENSE1:FREQUENCY:SPAN 1e9"
 GPIB.Write "SENSE2:FREQUENCY:SPAN 2e9"

'Turn marker 1 ON for each measurement
 GPIB.Write "CALCulate1:MEASure1:MARKer:STATE ON"
 GPIB.Write "CALCulate2:MEASure2:MARKer:STATE ON"
```

VNA as Controller and Talker / Listener

This Visual Basic Program uses VISA to do the following:

- Control the VNA using a VISA LAN Client interface on the VNA.
- Control another instrument using the VNA as GPIB controller.
- Queries both the analyzer and other instrument to identify themselves with *IDN?

Note: This program can be modified to work from a remote PC to control both instruments. In that case, set up the VNA to be a talker/listener.

To run this program, you need to do the following:

- Add module **visa32.bas** to the VB project.
- **Configure the VNA for VISA / SICL**
- Set up the VNA to be GPIB system controller.
- Connect another instrument to the analyzer through a GPIB cable with Primary address of 13 on GPIB0 interface

See Other SCPI Example Programs

```
Sub main()  
  
'This application run from onboard the VNA  
'can control both the VNA and another GPIB instrument.  
'  
'To run this program the module visa32.bas must be added  
'to the project.  
  
'VISA function status return code  
Dim status As Long  
'Session to Default Resource Manager  
Dim defRM As Long  
'Session to instrument  
Dim viPNA As Long  
'Session to other GPIB instrument  
Dim viInstrument As Long  
'String to hold results  
Dim strRes As String * 200  
On Error GoTo ErrorHandler  
  
status = viOpenDefaultRM(defRM)
```

```

If (status < VI_SUCCESS) Then GoTo VisaErrorHandler

'Open the session to the VNA
status = viOpen(defRM, "GPIB1::16::INSTR", 0, 0, viPNA)
If (status < VI_SUCCESS) Then GoTo VisaErrorHandler

'Ask for the VNA's ID.
status = viVPrintf(viPNA, "*IDN?" + Chr$(10), 0)
If (status < VI_SUCCESS) Then GoTo VisaErrorHandler

'Read the ID as a string.
status = viVScanf(viPNA, "%t", strRes)
If (status < VI_SUCCESS) Then GoTo VisaErrorHandler
'Display the results
MsgBox "PNA is: " + strRes

'Open the session to the other instrument
status = viOpen(defRM, "GPIB0::13::INSTR", 0, 0, viInstrument)
If (status < VI_SUCCESS) Then GoTo VisaErrorHandler

'Ask for the instrument's ID.
status = viVPrintf(viInstrument, "*IDN?" + Chr$(10), 0)
If (status < VI_SUCCESS) Then GoTo VisaErrorHandler

'Read the ID as a string.
status = viVScanf(viPNA, "%t", strRes)
If (status < VI_SUCCESS) Then GoTo VisaErrorHandler

'Display the results
MsgBox "Other instrument is: " + strRes
' Close the resource manager session (which closes everything)
Call viClose(defRM)
End

ErrorHandler:
'Display the error message
MsgBox "*** Error : " + Error$, MB_ICONEXCLAMATION
End

VisaErrorHandler:
Dim strVisaErr As String * 200
Call viStatusDesc(defRM, status, strVisaErr)
MsgBox "*** Error : " + strVisaErr

End
End Sub

```

Create a Balanced Measurement using SCPI

This example program does the following:

- creates several Balanced measurements in separate windows
- generates markers
- calculates statistics
- sets limit lines and queries results
- queries a measurement to determine if we have a balanced parameter and what type it is.

Note: By their nature, balanced measurements are extremely sensitive to phase differences between the two RF paths that make up the balanced port, especially at higher frequencies. A good calibration (not performed in this example) is critical to achieving good balanced measurement results.

The SCPI commands in this example are sent over a COM interface using the SCPIStringParser object. You do NOT need a GPIB connection to run this example.

This VBScript (*.vbs) program can be run as a macro in the VNA. To do this, copy the following code into a text editor file such as Notepad and save it on the VNA hard drive as Balanced.vbs. [Learn how to setup and run the macro.](#)

[See Other SCPI Example Programs](#)

```
Dim app

Dim scpi

' Create / Get the VNA application.

Set app = CreateObject("AgilentPNA835x.Application")

Set scpi = app.ScpiStringParser

' A comment

scpi.Parse("SYST:FPRESET")

' This example uses DUT topology Bal-Bal -
' a DUT with a balanced input and balanced output.
'
' Port mapping for our DUT:
' logical port 1 = physical ports 1 and 4
```

```

' logical port 2 = physical ports 2 and 3
' The default is:
' logical port 1 = physical ports 1 and 2
' logical port 2 = physical ports 3 and 4
'
'
' logical 1          logical 2
'
'      _____
' 1 -----|          |----- 2 +
'          |    DUT    |
' 4 -----|_____   |----- 3 -
'
' Turn on Four windows
scpi.Parse("DISP:WIND1:STATE ON")
scpi.Parse("DISP:WIND2:STATE ON")
scpi.Parse("DISP:WIND3:STATE ON")
scpi.Parse("DISP:WIND4:STATE ON")
' Create a trace called "sdd21", and for that trace turn on the balanced
' transformation and set the balanced transformation to BBAL SDD21.
scpi.Parse("CALC:PAR:DEF:EXT ""sdd21"",S11")
scpi.Parse("CALC:PAR:SEL ""sdd21""")
scpi.Parse("CALC:FSIM:BAL:PAR:STATE ON")
scpi.Parse("CALC:FSIM:BAL:PAR:BBAL:DEF SDD21")
' Feed the sdd21 trace to window 1, trace 1
scpi.Parse("DISP:WIND1:TRAC1:FEED ""sdd21""")
' Similarly create 3 more balanced transmission/conversion parameters
' Create Scd21
scpi.Parse("CALC:PAR:DEF:EXT ""scd21"",S11")
scpi.Parse("CALC:PAR:SEL ""scd21""")

```

```

scpi.Parse("CALC:FSIM:BAL:PAR:STATE ON")

scpi.Parse("CALC:FSIM:BAL:PAR:BBAL:DEF SCD21")

scpi.Parse("DISP:WIND1:TRAC2:FEED ""scd21""")

' Create Sdc21

scpi.Parse("CALC:PAR:DEF:EXT ""sdc21"",S11")

scpi.Parse("CALC:PAR:SEL ""sdc21""")

scpi.Parse("CALC:FSIM:BAL:PAR:STATE ON")

scpi.Parse("CALC:FSIM:BAL:PAR:BBAL:DEF SDC21")

scpi.Parse("DISP:WIND1:TRAC3:FEED ""sdc21""")

' Create Scc21

scpi.Parse("CALC:PAR:DEF:EXT ""scc21"",S11")

scpi.Parse("CALC:PAR:SEL ""scc21""")

scpi.Parse("CALC:FSIM:BAL:PAR:STATE ON")

scpi.Parse("CALC:FSIM:BAL:PAR:BBAL:DEF SCC21")

scpi.Parse("DISP:WIND1:TRAC4:FEED ""scc21""")

' Now create logical port 1 reflection parameters, and place them in window 2

scpi.Parse("CALC:PAR:DEF:EXT ""sdd11"",S11")

scpi.Parse("CALC:PAR:SEL ""sdd11""")

scpi.Parse("CALC:FSIM:BAL:PAR:STATE ON")

scpi.Parse("CALC:FSIM:BAL:PAR:BBAL:DEF SDD11")

' Feed the sdd11 trace to window 2, trace 1

scpi.Parse("DISP:WIND2:TRAC1:FEED ""sdd11""")

' Similarly create 3 more balanced reflection/conversion parameters

scpi.Parse("CALC:PAR:DEF:EXT ""scd11"",S11")

scpi.Parse("CALC:PAR:SEL ""scd11""")

scpi.Parse("CALC:FSIM:BAL:PAR:STATE ON")

scpi.Parse("CALC:FSIM:BAL:PAR:BBAL:DEF SCD11")

scpi.Parse("DISP:WIND2:TRAC2:FEED ""scd11""")

```

```

scpi.Parse("CALC:PAR:DEF:EXT ""sdc11"",S11")
scpi.Parse("CALC:PAR:SEL ""sdc11""")
scpi.Parse("CALC:FSIM:BAL:PAR:STATE ON")
scpi.Parse("CALC:FSIM:BAL:PAR:BBAL:DEF SDC11")
scpi.Parse("DISP:WIND2:TRAC3:FEED ""sdc11""")
scpi.Parse("CALC:PAR:DEF:EXT ""scc11"",S11")
scpi.Parse("CALC:PAR:SEL ""scc11""")
scpi.Parse("CALC:FSIM:BAL:PAR:STATE ON")
scpi.Parse("CALC:FSIM:BAL:PAR:BBAL:DEF SCC11")
scpi.Parse("DISP:WIND2:TRAC4:FEED ""scc11""")
' Now create reverse transmission parameters, and place them in window 3
scpi.Parse("CALC:PAR:DEF:EXT ""sdd12"",S11")
scpi.Parse("CALC:PAR:SEL ""sdd12""")
scpi.Parse("CALC:FSIM:BAL:PAR:STATE ON")
scpi.Parse("CALC:FSIM:BAL:PAR:BBAL:DEF SDD12")
' Feed the sdd11 trace to window 3, trace 1
scpi.Parse("DISP:WIND3:TRAC1:FEED ""sdd12""")
' Similarly create 3 more balanced reverse transmission/conversion parameters
scpi.Parse("CALC:PAR:DEF:EXT ""scd12"",S11")
scpi.Parse("CALC:PAR:SEL ""scd12""")
scpi.Parse("CALC:FSIM:BAL:PAR:STATE ON")
scpi.Parse("CALC:FSIM:BAL:PAR:BBAL:DEF SCD12")
scpi.Parse("DISP:WIND3:TRAC2:FEED ""scd12""")
scpi.Parse("CALC:PAR:DEF:EXT ""sdc12"",S11")
scpi.Parse("CALC:PAR:SEL ""sdc12""")
scpi.Parse("CALC:FSIM:BAL:PAR:STATE ON")
scpi.Parse("CALC:FSIM:BAL:PAR:BBAL:DEF SDC12")

```

```

scpi.Parse("DISP:WIND3:TRAC3:FEED ""sdc12""")
scpi.Parse("CALC:PAR:DEF:EXT ""scc12"",S11")
scpi.Parse("CALC:PAR:SEL ""scc12""")
scpi.Parse("CALC:FSIM:BAL:PAR:STATE ON")
scpi.Parse("CALC:FSIM:BAL:PAR:BBAL:DEF SCC12")
scpi.Parse("DISP:WIND3:TRAC4:FEED ""scc12""")
' Now create reverse reflection parameters, and place them in window 4
scpi.Parse("CALC:PAR:DEF:EXT ""sdd22"",S11")
scpi.Parse("CALC:PAR:SEL ""sdd22""")
scpi.Parse("CALC:FSIM:BAL:PAR:STATE ON")
scpi.Parse("CALC:FSIM:BAL:PAR:BBAL:DEF SDD22")
' Feed the sdd11 trace to window 3, trace 1
scpi.Parse("DISP:WIND4:TRAC1:FEED ""sdd22""")
' Similarly create 3 more balanced reverse reflection parameters
scpi.Parse("CALC:PAR:DEF:EXT ""scd22"",S11")
scpi.Parse("CALC:PAR:SEL ""scd22""")
scpi.Parse("CALC:FSIM:BAL:PAR:STATE ON")
scpi.Parse("CALC:FSIM:BAL:PAR:BBAL:DEF SCD22")
scpi.Parse("DISP:WIND4:TRAC2:FEED ""scd22""")
scpi.Parse("CALC:PAR:DEF:EXT ""sdc22"",S11")
scpi.Parse("CALC:PAR:SEL ""sdc22""")
scpi.Parse("CALC:FSIM:BAL:PAR:STATE ON")
scpi.Parse("CALC:FSIM:BAL:PAR:BBAL:DEF SDC22")
scpi.Parse("DISP:WIND4:TRAC3:FEED ""sdc22""")
scpi.Parse("CALC:PAR:DEF:EXT ""scc22"",S11")
scpi.Parse("CALC:PAR:SEL ""scc22""")
scpi.Parse("CALC:FSIM:BAL:PAR:STATE ON")
scpi.Parse("CALC:FSIM:BAL:PAR:BBAL:DEF SCC22")

```

```

scpi.Parse("DISP:WIND4:TRAC4:FEED ""scc22""")

scpi.Parse("CALC:FSIM:BAL:DEVIce BBALanced")

scpi.Parse("CALC:FSIM:BAL:TOPology:BBAL:PPORTs 1,4,2,3")

' Set up stimulus

scpi.Parse("SENS:SWE:POINts 801")

scpi.Parse("SENS:FREQ:STARt 10e6")

scpi.Parse("SENS:FREQ:STOP 1e9")

' Here we demonstrate how to determine if we have

' a balanced parameter and what type it is.

' Read back one parameter to verify its type

scpi.Parse("CALC:PAR:SEL ""sdd21""")

' Is this a balanced parameter?

isbal = scpi.Parse("CALC:FSIM:BAL:PAR?")

' Which topology/device is set?

device = scpi.Parse("CALC:FSIM:BAL:DEV?")

device = Left( device, Len(device)-1 ) ' strip off newline

' Which parameter are we measuring within that topology?

balparam = scpi.Parse("CALC:FSIM:BAL:PAR:" & device & ":DEF?")

balparam = Left( balparam, Len(balparam)-1 ) ' strip off newline

If isbal Then

WScript.Echo "Balanced Parameter: " & balparam & " in topology: " & device & "."

Else

WScript.Echo "Parameter not balanced."

End If

```

Create a Measurement using SCPI

This VBScript program creates a new S21 measurement and displays it on the VNA screen.

The SCPI commands in this example are sent over a COM interface using the SCPIStringParser object. You do NOT need a GPIB connection to run this example.

This VBScript (*.vbs) program can be run as a macro in the VNA. To do this, copy the following code into a text editor file such as Notepad and save it on the VNA hard drive as NewMeas.vbs. [Learn how to setup and run the macro.](#)

See Other SCPI Example Programs

```
Dim app
Dim scpi
' Create / Get the VNA application.
Set app = CreateObject("AgilentPNA835x.Application")
Set scpi = app.ScpiStringParser

' A comment
'Preset the analyzer
scpi.Execute ("SYST:FPRreset")
' Create and turn on window 1
scpi.Execute ("DISPlay:WINDow1:STATE ON")
'Define a measurement name, parameter
scpi.Execute ("CALCulate:PARAmeter:DEFine:EXT 'MyMeas',S21")
'Associate ("FEED") the measurement name ('MyMeas') to WINDow (1), and give the new
TRACe a number (1).
scpi.Execute ("DISPlay:WINDow1:TRACe1:FEED 'MyMeas'")
```

Example

```
Dim app
Dim scpi
' Create / Get the VNA application.
Set app = CreateObject("AgilentPNA835x.Application")
Set scpi = app.ScpiStringParser

' A comment
'Preset the analyzer
scpi.Execute ("SYST:PREset")
'Define a measurement parameter
scpi.Execute ("CALCulate:MEASure1:PARAmeter 'S21'")
```

Create an FOM Measurement

All three VBScript examples in this topic create a FOM measurement with the following attributes:

- Sweep the Source (input) from 1 GHz to 2 GHz
- Sweep the Receivers (output) from 2 GHz to 3 GHz
- You provide an LO at 1 GHz

[Learn more about Frequency Offset Mode](#)

These programs can be run as a macro in the VNA. To do this, copy the code into a text editor file such as Notepad and save on the VNA hard drive as FOM.vbs. [Learn how to setup and run the macro.](#)

See Other SCPI Example Programs

The following example will run on any VNA model with FOM (opt S93080A). However, these commands have no provisions for internal second source. It uses Sens:Offset commands.

```
' This section gets the VNA application
' starts the scpi parser, and presets the VNA
Set app = CreateObject("AgilentPNA835x.Application")
Set scpi = app.ScpiStringParser
scpi.Execute("SYST:FPRESET")
' Create and turn on window 1
scpi.Execute ("DISPlay:WINDow1:STATE ON")
'Define a measurement name, parameter
scpi.Execute ("CALCulate:PARAmeter:DEFine:EXT 'MyMeas',S21")
'Associate ("FEED") the measurement name ('MyMeas') to WINDow (1)
'and give the new TRACe a number (1).
scpi.Execute ("DISPlay:WINDow1:TRACe1:FEED 'MyMeas'")
```



```

scpi.Execute ("SENS:FREQ:START 1e9")
scpi.Execute ("SENS:FREQ:STOP 2e9")
'set the receivers to be 2e9 -> 3e9
scpi.Execute ("SENS:OFFS:OFFS 1e9")
scpi.Execute ("SENS:OFFS ON")

```

The following example can be run ONLY on a VNA with FOM (opt S93080A). It uses new **Sens:FOM** commands.

```

' This section gets the VNA application
' starts the scpi parser, and presets the VNA
Set app = CreateObject("AgilentPNA835x.Application")
Set scpi = app.ScpiStringParser
scpi.Execute("SYST:FPRESET")
' Create and turn on window 1
scpi.Execute ("DISPlay:WINDow1:STATE ON")
'Define a measurement name, parameter
scpi.Execute ("CALCulate:PARAMeter:DEFine 'MyMeas',S21")
'Associate ("FEED") the measurement name ('MyMeas') to WINDow (1),
and give the new TRACe a number (1).
scpi.Execute ("DISPlay:WINDow1:TRACe1:FEED 'MyMeas'")

scpi.Execute("SENS:FREQ:START 1e9")
scpi.Execute("SENS:FREQ:STOP 2e9")
'set the receivers to be 2e9 -> 3e9
scpi.Execute("SENS:FOM:RANG3:FREQ:OFFS 1e9")
scpi.Execute("SENS:OFFS ON")

```

The following example can be run ONLY on a VNA with FOM (opt S93080A). It uses the internal 2nd source for the fixed LO frequency.

```
' This section gets the VNA application
' starts the scpi parser, and presets the VNA
Set app = CreateObject("AgilentPNA835x.Application")
Set scpi = app.ScpiStringParser
scpi.Execute("SYST:FPRESET")
' Create and turn on window 1
scpi.Execute ("DISPlay:WINDow1:STATE ON")
'Define a measurement name, parameter
scpi.Execute ("CALCulate:PARAMeter:DEFine 'MyMeas',S21")
'Associate ("FEED") the measurement name ('MyMeas') to WINDow (1)
'and give the new TRACe a number (1).
scpi.Execute ("DISPlay:WINDow1:TRACe1:FEED 'MyMeas'")

scpi.Execute ("SENS:FREQ:START 1e9")
scpi.Execute ("SENS:FREQ:STOP 2e9")
'set the receivers to be 2e9 -> 3e9
scpi.Execute ("SENS:FOM:RANG3:FREQ:OFFS 1e9")
'setup the 2nd source frequencies
scpi.Execute ("SENS:FOM:RANG4:COUP 0")
scpi.Execute ("SENS:FOM:RANG4:FREQ:START 1e9")
scpi.Execute ("SENS:FOM:RANG4:FREQ:STOP 1e9")
'turn off coupling
scpi.Execute ("SOUR:POW:COUP 0")
'set LO power to 10dBm
scpi.Execute ("SOUR:POW3 10")
```

'turn ON port 3, our LO signal

```
scpi.Execute ("SOUR:POW3:MODE ON")
```

```
scpi.Execute ("SENS:FOM:STAT ON")
```

Create an SMC Fixed Output Measurement

This VB Script example creates a calibrated SMC fixed output measurement using an external, controlled LO. Then a single sweep is taken and data is retrieved. The external LO is NOT required when using the internal second VNA source for the LO.

Requirements:

- The external LO should be configured to match the SENS:MIX:LO:NAME command below.

Fixed output measurements require that an external LO source be swept and synchronized with the VNA source. FCA performs this synchronization using the external source configuration settings. See [Configure an External Source](#) using SCPI.

The fastest, and recommended, method of controlling the LO source is [Hardware List \(BNC\) triggering mode](#). However, in this mode, FCA channels will not respond to manual triggers. Therefore, the example uses the following mechanism to trigger a sweep:

```
Write "SENS:SWE:MODE HOLD"      'place channel 1 in HOLD mode
Write "INIT:CONT ON"            'place VNA in internal trigger mode
Write "SENS:SWE:MODE SINGLE"
Write "*OPC?"                   'wait until the sweep is complete
Read
```

The SCPI commands in this example are sent over a COM interface using the SCPIStringParser object. You can run a VBScript (*.vbs) program from the VNA [using Macros](#). To run this program, copy the following code into a text editor and save it as a *.vbs file.

```
option explicit

' Setup infrastructure to use the SCPI over COM

dim app

set app = createobject("Agilentpna835x.application")

dim p

set p = app.scpistringparser

dim returnStr

sub Write (command)

    if len(returnStr) <> 0 then

        err.Raise 55,"Write","Query Unterminated"
```

```

end if

returnStr = p.parse(command)

end sub

sub WriteIgnoreError(command)

returnStr = p.Execute(command)

p.Parse("SYST:ERR?") ' clear error queue

end sub

function Read

if len(returnStr) = 0 then

err.Raise 55,"Read","Bad read"

end if

Read = returnStr

returnStr = ""

end function

Write "SYST:PRES"

' When programming in remote mode, hold mode is recommended

Write "SENS:SWE:MODE HOLD"

' Delete the standard measurement

Write "CALC:PAR:DEL:ALL"

' Create an SC21 measurement

Write "CALC:CUST:DEF 'MySC21', 'Scalar Mixer/Converter', 'SC21'"

Write "DISP:WIND:TRACE:FEED 'MySC21'"

Write "CALC:PAR:SEL 'MySC21'"

' Set number of points to 11

Write "SENS:SWE:POIN 11"

' Setup the mixer parameters for a swept LO, fixed output measurement

Write "SENS:MIX:INP:FREQ:START 200e6"

Write "SENS:MIX:INP:FREQ:STOP 700e6"

```

```

Write "SENS:MIX:LO:FREQ:MODE Swept"

Write "SENS:MIX:OUTPUT:FREQ:FIX 3.4e9"

Write "SENS:MIX:OUTP:FREQ:SID HIGH"

Write "SENS:MIX:CALC LO_1"

Write "SENS:MIX:INP:POW -17"

Write "SENS:MIX:LO:POW 10"

Write "SENS:MIX:APPLY

' Specify the LO name, for controlled LO.

' This name is setup in the External Source Config Dialog

Write "SENS:MIX:LO:NAME '8360'"

Write "SENS:MIX:APPLY

' Create an S11 in the same channel

Write "CALC:CUST:DEF 'MyS11', 'Scalar Mixer/Converter', 'S11'"

Write "DISP:WIND:TRACE2:FEED 'MyS11'"

Write "CALC:PAR:SEL 'MyS11'"

' Create an IPwr in the same channel

Write "CALC:CUST:DEF 'MyIPwr', 'Scalar Mixer/Converter', 'IPwr'"

Write "DISP:WIND:TRACE3:FEED 'MyIPwr'"

Write "CALC:PAR:SEL 'MyIPwr'"

' Create an OPwr in the same channel

Write "CALC:CUST:DEF 'MyOPwr', 'Scalar Mixer/Converter', 'OPwr'"

Write "CALC:PAR:SEL 'MyOPwr'"

Write "DISP:WIND:TRACE4:FEED 'MyOPwr'"

' Perform a single sweep, synchronously. When *OPC returns, the sweep is done

Write "SENS:SWE:MODE SINGLE"

Write "*OPC?"

Read

' Retrieve the SC21 data

```

```
Write "CALC:PAR:SEL 'MySC21'"
```

```
Write "CALC:DATA? SDATA"
```

```
dim data
```

```
data = Read()
```

```
wscript.echo("SC21=" & data)
```

```
'Retrieve the S11 data
```

```
Write "CALC:PAR:SEL 'MyS11'"
```

```
Write "CALC:DATA? SDATA"
```

```
data = Read()
```

```
wscript.echo("S11=" & data)
```

Create and Cal a GCA Measurement

This VBS program does the following:

- creates and configures GCA to perform a SMART Sweep
- performs a calibration using an ECal with 3.5 mm Female on Port A and 3.5 mm Male connectors on Port B

This program can be run as a macro in the VNA. To do this, copy the code into a text editor file such as Notepad and save on the VNA hard drive as GCA.vbs. Learn how to setup and run the macro.

See the Gain Compression commands

```
option explicit
```

```
dim CompLevel , Tolerance , StartFreq , StopFreq , NumFreqs , Scale  
 , LinearPower
```

```
dim AcqMode , BackOff , StartPower , StopPower , NumPowers ,  
EnableInterp , CompAlg
```

```
dim DwellTime , IFBandwidth , ShowIterations , host , app , parser
```

```
' GCA Settings/Values
```

```
''
```

```
' Acquisition Mode:
```

```
' naSmartSweep = 0
```

```
' naSweepPowerAtEachFreq2D = 1
```

```
' naSweepFreqAtEachPower2D = 2
```

```
''
```

```
' Compression Algorithm
```

```
' naCompressionFromLinearGain = 0
```

```
' naCompressionFromMaximumGain = 1
```

```
' naBackoffCompression = 2
```



```

'' naXYCompression = 3
''
'' EndOfSweepOperation
'' naDefaultPowerSet = 0
'' naSetToStartPower = 1
'' naSetToStopPower = 2
'' naSetRFOff = 3
''
CompLevel          = 1          ' 1 dB compression level
Tolerance          = 0.05      ' SMART Sweep tolerance
StartFreq          = 1E9
StopFreq           = 9E9
NumFreqs           = 201
Scale              = 0.1
LinearPower        = -20
BackOff            = 10        ' Not used for Deviation from linear gain
StartPower         = -20
StopPower          = 8
NumPowers          = 60        ' Not used for SMART Sweep
DwellTime          = 0.0005   ' Allow some time for DUT bias/thermal
effects
IFBandwidth        = 1000     ' Reasonable trace noise at -20 dBm
EnableInterp       = False    ' Disable interpolation
AcqMode            = 0        ' Smart Sweep
CompAlg            = 0        ' Deviation from linear gain
ShowIterations     = False    ' Configure SMART to not show iteration
results

```

```

dim objargs
set objargs = wscript . Arguments
if ( objArgs . Count = 1) then host = objargs (0)
.....
'' Create and Configuration GCA Channel:
.....
set app = CreateObject ("Agilentpna835x.application" )
set parser = app .ScpiStringParser
call SetupGCA ( parser ,_
               StartFreq ,_
               StopFreq ,_
               NumFreqs ,_
               EnableInterp ,_
               Scale ,_
               CompLevel ,_
               LinearPower ,_
               AcqMode ,_
               BackOff ,_
               StartPower ,_
               StopPower ,_
               NumPowers ,_
               CompAlg ,_
               DwellTime ,_
               IFBAndwidth ,_
               ShowIterations )
call CalGCA ( parser )

```

```

call Analysis( parser )

.....

'' GCA Setup
.....

sub SetupGCA ( parser , StartFreq , StopFreq , NumFreqs ,
EnableInterp , Scale , CompLevel , LinearPower , _
            AcqMode , BackOff , StartPower , StopPower , NumPowers
, CompAlg , DwellTime , IFBAndwidth , _
            ShowIterations )

parser . Parse "*RST "
parser . Parse "CALC:PAR:DEL:ALL "
parser . Parse "CALC:CUST:DEF ""S21"", ""Gain Compression"", ""S21""
"
parser . Parse "DISP:WIND:TRAC1:FEED ""S21"" "
parser . Parse "CALC:PAR:SEL ""S21"" "
parser . Parse "CALC:CUST:DEF ""CompIn21"", ""Gain
Compression"", ""CompIn21"" "
parser . Parse "DISP:WIND:TRAC2:FEED ""CompIn21"" "
parser . Parse "CALC:CUST:DEF ""DeltaGain21"", ""Gain
Compression"", ""DeltaGain21"" "
parser . Parse "DISP:WIND:TRAC3:FEED ""DeltaGain21"" "
parser . Parse "SENS:SWE:MODE HOLD"
parser . Parse "DISP:WIND1:TRAC3:Y:SCAL:PDIV " & Scale
parser . Parse "DISP:WIND1:TRAC3:Y:RLEV " & -CompLevel
select case AcqMode
case 0 ' SMART Sweep
    parser . Parse "SENS:GCS:AMOD SMAR"
case 1 ' 2D Power Sweeps

```

```

    parser . Parse "SENS:GCS:AMOD PFREQ"
case 2 ' 2D Freq Sweeps
    parser . Parse "SENS:GCS:AMOD FPOW"
end select
select case CompAlg
case 0 ' Deviation from linear gain
    parser . Parse "SENS:GCS:COMP:ALG CFLG"
case 1 ' Deviation from max gain
    parser . Parse "SENS:GCS:COMP:ALG CFMG"
case 2 ' Back Off
    parser . Parse "SENS:GCS:COMP:ALG BACK"
case 3 ' XY
    parser . Parse "SENS:GCS:COMP:ALG XYCOM"
end select

if EnableInterp then
    parser . Parse "SENS:GCS:COMP:INT ON"
else
    parser . Parse "SENS:GCS:COMP:INT OFF"
end if

if ShowIterations then
    parser . Parse "SENS:GCS:SMAR:SIT ON"
else
    parser . Parse "SENS:GCS:SMAR:SIT OFF"
end if

```

```

parser . Parse "SENS:GCS:COMP:LEV " & CompLevel
parser . Parse "SENS:GCS:COMP:BACK:LEV " & BackOff
parser . Parse "SENS:GCS:COMP:DELT:X " & BackOff
parser . Parse "SENS:GCS:COMP:DELT:Y " & BackOff
parser . Parse "SENS:GCS:SWE:FREQ:POIN " & NumPowers
parser . Parse "SENS:GCS:SMAR:STIM " & DwellTime
parser . Parse "SENS:BAND " & IFBandwidth
parser . Parse "SENS:SWE:DWEL " & DwellTime
parser . Parse "SOUR:POW:STAR " & StartPower
parser . Parse "SOUR:POW:STOP " & StopPower
parser . Parse "SENS:FREQ:STAR " & StartFreq
parser . Parse "SENS:FREQ:STOP " & StopFreq
parser . Parse "SENS:SWE:POIN " & NumFreqs
parser . Parse "SENS:SWE:MODE SING"

```

```
dim str
```

```
str = parser .Parse ("* OPC ?" )
```

```
end sub
```

```
.....
```

```
'' GCA Calibration
```

```
.....
```

```
sub CalGCA ( parser )
```

```
dim CalSteps , I
```

```

parser . parse "SENS:CORR:COLL:GUID:CONN:PORT1 'APC 3.5 female'"
parser . parse "SENS:CORR:COLL:GUID:CONN:PORT2 'APC 3.5 male'"
parser . parse "SENS:CORR:COLL:GUID:CKIT:PORT1 'N4691-60004 ECal
'"
parser . parse "SENS:CORR:COLL:GUID:CKIT:PORT2 'N4691-60004 ECal
'"
parser . parse "SENS:CORR:GCSetup:POW 0"
parser . parse "SENS:CORR:COLL:GUID:INIT "
CalSteps = parser . parse ( " SENS:CORR:COLL:GUID:STEP ?" )
for I = 1 to CalSteps
  msgBox parser .parse ("SENS:CORR:COLL:GUID:DESC ? " & I )
  parser . parse ( "SENS:CORR:COLL:GUID:ACQ STAN"& I )
next
parser . parse "SENS:CORR:COLL:GUID:SAVE "
msgBox "Done"
end sub

```

```

.....
'' GCA Analysis
.....
sub Analysis( parser )
'select measurement 1
parser.parse "CALC:PAR:MNUM 1"
parser.parse "CALC:GCM:ANAL:ENABLE 1" 'turn on the analysis mode
parser.parse "CALC:GCM:ANAL:CWFR 1e9" 'set the analysis cw frequency
'select measurement 2
parser.parse "CALC:PAR:MNUM 2"

```

```
parser.parse "CALC:GCM:ANAL:ENABLE 1"  
parser.parse "CALC:GCM:ANAL:CWFR 2e9"  
parser.parse "CALC:GCM:ANAL:XAX PSO" 'set the axis to power settings  
'select measurement 3  
parser.parse "CALC:PAR:MNUM 3"  
parser.parse "CALC:GCM:ANAL:ENABLE 1"  
parser.parse "CALC:GCM:ANAL:CWFR 3e9"  
parser.parse "CALC:GCM:ANAL:ISD 0" ' set the discrete frequency  
option to false  
e nd sub
```

Create and Cal a Noise Figure Measurement

This example program creates a Noise Figure measurement, then calibrates the measurement.

You MUST change the ECal Identification strings (in **Blue** font).

Optional: Uncomment the following lines (in **Blue** font) to change these settings:

- Noise Receiver = Noise Receiver to Std (VNA) Receiver
- Cal Method = "Vector" to "Scalar"
- Receiver Characterization Method = "NoiseSource" to "PowerMeter"

This VBScript program can be run as a macro in the VNA. To do this, copy the code into a text editor file such as Notepad and save on the VNA hard drive as NF.vbs. [Learn how to setup and run the macro.](#)

[See the Noise figure commands.](#)

[See Other SCPI Example Programs](#)

```
' This section gets the VNA application
' starts the scpi parser, and presets the VNA
windowNum = 1
channelNum = 1
set pna=CreateObject("AgilentPNA835x.Application")
set scpi = pna.ScpiStringParser
' Create noise figure measurement
scpi.Parse "SYST:FPR"
scpi.Parse "DISP:WIND ON"
scpi.Parse "CALC:CUST:DEF 'noiseFig', 'Noise Figure Cold Source',
'NF'"
scpi.Parse "DISP:WIND:TRAC:FEED 'noiseFig'"
scpi.Parse "CALC:PAR:SEL 'noiseFig'"
```



```

' Substitute appropriate Ecal identification strings here
tunerEcal = "N4691-60004 ECal 02821"
pullEcal = "N4691-60004 ECal 02297"
' configure channel
ConfigureChannel
ConfigureNoiseSettings
' perform calibration
SetupNoiseSource
SetupCalAttributes_Insertable
FinishCalibration
' ----- Support subroutines -----
' Configure noise channel
sub ConfigureChannel
    scpi.Parse "SENS:FREQ:START 750MHz"
    scpi.Parse "SENS:FREQ:STOP 5.0GHz"
    scpi.Parse "SENS:SWEEP:POINTS 401"
    scpi.Parse "SENS:BWID 1.0E3"
end sub
' Configure noise-specific channel settings
sub ConfigureNoiseSettings
    scpi.Parse "SENS:NOIS:REC NOISe"      'Use noise receivers
' scpi.Parse "SENS:NOIS:REC NORM"      'Use std PNA receiver
    scpi.Parse "SENS:NOIS:AVER:STAT ON"   ' turn averaging ON
    scpi.Parse "SENS:NOIS:AVER 40"        ' noise averaging

    scpi.Parse "SENS:NOIS:BWID 8MHz"      ' noise bandwidth
    scpi.Parse "SENS:NOIS:GAIN 30"        ' gain of noise

```

```

receiver

    scpi.Parse "SENS:NOIS:TEMP:AMB 301"      ' ambient temperature, in
Kelvin

    scpi.Parse "SENS:NOIS:IMP:COUN 5"        ' number of tuner
impedance states

    scpi.Parse "SENS:NOIS:TUN:ID '" & tunerEcal & "'" ' set ID of
tuner Ecal module

    scpi.Parse "SENS:NOIS:TUN:INP 'B'"      ' orientation of
tuner input port

    scpi.Parse "SENS:NOIS:TUN:OUTP 'A'"     ' orientation of
tuner output port

    scpi.Parse "SENS:CORR:TCOL:USER:VAL 300" ' noise source cold
temperature

end sub

sub    SetupCalAttributes_Insertable

    scpi.Parse "SENS:CORR:COLL:GUID:CONN:PORT1 'APC 3.5 female'"
    scpi.Parse "SENS:CORR:COLL:GUID:CONN:PORT2 'APC 3.5 male'"
    scpi.Parse "SENS:CORR:COLL:GUID:CKIT:PORT1 '" & pullEcal & "'"
' port 1 calkit
    scpi.Parse "SENS:CORR:COLL:GUID:CKIT:PORT2 '" & pullEcal & "'"
' port 2 calkit

    scpi.Parse "SENS:NOIS:SOUR:CONN 'APC 3.5 male'"      ' noise
source connector type

    scpi.Parse "SENS:NOIS:SOUR:CKIT '" & pullEcal & "'"  ' noise
source calkit

    scpi.Parse "SENS:NOISE:CAL:METHOD 'Vector'"        ' cal
method

'   scpi.Parse "SENS:NOISE:CAL:METHOD 'Scalar'"

    scpi.Parse "SENS:NOISE:CAL:RMETHOD 'NoiseSource'"  'Receiver

```

Characterization method

```
' scpi.Parse "SENS:NOISE:CAL:RMETHOD 'PowerMeter'"
  scpi.Parse "SENS:CORR:COLL:GUID:INIT"
end sub

sub SetupNoiseSource
  ' specify the ENR file for the noise source
  enrfile = "C:/Program Files/Keysight/Network
Analyzer/Noise/346C_MY44420454.enr"
  scpi.Parse "SENS:NOISE:ENR:FILENAME '" & enrfile & "'"
  ' set noise source cold temperature
  scpi.Parse "SENS:CORR:TCOLD:USER:VAL 301.1"
end sub

sub FinishCalibration
  ' Build the connection list and acquire the calibration
  steps = scpi.Parse("SENS:CORR:COLL:GUID:STEPS?")
  for i = 1 to steps
    str = scpi.Parse("SENS:CORR:COLL:GUID:DESC? " & i)
    msgbox str
    scpi.Parse "SENS:CORR:COLL:GUID:ACQ STAN" & i
  next
  scpi.Parse "SENS:CORR:COLL:GUID:SAVE 0"
  wscript.echo "Calibration complete"
end sub
```

Create and Cal a VMC Measurement

The following example program sets up a 1-stage mixer, then performs a full VMC calibration.

By removing the comments (') at the start of the **BLUE code**, it can also do the following:

- Load a mixer setup file
- Use an ECal Module
- Perform manual ECal orientation
- Load a Mixer Characterization

See Also

[Setup Converter commands](#)

[VMC Cal commands](#)

[All Guided Cal commands](#)

Example - [Perform a Mixer Characterization ONLY](#)

This VBScript (*.vbs) program can be run as a macro in the VNA. To do this, copy the following code into a text editor file such as Notepad and save it on the VNA hard drive as VMC.vbs. [Learn how to setup and run the macro.](#)

```
Dim app
Dim scpi
' Create / Get the VNA application.
Set app = CreateObject("AgilentPNA835x.Application")
Set scpi = app.ScpiStringParser
scpi.Parse "SYSTEM:PRESet"

'Create a Vector Mixer Measurement
'First, delete all measurements on the channel
```

```

scpi.Parse "CALC:PAR:DEL:ALL"

'Create a forward scalar mixer measurement and configure it in channel 1.
'The first parameter is a unique identifying string to allow subsequent
'commands to be directed at this specific measurement.

scpi.Parse "CALC:CUST:DEF 'My VC21', 'Vector Mixer/Converter', 'VC21'"

'Setup the new measurement as the 2nd trace in the active window

scpi.Parse "DISP:WIND:TRAC2:FEED 'My VC21'"

'Make the new trace the active measurement

scpi.Parse "CALC:PAR:SEL 'My VC21'"

'The parameters of the mixer measurement can now be configured.
'This can be done by either using the SENS:MIX commands
'for each of the parameters or by loading a mixer setup file.
'Uncomment the following line to load a mixer setup file. The path
'name for the mixer file may be loaded from other mapped drives.

'scpi.Parse "SENS:MIXer:Load 'c:\users\public\network
analyzer\documents\Mixer/MyMixer.mxr'"

' Setup Stimulus

' Points and IFBW are channel settings

scpi.Parse "SENS:SWEep:POINTs 21"

scpi.Parse "SENS:BANDwidth 1e3"

' The rest are mixer settings

scpi.Parse "SENS:MIX:LO:FREQ:MODE SWEpt"

scpi.Parse "SENS:MIX:INPut:FREQ:STAR 3.6e9"

scpi.Parse "SENS:MIX:INPut:FREQ:STOP 3.9e9"

scpi.Parse "SENS:MIX:LO:FREQ:MODE FIXED"

scpi.Parse "SENS:MIX:LO:FREQ:FIX 1e9"

scpi.Parse "SENS:MIX:LO:POW 10"

```

```

scpi.Parse "SENS:MIX:OUTP:FREQ:SID LOW"

scpi.Parse "SENS:MIX:CALC Output"

scpi.Parse "SENS:MIX:LO:NAME 'Port 3'"

scpi.Parse "SENS:MIX:APPLY"

' Perform Cal

' Define the DUT connectors for at ports 1 and 2 of the VNA
scpi.Parse "sens:corr:coll:guid:conn:port1 'APC 3.5 female'"
scpi.Parse "sens:corr:coll:guid:conn:port2 'APC 3.5 male'"
scpi.Parse "sens:corr:coll:guid:conn:port3 'Not used'"
scpi.Parse "sens:corr:coll:guid:conn:port4 'Not used'"

' Specify Mechanical cal kits
scpi.Parse "sens:corr:coll:guid:ckit:port1 '85033D/E'"
scpi.Parse "sens:corr:coll:guid:ckit:port2 '85033D/E'"

' Specify an ECal module the same way
'scpi.Parse "sens:corr:coll:guid:ckit:port1 'N4691-60004 ECal'"
'scpi.Parse "sens:corr:coll:guid:ckit:port2 'N4691-60004 ECal'"

' Non-factory characterizations are specified as follows:
'scpi.Parse "sens:corr:coll:guid:ckit:port2 'N4691-60004 User 1 ECal'"

' When two or more ECal modules with the same model number are connected
' also specify the serial number as follows:
'scpi.Parse "sens:corr:coll:guid:ckit:port2 'N4691-60004 ECal 01234'"

' When Disk Memory ECal user characterizations are used,
' specify both the User char and the serial number as follows:
'scpi.Parse "sens:corr:coll:guid:ckit:port2 'N4691-60004 MyDskChar ECal 01234'"

```

```

'
' By default, VMC requires the measurement of a Calibration Mixer.
' To determine the conversion loss of the calmixer, the cal wizard
' will add a step to perform a 1 port cal at the output of the mixer.
' The following commands opt to perform the mixer
' characterization using a cal kit.
scpi.Parse "SENS:CORR:COLL:GUID:VMC:MIX:CHAR:CAL:OPT CKIT"
' Define the DUT connectors for the output of the characterization mixer
' Use (logical) Port 3. If it is already used by the DUT,
' then specify port 4.
scpi.Parse "sens:corr:coll:guid:conn:port3 'APC 3.5 male'"
' Specify the mechanical cal kit for port 3
scpi.Parse "sens:corr:coll:guid:ckit:port3 '85033D/E'"
' To avoid performing the 1-port cal, provide the cal wizard with a
' mixer characterization file. Uncomment the following line to
' specify the characterization file. This S2P file will be read.
'scpi.Parse "SENS:CORR:COLL:GUID:VMC:MIX:CHAR:CAL:OPT
FILE,'c:\users\public\network analyzer\documents\MyMixer.s2p'"
' ECal orientation
' By default, auto orientation of the ecal module is performed
' Uncomment the following lines to manually orient the ecal
'scpi.Parse "SENS:CORR:PREF:ECAL:ORI OFF"
' for 2-port portion, ecal port A connected to VNA port 1
'scpi.Parse "SENS:CORR:PREF:ECAL:PMAP ECAL2 ="A1,B2"
'for mixer char, ecal port A connected to cal mixer output
'scpi.Parse "SENS:CORR:COLL:GUID:VMC:MIXer:ECAL:PORTmap 1,"A1"

```

```
' the main calibration loop
' a description for the connection instructions is read
' and then the standard is acquired

dim steps, strPrompt

scpi.Parse "sens:corr:coll:guid:init"

steps=scpi.Parse ("sens:corr:coll:guid:steps?")

wscript.echo "Number of Steps = " + cstr(steps)

if (steps > 0) then ' otherwise an error condition occurred

for i = 1 to steps

    strPrompt = scpi.Parse ("sens:corr:coll:guid:desc? " + CStr(i))

    MsgBox strPrompt, vbOKOnly, step

    scpi.Parse ("sens:corr:coll:guid:acq STAN" + CStr(i))

next

scpi.Parse "sens:corr:coll:guid:save"

MsgBox ("Cal is done!")

end if
```

Create and Cal an SMC Measurement

This VB Script example creates and calibrates a scalar mixer measurement.

To run this example **without modification** you need the following:

- An ECal module that covers the frequency range of the measurement.
- A power meter must be available to the VNA. This can be accomplished either by attaching the meter to the VNA via a GPIB cable, or by using SCPI over LAN.

By removing the comments (') at the start of the **BLUE code**, it can also do the following:

- Load a mixer setup file
- Use ECal characterizations
- Specify Mechanical Cal Kits
- Perform manual ECal orientation.
- Specify the thru measurement method.
- Omit the isolation part of the 2-port cal.
- Perform an LO Power Cal.
- Set LO power level on External Source (MUST be pre-configured either remotely or **using the GUI. See example program.**)
- Enable and configure phase measurements

The SCPI commands in this example are sent over a COM interface using the SCPIStringParser object. You do NOT need a GPIB connection to run this example. However, some modification is necessary to make the program run on a traditional GPIB Interface. For example, during the power meter portion of this calibration, scpi.Parse will not process a command until the power meter routine has completed. Traditional GPIB would require a **serial polling technique** to ensure the routine has completed before proceeding.

This VBScript (*.vbs) program can be run as a macro in the VNA. To do this, copy the following code into a text editor file such as Notepad and save it on the VNA hard drive as SMC.vbs. **Learn how to setup and run the macro.**

```
Dim app
```

```

Dim scpi

' Create / Get the VNA application.
Set app = CreateObject("AgilentPNA835x.Application")
Set scpi = app.ScpStringParser

' Create a Scalar Mixer Forward Measurement
'First, delete all measurements on the channel
scpi.Parse "CALC:PAR:DEL:ALL"

'Create a forward scalar mixer measurement and configure it in
'channel 1. The first parameter is a unique
'identifying string (specified by the user) to allow subsequent
'commands to be directed at this specific measurement.
scpi.Parse "CALC:CUST:DEF 'My SC21', 'Scalar Mixer/Converter', 'SC21'"

'Setup the new measurement in the active window
scpi.Parse "DISP:WIND:TRAC:FEED 'My SC21'"

'Make the new trace the active measurement
scpi.Parse "CALC:PAR:SEL 'My SC21'"

'The parameters of the mixer measurement can now be configured.
'This can be done by either using the SENS:MIX commands
'for each of the parameters or by loading a mixer setup file.
'Uncomment the following line to load a mixer setup file. The path name
'for the mixer file may be loaded from other mapped drives.
'scpi.Parse "SENS:MIXer:Load 'c:\users\public\network
analyzer\documents\Mixer/MyMixer.mxr'"

' Setup Stimulus
' Points and IFBW are channel settings
scpi.Parse "SENS:SWEep:POINTs 21"

```

```

scpi.Parse "SENS:BANDwidth 1e3"

' Mixer settings

scpi.Parse "SENS:MIX:INPut:FREQ:MODE SWEpt"
scpi.Parse "SENS:MIX:INPut:FREQ:STAR 3.6e9"
scpi.Parse "SENS:MIX:INPut:FREQ:STOP 3.9e9"
scpi.Parse "SENS:MIX:LO:FREQ:MODE FIXED"
scpi.Parse "SENS:MIX:LO:FREQ:FIX 1e9"
scpi.Parse "SENS:MIX:LO:POW 10"
scpi.Parse "SENS:MIX:OUTP:FREQ:SID LOW"
scpi.Parse "SENS:MIX:CALC Output"
scpi.Parse "SENS:MIX:APPLY"

'First apply the settings, then set LO Name

scpi.Parse "SENS:MIX:LO:NAME 'Port 3'"
scpi.Parse "SENS:MIX:APPLY"

scpi.Parse "SENS:MIX:SAVE "C:/Program Files/Keysight/Network
Analyzer/Documents/Mixer/MyMixer.mrxr""

'-----Perform A Scalar Mixer Calibration-----

'Specify the connector types and the cal kits for each of the ports.

scpi.Parse "SENS:CORR:COLL:GUID:CONN:PORT1:SEL ""APC 3.5 male"""
scpi.Parse "SENS:CORR:COLL:GUID:CONN:PORT2:SEL ""APC 3.5 female"""
scpi.Parse "SENS:CORR:COLL:GUID:CKIT:PORT1:SEL ""N4691-60004 ECal"""
scpi.Parse "SENS:CORR:COLL:GUID:CKIT:PORT2:SEL ""N4691-60004 ECal"""

' Non-factory characterizations are specified as follows:

'scpi.Parse "sens:corr:coll:guid:ckit:port2 'N4691-60004 User 1 ECal'"

' When two or more ECal modules with the same model number are connected
' also specify the serial number as follows:

'scpi.Parse "sens:corr:coll:guid:ckit:port2 'N4691-60004 ECal 01234'"

```

```

' When Disk Memory ECal user characterizations are used,
' specify both the User char and the serial number as follows:
'scpi.Parse "sens:corr:coll:guid:ckit:port2 'N4691-60004 MyDskChar ECal 01234'"
' Uncomment the following lines to manually orient
' the ecal port A connected to VNA port 1
'scpi.Parse "SENS:CORR:PREF:ECAL:ORI OFF"
'scpi.Parse "SENS:CORR:PREF:ECAL:PMAP ECAL2 ="A1,B2"

' Specify Mechanical cal kits
'scpi.Parse "sens:corr:coll:guid:ckit:port1 '85033D/E'"
'scpi.Parse "sens:corr:coll:guid:ckit:port2 '85033D/E'"

'Optional settings
'Specify the thru measurement method.
'Always send an INIT command before the Thru command.
'scpi.Parse "SENS:CORR:COLL:GUID:INIT"
'scpi.Parse "SENS:CORR:COLL:GUID:PATH:TMET 1,2, ""UNDEFINED THRU"""
'Omit the isolation part of the 2-port cal (default behavior).
'scpi.Parse "SENS:CORR:COLL:GUID:ISOL NONE"
'
'Perform LO Power Cal
'scpi.Parse "SENS:CORR:COLL:GUID:SMC:LO1:PCAL 1"
'Set the LO power level for the cal on an external PSG source.
'scpi.Parse "SENS:CORR:COLL:GUID:PSEN1:POW:LEV 10,' PSG'"
'
'Enable and configure Phase measurements
'scpi.Parse "SENS:MIX:PHAS 1"
'scpi.Parse "SENS:MIX:NORM:POIN 1"

```

```

'Using Fixed delay

'scpi.Parse "SENS:CORR:COLL:GUID:SMC:PHAS:METH FIX"

'scpi.Parse "SENS:CORR:COLL:GUID:SMC:PHAS:DEL 12e-9"

'Initialize an SMC guided calibration.

scpi.Parse "SENS:CORR:COLL:GUID:INIT"

'Tell the wizard to generate and report the number of steps in this cal.

Dim steps

Dim desc

'Determine the number of steps required to complete the calibration.

steps = scpi.Parse ("SENS:CORR:COLL:GUID:STEP?")

For i = 1 To steps

'Display the prompt for each step

desc = scpi.Parse ("SENS:CORR:COLL:GUID:DESC? " & CStr(i))

MsgBox (desc)

'Perform the measurement for each step

scpi.Parse "SENS:CORR:COLL:GUID:ACQ STAN" & CStr(i)

Next

'Finish the cal and save the calset

scpi.Parse ("SENS:CORR:COLL:GUID:SAVE ON")

Msgbox ("SMC cal saved to CH1_CALREG")

```

Calibrate Multiple SMC Channels

This example allows you to calibrate multiple SMC channels while connecting the power meter and required standards or ECal module only once.

In the example program:

- Modify `chans = 2` to indicate the number of channels to calibrate.
- You can also change the connector type and cal kit for each port.

The SCPI commands in this example are sent over a COM interface using the `SCPIStringParser` object. You do NOT need a GPIB connection to run this example.

This VBScript (*.vbs) program can be run as a macro in the VNA. To do this, copy the following code into a text editor file such as Notepad and save it on the VNA hard drive as `MultChanCal.vbs`. [Learn how to setup and run the macro.](#)

```
Dim app
Dim scpi
Dim chans
Dim i
Dim steps
Dim desc
' Create / Get the VNA application.
Set app = CreateObject("AgilentPNA835x.Application")
Set scpi = app.ScpiStringParser
app.Preset
' Set number of channels to create
chans = 2
ReDim calset(chans - 1)
For i = 1 To chans
    chanStr = CStr(i+1) ' calibrate on channels 2 and 3
    Dim parm, measName, sens, calc
```

```
parm = "S" & CStr(i) & CStr(i)
measName = "My" & parm
sens = "SENS" & chanStr
calc = "CALC" & chanStr
scpi.Parse calc & ":CUST:DEF '" & measName & "', 'Scalar Mixer/Converter', '"
& parm & ""
```

```
'Setup the new measurement as the 2nd trace in the active window
```

```
scpi.Parse "DISP:WIND:TRAC" & chanStr & ":FEED '" & measName & ""
```

```
'Make the new trace the active measurement
```

```
scpi.Parse calc & ":PAR:SEL '" & measName & ""
```

```
'-----Perform A FCA Mixer Calibration-----
```

```
'Set ports and cal kits for 2 port calibration portion
```

```
scpi.Parse sens & ":CORR:COLL:GUID:CONN:PORT1:SEL ""APC 3.5 male""
```

```
scpi.Parse sens & ":CORR:COLL:GUID:CONN:PORT2:SEL ""APC 3.5 female""
```

```
scpi.Parse sens & ":CORR:COLL:GUID:CKIT:PORT1:SEL ""85052C""
```

```
scpi.Parse sens & ":CORR:COLL:GUID:CKIT:PORT2:SEL ""85052C""
```

```
'ECal modules are specified with the same command
```

```
' scpi.Parse sens & ":CORR:COLL:GUID:CKIT:PORT1:SEL ""N4691-60004 ECal""
```

```
' scpi.Parse sens & ":CORR:COLL:GUID:CKIT:PORT2:SEL ""N4691-60004 ECal""
```

```
'Specify the thru measurement method.
```

```
scpi.Parse sens & ":CORR:COLL:GUID:PATH:TMET 1,2, ""DEFINED THRU""
```

```
'Omit the isolation part of the 2-port cal
```

```
scpi.Parse sens & ":CORR:COLL:GUID:ISOL NONE"
```

```

'Initialize an SMC guided calibration.

scpi.Parse sens & ":CORR:COLL:GUID:INIT"

'Determine the number of steps required to complete the calibration.

steps = scpi.Parse (sens & ":CORR:COLL:GUID:STEP?")

Next

For j = 1 To CInt(steps)

'Display the prompt for each step

desc = scpi.Parse(sens & ":CORR:COLL:GUID:DESC? " & CStr(j))

MsgBox (desc)

'Measure the same standard for each channel

For i = 1 To chans

chanStr = CStr(i+1) ' channel number as string

scpi.Parse "SENS" & chanStr & ":CORR:COLL:GUID:ACQ STAN" & CStr(j)

opc_comp = scpi.Parse("*OPC?")

Next

Next

'Finish the cal and save the calsets

For i = 1 To chans

calset(i - 1) = scpi.Parse("SENS" & CStr(i+1) & ":CORR:COLL:GUID:SAVE ON")

Next

MsgBox ("SMC Cals Complete!")

```

Create New Cal Kit using SCPI

When creating new cal kits programmatically, the order in which cal kit commands are sent can be important.

For example to create a kit with opens, shorts, loads, and thrus. Be sure to use the following sequence for each newly defined standard.

1. Programmatically select the standard number
2. Programmatically select the standard type.
3. Program the cal standard's values.
4. Repeat steps 1, 2, 3 for additional new standards being defined.

```
10  !
20  !
30  ! This example program demonstrates how to create
40  ! new PNA calibration kits.
50  !
60  ! 1) Select a kit not previously defined
70  ! 2) Define open, short, load, and thru cal standards
80  !     Note: Each of the newly defined standards is assigned
90  !     a default connector name. These default connector names
100 !     will be replaced in subsequent steps.
110 ! 3) Use the delete connector command to remove default
120 !     connector names.
130 ! 4) Add connectors. Specify:
140 !     Start and Stop Freq
150 !     Z - Impedance
160 !     sex - MALE, FEMALE, NONE
170 !     media - COAX, WAVE
180 !     cutoff - Frequency for waveguide
190 ! 5) Assign the appropriate connector to each standard
200 ! 6) Modify the class assignments for the standards defined
210 ! 7) Verify the kit values
220 !
230 ! Additional Note: After setting each new cal kit value, it is
240 ! recommended that the program periodically perform queries to
250 ! verify the new values.
260 !
270 ! This will prevent program synchronization issues that can
affect
```

```

280 ! final values stored within new cal kits.
290 !
300 !-----
310 !
320 ! Set up I/O path
330 ASSIGN @Na TO 716
340 DIM Calkname$(80),Conn$(80)
350 INTEGER Calkitnum
360 !
370 CLEAR SCREEN
380 !
390 !!!!!!!!!!!!!!!!!!!!!!!!!!!!!!!!!!!!!!!!!!!!!!!!!!!!!!!!!!!!!!!!!!!!!!!
400 ! Designate the kit selection to be used for performing cal's
410 OUTPUT @Na;":sens:corr:ckit:count?"
420 ENTER @Na;Calkitnum
430 Calkitnum=Calkitnum+1
440 OUTPUT @Na;":sens:corr:coll:ckit "&VAL$(Calkitnum)
450 !
460 ! Name this kit with your own name
470 OUTPUT @Na;":sens:corr:coll:ckit:name ""Special 2.4 mm Model
85056""
480 !
490 !
500 DISP "Defining kit std 1..."
510 ! Now set up standard #1
520 OUTPUT @Na;":sens:corr:coll:ckit:stan 1"
530 OUTPUT @Na;":sens:corr:coll:ckit:stan:type SHORT"
540 Get_std
550 OUTPUT @Na;":sens:corr:coll:ckit:stan:char coax"
560 OUTPUT @Na;":sens:corr:coll:ckit:stan:label ""My Short""
570 Get_label
580 !
590 DISP "Defining kit std 2..."
600 ! Now set up standard #2
610 OUTPUT @Na;":sens:corr:coll:ckit:stan 2"
620 OUTPUT @Na;":sens:corr:coll:ckit:stan:type OPEN"
630 Get_std
640 OUTPUT @Na;":sens:corr:coll:ckit:stan:char coax"
650 OUTPUT @Na;":sens:corr:coll:ckit:stan:label ""My Open""
660 Get_label
670 !
680 DISP "Defining kit std 3..."
690 ! Now set up standard #3
700 OUTPUT @Na;":sens:corr:coll:ckit:stan 3"

```

```

710 OUTPUT @Na;":sens:corr:coll:ckit:stan:type LOAD"
720 Get_std
730 OUTPUT @Na;":sens:corr:coll:ckit:stan:char coax"
740 OUTPUT @Na;":sens:corr:coll:ckit:stan:label ""My Fixed Load""
750 Get_label
760 !
770 DISP "Defining kit std 4..."
780 ! Now set up standard #4
790 OUTPUT @Na;":sens:corr:coll:ckit:stan 4"
800 OUTPUT @Na;":sens:corr:coll:ckit:stan:type THRU"
810 Get_std
820 OUTPUT @Na;":sens:corr:coll:ckit:stan:char coax"
830 OUTPUT @Na;":sens:corr:coll:ckit:stan:label ""My Thru""
840 Get_label
850 !
860 DISP "Defining kit std 5..."
870 ! Now set up standard #5
880 OUTPUT @Na;":sens:corr:coll:ckit:stan 5"
890 OUTPUT @Na;":sens:corr:coll:ckit:stan:type SLOAD"
900 Get_std
910 OUTPUT @Na;":sens:corr:coll:ckit:stan:char coax"
920 OUTPUT @Na;":sens:corr:coll:ckit:stan:label ""Sliding Load""
930 Get_label
940 !
950 DISP "Defining kit std 6..."
960 ! Now set up standard #6
970 !
980 OUTPUT @Na;":sens:corr:coll:ckit:stan 6"
990 OUTPUT @Na;":sens:corr:coll:ckit:stan:type SHORT"
1000 Get_std
1010 OUTPUT @Na;":sens:corr:coll:ckit:stan:char coax"
1020 OUTPUT @Na;":sens:corr:coll:ckit:stan:label ""Short""
1030 Get_label
1040 !
1050 DISP "Defining kit std 7..."
1060 ! Now set up standard #7
1070 OUTPUT @Na;":sens:corr:coll:ckit:stan 7"
1080 OUTPUT @Na;":sens:corr:coll:ckit:stan:type SHORT"
1090 Get_std
1100 OUTPUT @Na;":sens:corr:coll:ckit:stan:char coax"
1110 OUTPUT @Na;":sens:corr:coll:ckit:stan:label ""Short""
1120 Get_label
1130 !
1140 DISP "Defining kit std 8..."

```

```

1150 ! Now set up standard #8
1160 !
1170 OUTPUT @Na;":sens:corr:coll:ckit:stan 8"
1190 OUTPUT @Na;":sens:corr:coll:ckit:stan:type ARBI"
1200 Get_std
1210 OUTPUT @Na;":sens:corr:coll:ckit:stan:char coax"
1220 OUTPUT @Na;":sens:corr:coll:ckit:stan:TZR 15;"
1230 OUTPUT @Na;":sens:corr:coll:ckit:stan:TZI -9;"
1240 OUTPUT @Na;":sens:corr:coll:ckit:stan:label ""Z Load""
1250 Get_label
1260 !
1270 !
1280 !
1290 ! First remove any old connector names
1300 OUTPUT @Na;":sens:corr:coll:ckit:conn:del"
1310 ! Verify that no connectors are currently installed
1320 OUTPUT @Na;":sens:corr:coll:ckit:conn:cat?"
1330 ENTER @Na;Conn$
1340 PRINT "Verify empty list: ";Conn$
1350 !
1360 ! Define your new connectors
1370 OUTPUT @Na;":sens:corr:coll:ckit:conn:add ""PSC
2.4"" ,0HZ,999GHZ,50.0,MALE,COAX,0.0"
1380 OUTPUT @Na;":sens:corr:coll:ckit:conn:add ""PSC
2.4"" ,0HZ,999GHZ,50.0,FEMALE,COAX,0.0"
1390 !
1400 ! Verify that the new connectors are installed
1410 OUTPUT @Na;":sens:corr:coll:ckit:conn:cat?"
1420 ENTER @Na;Conn$
1430 PRINT "Verify new connectors: ";Conn$
1440 DISP ""
1450 !
1460 DISP "Defining conn std 1..."
1470 ! Now set up standard #1
1480 OUTPUT @Na;":sens:corr:coll:ckit:stan 1"
1490 Verify_std
1500 OUTPUT @Na;":sens:corr:coll:ckit:conn:snam ""PSC
2.4"" ,FEMALE,1"
1510 Print_connector
1520 !
1530 DISP "Defining conn std 2..."
1540 ! Now set up standard #2
1550 OUTPUT @Na;":sens:corr:coll:ckit:stan 2"
1560 Verify_std

```

```
1570 OUTPUT @Na;":sens:corr:coll:ckit:conn:snam ""PSC
2.4"" ,FEMALE,1"
1580 Print_connector
1590 !
1600 DISP "Defining conn std 3..."
1610 ! Now set up standard #3
1620 OUTPUT @Na;":sens:corr:coll:ckit:stan 3"
1630 Verify_std
1640 OUTPUT @Na;":sens:corr:coll:ckit:conn:snam ""PSC
2.4"" ,FEMALE,1"
1650 Print_connector
1660 !
1670 DISP "Defining conn std 4..."
1680 ! Now set up standard #4
1690 OUTPUT @Na;":sens:corr:coll:ckit:stan 4"
1700 Verify_std
1710 OUTPUT @Na;":sens:corr:coll:ckit:conn:snam ""PSC
2.4"" ,FEMALE,1"
1720 OUTPUT @Na;":sens:corr:coll:ckit:conn:snam ""PSC 2.4"" ,MALE,2"
1730 Print_connector
1740 !
1750 DISP "Defining conn std 5..."
1760 ! Now set up standard #5
1770 OUTPUT @Na;":sens:corr:coll:ckit:stan 5"
1780 OUTPUT @Na;":sens:corr:coll:ckit:stan:label ""Sliding Load""
1790 Verify_std
1800 OUTPUT @Na;":sens:corr:coll:ckit:conn:snam ""PSC 2.4"" ,MALE,1"
1810 Print_connector
1820 !
1830 DISP "Defining conn std 6..."
1840 ! Now set up standard #6
1850 !
1860 OUTPUT @Na;":sens:corr:coll:ckit:stan 6"
1870 Verify_std
1880 OUTPUT @Na;":sens:corr:coll:ckit:conn:snam ""PSC 2.4"" ,MALE,1"
1890 Print_connector
1900 !
1910 DISP "Defining conn std 7..."
1920 ! Now set up standard #7
1930 OUTPUT @Na;":sens:corr:coll:ckit:stan 7"
1940 Verify_std
1950 OUTPUT @Na;":sens:corr:coll:ckit:conn:snam ""PSC 2.4"" ,MALE,1"
1960 Print_connector
1970 !
```

```

1980 DISP "Defining conn std 8..."
1990 ! Now set up standard #8
2000 OUTPUT @Na;":sens:corr:coll:ckit:stan 8"
2010 Verify_std
2020 OUTPUT @Na;":sens:corr:coll:ckit:conn:snam ""PSC 2.4"",MALE,1"
2030 Print_connector
2040 !
2050 DISP "Class assignments..."
2060 !
2070 ! Designate the "order" associated with measuring the standards
2080 !
2090 ! Set Port 1, 1st standard measured to be standard #2
2100 OUTPUT @Na;":sens:corr:coll:ckit:order1 2"
2110 ! Set Port 1, 2nd standard measured to be standard #1
2120 OUTPUT @Na;":sens:corr:coll:ckit:order2 1,6,7"
2130 ! Set Port 1, 3rd standard measured to be standard #3 and #5
2140 OUTPUT @Na;":sens:corr:coll:ckit:order3 3,5"
2150 ! Set Port 1, 4th standard measured to be standard #4
2160 OUTPUT @Na;":sens:corr:coll:ckit:order4 4"
2170 !
2180 ! Set Port 2, 1st standard measured to be standard #2
2190 OUTPUT @Na;":sens:corr:coll:ckit:order5 2"
2200 ! Set Port 2, 2nd standard measured to be standard #1
2210 OUTPUT @Na;":sens:corr:coll:ckit:order6 1,6,7"
2220 ! Set Port 2, 3rd standard measured to be standard #3 and #6
2230 OUTPUT @Na;":sens:corr:coll:ckit:order7 3,5"
2240 ! Set Port 2, 4th standard measured to be standard #4
2250 OUTPUT @Na;":sens:corr:coll:ckit:order8 4"
2260 !
2270 ! Set Port 1, 1st standard
2280 OUTPUT @Na;":sens:corr:coll:ckit:olabel1 ""MyOpen1""
2290 ! Set Port 1, 2nd standard
2300 OUTPUT @Na;":sens:corr:coll:ckit:olabel2 ""MyShorts1""
2310 ! Set Port 1, 3rd standard
2320 OUTPUT @Na;":sens:corr:coll:ckit:olabel3 ""MyLoads1""
2330 ! Set Port 1, 4th standard measured to be standard #4
2340 OUTPUT @Na;":sens:corr:coll:ckit:olabel4 ""MyThru1""
2350 !
2360 ! Set Port 2, 1st standard
2370 OUTPUT @Na;":sens:corr:coll:ckit:olabel5 ""MyOpen2""
2380 ! Set Port 2, 2nd standard
2390 OUTPUT @Na;":sens:corr:coll:ckit:olabel6 ""MyShorts2""
2400 ! Set Port 2, 3rd standard
2410 OUTPUT @Na;":sens:corr:coll:ckit:olabel7 ""MyLoads2""

```

```
2420 !      Set Port 2, 4th standard
2430 OUTPUT @Na;":sens:corr:coll:ckit:olabel8 ""MyThrus2""
2440 !
2450 BEEP
2460 DISP "Done!"
2470 END
2480 SUB Get_label
2490     OUTPUT 716;":sens:corr:coll:ckit:stan:label?"
2500     ENTER 716;Label$
2510     PRINT Label$
2520 SUBEND
2530 !
2540 SUB Get_std
2550     OUTPUT 716;":sens:corr:coll:ckit:stan:type?"
2560     ENTER 716;Type$
2570     PRINT Type$
2580 SUBEND
2590 !
2600 SUB Print_connector
2610     DIM Nam$(40)
2620     OUTPUT 716;":sens:corr:coll:ckit:conn:sname?"
2630     ENTER 716;Nam$
2640     PRINT Nam$
2650 SUBEND
2660 !
2670 SUB Verify_std
2680     OUTPUT 716;":sens:corr:coll:ckit:stan:label?"
2690     ENTER 716;Label$
2700 SUBEND
2710 !
```

Create a Custom Power Meter Driver

This topic requires that you have a working knowledge of Visual Basic.

This topic will help you create your own power meter driver for use with Source Power Calibration on the VNA. If you are using an Keysight Power Meter to perform a Source Power Calibration, you do NOT need to create your own driver.

Your Power Meter driver will be created from a template written in Visual Basic using VISA over the GPIB bus.

Note: This procedure applies to Visual Basic 6.0. Applicability to Visual Basic .NET has not yet been investigated.

- **Prepare Template Files**
- **Modify Template Files**
- **Compile, Copy, and Register, Your New Driver**
- **Test Your new Driver**

Other SCPI Example Programs

Prepare Template Files

1. Copy all the files from the VNA hard drive C:/Program Files/Keysight/Network Analyzer/Automation/Power Meter Driver Template folder, to a folder on your development PC.
2. In Visual Basic click **File**, then **Open Project...**, find **MyPowerMeter.vbp** (a file you copied from the VNA). Click **Open**. This is a VB ActiveX EXE template, which you will fill in to become your driver.
3. Click **Project**, then **MyPowerMeter Properties**. Click the **General** tab.
4. Overwrite the Project Name with a name of your own choosing. This will be the name of your driver's type library (also the default name of your exe).

Note If the name of your exe does not match the VB Project Name with which it was compiled, registration of the exe on the VNA will not succeed.

5. Set the Project Description. After building your driver if you wish to test it using VB, this is the string that will show up in the VB References list of your test project, and also in the lower pane of the VB Object Browser.

6. Set the Thread Pool size to 1 thread.
7. Click **OK** to close the project properties dialog.
8. From the VB **Project** menu, click **References...** Ensure that **Keysight PNA Power Meter 1.0 Type Library** and **VISA Library** are checked. Click **OK**.

Note: Keysight's implementation of VISA is installed as part of the Keysight I/O Libraries on the VNA. For help on VISA, go to the Windows Start button on your VNA, select Programs, Keysight IO Libraries, VISA Help.

Modify Template Files

From Visual Basic **View** menu click **Project Explorer**. Expand the **Modules** and **Class Modules** folders. Ensure there is one module (WinAPI) and one class module (PowerMeter).

Let's look at the WinAPI module first.

1. In the **Project Explorer** window, click **WinAPI**.
2. From the **View** menu click **Code**.

There is only one line of code you should need to modify in this module: the value of the string constant named `SIDSEARCH`. The comments preceding the declaration of that string describe how to change it. The rest of this module contains functions which will use the Microsoft Windows API to insure proper registration of your driver on the VNA. If you know of other Windows API functions you feel might be helpful to call from within your PowerMeter class module (to help in formatting data, for example), this module would be the place to declare them.

Now let's look at the class module.

1. In the Project Explorer window, click **PowerMeter**.
2. From the **View** menu click **Properties Window**. The **Instancing** property must be set to MultiUse. This allows other applications to create objects from this class, such that one instance of your driver EXE can supply more than one such object at a time.
3. From the **View** menu click **Code**.

Do NOT modify the Interfaces to IPowerMeter subroutines and functions. VNA source power cal expects to find these interfaces as they are currently defined.

The only members that you need to supply code to are those containing “**Your code here**” comments.

In addition, comments have been provided at the beginning of each member to describe the information that member needs to be read from or written to the power meter.

To get an idea of how communicate with the power meter using the VISA functions **viWrite** and **viRead**, examine the code which has been implemented for you in `IPowerMeter_Connect`, `IPowerMeter_QueryMeter`, and `IPowerMeter_WriteMeter`.

Compile, Copy, and Register Your New Driver

When your driver is ready to run, you will first need to compile it into an EXE.

From the File menu select **Make exe**.

After compiling, the following will instruct VB to use the same ID (GUID) every time you re-compile your project.

1. From the **Project** menu, click **PowerMeter Properties**.
2. On the **Component** tab, select **Binary Compatibility** and click ...
3. Browse to and select your project EXE. Click **Open**.
4. Click **OK** to close **Project Properties**.
5. Save your project.
6. Copy your driver EXE file to a folder on your VNA (do NOT use C:/Program Files/Keysight/Network Analyzer/Automation/Power Meter Driver Template folder).
7. Run the EXE file. A message box will pop up reporting whether or not registration was successful. If not successful, it will make a suggestion on what to fix.

When your driver is properly registered, VNA Source Power Cal should be able to associate it with the ID string of your power meter.

Test Your Power Meter Driver

We have also provided a Visual Basic project to test your new Power Meter driver. This project individually calls every `IPowerMeter` method and property in your driver to verify that it performs correctly. Before running the test your PC and VNA must be configured to communicate using DCOM.

1. Connect your PC and the VNA to LAN.

2. Add your PC logon to the VNA. Both logons and password must match to communicate using DCOM. See [Additional VNA users](#).
3. Configure your driver using DCOM Config on the VNA. This will give you permission to launch and access the driver. See Configure for COM-DCOM Programming.

Modify the Test Project

1. In Visual Basic click **File**, then **Open Project...**, find **MyPowerMeterTest.vbp** (a file you copied from the VNA). Click **Open**.
2. From the **Project** menu, click **References...** From the list, find and check your new Power Meter Driver. (It should have been registered on your PC when you successfully made your driver EXE.) Click **OK**.
3. From the **View** menu click **Code**.
4. Modify the **CreateObject** line as follows:
Replace **MyPowerMeter** with the Project Name that you chose for your driver
Replace **MyPNA** with the Computer Name of your VNA.
For example:

```
Set PowerMeterObj = CreateObject("AcmeBrand.PowerMeter", "AGILENT-PNA123")
```

(This assumes that you kept **PowerMeter** as class module name in your driver.)

Run the Test Project

Ensure your power meter is connected to the VNA with a GPIB cable.

Put the VNA in system controller mode:

1. From the VNA **System** menu point to **Configure** then click **SICL/GPIB**.
2. In the GPIB box click **System Controller**.

Run the test project. If there are no errors, the driver is created successfully. If there are errors, try to figure out what went wrong and fix it. Then re-compile, re-copy the .exe to the VNA, and re-run the test. You should not need to re-register the driver or re-modify the test program.

ECALConfidence Check using SCPI

This Visual Basic program performs a complete ECAL confidence check.

To run this program, you need:

- An established GPIB interface connection
- Keysight's VISA or National Instrument's VISA installed on your PC
- The module visa32.bas added to your VB project.
- A form with two buttons: cmdRun and cmdQuit
- A calibrated S11 1-port or N-port measurement active on Channel 1
- Window 1 is visible

Note: A confidence check can NOT be performed remotely from User Characterizations that are stored on the VNA disk.

[See Other SCPI Example Programs](#)

```
'Session to VISA Default Resource Manager
Private defRM As Long
'Session to VNA
Private viPNA As Long
'VISA function status return code
Private status As Long

Private Sub Form_Load()
    defRM = 0
End Sub

Private Sub cmdRun_Click()
'String to receive data from the VNA
Dim strReply As String * 200

' Open the VISA default resource manager
status = viOpenDefaultRM(defRM)
If (status < VI_SUCCESS) Then HandleVISAError

' Open a VISA session (viPNA) to the VNA at GPIB address 16.
status = viOpen(defRM, "GPIB0::16::INSTR", 0, 0, viPNA)
If (status < VI_SUCCESS) Then HandleVISAError
```

```

' Need to set the VISA timeout value to give all our GPIB Reads
' sufficient time to complete before a timeout error occurs.
' For this example, let's try setting the limit to
' 10000 milliseconds (10 seconds).
status = viSetAttribute(viPNA, VI_ATTR_TMO_VALUE, 10000)
If (status < VI_SUCCESS) Then HandleVISAError

' Get the catalog of all the measurements currently on Channel 1.
status = myGPIBWrite(viPNA, "CALC1:PAR:CAT?")
If (status < VI_SUCCESS) Then HandleVISAError
status = myGPIBRead(viPNA, strReply)
If (status < VI_SUCCESS) Then HandleVISAError

' If an S11 measurement named "MY_S11" doesn't already exist,
' then create it.
If InStr(strReply, "MY_S11") = 0 Then
    status = myGPIBWrite(viPNA, "CALC1:PAR:DEF:EXT MY_S11,S11")
    If (status < VI_SUCCESS) Then HandleVISAError
End If
strReply = ""

' Get the catalog of all the trace numbers currently active
' in Window 1.
status = myGPIBWrite(viPNA, "DISP:WIND1:CAT?")
If (status < VI_SUCCESS) Then HandleVISAError

status = myGPIBRead(viPNA, strReply)
If (status < VI_SUCCESS) Then HandleVISAError

' If a trace number 4 already exists in Window 1, then this
' will remove it.
If InStr(strReply, "4") > 0 Then
    status = myGPIBWrite(viPNA, "DISP:WIND1:TRAC4:DEL")
    If (status < VI_SUCCESS) Then HandleVISAError
End If

' Set trace number 4 to MY_S11.
status = myGPIBWrite(viPNA, "DISP:WIND1:TRAC4:FEED MY_S11")
If (status < VI_SUCCESS) Then HandleVISAError

' Set up trace view so we are viewing only the data trace.
status = myGPIBWrite(viPNA, "DISP:WIND1:TRAC4 ON")
If (status < VI_SUCCESS) Then HandleVISAError
status = myGPIBWrite(viPNA, "DISP:WIND1:TRAC4:MEM OFF")
If (status < VI_SUCCESS) Then HandleVISAError

' Select MY_S11 as the measurement to be used for the
' Confidence Check.
status = myGPIBWrite(viPNA, "SENS1:CORR:CCH:PAR MY_S11")
If (status < VI_SUCCESS) Then HandleVISAError

' Acquire the S11 confidence check data from ECal Module A

```

```

' into the memory buffer (asking for an OPC reply when it's done).
status = myGPIBWrite(viPNA, "SENS1:CORR:CCH:ACQ ECAL1;*OPC?")
If (status < VI_SUCCESS) Then HandleVISAError

' The VNA sends an OPC reply ("+1") when the confidence data
' acquisition into memory is complete, so this Read is waiting on
' the reply until it is received.
status = myGPIBRead(viPNA, strReply)
If (status < VI_SUCCESS) Then HandleVISAError

' Turn on trace math so the trace shows data divided by memory.
' You can be confident the S11 calibration is reasonably good if
' the displayed trace varies no more than a few tenths of a dB
' from 0 dB across the entire span.
status = myGPIBWrite(viPNA, "CALC1:PAR:SEL MY_S11")
If (status < VI_SUCCESS) Then HandleVISAError
status = myGPIBWrite(viPNA, "CALC1:MATH:FUNC DIV")
If (status < VI_SUCCESS) Then HandleVISAError
End Sub

Private Sub cmdQuit_Click()
' Turn off trace math
status = myGPIBWrite(viPNA, "CALC1:MATH:FUNC NORM")
If (status < VI_SUCCESS) Then HandleVISAError

' Conclude the confidence check to set the ECal module
' back to it's idle state.
status = myGPIBWrite(viPNA, "SENS1:CORR:CCH:DONE")
If (status < VI_SUCCESS) Then HandleVISAError

' Close the resource manager session (which also closes
' the session to the VNA).
If defRM <> 0 Then Call viClose(defRM)

' End the program
End
End Sub

Private Function myGPIBWrite(ByVal viHandle As Long, ByVal strOut As String) As Long
' The "+ Chr$(10)" appends an ASCII linefeed character to the output, for
' terminating the write transaction.
myGPIBWrite = viVPrintf(viHandle, strOut + Chr$(10), 0)
End Function

Private Function myGPIBRead(ByVal viHandle As Long, strIn As String) As Long
myGPIBRead = viVScanf(viHandle, "%t", strIn)
End Function

Sub HandleVISAError()
Dim strVisaErr As String * 200
Call viStatusDesc(defRM, status, strVisaErr)
MsgBox "*** Error : " + strVisaErr, vbExclamation

```

End
End Sub

Establish a VISA Session

This Visual Basic program demonstrates how to send a SCPI command using VISA and the Keysight IO libraries. To run this program, you need:

- Your PC and VNA both connected to a LAN (for communicating with each other).
- The SICL and VISA components of Keysight's I/O Libraries software installed on your PC. Both are included when you install the software, unless you already have another vendor's VISA installed. Then specify Full SICL and VISA installation to overwrite the other vendor's VISA.
- The module visa32.bas added to your VB project. After you install VISA, the module will be located at C:/VXI/INSTR/INCLUDE/Visa32.bas
- A form with two buttons: cmdRun and cmdQuit.
- Your PC configured to be a VISA LAN Client, and the SICL Server capability enabled on the analyzer. See [Configure for VISA and SICL](#)

[See Other SCPI Example Programs](#)

Note: This example is a piece of a larger VISA program that performs a source power calibration.

```
'Session to VISA Default Resource Manager
Private defRM As Long
'Session to VNA
Private viPNA As Long
'VISA function status return code
Private status As Long

Private Sub Form_Load()
defRM = 0
End Sub

Private Sub cmdRun_Click()
' String to receive data from the VNA.
' Dimensioned large enough to receive scalar comma-delimited values
' for 21 frequency points (20 ASCII characters per point)
Dim strReply As String * 420

' Open the VISA default resource manager
status = viOpenDefaultRM(defRM)
If (status < VI_SUCCESS) Then HandleVISAError

' Open a VISA session (viPNA) to the SICL LAN server
' at "address 16" on the VNA pointed to by the "GPIB0"
' VISA LAN Client on this PC.
' CHANGE GPIB0 TO WHATEVER YOU VNA IS SET TO
```



```

status = viOpen(defRM, "GPIB0::16::INSTR", 0, 0, viPNA)
If (status < VI_SUCCESS) Then HandleVISAError

' Need to set the VISA timeout value to give all our calls to
' myGPIBRead sufficient time to complete before a timeout
' error occurs.
' For this example, let's try setting the limit to
' 30000 milliseconds (30 seconds).
status = viSetAttribute(viPNA, VI_ATTR_TMO_VALUE, 30000)
If (status < VI_SUCCESS) Then HandleVISAError

' Preset the VNA
status = myGPIBWrite(viPNA, "SYST:PRES")
If (status < VI_SUCCESS) Then HandleVISAError

' Print the data using a message box
MsgBox strReply
End Sub

Private Sub cmdQuit_Click()
' Close the resource manager session (which also closes
' the session to the VNA).
If defRM <> 0 Then Call viClose(defRM)

' End the program
End
End Sub

Private Function myGPIBWrite(ByVal viHandle As Long, ByVal strOut As String) As Long
' The "+ Chr$(10)" appends an ASCII linefeed character to the
' output, for terminating the write transaction.
myGPIBWrite = viVPrintf(viHandle, strOut + Chr$(10), 0)
End Function

Private Function myGPIBRead(ByVal viHandle As Long, strIn As String) As Long
myGPIBRead = viVScanf(viHandle, "%t", strIn)
End Function

Sub HandleVISAError()
Dim strVisaErr As String * 200
Call viStatusDesc(defRM, status, strVisaErr)
MsgBox "*** Error : " + strVisaErr, vbExclamation
End
End Sub

```

External Test Set Control using SCPI

This program demonstrates the use of several External Test Set Control commands.

The SCPI commands in this example are sent over a COM interface using the SCPIStringParser object. You do NOT need a GPIB connection to run this example.

This VBScript (*.vbs) program can be run as a macro in the VNA. To do this, copy the following code into a text editor file such as Notepad and save it on the VNA hard drive as ExtTS.vbs. [Learn how to setup and run the macro.](#)

```
' Demonstrate some SCPI commands for external testsets.

Dim pna

Set pna = CreateObject("AgilentPNA835x.Application")

Set scpi = pna.ScpiStringParser

' The K64 testset is only usable on a 4-port VNA

If (pna.NumberOfPorts <> 4) Then

MsgBox("This program only runs on 4-port analyzers.")

Else

'If Help is active, show the measurement window and help

scpi.Execute("DISP:ARR:TILE")

'Return the list of supported test sets

list=scpi.Execute("SENS:MULT:CATALOG?")

MsgBox(list)

'***** K64 *****

'The K64 is connected using the Testset I/O

'connector. There is no handshake information.

'Therefore, a testset need not be connected.

' Load a configuration file.

scpi.Execute("SENS:MULT1:TYPE 'Z5623AK64'")

scpi.Execute("SENS:MULT1:ADDR 0")
```

```

'return stuff about the test set

' Returns number of input ports
Inports=scpi.Execute("SENS:MULT1:INCount?")
MsgBox("Input Ports: " & CStr(Inports))

' Returns number of output ports
ports=scpi.Execute("SENS:MULT1:COUNT?")
MsgBox("Output Ports: " & CStr(ports))

' Returns valid output ports for each input port
For portNum = 1 To Inports
ports=scpi.Execute("SENS:MULT1:PORT" & CStr(portNum) & ":CAT?")
MsgBox("Port " & CStr(portNum) & " catalog: " & (ports))
Next

'Set different port mapping
scpi.Execute("SENS:MULT1:ALLPorts '1 ext R,2 ext R,3 ext R,4 ext R'")

'Return port mapping
portMap=scpi.Execute("SENS:MULT1:ALLPorts?")
MsgBox("Ports will be mapped to " & CStr(portMap))

' Enable external testset control and execute port mapping. This automatically
enables status bar display as well.
scpi.Execute("SENS:MULT1:STATE 1")
MsgBox("Z5623A K64 Enabled")

End If

```

Getting and Putting Data using SCPI

This Visual Basic Program does the following:

- Reads data from the analyzer
- Puts the data back into memory
- To see the data on the analyzer after running the program, from the front panel click:
Trace - Math/Memory - Memory Trace

To run this program, you need:

- An established [GPIB interface connection](#)

See Other SCPI Example Programs

Note: To change the read and write location of data, removing the comment from the beginning of ONE of the lines, and replace the comment in the beginning of the SDATA and SMEM lines.

```
Private Sub ReadWrite_Click()  
Dim i As Integer  
Dim t As Integer  
Dim q As Integer  
Dim dat As String  
Dim cmd As String  
Dim datum() As Double  
  
GPIB.Configure  
GPIB.Write "SYSTem:PRESet;*wai"  
  
'Select the measurement  
GPIB.Write "CALCulate:PARAmeter:SElect 'CH1_S11_1'"  
  
'Read the number of data points  
GPIB.Write "SENSE1:SWEep:POIN?"  
numpts = GPIB.Read  
  
'Turn continuous sweep off  
GPIB.Write "INITiate:CONTInuous OFF"  
  
'Take a sweep  
GPIB.Write "INITiate:IMMEDIATE;*wai"  
  
'Ask for the Data  
  
'PICK ONE OF THESE LOCATIONS TO READ  
'GPIB.Write "CALCulate:DATA? FDATA" 'Formatted Meas  
'GPIB.Write "CALCulate:DATA? FMEM" 'Formatted Memory  
GPIB.Write "CALCulate:DATA? SDATA" 'Corrected, Complex Meas
```

```

'GPIB.Write "CALCulate:DATA? SMEM" 'Corrected, Complex Memory
'GPIB.Write "CALCulate:DATA? SCORR1" 'Error-Term Directivity

'Number of values returned per data point
'q = 1 ' Pick this if reading FDATA or FMEM
q = 2 ' Otherwise pick this

'Parse the data
ReDim datum(q, numpts)
For i = 0 To numpts - 1
  For t = 0 To q - 1
    'Read the Data
    dat = GPIB.Read(20)
    'Parse it into an array
    datum(t, i) = Val(dat)
  Next t
Next i

'PUT THE DATA BACK IN
GPIB.Write "format ascii"

'PICK ONE OF THESE LOCATIONS TO PUT THE DATA
'cmd = "CALCulate:DATA FDATA," 'Formatted Meas
'cmd = "CALCulate:DATA FMEM," 'Formatted Memory
'cmd = "CALCulate:DATA SDATA," 'Corrected, Complex Meas
cmd = "CALCulate:DATA SMEM," 'Corrected, Complex Memory
'cmd = "CALCulate:DATA SCORR1," 'Error-Term Directivity

For i = 0 To numpts - 1
  For t = 0 To q - 1
    If i = numpts - 1 And t = q - 1 Then
      cmd = cmd & Format(datum(t, i))
    Else
      cmd = cmd & Format(datum(t, i)) & ", "
    End If
  Next t
Next i

GPIB.Write cmd
End Sub

```

This Excel VBA Program with VISA-COM does the following:

- Reads data from the analyzer
- Puts the data back into memory

Note: To change the read and write location of data, removing the comment from the beginning of ONE of the lines, and replace the comment in the beginning of the FDATA lines.

```

Sub SampleGetPutData()
  '*** The variables of the resource manager and the instrument I/O are declared.
  Dim ioMgr As VisaComLib.ResourceManager
  Dim GPIB As VisaComLib.FormattedIO488
  '*** The memory area of the resource manager and the instrument I/O are acquired.
  Set ioMgr = New VisaComLib.ResourceManager
  Set GPIB = New VisaComLib.FormattedIO488
  '*** Open the instrument.
  Set GPIB.IO = ioMgr.Open("GPIB0::16::INSTR")
  GPIB.IO.timeout = 10000

  Dim Numpts As Long
  Dim Datam As Variant

  'Select the measurement
  GPIB.WriteString "CALCulatel:MEASure1:PARAMeter 'S21'", True
  'Read the number of data points
  GPIB.WriteString "SENSE1:SWEep:POINTs?", True
  Numpts = GPIB.ReadNumber
  'Turn continuous sweep off
  GPIB.WriteString "INITiate:CONTinuous OFF", True
  'Take a sweep
  GPIB.WriteString "INITiate1:IMMediate;*WAI", True
  'Ask for the Data
  'PICK ONE OF THESE LOCATIONS TO READ
  GPIB.WriteString "CALCulatel:MEASure1:DATA:FDATA?", True
  ' Formatted Meas
  'GPIB.WriteString "CALCulatel:MEASure1:DATA:FMEM?", True
  ' Formatted Memory
  'GPIB.WriteString "CALCulatel:MEASure1:DATA:SDATA?", True
  ' Corrected, Complex Meas
  'GPIB.WriteString "CALCulatel:MEASure1:DATA:SMEM?", True
  ' Corrected, Complex Memory
  'GPIB.WriteString "SENSE1:CORrection:CSET:ETERm:DATA? 'Directivity(1,1)'", True
  ' Error-Term Directivity

  'Parse the data
  Datam = GPIB.ReadList(ASCIIType_R8, ",")

  'PUT THE DATA BACK IN
  GPIB.WriteString "CALCulatel:MEASure1:DATA:FDATA ", False
  ' Formatted Meas
  'GPIB.WriteString "CALCulatel:MEASure1:DATA:FMEM ", False
  ' Formatted Memory
  'GPIB.WriteString "CALCulatel:MEASure1:DATA:SDATA ", False
  ' Corrected, Complex Meas
  'GPIB.WriteString "CALCulatel:MEASure1:DATA:SMEM ", False
  ' Corrected, Complex Memory
  'GPIB.WriteString "SENSE1:CORrection:CSET:ETERm:DATA 'Directivity(1,1)',", False
  ' Error-Term Directivity

```

```
GPIB.WriteList Datam, ASCIIType_R8, ",", True  
  
  *** End procedure  
  GPIB.IO.Close  
End Sub
```

GPIB Pass-Through Example

The SCPI **SYSTem** commands used in this example allow you to send GPIB commands to another GPIB device through the VNA. The other device would typically be connected to the VNA through the System Controller GPIB port on the VNA rear-panel or alternatively be connected using a USB/GPIB interface. Uncomment the line in **Blue text** in the example to open a session for a USB/GPIB interface.

This VB Script example uses the COM SCPIStringParser object. However, this is not critical to the use of these commands; they can be sent using the normal syntax of your programming environment. Using the SCPIStringParser over LAN allows you to communicate with GPIB devices without requiring your remote PC to have a GPIB interface card installed.

Although this method of pass-through works for most applications, there are a couple of limitations:

- All data is transferred using ASCII format. Therefore, transferring large blocks of data is very slow.
- Only read and write functions are possible. Service Interrupts are not supported.

See Other SCPI Example Programs

```
option explicit
dim app
set app = CreateObject("AgilentPNA835x.Application")

dim p
set p = app.ScpiStringParser

' Open a new GPIB session on Bus:0 Device:14 Timeout: 100ms
p.Parse "SYST:COMM:GPIB:RDEV:OPEN 0,14,100"
' The following commented-out line shows opening the same session but
' for a USB/GPIB interface with VISA interface number GPIB4
'p.Parse "SYST:COMM:GPIB:RDEV:OPEN 4,14,100"
dim handleAsStr

' Retrieve the handle (ID number)
handleAsStr = p.Parse ("SYST:COMM:GPIB:RDEV:OPEN?")

' Convert the handle to an integer
dim handleAsInt
handleAsInt = CInt(handleAsStr)

' Send the "*IDN?" query
p.Parse "SYST:COMM:GPIB:RDEV:WRITE " & handleAsInt & ", '*IDN?'"

' Read its results
dim idn
```



```
idn = p.Parse("SYST:COMM:GPIB:RDEV:READ? " & handleAsInt)
msgbox idn

' Close the GPIB session
p.Parse "SYST:COMM:GPIB:RDEV:CLOSE " & handleAsInt
```

See Other SCPI Example Programs

```
/*
 * This example assumes the user's PC has a National Instruments GPIB board. The
example is comprised of three basic parts:
 *
 * 1. Initialization
 * 2. Main Body
 * 3. Cleanup
 *
 * The Initialization portion consists of getting a handle to the VNA and then doing
a GPIB clear of the VNA.
 *
 * The Main Body consists of the VNA SCPI example.
 *
 * The last step, Cleanup, releases the VNA for front panel control.
 */

#include <stdio.h>
#include <stdlib.h>

/*
 * Include the WINDOWS.H and DECL-32.H files. The standard Windows
 * header file, WINDOWS.H, contains definitions used by DECL-32.H and
 * DECL-32.H contains prototypes for the NI GPIB routines and constants.
 */
#include <windows.h>
#include "decl-32.h"

#define ERRMSGSIZE 1024 // Maximum size of SCPI command string
#define ARRAYSIZE 1024 // Size of read buffer

#define BDINDEX 0 // Board Index of GPIB board
#define PRIMARY_ADDR_OF_PNA 16 // GPIB address of VNA
#define NO_SECONDARY_ADDR 0 // VNA has no Secondary address
#define TIMEOUT T10s // Timeout value = 10 seconds
#define EOTMODE 1 // Enable the END message
#define EOSMODE 0 // Disable the EOS mode

int pna;
char ValueStr[ARRAYSIZE + 1];
char ErrorMnemonic[21][5] = {"EDVR", "ECIC", "ENOL", "EADR", "EARG",
    "ESAC", "EABO", "ENEB", "EDMA", "",
    "EOIP", "ECAP", "EFSO", "", "EBUS",
    "ESTB", "ESRQ", "", "", "", "ETAB"};

void GPIBWrite(char* SCPIcmd);
```

```

char *GPIBRead(void);
void GPIBCleanup(int Dev, char* ErrorMessage);

int main()
{

char *opc;
char *result;
char *value;

/*
 * =====
 * INITIALIZATION SECTION
 * =====
 */

/*
 * The application brings the VNA online using ibdev. A device handle,VNA, is
returned and is used in all subsequent calls to the VNA.
 */
pna = ibdev(BDINDEX, PRIMARY_ADDR_OF_PNA, NO_SECONDARY_ADDR,
TIMEOUT, EOTMODE, EOSMODE);
if (ibsta & ERR)
{
printf("Unable to open handle to PNA/nibsta = 0x%x iberr = %d/n",
ibsta, iberr);
return 1;
}

/*
 * Do a GPIB Clear of the VNA. If the error bit ERR is set in ibsta, call
GPIBCleanup with an error message.
 */
ibclr (pna);
if (ibsta & ERR)
{
GPIBCleanup(pna, "Unable to perform GPIB clear of the PNA");
return 1;
}

/*
 * =====
 * MAIN BODY SECTION
 * =====
 */

// Reset the analyzer to instrument preset
GPIBWrite("SYSTEM:FPRESET");

// Create S11 measurement
GPIBWrite("CALCulatel:PARAMeter:DEFine:EXT 'My_S11',S11");

```

```

// Turn on Window #1
GPIBWrite("DISPlay:WINDow1:STATe ON");

// Put a trace (Trace #1) into Window #1 and 'feed' it from the measurement
GPIBWrite("DISPlay:WINDow1:TRACe1:FEED 'My_S11'");

// Setup the channel for single sweep trigger
GPIBWrite("INITiatel:CONTinuous OFF;*OPC?");
opc = GPIBRead();
GPIBWrite("SENSE1:SWEep:TRIGger:POINT OFF");

// Set channel parameters
GPIBWrite("SENSE1:SWEep:POINTs 11");
GPIBWrite("SENSE1:FREQuency:STARt 1000000000");
GPIBWrite("SENSE1:FREQuency:STOP 2000000000");

// Send a trigger to initiate a single sweep
GPIBWrite("INITiatel;*OPC?");
opc = GPIBRead();

// Must select the measurement before we can read the data
GPIBWrite("CALCulatel:PARAMeter:SElect 'My_S11'");

// Read the measurement data into the "result" string variable
GPIBWrite("FORMat ASCII");
GPIBWrite("CALCulatel:DATA? FDATA");
result = GPIBRead();

// Print the data to the display console window
printf("S11(dB) - Visual C++ SCPI Example for PNA/n/n");
value = strtok(result, ",");
while (value != NULL)
{
printf("%s/n", value);
value = strtok(NULL, ",");
}

/*
* =====
* CLEANUP SECTION
* =====
*/

/* The VNA is returned to front panel control. */
ibonl(pna, 0);

return 0;
}

/*
* Write to the VNA

```

```

*/
void GPIBWrite(char* SCPIcmd)
{
int length;
char ErrorMessage[ERRMSGSIZE + 1];
length = strlen(SCPIcmd) ;

    ibwrt (pna, SCPIcmd, length);
    if (ibsta & ERR)
    {
        strcpy(ErrorMessage, "Unable to write this command to PNA:/n");
        strcat(ErrorMessage, SCPIcmd);

        GPIBCleanup(pna, ErrorMessage);
        exit(1);
    }
}

/*
 * Read from the VNA
 */
char* GPIBRead(void)
{
    ibrd (pna, ValueStr, ARRAYSIZE);
    if (ibsta & ERR)
    {
        GPIBCleanup(pna, "Unable to read from the PNA");
        exit(1);
    }
else
    return ValueStr;
}

/*
 * After each GPIB call, the application checks whether the call succeeded. If an
NI-488.2 call fails, the GPIB driver sets the corresponding bit in the global status
variable. If the call failed, this procedure prints an error message, takes the VNA
offline and exits.
 */
void GPIBCleanup(int Dev, char* ErrorMessage)
{
    printf("Error : %s/nibsta = 0x%x iberr = %d (%s)/n",
        ErrorMessage, ibsta, iberr, ErrorMnemonic[iberr]);
    if (Dev != -1)
    {
        printf("Cleanup: Returning PNA to front panel control/n");
        ibonl (Dev, 0);
    }
}

```

Load Error Terms during a Cal Sequence

This example requires that you already have a Cal Set named "foo" that contains a 1-port cal on port 1 and a 1-port cal on port 2.

This example starts a Guided Calibration specifying an Unknown Thru. It loads the 1-port Cals from the existing "foo" Cal Set, then recalculates the number of steps required to complete the cal. After loading the 1-port cals, only the Unknown Thru standard is left to acquire.

```
SENS:CORR:COLL:GUID:CONN:PORT1 "APC 3.5 female"
SENS:CORR:COLL:GUID:CONN:PORT2 "APC 3.5 female"
SENS:CORR:COLL:GUID:CKIT:PORT1 "85033D/E"
SENS:CORR:COLL:GUID:CKIT:PORT2 "85033D/E"
SENS:CORR:COLL:GUID:METH UNKN
' auto-create user calsets for SCPI
SENS:CORR:PREF:CSET:SAVU 1
SENS:CORR:COLL:GUID:INIT
' should return the number 7
SENS:CORR:COLL:GUID:STEPS?
' to port 1, from port 1 in calset
SENS:CORR:COLL:GUID:ETER:LOAD "foo",1,1
' to port 2, from port 2 in calset
SENS:CORR:COLL:GUID:ETER:LOAD "foo",2,2
' should now return the number 1
SENS:CORR:COLL:GUID:STEPS?
' measure the unknown thru
SENS:CORR:COLL:GUID:ACQ STAN1
' save the cal to new user calset
SENS:CORR:COLL:GUID:SAVE
```

Modify a Calibration Kit using SCPI

This Visual Basic program:

- Modifies Calibration kit number 3
- Completely defines standard #4 (thru)

To run this program, you need:

- An established [GPIB interface connection](#)

See Other SCPI Example Programs

```
'Modifying cal kit number 3
Calkitnum = 3

'Designate the kit selection to be used for performing cal's
GPIB.Write "SENSe:CORRection:COLLect:CKIT:SElect " & Val(Calkitnum)

'Reset to factory default values.
GPIB.Write "SENSe:CORRection:COLLect:CKIT:RESet " & Val(Calkitnum)

'Name this kit with your own name
GPIB.Write "SENSe:CORRection:COLLect:CKIT:NAME 'My Cal Kit'"

'Assign standard numbers to calibration classes
'Set Port 1, class 1 (S11A) to be standard #8
GPIB.Write "SENSe:CORRection:COLLect:CKIT:ORDer1 8"
'Set Port 1, class 2 (S11B) to be standard #7
GPIB.Write "SENSe:CORRection:COLLect:CKIT:ORDer2 7"
'Set Port 1, class 3 (S11C) to be standard #3
GPIB.Write "SENSe:CORRection:COLLect:CKIT:ORDer3 3"
'Set Port 1, class 4 (S21T) to be standard #4
GPIB.Write "SENSe:CORRection:COLLect:CKIT:ORDer4 4"
'Set Port 2, class 1 (S22A) to be standard #8
GPIB.Write "SENSe:CORRection:COLLect:CKIT:ORDer5 8"
'Set Port 2, class 2 (S22B) to be standard #7
GPIB.Write "SENSe:CORRection:COLLect:CKIT:ORDer6 7"
'Set Port 2, class 3 (S22C) to be standard #3
GPIB.Write "SENSe:CORRection:COLLect:CKIT:ORDer7 3"
'Set Port 2, class 4 (S12T) to be standard #4
GPIB.Write "SENSe:CORRection:COLLect:CKIT:ORDer8 4"

'Set up Standard #4 completely
'Select Standard #4; the rest of the commands act on it
GPIB.Write "SENSe:CORRection:COLLect:CKIT:STANdard 4"
GPIB.Write "SENSe:CORRection:COLLect:CKIT:STANdard:FMIN 300KHz"
```

```
GPIB.Write "SENSE:CORREction:COLLect:CKIT:STANdard:FMAX 9GHz"  
GPIB.Write "SENSE:CORREction:COLLect:CKIT:STANdard:IMPedance 50"  
GPIB.Write "SENSE:CORREction:COLLect:CKIT:STANdard:DELay 1.234 ns"  
GPIB.Write "SENSE:CORREction:COLLect:CKIT:STANdard:LOSS 23e6"  
GPIB.Write "SENSE:CORREction:COLLect:CKIT:STANdard:C0 0"  
GPIB.Write "SENSE:CORREction:COLLect:CKIT:STANdard:C1 1"  
GPIB.Write "SENSE:CORREction:COLLect:CKIT:STANdard:C2 2"  
GPIB.Write "SENSE:CORREction:COLLect:CKIT:STANdard:C3 3"  
GPIB.Write "SENSE:CORREction:COLLect:CKIT:STANdard:L0 10"  
GPIB.Write "SENSE:CORREction:COLLect:CKIT:STANdard:L1 11"  
GPIB.Write "SENSE:CORREction:COLLect:CKIT:STANdard:L2 12"  
GPIB.Write "SENSE:CORREction:COLLect:CKIT:STANdard:L3 13"  
GPIB.Write "SENSE:CORREction:COLLect:CKIT:STANdard:LABel 'My Special Thru'"  
GPIB.Write "SENSE:CORREction:COLLect:CKIT:STANdard:TYPE THRU"  
GPIB.Write "SENSE:CORREction:COLLect:CKIT:STANdard:CHARacteristic Coax"
```

Perform a Guided 2-Port or 4-Port Cal using SCPI

This example performs a Guided 2-Port or 4-port Calibration using ONE set of calibration standards or an ECAL module.

A measurement must first be set up with desired frequency range, power, and so forth, ready to be calibrated.

The SCPI commands in this example are sent over a COM interface using the SCPIStringParser object. You do NOT need a GPIB connection to run this example.

This VBScript (*.vbs) program can be run as a macro in the VNA. To do this, copy the following code into a text editor file, such as Notepad, and save it on the VNA hard drive as *.vbs.

[Learn how to setup and run the macro.](#)

[See Guided Cal SCPI commands](#)

See Other SCPI Example Programs

```
Dim app
Dim scpi
' Create / Get the VNA application.
Set app = CreateObject("AgilentPNA835x.Application")
Set scpi = app.ScpiStringParser

' To perform 2-port cal, Uncomment TwoPortGuidedCal()
' Then comment FourPortGuidedCal()

'Do 2-port Cal
TwoPortGuidedCal()

'Do 4-port Cal
FourPortGuidedCal

Sub TwoPortGuidedCal()
' Select the connectors
scpi.Execute("sens:corr:coll:guid:conn:port1 ""APC 3.5 female"" ")
scpi.Execute("sens:corr:coll:guid:conn:port2 ""APC 3.5 male"" ")
scpi.Execute("sens:corr:coll:guid:conn:port3 ""Not used"" ")
scpi.Execute("sens:corr:coll:guid:conn:port4 ""Not used"" ")
MsgBox("Connectors defined for Ports 1 and 2")

' Select the Cal Kit for each port being calibrated.

scpi.Execute("sens:corr:coll:guid:ckit:port1 ""85052D"" ")
```

```

scpi.Execute("sens:corr:coll:guid:ckit:port2 ""85052D"" ")

' To use an ECal module instead, comment out the above two lines
' and uncomment the appropriate lines below:
' Your ECal module must already be connected
' via USB to the VNA.

'scpi.Parse "sens:corr:coll:guid:ckit:port1 'N4691-60004 ECal'"
'scpi.Parse "sens:corr:coll:guid:ckit:port2 'N4691-60004 ECal'"

' Non-factory characterizations are specified as follows:
'scpi.Parse "sens:corr:coll:guid:ckit:port2 'N4691-60004 User 1 ECal'"

' When two or more ECal modules with the same model number are connected
' also specify the serial number as follows:
'scpi.Parse "sens:corr:coll:guid:ckit:port2 'N4691-60004 ECal 01234'"

' When Disk Memory ECal user characterizations are used,
' specify both the User char and the serial number as follows:
'scpi.Parse "sens:corr:coll:guid:ckit:port2 'N4691-60004 MyDskChar ECal 01234'"

'

MsgBox("Cal kits defined for Ports 1 and 2")

' Initiate the calibration and query the number of steps
numSteps = GenerateSteps()
' Measure the standards, compute and apply the cal
MeasureAndComplete(numSteps)
End Sub

Sub FourPortGuidedCal()
' Select the connectors
scpi.Execute("sens:corr:coll:guid:conn:port1 ""APC 3.5 female"" ")
scpi.Execute("sens:corr:coll:guid:conn:port2 ""APC 3.5 female"" ")
scpi.Execute("sens:corr:coll:guid:conn:port3 ""APC 3.5 female"" ")
scpi.Execute("sens:corr:coll:guid:conn:port4 ""APC 3.5 female"" ")
MsgBox("Connectors defined for Ports 1 to 4")
' Select the Cal Kit for each port being calibrated.
scpi.Execute("sens:corr:coll:guid:ckit:port1 ""85052D"" ")
scpi.Execute("sens:corr:coll:guid:ckit:port2 ""85052D"" ")
scpi.Execute("sens:corr:coll:guid:ckit:port3 ""85052D"" ")
scpi.Execute("sens:corr:coll:guid:ckit:port4 ""85052D"" ")
' To use an ECal module instead, comment out the above four lines
' and uncomment these four lines and use the part number printed

```

```

' on your module (which in our case was N4431-60003), followed
' by the word 'ECal'. Your ECal module must already be connected
' via USB to the VNA.

' see above for ECal options

'scpi.Execute("sens:corr:coll:guid:ckit:port1 ""N4431-60003 ECal"" ")
'scpi.Execute("sens:corr:coll:guid:ckit:port2 ""N4431-60003 ECal"" ")
'scpi.Execute("sens:corr:coll:guid:ckit:port3 ""N4431-60003 ECal"" ")
'scpi.Execute("sens:corr:coll:guid:ckit:port4 ""N4431-60003 ECal"" ")
MsgBox("Cal kits defined for Ports 1 to 4")

' Initiate the calibration and query the number of steps
numSteps = GenerateSteps()
' If your selected cal kit is not a 4-port ECal module which can
' mate to all 4 ports at once, then you may want to choose which
' thru connections to measure for the cal. You must measure at
' least 3 different thru paths for a 4-port cal (for greatest
' accuracy you can choose to measure a thru connection for all 6
' pairings of the 4 ports). If you omit this command, the default
' is to measure from port 1 to port 2, port 1 to port 3, and
' port 1 to port 4. For this example we select to measure
' from port 1 to port 2, port 2 to port 3, and port 2 to port 4.
scpi.Execute("sens:corr:coll:guid:thru:ports 1,2,2,3,2,4")
' Re-generate the connection steps to account for the thru changes
numSteps = GenerateSteps()
' Measure the standards, compute and apply the cal
MeasureAndComplete(numSteps)
End Sub

Function GenerateSteps()
' Initiate the calibration and query the number of steps
scpi.Execute("sens:corr:coll:guid:init")
GenerateSteps = scpi.Execute("sens:corr:coll:guid:steps?")
End Function

Sub MeasureAndComplete(numSteps)
MsgBox("Number of steps is " + CStr(numSteps))
' Measure the standards
For i = 1 To numSteps
step = "Step " + CStr(i) + " of " + CStr(numSteps)
strPrompt = scpi.Execute("sens:corr:coll:guid:desc? " + CStr(i))
MsgBox strPrompt, vbOKOnly, step
' Note: if you have set up a slow sweep speed (for example, if
' you're using a narrow IF bandwidth) or you're using ECal, and
' while a cal step is being measured you wish to have your program
' perform other operations (like checking for the click event of a
' Cancel button) and you're NOT using the COM ScpiStringParser,
' you can use the optional ASYNchronous argument with the ACQuire
' command as shown in this commented-out line below. The SCPI

```

```
' parser then will return immediately while the cal step measurement
' proceeds (i.e., the parser will NOT block-and-wait for the
' measurement step to finish, so you can send additional commands
' in the meantime). So you can do "*ESR?" or "*STB?" queries to
' monitor the status register bytes to see when the OPC bit gets set,
' which indicates the cal measurement step has finished. This OPC
' detection works for all of the VNA's SCPI parsers except the COM
' ScpiStringParser.
' "sens:corr:coll:guid:acq STAN" + CStr(i) + ",ASYN;*OPC"
scpi.Execute("sens:corr:coll:guid:acq STAN" + CStr(i))
Next
' Conclude the calibration
scpi.Execute("sens:corr:coll:guid:save")
MsgBox ("Cal is done!")
End Sub
```

Perform a Simple Source Power Cal

This example performs a Source Power Cal using ONE USB Power Sensor, already connected to the VNA.

A measurement must first be set up with desired frequency range, power, and so forth, ready to be calibrated.

The SCPI commands in this example are sent over a COM interface using the SCPIStringParser object. You do NOT need a GPIB connection to run this example.

This VBScript (*.vbs) program can be run as a macro in the VNA. To do this, copy the following code into a text editor file, such as Notepad, and save it on the VNA hard drive as spc.vbs.

[Learn how to setup and run the macro.](#)

[See Source Power Cal SCPI commands](#)

See Other SCPI Example Programs

```
'Performs a source power cal on channel 1 - port 1 using a USB power sensor
'This example assumes ONE USB power sensor is connected to the VNA

Dim app

Dim scpi

Dim sensor

' Create / Get the VNA application.

Set app = CreateObject("AgilentPNA835x.Application")

Set scpi = app.ScpiStringParser

scpi.parse "SYST:PRES"

'set power accuracy tolerance and iterations

scpi.parse "SOUR1:POW1:CORR:COLL:ITER:NTOL 0.1"

scpi.parse "SOUR1:POW1:CORR:COLL:ITER:COUN 15"

'set power sensor settling tolerance

scpi.parse "SOUR1:POW1:CORR:COLL:AVER:NTOL 0.1"
```

```
scpi.parse "SOUR1::POW1:CORR:COLL:AVER:COUN 15"

'set offset value for amp or attenuation

scpi.parse "SOUR1:POW1:CORR:OFFS 0 DB"

'show source power cal dialog

scpi.parse "SOUR1:POW1:CORR:COLL:DISP ON"

'read the usb power sensor ID string

sensor=scpi.parse("SYST:COMM:USB:PMET:CAT?")

'specify that sensor

scpi.parse "SYST:COMM:PSEN usb," + sensor

'do the measurement

scpi.parse "SOUR1:POW1:CORR:COLL:ACQ PMR,"ASENSOR""

'save the source cal and create an R-Channel response calset

scpi.parse "SOUR:POW:CORR:COLL:SAVE RREC"
```

Perform an ECal User Characterization

This example performs a user-characterization and stores it to both the ECal module memory and VNA disk memory. It also demonstrates the use of the EXPort, CLear, IMPort and 'KNAME:INF?' commands.

It then performs two 2-port calcs: the first using the characterization from module memory, then using the characterization from disk memory.

Note: This example requires that channel 1 be already calibrated.

The SCPI commands in this example are sent over a COM interface using the SCPIStringParser object. You do NOT need a GPIB connection to run this example.

This VBScript (*.vbs) program can be run as a macro in the VNA. To do this, copy the following code into a text editor file, such as Notepad, and save it on the VNA hard drive as ECal.vbs.

[Learn how to setup and run the macro.](#)

[See all ECal User Characterization SCPI commands](#)

See Other SCPI Example Programs

```
Option Explicit

Dim pna

Set pna = CreateObject("AgilentPNA835x.Application")

Dim scpi

Set scpi = pna.ScpiStringParser

' Substitute here the model number and serial number of your own ECal.
' Note that this example corresponds to a 4-port ECal module with
' serial number 00001. If you have a 2-port ECal module, their model
' numbers are '5x5' numbers -- for example, 'N4691-60001'.

Dim ecalModelNum

ecalModelNum = "N4433A"

Dim ecalSerialNum
```

```

ecalSerialNum = "00001"

scpi.Parse "SENS1:CORR:CKIT:ECAL:CHAR:ID '" & ecalModelNum & "'," & ecalSerialNum
& ""

MsgBox "ECal module to be characterized is: " &
scpi.Parse("SENS1:CORR:CKIT:ECAL:CHAR:ID?")

' Set which user characterization number (1-12) the new characterization
' will be stored to in the ECal module when it is done. If you intend to
' store your user characterization just to VNA Disk Memory and NOT the
' ECal module's memory, then omit this command.

Dim characterizationNumber
characterizationNumber = 1

scpi.Parse "SENS1:CORR:CKIT:ECAL:CHAR:CNUM " & CStr(characterizationNumber)

' The following commented-out lines of code show how you can access
' the list of connector type names you can set for the ports of an
' ECal when you user-characterize it. However, please note that if
' you are writing the user characterization to the ECal module's memory,
' as of yet only the Factory Defined set of connector choices will work
' properly (see SENS:CORR:CKIT:ECAL:CHAR:CONN:CAT?). If you will be saving
' your characterization to just VNA Disk Memory only, then all connector
' names returned by this query will work,
' user-defined connector names as well as factory-defined.

'Dim connTypeList
'connTypeList = scpi.Parse("SENS:CORR:CKIT:ECAL:CHAR:CONN:CAT?")
'MsgBox connTypeList

' For each port of the ECal module, specify which connector type
' is at the end of the adapter (or cable or fixture) that is
' connected to that port of the ECal for the characterization

```



```

' (must be one of the connector types that is included in the
' list that "SENS:CORR:CKIT:ECAL:CHAR:CONN:CAT?" returns). The
' default is "No adapter", which assumes you are characterizing that
' port of the ECal "as is" (nothing attached to it). So in this
' example, Ports C and D of the ECal are being characterized to just
' the ECal's connectors.

scpi.Parse "SENS1:CORR:CKIT:ECAL:CHAR:CONN:PORT1 'APC 3.5 male'" ' ECal Port A
scpi.Parse "SENS1:CORR:CKIT:ECAL:CHAR:CONN:PORT2 'APC 3.5 male'" ' ECal Port B

' As with the connector types, the information set in these next
' few properties also gets stored within the characterization.
' Set the name of the person and/or company that is producing
' this characterization.

scpi.Parse "SENS1:CORR:CKIT:ECAL:CHAR:DESC:USER 'John Doe, Acme Inc.'"
' Set user-specified description of the VNA being used.

scpi.Parse "SENS1:CORR:CKIT:ECAL:CHAR:DESC:VNA 'SN US12345678'"
' Set descriptions of what you have connected to the ECal module's
' ports for the characterization.
' Port A of the ECal

scpi.Parse "SENS1:CORR:CKIT:ECAL:CHAR:DESC:PORT1 '3.5 mm adapter, SN 00001'"
' Port B of the ECal

scpi.Parse "SENS1:CORR:CKIT:ECAL:CHAR:DESC:PORT2 '3.5 mm adapter, SN 00002'"
' Note that the "SENS:CORR:CKIT:ECAL:CHAR:" INITiate, ACQuire and SAVE
' ("CHAR:SAVE" but not "CHAR:DMEMory:SAVE") commands can all each take a
significant
' amount of time to execute/complete. If you are looking at this example to
' leverage this functionality into a SCPI via GPIB or SCPI via SICTL-LAN
' (VXI-11.2/11.3) application, then you could issue the "*CLS" and "*ESE 1"
commands

' as shown in the commented-out lines below, and use your I/O libraries' Serial

```

Poll

```
' function to repeatedly read the status byte until you detect bit 5 (weight of
32)

' in that byte is set. That will happen when the command you are pairing with

' ";*OPC" has completed its operation. But that technique only works for the
GPIB

' and SICL-LAN interfaces. If you need to use the TCPIP Socket or COM

' ScpiStringParser (as is used in this example) SCPI interfaces where there's

' no "built-in" Serial Poll type of function, to ensure your program operates in
a

' synchronized manner it will need to wait on the "*OPC?" reply (and not time
out)

' before proceeding to the next line of your program. In that event, we
recommend

' you execute these commands on a thread of execution separate from your
program's

' user interface thread.

' Of the "SENS:CORR:CKIT:ECAL:CHAR:" INITiate, ACQuire and SAVE commands, the
SAVE

' command takes the longest amount of time to complete (unless you've set up your

' measurement channel to have a very slow sweep time, in which case the ACQuire

' command could take longer). For an ECal that is a N469x, N4432A or N4433A, or
an

' 8509x or N4431x produced by Keysight in 2005 or later, the SAVE command can
take a

' maximum of approximately 4 to 5 minutes to complete (that corresponds to a

' characterization that will result in the ECal's memory becoming completely
filled).

' For an 8509x or N4431x ECal that was produced in 2004 or earlier, the SAVE
command

' can take a maximum of 9 to 10 minutes to complete (again that corresponds to a

' characterization that will result in the ECal's memory becoming completely
full).
```

```

' Begin a user characterization on Channel 1.

' If you will be storing this characterization to the ECal module's memory, then
' the boolean argument to this command is optional (but if you choose to include
it
' for that case then you must specify it as 1 or ON). If you will be storing
this
' characterization to VNA disk memory ONLY, then you should specify 0 or OFF for
' that argument. In this example we will be storing the characterization to both
' module memory and VNA disk memory, so we can just omit the argument and let it
' default to 1.

scpi.Parse "SENS1:CORR:CKIT:ECAL:CHAR:INIT"

Dim numSteps

numSteps = CLng( scpi.Parse("SENS1:CORR:CKIT:ECAL:CHAR:STEP?") )

Dim opcReply

'Dim statusByte

' Measure the steps.

' Note: prior to measuring the steps you must already have a calibration of the
' necessary number of ports applied to the channel (which in this example is
Channel 1).

' Otherwise an error will be reported to the SCPI error queue.

Dim i

For i = 1 To numSteps

    ' Display the step's description.

    MsgBox scpi.Parse("SENS1:CORR:CKIT:ECAL:CHAR:DESC? " & i)

    ' Clear the instrument's Status Byte.

    ' scpi.Execute "*CLS"

    ' Enable for the OPC bit (bit 0, which has weight 1) in the instrument's
    ' Event Status Register, so that when that bit's value transitions from 0 to 1
    ' then the Event Status Register bit in the Status Byte (bit 5 of that byte,

```

```

' weight 32) will become set.

' scpi.Execute "*ESE 1"

' Issue the ACQuire command

opcReply = scpi.Parse("SENS1:CORR:CKIT:ECAL:CHAR:ACQ STAN" & CStr(i) & ";*OPC?")

' scpi.Execute "SENS1:CORR:CKIT:ECAL:CHAR:ACQ STAN" & CStr(i) & ";*OPC"

' Do

' here is where if you leverage this example into an environment where
' you are using SCPI via GPIB or SICTL-LAN, that in this loop you could do a
' Serial Poll via that interface to read the status byte into this
' statusByte variable. Then this If statement would detect when bit 5 is
set.

' If ( (statusByte/32) Mod 2) Then Exit Do

' And note that normally you would want to have your program do some other
' processing (for example, check for user input from keyboard/mouse, for
' a cancellation request) here in this loop.

' Loop

MsgBox "ACQuire is complete"

Next

MsgBox "Now the user characterization will be saved to the ECal module and to PNA
disk memory"

'scpi.Execute "*CLS;*ESE 1"

' Save the user characterization to the ECal module's memory.

opcReply = scpi.Parse("SENS1:CORR:CKIT:ECAL:CHAR:SAVE;*OPC?")

'scpi.Execute "SENS1:CORR:CKIT:ECAL:CHAR:SAVE;*OPC"

'Do

' again here you could do a Serial Poll to get statusByte if using GPIB or
SICTL-LAN

' If ( (statusByte/32) Mod 2) Then Exit Do

'Loop

```

```

' Save the user characterization to VNA Disk Memory.

Dim characterizationName

characterizationName = "test"

opcReply = scpi.Parse("SENS1:CORR:CKIT:ECAL:CHAR:DMEM:SAVE '" &
characterizationName & "';*OPC?")

Dim pnaDiskMemCalKitName

pnaDiskMemCalKitName = GetCalKitName(characterizationName)

' Exporting the characterization from VNA disk memory into a file.

' The file can be used for loading the characterization into VNA disk memory on
another VNA.

scpi.Parse "SENS:CORR:CKIT:ECAL:EXP '" & pnaDiskMemCalKitName & "'"

' Demonstrating that the characterization can be cleared from VNA disk memory and
' then re-loaded (IMPorted) from the file that was created by the
' "SENS:CORR:CKIT:ECAL:EXP".

scpi.Parse "SENS:CORR:CKIT:ECAL:DMEM:CLE '" & pnaDiskMemCalKitName & "'"

scpi.Parse "SENS:CORR:CKIT:ECAL:DMEM:IMP 'C:/Program Files/Keysight/Network
Analyzer/ECal User Characterizations/" & pnaDiskMemCalKitName & ".euc'"

Dim moduleMemCalKitName

moduleMemCalKitName = GetCalKitName("User '" & CStr(characterizationNumber))

MsgBox "Information about the characterization from ECal module memory = '" &
scpi.Parse("SENS:CORR:CKIT:ECAL:KNAM:INF? '" & moduleMemCalKitName & "'"")

MsgBox "Information about the characterization from PNA disk memory = '" &
scpi.Parse("SENS:CORR:CKIT:ECAL:KNAM:INF? '" & pnaDiskMemCalKitName & "'"")

MsgBox "User characterization is complete. Now we will calibrate using it.
First we will use it from ECal module memory."

DoTwoPortCal moduleMemCalKitName

MsgBox "Now we will calibrate using the characterization from PNA Disk Memory."

DoTwoPortCal pnaDiskMemCalKitName

MsgBox "Example has completed"

'

Function GetCalKitName(characterizationName)

```

```

Dim calKitName

calKitName = ecalModelNum

If Len(characterizationName) > 0 Then calKitName = calKitName & " " &
characterizationName

calKitName = calKitName & " ECal " & ecalSerialNum

GetCalKitName = calKitName

End Function

Sub DoTwoPortCal(calKitName)

' Specify the DUT connector for each VNA port to be calibrated (DUT connector =
ECal characterization's connector)

scpi.Parse "SENS1:CORR:COLL:GUID:CONN:PORT1 'APC 3.5 male'"
scpi.Parse "SENS1:CORR:COLL:GUID:CONN:PORT2 'APC 3.5 male'"

' Specify the "cal kit" for each of those ports
scpi.Parse "SENS1:CORR:COLL:GUID:CKIT:PORT1 '" & calKitName & "'"
scpi.Parse "SENS1:CORR:COLL:GUID:CKIT:PORT2 '" & calKitName & "'"

' This results in a calibration sequence of a single "connection step"
scpi.Parse "SENS1:CORR:COLL:GUID:INIT"

' Acquire the cal connection step

opcReply = scpi.Parse("SENS1:CORR:COLL:GUID:ACQ STAN1;*OPC?")

' Again here instead of waiting for opcReply you could do a Serial Poll to get
statusByte if using GPIB or SICT-LAN

'scpi.Execute "SENS1:CORR:COLL:GUID:ACQ STAN1;*OPC"

'Do

' If ( (statusByte/32) Mod 2) Then Exit Do

'Loop

' Conclude the cal and turn it on

scpi.Parse "SENS1:CORR:COLL:GUID:SAVE"

End Sub

```

Perform an Unguided Cal on a 4-Port VNA

This topic describes how to perform an unguided calibration on a multiport network analyzer using SCPI. The objective here is to make clear the relationship between the physical port on which a standard is being measured, the actual device in the cal kit, and the SCPI command used to acquire the device.

There are two sets of SCPI commands that acquire calibrations. One set is used for guided cal, the other for unguided. The SCPI commands that provide remote access to unguided cal are in the SENS:CORR:COLL block:

- SENS:CORR:COLL:METHod
- SENS:CORR:COLL:ACQuire
- SENS:CORR:COLL:SAVE

On a four port network analyzer, the remote programmer needs to be aware of the relationship between the physical port and the calibration kit class assignments. The example program (below) illustrates the usage by performing three unique 2 port cals, taking care to acquire the appropriate standards.

Calibration standards classes are ‘categories’ of standard types. To perform a 2 port calibration, the cal wizard requires the user to measure:

3 reflection standards on the forward port:

- Class S11A typically an open
- Class S11B typically a short
- Class S11C typically a load

Likewise, 3 reflection standards are required for the reverse port:

- Class S22A typically an open
- Class S22B typically a short
- Class S22C typically a load

There is also a transmission standard that is measured in both directions:

- Class S21T typically a thru

The following illustrates the relationship between cal kit physical standards and calibration classes.

Here is a list of the physical devices in my calibration kit.

Standard #1 = "3.5 mm male short"

Standard #2 = "3.5 mm male open"

Standard #3 = "3.5 mm male broadband load"

Standard #4 = "Insertable thru standard"

Standard #5 = "3.5 mm male sliding load"

Standard #6 = "3.5 mm male lowband load"

Standard #7 = "3.5 mm female short"

Standard #8 = "female to female characterized thru adapter"

Standard #9 = "0-2 Load"

Standard #10 = "Open"

Standard #11 = "Non-insertable thru"

Standard #12 = "3.5 mm female lowband load"

Standard #13 = "3.5 mm female sliding load"

Standard #14 = "3.5 mm female broadband load"

Standard #15 = "3.5 mm female open"

When you perform a calibration remotely using SCPI, you don't specify the device number directly.

Rather, you specify the class you want to measure. Each device in the calibration kit is assigned to a class. And since more than one device can be assigned to the same class, each class contains an ordered list of devices. The class assignments are user-settable using the Advanced Modify Cal Kit dialog or the SCPI command:

```
SENS:CORR:COLL:CKIT:ORDeR<class>, <std>, <std>, <std>, <std>, <std>, <std>, <std>
```

The 85052B kit used in the example program had the following standard list for each class: The list was obtained by issuing the corresponding SCPI query:

```
SENS:CORR:COLL:CKIT:OLIST1? S11A = +2,+15,+0,+0,+0,+0,+0
```

SENS:CORR:COLL:CKIT:OLIST2? S11B = +1,+7,+0,+0,+0,+0,+0

SENS:CORR:COLL:CKIT:OLIST3? S11C = +6,+5,+3,+12,+13,+14,+0

SENS:CORR:COLL:CKIT:OLIST4? S21T = +4,+8,+0,+0,+0,+0,+0

SENS:CORR:COLL:CKIT:OLIST5? S22A = +2,+15,+0,+0,+0,+0,+0

SENS:CORR:COLL:CKIT:OLIST6? S22B = +1,+7,+0,+0,+0,+0,+0

SENS:CORR:COLL:CKIT:OLIST7? S22C = +6,+5,+3,+12,+13,+14,+0

SENS:CORR:COLL:CKIT:OLIST8? S12T = +4,+8,+0,+0,+0,+0,+0

When you perform the calibration, you acquire data by issuing the ACQUIRE command:

SENS:CORR:COLL:ACQ <class>[, <subst>]

For example:

SENS:CORR:COLL:SFOR 1

SENS:CORR:COLL:ACQ STANA, SST2

The SFOR command tells the wizard to make the next acquisition in the forward direction. The ACQUIRE command specifies that we are measuring the 2nd device in the list for STANA. And since we are measuring SFORward, STANA refers to class #1 or S11A. The list of devices for this class are specified in the OLIST1 query above. The associations are shown in red.

Alternately, you could modify the device order for the S11A class to move device #15 into the first position (SENS:CORR:COLL:CKIT:ORDER1). When the desired device is in the first position, you needn't specify the order number in the ACQUIRE command. The default is the first device in the OLIST. This worked well for two port network analyzers where the order for S11A,B,C classes were setup for port 1 and the order for S22A,B,C was set up for port 2. With the kit setup in the proper order, you could eliminate the specification of the substandard number (SST<n>).

When performing 2 port calibrations on 4 Port Network Analyzers, the wizard applies S11A,B,C standards to the lower numbered port, S22A,B,C standards to the higher numbered port. Since the two classes (S11A,B,C and S22A,B,C) are applied to multiple ports, the programmer must take into account the ports being measured and take greater care when specifying the ACQUIRE command to ensure that the correct device is being measured.

Port to class relationship

Ports	S11A Port	S22A Port
1,2	1	2
1,3	1	3
1,4	1	4
2,3	2	3
2,4	2	4
3,4	3	4

The following example program shows one method of handling two port calcs on a multiport network analyzer. The connectors at the measurement plane are assumed to be (1) male, (2) female, (3) male, and (4) male. In the example, three calcs are performed: 1-2 (insertable male to female), 2-3 (insertable female to male), and 3-4 (noninsertable using an characterized adapter).

```
option explicit
public scpi
public pna
' assume a 4 port VNA with the following connectors:
' the standard measured on these ports will be the opposite gender
' PORT 1 = 3.5 male
' PORT 2 = 3.5 female
' PORT 3 = 3.5 male
' PORT 4 = 3.5 male
'To perform 2 port calibrations between 1-2, 2-3, and 3-4 you need to do the
following

call main

sub main
set pna = CreateObject("AgilentPnA835x.Application")
set scpi = pna.ScpiStringParser
pna.Preset
' select a kit to use for this demonstration
' kit #1 for the N5230A is the 85052B 3.5mm kit with sliding load
scpi.execute("SENS:CORR:COLL:CKIT:SELECT 1" )
PrintKitStandardInfo 1
PrintKitOlist 1

' -----
'   CALIBRATE PORTS 1 and 2, insertable cal
' -----

wscript.echo
wscript.echo "Calibrating ports 1 and 2"
scpi.execute("SYST:PRES;")
scpi.execute("calc:par:sel CH1_S11_1")
scpi.execute("SENS:CORR:TST:STATE 0")
```

```

scpi.execute("SENS:CORR:COLL:METHod SPARSOLT")
scpi.execute("SENS:CORR:SFOR 1")
MeasureFemaleStandards 1
scpi.execute("SENS:CORR:SFOR 0")
MeasureMaleStandards 2
MeasureTransmissionStandards 1,2
scpi.execute("SENS:CORR:COLL:SAVE")

' -----
'   CALIBRATE PORTS 2 and 3, insertable cal
' -----

wscript.echo
wscript.echo "Calibrating ports 2 and 3"
scpi.execute("SYST:PRES;")
scpi.execute("calc:par:sel CH1_S11_1")
scpi.execute("calc:par:mod S23")
scpi.execute("SENS:CORR:TST:STATE 0")
scpi.execute("SENS:CORR:COLL:METHod SPARSOLT")
scpi.execute("SENS:CORR:SFOR 1")
MeasureMaleStandards 2
scpi.execute("SENS:CORR:SFOR 0")
MeasureFemaleStandards 3
MeasureTransmissionStandards 2,3
scpi.execute("SENS:CORR:COLL:SAVE")

' -----
'   CALIBRATE PORTS 3 and 4, non-insertable cal
' -----

wscript.echo
wscript.echo "Calibrating ports 3 and 4"
scpi.execute("SYST:PRES;")
scpi.execute("calc:par:sel CH1_S11_1")
scpi.execute("calc:par:mod S43")
scpi.execute("SENS:CORR:COLL:METHod SPARSOLT")
scpi.execute("SENS:CORR:SFOR 1")
MeasureFemaleStandards 3
scpi.execute("SENS:CORR:SFOR 0")
MeasureFemaleStandards 4
MeasureAdapter 3, 4
scpi.execute("SENS:CORR:COLL:SAVE")
end sub

sub MeasureMaleStandards ( portNumber )
dim portstr
portstr = formatnumber(portNumber,0)
Promptconnect1 1, 1, portNumber
scpi.execute("SENS:CORR:COLL:ACQ STAN1;*OPC?")

Promptconnect1 2, 1, portNumber
scpi.execute("SENS:CORR:COLL:ACQ STAN2;*OPC?")
Promptconnect1 3, 3, portNumber
scpi.execute("SENS:CORR:COLL:ACQ STAN3,SST3;*OPC?")

```

```

end sub

sub MeasureFemaleStandards (portNumber)
dim portstr
portstr = formatnumber(portNumber,0)
Promptconnect1 1, 2, portNumber
scpi.execute("SENS:CORR:COLL:ACQ STAN1,SST2;*OPC?")
Promptconnect1 2, 2, portNumber
scpi.execute("SENS:CORR:COLL:ACQ STAN2,SST2;*OPC?")
Promptconnect1 3, 6, portNumber
scpi.execute("SENS:CORR:COLL:ACQ STAN3,SST6;*OPC?")
end sub

sub MeasureTransmissionStandards( port1, port2)
dim p1str
dim p2str
p1str = formatnumber( port1, 0)
p2str = formatnumber( port2, 0)

Promptconnect2 4, 1, port1, port2
scpi.execute("SENS:CORR:COLL:ACQ STAN4;*OPC?")
end sub

sub MeasureAdapter( port1, port2)
dim p1str
dim p2str
p1str = formatnumber( port1, 0)
p2str = formatnumber( port2, 0)

Promptconnect2 4, 2, port1, port2
scpi.execute("SENS:CORR:COLL:ACQ STAN4,SST2;*OPC?")
end sub

' return the nth item in the comma separated list
Function GetItemNumber( list, n)
dim strVector
strVector = split(list,",",-1,1)
GetItemNumber = strVector(n-1)
end function

' remove the trailing newline from str
function chop( str )
dim tmp
tmp = str
' remove the appended newline
dim pos
pos = InStrRev(tmp,vblf)
if (pos >0) then
tmp = mid(tmp,1,pos-1)
end if
chop = tmp
end function

```

```

'return the label for the nth standard assigned to the class described by
class_index.
' if class_index = 1, class is S11A (STAN1)
' if class_index = 2, class is S11B (STAN2), etc
function GetStandardLabel( class_index, nth)
dim olist
dim stdnum
dim resp
olist = scpi.execute("SENS:CORR:COLL:CKIT:OLIST" + formatnumber(class_index,0)+"?")
stdnum = GetItemNumber( olist, nth)
scpi.execute("SENS:CORR:COLL:CKIT:STAN " + formatnumber(stdnum,0))
resp = scpi.execute("SENS:CORR:COLL:CKIT:STAN:Label?")
GetStandardLabel = chop(resp)
end function

sub PromptConnect1( class_index, nth, port)
wscript.echo "CONNECT " + GetStandardLabel( class_index, nth) + " to port " +
formatnumber(port,0)
end sub

sub PromptConnect2( class_index, nth, port1, port2)
wscript.echo "CONNECT " + GetStandardLabel( class_index, nth) + " between ports " +
formatnumber(port1,0) + " and " + formatnumber(port2,0)
end sub

' Print the order of standards per class for this kit
sub PrintKitOlist( kit )
dim i
dim cmd
dim resp
wscript.echo
dim olistcmd
olistcmd = "SENS:CORR:COLL:CKIT:OLIST"
' list the sub standards for each of the following classes
' S11A, S11B, S11C, FWD TRANS, FWD ISOL, S22A, S22B, S22C, REV TRANS, REV ISOL
for i = 1 to 8
cmd = olistcmd + formatNumber(i,0) + "?"
resp = scpi.execute(cmd)
wscript.echo cmd + "=" + chop(resp)
next
end sub

sub PrintKitStandardInfo( kit )
wscript.echo scpi.execute("SENS:CORR:COLL:CKIT:NAME?")
dim i
for i = 1 to 30
dim slabel
dim snum
snum = formatNumber(i,0)
scpi.execute("SENS:CORR:COLL:CKIT:STAN " + snum)
slabel=scpi.execute("SENS:CORR:COLL:CKIT:STAN:Label?")
wscript.echo "Standard #" + snum + " = " + chop(slabel)

```

```
next
end sub
```

The output from this program is as follows:

Microsoft (R) Windows Script Host Version 5.6

Copyright (C) Microsoft Corporation 1996-2001. All rights reserved.

"85052B 3.5 mm with sliding load"

Standard #1 = "3.5 mm male short"

Standard #2 = "3.5 mm male open"

Standard #3 = "3.5 mm male broadband load"

Standard #4 = "Insertable thru standard"

Standard #5 = "3.5 mm male sliding load"

Standard #6 = "3.5 mm male lowband load"

Standard #7 = "3.5 mm female short"

Standard #8 = "female to female characterized thru adapter"

Standard #9 = "0-2 Load"

Standard #10 = "Open"

Standard #11 = "Non-insertable thru"

Standard #12 = "3.5 mm female lowband load"

Standard #13 = "3.5 mm female sliding load"

Standard #14 = "3.5 mm female broadband load"

Standard #15 = "3.5 mm female open"

Standard #16 = "Open"

Standard #17 = "Open"

Standard #18 = "Open"

Standard #19 = "Open"

Standard #20 = "Open"

Standard #21 = "Open"

Standard #22 = "Open"

Standard #23 = "Open"

Standard #24 = "Open"

Standard #25 = "Open"

Standard #26 = "Open"

Standard #27 = "Open"

Standard #28 = "Open"

Standard #29 = "Open"

Standard #30 = "Open"

SENS:CORR:COLL:CKIT:OLIST1?= +2,+15,+0,+0,+0,+0,+0

SENS:CORR:COLL:CKIT:OLIST2?= +1,+7,+0,+0,+0,+0,+0

SENS:CORR:COLL:CKIT:OLIST3?= +6,+5,+3,+12,+13,+14,+0

SENS:CORR:COLL:CKIT:OLIST4?= +4,+8,+0,+0,+0,+0,+0

SENS:CORR:COLL:CKIT:OLIST5?= +2,+15,+0,+0,+0,+0,+0

SENS:CORR:COLL:CKIT:OLIST6?= +1,+7,+0,+0,+0,+0,+0

SENS:CORR:COLL:CKIT:OLIST7?= +6,+5,+3,+12,+13,+14,+0

SENS:CORR:COLL:CKIT:OLIST8?= +4,+8,+0,+0,+0,+0,+0

Calibrating ports 1 and 2

CONNECT "3.5 mm female open" to port 1

CONNECT "3.5 mm female short" to port 1

CONNECT "3.5 mm female broadband load" to port 1

CONNECT "3.5 mm male open" to port 2

CONNECT "3.5 mm male short" to port 2

CONNECT "3.5 mm male broadband load" to port 2

CONNECT "Insertable thru standard" between ports 1 and 2

Calibrating ports 2 and 3

CONNECT "3.5 mm male open" to port 2

CONNECT "3.5 mm male short" to port 2

CONNECT "3.5 mm male broadband load" to port 2

CONNECT "3.5 mm female open" to port 3

CONNECT "3.5 mm female short" to port 3

CONNECT "3.5 mm female broadband load" to port 3

CONNECT "Insertable thru standard" between ports 2 and 3

Calibrating ports 3 and 4

CONNECT "3.5 mm female open" to port 3

CONNECT "3.5 mm female short" to port 3

CONNECT "3.5 mm female broadband load" to port 3

CONNECT "3.5 mm female open" to port 4

CONNECT "3.5 mm female short" to port 4

CONNECT "3.5 mm female broadband load" to port 4

CONNECT "female to female characterized thru adapter" between ports 3 and 4

Perform a Guided 1-Port Cal using SCPI

This example performs simultaneous measurement of multiple cal standards and channels, then feeds all data to SCPI commands to compute and activate 1-port calibrations for the channels.

The SCPI commands in this example are sent over a COM interface using the SCPIStringParser object. You do NOT need a GPIB connection to run this example.

This VBScript (*.vbs) program can be run as a macro in the VNA. To do this, copy the following code into a text editor file, such as Notepad, and save it on the VNA hard drive as *.vbs.

[Learn how to setup and run the macro.](#)

[See Guided Cal SCPI commands](#)

See Other SCPI Example Programs

```
Dim app

Dim scpi

' Create / Get the PNA application.

Set app = CreateObject("AgilentPNA835x.Application")

' Get the ScpiStringParser COM object

Set scpi = app.ScpiStringParser

' Ensure data format is ASCII for this example

scpi.Parse "form:data asc,0"

Dim response

' Begging with a FPRESET to start out with no measurements

response = scpi.Parse("sys:fpreset;*opc?")

' For both channels of this example, creating an S11 measurement and an "a1,1"
measurement

scpi.Parse "calc1:par:ext 'CH1_S11_1','S11'"

scpi.Parse "calc1:par:ext 'CH1_a1_1','a1_1'"

scpi.Parse "calc2:par:ext 'CH2_S11_1','S11'"

scpi.Parse "calc2:par:ext 'CH2_a1_1','a1_1'"
```

```

' Feeding all four of the newly created measurements to traces in Window 1

scpi.Parse "disp:wind1:stat on"

scpi.Parse "disp:wind1:trac1:feed 'CH1_S11_1'"
scpi.Parse "disp:wind1:trac2:feed 'CH1_a1_1'"
scpi.Parse "disp:wind1:trac3:feed 'CH2_S11_1'"
scpi.Parse "disp:wind1:trac4:feed 'CH2_a1_1'"

' Setting up for 1-port cal acquisitions on both channels 1 and 2,
' using APC 3.5 female DUT connector and 85033D/E cal kit for this example.

scpi.Parse "sens1:corr:coll:guid:conn:port1 'APC 3.5 female'"
scpi.Parse "sens2:corr:coll:guid:conn:port1 'APC 3.5 female'"
scpi.Parse "sens1:corr:coll:guid:ckit:port1 '85033D/E'"
scpi.Parse "sens2:corr:coll:guid:ckit:port1 '85033D/E'"
scpi.Parse "sens1:corr:coll:guid:init"
scpi.Parse "sens2:corr:coll:guid:init"

' This commented-out command shows how you can query for a given connection step
of a cal,

' which measurement parameters the calibration needs to measure for that step of
the cal.

' But for this example we know for each step the 1-port cals want to measure S11
and

' "a1,1" a.k.a "a1_1".

'response = scpi.Execute("sens:corr:coll:guid:data:cat? STAN1")

'MsgBox response

' Set up for channel coupling and measurement parameter coupling

scpi.Parse "syst:chan:coup:stat on"

scpi.Parse "syst:chan:coup:par on"

' Prompt for the standards to be connected, trigger all the channel-coupled
measurements,

' and feed the measured data into the cal connection steps.

MsgBox "Connect all the Opens"

```

```

MeasureStandards 1
MsgBox "Connect all the Shorts"
MeasureStandards 2
MsgBox "Connect all the Loads"
MeasureStandards 3
' Conclude and activate the calibrations for both channels
response = scpi.Parse("sens1:corr:coll:guid:save;*opc?")
response = scpi.Parse("sens2:corr:coll:guid:save;*opc?")
' Finished!
MsgBox "Done"
'Subroutine that acquires the measurements and feeds the data into the cal steps
Sub MeasureStandards (stepNum)
    response = scpi.Parse("sens1:swe:mode sing;*opc?")
    response = scpi.Parse("calc1:par:mnum:sel 1;*opc?")
    response = scpi.Parse("calc1:data? rdata")
    scpi.Parse "sens1:corr:coll:guid:data STAN" & CStr(stepNum) & ", 'S11',0," &
response
    response = scpi.Parse("calc1:par:mnum:sel 2;*opc?")
    response = scpi.Parse("calc1:data? rdata")
    scpi.Parse "sens1:corr:coll:guid:data STAN" & CStr(stepNum) & ", 'a1_1',0," &
response
    response = scpi.Parse("calc2:par:mnum:sel 3;*opc?")
    response = scpi.Parse("calc2:data? rdata")
    scpi.Parse "sens2:corr:coll:guid:data STAN" & CStr(stepNum) & ", 'S11',0," &
response
    response = scpi.Parse("calc2:par:mnum:sel 4;*opc?")
    response = scpi.Parse("calc2:data? rdata")
    scpi.Parse "sens2:corr:coll:guid:data STAN" & CStr(stepNum) & ", 'a1_1',0," &
response
End Sub

```

Perform a Guided 1-Port Cal on Port 2

This VBScript program does the following:

1. Clear measurements from the VNA
2. Create a new S22 measurement
3. Set an instrument state
4. Select the connector types
5. Select a cal kit
6. Initiate a Guided calibration
7. Display a prompt to connect each standard
8. Save the calibration to a newly created cal set

Note: This example illustrates an important step when calibrating a reflection measurement in the reverse direction. You **MUST** create a reverse (S22) measurement and have it be the active (selected) measurement on the channel that is being calibrated. This is not necessary for any calibrating any other measurement parameter.

The SCPI commands in this example are sent over a COM interface using the SCPIStringParser object. You do NOT need a GPIB connection to run this example.

This VBScript (*.vbs) program can be run as a macro in the VNA. To do this, copy the following code into a text editor file such as Notepad and save it on the VNA hard drive as Guided.vbs. [Learn how to setup and run the macro.](#)

```
Dim App
Set App = CreateObject("AgilentPNA835x.Application")
App.Preset

Dim step
Dim Parser
Dim prompt
Dim txtDat
Dim Chan

Rem Clear old measurements
App.Reset

Rem Create a new Measurement
```

```

Set Parser = App.SCPIStringParser
Parser.Parse "DISPlay:WINDow1:STATE ON"
Parser.Parse "CALCulate:PARAMeter:DEFine:EXT 'MyMeas',S22"
Parser.Parse "DISPlay:WINDow1:TRACe1:FEED 'MyMeas'"

Rem Initialize state
Set Chan = App.ActiveChannel
Chan.StartFrequency = 200e6
Chan.StopFrequency = 1.5e9
Chan.IFBandwidth = 1000
step = 3

Rem Begin a guided calibration
Parser.Parse "SENS:CORR:COLL:GUID:CONN:PORT1 'Not used'"
Parser.Parse "SENS:CORR:COLL:GUID:CONN:PORT2 'Type N (50) male'"
Parser.Parse "SENS:CORR:COLL:GUID:CKIT:PORT1 ''"
Parser.Parse "SENS:CORR:COLL:GUID:CKIT:PORT2 '85054D'"
Parser.Parse "SENS:CORR:COLL:GUID:INIT"

Rem Query the number of steps
txtDat = Parser.Parse("SENS:CORR:COLL:GUID:STEP?")

Rem Display the number of steps
MsgBox("Number of steps is " + txtDat)

Rem Set the loop counter limit
step = txtDat

Rem Measure the standards
For i = 1 To step
If i= 1 Then
prompt = Parser.Parse("sens:corr:coll:guid:desc? 1")
MsgBox(prompt)
Parser.Parse ("sens:corr:coll:guid:acq STAN1")
ElseIf i = 2 then
prompt = Parser.Parse("sens:corr:coll:guid:desc? 2")
MsgBox(prompt)
Parser.Parse ("sens:corr:coll:guid:acq STAN2")
ElseIf i = 3 then
prompt = Parser.Parse("sens:corr:coll:guid:desc? 3")
MsgBox(prompt)
Parser.Parse ("sens:corr:coll:guid:acq STAN3")
End If
Next

Rem All standards have been measured. Save the result
Parser.Parse "SENS:CORR:COLL:GUID:SAVE"
MsgBox("The calibration has been completed")

```

Perform a Guided Calibration using SCPI

This VBScript program performs a Guided Calibration using ECal **or** Mechanical standards. This example includes optional ECal orientation features.

This example has been updated to include:

- Guided Power Cal (Oct 8, 2010)
- The setting of Unknown Thru or Adapter Removal adapter delay. (March 2006).
- The activation of a channel to be calibrated. (Aug. 2006).

The SCPI commands in this example are sent over a COM interface using the SCPIStringParser object. You do NOT need a GPIB connection to run this example.

This VBScript (*.vbs) program can be run as a macro in the VNA. To do this, copy the following code into a text editor file such as Notepad and save it on the VNA hard drive as Guided.vbs. [Learn how to setup and run the macro.](#)

```
' Performing a Guided 2-port cal (Ports 1 and 2)

TwoPortGuidedCal

Sub TwoPortGuidedCal

Dim app

Dim scpi

Dim connList

Dim selectedConn1, selectedConn2

Dim kitList

Dim selectedKit

Dim message

' Create / Get the VNA application.

Set app = CreateObject("AgilentPNA835x.Application")

Set scpi = app.ScpiStringParser

'The following demonstrates that the Active Channel is cal'd
```



```

'Preset the VNA
scpi.Execute "SYST:UPR"

'Create a new measurement on Chan 2

'Now there are two windows, channels and measurements

'This becomes the Active Measurement
scpi.Execute ("DISPlay:WINDow2:STATE ON")

'Define a measurement name, parameter
scpi.Execute ("CALCulate2:PARAmeter:DEFine:EXT 'MyMeas',S21")

'"FEED" the measurement

scpi.Execute ("DISPlay:WINDow2:TRACe1:FEED 'MyMeas'")

'This is the Active Measurement

'Activate the 'Preset' measurement to cal chan 1
scpi.Execute ("CALC1:PAR:SEL 'CH1_S11_1'")

' Query the list of connectors that the VNA system recognizes
connList = scpi.Execute("sens:corr:coll:guid:conn:cat?")

' Format the list with linefeed characters in place of the commas
connList = FormatList(connList)

message = "Enter your DUT connector for Port 1. Choose from this list:"
message = message & Chr(10) & Chr(10) & connList

' Select the connector for Port 1
selectedConn1 = InputBox(message)
If selectedConn1 = "" Then Exit Sub
scpi.Execute "sens:corr:coll:guid:conn:port1 '" & selectedConn1 & "'"

message = "Enter your DUT connector for Port 2. Again, choose from this list:"
message = message & Chr(10) & Chr(10) & connList

' Select the connector for Port 2
selectedConn2 = InputBox(message)
If selectedConn2 = "" Then Exit Sub

```

```

scpi.Execute "sens:corr:coll:guid:conn:port2 '" & selectedConn2 & "'"
' Note: If your VNA has more than 2 ports, then uncomment
' one or both of these next two lines.
'scpi.Execute "sens:corr:coll:guid:conn:port3 ""Not used"" "
'scpi.Execute "sens:corr:coll:guid:conn:port4 ""Not used"" "

' This next block of commented code demonstrates how to specify an adapter
' and it's electrical delay, in situations where you are performing an
' Unknown Thru or Adapter Removal calibration. In most situations, the
' VNA is able to correctly determine an adapter's electrical length
' at the end of the calibration. However, there are scenarios where
' the VNA cannot correctly calculate the length -- such as when the channel
' has a relatively small number of measurement points (for example, 201 or less)
' and the adapter is significantly long (for example, a cable that is several
feet).

' In these cases, the ADAP commands (below) enable you to explicitly specify
' the adapter you are using.

' Send these commands prior to the "sens:corr:coll:guid:init" command.

' Create adapter and return the adapter number

'adapterNum = scpi.Execute("sens:corr:coll:guid:adap:cre? '" & selectedConn1 &
"', '"& selectedConn2 & "'")

' The adapterNum string contains a '+' character.

' Here we convert to integer to remove that.

'adapterNum = CStr( CInt(adapterNum) )

' Specify that this adapter has 10 nanoseconds electrical delay (coaxial).
'scpi.Execute "sens:corr:coll:guid:adap" & adapterNum & ":del 10E-9"

' Text description of adapter

'scpi.Execute "sens:corr:coll:guid:adap" & adapterNum & ":desc 'My adapter'"

```

```

' Select to use this adapter specifically between ports 1 and 2

'scpi.Execute "sens:corr:coll:guid:adap" & adapterNum & ":path 1,2"

' End of adapter block

' Query the list of acceptable cal kits and
' ECal module characterizations for Port 1.

kitList = scpi.Execute("sens:corr:coll:guid:ckit:cat? '" & selectedConn1 & "'")

' Format the list with linefeed
' characters in place of the commas

kitList = FormatList(kitList)

message = "Enter your cal kit or ECal module characterization for Port 1. "
message = message & "Choose from this list:"
message = message & Chr(10) & Chr(10) & kitList

' Select the Cal Kit or ECal module
' characterization to use for Port 1.

selectedKit = InputBox(message)

If selectedKit = "" Then Exit Sub

scpi.Execute "sens:corr:coll:guid:ckit:port1 '" & selectedKit & "'

' Query the list of acceptable cal kits
' and ECal module characterizations for Port 2.

kitList = scpi.Execute("sens:corr:coll:guid:ckit:cat? '" & selectedConn2 & "'")

' Format the list with linefeed characters in place of the commas

kitList = FormatList(kitList)

message = "Enter your cal kit or ECal module characterization for Port 2. "
message = message & "Choose from this list:"
message = message & Chr(10) & Chr(10) & kitList

' Select the Cal Kit or ECal module
' characterization to use for Port 2.

```

```

selectedKit = InputBox(message)

If selectedKit = "" Then Exit Sub

scpi.Execute "sens:corr:coll:guid:ckit:port2 '" & selectedKit & "'"

' This determines whether the cal will be a "Guided Power Cal"
' or just a traditional S-parameter cal.

message = "On which port number shall power be measured?  "

message = message & "For a traditional guided cal without power cal, enter 0"

Dim powerPort

powerPort = CInt( InputBox(message) )

If powerPort > 0 Then

scpi.Execute("sens:corr:coll:guid:psen" & CStr(powerPort) & ":stat on")

Dim retVal

retVal = MsgBox("Is the power sensor's connector type or gender different from
the DUT connector for that port?", vbYesNo)

If retVal = vbYes Then

message = "Enter your power sensor's connector.  Choose from this list:"

message = message & Chr(10) & Chr(10) & connList

' Select the sensor's connector.

selectedConn1 = InputBox(message)

If selectedConn1 = "" Then Exit Sub

scpi.Execute "sens:corr:coll:guid:psen" & CStr(powerPort) & ":conn '" &
selectedConn1 & "'"

' Query the list of acceptable cal kits and ECal module characterizations
' that are applicable for the sensor's connector.

kitList = scpi.Execute("sens:corr:coll:guid:ckit:cat? '" & selectedConn1 & "'")

' Format the list with linefeed
' characters in place of the commas

kitList = FormatList(kitList)

message = "Enter your cal kit or ECal module characterization to use for de-embed

```

```

of the sensor's connector.  "

message = message & "Choose from this list:"

message = message & Chr(10) & Chr(10) & kitList

' Select the Cal Kit or ECal module characterization to use for de-embed of the
sensor's connector.

selectedKit = InputBox(message)

If selectedKit = "" Then Exit Sub

scpi.Execute "sens:corr:coll:guid:psen" & CStr(powerPort) & ":ckit '" &
selectedKit & "'"

Else

scpi.Execute("sens:corr:coll:guid:psen" & CStr(powerPort) & ":conn 'Ignored'")

End If ' End of block that considers the sensor's connector

' Ask for the power level to perform the power cal at
' (if this command is omitted, the default is 0 dBm).

Dim powerLevel

powerLevel = InputBox("Enter the power level for the power cal to be performed
at")

If powerLevel = "" Then Exit Sub

scpi.Execute "sens:corr:coll:guid:psen" & CStr(powerPort) & ":pow:lev " &
powerLevel

Else

scpi.Execute("sens:corr:coll:guid:psen1:stat off")

End If ' End of block that considers if the cal will include power calibration

' This next block of commented code
' shows optional functions when using ECal.
' Send these "sens:corr:pref" commands prior to the
' "sens:corr:coll:guid:init" command.
' Read ECAL information from ECal module #1 on the USB bus
' about the Keysight factory characterization data

```

```

'module1Info = scpi.Execute("sens:corr:coll:ckit:inf? ECAL1,CHAR0")
'MsgBox "Description of ECal Module #1:" & Chr(10) & Chr(10) & module1Info

' The following command enables auto orientation of
' the ECal module (The VNA senses which port of the
' module is connected to which port of the VNA).
'scpi.Execute "sens:corr:pref:ecal:ori ON"

' However, if you are measuring at very low power levels where
' the VNA may fail to sense the module's orientation, then turn auto
' orientation OFF and specify how the module is connected.
' "A1,B2" indicates Port A of the module is connected
' to VNA Port 1 and Port B is connected to VNA Port 2).
'scpi.Execute "sens:corr:pref:ecal:ori OFF"
'scpi.Execute "sens:corr:pref:ecal:pmap ECAL1,'A1,B2'"
' End of optional ECal setup

' Select the thru method of "Default". This instructs the VNA to
' determine which thru standard measurement technique to use
' based upon the selected connectors and
' calibration kit(s) and the VNA model number.
' with new CMET and TMET 'default' is set by not sending the commands
'
' Initiate the calibration and query the number of steps
scpi.Execute "sens:corr:coll:guid:init"
numSteps = scpi.Execute("sens:corr:coll:guid:steps?")
MsgBox "Number of steps is " + CStr(numSteps)

' Measure the standards

For i = 1 To numSteps

```

```

step = "Step " + CStr(i) + " of " + CStr(numSteps)

strPrompt = scpi.Execute("sens:corr:coll:guid:desc? " + CStr(i))

MsgBox strPrompt, vbOKOnly, step

scpi.Execute "sens:corr:coll:guid:acq STAN" + CStr(i)

Next

' Conclude the calibration

scpi.Execute "sens:corr:coll:guid:save"

MsgBox "Cal is done!"

End Sub

Function FormatList(list)

Dim tokens

' Strip the leading and trailing quotation
' marks from the list string

list = Mid(list, 2, Len(list) - 3)

' Tokenize the comma-delimited list string
' into an array of the individual substrings

tokens = Split(list, ",")

' Rebuild the list string, placing linefeed
' characters where the commas were,
' using Trim to remove leading and trailing spaces.

list = ""

For i = 0 To UBound(tokens)

tokens(i) = Trim(tokens(i))

list = list & tokens(i) & Chr(9)

If i < UBound(tokens) Then

i = i + 1

tokens(i) = Trim(tokens(i))

list = list & tokens(i) & Chr(10)

```

```
End If
```

```
Next
```

```
FormatList = list
```

```
End Function
```

Perform Guided ECal using SCPI

This VBScript program performs a Guided ECal Calibration. While this example is good to use as a starting point for Guided ECal, the [Guided comprehensive cal example](#) has some advanced features that are not in this program.

The SCPI commands in this example are sent over a COM interface using the SCPIStringParser object. You do NOT need a GPIB connection to run this example.

This VBScript (*.vbs) program can be run as a macro in the VNA. To do this, copy the following code into a text editor file such as Notepad and save it on the VNA hard drive as Guided.vbs. [Learn how to setup and run the macro.](#)

```
' Performing a 2-port cal (Ports 1 and 2)
Dim app
Dim scpi

' Create / Get the VNA application.
Set app = CreateObject("AgilentPNA835x.Application")
Set scpi = app.ScpiStringParser

' Specify the DUT connectors
' (for each connector of your DUT, one of the ECal module's ports must have
' that same connector, or else you cannot achieve the cal using that module).
scpi.Execute "sens:corr:coll:guid:conn:port1 ""APC 3.5 female"" "
scpi.Execute "sens:corr:coll:guid:conn:port2 ""APC 3.5 male"" "

' Note: If your VNA has more than 2 ports, you would need to uncomment
' one or both of these next two lines, to explicitly specify this is
' just a 2-port cal.
'scpi.Execute "sens:corr:coll:guid:conn:port3 ""Not used"" "
'scpi.Execute "sens:corr:coll:guid:conn:port4 ""Not used"" "
MsgBox "Connectors defined for Ports 1 and 2"

' Specify ECal modules

scpi.Parse "sens:corr:coll:guid:ckit:port1 'N4691-60004 ECal'"
scpi.Parse "sens:corr:coll:guid:ckit:port2 'N4691-60004 ECal'"

' Non-factory characterizations are specified as follows:
'scpi.Parse "sens:corr:coll:guid:ckit:port2 'N4691-60004 User 1 ECal'"

' When two or more ECal modules with the same model number are connected
' also specify the serial number as follows:
'scpi.Parse "sens:corr:coll:guid:ckit:port2 'N4691-60004 ECal 01234'"
```

```
' When Disk Memory ECal user characterizations are used,  
' specify both the User char and the serial number as follows:  
  
scpi.Parse "sens:corr:coll:guid:ckit:port2 'N4691-60004 MyDskChar ECal 01234'"  
  
'  
MsgBox "Cal kits defined for Ports 1 and 2"  
  
' Initiate the calibration and query the number of steps  
scpi.Execute "sens:corr:coll:guid:init"  
numSteps = scpi.Execute("sens:corr:coll:guid:steps?")  
MsgBox "Number of steps is " + CStr(numSteps)  
  
' Measure the standards  
For i = 1 To numSteps  
step = "Step " + CStr(i) + " of " + CStr(numSteps)  
strPrompt = scpi.Execute("sens:corr:coll:guid:desc? " + CStr(i))  
MsgBox strPrompt, vbOKOnly, step  
scpi.Execute "sens:corr:coll:guid:acq STAN" + CStr(i)  
Next  
  
' Conclude the calibration  
scpi.Execute "sens:corr:coll:guid:save"  
MsgBox "Cal is done!"
```

Perform Guided Mechanical Cal using SCPI

This VBScript program performs a Guided Calibration using Mechanical standards. While this example is good to use as a starting point for guided mechanical cal, the [Guided comprehensive cal example](#) has some advanced features that are not in this program.

The SCPI commands in this example are sent over a COM interface using the SCPIStringParser object. You do NOT need a GPIB connection to run this example.

This VBScript (*.vbs) program can be run as a macro in the VNA. To do this, copy the following code into a text editor file such as Notepad and save it on the VNA hard drive as Guided.vbs. [Learn how to setup and run the macro.](#)

' Performing a 2-port cal (Ports 1 and 2)

```
Dim app
Dim scpi

' Create / Get the VNA application.
Set app = CreateObject("AgilentPNA835x.Application")
Set scpi = app.ScpiStringParser

' Specify the DUT connectors
scpi.Execute "sens:corr:coll:guid:conn:port1 ""APC 3.5 female"" "
scpi.Execute "sens:corr:coll:guid:conn:port2 ""APC 3.5 male"" "

' Note: If your VNA has more than 2 ports, you would need to uncomment
' one or both of these next two lines, to explicitly specify this is
' just a 2-port cal.
'scpi.Execute "sens:corr:coll:guid:conn:port3 ""Not used"" "
'scpi.Execute "sens:corr:coll:guid:conn:port4 ""Not used"" "
MsgBox "Connectors defined for Ports 1 and 2"

' Select the Cal Kit for each port being calibrated.
scpi.Execute "sens:corr:coll:guid:ckit:port1 ""85052D"" "
scpi.Execute "sens:corr:coll:guid:ckit:port2 ""85052D"" "
MsgBox "Cal kits defined for Ports 1 and 2"

' Initiate the calibration and query the number of steps
scpi.Execute "sens:corr:coll:guid:init"
numSteps = scpi.Execute("sens:corr:coll:guid:steps?")
MsgBox "Number of steps is " + CStr(numSteps)

' Measure the standards
'The following series of commands shows that standards
'can be measured in any order. These steps acquire
'measurement of standards in reverse order.
'It is easiest to iterate through standards using
```

```
'a For-Next Loop.
For i = numSteps To 1
step = "Step " + CStr(i) + " of " + CStr(numSteps)
strPrompt = scpi.Execute("sens:corr:coll:guid:desc? " + CStr(i))
MsgBox strPrompt, vbOKOnly, step
scpi.Execute "sens:corr:coll:guid:acq STAN" + CStr(i)
Next

' Conclude the calibration
scpi.Execute "sens:corr:coll:guid:save"
MsgBox "Cal is done!"
```

Perform Guided TRL Calibration

This VBScript file performs a 2-Port Guided TRL calibration on **2-port VNA analyzers**. (See an [example of TRL cal on a 4-port VNA.](#)) This program does the following:

- Clear old measurements from the VNA
- Create a new S22 measurement
- Set an instrument state
- Select the connectors and cal kit
- Initiate a Guided calibration
- Display a prompt as each new standard must be connected
- Save the calibration to a newly created cal set.

The SCPI commands in this example are sent over a COM interface using the SCPIStringParser object. You do NOT need a GPIB connection to run this example.

This VBScript (*.vbs) program can be run as a macro in the VNA. To do this, copy the following code into a text editor file such as Notepad and save it on the VNA hard drive as TRL.vbs. [Learn how to setup and run the macro.](#)

```
Dim App
Dim Parser
Dim Chan
Dim txtDat
Dim step
Dim parserTxt
Dim prompt
Set App = CreateObject("AgilentPNA835x.Application")
' Clear old measurements
App.Reset
' Create a new Measurement
```

```

Set Parser = App.SCPIStringParser
Parser.Parse "DISPlay:WINDow1:STATE ON"
Parser.Parse "CALCulate:PARAmeter:DEFine:EXT 'MyMeas',S12"
Parser.Parse "DISPlay:WINDow1:TRACe1:FEED 'MyMeas'"
' Initialize state
Set Chan = App.ActiveChannel
Chan.StartFrequency = 18.0e9
Chan.StopFrequency = 20.0e9
Chan.IFBandwidth = 1000
' Begin a guided calibrations
Parser.Parse "SENS:CORR:COLL:GUID:CONN:PORT1 'APC 3.5 male'"
Parser.Parse "SENS:CORR:COLL:GUID:CONN:PORT2 'APC 3.5 female'"
Parser.Parse "SENS:CORR:COLL:GUID:CKIT:PORT1 '85052C'"
Parser.Parse "SENS:CORR:COLL:GUID:CKIT:PORT2 '85052C'"
' Select TRL cal method.
Parser.Parse "SENS:CORR:COLL:GUID:PATH:CMET 1,2,'TRL'"
txtDat = Parser.Parse("SENS:CORR:COLL:GUID:PATH:CMET? 1,2")
MsgBox("Method " + txtDat)
Parser.Parse "SENS:CORR:COLL:GUID:INIT"
' Query the number of steps
txtDat = Parser.Parse("SENS:CORR:COLL:GUID:STEP?")
' Display the number of steps
MsgBox("Number of steps is " + txtDat)
' Set the loop counter limit
step = CInt(txtDat)
' Measure the standards

```

```
For i = 1 To step
parserTxt = "sens:corr:coll:guid:desc? " + CStr(i)
prompt = Parser.Parse(parserTxt)
MsgBox(prompt)
parserTxt = "sens:corr:coll:guid:acq STAN" + CStr(i)
Parser.Parse (parserTxt)
Next
' All standards have been measured. Save the result
Parser.Parse "SENS:CORR:COLL:GUID:SAVE"
MsgBox("The TRL calibration has been completed")
```

Perform an Unguided 1-Port Cal on Port 2

This VBScript program does the following:

1. Clear measurements from the VNA
2. Create a new S22 measurement
3. Set an instrument state
4. Select a cal kit
5. Initiate an Unguided calibration
6. Display a prompt to connect each standard
7. Save the calibration to a newly created cal set

Note: This example illustrates an important step when calibrating a reflection measurement in the reverse direction. You **MUST** create a reverse (S22) measurement and have it be the active (selected) measurement on the channel that is being calibrated. This is not necessary for any calibrating any other measurement parameter.

The SCPI commands in this example are sent over a COM interface using the SCPIStringParser object. You do NOT need a GPIB connection to run this example.

This VBScript (*.vbs) program can be run as a macro in the VNA. To do this, copy the following code into a text editor file such as Notepad and save it on the VNA hard drive as Unguided.vbs. [Learn how to setup and run the macro.](#)

```
Dim App
Set App = CreateObject("AgilentPNA835x.Application")
App.Preset

Dim Parser
Dim Chan

Rem Clear old measurements
App.Reset

Rem Create a new Measurement
Set Parser = App.SCPIStringParser
Parser.Parse "DISPlay:WINDow1:STATE ON"
Parser.Parse "CALCulate:PARAmeter:DEFine:EXT 'MyMeas',S22"
Parser.Parse "DISPlay:WINDow1:TRACe1:FEED 'MyMeas' "
```



```
Rem Initialize state
Set Chan = App.ActiveChannel
Chan.StartFrequency = 200e6
Chan.StopFrequency = 1.5e9
Chan.IFBandwidth = 1000

Rem Begin an unguided calibration
Rem Set the calibration method
Parser.Parse "SENSe:CORRection:COLLect:METhod REFL3"

Rem Turn off continuous sweep
Parser.Parse "INITiate:CONTinuous OFF"

Rem Select a cal kit
Parser.Parse "SENSe:CORRection:COLLect:CKIT:SElect 1"

Rem Measure the standards
MsgBox("Connect OPEN to port 2. Then press OK")
Parser.Parse ("sens:corr:coll:acq STAN1")

MsgBox("Connect SHORT to port 2. Then press OK")
Parser.Parse ("sens:corr:coll:acq STAN2")

MsgBox("Connect LOAD to port 2. Then press OK")
Parser.Parse ("sens:corr:coll:acq STAN3")

Rem All standards have been measured. Save the result
Parser.Parse "SENS:CORR:COLL:SAVE"

Rem Turn ON continuous sweep
Parser.Parse "INITiate:CONTinuous ON"
MsgBox("The calibration has been completed")
```

Perform an Unguided 2-Port Mechanical Cal

This VBScript program performs an Unguided, Full 2-Port, calibration using ONE set of mechanical calibration standards.

The SCPI commands in this example are sent over a COM interface using the SCPIStringParser object. You do NOT need a GPIB connection to run this example.

This VBScript (*.vbs) program can be run as a macro in the VNA. To do this, copy the following code into a text editor file such as Notepad and save it on the VNA hard drive as Unguided.vbs. [Learn how to setup and run the macro.](#)

```
Set App = CreateObject("AgilentPNA835x.Application")
Set Scpi = App.SCPIStringParser

'Initialize state
Scpi.Execute ("SYSTem:PRESet")

'Select the Preset measurement
Scpi.Execute ("CALCulate:PARAMeter:SElect 'CH1_S11_1'")

'Set the calibration method
Scpi.Execute ("SENSe:CORRection:COLLect:METHOD SPARSOLT")

'Select a cal kit
Scpi.Execute ("SENSe:CORRection:COLLect:CKIT:SElect 1")

'Set one set of standards
Scpi.Execute ("SENSe:CORRection:TStandards OFF")

'Set acquisition to FORWARD
Scpi.Execute ("SENSe:CORRection:SFORward ON")

'Measure the standards in forward direction
MsgBox "Connect OPEN to Port 1; then press OK"
Scpi.Execute ("SENSe:CORRection:COLLect:ACQuire stan1")

MsgBox "Connect SHORT to Port 1; then press OK"
Scpi.Execute ("SENSe:CORRection:COLLect:ACQuire stan2")

MsgBox "Connect LOAD to Port 1; then press OK"
Scpi.Execute ("SENSe:CORRection:COLLect:ACQuire stan3")

'Set acquisition to REVERSE
Scpi.Execute ("SENSe:CORRection:SFORward OFF")

'Measure the standards in reverse direction
MsgBox "Connect OPEN to Port 2; then press OK"
Scpi.Execute ("SENSe:CORRection:COLLect:ACQuire stan1")
```

```
MsgBox "Connect SHORT to Port 2; then press OK"
Scpi.Execute ("SENSe:CORRection:COLLect:ACQuire stan2")

MsgBox "Connect LOAD to Port 2; then press OK"
Scpi.Execute ("SENSe:CORRection:COLLect:ACQuire stan3")

'Measure the thru standard
MsgBox "Connect THRU between Ports 1 and 2; then press OK"
Scpi.Execute ("SENSe:CORRection:COLLect:ACQuire stan4")

'OPTIONAL Measure Isolation
MsgBox "Connect LOADS to Port 1 AND Port 2; then press OK"
Scpi.Execute ("SENSe:CORRection:COLLect:ACQuire stan5")

'All standards have been measured. Save the result
Scpi.Execute ("SENS:CORR:COLL:SAVE")
MsgBox "The calibration has been completed"
```

Perform an Unguided ECal

This VBScript program performs an Unguided Full 2-Port ECal.

The SCPI commands in this example are sent over a COM interface using the SCPIStringParser object. You do NOT need a GPIB connection to run this example.

This VBScript (*.vbs) program can be run as a macro in the VNA. To do this, copy the following code into a text editor file such as Notepad and save it on the VNA hard drive as Unguided.vbs. [Learn how to setup and run the macro.](#)

[See Sense:Correction commands.](#)

[See other SCPI Examples](#)

```
Set pna = CreateObject("AgilentPNA835x.Application")
Set scpi = pna.ScpIStringParser
' Preset the analyzer
scpi.Execute "SYSTem:PRESet"

' Start frequency of 10 MHz
scpi.Execute "SENSe:FREQuency:STARt 10E6"

' Stop frequency of 9 GHz
scpi.Execute "SENSe:FREQuency:STOP 9E9"

' Select the preset S11 measurement
scpi.Execute "CALCulate:PARAmeter:SElect 'CH1_S11_1'"
' Read the information about the Keysight factory
' characterization data of ECal module #1 on the USB bus
module1Info = scpi.Execute("SENSe:CORRection:COLLect:CKIT:INFormation? ECAL1,CHAR0")

' Prompt for the ECal module
MsgBox "Description of ECal Module #1:" & Chr(10) & Chr(10) & module1Info & _Chr(10)
& Chr(10) & "Make port connections to the ECal module, then press enter"
' ECal full 1 port and 2 port
' Choose a Calibration Type (comment out one of these)
scpi.Execute "SENSe:CORRection:COLLect:METhod ref13"
scpi.Execute "SENSe:CORRection:COLLect:METhod SPARSOLT"
' Specify to have the VNA automatically determine which port of the
' ECal module is connected to which port of the VNA.
scpi.Execute "SENSe:CORRection:PREFerence:ECAL:ORIENTATION ON"
' Alternatively, if you are measuring at very low power levels where
' the VNA fails to sense the module's orientation, you may need to turn
' off the auto orientation and specify how the module is connected (as in
' these next two commented lines of code -- "A1,B2" would indicate Port A
' of the module is connected to Port 1 and Port B is connected to Port 2).
```

```

'scpi.Execute "SENSe:CORRection:PREFErrence:ECAL:ORIEntation OFF"
'scpi.Execute "SENSe:CORRection:PREFErrence:ECAL:PMAP ECAL1,'A1,B2'"
' Acquire and store the calibration terms. *OPC? causes a "+1" to be
' returned when finished. CHAR0 indicates to use the Keysight factory
' characterized data within the ECal module (as opposed to a user characterization).
x = scpi.Execute("SENSe:CORRection:COLLect:ACQuire ECAL1,CHAR0;*OPC?")
' Note: if you have set up a slow sweep speed (for example, if
' you're using a narrow IF bandwidth), and while this calibration is
' being acquired you wish to have your program perform other operations
' (like checking for the click event of a Cancel button) and you're
' NOT using the COM ScpiStringParser, you can use the optional
' ASYNchronous argument with the ACQuire command as shown here below
' instead of sending that command in the way shown above. The SCPI
' parser then will return immediately while the cal acquisition
' proceeds (i.e., the parser will NOT block-and-wait for the
' cal to finish, so you can send additional commands in the meantime).
' So you can do "*ESR?" or "*STB?" queries to monitor the status register
' bytes to see when the OPC bit gets set, which indicates the cal has
' finished. That type of OPC detection works for all of the VNA's SCPI
' parsers except the COM ScpiStringParser.
' An alternative to querying the status register, is to setup an SRQ handler
' if your IO Libraries supports that.
' When an SRQ event occurs, a call back will automatically
' "SENSe:CORRection:COLLect:ACQuire ECAL1,CHAR0,ASYNchronous;*OPC"
MsgBox "Done with calibration."

```

Perform Unknown Thru or TRL Cal

The following program performs either a 2-port SOLT Unknown Thru Cal or a 2-port TRL Cal. The 85052C Cal Kit used in this program contains both types of standards. This program can be run on 2-port or 4-port VNAs. When run on select PNA-L models, a Delta Match Cal is required.

- See Delta Match Cal example program
- [See the Guided Cal commands](#)

This VBScript (*.vbs) program can be run as a macro in the VNA. To do this, copy the following code into a text editor file such as Notepad and save it on the VNA hard drive as Unknown.vbs. [Learn how to setup and run the macro.](#)

```
Sub PerformUnknownThruOrTRLCal ()

Set pna = CreateObject("AgilentPNA835x.Application")

Set scpi = pna.ScpiStringParser

' Specify connectors for Ports 1 and 2

scpi.Parse "SENS:CORR:COLL:GUID:CONN:PORT1 'APC 3.5 female'"

scpi.Parse "SENS:CORR:COLL:GUID:CONN:PORT2 'APC 3.5 male'"

'If your VNA has 3 or 4 ports, uncomment one or both of
'these next two lines, to explicitly specify this is a 2-port cal.

'scpi.Parse "SENS:CORR:COLL:GUID:CONN:PORT3 'Not used'"

'scpi.Parse "SENS:CORR:COLL:GUID:CONN:PORT4 'Not used'"

' Specify cal kit for Ports 1 and 2

scpi.Parse "SENS:CORR:COLL:GUID:CKIT:PORT1 '85052C'"

scpi.Parse "SENS:CORR:COLL:GUID:CKIT:PORT2 '85052C'"

' Since the 85052C cal kit contains SOLT standards and also TRL
' standards, these next two lines set cal and thru method.

' Always send the init command before and after these two commands

scpi.Parse "SENS:CORR:COLL:GUID:INIT"

scpi.Parse "SENS:CORR:COLL:GUID:PATH:CMETHOD 1,2,"SOLT"
```

```

scpi.Parse "SENS:CORR:COLL:GUID:PATH:TMETHOD 1,2,"Undefined Thru"

' To set up the cal as TRL, comment the previous 'CMET' line and uncomment
' this next line. The TMETHOD is set by default

scpi.Parse "SENS:CORR:COLL:GUID:PATH:CMETHOD 1,2,"TRL"

' Initiate the calibration

scpi.Parse "SENS:CORR:COLL:GUID:INIT"

' Query the list of ports that need delta match

retStr = scpi.Parse("SENS:CORR:COLL:GUID:DMAT:APPL:PORT?")

portList = Split(retStr, ",")

' If portList contains just one element and it's value is 0, then that indicates
' none of the ports being calibrated require delta match data.

' Note: if each testport on the VNA has it's own reference receiver (R channel),
' then delta match is never needed, so portList will always be just 0.

lowerBound = LBound(portList)
If (UBound(portList) <> lowerBound) Or (CInt( portList(lowerBound) ) <> 0) Then

' Delta match data is required for at least one port.

' For this example, we assume a Global Delta Match Cal has previously been
' performed so the Global Delta Match CalSet exists.

' The Global Delta Match CalSet is used when the APPL command is invoked
' without a specific calset ID (GUID).

scpi.Parse "SENS:CORR:COLL:GUID:DMAT:APPL"

End If

' Query the number of calibration steps

retStr = scpi.Parse("SENS:CORR:COLL:GUID:STEP?")

numSteps = CInt(retStr)

' Measure the cal standards

For i = 1 To numSteps

prompt = scpi.Parse("SENS:CORR:COLL:GUID:DESC? " & CStr(i))

```

```
retVal = MsgBox(prompt, vbOKCancel)

If retVal = vbCancel Then Exit Sub

retStr = scpi.Parse("SENS:CORR:COLL:GUID:ACQ STAN" & CStr(i) & ";*OPC?")

Next

' Compute the error coefficients and save the cal to CalSet, and turn it on

scpi.Parse "SENS:CORR:COLL:GUID:SAVE"

MsgBox "Cal is done!"

End Sub
```

Perform Multi DUT Parallel Measurement (M9485A/M980xA/P50xxA)

The following example show the multi DUT measurement sample code. See [Multi DUT parallel measurement](#).

Correction for multi DUT

To apply the channel independent correction, need to disable the parallel measurement temporary during the process. But the channel coupling still can be enabled.

Note that you can't apply multiple calsets independently, unless the parallel measurement is off.

Example 1: Measure 1-port DUT x2

Setup Configuration

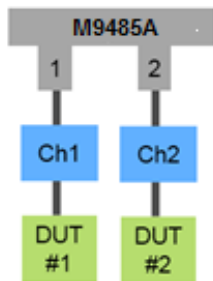

```
' Setup channels as Ch1-S11 and Ch2-S22.
SYST:PRES
CALC2:PAR:EXT "tr2","S22"
DISP:WIND1:TRAC2:FEED "tr2"
' Set channel coupling. In this case, group {0} means global coupling.
SYST:CHAN:COUP:GROUp 0
SYST:CHAN:COUP:STATe 1
' Set frequency and points. The changes are copied to Channel2 automatically.
SENS1:FREQ:START 1e6;STOP 1e8;
SENS1:SWE:POIN 1001
' Turn on parallel measurement. Then the sweep and measurement of Ch1 and 2 runs
at the same time.
SYST:CHAN:COUP:PARAllel:ENABle 1
```

```

' Check the state.
SYST:CHAN:COUP:PARallel:STATe? 1
' 1 will be returned
SYST:CHAN:COUP:PARallel:STATe? 2
' 1 will be returned
SYST:CHAN:COUP:GRoup?
' 0 will be returned

' Turn off the channel couple before calibration in order to apply the channel
independent correction.
:SYST:CHAN:COUP OFF

' calibrate the channel 1.
' apply the calset to channel 1.
' calibrate the channel 2.
' apply the calset to channel 2.

' Then restore the state. The channels start the parallel measurement with the
independent correction.
:SYST:CHAN:COUP ON

```

Example 2: Measure 1-port DUT x2 with 2 groups

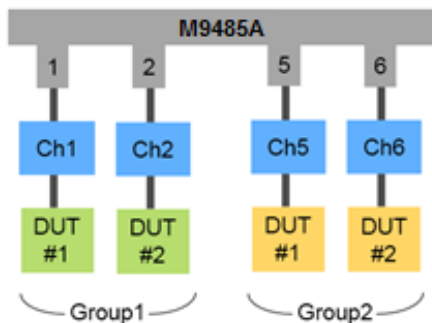

```

' Setup channels Ch1-S11 and Ch2-S22 for Group1.
SYST:PRES
CALC2:PAR:EXT "tr2","S22"

```

```

DISP:WIND1:TRAC2:FEED "tr2"

' Setup channels Ch5-S55 and Ch6-S66 for Group2.

DISP:WIND2:STAT ON

CALC5:PAR:EXT "tr5","S55"

DISP:WIND2:TRAC1:FEED "tr5"

CALC6:PAR:EXT "tr6","S66"

DISP:WIND2:TRAC2:FEED "tr6"

' Set channel coupling. Group1 has Ch1-2, Group2 has Ch5-6.

SYST:CHAN:COUP:GROup 2,1,2,5,6

SYST:CHAN:COUP:STATe 1

' Set independent sweep settings for each groups.

SENS1:FREQ:START 1e6;STOP 1e8;

SENS5:FREQ:START 5e9;STOP 6e9;

' Turn off the channel couple before calibration in order to apply the channel
independent correction.

:SYST:CHAN:COUP OFF

' calibrate the channel 1.
' apply the calset to channel 1.
' calibrate the channel 2.
' apply the calset to channel 2.

' calibrate the channel 5.
' apply the calset to channel 5.

' calibrate the channel 6.
' apply the calset to channel 6.

' Then restore the state. The channels start the parallel measurement with the
independent correction.
:SYST:CHAN:COUP ON

```

Example 3: Measure 2-port DUT x2

Setup Configuration

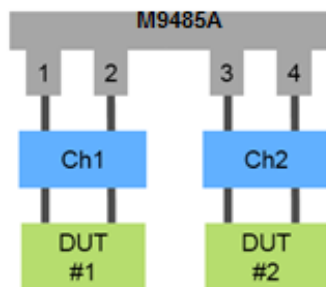

```
' Setup channels Ch1-S11&S12, Ch2-S33&S34
```

```
SYST:PRES
```

```
CALC1:PAR:EXT "tr2","S12"
```

```
DISP:WIND1:TRAC2:FEED "tr2"
```

```
CALC2:PAR:EXT "tr3","S33"
```

```
CALC2:PAR:EXT "tr4","S34"
```

```
DISP:WIND2:STAT ON
```

```
DISP:WIND2:TRAC1:FEED "tr3"
```

```
DISP:WIND2:TRAC2:FEED "tr4"
```

```
' Set channel coupling
```

```
SYST:CHAN:COUP:GROUp 0
```

```
SYST:CHAN:COUP:STATe 1
```

```
' Turn on parallel measurement. First, port1 and 3 become the source. Next port 2 and 4.
```

```
SYST:CHAN:COUP:PARAllel:ENABle 1
```

```
' Turn off the channel couple before calibration in order to apply the channel independent correction.
```

```
:SYST:CHAN:COUP OFF
```

```
' calibrate the channel 1.
```

```
' apply the calset to channel 1.
```

```
' calibrate the channel 2.
```

```
' apply the calset to channel 2.
```

```
' Then restore the state. The channels start the parallel measurement with the
independent correction.
:SYST:CHAN:COUP ON
```

Last modified:

20-May-2019 New topic

Power Meter Uncertainty

This VBScript program is an example of setting up power uncertainty on a power meter.

The SCPI commands in this example are sent over a COM interface using the SCPIStringParser object. You do NOT need a GPIB connection to run this example.

This VBScript (*.vbs) program can be run as a macro in the VNA. To do this, copy the following code into a text editor file such as Notepad and save it on the VNA hard drive as Guided.vbs. [Learn how to setup and run the macro.](#)

```
'
' Keysight Technologies 2018
'
' Uncertainty on power meter example with SCPI
'
' This script executes and prints the results of all the
' commands related to the uncertainty on power meter
'
' ..
' Create the Application and parser objects
option explicit
dim app, scpi
set app = CreateObject("AgilentPNA835x.Application")
set scpi = app.ScpiStringParser
' ..
' query for the ID to verify the communication is established
wscript.echo scpi.execute("*IDN?")
'
' In the following 'Device2' is name of the used external device
'
' .. QUERY COMMANDS ..
```

```

' Query for the available power meter models
'
dim catalog
catalog=scpi.Execute ("SYST:CONF:EDEV:PMAR:UNC:CAT? 'Device2' ")
wscript.echo catalog
' the return is a csv value
'
' Query for the file path. If the model is NOT Custom Model this function will
return
' "Undefined"
'
wscript.echo scpi.Execute ("SYST:CONF:EDEV:PMAR:UNC:FILE? 'Device2' ")
'
' Query for the pwr mtr model used.
wscript.echo scpi.Execute ("SYST:CONF:EDEV:PMAR:UNC:MOD? 'Device2' ")
'
' Query for the uncertainty of the pwr meter at 0.GHz and with 10dBm power level
wscript.echo scpi.Execute ("SYST:CONF:EDEV:PMAR:UNC:READ? 'Device2',0.1GHz,10.0
")
'
' Query for the optimum power level (minimum uncertainty) for for the selected
' power meter
wscript.echo scpi.Execute ("SYST:CONF:EDEV:PMAR:UNC:PLEV? 'Device2' ")
'
' ***** SETTING COMMANDS *****
'
' Setting a specific model:
scpi.Execute ("SYST:CONF:EDEV:PMAR:UNC:MOD 'Device2','N8482A' ")
'

```

```
' Setting a custom file
```

```
scpi.Execute ("SYST:CONF:EDEV:PMAR:UNC:FILE  
'Device2', 'C:\Users\Public\Documents\Network Analyzer\UncSensorExample.dat' ")
```

```
'
```

```
'
```

Setup Markers using SCPI

This VBScript program does the following:

- Preset the VNA
- Return active channel number and measurement string
- Create a marker
- Set X-axis value
- Read X, Y-axis values
- Set marker to trace Min
- Read X, Y-axis values

The SCPI commands in this example are sent over a COM interface using the SCPIStringParser object. You do NOT need a GPIB connection to run this example.

This VBScript (*.vbs) program can be run as a macro in the VNA. To do this, copy the following code into a text editor file such as Notepad and save it on the VNA hard drive as Markers.vbs. [Learn how to setup and run the macro.](#)

[See all Marker SCPI commands.](#)

See Other SCPI Example Programs

```
Dim na, vi, ret
Set na = CreateObject("AgilentPNA835x.Application")
Set vi = na.ScpStringParser
'Get Identification String from Analyzer
ret=vi.Parse("*IDN?")
msgbox ret
'Preset VNA
ret=vi.Parse("SYST:PRES; *OPC?")
'Get Active Channel and Measurement
```

```
chan = vi.Parse("SYST:ACT:CHAN?")
meas = vi.Parse("SYST:ACT:MEAS?")
'Convert chan to a single number
chan=CStr(CInt(chan))
'Select Active Measurement
vi.Parse "CALC" + chan + ":PAR:SEL " + meas
'Turn Marker 1 on and set X value to 1 GHz
vi.Parse "CALC" + chan + ":MARK1:STAT ON"
vi.Parse "CALC" + chan + ":MARK1:X 1e9"
'Get X and Y marker values
x_val = vi.Parse("CALC" + chan + ":MARK1:X?")
y_val = vi.Parse("CALC" + chan + ":MARK1:Y?")
'Display Marker Values
msgbox "X Value = " + x_val + Chr(10) + "Y Value = " + y_val
'Use Marker 1 as a minimum search
vi.Parse "CALC" + chan + ":MARK1:FUNC:EXEC MIN"
'Get X and Y marker values
x_val = vi.Parse("CALC" + chan + ":MARK1:X?")
y_val = vi.Parse("CALC" + chan + ":MARK1:Y?")
'Display Marker Values
msgbox "X Value = " + x_val + Chr(10) + "Y Value = " + y_val
```

Setup Noise Figure Port Mapping

This program demonstrates how to change source and receive ports when measuring noise figure. It assumes that option 029 ("Fully Corrected Noise Figure") is installed.

If only option 028 ("Noise figure measurements using standard receivers") is installed, switching ports is simpler, since only one noise receiver selection is available.

This program can be run as a macro in the VNA. To do this, copy the code into a text editor file such as Notepad and save on the VNA hard drive as NF.vbs. [Learn how to setup and run the macro.](#)

[See the Noise figure commands.](#)

See Other SCPI Example Programs

```
option explicit
dim app, hostname, parser
set app = CreateObject("Agilentpna835x.application")
set parser = app.ScpiStringParser
' Create Noise Figure measurement
parser.Parse "*RST"
parser.Parse "CALC:PAR:DEL:ALL"
parser.Parse "CALC:CUST:DEF 'NF', 'Noise Figure Cold Source', 'NF'
"
parser.Parse "DISP:WIND:TRAC1:FEED 'NF'"
' To change from the default input/output port settings of
' source port = VNA1, receive port = VNA2, you must first
' change the noise receiver, then select the desired ports.
dim srcPort, rcvPort
' Set source=VNA port 3 and receiver=VNA port 4
srcPort = 3
```

```
rcvPort = 4
' use VNA receiver for noise measurements
parser.Parse "SENS:NOIS:REC NORMAL"
' set port mapping
parser.Parse "SENS:NOIS:PMAP " & srcPort & "," & rcvPort
' To revert back to using the noise receiver, the source
' and receive ports must be set to their default values
' BEFORE switching to the noise receiver. Otherwise, a
' SCPI "Execution error" will occur.
' restore defaults: source=VNA1, receiver=VNA2
parser.Parse "SENS:NOIS:PMAP 1,2"
' use dedicated noise receiver for noise measurements
parser.Parse "SENS:NOIS:REC NOISE"
```

Setup PNOP and PSAT Marker Search

This example program does the following:

- Sets up measurement for either PNOP or PSAT marker search
- Sets parameters for search
- Reads a parameter for each

See [PNOP](#) and [PSAT](#) SCPI commands.

The SCPI commands in this example are sent over a COM interface using the SCPIStringParser object. You do NOT need a GPIB connection to run this example.

This VBScript (*.vbs) program can be run as a macro in the VNA. To do this, copy the following code into a text editor file such as Notepad and save it on the VNA hard drive as SearchMkr.vbs. [Learn how to setup and run the macro.](#)

See Other SCPI Example Programs

```
Dim app
Set app = CreateObject("AgilentPNA835X.Application")
Dim scpi
set scpi = app.ScpiStringParser
scpi.Execute ("SYST:FPRreset")
' View Power Out vs Power In
' Create and turn on window/channel 1
scpi.Execute ("DISPlay:WINDow1:STATE ON")
'Define a measurement name, parameter
scpi.Execute ("CALCulate1:PARAmeter:DEFine:EXT 'MyMeas',B")
'Associate ("FEED") the measurement name ('MyMeas') to WINDOW (1)
scpi.Execute ("DISPlay:WINDow1:TRACe1:FEED 'MyMeas'")
scpi.Execute ("CALCulate1:PARAmeter:SElect 'MyMeas'")
```

```

'perform power sweep

scpi.Execute ("SENSE1:SWEep:TYPE Power")

scpi.Execute ("SOURce1:POWer:START -5")

scpi.Execute ("SOURce1:POWer:STOP 0")

'-----

'Choose marker search

resp=Msgbox ("PNOP (yes) or PSAT (no)" , 4, "PNA Marker Search Demo")

if resp=6 then

    PNOP1()

Else

    PSAT1()

End If

'-----

'PSAT marker search

Sub PSAT1()

scpi.Execute ("CALCulate1:MARKer:PSATuration:BACKoff 2")

'Read PSAT Parameter

dim answer

answer=scpi.Execute ("CALCulate1:MARKer:PSATuration:GAIN?")

wscript.echo("Gain Sat: "& answer)

End Sub

'-----

'PNOP marker search

Sub PNOP1()

scpi.Execute ("CALCulate1:MARKer:PNOP:BACKoff 2")

scpi.Execute ("CALCulate1:MARKer:PNOP:POFFset 1")

'Read PNOP Parameter

dim answer

```

```
answer=scpi.Execute ("CALCulate1:MARKer:PNOP:GAIN?")  
wscript.echo("PNOP Gain: "& answer)  
End Sub
```

Setup Receiver Leveling using SCPI

This VBScript program configures Receiver Leveling.

- Preset the VNA
- Make all receiver leveling settings

The SCPI commands in this example are sent over a COM interface using the SCPIStringParser object. You do NOT need a GPIB connection to run this example.

This VBScript (*.vbs) program can be run as a macro in the VNA. To do this, copy the following code into a text editor file such as Notepad and save it on the VNA hard drive as RxLev.vbs. [Learn how to setup and run the macro.](#)

[See all Receiver Leveling SCPI commands.](#)

See Other SCPI Example Programs

```
Set pna = CreateObject("AgilentPNA835x.Application")
Set SCPI = pna.ScpIStringParser
'set source port
dim srcP
srcP = "1"
'Preset PNA
SCPI.Parse "SYST:PRES"
SCPI.Parse "sour1:pow" + srcP + "-15"
SCPI.Parse "sour1:pow" + srcP + ":alc:mode:rec:ref 'R1'"
SCPI.Parse "sour1:pow" + srcP + ":alc:mode:rec:tol 0.02"
SCPI.Parse "sour1:pow" + srcP + ":alc:mode:rec:iter 10"
SCPI.Parse "sour1:pow" + srcP + ":alc:mode:rec:fast OFF"
SCPI.Parse "sour1:pow" + srcP + ":alc:mode:rec:ifbw 100"
SCPI.Parse "sour1:pow" + srcP + ":alc:mode:rec:offs 0"
```



```
SCPI.Parse "sour1:pow" + srcP + ":alc:mode:rec:safe:max 20"
```

```
SCPI.Parse "sour1:pow" + srcP + ":alc:mode:rec:safe:min -100"
```

```
SCPI.Parse "sour1:pow" + srcP + ":alc:mode:rec:safe ON"
```

```
'Last, enable receiver leveling
```

```
SCPI.Parse "sour1:pow" + srcP + ":alc:mode:rec ON"
```

Setup Sweep Parameters using SCPI

This Visual Basic program sets up sweep parameters on the Channel 1 measurement. To run this program, you need:

- An established [GPIB interface connection](#)

[See Other SCPI Example Programs](#)

```
GPIB.Write "SYSTem:PRESet"
'Select the measurement
GPIB.Write "CALCulate:PARAmeter:SElect 'CH1_S11_1'"
'Set sweep type to linear
GPIB.Write "SENSe1:SWEep:TYPE LIN"

'Set IF Bandwidth to 700 Hz
GPIB.Write "SENSe1:BANDwidth 700"

'Set Center and Span Freq's to 4 GHz
GPIB.Write "SENSe1:FREQuency:CENTer 4ghz"
GPIB.Write "SENSe1:FREQuency:SPAN 4ghz"

'Set number of points to 801
GPIB.Write "SENSe1:SWEep:POINts 801"

'Set sweep generation mode to Analog
GPIB.Write "SENSe1:SWEep:GENeration ANAL"

'Set sweep time to Automatic
GPIB.Write "SENSe1:SWEep:TIME:AUTO ON"

'Query the sweep time
GPIB.Write "SENSe1:SWEep:TIME?"
SweepTime = GPIB.Read
```

Setup the Display using SCPI

This Visual Basic program:

- Sets data formatting
- Turns ON the Trace, Title, and Frequency Annotation
- Autoscales the Trace
- Queries Per Division, Reference Level, and Reference Position
- Turn ON and set averaging
- Turn ON and set smoothing

To run this program, you need:

- An established [GPIB interface connection](#)

[See Other SCPI Example Programs](#)

```
GPIB.Write "SYSTem:PRESet"

'Select the measurement
GPIB.Write "CALCulate:PARAmeter:SElect 'CH1_S11_1'"

'Set the Data Format to Log Mag
GPIB.Write ":CALCulatel:FORMat MLOG"

'Turn ON the Trace, Title, and Frequency Annotation
GPIB.Write "Display:WINDow1:TRACel:STATe ON"
GPIB.Write "DISPlay:WINDow1:TITLe:STATe ON"
GPIB.Write "DISPlay:ANNotation:FREQuency ON"

'Autoscale the Trace
GPIB.Write "Display:WINDow1:TRACel:Y:Scale:AUTO"

'Query back the Per Division, Reference Level, and Reference Position
GPIB.Write "DISPlay:WINDow1:TRACel:Y:SCALE:PDIVision?"
Pdiv = GPIB.Read
GPIB.Write "DISPlay:WINDow1:TRACel:Y:SCALE:RLEVel?"
Rlev = GPIB.Read
GPIB.Write "DISPlay:WINDow1:TRACel:Y:SCALE:RPOStion?"
Ppos = GPIB.Read

'Turn ON, and average five sweeps
```

```
GPIB.Write "SENSE1:AVERAGE:STATE ON"
```

```
GPIB.Write "SENSE1:AVERAGE:COUNT 5"
```

```
'Turn ON, and set 20% smoothing aperture
```

```
GPIB.Write "CALCULATE1:SMOOTHING:STATE ON"
```

```
GPIB.Write "CALCULATE1:SMOOTHING:APERTURE 20"
```

Show Custom Cal Windows during a Guided Calibration

This VBScript program shows how to send commands that allow you to view specific 'custom' windows, and sweep specific channels, during a UI (Cal Wizard) or remote calibration.

The SCPI commands in this example are sent over a COM interface using the SCPIStringParser object. You do NOT need a GPIB connection to run this example.

This VBScript (*.vbs) program can be run as a macro in the VNA. To do this, copy the following code into a text editor file such as Notepad and save it on the VNA hard drive as CalWindow.vbs. [Learn how to setup and run the macro.](#)

These commands are used to show and sweep windows and channels:

- SENS:CORR:COLL:DISP:WIND
- SENS:CORR:COLL:SWE:CHAN
- SENS:CORR:COLL:DISP:WIND:AOFF
- SENS:CORR:COLL:SWE:CHAN:AOFF
- SENS:CORR:COLL:GUID:PACQuire

See Other SCPI Example Programs

```
Dim app

Dim scpi

' Create / Get the PNA application.

Set app = CreateObject("AgilentPNA835x.Application")

Set scpi = app.ScpiStringParser

' A comment

'Preset the analyzer

'This creates an S11 measurement in channel 1, window 1

scpi.Execute "SYST:PRreset"

' Create and turn on window 2
```

```

scpi.Execute "DISPlay:WINDow2:STATE ON"

'Define an S21 measurement in channel 2

scpi.Execute "CALCulate2:PARAmeter:DEFine:EXT 'MyMeas',S21"

'Associate ("FEED") the measurement name ('MyMeas') to WINDow2

'and give the new TRACe a number (1).

scpi.Execute "DISPlay:WINDow2:TRACe1:FEED 'MyMeas'"

'The following lines are all you need in order to:

'show and sweep the custom Cal windows during a UI Calibration

'If sending ONLY these commands, make sure you know the

'correct window and channel numbers to show and sweep.

'Flag windows 1 and 2 to show during Ch1 calibration

scpi.Execute "SENS:CORR:COLL:DISP:WIND1 ON"

scpi.Execute "SENS:CORR:COLL:DISP:WIND2 ON"

'Flag channels 1 and 2 to sweep during Ch1 calibration

scpi.Execute "SENS1:CORR:COLL:SWE:CHAN1 ON"

scpi.Execute "SENS1:CORR:COLL:SWE:CHAN2 ON"

' =====

' The following code performs a remote guided Cal on Ch1.

' From a remote cal, the Cal window does not normally show and sweep

' after the previous standard has been acquired.

' This shows how to include the PACQuire (preview) to view and sweep the Cal

Window.

' The Custom window also shows and sweeps due to the flag commands above.

' The flags are cleared at the end of this section.

' Specify the DUT connectors

```

```

scpi.Execute "sens:corr:coll:guid:conn:port1 ""APC 3.5 female"" "
scpi.Execute "sens:corr:coll:guid:conn:port2 ""APC 3.5 male"" "
' Select the Cal Kit for each port being calibrated.
scpi.Execute "sens:corr:coll:guid:ckit:port1 ""85052D"" "
scpi.Execute "sens:corr:coll:guid:ckit:port2 ""85052D"" "
' Initiate the calibration and query the number of steps
scpi.Execute "sens:corr:coll:guid:init"
numSteps = scpi.Execute("sens:corr:coll:guid:steps?")
MsgBox "Number of steps is " + CStr(numSteps)
' Measure the standards
For i = 1 to numSteps
step = "Step " + CStr(i) + " of " + CStr(numSteps)
strPrompt = scpi.Execute("sens:corr:coll:guid:desc? " + CStr(i))
'send the Preview Acquire command, then prompt
scpi.Execute "sens:corr:coll:guid:PACquire STAN" + CStr(i)
' Do NOT send any Guided Cal commands here or the cal window will not sweep
MsgBox strPrompt, vbOKOnly, step
scpi.Execute "sens:corr:coll:guid:acq STAN" + CStr(i)
Next
' Conclude the calibration
scpi.Execute "sens:corr:coll:guid:save"
MsgBox "Cal is done!"

'Remove the Custom Window flags
scpi.Execute "SENS:CORR:COLL:DISP:WIND:AOFF"
'Remove the channel sweep flags
scpi.Execute "SENS:CORR:COLL:SWE:CHAN:AOFF"

```



Perform a Sliding Load Calibration using GPIB

This Visual Basic program does a **only** the sliding load portion of a Calibration.

To run this program, you need:

- An established **GPIB interface connection**
- A measurement and calibration routine to call this sub-program
- STAN3 set up as a sliding load standard

See Other SCPI Example Programs

```
Sub slide()  
'Measure the sliding load for at least 5 and no more than 7 slides  
'Note that "SLSET" and "SLDONE" must be executed before the actual acquisition of a  
slide  
MsgBox "Connect Sliding Load; set to Position 1; then press OK"  
GPIB.Write "SENS:CORR:COLL SLSET"  
GPIB.Write "SENS:CORR:COLL STAN3;"  
  
MsgBox "Set Sliding Load to position 2; then press OK"  
GPIB.Write "SENS:CORR:COLL SLSET"  
GPIB.Write "SENS:CORR:COLL STAN3;"  
  
MsgBox "Set Sliding Load to position 3; then press OK"  
GPIB.Write "SENS:CORR:COLL SLDONE"  
GPIB.Write "SENS:CORR:COLL STAN3;"  
End Sub
```

Create a Spectrum Analyzer Measurement

This example program creates a Spectrum Analyzer measurement setup.

This VBScript program can be run as a macro in the VNA. To do this, copy the code into a text editor file such as Notepad and save on the VNA hard drive as SA.vbs. [Learn how to setup and run the macro.](#)

[See the Spectrum Analyzer commands.](#)

See Other SCPI Example Programs

```
' Demonstration of basic Spectrum Analyzer measurement setup.
set pna=CreateObject("AgilentPNA835x.Application","hostname")
set scpi = pna.ScpiStringParser
CreateSAMeasurement
SetupLinearSweep
ConfigureAdvancedSettings
' Create a Spectrum Analyzer measurement
Sub CreateSAMeasurement
' Create a B measurement on channel 1
scpi.Parse "SYST:FPR"
scpi.Parse "DISP:WIND ON"
scpi.Parse "CALC:CUST:DEF 'sa_meas', 'Spectrum Analyzer', 'B'"
scpi.Parse "DISP:WIND:TRAC:FEED 'sa_meas'"
scpi.Parse "CALC:PAR:SEL 'sa_meas'"
' Set frequency range
scpi.Parse "SENS:FREQ:CENTER 3 GHz"
scpi.Parse "SENS:FREQ:SPAN 2 GHz"
' Center frequency step size
```

```

' Set to Auto mode with SENS:FREQ:CENTER:STEP:AUTO ON
scpi.Parse "SENS:FREQ:CENTER:STEP:SIZE 20 MHz"
' RBW filter shape
' Choices are GAUSSian|FLATtop|KAISer|BLACKman|NONE
scpi.Parse "SENS:SA:BAND:SHAPE KAIS"
' RBW and VBW values
scpi.Parse "SENS:SA:BAND:RES 100 kHz"
scpi.Parse "SENS:SA:BAND:VID 10 kHz"
' Detector type
' Choices are AVERAge|SAMPlE|PEAK|NORMAl|NEGPeak|PSAMPlE|PAVERage
scpi.Parse "SENS:SA:DET:FUNC PEAK"
' Video averaging type
' Choices are POWER|LOG|VOLTage|VMAX|VMIN
scpi.Parse "SENS:SA:BAND:VID:AVER:TYPE VMAX"
scpi.Parse "SENS:SA:BAND:VID:AVER:COUNT?"
' RBW/VBW and Span/RBW ratios
scpi.Parse "SENS:SA:BAND:VID:RAT 1.23"
scpi.Parse "SENS:SA:FREQ:SPAN:BAND:RAT 134"
' ADC Filter
' Choices are 11MHz|38MHz
' Enable auto mode with SENS:SA:ADC:FILT:AUTO.
scpi.Parse "SENS:SA:ADC:FILTer 38MHz"
End Sub

' Configure a Spectrum Analyzer measurement for Linear sweep mode
on Port 1.
Sub SetupLinearSweep
' Turn Port 1 ON

```

```

scpi.Parse "SOURCE:POW:MODE ON"
' Set Port 1 sweep type to Linear
scpi.Parse "SENS:SA:SOURCE1:SWEEP:TYPE LIN"
' Set start and stop frequencies
scpi.Parse "SENS:SA:SOURCE1:FREQ:START 2E9"
scpi.Parse "SENS:SA:SOURCE1:FREQ:STOP 4E9"
' Set 'Source Number of Steps'. This is the number of frequencies
to use between start and stop (inclusive).
' This setting is channel-wide.
scpi.Parse "SENS:SA:SOUR:SWEEP:POINT:COUNT 5"
' Set 'SA Sweeps per Source Steps'. This is the number of sweeps
to take at each measurement frequency.
' This setting is also channel-wide.
scpi.Parse "SENS:SA:SOUR:SWEEP:REPEAT:COUNT 2"
End Sub
' Configure a few of the Advanced Settings for SA.
Sub ConfigureAdvancedSettings
' Set the 'Image Reject' selection.
' Choices are MIN MAX NORM NLOW NHIGH
scpi.Parse "SENS:SA:IMAGE:REJ MAX"
' Enable display of ImageReject traces.
scpi.Parse "SENS:SA:TRACE:IMAGE:STATE ON"
' Enable point mode.
' This forces the number of display points to match the FFT point
count.
scpi.Parse "SENS:SA:DET:BYPASS ON"
End Sub

```

See Other SCPI Example Programs

Status Reporting using SCPI

This Visual Basic program demonstrates two methods of reading the analyzer's status registers:

- Polled Bit Method - reads the Limit1 register continuously.
- SRQ Method - enables an interrupt of the program when bit 6 of the status byte is set to 1. The program then queries registers to determine if the limit line failed.

To run this program, you need:

- An established [GPIB interface connection](#)
- A form with two buttons: Poll and SRQ Method
- A means of causing the limit line to fail, assuming it passes initially.

```
Private Sub Poll_Click()  
' POLL THE BIT METHOD  
' Clear status registers  
GPIB.Write "*CLS"  
  
'Loop FOREVER  
Do  
    DoEvents  
    GPIB.Write "STATus:QUESTionable:LIMit1:EVENT?"  
    onn = GPIB.Read  
Loop Until onn = 2  
  
MsgBox "Limit 1 Failed "  
End Sub  
  
Private Sub SRQMethod_Click()  
'SRQ METHOD  
GPIB.Write "SYSTem:PRESet"  
GPIB.Write "CALCulate:PARAmeter:SElect 'CH1_S11_1'"  
'slow down the trace  
GPIB.Write "SENS:BWID 150"  
  
'Setup limit line  
GPIB.Write "CALC:LIM:DATA 2,3e9,6e9,-2,-2"  
GPIB.Write "CALC:LIMit:DISP ON"  
GPIB.Write "CALC:LIMit:STATe ON"  
  
' Clear status registers.
```

```

GPIB.Write "*CLS;*wai"
' Clear the Service Request Enable register.
GPIB.Write "*SRE 0"
' Clear the Standard Event Status Enable register.
GPIB.Write "*ESE 0"

' Enable questionable register, bit(10) to report to the status byte.
GPIB.Write "STATUS:QUESTIONABLE:ENABLE 1024"

' Enable the status byte register bit3 (weight 8) to notify controller
GPIB.Write "*SRE 8"

' Enable the onGPIBNotify event
GPIB.NotifyMask = cwGPIBRQS
GPIB.Notify
End Sub

-----
Private Sub GPIB_OnGPIBNotify(ByVal mask As Integer)
' check to see what failed
' was it the analyzer?
GPIB.Write "*STB?"
onn = GPIB.Read
If onn <> 0 Then
' If yes, then was it the questionable register?
GPIB.Write "STATUS:QUESTIONABLE:EVENT?"
onn = GPIB.Read
' Determine if the limit1 register, bit 8 is set.
If onn = 1024 Then
'if yes, then was it trace 1?
GPIB.Write "STAT:QUES:LIMIT1:EVENT?"
onn = GPIB.Read
If onn = 2 Then MsgBox ("Limit Line1 Failed")
End If
End If
End Sub

```

Transfer Data using GPIB

The following RMB examples transfer data to and from a remote PC using the **MMEM:TRANsfer** command.

Transferring data FROM the VNA -- TO a remote PC:

```
30      !
40      !           Set up I/O paths
50      !
60      ! Network analyzer address
70      ASSIGN @Na TO 716
75      !
77      ! File to be stored on local computer
80      ! First time -- need to create the file.
90      ! After file name, number records set to 0 (ignored by WinOS)
95      ! Use "PURGE" command to delete if desired.
100     CREATE "mytestdata.s2p",0
110     ASSIGN @File TO "mytestdata.s2p"
120     !
122     !           TRANSFER the data (download)
123     !
125     ! Analyzer has file 'testdata.s2p' in default directory
130     OUTPUT @Na;" :MMEM:TRAN? ""testdata.s2p""
135     !
137     ! Now read the bytes coming back from the analyzer in four steps
138     ! (1) Read and dump the first character - '#'
140     ENTER @Na USING "#,A";A$
141     !
142     ! (2) Read the next character which is the number of digits in the file size
150     ENTER @Na USING "#,A";Digit$
160     !
161     ! (3) Use the value of the number of digits to read back the file byte size
170     ! Create query string using this number of digits
180     Img$="#,"&Digit$&"A"
190     !
200     ! Byte$ holds the number of bytes in string format
210     ENTER @Na USING Img$;Byte$
220     !
225     ! (4) Read the file contents into a buffer and store the buffer contents to a
local file
230     ! Allocate a buffer for holding the data
240     ALLOCATE Dat$[VAL(Byte$)]
250     !
260     ! Set up a different image for filling the buffer
270     Img$=Byte$&"A"
280     !
290     ! Retrieve the actual file data
300     ENTER @Na USING Img$;Dat$
```

```
305  !
307  ! Now save the file locally.
310  OUTPUT @File;Dat$
320  END
```

Transferring data FROM the remote PC - TO the VNA:

```
40   !           Set up I/O paths
50   !
60   ! Network analyzer address
70   ASSIGN @Na TO 716
77   ! File to be retrieved from local computer
78   ASSIGN @File TO "mytestdata.s2p"
79   !
120  !
122  !           TRANSFER the data
123  !
230  ! Allocate a buffer for holding the data
240  ALLOCATE Dat$[26236]
250  !
260  ! Get data from the file and fill Dat$
270  ENTER @File;Dat$
280  !
325  ! Data to be transferred to analyzer file 'testupld.s2p'
325  ! in default directory.
326  !
327  ! A specific block transfer designator must follow the
328  ! file name:
329  !     '#' specifies a block transfer.
330  !     '6' specifies 6 digits to follow.
331  !     '026236' matches the buffer size allocated above
332  !     not counting <NL><END> (new line and end of file).
430  OUTPUT @Na;":MMEM:TRAN ""testupld.s2p"",#6026236",Dat$
520  END
```

Triggering the Analyzer using SCPI

To understand how to trigger the analyzer using SCPI, it is very important to understand the **trigger model**. Here is a very simple explanation. These three separate functions control triggering:

1. **Trigger:Source** - Where the trigger signals originate:
 - Internal Continuous
 - Internal Manual (Single)
 - External - a trigger source that is connected to the rear panel.
2. **Trigger:Scope** - what gets triggered:
 - Global - each signal triggers all channels in turn.
 - Channel - each signal triggers ONE channel.
3. Channel settings (**Sense<ch>:Sweep:Mode**) How many triggers will each channel accept before going into hold.
 - HOLD - channel will not trigger.
 - CONTinuous - channel triggers indefinitely.
 - GROups - channel accepts the number of triggers specified with the last **SENS:SWE:GRO:COUN** <num>.
 - SINGle - channel accepts ONE trigger, then goes to HOLD.
 - Point trigger **SENS1:SWE:TRIG:POINT**

When controlling the VNA using SCPI, a SINGLE trigger is used to ensure that a complete sweep is taken. This example demonstrates how to Single trigger the VNA using the following two methods:

- **Simplest Triggering**
 - This method uses the **default** Trigger Source = Internal to send a stream of trigger signals.
 - The channel is configured to ACCEPT only a single trigger signal, then HOLD (**Sense<ch>:Sweep:Mode SINGle**). This is the ONLY required command.

- This method can also be used when an External trigger source sends a continuous stream of trigger signals.

- **Advanced Triggering**

- This method SENDS a single trigger from the Source, which can be from either Internal (using INIT:IMM) or External triggering.
- Each channel is configured to accept an unlimited number of triggers. This method is the only way to perform point triggering.
- When you require some channels to accept continuous triggers and other channels to accept single triggers, see [INIT:IMM Advanced](#) to learn how.

The SCPI commands in this example are sent over a COM interface using the SCPIStringParser object. You do NOT need a GPIB connection to run this example.

This VBScript (*.vbs) program can be run as a macro in the analyzer. To do this, copy the following code into a text editor file such as Notepad and save it on the analyzer hard drive as Trigger.vbs. [Learn how to setup and run the macro.](#)

Measurement setup example: This section of code can be used at the start of both methods. It sets up:

- S11 traces on two channels
- 10 data points
- Sweep time of 2 seconds - this is slow enough to allow us to watch as each trace is triggered.

```
Dim app
Dim scpi
' Create / Get the VNA application.
Set app = CreateObject("AgilentPNA835x.Application")
Set scpi = app.ScpiStringParser
'=====
'Setup the VNA
'Preset the analyzer
scpi.Execute ("SYST:FPRreset")
```

```

' Create and turn on window/channel 1
scpi.Execute ("DISPlay:WINDow1:STATE ON")
'Define a measurement name, parameter
scpi.Execute ("CALCulate1:PARAmeter:DEFine:EXT 'MyMeas1',S11")
'Associate ("FEED") the measurement name ('MyMeas') to WINDow (1)
scpi.Execute ("DISPlay:WINDow1:TRACe1:FEED 'MyMeas1'")
' Create and turn on window/channel 2
scpi.Execute ("DISPlay:WINDow2:STATE ON")
'Define a measurement name, parameter
scpi.Execute ("CALCulate2:PARAmeter:DEFine:EXT 'MyMeas2',S11")
'Associate ("FEED") the measurement name ('MyMeas') to WINDow (2)
scpi.Execute ("DISPlay:WINDow2:TRACe2:FEED 'MyMeas2'")
'Set slow sweep so we can see
scpi.Execute ("SENS1:SWE:TIME 2")
scpi.Execute ("SENS2:SWE:TIME 2")
'set number of points to 10
scpi.Execute ("SENS1:SWE:POIN 10")
scpi.Execute ("SENS2:SWE:POIN 10")
'=====
' Put both channels in Hold
scpi.Execute ("SENS1:SWE:MODE HOLD")
scpi.Execute ("SENS2:SWE:MODE HOLD")
'=====
'Pick Single Send or Single Accept
resp=Msgbox ("Single Send? - Click No for Single Accept", 4, "PNA Trigger Demo")
If resp=6 Then
SingleSend()
Else

```

```
SingleAccept()
```

```
End If
```

Simple Triggering The following example sends a continuous stream of trigger signals and each VNA channel is set to ACCEPT only a signal trigger signal, then HOLD.

- This example can be used to configure External triggering where the trigger source sends a continuous stream of trigger signals. Configure the type of trigger signal that the VNA responds to using the **CONTRol:SIGNal** command. The command in this example sets the VNA to respond to HIGH TTL signals at the rear-panel BNC1 trigger IN connector. This command also automatically sets Trigger Source to External Trigger.
- The **TRIG SCOPE** (Global or Channel) setting is NOT necessary with a continuous stream of trigger signals. The example program directly controls when each channel is triggered.
- Point triggering can NOT be used with a continuous stream of trigger signals because in point triggering the channel will accept as many triggers as necessary to complete ONE full sweep. Use the **single SEND** example for point triggering.

```
Sub SingleAccept()
```

```
'VNA sends continuous trigger signals
```

```
scpi.Execute ("TRIG:SOUR IMMEDIATE")
```

```
'Uncomment the following to set External triggering
```

```
'scpi.Execute ("CONT:SIGN BNC1,TILHIGH")
```

```
AcceptOne()
```

```
End Sub
```

```
Sub AcceptOne()
```

```
'The following command makes the channel immediately sweep
```

```
'*OPC? allows the measurement to complete before the controller sends another command
```

```
scpi.Execute ("SENS1:SWE:MODE SINGLE;*OPC?")
```

```
' You could do something to ch2 here before sweeping it
```

```
scpi.Execute ("SENS2:SWE:MODE SINGLE;*OPC?")
```

```

resp=Msgbox ("Another trigger?", 1, "PNA Trigger Demo")

If resp=1 Then

AcceptOne ()

End If

End Sub

```

Advanced Trigger This example section performs Single Send triggering. Here, single triggering is accomplished by SENDING one trigger signal from the Trigger source and each channel is setup to accept unlimited trigger signals. See the **INIT:IMM** command for more details.

- Using this method, it is possible to change **Trigger:Scope** to Global or Channel. Set trigger scope to channel if there is some code to execute between channel measurements. Similarly, this method can be used to set **Point triggering**. Use this method if there is some code to execute between data point measurements.
- In addition, this method can also be used to perform External triggering if the external trigger source is capable of SENDING single triggers. See the **CONTROL:SIGNaI** command to set the type of signal to which the VNA will respond.
- If the external source can only send a continuous stream of trigger signals, then the **Single Accept** section must be used.

```

Sub SingleSend()

' Set Source Internal - Manual Triggering

scpi.Execute ("TRIG:SOUR MANual")

' If using an External trigger source that is capable of
' sending SINGLE trigger signals, then uncomment the following.
' This command automatically sets trigger source to External
' scpi.Execute ("CONT:SIGN BNC1,TILHIGH")

' Setup Trigger Scope

' WHAT gets triggered

' Pick one using comments

' Set Channel triggering

' scpi.Execute ("TRIG:SCOPE CURRent")

```

```

'Set Global triggering (Default)

scpi.Execute ("TRIG:SCOPE ALL")

'Set Channel Settings

'The channels respond to UNLIMITED trigger signals (Default)

scpi.Execute ("SENS1:SWE:MODE CONTinuous")

scpi.Execute ("SENS2:SWE:MODE CONTinuous")

'To do Point trigger on one or more channels, uncomment the following.

'Point trigger automatically sets Trig:Scope to Current/Channel

'scpi.Execute ("SENS1:SWE:TRIG:POINT ON")

'scpi.Execute ("SENS2:SWE:TRIG:POINT ON")

IntTrig()

End Sub

Sub IntTrig()

'If External triggering, replace this Sub with code

'to single trigger the External Trig Source

Dim resp

'*OPC? allows the measurement to complete before the controller sends another
command

scpi.Execute ("INITiate:IMMediate;*OPC?")

resp=Msgbox ("Another trigger?", 1, "PNA Trigger Demo")

If resp=1 Then

IntTrig()

End If

End Sub

```

Perform an Unguided Cal on Multiple Channels

This VBScript program performs an Unguided Calibration simultaneously on two channels.

This could be used in the following cases:

- If you need more than the current number of data points per trace, so the additional points must be added to a different channel.
- If you need several channels with independent settings, but you want to calibrate all channels with a minimal number of standard connections. This would be especially critical for on wafer calibration.

The SCPI commands in this example are sent over a COM interface using the SCPIStringParser object. You do NOT need a GPIB connection to run this example.

This VBScript (*.vbs) program can be run as a macro in the VNA. To do this, copy the following code into a text editor file such as Notepad and save it on the VNA hard drive as Unguided.vbs. [Learn how to setup and run the macro.](#)

```
Dim app
Dim scpi
Dim NumberOfActiveChannels
NumberOfActiveChannels = 2
' Create / Get the VNA application.
Set app = CreateObject("AgilentPNA835x.Application")
Set scpi = app.ScpiStringParser
' Query the list of connectors that the VNA system recognizes
scpi.Execute("SYST:PRES")
'Wait for successful preset before continuing
done=scpi.Execute("*OPC?")
'The following section sets up 2 channels with different frequency ranges
scpi.Execute("DISP:WIND1:STATE OFF")
'Reset Windows
scpi.Execute("DISP:WIND1:STATE ON")
```



```

scpi.Execute("DISP:WIND2:STATE ON")
'
' Assign a measurement to the first window
scpi.Execute("CALC1:PAR:DEF:EXT 'Meas1', S21")
scpi.Execute("DISP:WIND1:TRAC1:FEED 'Meas1'")
'Assign a measurement to the second window
scpi.Execute("CALC2:PAR:DEF:EXT 'Meas2', S21")
scpi.Execute("DISP:WIND2:TRAC1:FEED 'Meas2'")
'Set up two channels with independent parameters
scpi.Execute("SENS1:FREQ:SPAN 1e9")
scpi.Execute("SENS2:FREQ:SPAN 1e6")
'Wait for changes before continuing
done=scpi.Execute("*OPC?")
'
' This section sets the calibration kits for channel 1 and channel 2
' Select a trace from channel 1 and set calibration type and cal kit
scpi.Execute("CALC1:PAR:SEL 'Meas1'")
scpi.Execute("SENS1:CORR:COLL:METH SPARSOLT")
scpi.Execute("SENS1:CORR:COLL:CKIT 2") '85056D for default settings
' Same standards for forward and reverse direction
scpi.Execute("SENS1:CORR:TST OFF")
' Select a trace from channel 2 and set calibration type and cal kit
scpi.Execute("CALC2:PAR:SEL 'Meas2'")
scpi.Execute("SENS2:CORR:COLL:METH SPARSOLT")
scpi.Execute("SENS2:CORR:COLL:CKIT 2") '85056D for default settings
' Same standards for forward and reverse direction
scpi.Execute("SENS2:CORR:TST OFF")

```

```

'Set both channels to manual triggering

scpi.Execute("INIT1:CONT OFF")

scpi.Execute("INIT2:CONT OFF")

'

'The following assumes female port connector on port 1

' and male port connector on port 1

'Step through all active channels and calibrate and measure all standards.

scpi.Execute("SENS1:CORR:SFOR ON") 'Set acquisition to forward
scpi.Execute("SENS2:CORR:SFOR ON") 'Set acquisition to forward

MsgBox("Connect OPEN standard to port 1")

For CurrentChannel = 1 To NumberOfActiveChannels
scpi.Execute("CALC" & CurrentChannel & ":PAR:SEL 'Meas" & CurrentChannel & "'")
scpi.Execute("SENS" & CurrentChannel & ":CORR:COLL stan1")
done= scpi.Execute("*OPC?")
Next

MsgBox("Connect SHORT standard to port 1")

For CurrentChannel = 1 To NumberOfActiveChannels
scpi.Execute("CALC" & CurrentChannel & ":PAR:SEL 'Meas" & CurrentChannel & "'")
scpi.Execute("SENS" & CurrentChannel & ":CORR:COLL stan2")
done=scpi.Execute("*OPC?")
Next

MsgBox("Connect LOAD standard to port 1")

For CurrentChannel = 1 To NumberOfActiveChannels
scpi.Execute("CALC" & CurrentChannel & ":PAR:SEL 'Meas" & CurrentChannel & "'")
scpi.Execute("SENS" & CurrentChannel & ":CORR:COLL stan3")
done=scpi.Execute("*OPC?")

```

```

Next

scpi.Execute("SENS1:CORR:SFOR OFF") 'Set acquisition to reverse
scpi.Execute("SENS2:CORR:SFOR OFF") 'Set acquisition to forward

MsgBox("Connect OPEN standard to port 2")

For CurrentChannel = 1 To NumberOfActiveChannels

scpi.Execute("CALC" & CurrentChannel & ":PAR:SEL 'Meas" & CurrentChannel & "'")

scpi.Execute("SENS" & CurrentChannel & ":CORR:COLL stan1")

done=scpi.Execute("*OPC?")

Next

MsgBox("Connect SHORT standard to port 2")

For CurrentChannel = 1 To NumberOfActiveChannels

scpi.Execute("CALC" & CurrentChannel & ":PAR:SEL 'Meas" & CurrentChannel & "'")

scpi.Execute("SENS" & CurrentChannel & ":CORR:COLL stan2")

done=scpi.Execute("*OPC?")

Next

MsgBox("Connect LOAD standard to port 2")

For CurrentChannel = 1 To NumberOfActiveChannels

scpi.Execute("CALC" & CurrentChannel & ":PAR:SEL 'Meas" & CurrentChannel & "'")

scpi.Execute("SENS" & CurrentChannel & ":CORR:COLL stan3")

done=scpi.Execute("*OPC?")

Next

'

'Measure thru standard for all channels in both forward and reverse direction

MsgBox("Connect THRU between ports 1 and 2")

scpi.Execute("SENS1:CORR:SFOR ON") 'Set acquisition to forward

```

```

scpi.Execute("SENS2:CORR:SFOR ON") 'Set acquisition to forward
For CurrentChannel = 1 To NumberOfActiveChannels
scpi.Execute("CALC" & CurrentChannel & ":PAR:SEL 'Meas" & CurrentChannel & "'")
scpi.Execute("SENS" & CurrentChannel & ":CORR:COLL stan4")
done=scpi.Execute("*OPC?")
Next

scpi.Execute("SENS1:CORR:SFOR OFF") 'Set acquisition to reverse
scpi.Execute("SENS2:CORR:SFOR OFF") 'Set acquisition to reverse
For CurrentChannel = 1 To NumberOfActiveChannels
scpi.Execute("CALC" & CurrentChannel & ":PAR:SEL 'Meas" & CurrentChannel & "'")
scpi.Execute("SENS" & CurrentChannel & ":CORR:COLL stan4")
done=scpi.Execute("*OPC?")
Next

For CurrentChannel = 1 To NumberOfActiveChannels
scpi.Execute("CALC" & CurrentChannel & ":PAR:SEL 'Meas" & CurrentChannel & "'")
scpi.Execute("SENS" & CurrentChannel & ":CORR:COLL:SAVE")
done=scpi.Execute("*OPC?")
Next

'Set both channels to continuous triggering
scpi.Execute("INIT1:CONT ON")
scpi.Execute("INIT2:CONT ON")

```

Upload and Download a Segment List

This VBScript program creates two segments, then uploads the segment data to the VNA.

The second part [downloads the segment list from the VNA](#).

The SCPI commands in this example are sent over a COM interface using the SCPIStringParser object. You do NOT need a GPIB connection to run this example.

This VBScript (*.vbs) program can be run as a macro in the VNA. To do this, copy the following code into a text editor file such as Notepad and save it on the VNA hard drive as Unguided.vbs. [Learn how to setup and run the macro](#).

[See all Segment SCPI commands](#).

Create and Upload a Segment List

```
Option Explicit

Dim app

Set app = CreateObject("AgilentPNA835x.Application")

' Preset the VNA
app.Preset

Dim scpi

Set scpi = app.ScpiStringParser

' In case of a measurement receiver VNA like N5264B
' which has no source ports, "SOURCE:CAtalog?" will
' return an empty list (just a pair of quotation marks)

Dim srcPortNames

srcPortNames = Split( scpi.Execute("SOURCE:CAtalog?"), ",")

Dim numberOfSrcPorts

If Left( srcPortNames(0), 2 ) = Chr(34) & Chr(34) Then

    numberOfSrcPorts = 0

Else

    numberOfSrcPorts = UBound(srcPortNames) + 1
```

```

End If

' Building up a string consisting of the sweep segment data
' we want to set up. This example will create two segments.
Dim segData

' Set state of first segment to be ON (1 = ON, 0 = OFF),
' 101 points, start freq of 10 MHz, stop freq of 1 GHz
segData = "1,101,10E6,1E9"

' If you want to include one or more of: IFbandwidth, Dwell Time
' or Port Power, remove the comments from these next two lines
'TurnOnOptions 1 'Call the subroutine
'segData = AddOptionalSettings(segData, numberOfSrcPorts)
' Set state of second segment to be ON, 201 points,
' start freq of 1 GHz, stop freq of 3 GHz
segData = segData & ",1,201,1E9,3E9"

' Uncomment this line below only if you uncommented the
' AddOptionalSettings line above for the first segment.
'segData = AddOptionalSettings(segData, numberOfSrcPorts)

Const numSegs = 2

' Upload our segment list to the channel
scpi.Execute "SENSE1:SEGMENT:LIST SSTOP," & numSegs & "," & segData

' Set segment sweep type on Channel 1
scpi.Execute "SENSE1:SWEep:TYPE SEGMENT"

' Having the VNA display the segment sweep table for the channel
scpi.Execute "DISPlay:WINDow1:TABLE SEGMENT"

Sub TurnOnOptions (ByVal chan)

    scpi.Execute "SENSE"&chan&":SEGMENT:BWIDth:CONTROL ON"

    scpi.Execute "SENSE"&chan&":SEGMENT:SWEep:TIME:CONTROL ON"

    scpi.Execute "SENSE"&chan&":SEGMENT:POWER:CONTROL ON"

```

```

' Turning off coupling allows power to vary per each port
scpi.Execute "SOURCE"&chan&":POWER:COUPLE OFF"

End Sub

Function AddOptionalSettings(ByVal inStr, ByVal numSrcPorts)

' Specifying 1 kHz IF bandwidth and Dwell Time of 0
inStr = inStr & ",1E3,0"

' -10 dBm power for each of the source ports

Dim i

For i = 0 To numSrcPorts - 1

    inStr = inStr & ",-10"

Next

AddOptionalSettings = inStr

End Function

```

Download a Segment List

This example assumes that the active trace is in Window 1

```

Option Explicit

Dim app

Set app = CreateObject("AgilentPNA835x.Application")

Dim scpi

Set scpi = app.ScpiStringParser

' Set the display-active channel's sweep type to segment sweep
' (if the VNA's currently active measurement window doesn't
' contain any traces, this querying for active channel will
' result in a SCPI error which scpi.Parse will trap and throw)

Dim chan

chan = CLng( scpi.Parse("SYSTEM:ACTIVE:CHANNEL?") )

scpi.Execute "SENSE"&chan&":SWEep:TYPE SEGment"

```

```

' Having the VNA display the segment sweep table for the channel
scpi.Execute "DISPlay:WINDow1:TABLE SEGMENT"

' Get the total number of segments
Dim numSegs
numSegs = CLng( scpi.Execute("SENSe"&chan&":SEGMENT:COUNT?") )

' Read the segment listing
Dim segDataStr
segDataStr = scpi.Execute("SENSe"&chan&":SEGMENT:LIST?")
Dim segData
segData = Split(segDataStr, ",")

' Get upper bound of the array of data values
' (lower bound of array resulting from VB 'Split' function is 0)
Dim segArrayUB
segArrayUB = UBound(segData)

Dim numDataElementsPerSeg
numDataElementsPerSeg = (segArrayUB + 1) / numSegs
WScript.Echo "Number of segments = " & numSegs
WScript.Echo "Number of data values per segment = " & numDataElementsPerSeg

Dim segInfStr
segInfStr = "Segment 1: state = " & CBool(segData(0))
segInfStr = segInfStr & ", num points = " & CLng(segData(1))
segInfStr = segInfStr & ", start freq = " & CDbL(segData(2))
segInfStr = segInfStr & ", stop freq = " & CDbL(segData(3))
segInfStr = segInfStr & ", IFBW = " & CDbL(segData(4))
segInfStr = segInfStr & ", dwell time = " & CDbL(segData(5))

' In case of a measurement receiver VNA like N5264B
' which has no source ports, "SOURce:CATalog?" will
' return an empty list

```



```

Dim srcPortNames

srcPortNames = Split( scpi.Execute("SOURCE"&chan&":CATalog?"), ",")

Dim srcPortNamesUB

srcPortNamesUB = UBound(srcPortNames)

' First source port name will be preceded by a quotation mark
' and the last name will be followed by one of those, so stripping
' those off now.

srcPortNames(0) = Right( srcPortNames(0), Len(srcPortNames(0)) - 1 )

srcPortNames(srcPortNamesUB) = Left( srcPortNames(srcPortNamesUB),
InStrRev(srcPortNames(srcPortNamesUB), Chr(34)) - 1 )

Dim firstPortIndex

firstPortIndex = 6

Dim lastPortIndex

lastPortIndex = numDataElementsPerSeg - 1

Dim j

For j = firstPortIndex To lastPortIndex

    segInfStr = segInfStr & ", " & srcPortNames(j - firstPortIndex) & " power = "
& Cdbl(segData(j))

Next

WScript.Echo segInfStr

```

Example in Excel VBA with VISA-COM

```

Sub SampleSegmentSetup()
    '*** The variables of the resource manager and the instrument I/O are declared.
    Dim ioMgr As VisaComLib.ResourceManager
    Dim GPIB As VisaComLib.FormattedIO488
    '
    '    *** The memory area of the resource manager and the instrument I/O are
acquired.
    Set ioMgr = New VisaComLib.ResourceManager
    Set GPIB = New VisaComLib.FormattedIO488
    '*** Open the instrument.
    Set GPIB.IO = ioMgr.Open("GPIB0::16::INSTR")
    GPIB.IO.timeout = 10000

```

```

Dim Buf As String * 100
Dim srcPortNames As Variant
Dim numberOfSrcPorts As Integer
Dim segData As Variant
Const numSegs = 2
Const Chan = 1
Const addIFBW_PWR = 0
' In case of a measurement receiver VNA like N5264A
' which has no source ports, "SOURce:CATalog?" will
' return an empty list (just a pair of quotation marks)
GPIB.WriteString "SOURce:CATalog?", True
Buf = GPIB.ReadString
srcPortNames = Split(Buf, ",")
If Left(srcPortNames(0), 2) = Chr(34) & Chr(34) Then
    numberOfSrcPorts = 0
Else
    numberOfSrcPorts = UBound(srcPortNames) + 1
End If
' Building up a string consisting of the sweep segment data
' we want to set up. This example will create two segments.
' Set state of first segment to be ON (1 = ON, 0 = OFF),
' 101 points, start freq of 10 MHz, stop freq of 1 GHz
segData = "1,101,10E6,1E9"
' If you want to include one or more of: IFbandwidth, Dwell Time
' or Port Power, set Const addIFBW_PWR = 1

If addIFBW_PWR = 1 Then
    GPIB.WriteString "SENSe" & Chan & ":SEGment:BWIDth:CONTRol ON"
    GPIB.WriteString "SENSe" & Chan & ":SEGment:SWEep:TIME:CONTRol ON"
    GPIB.WriteString "SENSe" & Chan & ":SEGment:POWer:CONTRol ON"
    ' Turning off coupling allows power to vary per each port
    GPIB.WriteString "SOURce" & Chan & ":POWer:COUPlE OFF"
    segData = AddOptionalSettings(segData, numberOfSrcPorts)
End If

' Set state of second segment to be ON, 201 points,
' start freq of 1 GHz, stop freq of 3 GHz

segData = segData & ",1,201,1E9,3E9"

' Uncomment this line below only if you uncommented the
' AddOptionalSettings line above for the first segment.
segData = AddOptionalSettings(segData, numberOfSrcPorts)
' Upload our segment list to the channel
GPIB.WriteString "SENSe1:SEGment:LIST SSTOP," & numSegs & "," & segData
' Set segment sweep type on Channel 1
GPIB.WriteString "SENSe1:SWEep:TYPE SEGment"
' Having the PNA display the segment sweep table for the channel
GPIB.WriteString "DISPlay:WINDow1:TABLE SEGment"

'*** End procedure
GPIB.IO.Close

```

```
End Sub
Function AddOptionalSettings(ByVal pStr As String, ByVal numSrcPorts As Integer) As
String
    Dim i

    ' Specifying 1 kHz IF bandwidth and Dwell Time of 0
    pStr = pStr & ", 1E3, 0"
    ' -10 dBm power for each of the source ports
    For i = 0 To numSrcPorts - 1
        pStr = pStr & ",-10"
    Next
    AddOptionalSettings = pStr
End Function
```

Uploading a Source Power Cal using SCPI

Programming the VNA using COM or using SICL/VISA over LAN (as in this example) leaves the VNA free to control GPIB devices as needed. This Visual Basic program demonstrates:

- Uploading a source power calibration of Port 2 for Channel 1.
- Reading the calibration data.

Learn more about [Power Calibrations](#)

Other SCPI Example Programs

To run this program, you need:

- Your PC and VNA both connected to a LAN (if using VISA LAN server / client).
- The SICL and VISA components of Keysight I/O Libraries software installed on your PC (both are included when you install the software, unless you already have another vendor's VISA installed. Then specify Full SICL and VISA installation to overwrite the other vendor's VISA).
- The module visa32.bas added to your VB project.
- A form with two buttons: cmdRun and cmdQuit.
- A VISA interface configured on your remote PC to control the VNA. This could be GPIB interface or a [VISA LAN Client](#).

```
'Session to VISA Default Resource Manager
Private defRM As Long
'Session to VNA
Private viPNA As Long
'VISA function status return code
Private status As Long
Private Sub Form_Load()
defRM = 0
End Sub
Private Sub cmdRun_Click()

' String to receive data from the VNA.
' Dimensioned large enough to receive scalar comma-delimited values
' for 21 frequency points (20 ASCII characters per point)
Dim strReply As String * 420
Dim strPower As String, strCalPower As String
```

```

Dim strStimulus, strCalValue
Dim strResult As String

' Open the VISA default resource manager
status = viOpenDefaultRM(defRM)
If (status < VI_SUCCESS) Then HandleVISAError

' Open a session (viPNA) to the VNA at "address 16" on the VISA
' interface configured as "GPIB0" on this PC.
status = viOpen(defRM, "GPIB0::16::INSTR", 0, 0, viPNA)
If (status < VI_SUCCESS) Then HandleVISAError

' Set the number of sweep points to 2 on Channel 1.
status = myGPIBWrite(viPNA, "SENS1:SWE:POIN 2")
If (status < VI_SUCCESS) Then HandleVISAError

' Ensure there's currently no source power cal on for this channel and port.
status = myGPIBWrite(viPNA, "SOUR1:POW2:CORR OFF")
If (status < VI_SUCCESS) Then HandleVISAError

' Specify if the cal power level is offset (positive value for a gain, negative
' value for a loss) from the VNA port power setting on the channel when no source
' power cal is active. This is to account for components between the VNA test
' port and cal reference plane. In this example, let's set up our calibration
' at the output of an amplifier with 15 dB gain.
status = myGPIBWrite(viPNA, "SOUR1:POW2:CORR:OFFS 15 DB")
If (status < VI_SUCCESS) Then HandleVISAError

' Prepare for doing data transfer in ASCII format.
status = myGPIBWrite(viPNA, "FORM:DATA ASCII")
If (status < VI_SUCCESS) Then HandleVISAError

' Send our source power correction data to the VNA. For purpose of simplicity
' in this example, we'll set up for no correction (0) at our start stimulus and
' 0.5 dB at our stop stimulus (recall that our sweep currently has just 2 points).
status = myGPIBWrite(viPNA, "SOUR1:POW2:CORR:DATA 0,0.5")
If (status < VI_SUCCESS) Then HandleVISAError

' Set the number of sweep points to 21 on Channel 1.
status = myGPIBWrite(viPNA, "SENS1:SWE:POIN 21")
If (status < VI_SUCCESS) Then HandleVISAError

' Read the fixed power level for this port on Channel 1.
status = myGPIBWrite(viPNA, "SOUR1:POW2:LEV?")
If (status < VI_SUCCESS) Then HandleVISAError
status = myGPIBRead(viPNA, strReply)
If (status < VI_SUCCESS) Then HandleVISAError
strPower = strReply

' Turn the source power cal on.
status = myGPIBWrite(viPNA, "SOUR1:POW2:CORR ON")
If (status < VI_SUCCESS) Then HandleVISAError

```

```

' Again read the fixed power level for this port on Channel 1
' (with our calibration turned on, this should now include the 15 dB offset
' we indicated our power amplifier provides).
status = myGPIBWrite(viPNA, "SOUR1:POW2:LEV?")
If (status < VI_SUCCESS) Then HandleVISAError
status = myGPIBRead(viPNA, strReply)
If (status < VI_SUCCESS) Then HandleVISAError
strCalPower = strReply

' Read the stimulus values from Channel 1.
status = myGPIBWrite(viPNA, "SENS1:X?")
If (status < VI_SUCCESS) Then HandleVISAError
status = myGPIBRead(viPNA, strReply)
If (status < VI_SUCCESS) Then HandleVISAError

' Tokenize the reply string into an array containing the values
strStimulus = Split(strReply, ",")

' Read back the source power correction data, now interpolated for 21 points
status = myGPIBWrite(viPNA, "SOUR1:POW2:CORR:DATA?")
If (status < VI_SUCCESS) Then HandleVISAError
status = myGPIBRead(viPNA, strReply)
If (status < VI_SUCCESS) Then HandleVISAError

' Tokenize the reply string into an array containing the values
strCalValue = Split(strReply, ",")

' Print the data using a message box (here, Chr returns the ASCII characters
' for Tab (9) and Linefeed (10)).
strResult = "PNA port power = " & Val(strPower) & Chr(10)
strResult = strResult & "Power at reference plane = " & Val(strCalPower) & Chr(10)
Chr(10)
strResult = strResult & "Stimulus" & Chr(9) & Chr(9) & "Cal Value" & Chr(10)
For i = 0 To UBound(strStimulus)
    strResult = strResult & Val(strStimulus(i)) & Chr(9) & Val(strCalValue(i)) &
Chr(10)
Next
MsgBox strResult
End Sub
Private Sub cmdQuit_Click()

' Close the resource manager session (which also closes
' the session to the VNA).
If defRM <> 0 Then Call viClose(defRM)

' End the program
End
End Sub
Private Function myGPIBWrite(ByVal viHandle As Long, ByVal strOut As String) As Long

' The "+ Chr$(10)" appends an ASCII linefeed character to the

```

```

' output, for terminating the write transaction.
myGPiBWrite = viVPrintf(viHandle, strOut + Chr$(10), 0)
End Function
Private Function myGPiBRead(ByVal viHandle As Long, strIn As String) As Long
myGPiBRead = viVScanf(viHandle, "%t", strIn)

' Remove trailing linefeed character
If Right(strIn, 1) = Chr(10) Then strIn = Left(strIn, Len(strIn) - 1)
End Function
Sub HandleVISAError()
Dim strVisaErr As String * 200
Call viStatusDesc(defRM, status, strVisaErr)
MsgBox "*** Error : " + strVisaErr, vbExclamation

' Close the resource manager session (which also closes
' the session to the VNA).
If defRM <> 0 Then Call viClose(defRM)
End
End Sub

```

GPIB Fundamentals

The General Purpose Interface Bus (GPIB) is a system of hardware and software that allows you to control test equipment to make measurements quickly and accurately. This topic contains the following information:

- [The GPIB Hardware Components](#)
- [The GPIB / SCPI Programming Elements](#)
- [Specifications](#)
- [GPIB Interface Capability Codes](#)

Note: All of the topics related to programming assume that you already know how to program, preferably using a language that can control instruments.

Other Topics about GPIB Concepts

The GPIB Hardware Components

The system bus and its associated interface operations are defined by the IEEE 488 standard. The following sections list and describe the main pieces of hardware in a GPIB system:

Early VNA models had only ONE GPIB connector. These models could control other GPIB devices using one of, or a combination of, the following methods:

- Use the SCPI `SYST:COMM:GPIB:RDEV:` commands.
- Use VISA or SICL over LAN to accomplish this. See an [example](#).
- Use USB / GPIB Interface

Note: Current VNA models have dedicated Controller and Talker/Listener GPIB ports. [See how to configure these ports.](#)

Controllers

Controllers specify the instruments that will be the talker and listener in a data exchange. The controller of the bus must have a GPIB interface card to communicate on the GPIB.

- The **Active Controller** is the computer or instrument that is currently controlling data exchanges.
- The **System Controller** is the only computer or instrument that can take control and give up control of the GPIB to another computer or instrument, which is then called the active controller.

Talker / Listener Instruments and GPIB Addresses

- **Talkers** are instruments that can be addressed to send data to the controller.
- **Listeners** are instruments that can be addressed to receive a command, and then respond to the command. All devices on the bus are required to listen.

Every GPIB instrument must have its own unique address on the bus. The VNA address (default = 716) consists of two parts:

1. **The interface select code** (typically 7) indicates which GPIB port in the system controller is used to communicate with the device.
2. **The primary address** (16) is set at the factory. You can change the primary address of any device on the bus to any number between 0 and 30. To change the analyzer address click **System / Configure / SICL-GPIB**.

A **secondary address** is sometimes used to allow access to individual modules in a modular instrument system, such as a VXI mainframe. The VNA does NOT have a secondary address.

Cables

GPIB Cables are the physical link connecting all of the devices on the bus. There are eight data lines in a GPIB cable that send data from one device to another. There are also eight control lines that manage traffic on the data lines and control other interface operations.

You can connect instruments to the controller in any arrangement with the following limitations:

- Do not connect more than 15 devices on any GPIB system. This number can be extended with the use of a bus extension.
- Do not exceed a total of 20 meters of total cable length or 2 meters per device, whichever is less.
- Avoid stacking more than three connectors on the back panel of an instrument. This can cause unnecessary strain on the rear-panel connector.

The GPIB / SCPI Programming Elements

The following software programming elements combine to become a GPIB program:

- [GPIB / SCPI Commands](#)
- [Programming Statements](#)
- [Instrument Drivers](#)

GPIB Commands

The GPIB command is the basic unit of communication in a GPIB system. The analyzer responds to three types of GPIB commands:

1. IEEE 488.1 Bus-management Commands

These commands are used primarily to tell some or all of the devices on the bus to perform certain interface operations.

All of the functions that can be accomplished with these commands can also be done with IEEE 488.2 or SCPI commands. Therefore, these commands are not documented in this Help system. For a complete list of IEEE 488.1 commands refer to the IEEE 488 standard. **Examples** of IEEE 488.1 Commands

- **CLEAR** - Clears the bus of any pending operations
- **LOCAL** - Returns instruments to local operation

2. IEEE 488.2 Common Commands

These commands are sent to instruments to perform interface operations. An IEEE 488.2 common command consists of a single mnemonic and is preceded by an asterisk (*). Some of the commands have a query form which adds a "?" after the command. These commands ask the instrument for the current setting. See a complete list of the [Common Commands](#) that are recognized by the analyzer.

Examples of IEEE 488.2 Common Commands

- ***OPC** - Operation Complete
- ***RST** - Reset
- ***OPT?** - Queries the option configuration

3. SCPI Commands

The Standard Commands for Programmable Instruments (SCPI) is a set of commands developed in 1990. The standardization provided in SCPI commands helps ensure that programs written for a particular SCPI instrument are easily adapted to work with a similar SCPI instrument. SCPI commands tell instruments to do device specific functions. For example, SCPI commands could tell an instrument to make a measurement and output data to a controller. **Examples** of SCPI Commands:

CALCULATE : AVERAGE : STATE ON

SENSE : FREQUENCY : START?

For more information on SCPI:

- [The Rules and Syntax of SCPI Commands](#) provides more detail of the SCPI command structure.
- [SCPI Command Tree](#) is a complete list of the SCPI commands for the analyzer

Programming Statements

SCPI commands are included with the language specific I/O statements to form program statements. The programming language determines the syntax of the programming statements. SCPI programs can be written in a variety of programming languages such as VEE, HP BASIC, or C++. **Example** of a Visual Basic statement:

- `GPIB.Write "SOURCE:FREQUENCY:FIXED 1000 MHz"`

Note about examples

Instrument Drivers

Instrument drivers are subroutines that provide routine functionality and can be reused from program to program. GPIB industry leaders have written standards for use by programmers who develop drivers. When programmers write drivers that comply with the standards, the drivers can be used with predictable results. To comply with the standard, each instrument driver must include documentation describing its functionality and how it should be implemented.

GPIB Specifications

Interconnected devices - Up to 15 devices (maximum) on one contiguous bus.

Interconnection path - Star or linear (or mixed) bus network, up to 20 meters total transmission path length or 2 meters per device, whichever is less.

Message transfer scheme - Byte-serial, bit-parallel, asynchronous data transfer using an interlocking 3-wire handshake.

Maximum data rate - 1 megabyte per second over limited distances, 250 to 500 kilobytes per second typical maximum over a full transmission path. The devices on the bus determine the actual data rate.

Address capability - Primary addresses, 31 Talk and 31 Listen; secondary addresses, 961 Talk and 961 Listen. There can be a maximum of 1 Talker and up to 14 Listeners at a time on a single bus. See also previous section on [GPIB addresses](#).

GPIB Interface Capability Codes

The IEEE 488.1 standard requires that all GPIB compatible instruments display their interface capabilities on the rear panel using codes. The codes on the analyzer, and their related descriptions, are listed below:

SH1 full source handshake capability

AH1 full acceptor handshake capability

T6 basic talker, serial poll, no talk only, unaddress if MLA (My Listen Address)

TE0 no extended talker capability

L4 basic listener, no listen only, unaddress if MTA (My Talk Address)

LE0 no extended listener capability

SR1 full service request capability

RL1 full remote / local capability

PPO **no parallel poll capability**

DC1 full device clear capability

DT1 full device trigger capability

C1 system controller capability

C2 send IFC (Interface Clear) and take charge controller capability

C3 send REN (Remote Enable) controller capability

C4 respond to SRQ (Service Request)

The Rules and Syntax of SCPI

Most of the commands used for controlling instruments on the GPIB are SCPI commands. The following sections will help you learn to use SCPI commands in your programs.

- **Branches on the Command Tree**
- **Command and Query**
- **Multiple Commands**
- **Command Abbreviation**
- **Bracketed (Optional) Keywords**
- **Vertical Bars (Pipes)**
- **MIN and MAX Parameters**

Other Topics about GPIB Concepts

Branches on the Command Tree

All major functions on the analyzer are assigned keywords which are called ROOT commands. (See GPIB Command Finder for a list of SCPI root commands). Under these root commands are branches that contain one or more keywords. The branching continues until each analyzer function is assigned to a branch. A root command and the branches below it is sometimes known as a subsystem.

For example, under `SOURce:POWer` are several branch commands.

Sometimes the same keyword, such as `STATE`, is used in several branches of the command tree. To keep track of the current branch, the analyzer's command parser uses the following rules:

- **Power On and Reset** - After power is cycled or after `*RST`, the current path is set to the root level commands.
- **Message Terminators** - A message terminator, such as a `<NL>` character, sets the current path to the root command level. Many programming language output statements send message terminators automatically. Message terminators are described in *Sending Messages to the Analyzer*.
- **Colon (:)** - When a colon is between two command keywords, it moves the current path down one level in the command tree. For example, the colon in `:SOURCE:POWER` specifies that `POWER` is one level below `SOURCE`. When the colon is the first character of a command, it specifies that the following keyword is a root level command. For example, the colon in `:SOURCE` specifies that `source` is a root level command.

Note: You can omit the leading colon if the command is the first of a new program line. For example, the following two commands are equivalent:

```
SOUR:POW:ATT:AUTO
:SOUR:POW:ATT:AUTO
```

- **<WSP>** - Whitespace characters, such as <tab> and <space>, are generally ignored. There are two important exceptions:
 - Whitespace inside a keyword, such as `:CALC ULATE`, is not allowed.
 - Most commands end with a parameter. You must use whitespace to separate these ending parameters from commands. **Always refer to the command documentation**. In the following example, there is whitespace between `STATE` and `ON`.

```
CALCULATE1:SMOOTHING:STATE ON
```

- **Comma (,)** - If a command requires more than one parameter, you must separate adjacent parameters using a comma. For example, the `SYSTEM:TIME` command requires three values to set the analyzer clock: one for hours, one for minutes, and one for seconds. A message to set the clock to 8:45 AM would be `SYSTEM:TIME 8,45,0`. Commas do not affect the current path.
- **Semicolon(;** - A semicolon separates two commands in the same message without changing the current path. See [Multiple Commands](#) later in this topic.
- **IEEE 488.2 Common Commands** - Common commands, such as `*RST`, are not part of any subsystem. An instrument interprets them in the same way, regardless of the current path setting.

Command and Query

A SCPI command can be an Event command, Query command (a command that asks the analyzer for information), or both. The following are descriptions and examples of each form of command. GPIB Command Finder lists every SCPI command that is recognized by the analyzer, and its form.

Form

Event commands - cause an action to occur inside the analyzer.

Query commands - query only; there is no associated analyzer state to set.

Command and query - set or query an analyzer setting. The query form appends a question mark (?) to the set form

Examples

```
:INITIATE:IMMEDIATE
```

```
:SYSTEM:ERROR?
```

```
:FORMat:DATA ! Command
:FORMat:DATA? ! Query
```

Multiple Commands

You can send multiple commands within a single program message. By separating the commands with semicolons the current path does not change. The following examples show three methods to send two commands:

1. Two program messages:

```
SOURCE:POWER:START 0DBM
SOURCE:POWER:STOP 10DBM
```

2. One long message.

A colon follows the semicolon that separates the two commands causing the command parser to reset to the root of the command tree. As a result, the next command is only valid if it includes the entire keyword path from the root of the tree:

```
SOURCE:POWER:START 0DBM;:SOURCE:POWER:STOP 10DBM
```

3. One short message.

The command parser keeps track of the position in the command tree. Therefore, you can simplify your program messages by including only the keyword at the same level in the command tree.

```
SOURCE:POWER:START 0DBM;STOP 10DBM
```

Common Commands and SCPI Commands

You can send Common commands and SCPI commands together in the same message. (For more information on these types of commands see [GP-IB Fundamentals](#).) As in sending multiple SCPI commands, you must separate them with a semicolon.

Example of Common command and SCPI commands together

```
*RST;SENSE:FREQUENCY:CENTER 5MHZ;SPAN 100KHZ
```

Command Abbreviation

Each command has a long form and an abbreviated short form. The syntax used in this Help system use uppercase characters to identify the short form of a particular keyword. The remainder of the keyword is lower case to complete the long form.

```
SOUR - Short form
SOURce - Long form
```

Either the complete short form or complete long form must be used for each keyword. However, the keywords used to make a complete SCPI command can be a combination of short form and long form.

The following is **unacceptable** - The first three keywords use neither short or long form.

```
SOURc:PowE:Atten:Auto on
```

The following is **acceptable** - All keywords are either short form or long form.

```
SOUR:POWer:ATT:AUTO on
```

In addition, the analyzer accepts lowercase and uppercase characters as equivalent as shown in the following equivalent commands:

```
source:POW:att:auto ON  
Source:Pow:Att:Auto on
```

Optional [Bracketed] Keywords

You can omit some keywords without changing the effect of the command. These optional, or default, keywords are used in many subsystems and are identified by brackets in syntax diagrams.

Example of Optional Keywords

The HCO_Py subsystem contains the optional keyword IMMEDIATE at its first branching point. Both of the following commands are equivalent:

```
"HCOPY:IMMEDIATE"  
"HCOPY"  
The syntax in this Help system looks like this:  
HCOPY[:IMMEDIATE]
```

Vertical Bars | Pipes

Vertical bars, or "pipes", can be read as "**or**". They are used in syntax diagrams to separate alternative parameter options.

Example of Vertical Bars:

```
SOURce:POWer:ATTenuation:AUTO <on|off>
```

Either ON or OFF is a valid parameter option.

MIN and MAX Parameters

The special form parameters "MINimum" and "MAXimum" can be used with commands that specify single frequency (Hz) and time (seconds) as noted in the command documentation. **Note:** Also with these commands, KHZ, MHZ, and GHZ are accepted as suffixes/units.

The short form (min) and long form (minimum) of these two keywords are equivalent.

- **MAX**imum refers to the largest value that the function can currently be set to
- **MIN**imum refers to the smallest value that the function can currently be set to.

For example, the following command sets the start frequency to the smallest value that is currently possible:

```
SENS:FREQ:START MIN
```

In addition, the max and min values can also be queried for these commands.

For example, the following command returns the smallest value that Start Frequency can currently be set to:

```
SENS:FREQ:START? MIN
```

An error will be returned if a numeric parameter is sent that exceeds the MAX and MIN values.

For example, the following command will return an "Out of range" error message.

```
SENS:FREQ:START 1khz
```

Configure for GPIB, SCPI, and SICL

The following settings are used to configure the analyzer for remote control using SCPI commands.

How to Configure for SICL / GPIB Operation

Using **Hardkey/SoftTab/Softkey**

1. Press **System** > **System Setup** > **Remote Interface....**

Using a mouse

1. Click **Utility**
2. Select **System**
3. Select **System Setup**
4. Select **Remote Interface...**

◀ Programming Commands ▶

SICL / GPIB dialog box help

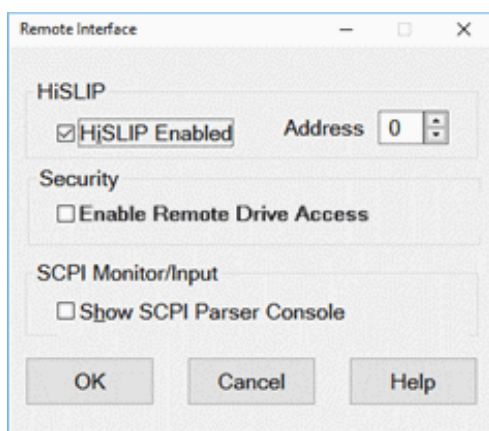

HiSLIP

HiSLIP is available ONLY when the soft front panel has already been launched.

When checked, the VNA will also advertise itself using port TCPIP port 4880. You must configure your firewall to enable communication through this port. You can connect to the module and send SCPI commands by using the VISA address:

TCPIP0::<PXI controller name >::hislip0::INSTR. ("hislip" is case-sensitive)

For example, if your controller is named: myPC, then the TCPIP connection string would be:

```
TCPIP0::myPC::hislip0::INSTR
```

When running locally, then replace <PXI controller name> with "Localhost". For example:

```
TCPIP0::Localhost::hislip0::INSTR
```

Security

Enable Remote Drive Access When checked allows access to the hard disk. The default is unchecked. When unchecked, hard disk access is blocked and any of the following commands will return an error:

MMEM:CAT:FILE?

MMEM:CAT:STAT?

MMEM:CAT:CStAte?

MMEM:CAT:CSARchive?

MMEM:CAT:CORRection?

MMEM:CDIR?

MMEM:COpy

MMEM:DELeTe

MMEM:MOVE

MMEM:MDIRectory

MMEM:RDIRectory

MMEM:TRANsfer[?]

SYST:SHORcut:EXECute

SCPI Monitor / Input

Show SCPI Parser Console Launches a window that is used to send single SCPI/GPIB commands from the analyzer keyboard. This window can also be used to capture the SCPI traffic used over HiSLIP.

- Type a valid command, with appropriate arguments and press enter.

- Use the arrow keys to recall previous commands.

Local and Remote Operation

The analyzer **LCL** and **RMT** (Local and Remote) operation labels appear in the lower right corner of the status bar.

Note: The status bar is NOT visible when the analyzer is preset. See [how to make the status bar visible](#).

- **LCL** appears when NOT under SCPI control
- **RMT** appears when under SCPI control. The RMT label does NOT appear when under COM control. Remote operation disables the front panel keys except for the **Macro/Local** key.

To return to Local (front panel) operation, press the Macro / Local key

Sending the GPIB "GTL" (go to local) command also returns the analyzer to Local operation.

Sending the GPIB "LLO" (local lockout) command disables the front panel Local button.

Getting Data from the Analyzer

Data is sent from the analyzer in response to program queries. Data can be short response messages, such as analyzer settings, or large blocks of measurement data. This topic discusses how to read query responses and measurement data from the analyzer in the most efficient manner.

- [Response Message Syntax](#)
- [Clearing the Output Queue](#)
- [Response Data Types](#)
- [Transferring Measurement Data](#)

Note: Some PCs use a modification of the IEEE floating point formats with the byte order reversed. To reverse the byte order for data transfer into a PC, use the `FORMat:BORDer` command.

Other Topics about GPIB Concepts

Response Message Syntax

Responses sent from the analyzer contain data, appropriate punctuation, and message terminators.

<NL><^END> is always sent as a response message terminator. Most programming languages handle these terminators transparent to the programmer.

Response messages use commas and semicolons as separators in the following situations:

- a comma separates response data items when a single query command returns multiple values

```
FORM:DATA? 'Query  
ASC, +0 'Analyzer Response
```

- a semicolon separates response data when multiple queries are sent within the same messages

```
SENS:FREQ:STAR?;STOP? --Example Query
```

```
+1.23000000000E+008; +7.89000000000E+008<NL><^END> 'Analyzer Response
```

Clearing the Output Queue

After receiving a query, the analyzer places the response message in its output queue. Your program should read the response immediately after the query is sent. This ensures that the response is not cleared before it is read. The response is cleared when one of the following conditions occur:

- When the query is not properly terminated with an ASCII carriage return character or the GPIB <^END> message.
- When a second program query is sent.
- When a program message is sent that exceeds the length of the input queue
- When a response message generates more response data than fits in the output queue.
- When the analyzer is switched ON.

Response Data Types

The analyzer sends different response data types depending on the parameter being queried. You need to know the type of data that will be returned so that you can declare the appropriate type of variable to accept the data. For more information on declaring variables see your programming language manual. The GPIB Command Finder lists every GPIB command and the return format of data in response to a query. The analyzer returns the following types of data:

- **Numeric Data**
- **Character Data**
- **String Data**
- **Block Data**

Numeric Data

All numeric data sent over the GPIB is ASCII character data. Your programming environment may convert the character data to numeric data for you. Boolean data (1 | 0) is a type of numeric data.

Character Data

Character data consists of ASCII characters grouped together in mnemonics that represent specific analyzer settings. The analyzer always returns the short form of the mnemonic in upper-case alpha characters. Character data looks like string data. Therefore, refer to the GPIB Command Finder to determine the return format for every command that can be queried.

Example of Character Data

MLOG

String Data

String data consists of ASCII characters. String parameters can contain virtually any set of ASCII characters. When sending string data to the analyzer, the string **must** begin with a single quote (') or a double quote (") and end with the same character (called the delimiter).

Note: The analyzer responds best to all special characters if the string is enclosed in single quotes. If quotes are not used, the analyzer will convert the text to uppercase. The analyzer may not respond as you expect.

The analyzer always encloses data in double quotes when it returns string data.

Example of String Data

```
 GPIB.Write "DISP:WINDow:TITLe:DATA?"
```

```
"This is string response data."
```

Block Data

Block data is used to transfer measurement data. Although the analyzer will accept either definite length blocks or indefinite length blocks, it always returns definite length block data in response to queries unless the specified format is ASCII. The following graphic shows the syntax for definite block data:

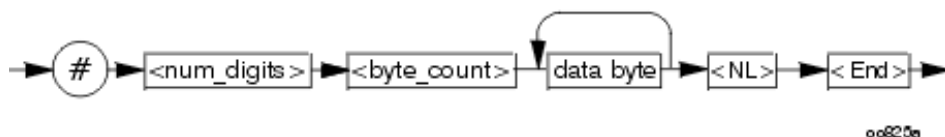

<num_digits> specifies how many digits are contained in <byte_count>

<byte_count> specifies how many data bytes will follow in <data bytes>

Example of Definite Block Data

```
#210ABCDE+WXYZ<nl><end>
```

Where:

- always sent before definite block data

2 - specifies that the byte count is two digits (2)

10 - specifies the number of data bytes that will follow, not counting <NL><END>

ABCDE+WXYZ - 10 digits of data

<NL><END> - always sent at the end of block data

Transferring Measurement Data

Measurement data is blocks of numbers that result from an analyzer measurement. Measurement data is available from various processing arrays within the analyzer. For more information on the analyzer's data processing flow, see [Accessing Data Map](#). Regardless of which measurement array is read, transferring measurement data is done the same.

See an example.

When transferring measurement data, the `FORMat:DATA` command allows you to choose from the following two data types:

- REAL
- ASCII

The following graphic shows the differences in transfer times between the two:

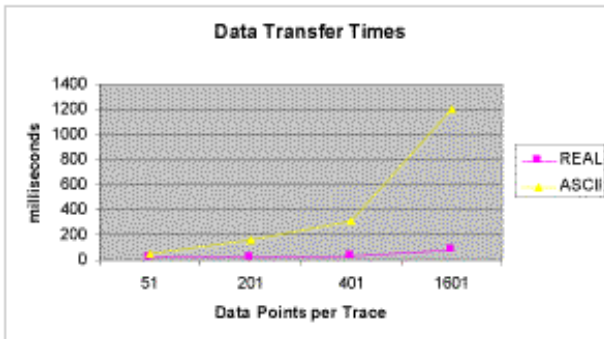

REAL Data

REAL data (also called floating-point data) types transfer faster. This is because REAL data is binary and takes about half the space of ASCII data. The disadvantage of using REAL data is that it requires a header that must be read. See [definite length block data](#). The binary floating-point formats are defined in the IEEE 754-1985 standard. The following choices are available in REAL format:

- **REAL,32** - IEEE 32-bit format - single precision (not supported by HP BASIC)
- **REAL,64** - IEEE 64-bit format - double precision

ASCII Data

The easiest and slowest way to transfer measurement data is to use ASCII data. ASCII data is sent if the

data contains both numbers and characters (the setting of FORMat:DATA is ignored). ASCII data is separated by commas.

Synchronizing the VNA and Controller

Synchronizing the VNA (Vector Network Analyzer) and Controller means to keep VNA and the controller working at approximately the same pace. In this topic:

- [The Problem and the Solution](#)
- [VNA Queues](#)
- [Synchronization Methods](#)
- [When To Synchronize the Analyzer and Controller](#)
 - [Completion of a Measurement](#)
 - [Measurements with External Trigger](#)
 - [Averaged Measurements](#)
 - [During Calibration Acquire](#)

See Also

- [Synchronize an External PSG Source](#)
- [Triggering the VNA using SCPI](#)

The Problem

The controller sends commands to the VNA as fast as the bus will allow. The VNA stores these commands in the VNA **Input queue**. However, the VNA executes those commands at a slower rate than they are accepted. If left unchecked, the VNA input buffer will contain a long list of commands waiting to be executed.

At some point, the controller will send a query command which requires a response from the VNA. The controller will not send more commands until a response is received. It will wait for a response from the VNA for the amount of time set by the Timeout setting. If the VNA is working off a long list of commands in the input buffer, it may not execute and respond to the query command until the controller has quit waiting, or "timed out".

The Solution

The easiest way to keep the controller and the VNA "synched" is to send query commands often. This

stops the controller from sending more commands until the VNA executes and responds to the query. This limits the number of commands that are waiting in the VNA input queue to be processed.

Although any query will stop the controller from sending more commands, a good practice is to send ***OPC?** Most of the time, as soon as this query is executed, the VNA will immediately reply. The exception to this is the Overlapped command.

- **Sequential** commands are executed quickly and in the order in which they are received.
- **Overlapped** (also known as Asynchronous) commands take longer to execute. Therefore, they allow the VNA to execute other commands while waiting. However, the programmer may want to prevent the analyzer from processing new commands until the overlapped command has completed. If the VNA is executing an overlapped command when a ***OPC?** is received, it will wait until the overlapped command is complete before processing new commands.

Note: The analyzer has two overlapped commands:

- **INITiate:IMMediate**
- **SENSe:SWEp:MODE GROUPS** (when INIT:CONT is ON)

Several calibration commands have an optional ASYNchronous argument which allows them to behave like overlapped commands. [Learn more.](#)

Analyzer Queues

Queues are memory buffers that store messages until they can be processed. The analyzer has the following queues:

- **Input Queue**
- **Output Queue**
- **Error Queue**

Input Queue

The controller sends statements to the analyzer without regard to the amount of time required to execute the statements. The input queue is very large (31k bytes). It temporarily stores commands and queries from the controller until they are read by the analyzer's command parser. The input queue is cleared when the analyzer is switched ON.

Output Queue

When the analyzer parses a query, the response is placed in the output queue until the controller reads

it. Your program should immediately read the response or it may be cleared from the output queue. The following conditions will clear a query response:

- When a second query is sent before reading the response to the first. This does not apply when multiple queries are sent in the same statement.
- When a program statement is sent that exceeds the length of the input queue.
- When a response statement generates more data than fits in the output queue.
- When the analyzer is switched ON.

Error Queue

Each time the analyzer detects an error, it places a message in the error queue. When the `SYSTEM:ERROR?` query is sent, one message is moved from the error queue to the output queue so it can be read by the controller. Error messages are delivered to the output queue in the order they were received. The error queue is cleared when any of the following conditions occur:

- When the analyzer is switched ON.
- When the `*CLS` command is sent to the analyzer.
- When all of the errors are read.

If the error queue overflows, the last error is replaced with a "Queue Overflow" error. The oldest errors remain in the queue and the most recent error is discarded.

Synchronization Methods

The following common commands are used to synchronize the analyzer and controller. Examples are included that illustrate the use of each command in a program. See the SCPI command details to determine if a command is an overlapped command.

- `*WAI`
- `*OPC?`
- `*OPC`

*WAI

The `*WAI` command:

- **Stops the analyzer** from processing subsequent commands until all overlapped commands are completed.
- **It does NOT stop the controller** from sending commands to this and other devices on the bus. This is the easiest method of synchronization.

Example of the *WAI command

```
"ABORT ; INITIATE : IMMEDIATE" 'Restart the measurement.
"CALCULATE : MARKER : SEARCH : MAXIMUM" 'Search for max amplitude.
"CALCULATE : MARKER : X?" 'Which frequency?
```

The following time line shows how the processing times of the three commands relate to each other:

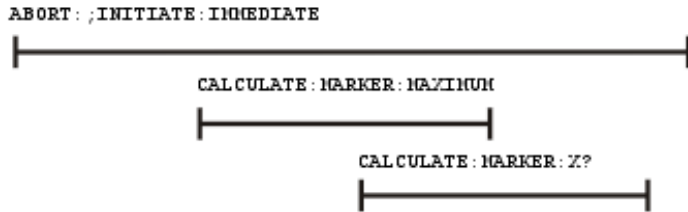

INITIATE : IMMEDIATE is an overlapped command. It allows the immediate processing of the sequential command, CALCULATE : MARKER : SEARCH : MAXIMUM. However, the INITIATE : IMMEDIATE is not considered complete until the measurement is complete. Therefore, the marker searches for maximum amplitude before the measurement completes. **The CALCULATE : MARKER : X? query could return an inaccurate value.**

To solve the problem, insert a *WAI command.

```
"ABORT ; INITIATE : IMMEDIATE" 'Restart the measurement.
"*WAI" 'Wait until complete.
"CALCULATE : MARKER : MAXIMUM" 'Search for max amplitude.
"CALCULATE : MARKER : X?" 'Which frequency
```

The time line now looks like this:

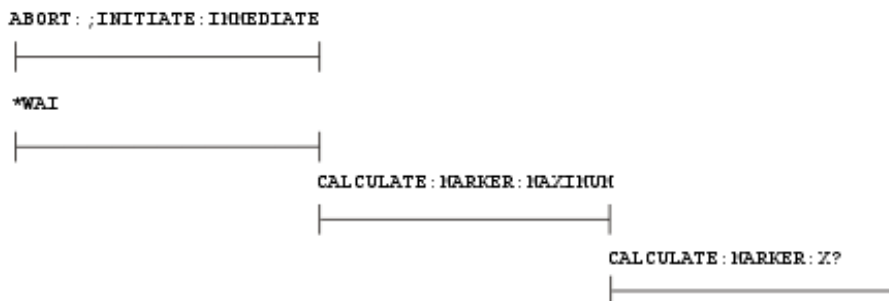

The *WAI command keeps the MARKER : SEARCH : MAXIMUM from taking place until the measurement is completed. The CALCULATE : MARKER : X? query returns the correct value.

Note: Although *WAI stops the analyzer from processing subsequent commands, it does not stop the controller. The controller could send commands to other devices on the bus.

*OPC?

The *OPC? query stops the controller until all pending commands are completed.

In the following example, the **Read** statement following the *OPC? query will not complete until the analyzer responds, which will not happen until all pending commands have finished. Therefore, the analyzer and other devices receive no subsequent commands. A "1" is placed in the analyzer output queue when the analyzer completes processing an overlapped command. The "1" in the output queue satisfies the **Read** command and the program continues.

Example of the *OPC? query

This program determines which frequency contains the maximum amplitude.

```
"ABORT; :INITIATE:IMMEDIATE"! Restart the measurement
"*OPC?" 'Wait until complete
Meas_done = GPIB.Read 'Read output queue, throw away result
"CALCULATE:MARKER:MAX" 'Search for max amplitude
"CALCULATE:MARKER:X?" 'Which frequency?
Marker_x = GPIB.Read
PRINT "MARKER at " & Marker_x & " Hz"
```

*OPC

The *OPC command allows the analyzer and the controller to process commands while processing the overlapped command.

When the analyzer completes processing an overlapped command, the *OPC command sets bit 0 of the standard event register to 1. This requires polling of status bytes or use of the service request (SRQ) capabilities of your controller. See [Reading the Analyzer's Status Registers](#) for more information about the standard event status register, generating SRQs, and handling interrupts.

Note: Be careful when sending commands to the analyzer between the time you send *OPC and the time you receive the interrupt. Some commands could jeopardize the integrity of your measurement. It also could affect how the instrument responds to the previously sent *OPC.

Example of polled bit and SRQ processes.

When To Synchronize the Analyzer and Controller

The need to synchronize depends upon the situation in which the overlapped command is executed. The following section describes situations when synchronization is required to ensure a successful

operation.

- [Completion of a Measurement](#)
- [Measurements with External Trigger](#)
- [Averaged Measurements](#)

Completion of a Measurement

To synchronize the analyzer and controller to the completion of a measurement, use the `ABORT ; INITIATE : IMMEDIATE` command sequence to initiate the measurement.

This command sequence forces data collection to start (or restart) under the current measurement configuration. A restart sequence, such as `ABORT ; INITIATE : IMMEDIATE` is an overlapped command. It is complete when all operations initiated by that restart command sequence, including the measurement, are finished. The `*WAI`, `*OPC?` and `*OPC` commands allow you to determine when a measurement is complete. This ensures that valid measurement data is available for further processing.

Measurements with External Trigger

See [Triggering the VNA using SCPI](#).

External Triggering

Averaged Measurements

Averaged measurements are complete when the average count is reached. The average count is reached when the specified number of individual measurements is combined into one averaged measurement result. Use synchronization to determine when the average count has been reached.

If the analyzer continues to measure and average the results after the average count is reached, use synchronization to determine when each subsequent measurement is complete.

During Calibration Acquire

During a calibration with slow sweep speeds, such as when using a narrow IF bandwidth, you may want to have your program perform other operations, such as checking for the click event of a Cancel button.

To do this, use the optional `ASYNchronous` argument with the `ACQUIRE` command as shown in several calibration example programs. The VNA parser returns immediately while the cal step measurement proceeds. It does NOT block commands and wait for the measurement step to finish. You can send `*ESR?` or `*STB?` queries to monitor the status register bytes to see when the OPC (operation complete) bit gets set, which indicates the cal measurement step has finished. Learn more about [status registers](#).

Note: Do NOT issue the *OPC? command when using the ASYN argument. If your program is using the ScpiStringParser, then you can ONLY use *OPC? to detect when the OPC bit is set, so do NOT use the ASYN argument with the calibration commands when using that parser.

When using the ASYN argument, set the timeout value in the IO settings to at least 5 seconds. There are intervals during the cal acquires when the VNA takes a several seconds to respond to additional commands, such as when the processor is calculating error terms.

The following commands have this argument:

Command	Example
<code>SENS:CORR:COLL:GUID:ACQUIRE</code> (Guided Cal)	Guided 2-Port or 4-Port Cal
<code>SENS:CORR:COLL:ACQUIRE</code> (Unguided Cal)	Perform Unguided ECAL
<code>SOUR:POW:CORR:COLL:ACQUIRE</code> (Source Power Cal)	Perform a Source and Receiver Power Cal (shows polling loop)

In addition, the `SENS:CORR:COLL:GUIDed:INITialize` command has this optional argument for long calibration initialization, such as a `CalAll` calibration.

Calibrating the Analyzer Using SCPI

There are several ways to calibrate the analyzer using SCPI depending on your measurement needs. As from the Cal Wizard, you can perform a Guided Cal, Unguided Cal, or ECal. This topic explains the differences in these calibration choices when using SCPI commands.

- [Guided Calibrations](#)
- [ECal](#)
- [Creating Cal Sets](#)
- [Applying Cal Sets and Cal Types](#)
- [Uploading Error Terms](#)
- [Unguided Cals and Calibration Classes](#)

Note: ALWAYS send ALL measurement setup commands BEFORE initializing a remote calibration.

See Also

[Synchronizing the Analyzer and Controller \(During a calibration\)](#)

[See SCPI Calibration Examples](#)

Guided Calibrations

Guided versus Unguided is the style of calibration that is selected on the first page of the [Calibration Wizard](#). A remote 'guided' cal does not present the cal wizard, but prompts for specific standards to be connected. In a remote 'Unguided', the steps must be 'hard-coded'.

- To perform a **Guided Calibration**, use ONLY [Sens:Corr:Coll:Guided](#) commands.
- These commands calibrate the ACTIVE channel. Activate a channel by selecting a measurement on the channel to be calibrated using [Calc:Par:Select](#).
- Full 1,2,3,4-port SOLT and TRL calibrations - No response cals.
- All of the advanced calibration features (Thru method, specify DUT connectors and Cal kits for each port, port pairings).
- A Cal Set is applied to the channel and saved at the completion of a guided cal according to the preference

setting **SENS:CORR:PREF:CSET:SAVE**

Note: To perform an **Unguided Calibration**, use ONLY the **Sens:Corr** commands (NOT Guided).

ECal

From the Cal Wizard or from a SCPI program, ECal is fast, accurate, and very repeatable. Unlike from the Cal Wizard, you can use SCPI to perform ECal using either the Guided or Unguided commands. The Unguided commands are easiest to use. However, the following situations require that you use the Guided commands.

- To maximize accuracy, all ECal calibrations on the analyzer perform an Unknown Thru measurement of the ECal module Thru state **IF** the analyzer model being used has **1 reference receiver per port**. If your analyzer does NOT have 1 reference receiver per port, use Guided ECal commands and specify a Thru method.
- If your ECal module connectors do NOT match the DUT connectors, and you choose not to perform a User Characterization, use Guided ECal commands and specify the Thru method.

ECAL Notes:

- When using either Guided or Unguided ECal commands under low power situations, use the Orientation settings. The Guided example shows the use of these commands. When using Unguided, they must appear before the Acquire command.
- The frequency range of the measurement must be within the range of the ECal module. Otherwise, the calibration will fail.
- You do NOT have to send the ECal module state 'switch' commands. The ECal algorithm switches ECal states automatically.
- All of these ECal choices are listed in the **Programming Command Finder** function in this Help file.

See **Using ECal** to learn about all of the ECal features.

Creating Cal Sets

There are several ways to store guided cal data into a unique Cal Set. The following is probably the easiest. It does not require the name of an existing Cal Set and it allows you to name the Cal Set.

```
SENS:CORR:COLL:GUID:INIT 'start the cal with no cal set argument
'Perform the cal
SENS:CORR:COLL:GUID:SAVE 'create cal set with auto-generated name or to cal
register
SENS:CORR:CSET:NAME 'MyCalSet' 'name the current cal set.
```

Applying Cal Sets and Cal Types

A Cal Set is applied to the channel and saved at the completion of a guided cal according to the preference setting `SENS:CORR:PREF:CSET:SAVE`.

When you select a Cal Set to apply to an uncalibrated channel, the analyzer attempts to find the most comprehensive calibration type in the Cal Set and turn it ON. In addition, changing a measurement parameter (for example, from S11 to S21) will also initiate an attempt to apply the best Cal Type and turn correction ON.

There may be times when you do not want the most comprehensive Cal Type. For example, say there is a Full 2-port Cal Set applied, but there is only an S11 measurement displayed. If measurement speed is a concern, you can apply a Full 1-Port Cal Type from that same Cal Set and save time by not doing the extra background sweeps. [Learn more about background sweeps.](#)

If you change the measurement parameter, the analyzer will reapply the Full 2-Port Cal Type.

See the SCPI and COM commands for [Cal Sets](#) and [Cal Types](#).

Uploading Error Terms

Note: There was a method described here for WinCal 3.x that involved a [preference setting](#). That method is no longer supported.

To upload error terms into a created or selected Cal Set:

```
SENS:CORR:CSET:CREate or SENS:CORR:CSET:GUID
SENS:CORR:CSET:Data <term> <port> <port> <data>
SENS:CORR:CSET:SAVE
```

This method puts error terms into a Cal Set, outside of a Guided or Unguided calibration session.

The Cal Set can then be applied at any time.

See `SENS:CORR:CSET` commands.

Unguided Cals and Calibration Classes

- Use **Sens:Correction** commands.
- 1-port, 2-port, Response.
- Can select 2 sets of standards.
- TRL is NOT recommended.

The following describes how to perform an unguided calibration using SCPI. The objective here is to make clear the relationship between the physical port on which a standard is being measured, the actual device in the cal kit, and the SCPI command used to acquire the device.

Calibration standards classes are ‘categories’ of standard types. To perform a 2 port calibration, the cal wizard requires the following types of standards to be measured:

3 reflection standards on the forward port:

- Class S11A typically an open
- Class S11B typically a short
- Class S11C typically a load

Likewise, 3 reflection standards are required for the reverse port:

- Class S22A typically an open
- Class S22B typically a short
- Class S22C typically a load

There is also a transmission standard that is measured in both directions:

- Class S21T typically a thru

The following illustrates the relationship between cal kit physical standards and calibration classes. Here is a list of the physical devices in my calibration kit.

Standard #1 = "3.5 mm male short"

Standard #2 = "3.5 mm male open"

Standard #3 = "3.5 mm male broadband load"

Standard #4 = "Insertable thru standard"
 Standard #5 = "3.5 mm male sliding load"
 Standard #6 = "3.5 mm male lowband load"
 Standard #7 = "3.5 mm female short"
 Standard #8 = "female to female characterized thru adapter"
 Standard #9 = "0-2 Load"
 Standard #10 = "Open"
 Standard #11 = "Non-insertable thru"
 Standard #12 = "3.5 mm female lowband load"
 Standard #13 = "3.5 mm female sliding load"
 Standard #14 = "3.5 mm female broadband load"
 Standard #15 = "3.5 mm female open"

When you perform a calibration remotely using SCPI, you don't specify the device number directly. Rather, you specify the class you want to measure. Each device in the calibration kit is assigned to a class. And since more than one device can be assigned to the same class, each class contains an ordered list of devices. The class assignments are set using the Advanced Modify Cal Kit dialog or the SCPI command:

SENS:CORR:COLL:CKIT:ORDer<class>, <std>, <std>, <std>, <std>, <std>, <std>, <std>

The 85052B kit used in the example program has the following standard list for each class: The list was obtained by issuing the corresponding SCPI query:

SENS:CORR:COLL:CKIT:OLIST1? S11A = +2,+15,+0,+0,+0,+0,+0
SENS:CORR:COLL:CKIT:OLIST2? S11B = +1,+7,+0,+0,+0,+0,+0
SENS:CORR:COLL:CKIT:OLIST3? S11C = +6,+5,+3,+12,+13,+14,+0
SENS:CORR:COLL:CKIT:OLIST4? S21T = +4,+8,+0,+0,+0,+0,+0
SENS:CORR:COLL:CKIT:OLIST5? S22A = +2,+15,+0,+0,+0,+0,+0
SENS:CORR:COLL:CKIT:OLIST6? S22B = +1,+7,+0,+0,+0,+0,+0

SENS:CORR:COLL:CKIT:OLIST7? S22C = +6,+5,+3,+12,+13,+14,+0

SENS:CORR:COLL:CKIT:OLIST8? S12T = +4,+8,+0,+0,+0,+0,+0

When you perform the calibration, you acquire data by issuing the ACQUIRE command:

SENS:CORR:COLL:ACQ <class>[, <subst>]

For example:

SENS:CORR:COLL:SFOR 1

SENS:CORR:COLL:ACQ STANA, SST2

The SFOR command tells the wizard to make the next acquisition in the forward direction. The ACQUIRE command specifies that we are measuring the 2nd device in the list for STANA. And since we are measuring SFORward, then STANA refers to class #1 or S11A. The list of devices for this class are specified in the OLIST1 query above.

Alternately, you could modify the device order for the S11A class to move device #15 into the first position (SENS:CORR:COLL:CKIT:ORDER1). When the desired device is in the first position, you need not specify the order number in the ACQUIRE command. The default is the first device in the OLIST. This works well for two port network analyzers where the order for S11A,B,C classes is set up for port 1 and the order for S22A,B,C is set up for port 2. With the kit set up in the proper order, you eliminate the need to specify the substandard number (SST<n>).

See an example: Perform an Unguided 2-port Cal on a 4-port analyzer.

Reading the Analyzer's Status Register

The VNA has several status registers that your program can read to know when specific events occur. There are two methods of reading the status registers in the analyzer: the Polled Bit method and the Service Request method.

- [The Status Registers](#)
- [Setting and Reading Bits in Status Registers](#)
- [Polled Bit Method](#)
- [Service Request Method](#)

See Also

[IEE 482 Common commands](#)

[Example: Status Reporting](#)

[Status Commands](#)

Other Topics about GPIB Concepts

Important Notes:

- A new [Limit Line Fail command](#) that makes it easy to determine if Limit Line testing has failed.
- [*OPC?](#) can be used to easily determine when a channel has completed a sweep. This requires no interaction with the Status Register system. Most [VNA programming examples](#) use [*OPC?](#).
- Most of the Status Register system can NOT be used with the SCPIStringParser Object. However, [*OPC?](#) can be used.

The Status Registers

Most of the status registers in the analyzer have sixteen bits. For simplicity, this topic will illustrate their use with 8-bit registers. Bits in registers represent the status of different conditions inside of the analyzer. In the following graphic, a register is represented by a row of boxes; each box represents a bit. Bit 3 is ON.

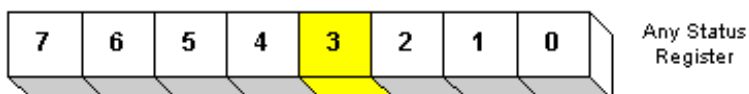

Each VNA Status Register is actually comprised of the following registers. [See an image of the VNA Status registers.](#)

- **Enable Registers** - When using the [SRQ method of polling](#), you first set bits in the enable register which tells the VNA which events to monitor. This is not necessary using the [Polled Bit method](#), as you can only monitor a single event. A *CLS (clear status) command will not clear the enable register. The *ESE and *ESE? commands are used to set and query Enable bits, while *ESR is used to read and clear an Enable register. [Learn how to set bits.](#)
- **Condition Registers** - A condition register continuously monitors events in the VNA. Bits in the condition register change real time as conditions occur. These bits are not latched, so this register is used mainly for diagnostic purposes. The registers that only summarize lower level registers do NOT have a condition register.
- **Event Registers** - This is the register that is read to determine if an event has occurred. An event register latches the bits from the corresponding condition register. When an event register bit is set, subsequent changes to the corresponding condition register bit are ignored. The bit remains set until a query command such as *CLS clears the bit. [Learn how to read the Event Register.](#)
- **Positive and Negative Transition Registers** - Transition registers control what type of condition register will set the corresponding bit in the event register.
 - **Positive** transitions (**0 to 1**) are only reported to the event register if the corresponding positive transition bit is set to 1.
 - **Negative** transitions (**1 to 0**) are only reported to the event register if the corresponding negative transition bit is set to 1.
 - Setting **both** transition bits to 1 causes both **positive and negative** transitions to be reported.

Transition registers are read-write and are unaffected by *CLS (clear status) or queries. They are reset to their default settings at power-up and after *RST and SYSTEM:PRESet commands. The **following are the default settings** for the transition registers:

- All Positive Transition registers = 1
- All Negative Transition registers = 0

This means that, by default, the analyzer will latch all event registers on the negative to positive transition (0 to 1).

The following is an example of why you would set transition registers:

A critical measurement requires that you average 10 measurements and then restart averaging. You decide to poll the averaging bit. When averaging is complete, the bit makes a positive transition. After restart, you poll the bit to ensure that it is set back from 1 to 0, a negative

transition. You set the negative transition bit for the averaging register.

Setting and Reading Bits in Status Registers

Both the Polled-Bit method and Service Request method require that you set and read status register bits. Most of the VNA status registers contain 16 bits, numbered 0 to 15. Each bit has a weighted value. The following example shows how to set the bits in a 8-bit status register.

8-bit register

Bit	0	1	2	3	4	5	6	7
Weight	1	2	4	8	16	32	64	128

How to set bits 4 and 5 in the Standard Event Status Enable register:

Step	Example
1. Determine the weighted bit value for these weights 16 and 32 (respectively) bits	
2. Add these values together	$16 + 32 = 48$
3. Send this number as an argument in the appropriate command. (see Status Commands)	STAT:QUES:LIMIT1:ENAB 48

The Polled Bit Method

With the Polled Bit Method, your program monitors a bit in the status register that represents the condition of interest to you. When the VNA sets the bit to 1, your program sees it and responds accordingly.

- If your program **periodically** monitors a bit in the status register, it is free to do other things as well. However, your program can respond only as fast as the bit is polled.
- If your program **continually** monitors a bit, it can respond immediately, but will be unavailable to do anything other than poll the bit.

Advantage: This method requires very little programming.

Procedure:

1. Decide which condition to monitor. The [Status Commands](#) topic lists all of the possible conditions that can be monitored in the analyzer.
2. Determine the command to be used to monitor the bit.

3. Determine how often to poll the bit until it is set.
4. Construct the routine to respond when the bit is set.

The Service Request (SRQ) Method

Your program enables the bits in the status registers representing the condition of interest. When the condition occurs, the VNA actively interrupts your program from whatever it is doing, and an event handler in your program responds accordingly. Do this method if you have several conditions you want to monitor or the conditions are such that it is not practical to wait for the condition to occur.

Advantage: This method frees your program to do other things until the condition occurs. The program is interrupted to respond to the condition.

Disadvantage: This method can require extensive programming depending on the number and type of conditions that you want to monitor.

Procedure:

1. Decide which conditions to monitor. The **Status Commands** topic lists all of the possible analyzer conditions that can be monitored.
2. Set the enable bits in the **summary** registers and the **status byte** register.

Enabling is like making power available to a light. Without power available, the switch can be activated, but the light won't turn ON. In the analyzer, without first enabling a bit, the condition may occur, but the controller won't see it unless it is enabled.

The condition, and the bit in the **summary** registers in the reporting path, must be enabled. This is like streams (conditions) flowing into rivers (summary registers), and rivers flowing into the ocean (controller). See the diagram of status registers in **Status Commands**.

Bit 6 of the **status byte** register is the only bit that can interrupt the controller. When **any** representative bit in the status byte register goes ON, bit 6 is automatically switched ON.

3. Enable your program to interrupt the controller. This is done several ways depending on the programming language and GPIB interface card you use. An **example program** is provided showing how this is done with in Visual Basic with a National Instruments GPIB card.
 4. Construct a subroutine to handle the interrupt event. If you are monitoring more than one condition in your system, your event handler must determine which condition caused the interrupt. Use the ***SPE** command to determine the instrument that caused the interrupt, then poll the summary registers, then poll condition registers to determine the cause of the interrupt.
-

Referring to Traces, Measurements, Channels, and Windows Using SCPI

Sometimes in a SCPI program you may need to refer to traces that you have not created. This can be a bit confusing in the VNA. Here are the THREE ways to refer to a specific measurement trace.

Note: The terms "Trace" and "Measurement" effectively mean the same thing in this discussion.

1. The **Measurement Name** is picked by you when you first create a trace using the `CALCulate<cnum>:PARAmeter[:DEFine]:EXTended <Mname>,<param>` command. The measurement name is only used by SCPI.
2. The **Trace Number** is also picked by you when 'feeding' a newly-created measurement name to a window number using `DISP:WINDow<wmun>:TRACe<tnum>:FEED`. The trace number is used ONLY by SCPI and is mainly used to refer to traces in the DISPlay node. This is NOT the number that appears as **Tr#** on the screen. While you can assign any Trace number you want, when a measurement is created from the GUI, the VNA assigns numbers to the traces sequentially, starting with one in each window. Therefore, when there is more than one window, these numbers are not unique.
3. The **Tr#** that appears on the VNA screen is the third and most visible way to refer to a trace. Since we already have a "Trace Number", we call this the **Measurement Number** in the VNA Help file. This number is issued sequentially by the VNA regardless of channel and window. It is therefore unique among all traces. Use `CALC<ch>:PAR:MNUM?` just after the trace is created to read the measurement number.

The concept of the **Active measurement** versus **Selected Measurement** is also a bit confusing. As seen on the screen, the Active measurement has the highlighted Tr# . While there can only be ONE active measurement, every channel has a selected measurement. The target measurement must first be selected before most CALC node settings can be made. There are two ways to select a measurement for each channel:

1. Use `CALC<ch>:PAR:SEL <measName>` which requires the channel number and measurement name.
2. Use `CALC<ch>:PAR:MNUM <measNum>` which requires the channel and measurement (**Tr**) number.

Here are other relevant commands for referring to traces, measurements, channels, and windows:

- `CALC<cnum>:PAR:CATalog:EXTended?` - Catalog the Measurement Names for the specified channel.
- `CALC<cnum>:PAR:TNUMBER?` - Returns the Trace Number of the selected trace.
- `CALC<cnum>:PAR:WNUMBER?` - Returns the window number of the selected trace.
- `SYSTEM:ACTIVE:CHANNEL?` - Returns the number of the active channel. The active channel is the channel number that contains the active measurement.

- **SYSTem:ACTive:MEAS?** - Returns the name of the active measurement. As seen on the screen, the Active measurement has the highlighted Tr#.
 - **SYSTem:CHANnels:CATalog?** - Returns the channel numbers currently in use.
 - **SYSTem:WINDows:CATalog?** - Returns the window numbers that are currently being used.
 - **SYSTem:MEAS:CATalog? [chan]** - Returns ALL measurement numbers, or optionally measurement numbers from a specified channel.
 - **SYSTem:MEAS<n>:NAME?** - Returns the name of the specified measurement (Tr#) number.
 - **SYSTem:MEAS<n>:TRACe?** - Returns the trace number of the specified measurement number.
 - **SYSTem:MEAS<n>:WINDow?** - Returns the window number of the specified measurement number.
-

Configure for SCPI LAN using SICL / VISA

- [VNA Supported Interfaces](#)
- [Keysight I/O Libraries](#)
- [SICL / VISA Programs Running on the VNA](#)
- [Configure the VNA for SICL / VISA](#)
- [Configure the External Controller](#)

Other Topics about GPIB Concepts

VNA Supported Interfaces

The VNA supports the following interfaces for SICL / VISA communication:

- **LAN** - as a remote GPIB interface. The VNA LAN is presented as a virtual GPIB interface. It does NOT support simple TCPIP-based control. Therefore, when configuring the Keysight IO libraries on your PC, add a **REMOTE GPIB** interface, which uses the LAN client interface.
- **GPIB** - requires that your external controller have a GPIB card.

Note: For optimum LAN interface performance, use COM to control the VNA. SCPI commands can be sent to the VNA using the COM SCPIStringParser object.

The following interfaces are NOT supported:

- **USB**
- **Serial**

Important Note:

To enable VISA or SICL communication over LAN, you must do the following:

1. On the VNA, click **Utility, System, System Setup...**, then select **Remote Interface...**
2. Check **SICL Enabled**. To automatically enable SICL when the VNA is booted, check **Automatically enable on Startup**.
3. Click **OK**.

The VNA is now ready to be controlled over LAN.

[Learn more about this dialog box.](#)

Keysight I/O Libraries

The Keysight I/O libraries includes the drivers to allow you to communicate with Keysight test instruments. Every VNA is shipped with the Keysight I/O libraries installed. We recommend you do NOT upgrade the Keysight I/O libraries on the VNA as unexpected results may occur. If you choose to upgrade the Keysight I/O libraries on the VNA, do NOT change the default folder path in the InstallShield Wizard.

To communicate with the VNA, the Keysight I/O libraries must also be installed on your external controller. To purchase the Keysight I/O libraries, or download a free upgrade, go to www.Keysight.com and search for IO Libraries. Scroll to find Software, Firmware & Drivers.

SICL / VISA Programs Running on the VNA

You can run your SICL / VISA program on the VNA to control the VNA. Although the Keysight I/O libraries are already installed on the VNA, it is configured as the **Host**. You must also configure a SICL or VISA LAN **Client** interface on the VNA, specifying the LAN hostname of that same VNA.

If your program uses the COM interface to VISA, and is compiled on a PC with the Keysight IO Libraries Suite (version 14 or later), and the resulting executable is copied and run on the VNA, it will produce a “type mismatch error”. This is because the VNA has the ‘M’ version of Keysight I/O libraries. The following Visual Basic code is an example of how to avoid this error when communicating with the VNA from within the VNA:

```
Dim rm As IResourceManager
Dim fmio As IFormattedIO488
Set rm = CreateObject("AgilentRM.SRMCl1s")
```

```

Set fmio = CreateObject("VISA.BasicFormattedIO")
Set fmio.IO = rm.Open("GPIB0::22")
fmio.WriteString "*IDN?" & Chr(10)
MsgBox fmio.ReadString()

```

Controlling the VNA over LAN while controlling other instruments over GPIB

The VNA can NOT be both a controller and talker/listener on the same GPIB bus. Using SICL / VISA, you can use LAN to control the VNA, leaving the VNA free to use the rear-panel GPIB interface to control other GPIB devices.

Configure the VNA for SICL / VISA

1. Open the **Keysight Connection Expert**.
2. Select each GPIB Interface and verify (or make) the default settings in the following table. These settings are REQUIRED when using a 82357A USB / GPIB Interface with the VNA.
3. When complete, click **Accept** to close the **Keysight Connection Expert**.

VISA Interface Name	SICL Interface Name	Dialog box title	Description
GPIB0	gpib0	GPIB Using NI-488.2	VNA Rear-panel GPIB connector. This GPIB interface can be used to control the VNA OR for the VNA to control external equipment. IT CAN NOT DO BOTH IN THE SAME PROGRAM. Learn more about pass-through options.
GPIB1	hpib7	Internal Instrument Configuration	Internal interface for programs running on the VNA to control itself.
GPIB4	inst0	Internal Instrument Configuration	Used for LXI compliance. Do NOT delete this interface.

Configure the External Controller

Please refer to the Keysight I/O libraries documentation to learn how to configure your controller to communicate with the VNA. These links can show you how to find the following VNA information:

- VNA full computer name

- GPIB Address
- IP Address

This **example program** can help test your VISA configuration.

Keysight VEE Pro RunTime Installed

Beginning in Dec. 2005, Keysight VEE Pro RunTime is installed on new VNAs. This means that programs written with Keysight VEE (.vxe files) can be run directly on the VNA.

VNAs **without** Keysight VEE installed can go to the [Keysight VEE website](#) and download Keysight **VEE Pro 6.2** RunTime to the VNA and begin to run VEE programs directly on the VNA. This version does not require Keysight I/O Libraries suite 14. **Do NOT upgrade to Keysight I/O libraries suite 14 on the VNA.**

With Keysight VEE Pro RunTime installed on the VNA, the following examples can be run directly on the VNA:

- [Basic Control](#) of the VNA

For more VEE examples, see the [PNA support website](#).

For more information on Keysight VEE, see www.Keysight.com/find/VEE

Basic Control using VEE

This VEE Pro 6.0 example does the following:

- Controls VNA windows and traces.
- Changes stimulus settings.
- Measures all four S parameters.
- Create markers and displays marker readout.

If this Help file is on a VNA and **VEE Pro RunTime is installed**, then:

1. **Run the BasicControl.vxe example**
2. Then click **Open** on the following dialog box to run the program.

Otherwise, you can modify the example program using VEE, **save the VEE BasicControl.vee**

Learn how to run this program as a Macro on the VNA.

The following dialog box will be visible on the VNA when the example program is running.

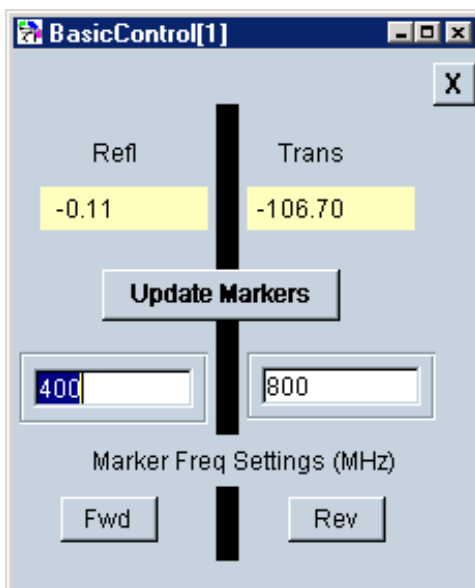

- Click **Fwd** to activate the Forward (S11 and S21) measurements.

- Click **Rev** to activate the Reverse (S22 and S12) measurements.
 - Click **Update Markers** to sweep the VNA.
 - Type values to change Marker Frequencies.
-

ECal with Confidence Check using VEE

This VEE Pro 6.0 example performs an ECal and subsequent ECal confidence Check.

If this Help file is on a VNA and **VEE Pro RunTime** is installed:

- Run the **.vxe** example
- Then click **Open** on the following dialog box to run the program.

Or to modify the example program using VEE, **save the VEE BasicControl.vee**

[Learn how to run this program as a Macro on the VNA.](#)

The following dialog box will be visible on the VNA when the example program is running.

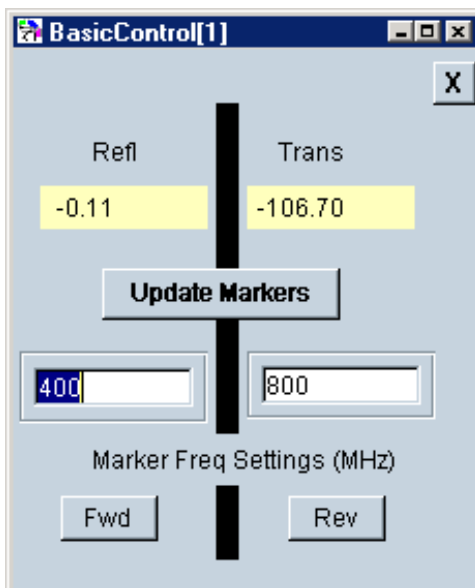

- Click **Fwd** to activate the Forward (S11 and S21) measurements.
 - Click **Rev** to activate the Reverse (S22 and S12) measurements.
 - Click **Update Markers** to sweep the VNA.
 - Type values to change Marker Frequencies.
-

I/O Connector (M9485A)

M9376A and M9377A have the I/O connectors which is used to synchronize the triggering of the analyzer with other equipment. M9376A and M9377A also has the port to generate the pulse for pulse measurement.

IO Port Assignments

The ports on M9376A/M9377A which are assigned to the ports 1 to 4 can be used as the Handler I/O as shown below at the default.

Module	Port name	Signal name	Input/Output	Description
Port 1	I/O1	/READY FOR TRIGGER	Output	<p>Indicates that the instrument is ready for triggering. The signal is changed to the High level when the instrument is ready for receiving a trigger signal.</p> <p>With the point trigger function on, it goes to the Low level when the instrument is ready to accept the trigger signal for the first point and goes to the High level when the trigger signal for the first point is received. When measurement of all measurement points is completed and the instrument is ready to receive the trigger signal for the first point of the next sweep, this signal goes to the Low level again.</p>
	Trig	/EXTERNAL	Input	An external trigger

		TRIGGER		signal. When the trigger source is set to the "External," this port generates a trigger in respond to the trailing edge of a negative pulse.
	I/O2 (M9376A), I/O2, Sync (M9377A)	/INDEX	Output	<p>Indicates that analog measurement is complete. The /INDEX signal changes to the Low level when analog measurement (all sweeps of all channels) is complete. When the handler receives the signal, it assumes that it is ready to connect the next DUT. However, no measurement data are available until data calculation is completed.</p> <p>When the point trigger function is on, it goes to the High level before staring measurement of the first measurement point and returns to the Low level after completing measurement of all measurement points.</p>
Port 2	I/O1	/SWEEP END	Output	A sweep completion signal. When measurement (all

				sweeps of all channels) and data calculation are completed, this signal provides a negative pulse.
	Trig	INPUT1	Input	When this port receives a negative pulse, /OUTPUT1 are changed to the Low/High level depending on the setup.
	I/O2 (M9376A), I/O2, Sync (M9377A)	OUTPUT1	Output	Changes to the logic level when /INPUT1 receives a negative pulse. A command can be available for altering the Low/High level logic.
Port 3	I/O1	P1	Output	Hardwired pulse train output #1 (TTL)
	Trig	PULSE SYNC IN	Input	Pulse generator synchronization trigger input (TTL)
	I/O2 (M9376A), I/O2, Sync (M9377A)	P2	Output	Hardwired pulse train output #2 (TTL)
Port 4	I/O1	P3	Output	Hardwired pulse train output #3 (TTL)
	Trig	If the left slot space is not receiver modules, /EXTERNAL TRIGGER	Input	If the left side slot space of port 4 is not receiver modules, this Trig is assigned to an external trigger signal. When the trigger source is set to the "External," this port generates a

				trigger in respond to the trailing edge of a negative pulse.
	I/O2 (M9376A), I/O2, Sync (M9377A)	P4	Output	Hardwired pulse train output #4 (TTL)
Ports 5 and above	I/O1	N/A	N/A	At default, no signal is assigned to Trig on Ports 5 and above.
	Trig	If the left slot space is not receiver modules, /EXTERNAL TRIGGER	Input	If the left side slot space of port 4 is not receiver modules, this Trig is assigned to an external trigger signal. When the trigger source is set to the "External," this port generates a trigger in respond to the trailing edge of a negative pulse.
	I/O2 (M9376A), I/O2, Sync (M9377A)	Sync	Output	Sync

Modification of Pin Assignments

The user can modify the pin assignments of digital I/O port except for the three signals; READY_FOR_TRIGGER, EXTERNAL_TRIGGER and INDEX which are assigned on the PORT1. If you have two port system, it is necessary to modify this file in order to use the signals of P1 to P4 and PULSE SYNC IN.

Save the definition file according to the following examples. The VNA firmware first initializes the pin assignments to the default condition defined above then read the user defined file.

File name and location to save

C:\\Users\\Public\\Public Documents\\Network Analyzer\\m9485a_digitalio.csv

File format

<port number>, <signal for I/O1>, <signal for Trig>, <signal for I/O2>

Parameter	Value
<port number>	2 – maximum port number in the 1st chassis
<signal for I/O1>	SWEEP_END, OUTPUT1, P1, P2, P3 or P4, RFOUT_N, NOISE_PORT1 to NOISE_PORT24, NOISE_LO2, AUX1_TRIG_OUT, AUX2_TRIG_OUT
<signal for Trig>	INPUT1 or PULSE_SYNC_IN
<signal for I/O2>	SWEEP_END, OUTPUT1, P1, P2, P3 or P, RFOUT_N, NOISE_PORT1 to NOISE_PORT24, NOISE_LO2, AUX1_TRIG_OUT, AUX2_TRIG_OUT

INPUT1 and OUTPUT1 must be assigned to the same port number

If the same signal is assigned to some of the different I/O ports, the lower port is selected. And if the same signal is assigned to the both of the I/O1 and I/O2 on the same port, the I/O1 is selected.

Auxiliary Trigger

Auxiliary Triggering can be assigned on I/O 1 and 2. See example 7.

I/O signal for Noise Figure measurement

The following signals are available in Noise Figure measurement. This signal can be used to control the external RF switch .

Port name	Signal name	Input/Output	Description
I/O1 or I/O2	/RFOUT_N	Output	Indicates that the source signal is out. This signal is changed to the Low level when the source signal is out.
I/O1 or I/O2	NOISE_PORT1 to NOISE_PORT24	Output	Indicates that noise sweep. This signal is changed to the high level when the target port is used in in a sweep for noise measurement.
I/O1 or I/O2	NOISE_LO2	Output	Indicates that noise sweep for dual-band parallel mode (option). This signal is changed to the high level when the target port is used in in a sweep for dual-band parallel noise measurement.

Example 1

2 ports system with P1, PULSE SYNC IN, P2

(SWEEP_END, INPUT1, OUTPUT1, P3 and P4 are not used)

	PORT1	PORT2
I/O 1	READY FOR TRIGGER	P1
Trig	EXTERNAL TRIGGER	PULSE SYNC IN
I/O 2 (M9376A), I/O2, Sync (M9377A)	INDEX	P2

File format example

2, P1,PULSE_SYNC_IN,P2

Example 2

2 ports system with SWEEP_END, PULSE SYNC IN, P1

(INPUT1, OUTPUT1, P2 to P4 are not used)

	PORT1	PORT2
I/O 1	READY FOR TRIGGER	SWEEP_END
Trig	EXTERNAL TRIGGER	PULSE SYNC IN
I/O 2 (M9376A), I/O2, Sync (M9377A)	INDEX	P1

File format example

2, SWEEP_END,PULSE_SYNC_IN,P1

Example 3

4 ports system, signal locations are assigned differently from default as shown below.

	PORT1	PORT2	PORT3	PORT4
I/O 1	READY FOR TRIGGER	SWEEP_END	OUTPUT1	P4
Trig	EXTERNAL TRIGGER	N/A	INPUT1	PULSE SYNC IN
I/O 2 (M9376A), I/O2, Sync (M9377A)	INDEX	P1	P2	P3

File format example

2, SWEEP_END,,P1

3, OUTPUT1,INPUT1,P2

4, P4,PULSE SYNC IN,P3

Example 4

6 ports system for Noise Figure measurement, signal locations are assigned differently from default as shown below.

	PORT1	PORT2	PORT3	PORT4	PORT5	PORT6
I/O 1	READY FOR TRIGGER	RFOUT_N	NOISE_PORT3	NOISE_PORT4	NOISE_PORT5	NOISE_PORT6
Trig	EXTERNAL TRIGGER	N/A	N/A	N/A	N/A	N/A
I/O 2 (M9376A), I/O2, Sync (M9377A)	INDEX	N/A	N/A	N/A	N/A	N/A

File format example

2, RFOUT_N, ,

3, NOISE_PORT3, ,

4, NOISE_PORT4, ,

5, NOISE_PORT5, ,

6, NOISE_PORT6, ,

Example 5

M9376A/77A 4 ports system with one M9379A RF Amplifier between ports 2 and 3. The **I/O2** on Port 2 and **Trig** on Port 3 should be connected with SMB cable.

	PORT1	PORT2		PORT3	PORT4	
Module	M9376A	M9377A	M9379A	M9377A	M9377A	M9379A
I/O 1	READY FOR TRIGGER	SWEEP END		P1	P3	
Trig	EXTERNAL TRIGGER	PULSE SYNC IN		EXTERNAL TRIGGER	N/A	
I/O 2 (M9376A), I/O2, Sync (M9377A)	INDEX	SYNC		P2	N/A	

File format example

2, SWEEP_END,,PULSE_SYNC_IN,

3, P1, ,P2

4, P3, ,

Example 6

M9376A 4 ports system with one M9379A between ports 2 and 3. The **Sync** on Port 2 and **Trig** on Port 3 should be connected with SMB cable.

	PORT1	PORT2		PORT3	PORT4	
Module	M9376A	M9376A	M9379A	M9376A	MM9376A	M9379A
I/O 1	READY FOR TRIGGER	SWEEP END		P1	P3	
Trig	EXTERNAL TRIGGER	PULSE SYNC IN		EXTERNAL TRIGGER	EXTERNAL TRIGGER	
Sync	N/A	Sync ON		N/A	N/A	
I/O 2 (M9376A), I/O2, Sync (M9377A)	INDEX	N/A		P2	N/A	

File format example

2, SWEEP_END,,PULSE_SYNC_IN,

3, P1, ,P2

4, P3, ,

Example 7

4 ports system, assign Auxiliary Triggering for I/O 2 on ports 2 and 4.

	PORT1	PORT2	PORT3	PORT4
I/O 1	READY FOR TRIGGER	SWEEP_END	P1	P3
Trig	EXTERNAL TRIGGER	N/A	PULSE SYNC IN	N/A
I/O 2 (M9376A), I/O2, Sync (M9377A)	INDEX	AUX1_TRIG_OUT	P2	AUX2_TRIG_OUT

File format example

2, SWEEP_END,,AUX1_TRIG_OUT

3, P1,PULSE SYNC IN,P2

4, P3,,AUX2_TRIG_OUT

Restriction of the usage of M9377A I/O2

In case of the multi-chassis configuration and M9377A is used as the 1st port receiver, the I/O2 pin must be used as Sync pin to synchronize over the chassis. Then the INDEX signal cannot be output from the I/O2 of PORT1. In this special case the INDEX signal is output from the I/O1 pin of the 1st port receiver in the 2nd chassis.

Restriction of the P1 to P4 and PULSE SYNC IN

In case of the multi-chassis configuration, the P1 to P4 can be assigned to the receivers installed in the 1st chassis. The PULSE SYNC IN can be assigned to the receivers installed in the slots which belong to the same trigger bus segment of the 1st port receiver. In standard configuration, both receiver should be in slots No. 7 to 12 for M9018A. Refer to M9018A users guide for the trigger bus segment.

Pin Descriptions

Input1

When this Input line receives a Low pulse from the material handler, data is latched on the OUTPUT1 lines. The Input Line activity can be read:

SCPI
CONTrol:HANDler:INPut?

Output1

The **current** state of these latched TTL outputs may be set High or Low (Default setting) using the (non-user) OUTPUT commands.

The **next** state (following a negative edge on the INPUT1 line) may be pre-loaded to High or Low (Default setting) using the user commands.

For example, on the next negative pulse on the INPUT1 line, you want the OUTPUT1 line to go from 0 to 1. To do this:

```
CONT:HAND:OUTP1:DATA 0  'Force the OUTPUT1 line to 0
CONT:HAND:OUTP1:USER 1  'Set the OUTPUT1:USER buffer to 1, indicating the next
state
```

SCPI

Write User Data	CONT:HAND:OUTP1:USER
Read last value written	CONT:HAND:OUTP1:USER
Write non-user data	CONT:HAND:OUTP1:DATA
Read last value written	CONT:HAND:OUTP1:DATA

External Trigger

When trigger source is set to external, this Input line accepts a trigger signal from the material handler. This usually means that a part is in place and ready to be tested.

Sweep End

This output line indicates the status of the VNA sweep. The sweep includes sweeping the source and taking data.

- **Low** (falling edge) indicates that the specified sweep event has finished. This does NOT indicate that all calculations have finished.
- **High** indicates that the specified sweep event is active.

Set Sweep Event Mode:

- **Sweep** : indicates that a single source sweep has finished. (Default setting)
- **Channel** : indicates that a single channel has finished.
- **Global** : indicates that all enabled channels have finished.

SCPI

CONTrol:HANDler:SWEEpend

Timing Diagrams

	Description	Minimum Typical
T1	Pulse width of /EXTERNAL TRIGGER	0.1 μ s
T2	Pulse width of /SWEEP END	10 μ s

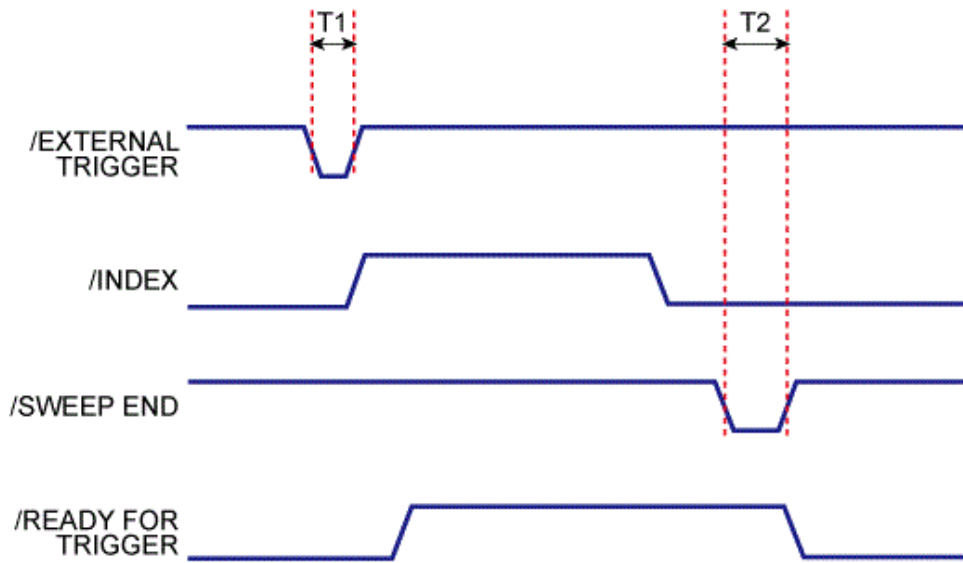

Description	Minimum	Typical
T1 Pulse width of /INPUT1	0.1 μ s	
T2 Response time of /OUTPUT1		0.1 μ s

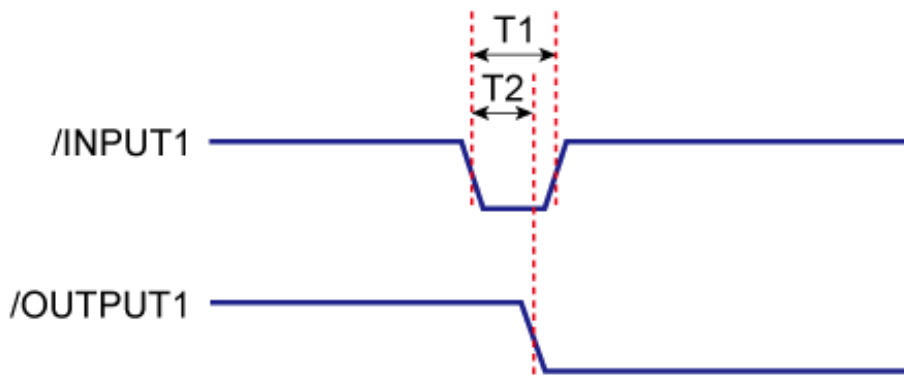

Last modified:

20-May-2019 New topic

I/O Adapter (M98xxA/P50xxA)

Overview

M98xx/P50xxA can output/input the signals to communicate with external peripherals via control ports (master and sub) on the front panel. The Y1731A-001 I/O adapter allows you to access the signal via SMB connectors.

Connection

The cables should be connected like the following figures. The Y1731A-001 does not require the power. Installing it into the PXIe chassis is not necessary. You can use it outside of the PXIe chassis.

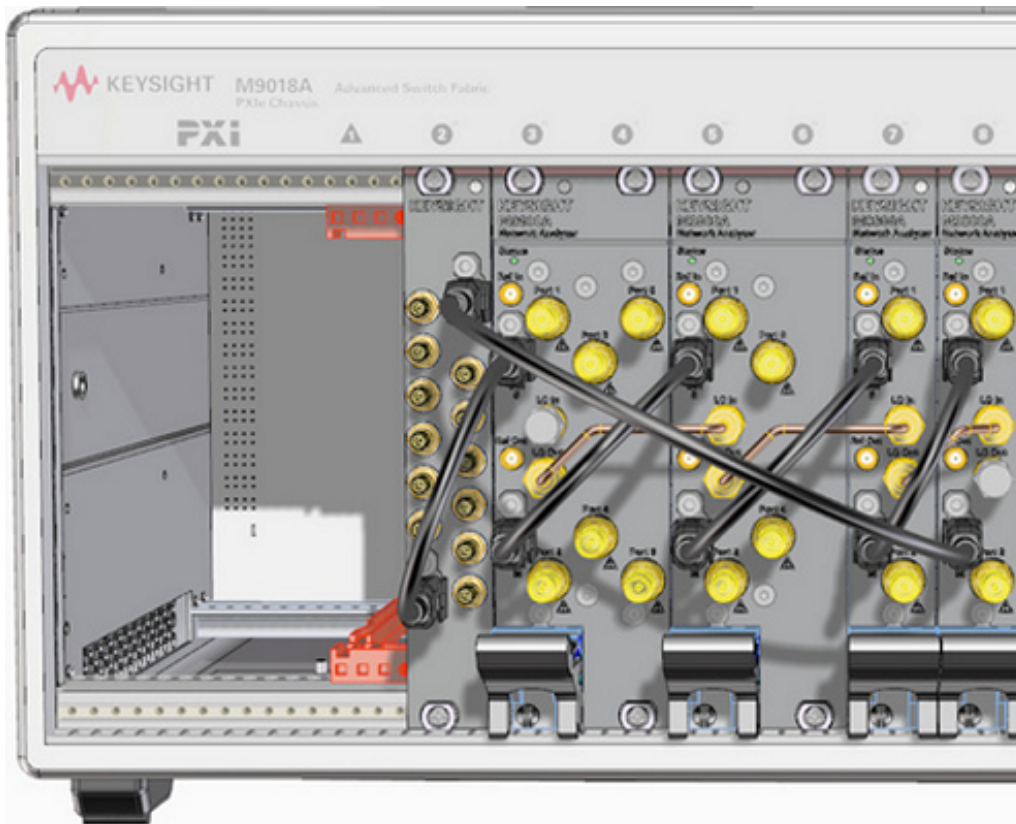

The angle and screws prevent the cable from coming off.

	No.	Part Number	Description	Qty.
	1	M9800-61601	Cable Assembly, Control 150mm-LG (This cable is not furnished with Y1731A-001)	1
		P5000-61603	Cable Assembly, Control 175mm-LG	
		M9800-61605	Cable Assembly, Control 500mm-LG	
	2	M9800-01201	Angle, Control Cable Assembly	2
	3	0515-4351	Screw-SKT-HD-Cap HEX-SKT M3X0.5 4mm-LG	2

Port Assignment



Sides A and B on the Y1731A-001 are identical. You can connect the Ctrl M or S with both sides.

Main Side (Connected with Ctrl M)

Port Number	Function (Factory Default)	Alternative Function
1	High level output	<ul style="list-style-type: none"> • Pulse Output 1 • Low or High level outputs • Source port (#S) external switch control output for Noise Figure • Receiver port (#R) external switch control output for

		<p>Noise Figure</p> <ul style="list-style-type: none"> • LO signal of module (#M) external switch control output for Noise Figure
2	High level output	<ul style="list-style-type: none"> • Pulse Output 2 • Low or High level outputs • Source port (#S) external switch control output for Noise Figure • Receiver port (#R) external switch control output for Noise Figure • LO signal of module (#M) external switch control output for Noise Figure
3	Arbitrary input	<ul style="list-style-type: none"> • Pulse Output 3 • Low or High level outputs • Source port (#S) external switch control output for Noise Figure • Receiver port (#R) external switch control output for Noise Figure • LO signal of module (#M) external switch control output for Noise Figure
		<ul style="list-style-type: none"> • Pulse Output 4 • Low or High level outputs • Source port (#S) external switch control output for

4	Arbitrary input	<p>Noise Figure</p> <ul style="list-style-type: none"> • Receiver port (#R) external switch control output for Noise Figure • LO signal of module (#M) external switch control output for Noise Figure
5	RF pulse modulation input	None
6	Arbitrary input	None

Sub Side (Connected with Ctrl S)

Port Number	Function (Factory Default)	Alternative Function
1	Trigger input	None
2	Pulse synchronization input	None
3	Arbitrary input	<ul style="list-style-type: none"> • Ready for trigger output • Low or High level outputs • Source port (#S) external switch control output for Noise Figure • Receiver port (#R) external switch control output for Noise Figure • LO signal of module (#M) external switch control output for Noise Figure
		<ul style="list-style-type: none"> • AUX trigger output

4	Arbitrary input	<ul style="list-style-type: none"> • Low or High level outputs • Source port (#S) external switch control output for Noise Figure • Receiver port (#R) external switch control output for Noise Figure • LO signal of module (#M) external switch control output for Noise Figure
5	High level output	<ul style="list-style-type: none"> • Index output • Low or High level outputs • Source port (#S) external switch control output for Noise Figure • Receiver port (#R) external switch control output for Noise Figure • LO signal of module (#M) external switch control output for Noise Figure
6	High level output	<ul style="list-style-type: none"> • Sweep End output • Low or High level outputs • Source port (#S) external switch control output for Noise Figure • Receiver port (#R) external switch control

		<p>output for Noise Figure</p> <ul style="list-style-type: none"> • LO signal of module (#M) external switch control output for Noise Figure
--	--	---

I/O signal description

Signal name	Input/Output	Description
/READY FOR TRIGGER	Output	<p>Indicates that the instrument is ready for triggering. This signal changes to the Low level when the instrument is ready for receiving a trigger signal.</p> <p>With the point trigger function on, it goes to the Low level when the instrument is ready to accept the trigger signal for the first point and goes to the High level when the trigger signal for the first point is received. When measurement of all measurement points is completed and the instrument is ready to receive the trigger signal for the first point of the next sweep, this signal goes to the Low level again.</p>
/EXTERNAL TRIGGER	Input	An external trigger signal. When the trigger source is set to the "External," this port generates a trigger in response to the trailing edge of a negative pulse.
/INDEX	Output	<p>Indicates that analog measurement is complete. The /INDEX signal changes to the Low level when analog measurement (all sweeps of all channels) is complete. When the handler receives the signal, it assumes that it is ready to connect the next DUT. However, no measurement data are available until data calculation is completed.</p> <p>When the point trigger function is on, it goes to the High level before starting measurement of the first measurement point and returns to the Low level after completing measurement of all measurement points.</p>
/SWEEP END	Output	A sweep completion signal. When measurement (all sweeps of all channels) and data calculation are completed, this signal provides a negative pulse.
PULSE SYNC IN	Input	Pulse generator synchronization trigger input
RF PULSE MOD IN	Input	RF source pulse modulation drive input

Pulse Output 1 (P1)	Output	Hardwired pulse train output #1
Pulse Output 2 (P2)	Output	Hardwired pulse train output #2
Pulse Output 3 (P3)	Output	Hardwired pulse train output #3
Pulse Output 4 (P4)	Output	Hardwired pulse train output #4
Source port (#S) external switch control output	Output	Indicates that the source signal is out. This signal is changed to the Low level when the source signal is out.
Receiver port (#R) external switch control output	Output	Indicates that noise sweep. This signal is changed to the high level when the target port is used in a sweep for noise measurement.
LO signal of module (#M) external switch control output	Output	Indicates that noise sweep for dual-band parallel mode (option). This signal is changed to the high level when the target port is used in in a sweep for dual-band parallel noise measurement.

SCPI Command

See [CONTrol:SIGNal:KDMI SCPI commands](#) to set or read the signals, assign the alternative functions for the test port. The assigned settings are preserved for each system configuration even after preset, firmware restart and power on/off.

Timing Diagrams

Trigger Timing

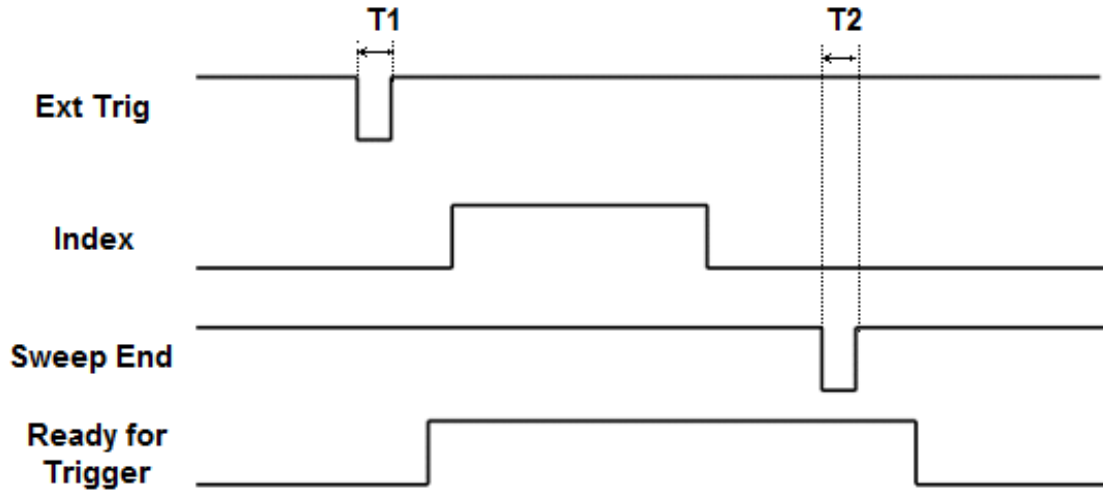

All signals are active low.

T1 = 1 μ s External Trigger pulse width

T2 > 10 μ s Sweep End pulse width (both High and Low)

Input / Output Electrical Characteristics

All I/O Input and Output lines are TTL compatible.

Input and Input/Output lines

Lines carrying information IN (or bidirectional) to the VNA from the material handler.

Maximum Input Voltages:	-0.5 V to 5.5 V
TTL High level:	2.0 V to 3.3 V
TTL Low level:	0 V to 0.5 V

VNA **Input** and **Input/Output** Circuit Diagram

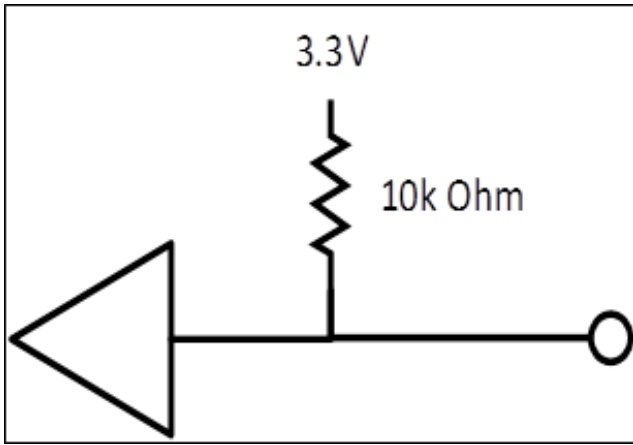

Output Lines

Lines carrying information OUT of the VNA to the material handler.

	Maximum Output Current:	-10 mA to 10 mA
Output Current	TTL High level:	-5 mA
	TTL Low level:	3 mA
Output Voltage	TTL High level:	≥ 2.0 V
	TTL Low level:	0 V to 0.8 V

VNA **Output** Circuit Diagram

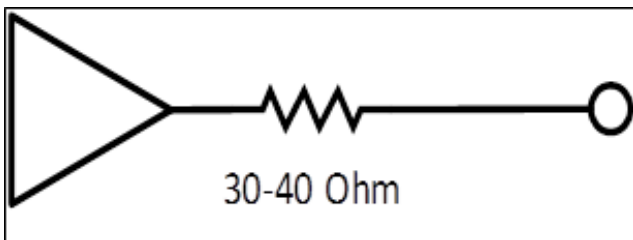

Material Handler I/O Connector

This rectangular 36-pin female connector provides communication signals between the VNA and a material parts handler. You can change the settings on the Material Handler IO connector using SCPI commands.

The M9341A/B I/O module can be work with the PXIe VNA as Material Handler I/O. The input and output interfaces are compatible with ENA and PNA material handler I/O.

- Overview - Controlling a Material Handler
- Pin Assignments
- Pin Descriptions
- Timing Diagrams
- Input Output Electrical Characteristics

Note: On early VNAs this connector is labeled "GPIO". It is covered to indicate that the connector is not functional.

Overview - Controlling a Material Handler

The VNA is capable of interacting with an external material handler or part handler. This allows the VNA to be used in an automated test environment, where devices to be tested are inserted into a test fixture by a part handler, and sorted into pass/fail bins by the handler after testing is complete. By connecting the part handler to the Material Handler I/O ports, the VNA and part handler can synchronize their activities in a way that makes automated testing possible.

M9341A/B Module Installation

When the M9341A/B I/O module is used with M937xA, M980xA and M9485A, the SMB cables for sync must be connected as shown below.

M937xA

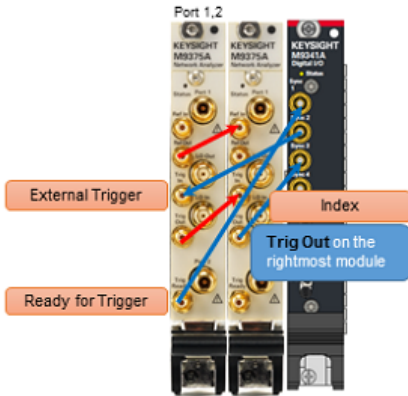

M980xA

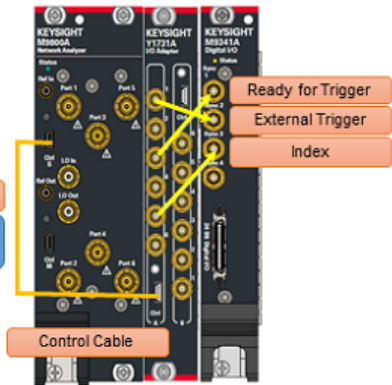

M9485A



M9341A/B Location

The M9341A should be placed the following location

- M937xA/M980xA: Any slot.
- M9485A: Installing at the right side of the rightmost receiver is recommended. When the M9341A is installed between receivers, the sync signal connection is required. The **Sync** on Port n and **Trig** on Port (n+1) should be connected with SMB cable when the M9341A is located between Ports n and (n+1).

Port Connection

M9341A/B	M9371A/72A/73A/74A/75A	M980xA (IO adapter is required)	M9485A
Sync 1	Trig Ready on Port 1,2 module	Ready for Trigger (IO adapter : Sub/port 3, function assignment is necessary, CONT:SIGN:KDMILSUB3:FUNC "READY_FOR_TRIGGER")	I/O 1
Sync 2	Trig In on Port 1,2 module	External Trigger (IO adapter: Sub/port 1)	Trig on Port 1
Sync 3	Trig Out on the rightmost module	Index (IO adapter : Sub/port 5, function assignment is necessary, CONT:SIGN:KDMILSUB5:FUNC "INDEX")	I/O2 on Port 1

Recommended Cables

Number of slot between M9341A/B and VNA module	SMB Cable Part Number	Length
1	8121-5091	120 mm
2 to 3	8121-2169	165 mm
4 to 8	M9485-61605	270 mm
More than 9	M9485-61604	340 mm

VNA and Part Handler Preparation

1. Define the measurements you want to make.
2. Define limits for each of the measurements.
3. Configure the VNAs Material Handler port so that it is compatible with your part handler. This usually involves setting the pass/fail logic , pass/fail scope , and pass/fail mode . These settings are made remotely using SCPI commands.
4. Use a cable to connect the VNA to your part handler.
5. Put the VNA in External Trigger mode.
6. Load parts in handler per manufacturer instructions.

Note : The Material Handler configuration settings REMAIN after an Instrument Preset . The settings will revert to their default settings ONLY after the VNA is restarted, or until they are changed by you.

Flow Diagram

The following diagram and descriptions summarizes the events that occur during automated testing. 'DUT' refers to Device Under Test.

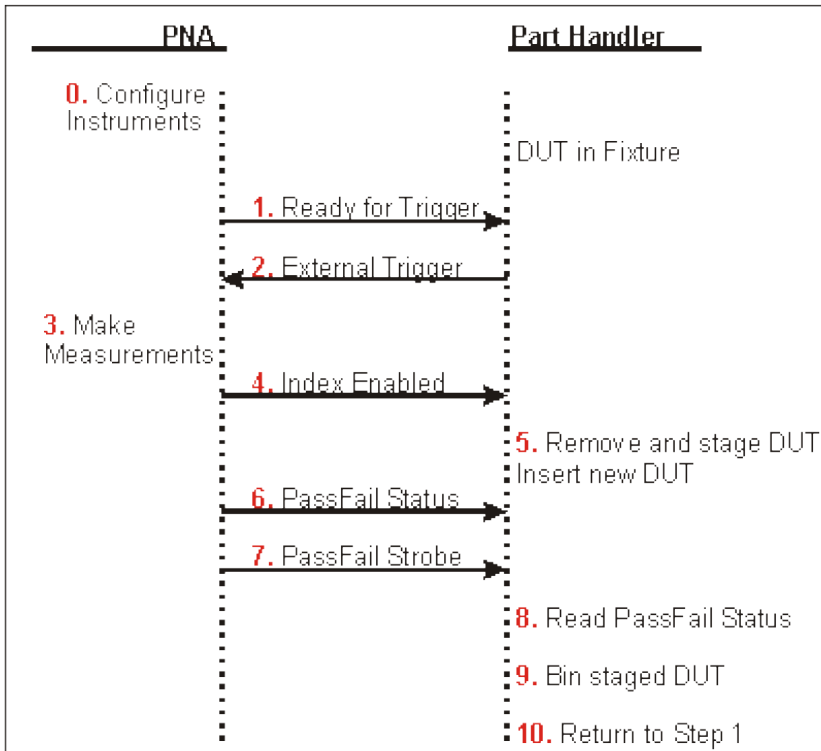

Text Descriptions

0. (Optional). The VNA sends values out the Material Handler to configure external instruments. The A,B,C, and D ports of the Material Handler can be used to control devices used in testing, such as step attenuators, part handlers, or even the DUT itself. If you wish to use the Material Handler for testing, you will need to write a program to send values out the various lines and ports, as there is no activity on these lines by default.
1. The part handler receives a Ready for Trigger signal from the VNA. This indicates that the VNA is properly configured and ready to take a measurement.
2. The part handler sends an External Trigger signal to the VNA. This signals that the part handler has settled, and allows the VNA to begin taking measurements.
3. The VNA takes measurements on all triggerable channels.
4. The Index line on the material handler goes to a Low state, which means that all required data has been collected by the VNA.
5. The part handler removes the DUT from the test fixture, and inserts a new DUT into the fixture. This operation is often referred to as part handler indexing. The device just tested is staged (removed from the fixture and prepared for binning), and the next part to be tested is put into the fixture. The removed DUT cannot be assigned to a Pass/Fail bin yet, as the Pass/Fail status is not available.
6. The VNA sends the Pass/Fail Status .
7. The VNA sends the Pass/Fail Strobe meaning that the Pass/Fail status has been determined.

8. The part handler reads the Pass/Fail Status line.
9. The part handler bins the staged part based on the Pass/Fail Status.
10. The test process repeats at step 1, waiting for Ready for Trigger from the VNA.

Material Handler IO Pin Assignments

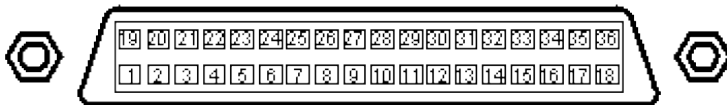

Pin	Description
1	Ground
2	/ INPUT1
3	/ OUTPUT1
4	/ OUTPUT2
5	/ Output port A0
6	/ Output port A1
7	/ Output port A2
8	/ Output port A3
9	/ Output port A4
10	/ Output port A5
11	/ Output port A6
12	/ Output port A7
13	/ Output port B0
14	/ Output port B1
15	/ Output port B2
16	/ Output port B3
17	/ Output port B4

18	/ Ext. Trigger
19	/ Output port B5
20	/ Output port B6 -or / Index Signal (select by command)
21	/ Output port B7 or / Ready for Trigger (select by command or dialog box)
22	/ In/Out port C0
23	/ In/Out port C1
24	/ In/Out port C2
25	/ In/Out port C3
26	/ In/Out port D0
27	/ In/Out port D1
28	/ In/Out port D2
29	/ In/Out port D3
30	Port C Status
31	Port D Status
32	/ Output Port Write Strobe
33	/ Pass/Fail
34	/ Sweep End
35	+5V
36	/ Pass/Fail Write Strobe

Pin Descriptions

Input1

When this Input line receives a Low pulse from the material handler, data is latched on the OUTPUT1 and OUTPUT2 lines. See OUTPUT1|2 Data Output Write Timing

The Input Line activity can be read:

SCPI
CONTrol:HANDler:INPut?

Output1, Output2

See OUTPUT1|2 Data Output Write Timing

The **current** state of these latched TTL outputs may be set High or Low (Default setting) using the (non-user) SCPI `put_Output (COM)` commands.

The **next** state (following a negative edge on the INPUT1 line) may be pre-loaded to High or Low (Default setting) using the user commands.

For example, on the next negative pulse on the INPUT1 line, you want the OUTPUT1 line to go from 0 to 1. To do this:

```
CONT:HAND:OUTP1:DATA 0 'Force the OUTPUT1 line to 0
CONT:HAND:OUTP1:USER 1 'Set the OUTPUT1:USER buffer to 1, indicating the next
state
```

SCPI

Write User Data

CONT:HAND:OUTP<pin>:USER

Read last value written

CONT:HAND:OUTP<pin>:USER

Write non-user data

CONT:HAND:OUTP<pin>:DATA

Read last value written

CONT:HAND:OUTP<pin>:DATA

How to Control Handler Output

Using **Hardkey** / **SoftTab** / **Softkey**

1. Press **Setup** > **Internal Hardware** > **PXI Device...**
2. **C** lick **M9341 Handler Setup..**

Using a mouse

1. Click **Instrument**
2. Select **Setup**
3. Select **Internal Hardware**
4. Select **PXI Device..**
5. Select **M9341A Handler Setup..**

Programming Commands

M9341 Setup dialog box help

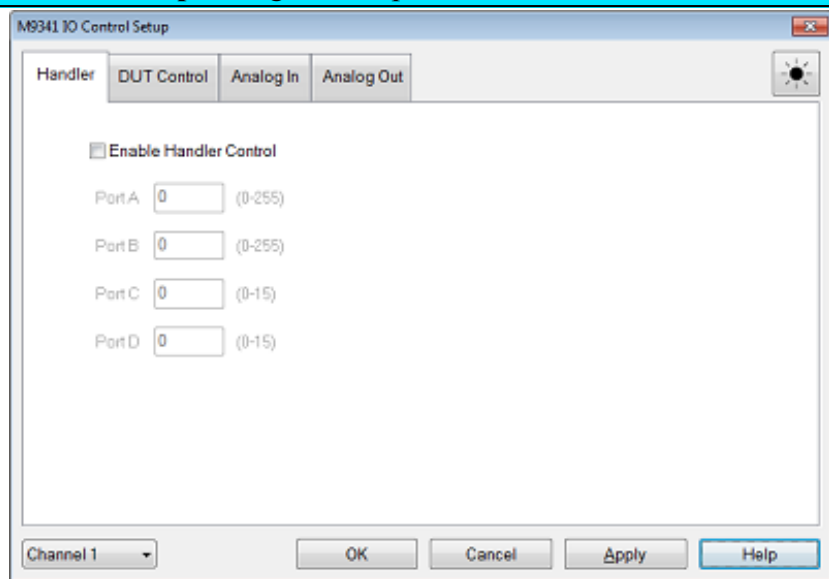

You can specify the port A to D output with this dialog box. The setting value is independent for each channel. These values are set before sweep.

Enable Handler Control Enabling the setting for Parts A to D.

Port A to D Sends values to the respective Handler I/O port. Although ports C and D are normally bidirectional, **ONLY** Output mode is allowed using the Interface Control feature. It cannot read from these, or any other, ports

Output Ports A and B

These two general purpose, 8-bit output ports are used to write data to the material handler. When any line changes state, all output lines are latched to the I/O connector as the Output Write Strobe goes Low.

The default state for data is Low.

See Data Output Write Timing Diagram

Combine to write data to Port F :

Ports A and B can be virtually combined to write data to one 16-bit I/O port F.

SCPI

CONTRol:HANDler:F <num>

Input/Output Ports C and D

These two general purpose 4-bit Input/Output ports are used to write data (Output) or read data (Input). These lines could be used to write to an external device such as a step attenuator.

When any line changes state, all output lines are latched to the I/O connector as the Output Write Strobe goes Low. See Data Output Write Timing .

Set Input | Output Mode:

Each port may be independently defined as Output or Input.

SCPI

CONTRol:HANDler:C:MODE

CONTRol:HANDler:D:MODE

Set Port Logic:

The logic for the data lines can be set to either: Positive (1 = High) or Negative (1 = Low). This setting affects all data ports. They cannot be set independently.

SCPI

CONTRol:HANDler:LOGic

Read or write data:

Ports C and D can be virtually combined to read or write data to one 8-bit I/O port **E**. When combined, **both** C and D ports must be set to either INPUT or OUTPUT mode.

SCPI

CONTRol:HANDler:<port>[:DATa]>

Port C Status, Port D Status

These two output lines indicate the Read / Write mode of the C and D ports.

- A Low level indicates that the associated port is in **INPUT** mode (read only).
- A High level indicates that the associated port is in **OUTPUT** mode (write only).

These logic of these status outputs cannot be changed.

See Input/Output Ports C and D to learn how to set I/O Mode

See Data Output Write Timing

Output Port Write Strobe

This Output line goes Low to write data from Ports A and B and Ports C and D when a change is detected on any of the data lines.

These logic of this strobe output cannot be changed.

See Data Output Write Timing

External Trigger

When trigger source is set to external, this Input line accepts a trigger signal from the material handler. This usually means that a part is in place and ready to be tested.

See Trigger Timing Diagram

Index

A Low signal on this Output line indicates to the material handler that the measurement is complete. This usually means that the handler can connect the next device. However, measurement data is not available until data is calculated. See Trigger Timing Diagram .

Set Function:

This line also serves as a data line. Set the function using the following commands:

SCPI

CONTRol:HANDler:INDex:STATe

Ready for Trigger

When this output line goes low, it indicates to the material handler that the VNA is ready for a trigger signal.

See Trigger Timing Diagram

See Pass/Fail Timing Diagram

Set Function:

This line also serves as a data line. Set the function using the following commands:

SCPI

CONTRol:HANDler:RTRigger:STATe

Pass/Fail State

This Output line indicates to the handler whether the limit test has passed or failed.

Pass/Fail state is valid only when the limit test function is ON and while Pass/Fail strobe line is Low. See Pass/Fail Timing Diagram

Set Pass / Fail Logic:

- Positive Logic: High=Pass, Low=Fail. (Default setting)
- Negative Logic: High=Fail, Low=Pass.

SCPI

CONTRol:HANDler:PASSfail:LOGic

Set Default Conditions :

- **PASS** - the line stays in PASS state. When a device fails, then the line goes to fail after the Sweep End line is asserted.
- **FAIL** - the line stays in FAIL state. When a device passes, then the line goes to PASS state after the Sweep End line is asserted.
- **No Wait**- the line stays in PASS state. When a device fails, then the line goes to fail IMMEDIATELY. (Default setting)

SCPI

CONTRol:HANDler:PASSfail:MODE

Set Pass / Fail Scope:

- **Channel scope**: The line resets to the default state after the measurements on a channel have completed.
- **Global scope**: The line resets to the default state after the measurements on all triggerable channels have completed. (Default setting)

SCPI

CONTRol:HANDler:PASSfail:SCOPE

Pass/Fail Write Strobe

A Low pulse indicates that Pass/Fail line is valid and the Pass / Fail State is output to the material handler.

The Pass/Fail Strobe is fixed in duration and timing. However, when the strobe occurs depends on the Pass/Fail Mode and Pass/Fail Scope (Channel or Global) settings. See Pass/Fail State

See Pass/Fail Timing Diagram

+5V

+5V nominal output (100mA max).

Protected by self-healing fuse.

Sweep End

This output line indicates the status of the VNA sweep. The sweep includes sweeping the source and taking data.

- **Low** (falling edge) indicates that the specified sweep event has finished. This does NOT indicate that all calculations have finished.
- **High** indicates that the specified sweep event is active.

See Trigger Timing Diagram

Set Sweep Event Mode:

- **Sweep** : indicates that a single source sweep has finished.
- **Channel** : indicates that a single channel has finished.
- **Global** : indicates that all enabled channels have finished. (Default setting)

SCPI

CONTRol:HANDler:SWEepend

Timing Diagrams

Trigger Timing

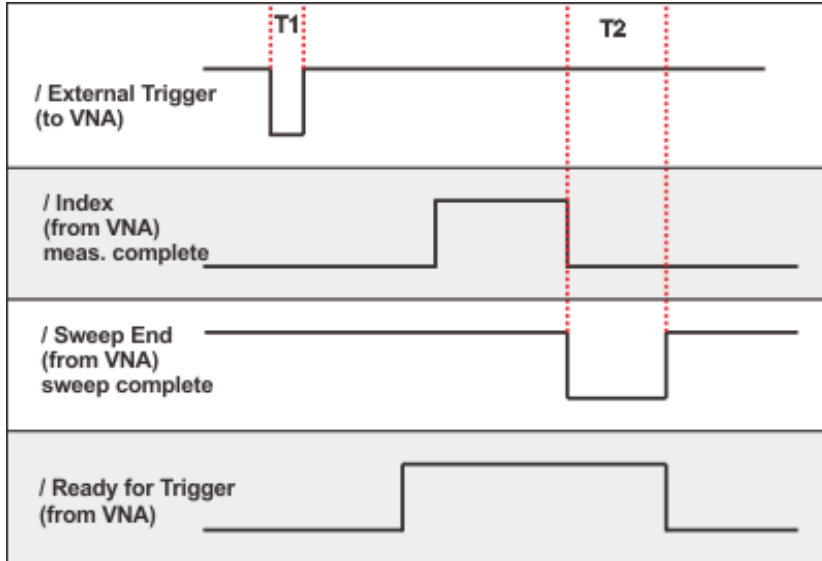

All signals are active low.

T1 = 0.1 μ s External Trigger pulse width

T2 > 10 μ s Sweep End pulse width (both High and Low)

Pass / Fail Timing

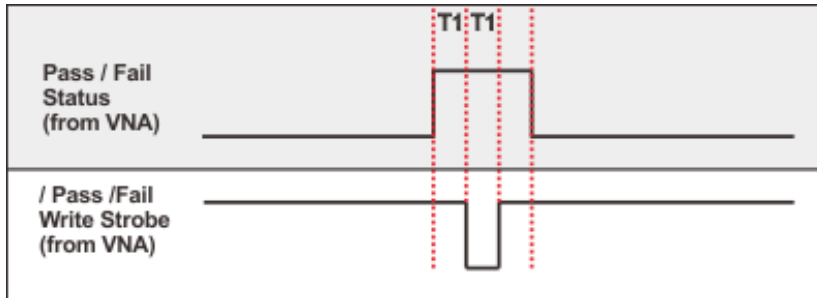

T1 = 1 μ s Pulse width and response time of Pass / Fail Strobe

T2 > 10 μ s Ready for Trigger lag

Ports A-F(H) Data Output Write Timing

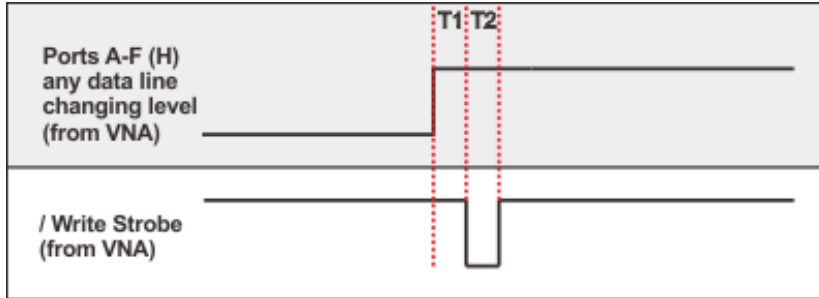

T1 = 1 μ s Write Strobe response time

T2 = 1 μ s Write Strobe pulse width

OUTPUT1|2 Data Output Write Timing

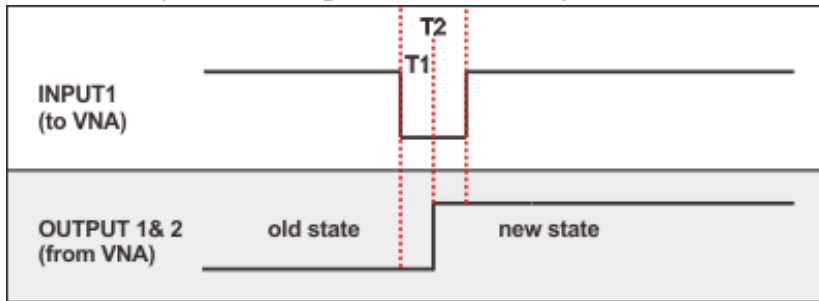

The old state to new state transition can be either low to high (as shown) or high to low.

T1 = 0.1 μ s Output1|2 response time

T2 = 0.1 μ s Input1 Strobe pulse width

Input / Output Electrical Characteristics

All Material Handler I/O Input and Output lines are TTL compatible.

Input and Input/Output lines

Lines carrying information IN (or bidirectional) to the VNA from the material handler.

Maximum Input Voltages:	-0.5 V to 5.5 V
TTL High level:	2.0 V to 5.0 V
TTL Low level:	0 V to 0.5 V

VNA Input and Input/Output Circuit Diagram

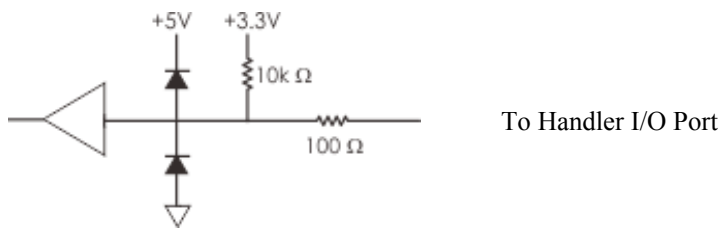

Note: The INPUT1 line does NOT have the 10K pullup resistor.

Output Lines

Lines carrying information OUT of the VNA to the material handler.

	Maximum Output Current:	-10 mA to 10 mA
Output Current	TTL High level:	-5 mA
	TTL Low level:	3 mA
Output Voltage	TTL High level:	2.0 V to 3.3 V
	TTL Low level:	0 V to 0.8 V

VNA Output Circuit Diagram

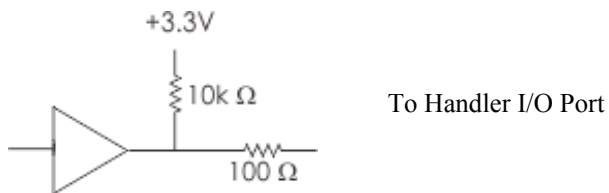

New PXI Programming Commands

The following are programming commands for PXIe release A.13.50. See What's New

Millimeter-Wave Commands

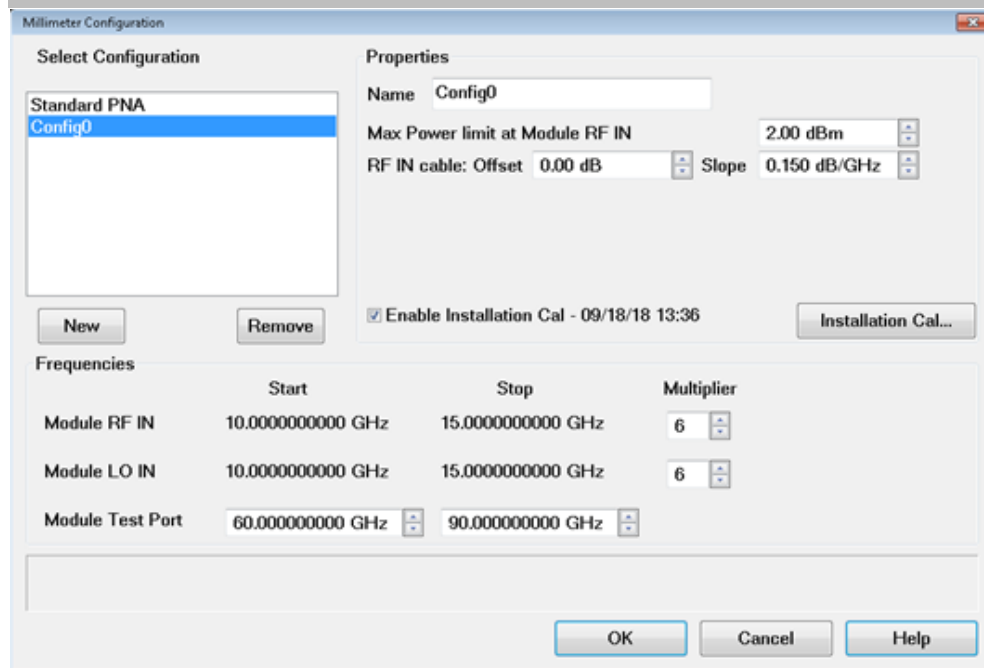

SYSTem:CONFigure:MWAVE:
 SYSTem:CONFigure:MWAVE:
 SYSTem:CONFigure:MWAVE:C
 SYSTem:CONFigure:MWAVE:(
 SYSTem:CONFigure:MWAVE:FREQ
 SYSTem:CONFigure:MWAVE:FREI
 SYSTem:CONFigure:MWAVE:FRE
 SYSTem:CONFigure:MWAVE:FREQ
 SYSTem:CONFigure:MWAVE:FREI
 SYSTem:CONFigure:MWAVE:FRE
 SYSTem:CONFigure:MWAVE:FF
 SYSTem:CONFigure:MWAVE:FF
 SYSTem:CONFigure:MWAVE:TS
 SYSTem:CONFigure:MWAVE:TSE
 SYSTem:CONFigure:MWAVE:TSE

The following are programming commands for PXIe release A.13.10. See What's New

Automatic Fixture Removal (AFR)

Selects

whether the
fixture is band
limited or not.

AFR:FIXTure:BLIMited[:STATe]

Selects

whether to use
DUT correction
or not when the
characterization
fixture is not
equal to the
DUT
measurement

AFR:FIXTure:CDUT[:STATe]

fixture.	
Selects Fixture Length A not equal to B correction.	AFR:FIXTure:CLENgth[:STATe]
Selects Fixture Match A not equal to B correction.	AFR:FIXTure:CMATch[:STATe]
Describes the fixture inputs (single ended or differential).	AFR:FIXTure:INPUts
Selects the number of fixtures to be characterized.	AFR:FIXTure:MEASurement
Refreshes preview data.	AFR:FIXTure:PREView
Reads the impedance profile of the calculated fixture model.	AFR:FIXTure:PREView:DATA[:IMPedance]?
Reads the impedance profile of the calculated fixture model at a specified position.	AFR:FIXTure:PREView:DATA[:IMPedance]:MARKer:Y?
Chooses the calibration reference Z0 after fixture removal.	AFR:FIXTure:REFZ
Restores the default AFR settings.	AFR:INITialize
Specifies the file paths of saved fixture data.	AFR:SAVE:FILEname

Assigns the ports for saved fixture data in several formats.	AFR:SAVE:PORTs
Sets the file type to save fixture data.	AFR:SAVE:TYPE
Selects all OPEN standards.	AFR:STANdard:ALLOpen[:STATe]
Selects all SHORT standards.	AFR:STANdard:ALLShort[:STATe]
Reads the impedance profile of the measured standard.	AFR:STANdard:DATA[:IMPedance]?
Reads the impedance of the measured standard at a specified position.	AFR:STANdard:DATA[:IMPedance]:MARKer:Y?
Sets the fixture length for the selected fixture (for 1X AFR only).	AFR:STANdard:EDIT:FLENgth
Sets the gate position for the selected fixture.	AFR:STANdard:EDIT:GATE
Sets the impedance for the selected term.	AFR:STANdard:EDIT:IMPedance
Sets the impedance method.	AFR:STANdard:EDIT:IMPedance:METHod
Loads the calibration standards data from a file.	AFR:STANdard:LOAD

Specifies fixture thru settings.	AFR:STANdard:THRU
Chooses the calibration standards.	AFR:STANdard:USE

Time Domain - Transform

Sets the alignment of the time domain measurement.	CALCulate:MEASure:TRANSform:TIME:ALIGNment
Transform ON OFF	CALCulate:MEASure:TRANSform:TIME:STATe
Mode (LowPass, BandPass)	CALCulate:MEASure:TRANSform:TIME[:TYPE]
Start Time	CALCulate:MEASure:TRANSform:TIME:START
Stop Time	CALCulate:MEASure:TRANSform:TIME:STOP
Center	CALCulate:MEASure:TRANSform:TIME:CENTer
Span	CALCulate:MEASure:TRANSform:TIME:SPAN
Step Rise Time	CALCulate:MEASure:TRANSform:TIME:STEP:RTIME
Set Low Pass Frequency	CALCulate:MEASure:TRANSform:TIME:LPFREQuency
Set/get the impulse width	CALCulate:MEASure:TRANSform:TIME:IMPulse:WIDTh
TD Toolbar	DISPlay:TOOLbar:TRANSform[:STATe]

Time Domain - Gating

ON OFF	CALCulate:MEASure:FILTer[:GATE]:TIME:STATe
Type (BandPass, Notch)	CALCulate:MEASure:FILTer[:GATE]:TIME[:TYPE]
Shape	CALCulate:MEASure:FILTer[:GATE]:TIME:SHAPE
Start	CALCulate:MEASure:FILTer[:GATE]:TIME:START
Stop	CALCulate:MEASure:FILTer[:GATE]:TIME:STOP
Center	CALCulate:MEASure:FILTer[:GATE]:TIME:CENTer
Span	CALCulate:MEASure:FILTer[:GATE]:TIME:SPAN
Set gate coupling parameters	CALCulate:MEASure:FILTer[:GATE]:COUple:PARAmeters

Time Domain - Window

Kaiser Beta	CALCulate:MEASure:TRANsform:TIME:KBESsel
Impulse Width	CALCulate:MEASure:TRANsform:TIME:IMPulse:WIDTh

Time Domain - Coupling

Enable trace coupling	SENSe:COUple:PARAmeter[:STATe]
Set transform coupling parameters	CALCulate:MEASure:TRANsform:COUple:PARAmeters

Time Domain - Marker

Specify measurement type for distance markers	CALCulate:MEASure:TRANsform:TIME:MARKer:MODE
Specify units for distance markers	CALCulate:MEASure:TRANsform:TIME:MARKer:UNIT
Set and return marker distance value	CALCulate:MEASure:MARKer:DISTance

Frequency Offset Commands

Freq Offset ON/Off	SENSe:FOM[:STATe]
Read available ranges	SENSe:FOM:CATalog?
Read number of ranges	SENSe:FOM:COUNT?
X-Axis display range	SENSe:FOM:DISPlay:SElect
Read range name	SENSe:FOM:RANGe:NAME?
Read range number	SENSe:FOM:RNUM?
Set range coupling	SENSe:FOM:RANGe:COUpled
Set sweep type	SENSe:FOM:RANGe:SWEep:TYPE
Set CW freq	SENSe:FOM:RANGe:FREQuency:CW
Set start freq	SENSe:FOM:RANGe:FREQuency:STARt
Set stop freq	SENSe:FOM:RANGe:FREQuency:STOP
Set offset value	SENSe:FOM:RANGe:FREQuency:OFFSet
Set divisor value	SENSe:FOM:RANGe:FREQuency:DIVisor
Set multiplier value	SENSe:FOM:RANGe:FREQuency:MULTiplier
Freq. Offset Segment Sweep	
ON OFF	SENSe:FOM:RANGe:SEGMENT
Add a segment	SENSe:FOM:RANGe:SEGMENT:ADD
Delete a segment	SENSe:FOM:RANGe:SEGMENT:DELeTe
Count the segments	SENSe:FOM:RANGe:SEGMENT: COUNT?
Center Frequency	SENSe:FOM:RANGe:SEGMENT:FREQuency:CENTer

Frequency Span	SENSe:FOM:RANGe:SEGMENT:FREQuency:SPAN
Start Frequency	SENSe:FOM:RANGe:SEGMENT:FREQuency:START
Stop Frequency	SENSe:FOM:RANGe:SEGMENT:FREQuency:STOP
Number of Points	SENSe:FOM:RANGe:SEGMENT:SWEep:POINTs
IF Bandwidth value	SENSe:FOM:RANGe:SEGMENT:BWID
IF Bandwidth control	SENSe:FOM:RANGe:SEGMENT:BWID:CONTRol
Source Power value	SENSe:FOM:RANGe:SEGMENT:POWer
Source Power control	SENSe:FOM:RANGe:SEGMENT:POWer:CONTRol
Sweep time value	SENSe:FOM:RANGe:SEGMENT:SWEep:TIME
Sweep time control	SENSe:FOM:RANGe:SEGMENT:SWEep:TIME:CONTRol

Scalar Mixer Converter (SMC) Commands

SMC network embed/deembed	SENSe:CORRection:COLLect:GUIDed:SMC:FSIMulator:NETWork:MODE
SMC filename	SENSe:CORRection:COLLect:GUIDed:SMC:FSIMulator:NETWork:FILEname
Import existing Phase Ref Cal or Source Power Cal	SENSe:CORRection:COLLect:GUIDed:SMC:IMPort
Use Thru or perform separate power calcs	SENSe:CORRection:COLLect:GUIDed:SMC:PWRCal:SEParate
Include Reverse SC12 sweep	SENSe:MIXer:REVerse

Include
input/output
match
correction

CALCulate:MEASure:CORRection:TYPE

Use Nominal
Incident Power

SENSe:MIXer:INPut:POWer:USENominal

Enable LO
Power Cal

SENSe:CORRection:COLLect:GUIDed:SMC:LO:PCAL

The following are new programming commands for PXIe release A.12.60.

SENSe:DUTControl:M9341:[MODule] commands

Sets and reads the DUT Control function state.	SENS:DUTC:M9341
Sets and returns I/O function type of the 8 bit Input/Output pins, for each I/O group.	SENS:DUTC:M9341:IOTY
Sets and reads the output voltage level of the M9341B 8bit I/O.	SENS:DUTC:M9341:LEV
Sets and reads the signal direction type of Parallel IO, for each IO pin.	SENS:DUTC:M9341:PIO:TYPE
Sets and reads the signal level of IO pin, high or low.	SENS:DUTC:M9341:PIO:LEV
Sets and reads the RFFE clock rate.	SENS:DUTC:M9341:RFFE:CLOC
Sets and reads the Slave Address ("SA" in GUI) for the specified command sequence	SENS:DUTC:M9341:CSEQ:SADD
Sets and reads the command sequence type for the specified command sequence.	SENS:DUTC:M9341:CSEQ:TYPE
Sets and reads the byte count for the specified command sequence.	SENS:DUTC:M9341:CSEQ:BCO
Sets and reads the address value for the specified command sequence.	SENS:DUTC:M9341:CSEQ:ADDR
Sets and reads the data values for the specified command sequence.	SENS:DUTC:M9341:CSEQ:DATA
Reads the data and parity value pairs from DUT for the specified command sequence.	SENS:DUTC:M9341:CSEQ:READ:DATA
Sets and reads the RFFE Command Sequence count.	SENS:DUTC:M9341:CSEQ:COUN

SOURce:DC commands

Sets and returns the negative current limit (in Amps) when output regulation is in voltage priority mode.	SOUR:DC:CURR:CLAM:NEG
Sets and returns the positive current limit (in Amps) when output regulation is in voltage priority mode.	SOUR:DC:CURR:CLAM:POS
Sets and returns a current output range in Amps.	SOUR:DC:CURR:RANG
Sets and reads the locked-down state of the output relays on SMU units with output relays	SOUR:DC:LOCK:OUT:REL:CLOS
Returns the module list which protection function is activated due to over current or voltage.	SOUR:DC:PROT:CAT
Sets and reads the DC output protection state.	SOUR:DC:PROT:ENAB
Sets and reads the protection voltage level for the DC output.	SOUR:DC:PROT:LEV
Resets the instrument's output protection circuit after a protection condition occurs.	SOUR:DC:PROT:RES
Sets and reads the DC output sequencing state.	SOUR:DC:SEQ
Sets and reads the DC output sequencing settling time.	SOUR:DC:SEQ:STIM
Sets and returns the output regulation mode	SOUR:DC:TYPE
Returns the date of execution output voltage calibration.	SOUR:DC:VOLT:CALB:DATE
Execute the output voltage calibration for both AO1 and AO2.	SOUR:DC:VOLT:CALB:EXEC
Returns the time of execution output voltage calibration.	SOUR:DC:VOLT:CALB:TIME
Sets and returns a voltage bandwidth to optimize the output response time with capacitive loads.	SOUR:DC:VOLT:BAND
Sets and returns the positive voltage limit in Volts when output regulation is in current priority mode.	SOUR:DC:VOLT:CLAM
Sets and returns a voltage output range in Volts.	SOUR:DC:VOLT:RANG

The following are new programming commands for PXIe release A.12.50. See What's New

SENSe:AMPLifier:M9379 commands (Only for M9485A)

Returns the total number of M9379A amplifier modules	SENS:AMPL:M9379:COUNT?
Sets and reads the attenuation of the M9379A amplifier 1	SENS:AMPL:M9379:MOD:ATT
Returns the chassis number	SENS:AMPL:M9379:MOD:CHAS
Sets and reads the status of M9379A control.	SENS:AMPL:M9379:MOD:CONT
Sets and reads the path for the M9379A amplifier 1.	SENS:AMPL:M9379:MOD:PATH
Sets and reads the status of M9379A power.	SENS:AMPL:M9379:MOD:POW
Reads the slot number where the M9379A is located.	SENS:AMPL:M9379:MOD:SLOT?
Sets and reads the path for the M9379A switch	SENS:AMPL:M9379:MOD:SWIT:PATH

The following are new programming commands for PXIe release A.03.00. See What's New

CALCulate commands

Resets the currently-stored data points	CALC:HOLD:CLEAR
Sets the type of trace hold to perform	CALC:HOLD:TYPE
Returns the number of segments used in a limit test	CALC:LIMit:SEGMENT:COUNT?
Sets and reads the scope of Coupled Markers	CALC:MARK:COUP:METHOD

Ground Loop De-embedding/Embedding commands

De-embedding

Sets and returns the Capacitance value	CALC:FSIM:GLOop:DEEMbed:PARAmeters:C
Sets and returns the Inductance value	CALC:FSIM:GLOop:DEEMbed:PARAmeters:L
Sets and returns the Resistance value	CALC:FSIM:GLOop:DEEMbed:PARAmeters:R
Turns ON or OFF De-embedding	CALC:FSIM:GLOop:DEEMbed:STATe
Specifies the circuit model type	CALC:FSIM:GLOop:DEEMbed:TYPE
Specifies the filename of the s1p file to load	CALC:FSIM:GLOop:DEEMbed:USER

Embedding

Sets and returns the Capacitance value	CALC:FSIM:GLOop:EMBed:PARAmeters:C
Sets and returns the Inductance value	CALC:FSIM:GLOop:EMBed:PARAmeters:L
Sets and returns the Resistance value	CALC:FSIM:GLOop:EMBed:PARAmeters:R
Turns ON or OFF Embedding	CALC:FSIM:GLOop:EMBed:STATe
Specifies the circuit model type	CALC:FSIM:GLOop:EMBed:TYPE
Specifies the filename of the s1p file to load	CALC:FSIM:GLOop:EMBed:USER

CSET commands

Returns a list of error term names for the given Cal Set
CSET:ETERm:CATalog?

Sets and returns the error term data
CSET:ETERm:DATA

DISPlay commands

Sets and returns the X-axis position of the Limit Line Pass/Fail indicator
DISP:WIND:ANN:LIM:XPOStion

Sets and returns the Y-axis position of the Limit Line Pass/Fail indicator
DISP:WIND:ANN:LIM:YPOStion

Display marker symbols above trace or not
DISP:WIND:ANN:MARK:SYMB:ABOVe[STATe]

SENSe commands

Returns a list of all name-value pairs in cal set
SENS:CORR:CSET:ITEM:CATalog?

Add or change a name-value pair in the Cal Set
SENS:CORR:CSET:ITEM[:DATA]

Sets and returns the ECAL over range state
SENS:CORR:PREF:ECAL:OVRrange[:STATe]

Computes the error correction terms, turns Correction ON, and saves the calibration to an existing, specified Cal Set
SENS:CORR:COLL:GUID:ETER:COMPute

Sets the frequency step size across the selected frequency range
SENS:SWE:STEP

SYSTem commands

Returns the maximum possible number of channels
SYSTem: CAPability:CHAN:MAX[:COUNt]?

Returns whether or not the analyzer has FOM Opt. 080 installed
SYSTem: CAPability:FOM:EXISTs?

Returns whether or not there is a receiver attenuator on the specified port
SYSTem: CAPability:HARDware:ATTenuator:RECeiver:EXISTs?

Returns the maximum amount of receiver attenuation on the specified port	SYSTem: CAPability:HARDware:ATTenuator:RECeiver:MAXimum?
Returns the step size of the receiver attenuator on the specified port	SYSTem: CAPability:HARDware:ATTenuator:RECeiver:STEP[:SIZE]?
Returns the maximum amount of source attenuation on the specified port	SYSTem: CAPability:HARDware:ATTenuator:SOURce:MAXimum?
Returns the step size of the source attenuator on the specified port	SYSTem: CAPability:HARDware:ATTenuator:SOURce:STEP[:SIZE]?
Returns whether or not the specified port number has a reference bypass switch	SYSTem: CAPability:HARDware:RBSWitch:EXISTS?
Returns the maximum specified frequency of the analyzer	SYSTem: CAPability:PRESet:FREQuency:MAXimum?
Returns the minimum specified frequency of the analyzer	SYSTem: CAPability:PRESet:FREQuency:MINimum?
Returns the maximum number of windows	SYSTem: CAPability:WINDows:MAXimum
Returns the maximum number of traces per window	SYSTem: CAPability:WINDows:TRACes:MAXimum?
Returns the maximum leveled source power setting	SYSTem:CAPability:ALC:POWer:MAXimum[:LEVel]?
Returns the minimum leveled source power setting	SYSTem:CAPability:ALC:POWer:MINimum[:LEVel]?
Returns a list of names of the internal DC receivers	SYSTem:CAPability:HARDware:DC:RECeiver:INTernal:CATalog?
Returns the number of internal DC receivers in the analyzer	SYSTem:CAPability:HARDware:DC:RECeiver:INTernal:COUNT?
Returns a list of names of the internal DC sources	SYSTem:CAPability:HARDware:DC:SOURce:INTernal:CATalog?
Returns the number of internal DC sources in the analyzer	SYSTem:CAPability:HARDware:DC:SOURce:INTernal:COUNT?
Returns a list of test port names	SYSTem:CAPability:HARDware:PORTs:CATalog?
Returns the number of test ports	SYSTem:CAPability:HARDware:PORTs:COUNT?
Returns a list of internal test port names	SYSTem:CAPability:HARDware:PORTs:INTernal:CATalog?
Returns the number of internal test ports	SYSTem:CAPability:HARDware:PORTs:INTernal:COUNT?
Returns the port number	SYSTem:CAPability:HARDware:PORTs:PNUMber?
Returns a list of source port names	SYSTem:CAPability:HARDware:PORTs:SOURce:CATalog?
Returns the number of source ports	SYSTem:CAPability:HARDware:PORTs:SOURce:COUNT?

Returns a list of internal source port names	SYSTem:CAPability:HARDware:PORTs:SOURce:INTernal:CATalog?
Returns the number of internal source ports	SYSTem:CAPability:HARDware:PORTs:SOURce:INTernal:COUNT?
Returns the number of receivers in the analyzer	SYSTem:CAPability:HARDware:RECEiver:INTernal:COUNT?
Returns the number of sources in the analyzer	SYSTem:CAPability:HARDware:SOURCe:COUNT?
Returns the list of supported Noise Bandwidth values when using a noise receiver	SYSTem:CAPability:NBW:NOISe:CATalog?
Returns the list of supported Noise Bandwidth values when using the NA receiver for noise measurements	SYSTem:CAPability:NBW:STD:CATalog?
Returns the list of supported Resolution BW values for the IMSpectrum channel	SYSTem:CAPability:RBW:IMS:CATalog?
Returns a comma separated list of either VISA address strings or aliases	SYSTem:COMMunicate:VISA:RDEvice:FiND?
Sets or returns the timeout value for VISA pass-through commands	SYSTem: COMMunicate:VISA:RDEvice:TIMEout?
Returns the system date	SYSTem:DATE?
Returns front panel history	SYSTem:HISTory:FPANel?
Returns SCPI history	SYSTem:HISTory:SCPI?
Set and return whether the keys are displayed or not	SYSTem:PREFerences:ITEM:KEYS
Set and return whether the Coupled Markers setting controls the ON OFF state of coupled markers	SYSTem:PREFerences:ITEM:MCControl
Set and return whether Coupled Markers is set to Channel or All after Preset	SYSTem:PREFerences:ITEM:MCMethod
Set and return whether Coupled Markers is set to ON or OFF after Preset	SYSTem:PREFerences:ITEM:MCPReset
Set and return whether to draw limits lines in Red	SYSTem:PREFerences:ITEM:REDLimits
Set and return whether to treat marker 10 as a reference marker	SYSTem:PREFerences:ITEM:REFMarker
Returns the system time	SYSTem:TIME?

The following are new programming commands for PXIe release A.02.00. See What's New

PXIe Speed Enhancement commands

Set logic of the index line	CONT:HAND:EXT:INDEX:LOG
-----------------------------	-------------------------

Trigger multiple channels	SYST:CHAN:SING:COMB
---------------------------	---------------------

Shared Memory Data Transfer commands	SYST:DATA:MEM
--------------------------------------	---------------

PXI Capability commands	SYST:CAP:HARD:MODule
-------------------------	----------------------

Remotely Specifying a Source Port

In the 'not-too-distant past', it was a simple task to specify a VNA source port. It was either port 1 or port 2. Now, for the following reasons, it is not so simple:

- **Internal 2nd sources** are now offered on various VNA models. However, some source ports do not have a port number. One example is the second source on the PNA-X 2-port model (option 224). Learn more about Internal Second Sources.
- **External sources** can now be controlled by the VNA as though they are internal sources. External sources do not have a source port number, but use String names as identifiers.
 - **For FCA ONLY:** Once configured using the [Configuration dialog](#), an external source can be selected remotely and controlled by the VNA by specifying the LOName using [SCPI](#) or COM.
 - **All other uses for External sources:** The external source must be configured and selected from the [External Source](#) dialog. You can then save an [Instrument State file](#), then recall that state file remotely.
- **Multiport test sets**...choose between ports 1 through port N, where N is the number of ports on the test set. You still use a port number, but this port number refers to a logical port. The Port mapping feature maps the logical port to a physical port. Learn more about Multiport test sets.
- **iTMSA (Opt S93460A/B)** When this option is present, the string names for balanced source ports are returned with the appropriate COM and SCPI commands. For example, "SE Port 1" is used to access 'Single-ended Port 1'.

Source Port String Names

The VNA User Interface (UI) makes it easy to configure and select the sources and ports. Remotely however, string names are used now, in addition to port numbers, to specify a Source port.

COM - The existing COM commands specify source ports as numbers and they are still used. It is necessary to learn the port number from the string using the `GetPortNumber` Method. Port numbers are assigned dynamically depending on whether [external sources are selected](#) and the number of ports of the VNA.

- `SourcePortNames` Property
- `GetPortNumber` Method
- `SourcePortCount` Property.

An example:

```
dim app
```

```
set app = CreateObject("Agilentpna835x.application")
dim channel
set channel = app.Channel
dim portnum
portnum = Channel.GetPortNumber("Src2 Out1")
app.CreateMeasurement 1,"A",portnum
```

SCPI - ALL of the existing SCPI commands that specify a source port are extended to also allow the source port to be specified using string names. For example, send the following command to set the power on Src2 Out1:

- **SOUR:POW 5, "Src2 Out1"**
 - Use **Source:Cat?** to list the available source port string names.
-

Multi DUT Parallel Measurement (M9485A, M980xA, P50xxA)

Multi DUT parallel measurement allows you to measure several DUT at the same time. This can improve the measurement speed by reducing the number of sweep.

For example, the M9485A can support up to 24 ports. The hardware can output source power from all measurement ports at once, and all receiver can capture signals simultaneously. It is capable of measuring 24 identical individual 1-port devices at once, 12 2-port devices at once, 8 3-port device at once etc.

Note: (M9485A) Multi DUT parallel measurement is available only for M9376A. When your configuration includes any of M9377A, the Multi DUT parallel measurement is NOT available.

Multi DUT Parallel Measurement Structure

In a traditional VNA such as the E5080A, only one test port can output RF source signal at a time. As shown in the below diagram, new PXI/USB VNAs can control source output independently

Hence, PXI/USB VNAs are capable of measuring DUTs in parallel. Calibration types are identical on both instrument, however correction data is independent. Topologies are also identical but fixturing data are independent.

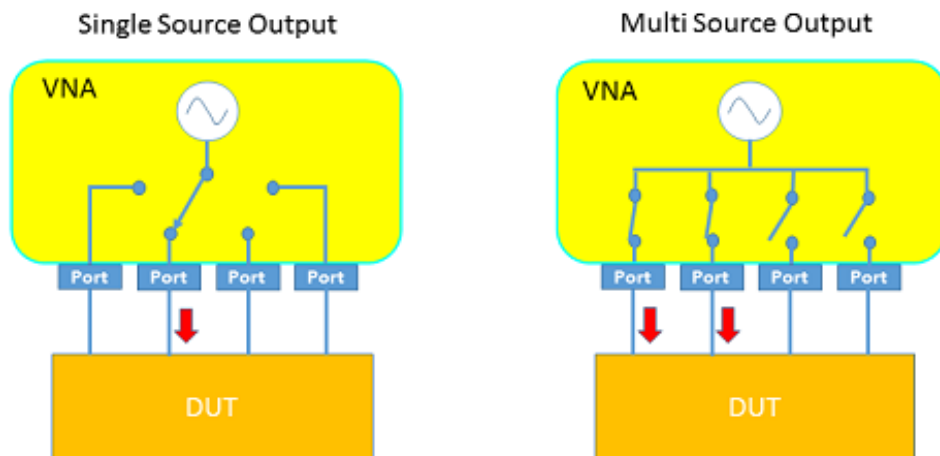

For example, in measuring two 3-port DUTs, by using ENA such as the E5080A, it requires 6 sweeps to perform the measurement. PXI/USB VNAs can do the same by 3 sweeps only and twice faster in total.

E5080A

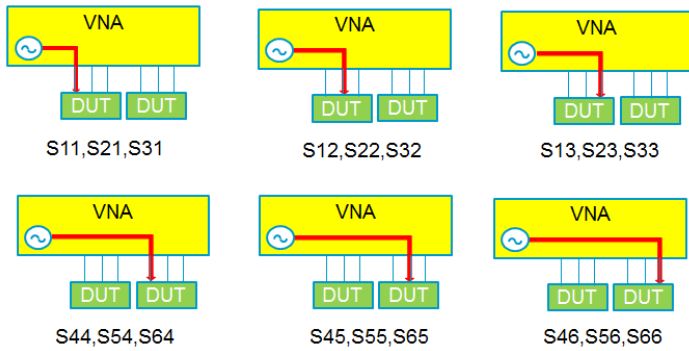

PXI/USB VNAs

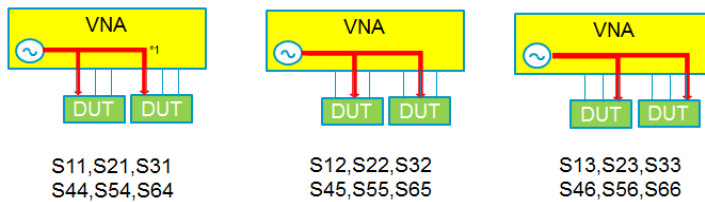

Multi DUT measurement is achieved by SCPI program not from Soft Front Panel. See [Perform Multi DUT Parallel measurements](#).

Multi DUT Measurement Limitations

There are some limitations on multi DUT parallel measurement because of analog hardware configuration.

- Parallel measurement is restricted to standard S-parameter channel. If there are SMC channel or other measurement classes, sequential measurement will be held. Parallel measurement does not support FOM. If FOM is enabled, sequential measurement will be held.
- Parallel measurement does not support FOM, Receiver Leveling. If FOM or Receiver Leveling is enabled, sequential measurement will be held.
- Port Power State of each multi-site DUT assignment should be same in order to enable parallel measurement. If they are different, sequential measurement will be held.

Example : 2-port DUT x 2 case

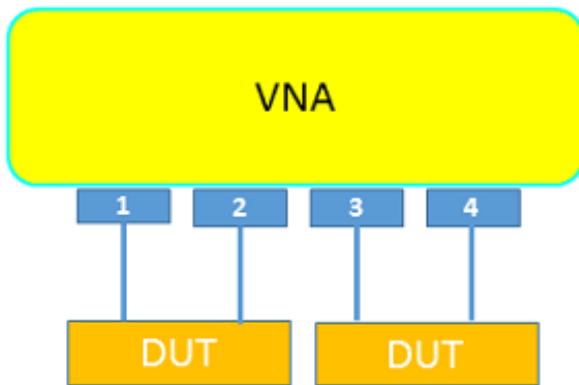

The master channel #1 has port 1 and 2. Also the slave channel #2 has port 3 and 4.

- Parallel Measurement is enabled when Port1 and 2 states are the same as Port 3 and 4, respectively.
example: {"Auto", "Auto", "Auto", "Auto"}, {"Auto", "Off", "Auto", "Off"}, {"Off", "Off", "Off", "Off"}
- Parallel Measurement is disabled when Port1 and 2 states are not the same as Port 3 and 4, respectively.
example: {"Auto", "Auto", "Auto", "Off"}, {"On", "Off", "Off", "Off"}

Port Power Value

If Port Power Coupling is disabled, the actual Port Power Values are depend on multi-site DUT assignment.

- Master channel: directly reflect user settings.
- Slave channels: duplicate the master channel state.

In the example 2-port DUT x 2 case above, if the user settings are {+1, +2, +3, +4} and the actual states are {+1, +2, +1, +2}, then the ports 3 and 4 settings are ignored and overwritten by the ports 1 and 2.

Port Power Limit

The actual Port Power Limits are depend on multi-site DUT assignment.

- Master channel: directly reflect user settings.
- Slave channels: duplicate the master channel state.

In the example 2-port DUT x 2 case above, If the user settings are following, the actual power of Port 2 and 4 are limited to -5dBm. Port 1 and 3 are 0 dBm (not limited).

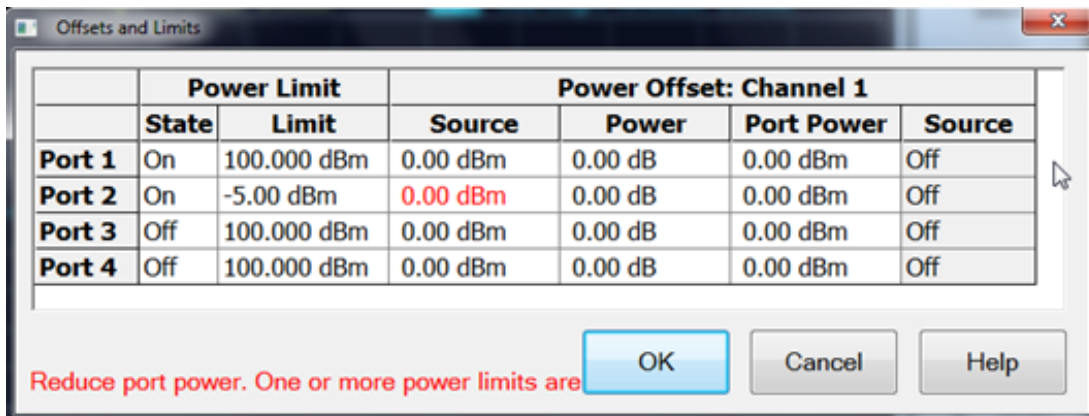

The screenshot shows a dialog box titled "Offsets and Limits" with a table of power settings for four ports. The table has two main sections: "Power Limit" and "Power Offset: Channel 1". The "Power Limit" section has columns for "State", "Limit", and "Source". The "Power Offset: Channel 1" section has columns for "Power", "Port Power", and "Source".

	Power Limit		Power Offset: Channel 1			
	State	Limit	Source	Power	Port Power	Source
Port 1	On	100.000 dBm	0.00 dBm	0.00 dB	0.00 dBm	Off
Port 2	On	-5.00 dBm	0.00 dBm	0.00 dB	0.00 dBm	Off
Port 3	Off	100.000 dBm	0.00 dBm	0.00 dB	0.00 dBm	Off
Port 4	Off	100.000 dBm	0.00 dBm	0.00 dB	0.00 dBm	Off

Below the table, there is a red warning message: "Reduce port power. One or more power limits are". To the right of the message are three buttons: "OK", "Cancel", and "Help".

Last Modified:

26-Mar-2015 First Release

The FIFO Data Buffer

The FIFO (First-IN, First-OUT) data buffer is a circular buffer that allows very fast Read-Write access.

- When enabled, all the data gathered is placed into a 4 GB FIFO buffer.
- You can write to, and simultaneously read from, the FIFO buffer.
- A maximum of 1 million data points can be read for each query.
- REAL / IMAGINARY pairs is the ONLY supported format for the FIFO buffer.
- A preset or instrument state recall will turn off the FIFO buffer collection.
- When more than one measurement is present, data from each measurement is stored in the FIFO buffer in the following order. These measurements are separated into lines for easier reading.

4-port models

R, A, B, C, D,
R/R, A/R, B/R, C/R, D/R,
R/A, A/A, B/A, C/A, D/A,
R/B, A/B, B/B, C/B, D/B,
R/C, A/C, B/C, C/C, D/C,
R/D, A/D, B/D, C/D, D/D

2-port models

R1, R2, A, B,
R1/R1, R2/R1, A/R1, B/R1
R1/R2, R2/R2, A/R2, B/R2
R1/A, R2/A, A/A, B/A
R1/B, R2/B, A/B, B/B

S-parameters are pre-defined, ratioed-receiver measurements. [Learn more](#). S-parameters are placed in the FIFO in order based on their underlying receivers. For example, S21 is placed into

the FIFO in the same manner as B/R1.

Fast CW

In Fast CW mode the VNA display is not updated. There is no background computation or other 'interference' from the VNA computer. Therefore, data is acquired real-time.

The following **requirements** must be met **before** sending the Fast CW command.

- FIFO is ON
- A single channel is being measured. Other channels can be in Hold.
- All measurements are acquired in a single sweep.

IMPORTANT - Fast CW and IF Bandwidth setting

- IF Bandwidth of **10 kHz and lower** - Data is transferred immediately to the FIFO after every acquisition.
- IF Bandwidths **greater than 10 kHz** - Data is transferred to the FIFO in groups. A triggered acquisition is NOT placed into the FIFO buffer until either the total number of points is completed, or an intermediate group of points is finished. The number of points within a group differs for each IF Bandwidth setting.

Notes:

- See example programs in SCPI and COM.
- Fast CW sets the number of data points, overwriting the standard channel setting.
- When exiting Fast CW, the FIFO data buffer is cleared.
- External trigger signals are allowed only through the rear-panel Trig In connector - NOT the Aux1 and Aux2 In connectors.
- An error message appears if triggering is sent to the VNA faster than it can respond.

Fast Groups with FIFO Data Buffer

With this speed optimization feature, interaction with Windows or other VNA 'overhead' calls are suspended, allowing very fast and predictable measurement timing.

Fast Groups is automatically enabled when the following **requirements** are met:

- FIFO is ON

- A single channel is being measured. Other channels can be in Hold.
- All measurements are acquired in a single sweep.
- **Group trigger is enabled** with count > 1.

Notes:

- Fast CW can **NOT** be used with Fast Groups.
- Fast Groups and Fast CW Segments were designed to be used together, but not required.
- The FIFO Tester example program demonstrates this feature.

Fast CW Segments with FIFO Buffer

In this optimization feature, each CW segment (where the start and stop frequency is identical) within a channel is measured at speeds as fast as the Fast CW mode sweep.

Fast CW Segments is automatically enabled when the following **requirements** are met:

- FIFO is ON
- Start and stop frequency of a segment is identical.
- External trigger signals are allowed only through the rear-panel Trig In connector - NOT the Aux1 and Aux2 In connectors.

Notes:

- Fast CW can **NOT** be used with Fast CW Segments.
- The sweep can include non-CW segments, but these are not acquired in Fast mode.
- Fast Groups and Fast CW Segments were designed to be used together, but not required.
- The FIFO Tester example program demonstrates this feature.
- In Fast CW Segments, when data is not being acquired in real-time, the following message appears:
Caution: Sweep time jitter. Try reducing the number of segments. To avoid this error, reduce the number of segments in the channel.

Other Antenna Features

Point Averaging

This feature is selected on the [Average](#) dialog.

When selected, each data point is measured the specified number of averages before stepping to the next data point. When [point trigger](#) is selected, only one trigger is required for each data point regardless of the number of averages.

Point Sweep

This feature is selected on the [Sweep Setup](#) dialog.

In Point Sweep mode, the VNA measures both the forward and reverse parameters at each frequency point before stepping to the next frequency. The display trace is updated as each data point is measured. Point sweep is the same as stepped sweep mode of the 8510 and 8530.

Trace Triggering

This feature is selected under [Trigger Mode](#) on the Trigger dialog.

Available ONLY when [Point Sweep](#) is selected. Each trigger signal causes two identical measurements to be triggered separately - one trigger signal is required for each measurement. Other trigger mode settings cause two identical parameters to be measured simultaneously.

Trace triggering is NOT permitted when a channel is using a 2 port (or more) S-Parameter calibration.

See Also

- [Pulsed Measurements](#)
 - [Frequency \(Security\) Blanking](#)
 - [External Triggering](#)
-

Frequency Converter Application

Option M937xA-009, P937xA-S97080 and S97082A, and M9485A-009 allows Scalar Mixer Converter (SMC) measurements on a maximum of four ports.

In this topic:

- [FCA Options Explained](#)
- [SMC Overview](#)
- [Requirements and Limitations](#)
- [How to make SMC Measurements](#)
 - [Create a Measurement](#)
 - [Make Measurement Settings](#)
 - [Sweep Tab](#)
 - [Segment Sweep](#)
 - [Power Tab](#)
 - [Mixer Setup Tabs](#) (separate topic)
 - [Select X-axis Display](#)
 - [Save Trace Data](#)

See Also

- [SMC Measurements and Calibrations](#)
 - [SMC + Phase](#)
- [Configure an External LO Source](#)
- For a detailed understanding of FCA, see our [Mixer Measurements App Notes](#).

FCA Options Explained

- M937xA Option 009 or P937xA Option S97080A/S97082A includes Scalar Mixer Converter (SMC) measurements. M9485A provides which includes **Scalar Mixer (SMC)** and **Vector Mixer (VMC)** Measurements.

Note: The **VMC** of the M9485A is provided by macro.

SMC Overview

	<p>Scalar Mixer Calibration</p> <p>See Hardware setup</p>
Overview	<p>Provides highest Scalar accuracy for measurements of conversion loss/gain.</p> <p>Optionally measures phase</p> <p>Combines SOLT and power-meter calibration.</p>
Measurements Offered	<p>Both forward and reverse directions.</p> <p>DUT can be connected to any VNA ports.</p>
Equipment Required	Power meter and sensor
	<p>Common equipment for SMC</p> <ul style="list-style-type: none"> • Mechanical cal kit or ECal module

See **Comparison of Mixer Characterization using New Vector Characterization Techniques**.

Requirements and Limitations

The following VNA features are **NOT** available with FCA:

- Analog Sweep (**Stepped sweep** mode only)
- **Log frequency** sweeps
- **ECal User Characterization** (can NOT be created in FCA channel)
- **Time Domain**
- **Balanced measurements**
- **Port extensions**
- **Some Fixturing Features**
- **PMAR (Power Meter As Receiver)**

How to make SMC Measurements

The following is an overview of how to make an FCA measurement:

1. CREATE an SMC Measurement.
2. **SETUP** the measurements.
3. CALIBRATE your measurement.

Create an SMC Measurement

1. Press **Setup** > **Main** > **Meas Class....**
2. Select **SMC**, then either:
 - **OK** delete the existing measurement, or
 - **New Channel** to create the measurement in a new channel.
3. See **SMC measurements** to learn about the parameters that are offered in each.

How to make SMC settings

Using **Hardkey/SoftTab/Softkey**

1. Press **Freq** > **Main** > **SMC Setup...**

Using a mouse

1. Click **Stimulus**
2. Select **Frequency**
3. Select **SMC**

Programming Commands

Valid Mixer Configuration / Sweep Type Combinations

Configuring the SMC Setup dialog can be challenging at first. **RED** messages like this one appear at the bottom of the Setup dialog to notify you of an invalid setup.

Unsupported mixer configuration and sweep type

At least one range (Input, LO, or Output) MUST be Fixed.

The following are the **Valid Mixer Configurations**:

Sweep Type	Input	LO	Output
Linear	Swept	Swept	Fixed
	Swept	Fixed	Swept
	Fixed	Swept	Swept
CW Time	Fixed	Fixed	Fixed
Power			

Tips

Although you will soon become comfortable navigating these tabs, at first it may be best to complete the dialog in the following order:

1. For 2-stage mixers, select **Mixer Setup** settings.
2. Select **Sweep tab** settings.
3. Select **Mixer Frequency** settings.
4. Select **Power** settings.
5. Select **Mixer (LO) Power** settings.

Sweep Tab - SMC dialog box help

Sweep Type

Linear Sweep frequency. Measurements are displayed on a standard grid with ten equal horizontal divisions. Learn how to [select the range to display on the X-Axis](#).

CW Time All ranges are set to a Fixed (CW) frequency, and the data is displayed versus time.

Segment Sweep Sweep user-defined segments. [Learn more](#).

Power Sweep Input or LO power.

X-axis Point Spacing (Available only with Segment Sweep) - [Learn about this feature](#)

Number of Points [Learn about this feature](#).

IF Bandwidth [Learn about this feature](#).

Phase Reference Point (SMC ONLY) [Learn about this feature](#).

Save...

Load...

[Learn about these buttons](#).

Power Tab - SMC dialog box help

Note: Set LO Power on the [Mixer \(LO\) Power tab](#).

Configures Input and Output power settings for an FCA measurement. Use the [Mixer Power tab](#) to set LO power.

Power ON (All channels) Check to turn RF Power ON or clear to turn power OFF for all channels.

Port Powers Coupled Check to set the same power level at the DUT Input and Output ports. The LO power is NOT coupled. Clear to set power levels independently for each test port. Uncouple power, for example, to apply more power in the reverse direction than in the forward direction
[Learn more about Setting Independent Port Power](#)

DUT Input / Output Port

Select the VNA port that is connected to the DUT Input and Output. For **VMC**, the DUT input must always be connected to VNA port 1 because of the need for a reference mixer on port 1.

Power Level Set the power level to the DUT Input port. To set power at the Output port, clear the **Port Powers Coupled** checkbox.

Source Attenuator Auto Check to automatically select the correct attenuation to achieve the specified input power. Clear, then select attenuator setting that is used achieve the specified Power Level. [Learn more about Source Attenuation.](#)

All VNA channels in continuous sweep must have the same attenuation value. [Learn more.](#)

Receiver Attenuator Specifies the receiver attenuator setting for the DUT port.

Source Leveling Choose from: **Internal** (normal operation), **Open Loop** (used only for [Wideband Pulse measurements](#)), or **Receiver - R1** for [Receiver Leveling](#).

DUT Input and Output Port Power Sweep

Available when Power (sweep) is selected on the [Sweep tab](#).

Input Start and Stop Power To set Start and Stop power at the Output port, clear the **Port Powers Coupled** checkbox.

Note: If your DUT requires more input power than this setting allows below 3.2 GHz, use the PNA-X **Hi-power mode**, available from the RF Path Configuration dialog. The disadvantage to this is higher harmonic content.

Power Points Number of power points to measure.

Power Step (Size) Calculated value from current Start, Stop, and Points settings. This setting can NOT be changed directly.

Save...

Load...

[Learn about these buttons.](#)

The following tabs are shared with all [Mixer / Converter Applications](#):

- [Mixer Frequency tab](#)
- [Mixer \(LO\) Power tab](#)
- [Mixer Setup tab](#)

Mixer Frequency tab - SMC Setup -dialog box help

Mixer Frequency

Input	Start/Stop	1.00000000 GHz	2.00000000 GHz	Calc Input
LO1	Fixed	500.000000 MHz	<input checked="" type="checkbox"/> Input > LO	
IF	Start/Stop	<input checked="" type="radio"/> + 1.50000000 GHz	2.50000000 GHz	Calc LO1
		<input type="radio"/> - 500.000000 MHz	1.50000000 GHz	Calc LO2
LO2	Fixed	500.000000 MHz	<input checked="" type="checkbox"/> IF1 > LO2	
Output	Start/Stop	<input checked="" type="radio"/> + 2.00000000 GHz	3.00000000 GHz	Calc Output
		<input type="radio"/> - 1.00000000 GHz	2.00000000 GHz	

[Learn about this dialog](#)

Mixer Setup tab - SMC Setup -dialog box help

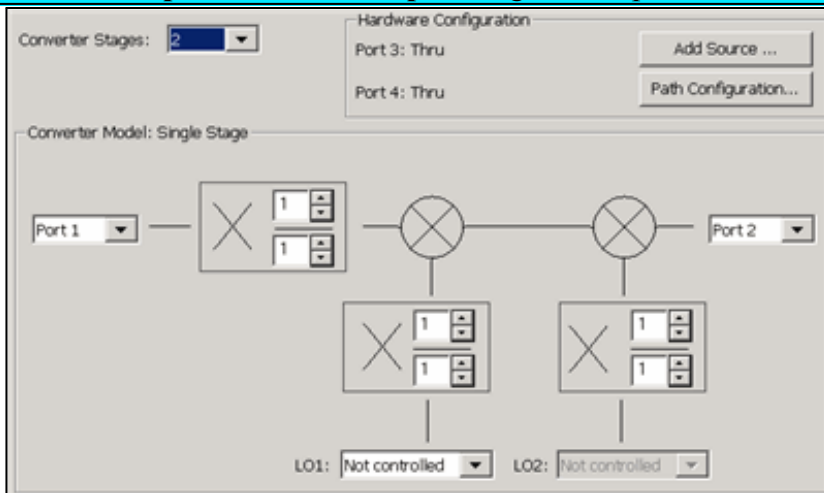

[Learn about this dialog](#)

Mixer (LO) Power tab - SMC Setup -dialog box help

Power On (All Channels)

LO1: Not Controlled
LO1 Power: -10.00 dBm
Source Leveling Mode: []

LO2: Not Controlled
LO2 Power: -10.00 dBm
Source Leveling Mode: []

Port Settings

Port 3
Source Attenuator: 5 dB
Receiver Attenuator: 0 dB

Port 4
Source Attenuator: 5 dB
Receiver Attenuator: 0 dB

Swept Power Settings

	Start	Stop	Step
LO1 Swept Power:	-10.00 dBm	0.00 dBm	0.050 dB
LO2 Swept Power:	-10.00 dBm	0.00 dBm	0.050 dB

Path Configuration...

[Learn about this dialog](#)

FCA Segment Sweep

The following settings appear on the Mixer Frequency tab when **Segment Sweep** is selected on the **Sweep tab**.

Mixer Frequency tab - Segment Sweep - SMC dialog box help

Mixer Frequency

Segment: 1 of 3 State: ON Add Delete

Input: Start/Stop 1.00000000 GHz 2.00000000 GHz Calc Input

LO1: Fixed 500.000000 MHz Input > LO

Output: Start/Stop + 1.50000000 GHz 2.50000000 GHz Calc LO
- 500.000000 MHz 1.50000000 GHz Calc Output

Num Pts: 21 Input Port: -10.00 dBm LO1 Port: -10.00 dBm

IF Bandwidth: 100.000 kHz Output Port: -10.00 dBm

How to configure a segment:

1. Click **Add**. Click **Delete** to remove a segment and renumber all subsequent segments.
2. State is **ON** by default. Click **OFF** and that segment will not be included in the sweep.

3. Configure **Frequency settings** for Input, LO, and Output ranges.

- For each segment, the same **sweep requirements** apply as a standard (non-segment) sweep. For example, at least one range **MUST** be Fixed (Start = Stop frequencies).
- The Input, Output, and LO frequencies of segments **ARE** allowed to overlap other segments.
- All segments must sweep in either the forward (Start<Stop) or reverse (Start>Stop) directions. Mixed sweep directions are **NOT** allowed.
- The following settings can be set independently for each segment:
 - **Number of Points** - Total number of points for all segments is limited to the **Max allowed by the VNA**.
 - **IF Bandwidth**
 - **Port Powers:** (Input, Output, LO 1, LO2). These settings override the settings on the **Power tab**.
- The following settings apply to **ALL** segments:
 - Number of Converter/Mixer Stages (1 or 2).
 - LO Source Selections
 - **All Input and LO Multipliers and Dividers**
 - **Source and Receiver Attenuator Settings**
 - **Source Leveling**
 - **Nominal Incident Power** (SMC only)
 - **X-Axis Display** (Input, LO1, LO2, Output) There must be at least two data points for this setting to be available.
 - **X-Axis Point Spacing** (vs Normal point spacing).
 - **SMC + Phase**
- Mixer Segment sweep data can be saved to a ***.S2PX** file (NOT *.S2P).
- Mixer Segment setup information is saved to a ***.MXRX** file. [Learn more](#).

Save...

Load...

[Learn about these buttons](#)

Apply and Interpolate FCA Cal Sets

In general, when a Cal Set covers a wider frequency range than the channel, the VNA will offer to interpolate the Cal Set when it is applied. [Learn more](#). However, with FCA measurements the LO frequency range may also be considered.

- **SMC measurements** ALWAYS IGNORE the LO frequency range. Therefore, if the Input and Output frequency ranges of the measurements are within those of the Cal Set, then the Cal Set is interpolated if necessary and applied. For example, this would allow you to perform ONE SMC calibration with Input range = the VNA frequency span, LO at 0 Hz, and Output range + the VNA frequency span. This Cal Set could be applied to ALL SMC measurements. [Learn more about applying SMC Cal Sets](#).

These same general concepts apply to **segment sweeps**. However, if ALL applicable frequency ranges (SMC: Input and Output) are NOT within those ranges of the measurement for ONE segment, then the Cal Set is NOT applied for ANY segment.

Select X-axis Display for FCA Measurements

Click **Sweep** > **Main** > **X-Axis Type**, then select the desired type.

When **Sweep Type** = **Linear**, you can choose to show the frequency range of any of the swept parameters on the X-axis.

For example, the following image shows an SMC Fixed Output response with the **Input frequency range** on the X-axis:

Output: 100 MHz (data trace)

Input: 2 GHz to 23 GHz (X-axis)

LO: 1.9 GHz to 22.9 GHz (not shown)

Marker annotation shows Output power at Input frequency.

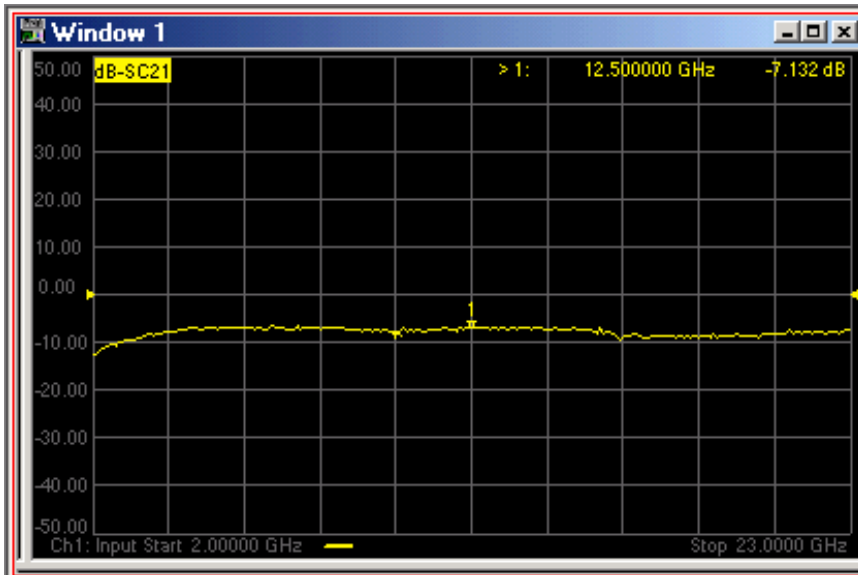

Save Trace Data

You can save your FCA measurement data in several standard formats.

Click **Save Recall** > **Save Other** > **Save Data...**

The following shows how CSV and SNP files are saved.

Mixer Trace Data

When you select **Mixer Trace Data**, the FCA data is saved to a CSV file in the following format:

```
#MIXER TRACE FILE,A.01.00
```

```
SegIndex, InputFreq, OutputFreq, LO1Freq, InputPower, LO1Power, SC21  
Mag (dB), SC21 Phase (Deg)
```

SNP Format

Each record contains 1 stimulus value and 4 parameters (total of 9 values) as follows:

```
Stim Real(p1) Imag(p1) Real(p2) Imag(p2) Real(p3) Imag(p3) Real(p4) Imag(p4)
```

where **pX** is the parameter depending on measurement type:

Measurement Type	p1	p2	p3	p4
Scalar	S11	SC21 (FWD)	SC12 (REV)	S22

- If correction is OFF, data is only saved for the active parameter. Zeros are saved for all other parameters.

- If correction is ON, data is saved for all of the parameters.

All files contain the following Header Information: Brackets [] contain parameters.

```
!Keysight [Instrument Model Number]: [version]
!Mixer S2P File: [Mixer Measurement Type]
!Parameters: [Parameter List]
!Calibration State: [On/Off]
```

```
!# Begin Mixer Setup
![Mixer Setup parameters listed here]
![Mixer Parameter 1]
.
.
![Mixer Parameter n]
!# End Mixer Setup
```

```
# [S2P data here]
```

Scalar Mixer/Converter Measurements (SMC)

The following information is unique to SMC:

- [SMC Hardware Setup](#)
- [Create an SMC Measurement](#)
- [SMC Parameters Offered](#)
- [The SMC Mixer Setup dialog](#)
- [Speed Up SMC Measurements](#)
 - [Use Nominal Incident Power](#)
 - [Apply a Cal Set or SMC Cal Type](#)
- [SMC Calibration](#)

See Also

[Programming Commands](#)

SMC Hardware Setup

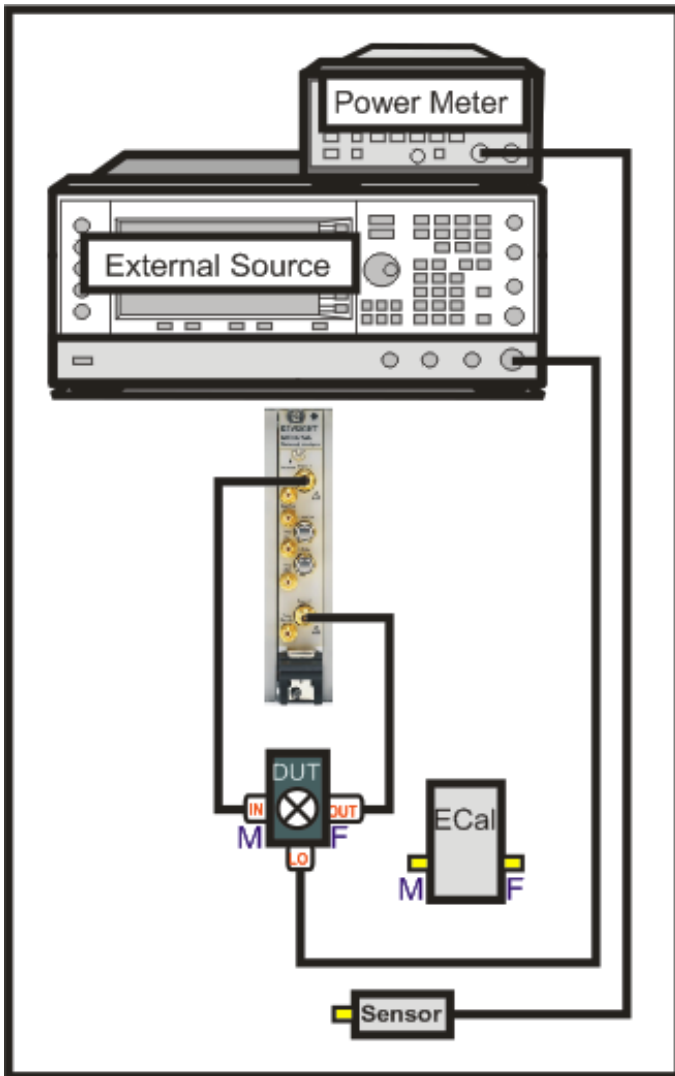

SMC requires a power meter/sensor, two sources, and a Cal Kit or ECal module

- Your DUT can be connected to any VNA ports. [Learn more.](#)
- Connect **External Source** to the VNA GPIB Controller port. Learn how to [Configure an External Source.](#)
- Connect the 10 MHz reference signal of an external source to the VNA.
- Use either a GPIB power meter or USB power sensor.

Create an SMC Measurement

1. Press **Setup** > **Main** > **Meas Class....**
2. Select **SMC**, then either:

- **OK** delete the existing measurement, or
- **New Channel** to create the measurement in a new channel.

3. An SC21 measurement is displayed.

SMC Parameters Offered

To select additional parameters to display, click **Trace**, then click on a new trace, then select a parameter from the list.

Important Note: Connecting your DUT to the VNA:

RF and **IF** terminology is NOT used in FCA because the VNA does not know how the DUT is labeled or how it will be used. Instead, the general terms **INPUT** and **OUTPUT** are used.

- **INPUT** - The DUT port being stimulated with frequencies before conversion.
- **OUTPUT** - The DUT port outputting converted frequencies.

INPUT and **OUTPUT** Frequencies are specified using the **Mixer Setup dialog box**.

The DUT input and output can be connected to any VNA ports.

Note: Although there are MANY configuration possibilities, the following images and descriptions show ONLY a DUT connected to VNA ports 1 and 2.

Legend:

Black are ratioed measurements (test port/reference receiver).

Green are unratioed measurements (either a test port OR reference receiver).

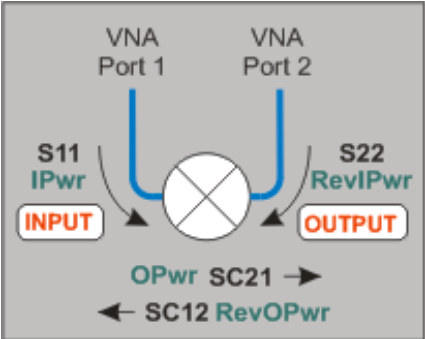
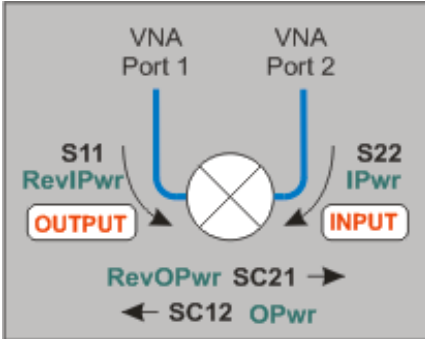
<p>DUT Input to VNA port 1</p> <p>DUT Output to VNA port 2</p>	<p>DUT Input to VNA port 2</p> <p>DUT Output to VNA port 1</p>
	
<p>Ratioed</p> <ul style="list-style-type: none"> • SC21 (Conversion Loss) Stimulus at Input, response at Output (B/R1). • SC12 (Reverse Isolation) Stimulus at Output, response at Input (A/R2) • S11 (Input match) Stimulus and response at Input (A/R1) • S22 (Output match) Stimulus and response at Output (B/R2) 	<p>Ratioed</p> <ul style="list-style-type: none"> • SC12 (Conversion Loss) Stimulus at Input, response at Output (A/R2) • SC21 (Reverse Isolation) Stimulus at Output, response at Input (B/R1) • S11 (Output match) Stimulus and response at Output (A/R1) • S22 (Input match) Stimulus and response at Input (B/R2)
<p>Unratioed Absolute test port receiver measurements. The receiver is automatically selected depending on the DUT configuration.</p> <ul style="list-style-type: none"> • IPwr (Incident Power) - stimulus and response at Input. • RevIPwr (Reverse Incident Power) - stimulus and response at Output. • OPwr (Output Power) - stimulus at Input, response at Output. • RevOPwr (Reverse Output Power) - stimulus at Output, response at Input. 	

SMC Mixer Setup

How to start the SMC Mixer Setup dialog

Using **Hardkey/SoftTab/Softkey**

1. Press **Sweep** > **Main** > **SMC Setup...** > **Mixer Setup** tab.

Using a mouse

1. Click **Stimulus**
2. Select **Sweep**
3. Select **SMC Setup...**
4. Select **Mixer Setup**

Programming Commands

The following SMC Mixer Setup dialog tabs are presented:

- **Sweep Tab** (shared with VMC)
- **Power Tab** (shared with VMC)
- **Mixer Freq Tab** (shared with all converter apps)
- **Mixer Power Tab** (shared with all converter apps)
- **Mixer Setup Tab** (shared with all converter apps)

Speed Up SMC Measurements

Using default SMC settings, any calibrated SMC measurement requires four sweeps. However, you can reduce the number of sweeps required by selecting one or more of the following settings.

- **Use Nominal Incident Power**
- **Apply Cal Set or Cal Type**
- To speed up a Swept LO measurement when using an external source for the LO, use **Hardware List (BNC)** Trigger setting . [Learn more.](#)

Use Nominal Incident Power

Click **Response**, then **Measure**, then **Use Nominal Incident Power**

Each data sweep of a fully corrected SMC transmission measurement actually requires FOUR data sweeps. When you clear **Use Nominal Incident Power**, the reference receiver (R1 or R2) does NOT

measure incident power. Instead, the incident power is assumed to be at the level that was set with the **Source Power Calibration** that is done as part of every SMC measurement. The degradation in accuracy is very negligible if the input or output of your DUT is well-matched.

This selection eliminates sweeps ONLY when both **Include Input Match** AND **Include Output Match** is cleared on the Cal Type dialog. [Learn more.](#)

Apply a Cal Set or SMC Cal Type

You can create an FCA measurement and apply an existing Cal Set as you can with any VNA measurement. Learn about **Cal Sets**. In addition, from a Cal Set, you can apply a specific SMC Cal Type to an existing SMC measurement.

How to apply an SMC Cal Type

1. **Create an SMC measurement**
2. Calibrate or apply an existing SMC Cal Set, then...

Using **Hardkey/SoftTab/Softkey**

1. Press **Cal** > **Main** > **Correction Methods...**

Programming Commands

Correction Method dialog box help

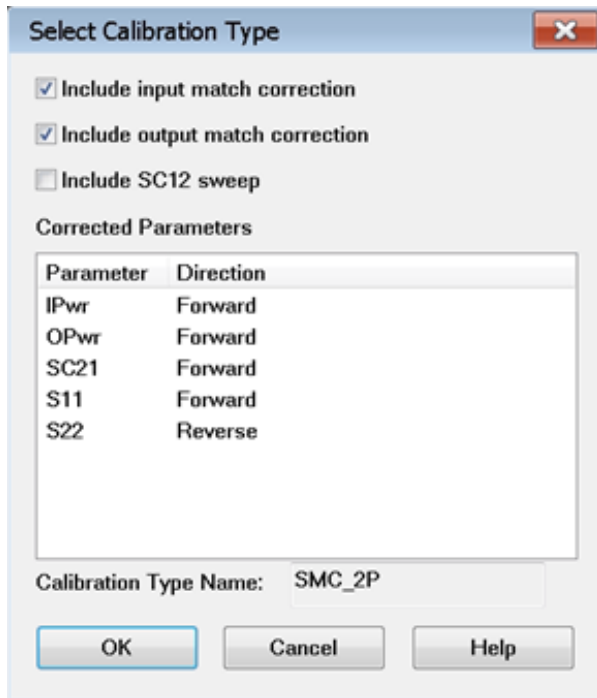

By default, each SMC calibration requires FOUR sweeps. Clearing boxes will eliminate sweeps and speed up your SMC measurements. The difference in speed is most noticeable when making fixed input or fixed output measurements with an external LO source.

Include input match correction Check to perform a sweep to measure and correct for INPUT match. Clear this box if the input of your mixer is well-matched to the VNA, or if your setup does not permit a valid S11 measurement.

Include output match correction Check to perform a sweep to measure and correct for OUTPUT match. Clear this box if the output of your mixer is well-matched to the VNA, or if your setup does not permit a valid S22 measurement.

Include SC12 Sweep Check to perform a reverse sweep to measure SC12.

- When checked (default setting), a calibrated SMC measurement sweeps in both forward (SC21) and reverse (SC12) directions.
- Clear this checkbox to eliminate sweeps in the reverse direction. This means that the following measurements will NOT be corrected: SC12, RevOPwr, RevIPwr.

Corrected Parameters Lists the parameters that **can** be corrected given the boxes that are currently checked. These parameters may not be currently measured.

Calibration Type Shows the type of SMC Cal that will be applied given the boxes that are currently checked.

Learn about [Use Nominal Incident Power](#)

How many sweeps can be eliminated?

Setting	Parameters Learn about parameter abbreviations	# of sweeps
ALL checked and clear Use Nominal Incident Power	IPwr,OPwr,RevIPwr,RevOPwr,SC21,SC12,S11,S224	Total
Perform this action...	to REMOVE these parameters...	and these sweeps
Clear "Include SC12"	Remove RevIPwr,RevOPwr,SC12	Removes 1
Clear "Include OUTPUT match"	Remove S22	Removes 1 when Nominal is checked*.
Clear "Include INPUT match"	Remove S11	Removes 1 when Nominal is checked*.
Check "Use Nominal Incident Power"	Remove IPwr, RevIPwr	May remove up to 2*
ALL cleared and check Nominal Incident Power	OPwr,SC21	1 Total

*S11 shares a sweep with IPwr and S22 shares a sweep with RevIPwr. Therefore, when **Include Input Match** or **Include Output Match** is checked, then checking Nominal incident power does nothing.

VMC measurement sweeps can NOT be eliminated.

SMC Calibration Overview

The [Cal All Wizard](#) guides you through the calibration process on the M937xA/P937xA.

Note: Before SMC Calibration, perform the [System Receiver Cal](#).

The [SMC Calibration Wizard](#) guides you through this process.

When applying a [Phase Reference cal set](#), step 1 (power cal) is NOT performed.

1. Connect a power meter / sensor to VNA Port 1. At each step of the input and output frequency, the VNA measures:
 - input match of the power sensor
 - source power of the VNA

2. Perform two Full 2-port calibrations: one over the INPUT frequencies and one over the OUTPUT frequencies of the DUT. (If your DUT is a linear device, the calibration uses only the INPUT frequency range.) Use either a mechanical calibration kit or an ECal module.

For Mixers / Converters with High-output Power

The Unknown Thru method is NOT valid when there is over 40 dB of combined loss in the Unknown Thru and calibration path. In this case, the following calibration and correction method is recommended.

- On the Cal Wizard **Modify Frequency** page, select Defined Thru or Flush Thru as the **Thru method**. When using an ECal module, also on the Modify Frequency page, disable (clear) **Do Orientation** due to very low power.
- After calibration, on the **Correction Method** dialog, CLEAR the **Include output match correction** and **Include SC12 Sweep** check boxes. Check ONLY **Include input match correction**.
- To learn more about High-power measurements, see our [App Notes](#).

SMC Cal Wizard

NOTE: The Smart Cal wizard is not available for the M937xA/P937xA

The following dialog boxes are presented during an SMC Calibration.

Indented steps are optional.

- **Calibration Setup**
 - **Waveguide/In-fixture/On-Wafer Setup**
- **Select DUT Connectors and Cal Kits**
 - **Modify Frequency Cal**
 - **Specify how the ECal module is connected**
- **Power Cal Settings**
- **SMC Cal Steps**
- **Calibration Completed**
- **Specify Adapter Delay**

How to Perform a SMC Calibration

1. Create an SMC measurement, then...

Using **Hardkey/SoftTab/Softkey**

1. Press **Cal** > **Main** > **Smart Cal...**

Using a mouse

1. Click **Response**
2. Select **Cal**
3. Select **Smart Cal...**

Programming Commands

SMC Calibration Setup dialog box help

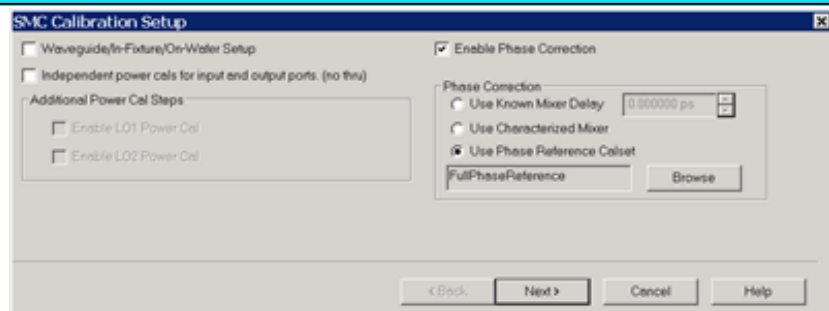

Allows you to review and change the settings for your SMC calibration.

Note: With release A.09.90 and before, checking both '**Independent power cals**' AND '**Use Phase Reference Calset**' would generate an error after performing the calibration. With releases AFTER A.09.90, the two settings are compatible.

Waveguide/In-fixture/On-Wafer Setup Click **Next** to launch the following Setup dialog box.

Independent power cals for input and output ports (no thru) Check if a Thru standard is NOT available. During the power cal, you will be prompted to connect the power sensor to the Input, then the Output port.

Additional Power Cal Steps

Enable LO1 / LO2 Power Cal Check when LO1 / LO2 is controlled (on the **Mixer Setup** tab) to perform a Power Cal on the LO source(s).

Phase Correction

Enable Phase Correction Check to enable Phase measurements.

Choose one of the following methods to specify the delay through the characterized mixer. With the first two methods, the phase delay through a Calibration Mixer is measured and compared to the known delay, either entered, or stored in an *.S2PX file.

- **Use Known Mixer Delay** Enter the fixed, known, delay through the calibration mixer.
- **Use characterized mixer** Select, then browse to the *.S2P file that characterizes the calibration mixer. Use an *.S2PX file when making segmented SMC + Phase measurements. [Learn more](#). Use either of the following two methods to characterize the Cal Mixer over the SMC measurement frequency range:
 1. Use the Mixer Characterization Wizard. (Click **Response**, then **Cal**, then **Mixer Characterization Wizard**.) The Cal Mixer has the same requirements as the **VMC Cal Mixer**. [Learn more](#).
 2. In a calibrated VMC channel, measure the group delay of the calibration mixer, then save to an *.S2P or *.S2PX file. However, a characterized mixer is required to calibrate the VMC channel.
- **Use Phase Reference Calset** Select, then browse to the Phase Reference Calset that covers the frequency range of the current measurement. [Learn more about SMC with a Phase Reference Calibration](#).

Waveguide/In-fixture/On-Wafer Setup dialog box help

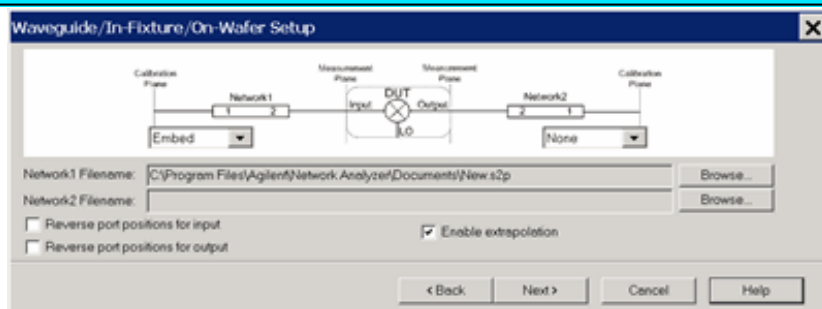

This dialog box appears ONLY if you checked the **Waveguide/In-fixture/On-Wafer Setup** box in the previous **Cal Setup** dialog.

Allows you to embed or de-embed circuit networks on the input and output of your mixer under test.

For Network1 (Input) and Network2 (Output) select **Embed**, **De-embed**, or **None**.

Browse Click to navigate to the .S2P file that models the network to embed or de-embed.

Reverse port positions for input/output Check to cause the Fixture/Adapter to be configured with Port 2 connected to the VNA and Port 1 to be connected to the DUT. The image in the dialog is updated to reflect that change.

Enable Extrapolation Check (default setting) to apply a simple extrapolation when the S2P file has a narrower frequency range than the channel. The values for the first and last data points are extended in either direction to cover the frequency range of the measurement. A warning message is also displayed when extrapolation is necessary.

To Embed or De-embed

- When you have a 2 port network that needs to be connected between the Cal reference plane and the DUT during the measurement, but it is NOT present during the calibration, then that network has to be **De-Embedded** from the port in question during the calibration. In other words, De-Embedding in FCA calibration extends the calibration reference plane to include the two port network.
- When you have a 2 port network that is included as part of the calibration reference plane but has to be disconnected during the measurement, then that 2-port network has to be **Embedded** for the port in question during the calibration. In other words, Embedding in FCA calibration retracts the calibration reference plane to exclude the two port network during the measurement.

Notes

- Interpolation is performed when more frequencies are included in the file than in the channel, and the data points do not exactly match those of the measurement.

Select DUT Connectors and Cal Kits dialog box help

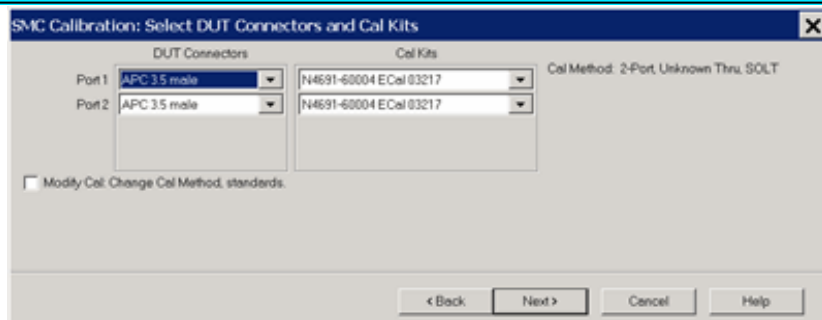

Allows you to specify the connector type and Cal Kit for each DUT port.

Port n For each listed VNA port, specify the DUT connector type and gender, and the Cal Kit

to use.

Note: If your DUT connectors are:

- **Waveguide** Change the system impedance to 1 ohm before performing a calibration. See [Setting System Impedance](#).
- **Not listed** (male and female) Select **Type A** as the connector type. Type A requires a calibration kit file containing the electrical properties of the standards used for calibration (see [Calibration kits](#)).
- **Unspecified** (like a packaged device) Select **Type B** as the connector type. Type B requires a calibration kit file containing the electrical properties of the standards used for calibration (see [Calibration kits](#)).

Modify Cal Check, then click **Next**, to start the [Modify Frequency Cal dialog](#).

Source Cal Settings Click to start the [Source Cal Settings dialog](#).

Modify Frequency Cal dialog box help

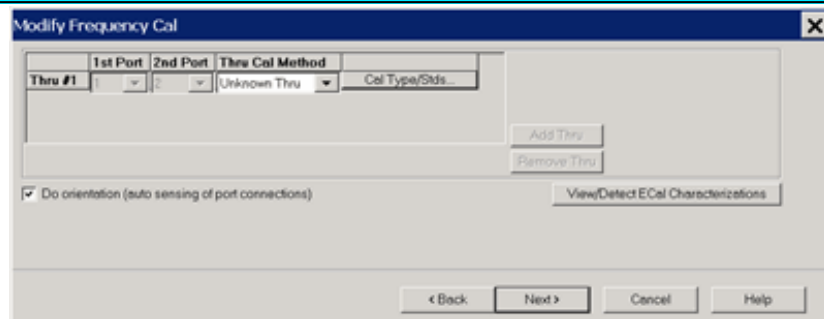

This dialog appears only when **Modify Cal** is checked on the previous dialog.

The following selections are available ONLY if using an ECal module.

Do orientation When this box is checked (default) the VNA senses the ECal model and direction in which the ECal module port is connected to the VNA ports. If power to the ECal module is too low, it will appear as if there is no ECal module connected. If you use low power and are having this problem, clear this check box to provide the orientation manually. Orientation occurs first at the middle of the frequency range that you are calibrating. If a signal is not detected, it tries again at the lowest frequency in the range.

Power Cal Settings dialog box help

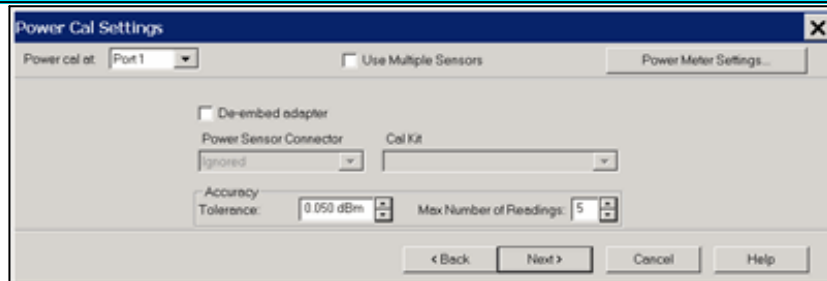

Note: A **Use Power Table** checkbox (not shown) is available when a mmWave SMC measurement is active. Learn more.

Power Cal at: Select the source port for which a Power Calibration will be performed. The source and receiver correction will be transferred to all other sources and receivers involved in the S-parameter measurements.

Use Multiple Sensors (NOT available with mmWave SMC measurements.) Check this box when you want to use more than ONE power sensor to cover the measurement frequency range. The dialog is replaced with the **Multiple Sensors** dialog (see following image). When "Use Multiple Sensors" is cleared (default setting), connect only ONE sensor to the VNA.

Power Meter Settings Click to start the standard **Power Meter Settings** dialog.

De-embed (power sensor) adapter When the power sensor connector is NOT the same type and gender as the DUT connector for the specified port, then for optimum accuracy, extra cal steps are required to measure and correct for the adapter that is used to connect the power sensor to the reference plane.

Clear this box to NOT compensate for the added adapter.

Check this box to perform extra calibration steps to measure and correct for the adapter.

Then select the **Power Sensor Connector** type and gender of the power sensor. "Ignored" does NOT compensate for the added adapter, just as if the checkbox were cleared.

When this connector matches the DUT connector for the same port, then the VNA assumes that there is no adapter. Extra cal steps are NOT required and the Cal Kit selection is not available.

Otherwise, select the **Cal Kit** to be used to calibrate at the adapter.

See **Accuracy Settings** below.

Specify how the ECal module is connected dialog box help

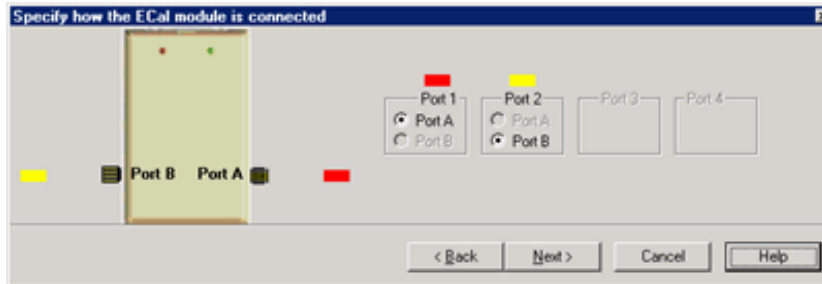

This dialog box appears when the **Do orientation** checkbox in the previous **Modify Frequency** dialog box is cleared.

Click the ECal Port that is connected to each VNA port.

SMC Calibration Steps dialog box help



Power Level at which to perform the Power Cal.

It is usually best to set power level to 0 dBm at the power sensor because the power sensor is calibrated at that level. Lower power levels will yield a slower and noisier calibration.

If an external component is used between the PNA-X test port and the calibration reference plane, then adjust the power level so that the power at the sensor is about 0 dBm if possible.

The current source attenuation value is shown on the dialog.

LO Power Cal (Optional) When enabled, perform a **Source Power Cal at the DUT LO connector**. An LO must already be selected. **Learn how**. The power level of the LO source calibration is set on the **(LO) Power Tab**.

Calibration Completed dialog box help

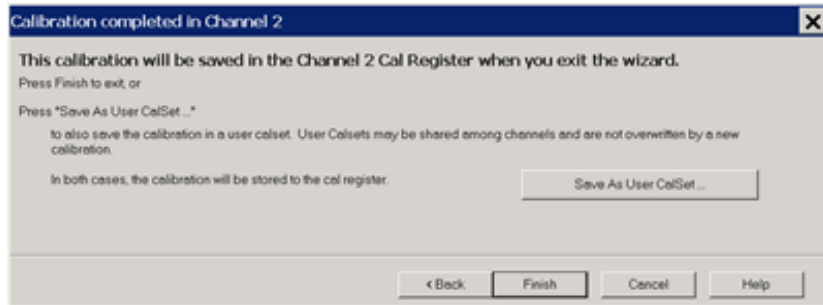

Finish Save to the channel's calibration register.

Save As User Cal Set Starts the [Save as User Cal Set dialog box](#) AND save to the channel's calibration register.

Cancel Calibration is NOT applied or saved.

Learn about [Calibration Registers](#).

Learn about [User Cal Sets](#)

Specify delay dialog box help

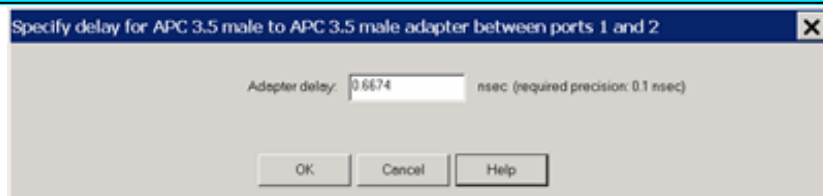

This dialog appears ONLY when [Adapter Removal](#) or [Unknown Thru](#) calibrations are performed.

The following values were estimated from the measurement. Most of the time, they are adequate. However, for CW sweep or frequency sweep with large step sizes, the accuracy of the values may be improved.

Adapter delay To improve this value, measure and record the delay of the adapter with a dense step size. Enter that value here. The required precision value is the accuracy that is required to characterize the delay value.

Nominal phase offset (Waveguide ONLY). To improve this value, measure and record the phase offset of the Waveguide adapter with dense step size. Enter that value here.

When one connector is coax and the other connector is waveguide, the phase offset has an ambiguity of 180 degrees. For consistency, the estimate provided here is always between 0 and 180 degrees. You can change this estimate to any value between -180 degrees and +180 degrees.

For SMC calibrations, this dialog box appears twice: once for the input frequencies and once for the output frequencies. The values can be slightly different.

Mixer/Converter Setup

The following dialogs are common to all Converter Apps: FCA, Swept IMDx, IMx Spectrum, NFX, and GCx applications.

Note: Swept IMDx, IMx Spectrum, NFX are supported by PNA only. GCx is currently not supported on the M9370A/71A/72A/73A/74A/75A.

- Mixer Frequency tab
- Mixer Setup tab
- Mixer (LO) Power tab
- Fractional Multiplier Examples

Important Note: Connecting your Mixer/Converter DUT to the VNA.

RF and **IF** terminology is NOT used in this topic because the VNA does not know how your DUT is labeled or how it will be used. Instead, the general terms INPUT and OUTPUT are used to describe the following VNA behavior:

- INPUT - the stimulus frequencies BEFORE conversion by your DUT.
- OUTPUT - the response frequencies, AFTER conversion (either UP or DOWN) by your DUT. Specify UP or DOWN conversion using the + or - symbol for each output.

Mixer Frequency tab help

◀ Programming Commands ▶

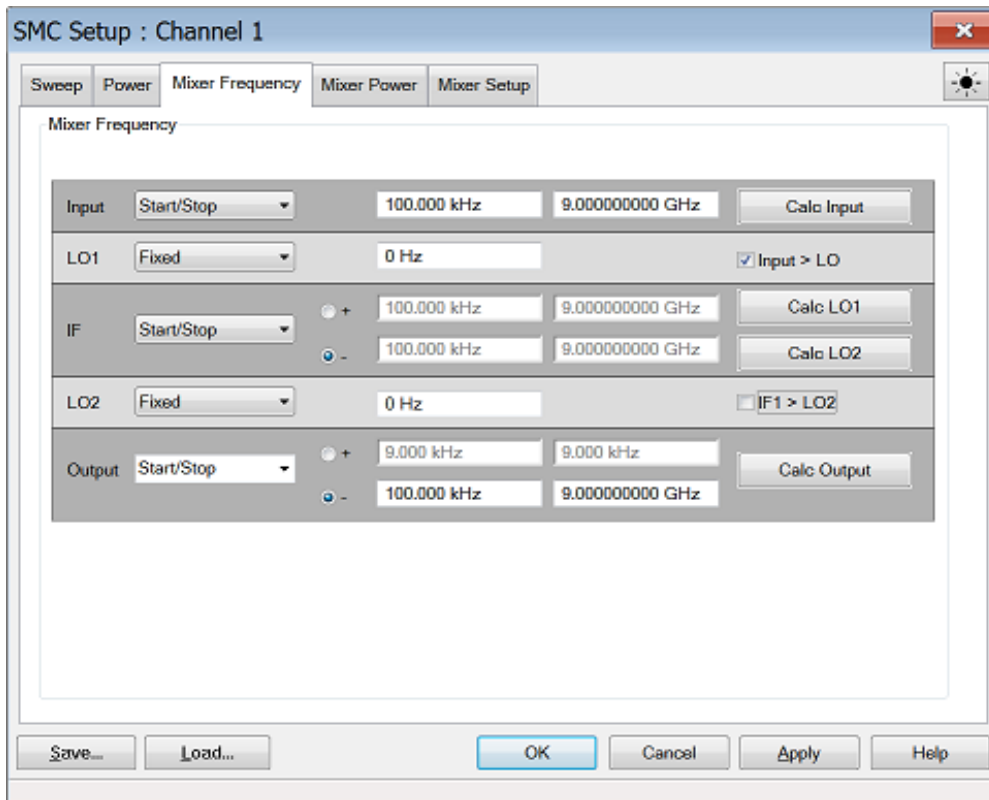

Settings

Frequency Format Select Start/Stop (Swept) or Fixed. For Linear sweep type, at least one of these must be fixed. For CW or Power, ALL must be Fixed.

Frequencies Enter the frequency values for each of the Mixer/Converter ports.



Mixer-Product Selector Determines whether the receivers will tune to the Sum (+) or the Difference (-) of the Input and LO frequencies.

Calc buttons Calculates frequency settings based on your other mixer settings. For example, enter the Input frequency range and LO1 frequency range, then press **Calc Output**. The VNA will calculate and display the Output frequencies.

Input > LO or IF1>LO2 Removes ambiguity when using a Calc button to determine the INPUT frequency.

These check boxes are used ONLY when all 3 of the following conditions are TRUE:
(If ALL 3 are NOT true, the VNA does not read these check boxes).

1. Difference (Low) sideband  is selected for the corresponding Calculate button AND

2. Output frequency is less than the LO frequency AND
3. One of the **Calculate** buttons are used to calculate the **Input frequency**.

Rules for Configuring a Mixer

A **Red** message across the bottom of the dialog indicates that one or more of the following settings are invalid:

- Either ALL ranges (Input, LO, Output) must be Fixed, or ONE Range fixed. TWO ranges can NOT be Fixed or THREE ranges can NOT be Swept.
- For determining a valid mixer configuration with **2 LOs**, one Fixed LO and one Swept is equivalent to having a single-stage Swept LO. To configure a 2-stage LO, select **Converter Stages: 2** on the **Mixer Setup** tab.
- INPUT or OUTPUT frequencies cannot be outside the range of the VNA.
- Any combination of INPUT and LO which results in an OUTPUT that sweeps through Zero Hz is NOT allowed.

About Mixer Configuration Files (.mxr and *.mxrx)

Save Saves SOME of the mixer settings to a *.mxr or *.mxrx file.

Load Recalls a previously-configured mixer *.mxr or *.mxrx file .

Note: By default, mixer configurations are saved to a *.**mxrX** file. Previously, they were saved to a *.**mxr** file.

ONLY *.**mxrx** files allow saving **segmented sweep** mixer setups. Currently, only allows segmented sweeps. In all other respects, these new file types are completely backward compatible with *.mxr files.

What Mixer Settings are Saved?

- Sweep Type, frequency, and power settings.
- With Segment Sweep Type, all segment settings are saved.

Converter App Compatibility

The mixer setup files that are used with FCA, NFx, and GCx for PNA ARE compatible. However, *.mxr(x) files created in IMDx contain information that is NOT included with other

*.mxr(x) files.

External Sources

A *.mxr(x) file includes an LO source name. However, It does NOT include the LO Source configuration.

Apply Applies the settings for your mixer/converter test setup to the measurement. The mixer setup dialog box remains OPEN.

OK Applies the settings for your mixer/converter test setup to the measurement. The mixer setup dialog box CLOSES.

Cancel Closes the mixer setup dialog box and does NOT apply the settings.

Mixer Setup tab help

Programming Commands

Converter Stages Select either 1 or 2-stage converters.

Hardware Configuration

Add Source Click to start the [External Device Configuration dialog](#).

DUT Ports

Select VNA ports to connect to the DUT input and output.

Note: In M9485A, Only ports 1 to 4 can be set even if your unit has more than 4-port configuration.

Fractional Multipliers



The combination of (numerator / denominator) forms a fractional value that is multiplied by the input and LO frequency ranges. These values are used to calculate the response frequency of the VNA receiver for the converter output. Use the fractional multipliers to:

- simulate the action of harmonic mixers
- simulate the action of multipliers and dividers that may exist in your test setup

- tune the VNA receiver frequency to a harmonic of the mixer/converter

The range for the numerator and denominator of a fractional multiplier is from +1 to +10. Negative values are NOT allowed.

See [Fractional Multiplier examples](#).

LO1 and LO2

Select **Not controlled** to allow an external source to provide a Fixed LO Frequency at all times. Otherwise, select an internal VNA source or External source to be used as the LO. Learn how to [Configure an External Device](#) (Source).

See Also

[How to measure a DUT with an Embedded LO](#)



[Learn about these buttons.](#)

Mixer (LO) Power tab help



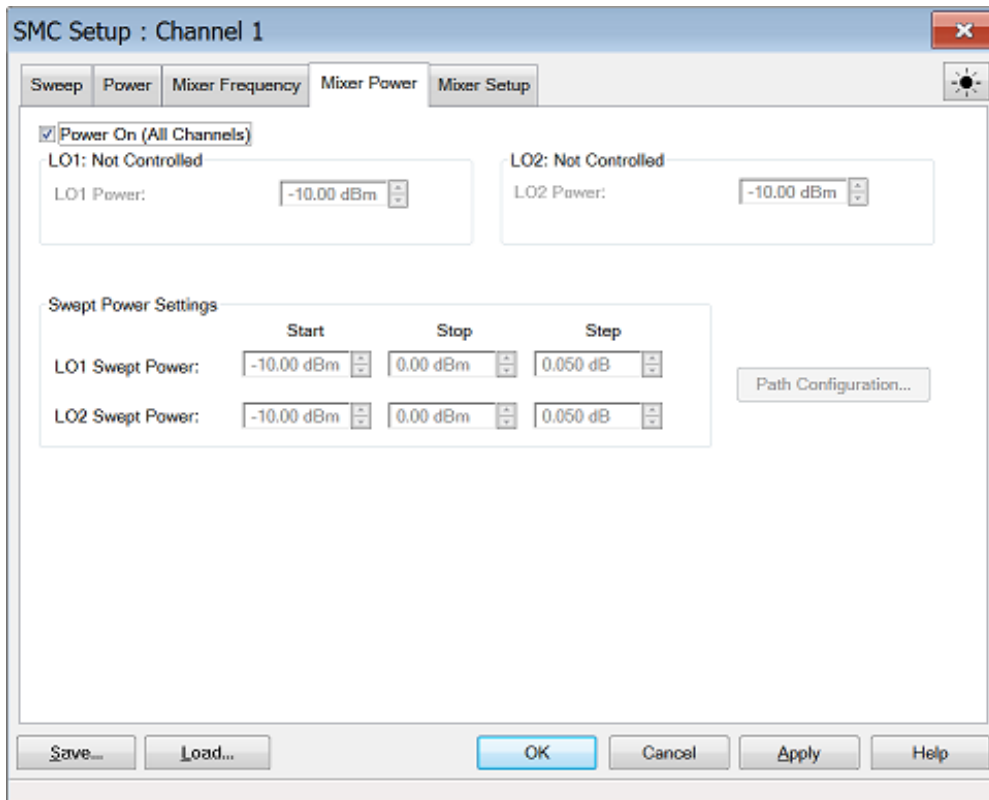

Configures LO Power settings.

Power ON (All channels) Check to immediately turn ON or OFF ALL VNA internal RF Sources for all channels.

LO1 Power Sets the power level for LO1.

LO2 Power Sets the power level for LO2.

Swept Power Settings Set the power sweep setting.

Path Configuration (PNA only)



[Learn about these buttons.](#)

Fractional Multiplier Examples

Example 1

Use the LO fractional multiplier to replicate the action of the third-harmonic mixer so the VNA can accurately calculate the receiver frequency. The input and LO frequencies are known.

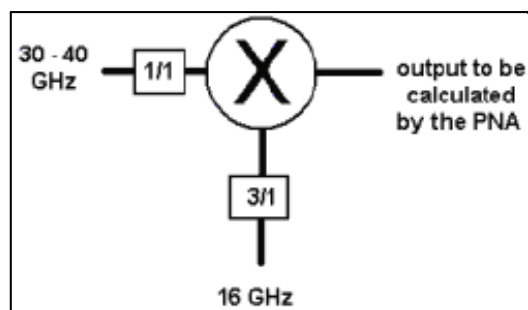

Enter these settings in the **Mixer Setup** dialog box:

- **Input Start Freq: 30 GHz**
- **Input Stop Freq: 40 GHz**
- **LO Fixed Freq: 16 GHz**
- Mixer-Product Selector: - (difference)
- LOs: 1
- LO fractional multiplier: 3/1
- INPUT fractional multiplier: 1/1

Click **Calculate Output**

Results:

- **Output Start Freq: 18 GHz**
- **Output Stop Freq: 8 GHz**

Example 2

Use the fractional multipliers to tune the VNA receiver frequency to the second harmonic of the mixer's 14 GHz fundamental output. The input, LO, and output frequencies are known.

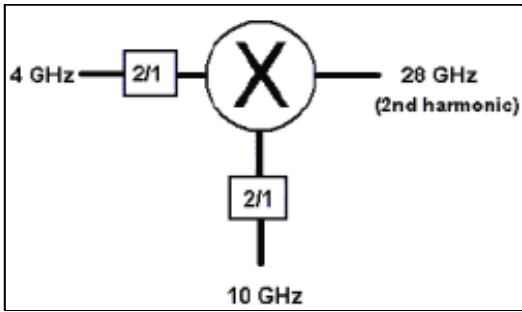

Enter these settings in the **Mixer Setup** dialog box:

- **Input Start Freq: 4 GHz**
- **Input Stop Freq: 4 GHz**
- **LO Fixed Freq: 10 GHz**
- Mixer-Product Selector: + (Sum) of the input and LO signals
- LOs: 1
- INPUT fractional multiplier = 2/1
- LO fractional multiplier = 2/1

Click **Calculate Output**

Results:

- **Output Start Freq: 28 GHz**
- **Output Stop Freq: 28 GHz**

Example 3

Use the LO fractional multiplier to replicate the action of the divide-by-two mechanism inside the mixer package. Having done this, the VNA can accurately calculate the receiver frequency. The input and LO frequencies are known.

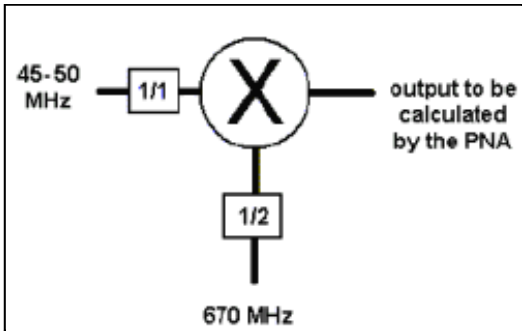

Enter these settings in the **Mixer Setup** dialog box:

- **Input Start Freq: 45 MHz**
- **Input Stop Freq: 50 MHz**
- **LO Fixed Freq: 670 MHz**
- Mixer-Product Selector: + (Sum) of the input and LO signals
- LOs: 1
- INPUT fractional multiplier = 1/1
- LO fractional multiplier = 1/2

Click **Calculate Output**

Results:

- **Output Start Freq: 380 MHz**
 - **Output Stop Freq: 385 MHz**
-

SMC+Phase

With SMC you can optionally measure phase. This feature is available ONLY with Opt S9x083A/B on a M980x or P50xx model.

In this topic:

- [Overview](#)
- [How to make SMC+Phase measurements](#)
- [Measuring Mixers below 630MHz](#)
- [Comparing SMC+Phase with VMC Phase Measurements](#)
- [How to improve the stability of SMC+Phase measurements](#)
- [How to Calibrate a 2-stage \(LO\) SMC+Phase Measurement](#)

See Also

[SMC Phase Reference Calibration](#)

[SMC Measurements and Calibration](#)

[SMC+Phase Demo](#) (Internet connection required)

Other FCA Topics

Overview

There are three methods used in the VNA to calibrate SMC+Phase measurements. All three methods rely on newer phase-coherent synthesizers in the VNA to produce phase capability in frequency offset measurements.

With the first two methods, during an SMC calibration, the phase delay through a Calibration Mixer is measured and compared to the known delay. The difference is used to correct subsequent SMC+Phase measurements.

A Calibration Mixer is required with the first two methods.

1. Enter the known delay into a dialog.

2. Uses the known delay at various frequencies from an *.s2p file from a mixer characterization. You create the *.S2P file from a separate Mixer Characterization. This method is NOT supported with **Cal All**.
3. Uses a Phase Reference to perform a 'tier 1' calibration. A Calibration Mixer is NOT required with this process. [Learn more about this process.](#)

Notes

- A Reference Mixer is NOT required with any of these methods as it is with VMC.
- SMC+Phase can be measured on Converters with an Embedded LO. [Learn how.](#)
- Phase can be measured with Power Sweeps.
- Phase can NOT be measured on Swept LO measurements.
- It is especially important with SMC + Phase measurements to connect the **10 MHz reference signal** of an external source to the VNA.
- you can use a Phase Reference Cal Set with **Independent power cals for input and output ports (no thru)**. [Learn more.](#)

How to make SMC+Phase measurements

1. On the Mixer **Sweep tab**, check **Enable Phase**, then select the Phase Reference Point.

SMC Mixer Sweep tab - Phase Settings help

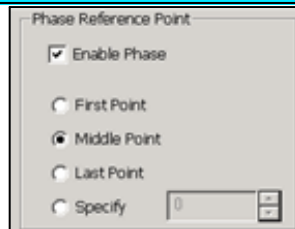

Enable Phase with SMC Check to perform phase measurements.

You can also enable phase measurements at the [SMC Cal Setup dialog](#).

Phase Reference Point

The SMC Phase measurement technique provides for a coherent phase relationship from one frequency to the next in each sweep. However, the phase measurement of the first data point is random from sweep to sweep. This initial phase offset does not impact measurements such as group delay or deviation from linear phase.

However, in order to keep a phase trace from appearing random, all phase data in

the sweep is normalized against a single point. This results in a stable, normalized phase trace.

For this normalization, select the measurement point that has the best signal-to-noise ratio. The phase at the selected point will always be zero. This selection applies for both the measurement and the calibration sweeps.

The Reference Point is fixed at the middle point when **segment sweep** is selected.

Programming Commands

2. **Select a Phase Format** for the SMC measurement: click **Response**, then **Format**, then phase, unwrapped phase, or group delay.
3. During SMC Cal, at the **Cal Setup dialog**, select the Phase Correction method as follows:

SMC Cal Setup - Phase Correction dialog help

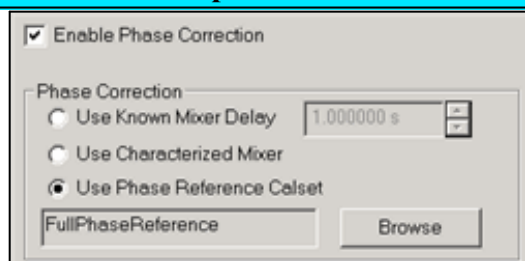

Enable Phase Correction Check to enable Phase measurements. This can also be done during the mixer setup.

Phase Correction

Choose one of the following methods to specify the known delay through the characterized mixer. With the first two methods, the phase delay through a Calibration Mixer is measured and compared to the known delay, either entered, or stored in an *.S2PX file.

- **Use Known Mixer Delay** Enter the fixed, known, delay through the calibration mixer.
- **Use characterized mixer** Select, then browse to the *.S2P file that characterizes the calibration mixer. Use an *.S2PX file when making segmented SMC+Phase measurements. [Learn more](#). Use either of the following two methods to characterize the Cal Mixer over the SMC measurement frequency range:

1. Use the Mixer Characterization Wizard. The Cal Mixer has the same requirements as the **VMC Cal Mixer**. [Learn more](#).

2. In a calibrated VMC channel, measure the group delay of the calibration mixer, then save to an *.S2P or *.S2PX file. However, a characterized mixer is required to calibrate the VMC channel.

- **Use Receiver Characterization Calset** Select, then browse to the Phase Reference Cal Set that covers the frequency range of the current measurement. [Learn more about SMC with a Phase Reference.](#)

Measuring phase on Mixers below 630 MHz

Measuring phase on mixers below 630 MHz is challenging for the following reason:

1. The M980x has a significant number of **frequency bands** below 630 MHz. SMC+Phase must have multiple measurement points within every frequency band.
 - **Recommendation:** Select the number of data points to yield a point spacing of NO MORE than 100 kHz per point. **Segment Sweep** can be used so that the point spacing above 630 MHz is not as dense.

Comparing SMC+Phase with VMC Phase Measurements

SMC phase measurements do NOT require a reference mixer, and are therefore easier to make than VMC phase measurements. Also the SMC calibration mixer is only required to have a known delay value, although an S2P characterization file provides more accurate results. The **Phase Reference** method provides the highest accuracy phase measurements for mixer/converters.

- When measuring converters with an embedded LO, SMC with phase can provide results that are as stable and free from sweep-to-sweep jitter as VMC.
- When measuring converters with an external LO that is shared with the reference mixer (as shown in the VMC Setup diagram), VMC provides results that are more stable than SMC+Phase.

How to improve the stability of SMC+Phase measurements

Stable phase measurements are attained by increasing **Sweep Averaging**, and sometimes lowering the IFBW, until you attain the desired compromise between sweep time and trace jitter (the amount of random phase change at a single data point). For SMC+Phase, the default IFBW is 10 kHz, and 1 average. During calibration, the Averaging factor is temporarily multiplied by 4 to ensure an accurate phase calibration.

The following procedure shows **how to view and improve phase jitter**:

1. Create an SMC+Phase channel (Click Response, Measurement Class).

2. Enable Phase with SMC (See above) On the phase trace (to follow) notice that the only point that has NO jitter is the data point that you selected as the Phase Reference point.
3. Change the measurement to **IPWR**: (Click Response, Measure, IPWR)
4. Change Format to Phase. (Click Response, Format, Phase)
5. Normalize the trace. (Click Marker/Analysis, Memory, Normalize) [Learn more about Normalization.](#)
6. Autoscale the trace. (Click Response, Scale, Autoscale).
7. Optionally monitor the jitter with **Trace Statistics** (Std Dev)
8. Increase Averaging and possibly lower IFBW to improve jitter. (Click Response, Avg BW, then Averaging). Use a MINIMUM of 10 sweep averages (never use Point Averaging).
9. After the adjustments are made, change the measurement back to your measurement of interest.
10. When measuring a new DUT, restart Averaging.

How to Calibrate a 2-stage (LO) SMC+Phase Measurement

Note: The following discussion does NOT pertain when a **Phase Reference cal** is used to correct the SMC+Phase Measurement.

When calibrating a dual-stage SMC+Phase measurement for group delay using a characterized mixer, the channel setup requires frequency values for two LOs, but the characterized-thru mixer uses only one LO. The frequencies of LO1 and LO2 are different. There are two ways to overcome this challenge:

1. Before the calibration, set the LO that is provided by an external source to uncontrolled. Then manually set the frequency of this external source to the LO frequency that gives the same input and output frequencies, and the same sweep direction, as the dual-stage setup. Perform the calibration under this condition. After the calibration, return the LO to controlled so that its frequency will be properly set during the measurement of the DUT.
 2. Configure a 1-stage mixer setup, with the LO set to the frequency that gives the same input and output frequencies and the same sweep direction as the dual-stage setup. Perform the calibration under this condition. Save the calibration data as a user calset. Configure the dual-stage case, and apply the 1-stage calibration.
-

SMC Phase Reference Calibration

A Phase Reference calibration is performed to simplify the SMC+Phase calibration process.

In this topic:

- [Features, Requirements, and Limitations](#)
- [How it Works](#)
- [Hardware Setup](#)
- [Phase Reference Calibration Summary](#)
- [How to Perform the Phase Reference Calibration](#)

Other FCA Topics

Features

- Greatly simplified phase measurements on mixers.
- A Reference Mixer or Calibration Mixer is **NOT** required.
- Works well with segmented sweeps, and mixers with 2-stage LOs.

Requirements

- One of the following Keysight Comb Generators (Phase Reference):
 - U9391C (26.5 GHz)
 - U9391F (50 GHz)
 - U9391G (67 GHz) - Receiver attenuation must be used.

Note: The U9391-60009 sine-to-square wave is recommended when using the instrument's 10 MHz reference output as the driving source to the comb generator. Connect between the instrument's 10 MHz output and the input to the comb generator. See the [U9391 Technical Overview](#) for more information.

- Power meter or USB power sensor.
- S-parameter Cal Kit (mechanical or ECal module).
- For measurements below 630 MHz, an additional 'Unknown mixer' is required. [Learn more.](#)
- For measurements between 50 GHz and 67 GHz, an additional high-pass filter is required. Two back-to-back Keysight V281A waveguide-to-coax adapters is recommended.

Note: The 67 GHz comb generator creates a large pulse for generating useful harmonics up to 67 GHz. At low frequencies, receiver attenuation must be used to prevent overloading the VNA receiver due to the large signal.

Limitations

- Available with opt. S9x083A/B (NOT with opt. S9x082A/B). Opt S9x083A/B ONLY available on a PNA-X or N522x or M980x or P50xx model.
- Swept LO measurements are NOT allowed.
- Lowest frequency for Phase Reference Cal is 10 MHz.

How it Works

A Phase Reference Cal is performed, saved, and later recalled during a SMC Calibration. This is sometimes referred to as a 'tier 1' calibration. Due to stability of the VNA, the Phase Reference Cal can be performed infrequently. It is typically performed over the full frequency range of the VNA or Phase Reference so that it can be applied to all SMC calibrations that will be needed in the future.

The Phase Reference is a comb generator which produces signals at the multiple of its input frequency. By driving it with the VNA 10 MHz reference output, the Phase Reference produces signals at multiples of 10 MHz with a flat phase response.

During the tier 1 calibration, the VNA port 2 (B) receiver measures the phase at each 10 MHz comb frequency in order to generate correction values. These correction values are stored to a Phase Reference Cal Set which can be recalled and applied to correct subsequent SMC+Phase measurements.

Although only the B receiver is phase calibrated, an S-parameter calibration is performed at specified test ports and used to transfer the characterization to other VNA receivers.

A power calibration is also performed on port 1 as part of the Phase Reference cal. It does NOT have to be performed again during the SMC Cal.

Unknown Mixer Calibration (extends the phase reference calibration below 630 MHz)

By itself, the phase reference can only be used to calibrate down to 630MHz. With one additional

unknown mixer connection, the phase reference calibration can be extended to the lower limit frequency which is 10 MHz and maximum frequency range of the VNA. The unknown mixer is also used to improve the quality of the phase reference calibration below 630 MHz.

With the unknown mixer process, the phase of the unknown mixer is measured as a down converter with the output frequencies set between 10 MHz and 900 MHz. By using the data acquired using the phase reference, the system is able to make produce calibrated measurements of the mixer above 630 MHz. The phase response of the unknown mixer is assumed to be linear, so the expected phase response of the mixer is extrapolated down to 10 MHz. The variation in the measurements versus the expected phase response is attributed to, and used to correct, the phase response of the VNA receivers from 10 MHz to 630 MHz.

Unknown Mixer Properties

- The mixer must be able to output a signal from DC to 1GHz.
- Over these frequencies, the delay response of the mixer should be constant. Therefore, the unknown mixer must be passive, with no filtering or amplification.
- Add a 10dB attenuator on the mixer input and output to minimize mismatch effects.

Hardware Setup

1. Connect the U9391 Phase Reference to a DC power supply. See the [U9391 Technical Overview](#) for more information.
 - a. The black wire is “ground”.
 - b. The red wire is + 15Vdc. The U9391C and U9391F only require +15 Vdc.
2. Connect a cable from the VNA 10 MHz Reference signal output to the U9391 input. The cable should be as short as possible.

Note: The U9391-60009 sine-to-square wave is recommended when using the instrument’s 10 MHz reference output as the driving source to the comb generator. Connect between the instrument’s 10 MHz output and the input to the comb generator. See the [U9391 Technical Overview](#) for more information.

3. Connect the U9391 output directly to the VNA test port 2.
4. Insert the U9391 USB connector into any of the Controller PC USB ports.

Phase Reference Calibration Summary

The Phase Reference Cal Wizard steps will show the appropriate prompts.

When Unknown Mixer is enabled (Start Frequency is 10 MHz)

- The input and output match of the unknown mixer is measured. Then SC21 using 100 averages.

Phase Reference measurement and S-Parameter calibration below 50 GHz.

- When using the 67 GHz phase reference, use receiver attenuator or external attenuator.

When mixer output is above 50 GHz, Phase Reference measurement and S-Parameter calibration.

- Connect 50 GHz high pass filter to phase reference output.
- Receiver attenuator or external attenuator is NOT used.

Full band power sensor measurement.

- Connect Power Sensor to Port 1.

Full band S-parameter calibration.

- Connect standards to Port 1.
- High-pass filter is NOT used.
- Receiver attenuator or external attenuator is NOT used.

How to start the Phase Reference Calibration

With an **Scalar Mixer / Converter** + **Phase** measurement active...

Using **Hardkey/SoftTab/Softkey**

1. Press **Cal** > **Main** > **Other Cals** > **Phase Reference Wizard....**

Using a mouse

1. Click **Response**
2. Select **Cal**
3. Select **Other Cals**
4. Select **Phase Reference Wizard...**

Programming Commands

Phase Reference Cal Settings dialog box help

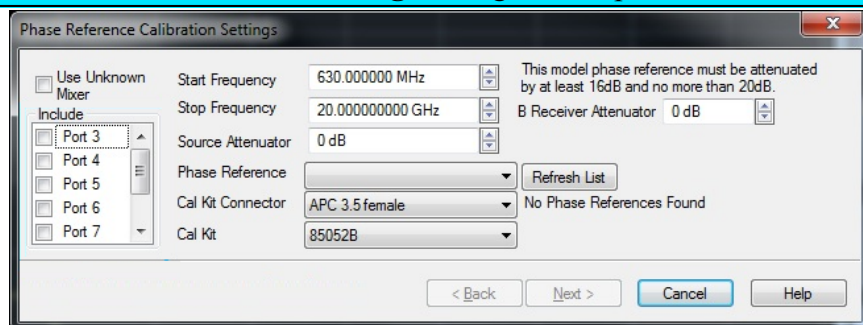

Use Unknown Mixer

Check to use an Unknown Mixer to calibrate the VNA receivers below 630 MHz. The Start Frequency becomes 10 MHz and can not be changed. [Learn how it works.](#)

Ports

- Ports 1 and 2 are always selected.
- Select port 3 and 4 more to perform an S-parameter (SOLT) cal at those ports. The phase correction is transferred to all checked ports.

Start / Stop Frequency

Select the start and stop frequency of the Phase Reference Cal. Subsequent SMC+Phase

calibrations MUST be the same or a subset of these frequencies. Interpolation is performed when the 10 MHz 'grid' of characterized frequencies is off from measurement frequencies.

- When Unknown Mixer is NOT checked, the lowest start frequency is **630 MHz**. The lowest stop frequency is 1 GHz.
- When Unknown Mixer IS checked, the start frequency is **10 MHz** and can NOT be changed. The lowest stop frequency is 5 GHz.

Source Attenuation

Select the attenuation value for the VNA source port.

Important Source Attenuation Notes

- This setting should match the port 1 source attenuator setting used for subsequent SMC+Phase measurements. If the settings are the same, only an S-parameter cal need be performed with the SMC+Phase calibration wizard to complete the calibration process. If the settings are different, a **Cal All calibration** must be performed, which requires both an S-parameter cal and another power-sensor cal. As an alternative, if you plan to make SMC+Phase measurements with different input attenuator settings, you may want to perform a couple of Phase Reference cal's using these different attenuator settings.
- The phase reference cal is not as good when using input attenuation. You will get a better calibration if you use 0 dB of source attenuation. Then use the **Cal All** feature to perform the 2nd tier calibration with the required input attenuation. This is because the Cal All feature includes an attenuator calibration that will properly move the phase reference cal from the 0 dB attenuator plane to the new (required) attenuator plane.

Phase Reference

When the Phase Reference is detected by the VNA, it should appear in this field. If it does NOT appear here, try a different USB port, then click **Refresh**.

Phase Reference Connector type and gender. When the Phase Reference does NOT mate directly with the test port, you can add a well-behaved, broadband (no filters, waveguide, etc.) adapter to the Phase Reference and ignore it. That is because the adapter will stay with the Phase Reference and the calibration plane will still be the VNA test port connectors. The adapter adds constant delay; the **deviation** in delay is what is being calibrated out. Loss in the adapter is not a concern because the adapter is not used during the S-parameter and the power meter portion of the cal.

Cal Kit Connector

Select the connector type and gender of your Cal Kit.

Only ONE connector type and gender is specified. This is because the entire Phase Reference cal is performed at the VNA test ports to reduce the effects of cable flex in the characterization.

There may be times when an adapter or connector-savers are used to connect the phase reference and cal standards to the test ports. In these cases, for highest accuracy use that adapter style and gender for ALL connections to ALL test ports. The effects of the adapter will be de-embedded automatically during subsequent SMC+Phase calibrations.

Note: For highest accuracy, perform the phase reference cal at the test ports.

Cal Kit Select the Cal Kit that will be used to perform the S-parameter Cal.

B Receiver Attenuation

The 67 GHz (U9391G) phase reference outputs too much power and overloads the VNA Port 2 (B) receiver. Use at least 16 dB and not more than 20 dB of receiver attenuation to make accurate measurements using that phase reference.

This message is shown when a 67 GHz phase reference is connected to USB.

The B receiver attenuator control is shown if your VNA has receiver attenuators. Otherwise, connect external attenuation to the U9391G output when prompted.

Unknown Mixer Settings (Phase Reference Cal Wizard) dialog box help

The following wizard pages appear when Unknown Mixer is checked on the previous page:

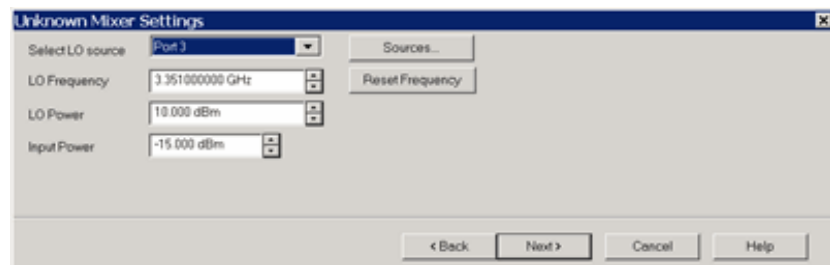

Select LO source The LO can be an internal 2nd source or an external source.

Sources Click to start the **External Devices dialog** where you can select or configure an external RF source.

LO Frequency Select a frequency that results in the unknown mixer output of 10 MHz to 900 MHz using this formula: $\text{Input} = \text{LO} + \text{Output}$.

Note: For best results, use the default LO frequency which avoids the VNA input (source)

frequency band crossings.

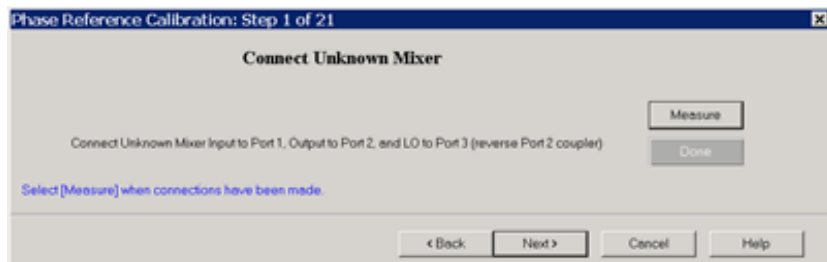

- Connect the unknown mixer input to the between port 1 and port 2. For best results, connect the mixer output as close as possible to port 2.
- Connect the LO of the unknown mixer.
- Click **Measure**.
 - The input and output match of the unknown mixer is measured, then, SC21 using an averaging count of 100.
 - The data point spacing of the calibration is decreased to 156 kHz. This point spacing is necessary to accurately characterize all the low frequency band breaks of the VNA.

Power Cal Settings (Phase Reference Cal Wizard) dialog box help



A power calibration is performed on port 1. This is done to simplify subsequent SMC calibrations since the power calibration will not need to be repeated.

For highest accuracy, connect the power sensor directly to the test port with no adapter.

[Learn more about these settings.](#)

Phase Reference Calibration Steps dialog box help

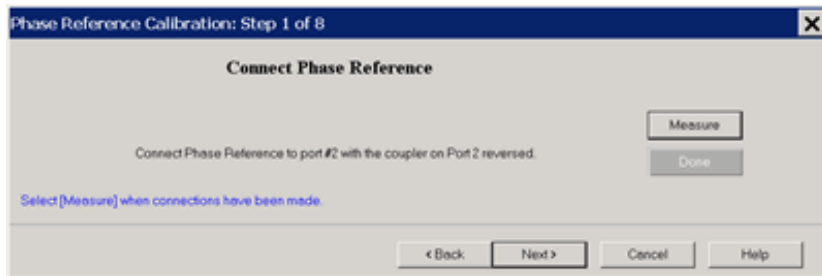

- Connect the Phase Reference directly to the port 2 test port.
 - a. If an adapter is necessary, then that adapter must be left in place for the SOLT cal at port 2.
 - b. When using a 67 GHz phase reference, attenuation or high-pass filter is required.
- Press **Measure**.
- The VNA will make a series of measurements which can take several minutes:
 - a. First, the match of the phase reference is measured.
 - b. Then, a sweep is made at multiples of 10 MHz across the entire frequency span. Each measurement is repeated 100 times and averaged to reduce the noise in the measurement.
 - c. An error is reported if the approximate power level is not detected.
- 5. When finished, press **Next>**

Power sensor A

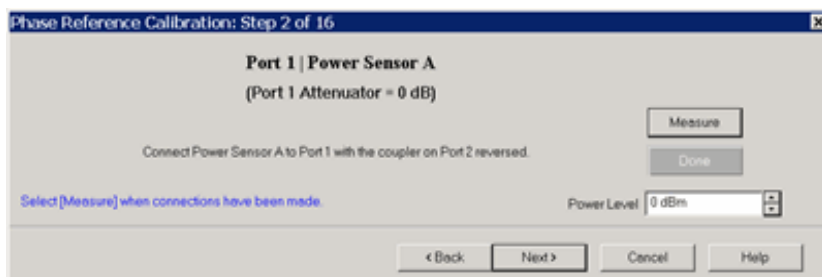

Connect the power sensor to port 1 test port.

SOLT cals are performed at the test ports.

- The THRU standard always performs an **Unknown Thru**.
- Follow the prompts to complete the Phase Reference Cal.

Phase Ref Cal Finished

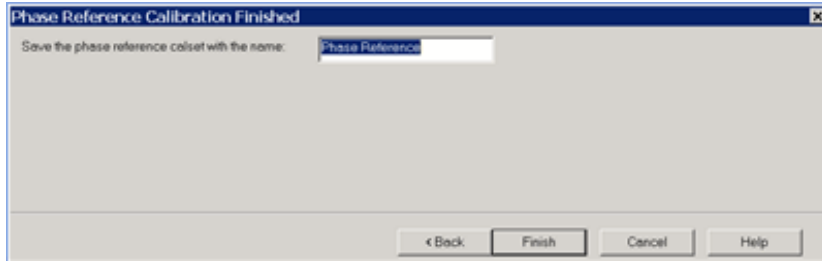

Enter a name for the Phase Ref Cal, then click **Finished**.

During subsequent SMC calibrations, select the Phase Reference Cal Set at the SMC Cal setup dialog. [Learn more](#).

Specify Delay

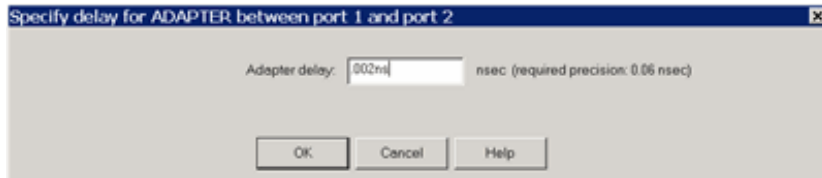

If you know the delay value of the Unknown Thru connection, enter it here.

Otherwise, click **OK** to accept the calculated value.

Embedded LO Measurements

The Embedded LO feature allows you to make **SMC** measurements of mixers that have a **FIXED LO** inside the DUT.

Note: This feature is available as Opt S9x084A/B, and must be **enabled**.

In this topic:

- [Overview - How the VNA measures the embedded LO](#)
- [To measure a DUT with an Embedded LO \(Procedure\)](#)
- [How to Launch the Embedded LO Mode dialog box](#)
- [Embedded LO dialog box help](#)
- [Embedded LO Diagnostic dialog box help](#)

Overview - How the VNA measures the embedded LO

Measurements of these devices are challenging for a couple of reasons:

1. All Embedded LO measurements require the VNA receivers to be tuned to the correct frequency to measure the mixer output, which is highly dependent on the exact LO frequency.

The nominal frequency of the embedded LO is input into the **Mixer Setup dialog**. This is used as a starting point for the measurement.

Before each DUT measurement sweep, background sweeps are made to determine the frequency of the embedded LO to a configurable degree of accuracy.

Background sweeps...

- **Broadband Sweep** - rough measurement of the embedded LO frequency, made around a selectable data point over a selectable frequency span. The input signal to the DUT is tuned to a selectable CW frequency. The B receiver is swept across a selectable span around the anticipated output frequency. The difference between the frequency of the found signal and the desired output frequency is then applied as an adjustment.
- **Precise Sweep** The B receiver is measured at the selectable data point. Measurements of phase versus time are made, from which the exact offset frequency is computed, until either the tolerance value or maximum iterations are met.

To measure a DUT with an Embedded LO:

1. Create a **SMC** measurement.
2. In the mixer setup dialog, enter the nominal frequency of the embedded LO as the LO frequency.
3. Perform a calibration as usual.
4. **Launch and complete the Embedded LO Mode dialog box** (below)

How to Launch the Embedded LO Mode dialog box

Using **Hardkey/SoftTab/Softkey**

1. Press **Sweep** > **Source Control** > **Embedded LO...**

Using a mouse

1. Click **Stimulus**
2. Select **Sweep**
3. Select **Source Control**
4. Select **Embedded LO...**

Programming Commands

Embedded LO dialog box help

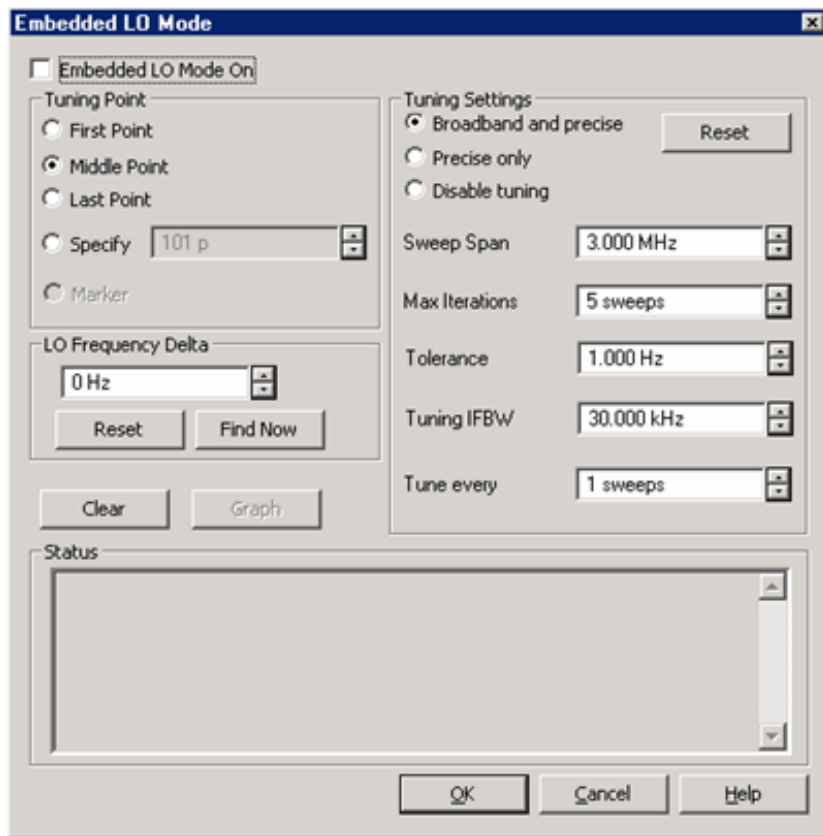

The Tuning Settings balance LO measurement speed versus accuracy. You can see that accuracy is becoming compromised when noise starts to appear on the measurement trace.

[Scroll up](#) to learn more about the Embedded LO measurement process.

Embedded LO Mode On Check to enable measurement of the Embedded LO.

Tuning Point Select, or specify, the data point in the mixer sweep that will be used to find the embedded LO frequency. If a marker is enabled, that data point can be used. For broadband and Precise sweeps, choose a point in the mixer sweep where noise is least likely to be found, such as the point of highest gain. This is generally the center of a sweep or the center of a filter if used.

LO Frequency Delta The absolute difference between the measured embedded LO frequency and the LO setting that is entered in the [Mixer Setup dialog](#). This value is updated each time the embedded LO frequency is measured. Entering a value is a way to change the LO frequency on the mixer setup without invalidating the calibration.

Reset Set the LO Frequency Delta back to 0 Hz.

Find Now The VNA finds and measures the actual LO frequency using the current dialog settings. This data is displayed in the **Status** box.

Tuning Settings These settings determine the amount of time spent versus the degree of accuracy

to which the LO Frequency is measured. You can see that accuracy is becoming compromised when noise starts to appear on the measurement trace.

Reset Set all Tuning Settings back to the defaults.

Broadband and Precise Does the entire tuning process for each background sweep. See the [Overview](#) for more information.

Precise only Does NOT perform broadband tuning on each sweep. Use this setting when the embedded LO is stable. The signal (after broadband) must be within $\frac{1}{2}$ the tuning IFBW. If the signal will always be within $\frac{1}{2}$ the IFBW, broadband tuning is not needed. Most satellite components are within 3 kHz absolute so might not need broadband tuning.

Disable tuning Only the previously measured LO Frequency Delta is applied to the reference mixer LO and VNA receivers.

Sweep Span Narrowing the sweep span limits the number of data points that are measured in the broadband sweep and makes the measurement faster. Sweep span should be less than 14 MHz. The resolution of the broadband mode is the tuning IFBW.

Max Iterations The maximum number of Precise sweeps to make. When this number is reached, the final measurement is used.

Tolerance When two consecutive Precise measurements are made within this value, the final measurement is used. If this is not achieved within the Max Iterations value, then the last measurement is used. This is the best of the 'Tunings settings' to change to improve accuracy.

Tuning IFBW IF Bandwidth used for Broadband and Precise tuning sweeps. This sets the resolution in the Broadband sweeps and sets the max error ($\frac{1}{2}$ IFBW) for precise tuning. The larger the IFBW, the faster the sweep, but the signal may not be found.

Tune every Set the interval at which tuning is performed before a measurement sweep. 'Tune every 3 sweeps' means that every third measurement sweep is preceded by tuning sweeps. If the embedded LO drifts, or if regularly changing DUTs, use 'Tune every 1 sweep'.

Status Allows textual and graphical representation of the Embedded LO measurement sweeps.

Clear Removes the text information currently being displayed.

Graph Launches the following graphical (spectrum analyzer type) display sweeps of the latest embedded LO measurement.

Embedded LO Diagnostic dialog box help

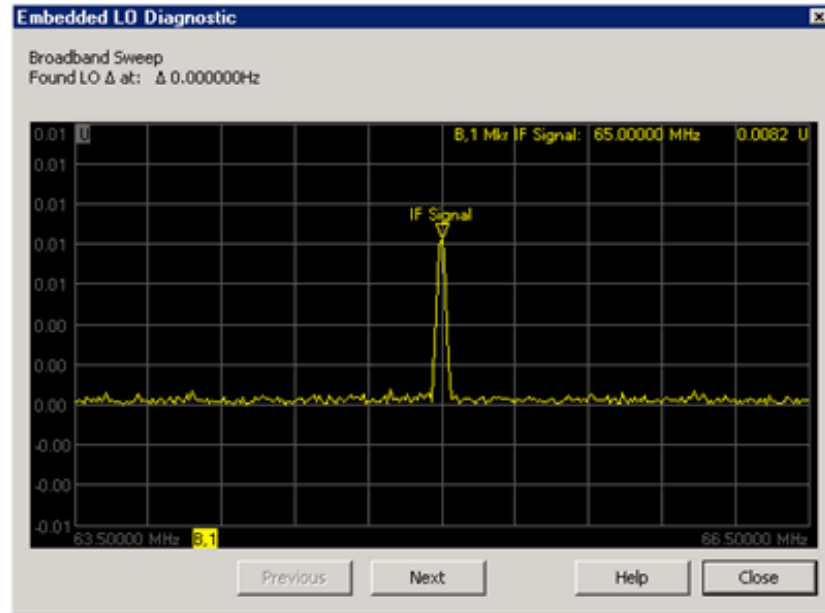

This dialog appears when **Graph** is clicked on the **Embedded LO** dialog.

Presents a graphical (spectrum analyzer type) display of the latest embedded LO measurement.

Click **Previous** and **Next** to view available Broadband and Precise sweeps. The LO Frequency is displayed in the Marker annotation.

Frequency Offset Mode

Frequency Offset Mode (FOM) provides the capability to have the VNA Sources tune to frequencies that are different (offset) from the VNA Receivers.

VNA Option 080 or S9x080A provides you with the hardware and basic software capability to make Frequency Offset Measurements. This topic discusses the VNA settings that are relevant to making these types of measurements. See [Frequency Converting Device Measurements](#) for more information on making specific device measurements.

Note: (M980xA, P50xxA) This function is available when S9x082A, S9x083A or S9x090A is installed.

- [Frequency Offset Dialog Box](#)
- [Setup Examples](#)

Other Frequency Offset topics

How to make Frequency Offset settings

Using [Hardkey](#)/[SoftTab](#)/[Softkey](#)

1. Press [Sweep](#) > [Source Control](#) > [Frequency Offset...](#)

[Programming Commands](#)

Frequency Offset dialog box help

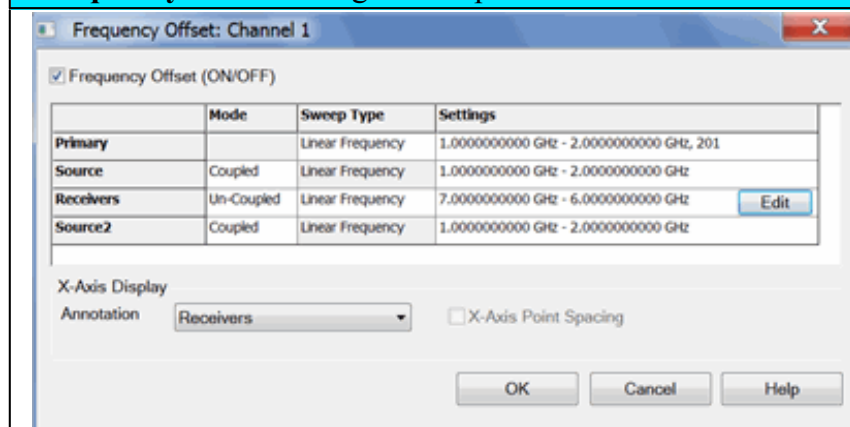

The following are major changes to FOM:

- Stimulus and Response are now called Sources and Receivers.
- Sources and Receivers settings can be made in two ways:
 1. By **Coupling** to the Primary (Channel) settings. This is the only method used in previous releases.
 2. By **Uncoupling** and setting Sources and Receivers values independently. This is the new, simplified method.
- External sources appear here and can be controlled from this dialog. [Learn more.](#)

Frequency Offset (ON/OFF) Enables Frequency Offset Mode on ALL measurements that are present in the active channel.

When FOM is NOT enabled, all frequencies are the same as the active channel.

Tip: First make other settings on this dialog box, then click **Frequency Offset ON**.

Primary The current Active Channel settings. When a Source or Receiver is coupled to the Primary settings, its Sweep Type is the same as that of the Primary. The frequency settings of the coupled range are mathematically derived from the Primary settings using the **Multiplier, Divisor, and Offset values**. With this approach, only the Primary settings need to be changed in order to affect change in the coupled Sources and Receivers. Changes to the Primary channel settings occur when Frequency Offset is checked ON. [See example using Primary and Coupled setting.](#)

Tip: Primary settings are ONLY used when Sources and Receivers are Coupled. It is often easier to Uncouple, then set Sources and Receivers independently.

Receivers All receivers that are used in the channel, including Reference receivers, are tuned to the specified frequency settings.

Mode

Coupled Source and Receiver settings are mathematically derived from the Primary settings using Multiplier, Divisor, and Offset values. [Learn more.](#)

Uncoupled Source and Receiver settings are entered independently, without reference to Primary settings. When Uncoupled, Source and Receiver Ranges can use separate sweep types.

Sweep Type Click to change the type of sweep for each range. Only available for Primary and

Uncoupled Sources and Receivers.

Unsupported Sweep Type combinations

- Power Sweep and Segment Sweep can NOT be used together.
- Uncoupled Log Sweep yields **invalid data** whenever the sources are offset from the receivers.
- Coupled Log Sweep is allowed only for the following two conditions:
 1. The offset = 0, the multiplier = 1, and the divisor = 1.
 2. The multiplier = 0

Settings To change settings, click **IN** the appropriate Settings cell, then click **Edit**.

- If coupled, invokes the **Coupled dialog**.
- If uncoupled or Primary invokes the **Uncoupled settings dialog**.

X-Axis Select the settings to be displayed on the X-Axis.

X-Axis Point Spacing Only available when a Segment Sweep Type is selected as the X-Axis display. [Learn more](#).

Note: When Frequency Offset is enabled, ALL receivers on the channel, including the reference receivers, tune to the new offset frequencies, Therefore the source and reference receiver will be at different frequencies. Therefore, FOM measurements that include a reference receiver, which includes all S-parameters, display invalid data.

To measure and display measurements at both the source and receiver frequencies, you must use two channels. Use [Equation Editor](#) to calculate the conversion loss. [See a calibrated FOM conversion loss example](#).

[Learn how to calibrate frequency offset measurements.](#)

Coupled settings dialog box help

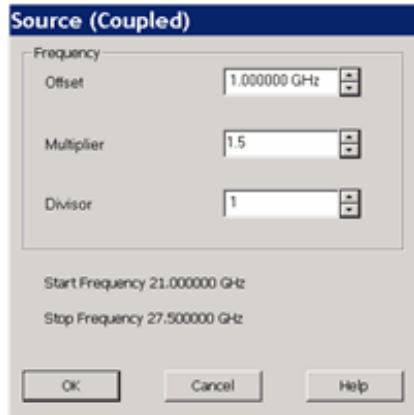

Coupled Formulas:

Range Start = [Primary Start x (Multiplier / Divisor)] + Offset

Range Stop = [Primary Stop x (Multiplier / Divisor)] + Offset

Where:

Offset Specifies an absolute offset frequency in Hz. For mixer measurements, this would be the LO frequency. Range is +/- 100 GHz. Offsets can be positive or negative.

Multiplier Specifies (along with the divisor) the value to multiply by the stimulus. Range is +/- 100.

- Negative multipliers cause the stimulus to sweep in decreasing direction. For downconverter mixer measurements, this would be for setups requiring the Input frequency to be less than LO frequency. [See an example.](#)
- 0 (zero) as the multiplier nulls the Primary setting. Then the Offset value adds to zero.

Divisor Specifies (along with the multiplier) the value to multiply the stimulus. Range is 1 to 100.

Primary and Uncoupled settings dialog box help



This dialog will vary depending on the sweep type:

Linear and Log frequency

Uncoupled Log sweep yields **invalid data** whenever the sources are offset from the receivers.

Select Start/Stop or Center/Span

Frequency Enter values

Points (Primary only) Enter number of data points for the sweep.

Power

CW Freq Enter frequency in Hz.

Points (Primary only) Enter number of data points for the power sweep.

CW Time

CW Freq Enter frequency in Hz.

Sweep Time Enter time to complete one sweep. Enter 0 for the fastest sweep.

Segment Sweep Edits are made exactly like the [standard segment table](#).

For Advanced Users: Uncoupled Segment Sweep offers great flexibility in configuring measurements. In segment sweep mode:

- The **OK** button is NOT available until the total number of data points for all segments matches the number of Primary data points.
- **Independent IF Bandwidth** and **Independent Sweep Time** are available ONLY on the Primary (channel) and the Uncoupled **Receivers** - NOT Sources.

- **Independent Power** is available ONLY on the Primary (channel) and the Uncoupled **Sources** - NOT Receivers.

Setup Examples

Although the Frequency Offset settings can be used with many types of devices, these examples include mixer terminology.

1. Fixed LO - Upconverter

- **Swept Stimulus (Mixer Input):** 1000 MHz - 1200 MHz
- **Fixed LO:** 1500
- **Swept Response (Mixer Output):** 2500 MHz to 2700 MHz

Make the following settings on the FOM dialog

Source: Uncoupled

Sweep Type: Linear

Click Settings, then Edit. In the Source dialog:

Start Frequency = 1000 MHz

Stop Frequency = 1200 MHz

Receiver: Uncoupled

Sweep Type: Linear

Click Settings, then Edit. In the Receiver dialog:

Start Frequency = 2500 MHz

Stop Frequency = 2700 MHz

LO Settings

Set external source to CW - 1500 MHz.

2. Fixed LO - Downconverter (Input < LO)

- **Swept INCREASING Stimulus (Mixer Input):** 1000 MHz to 1100 MHz

- **Fixed LO:** 2500 MHz
- **Swept DECREASING Response (Mixer Output)** 1500 MHz to 1400 MHz

Make the following settings on the FOM dialog

Primary: Not used

Source (Input): Uncoupled

Sweep Type: Linear

Click Settings, then Edit. In the Source dialog:

Start Frequency = 1000 MHz

Stop Frequency = 1100 MHz

Receiver (Output): Coupled

Sweep Type: Linear

Click Settings, then Edit. In the Receiver dialog:

Offset: 2500 MHz

Multiplier: -1 (Minus one)

LO Settings

- If using external source, set to CW: 2500 MHz.

[See a calibrated FOM conversion loss example.](#)

3. Swept LO - Fixed Output - Upconverter

Swept External LO measurements in Frequency Offset Mode can be very difficult. The external LO source must be synchronized with the swept output or input (as in this case). See [Synchronizing and External Source Control](#) to see how this is done. The [Frequency Converter Application Opt S9x083A/B](#) performs makes these measurements easily.

Note: (M980xA/P50xxA) The state for an external source in [Power and Attenuator dialog](#) must be set at ON after enabling FOM in [Frequency Offset dialog](#). Auto state does not work.

- **Swept Stimulus (Mixer Input):** 1000 MHz to 1100 MHz

- **Swept LO:** 1500 MHz to 1400 MHz
- **Fixed Response (Mixer Output):** 2500 MHz

Make the following settings on the FOM dialog

Source: Uncoupled

Sweep Type: Linear

Click Settings, then Edit. In the Source dialog:

Start Frequency = 1000 MHz

Stop Frequency = 1100 MHz

Receiver: Uncoupled

Sweep Type: CW Time

Click Settings, then Edit. In the Receiver dialog:

CW Frequency = 2500 MHz

LO Settings

- If using external source, set to sweep from 1500 - 1400 MHz.
-

4. Power Sweep for Mixers

To measure the gain compression of a mixer, the input power to the mixer is swept. The input and output frequencies are fixed but offset from one another.

This is a good use of Coupled settings because the same compression test can be performed at several different frequencies. With coupled Source and Receiver ranges, the Primary (channel) frequency can be easily changed from the front panel. The coupled source and receiver frequencies will update accordingly.

- **Swept Input Power:** -10 dBm to 0 dBm
- **Fixed Input Frequency:** 1500 MHz
- **Fixed LO:** 500 MHz
- **Fixed Output:** 2000 MHz

Make the following settings on the FOM dialog

Primary:

Sweep Type: Power Sweep

Click Settings, then Edit. In the Primary dialog:

CW Frequency = 1500 MHz

Source: Coupled

Default settings make CW Frequency: 1500 MHz (same as Primary)

Receiver: Coupled

Default settings make Sweep Type: CW Time

Click Settings, then Edit. In the Receiver dialog:

Offset = 500 MHz

LO Settings

- If using external source, set to CW: 500 MHz.
-
-

Frequency Converting Device Measurements

Note: The M937xA/P937xA does not support this function.

Many frequency offset measurements can be made using the VNA with option 009. The following is a list of some of those measurements and how they are made.

- [Conversion Loss](#)
- [Conversion Compression](#)
- [Return Loss and VSWR](#)
- [Harmonic Distortion](#)

See Also: [Frequency Offset Measurement Accuracy](#)

Frequency Offset Measurement Accuracy

This topic discuss methods that can be used to make accurate frequency offset measurements.

- [Calibrations](#)
- [Mismatch Errors](#)
- [Accurate and Stable LO](#)

[See other Mixer Measurement topics](#)

Calibrations

With Frequency Offset measurements, the stimulus and response frequencies are different. Standard calibration error terms are calculated using reference measurements. Therefore, traditional calibration methods such as full 2-port SOLT cannot be used with frequency offset.

[Source and Receiver Power calibrations](#) can be used to calibrate your Frequency Offset measurements.

[Frequency Converter Application](#) offers fully calibrated scalar and vector frequency offset measurements.

Source Power calibration:

- Sets accurate power level at stimulus frequencies regardless of the receiver that will be used in the measurement.
- Can be copied to other channels with copy channels feature.
- Can be interpolated.

Receiver Power Cal:

- Requires a source cal to have already been performed and applied.
- Cannot be copied to other channels.

Therefore:

- Start by performing a [source power cal](#) over the combined stimulus and response frequencies.

- Copy the channel to other needed channels and the source power cal is copied.
- Change the frequency range of the copied channel to response frequencies.
- Perform a receiver cal at the response frequencies on individual channels.
- Change the frequency range to stimulus frequency and switch frequency offset ON.
- On Status Bar, ensure that source and receiver cals are ON (source cal will be interpolated).

See Frequency Offset Conversion Loss Measurements to see a step-by-step example.

Mismatch Errors

Mismatch errors result when there is a connection between two ports that have different impedances. With S-parameter measurements, these mismatches are measured and mathematically removed during a full 2-port calibration. This is much more difficult with frequency offset measurements. A much easier solution is to use high-quality attenuators on the input and output of the mixer.

By adding a high-quality attenuator to a port, the effective port match can be improved by up to twice the value of the attenuation. For example, a 10-dB attenuator, with a port match of 32 dB, can transform an original port match of 10 dB into an effective match of 25 dB. However, as the match of the attenuator approaches the match of the original source, the improvement diminishes.

Note: The Frequency Converter Application (option S93083A/B) uses calibration techniques that correct for mismatch errors.

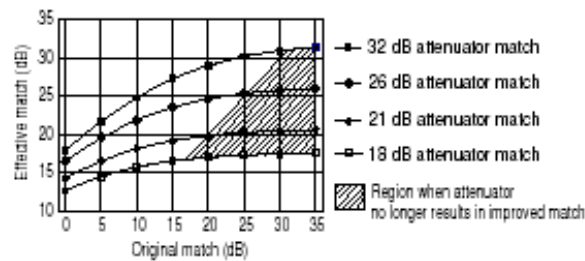

The larger the attenuation, the more nearly the resulting match approaches that of the attenuator, as shown in the following graphic. However, excessive attenuation is not desired because that will decrease the dynamic range of the measurement system.

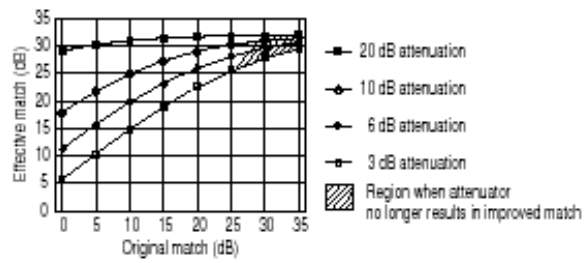

Accurate and Stable LO

When using frequency offset mode, if the LO signal is not accurate and stable, the output signal will not be at the expected response frequency. As a result, the output signal can fall on the skirts of the VNA receiver IF filter, or fall completely outside of the receiver filter passband.

Also, the LO power level is critical in mixer measurements. Be sure to monitor these power levels closely.

Conversion Loss (or Gain)

Note: The M937xA/P937xA does not support this function.

- What is Conversion Loss?
- Why Measure Conversion Loss?
- How to Measure Conversion Loss

See other Frequency Converting Device Measurements

What is Conversion Loss?

Conversion loss is defined as the ratio of the power at the output frequency to the power at the input frequency with a given LO (local oscillator) power. This is illustrated in the graphic below. A specified LO power is necessary because conversion loss varies with the level of the LO, as the impedance of the mixer diode changes.

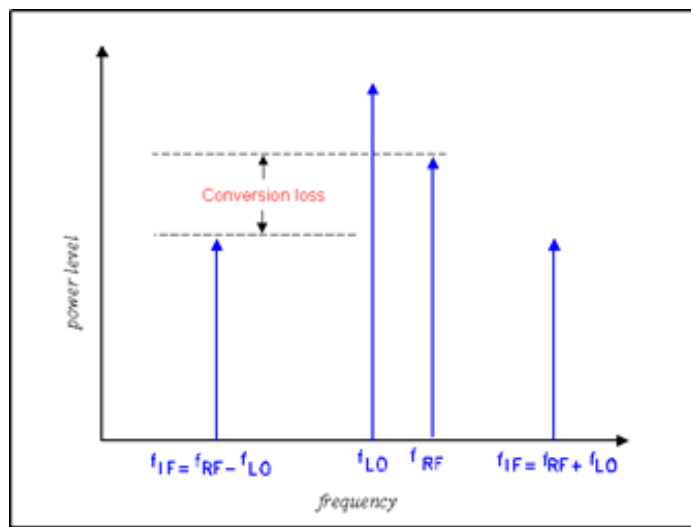

Why Measure Conversion Loss?

Conversion loss (or gain in the case of many converters and tuners) is a measure of how efficiently a mixer converts energy from the input frequency to the output frequency. If the conversion loss response of a mixer or converter is not flat over the frequency span of intended operation, valuable information

may be lost from the resulting output signal.

How to Measure Conversion Loss

Conversion loss is a transmission measurement. It is measured by applying an input signal (stimulus) and an LO signal at specific known power levels, and measuring the resulting output signal level. Because the output frequency is different from the input frequency, **frequency offset** mode (option S93080A) must be used for this measurement.

Note: This measurement is made much easier if your VNA has the **Frequency Converter Application**

Equipment Setup

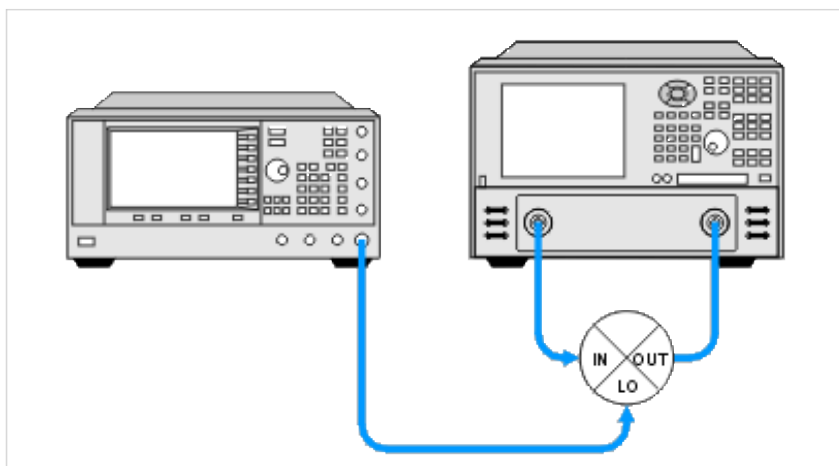

Example: A calibrated Conversion Loss (Down-converter) measurement

Swept Input with Fixed LO = Swept Output

- RF Input: 3.1 - 3.3 GHz
- LO: 2.2 GHz
- IF Output: 900 - 1100 MHz

VNA setup and calibrate on channel 1

1. On channel 1 create an **unratioed** R measurement over the ENTIRE input and output frequency span (.9 - 3.3 GHz). This will be the base source power cal that will be copied to the R and B channel measurements.
2. Perform a **source calibration** using a power meter. This makes the power level at the input of the mixer very accurate.

Setup Reference measurement on channel 2

1. **Copy channel** 1 to channel 2 which will display the reference input to the mixer. The channel 1 source power cal is copied with the other channel settings.
2. Change measurement to R1 unratiod.
3. Change RF Input frequency to 3.1 - 3.3 GHz. The source power cal becomes interpolated.
4. Perform **receiver power cal**. Do not need to make physical connections. The VNA source is internally connected to the R1 receiver. Makes the R receiver read the source power level.

Setup B measurement on channel 3

1. Copy channel 1 to channel 3. This channel will display the output of the mixer. The channel 1 source power cal is copied with the other channel settings.
2. Change measurement to B unratiod.
3. Change IF Output frequency to .9 - 1.1 GHz. This causes the source power cal becomes interpolated.
4. Connect thru line from port 1 to port 2.
5. Perform receiver power cal. This makes the B receiver read the source power at the IF Output frequencies.
6. **Turn OFF receiver power cal**. This prevents an error when changing to input frequencies (next step).
7. Change RF Input frequency to 3.1 - 3.3 GHz. This changes the channel back to the mixer RF Input frequencies.
8. **Enable Frequency Offset**.
9. Change Offset to (-2.2 GHz). This tunes the B receiver to the IF Output frequencies .9 to 1.1 GHz. **Note:** The minus sign indicates a down-converter measurement.
10. Turn ON receiver power cal.

Measure the Mixer

1. Connect the mixer.
2. Adjust **scale** to suit your needs.
3. Enable **markers** to read power levels for each trace.

The display below shows:

- Ch3 B receiver (bottom trace) absolute output power.
- Ch2 R1 receiver measurement (top trace) absolute input power to the mixer.

With this method, the conversion loss math (B/R1) can be performed with **Equation Editor** (not shown). The B/R1 ratio measurement is not supported with receiver power Cal turned on. However, conversion loss (C21) measurements can be made directly and are much easier using the Frequency Converter Application, FCA (Opt S93083A/B).

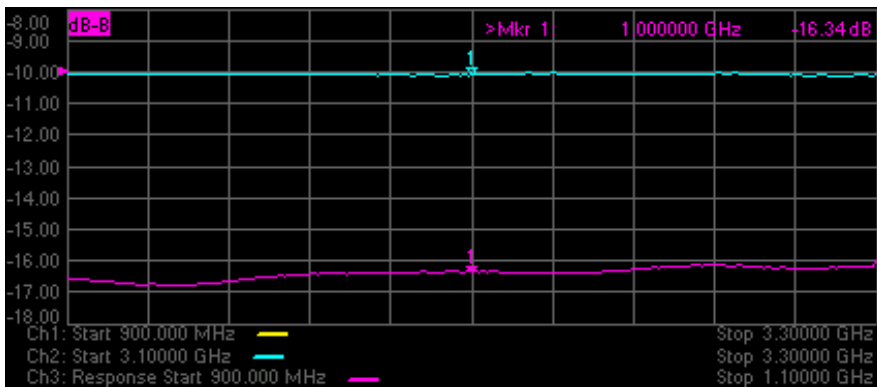

Conversion Compression

Note: The M937xA/P937xA does not support this function.

- What is Conversion Compression?
- Why Measure Conversion Compression?
- How to Measure Conversion Compression
- Measurement Accuracy Considerations

See other Frequency Converting Device Measurements

What is Conversion Compression?

Conversion compression is a measure of the maximum input signal level for which a mixer will produce linear operation. It is very similar to the **gain compression** experienced in amplifiers.

To understand conversion compression, you must first understand **conversion loss**. This is the ratio of the mixer output level to the mixer input level. This value remains constant over a specified input power range. When the input power level exceeds a certain maximum level, the constant ratio between input and output power levels begins to change. The point at which the ratio has decreased 1 dB is called the 1-dB compression point. This is illustrated in the graphic below.

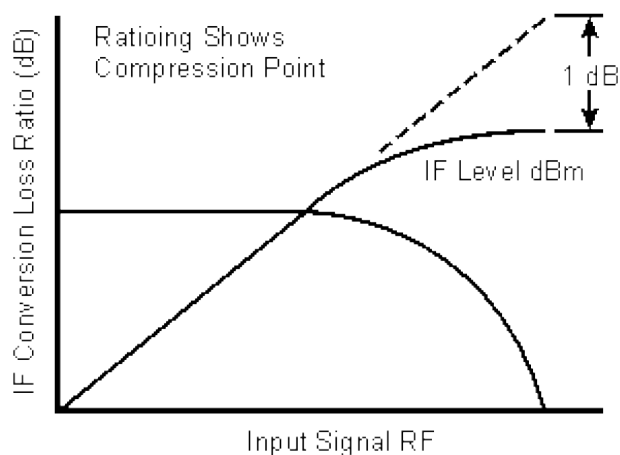

Why Measure Conversion Compression?

Conversion compression is an indicator of the dynamic range of a device. Dynamic range is generally defined as the difference between the noise floor and the 1-dB compression point.

How to Measure Conversion Compression

The equipment and setup used to measure conversion compression are essentially the same as for measuring conversion loss and is illustrated in the following graphic.

The VNA performs a power sweep using **frequency-offset mode** and the resulting display shows the mixer's output power as a function of its input power. The 1-dB compression point (or others such as 3-dB) can be determined using markers.

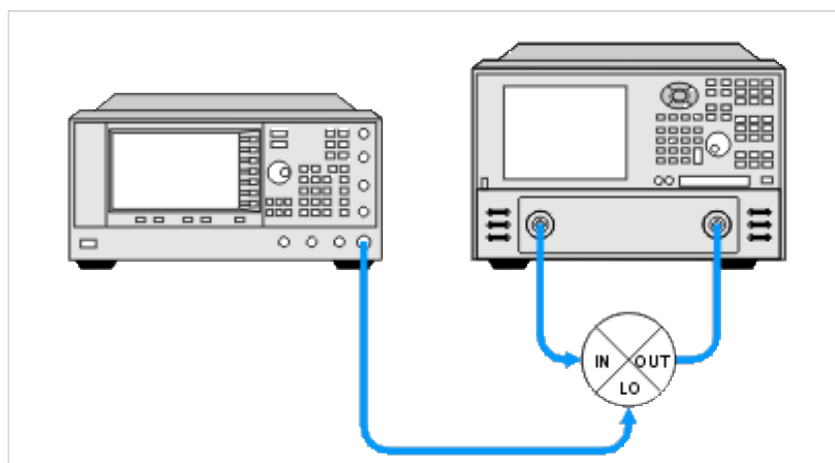

Measurement Accuracy Considerations

Equipment Setup Considerations

- The couplers in the VNA have very good directivity. If the return loss of the DUT is bad, the reflected signal gets sampled by the VNA and can result in errors. This relates to error in DUT gain. To increase the accuracy, an attenuator can be added between the VNA's source port and the DUT's input port. Normally a 6- to 10-dB attenuator is sufficient. Addition of this attenuator, however, decreases the available drive to the DUT.
- With high drive levels the VNA can be driven into compression resulting in measurement error. With excessive drive levels, the VNA can be damaged. Add an attenuator between the output of the DUT and the receiver input of the VNA to avoid these problems.

Calibration Considerations

- **Source power calibration** can be used to provide a high level of accuracy for this measurement.

Harmonic Distortion

- [What is Harmonic Distortion?](#)
- [Why Measure Harmonic Distortion?](#)
- [How to Measure Harmonic Distortion](#)
- [Measurement and Accuracy Considerations](#)

[See other Frequency Converting Device Measurements](#)

What is Harmonic Distortion?

Harmonics are multiples of any signal appearing at the mixer input and also multiples of the LO input. The distortion of the mixer's output characteristics caused by these harmonics is referred to as harmonic distortion. Harmonic distortion is caused by non-linearities in the device.

Harmonics are NOT signals created by two or more signals interacting (mixing); these signals are known as intermodulation products, which result in intermodulation distortion.

Why Measure Harmonic Distortion?

- It can degrade the performance of devices connected to the output of the mixer.
- The harmonics can also mix with other signals present in the mixer, adding to the intermodulation distortion of the mixer.

How to measure Harmonic Distortion

The harmonics can be measured using the VNA with [Frequency Offset](#) (option 80). The frequency of the LO to the mixer is set to zero and multiplier of the RF input is used to set the IF frequency (the harmonic). The equipment setup is shown below.

Since harmonics are specified in dBc, the fundamental RF and both the second and third harmonics are measured and the differences calculated. Multiple channels can be used to do this.

1. Connect the equipment.
2. Setup the measurement for calibration. See also [Measurement and Accuracy Considerations](#).

Use three channels and **frequency offset mode**:

Channel 1 = F1 to F2

Channel 2 = F1 to 2F2 (frequency offset mode, multiplier = 1)

Channel 3 = F1 to 3F2 (frequency offset mode, multiplier = 1)

- Perform a source power calibration and receiver power calibration over the entire frequency range. See **Measurement and Accuracy Considerations**.

- Reduce the frequency span and increase the frequency offset multiplier on Channels 2 and 3:

Channel 2 = F1 to F2 (frequency offset mode, multiplier = 2)

Channel 3 = F1 to F2 (frequency offset mode, multiplier = 3)

Note: Because the frequency span has been changed from that used for calibration, the source and receiver calibrations will be interpolated.

- Connect the DUT, make the measurement, and calculate the harmonic response:

Set up markers on Channels 1, 2 and 3, and determine the difference between the marker values to get the dBc value of each harmonic.

Channel 1 - Channel 2 = 2nd harmonic (dBc)

Channel 1 - Channel 3 = 3rd harmonic (dBc)

Note: Be sure to set the markers to the appropriate stimulus. Channel 2 markers should be set to twice the frequency of Channel 1 markers. Channel 3 markers should be set to three times the frequency of Channel 1 markers.

Measurement and Accuracy Considerations

Equipment Setup Considerations

- A filter must be used at the input of the mixer to remove the VNA source harmonics.

Return Loss and VSWR

- [What are Return Loss and VSWR?](#)
- [Why Measure Return Loss and VSWR?](#)
- [How to Measure Return Loss and VSWR](#)

[See other Frequency Converting Device Measurements](#)

What is Return Loss and VSWR?

Return loss and VSWR are both linear reflection measurements, even when testing frequency conversion devices, because the reflected frequency is not converted. These measurements are essentially the same as for filters and amplifiers. Learn more about [Reflection Measurements](#).

Why Measure Return Loss and VSWR?

Devices which have poor return loss and VSWR result in loss of signal power or degradation of signal information.

How to Measure Return Loss and VSWR

Setup the VNA measure return loss and VSWR as you would any two-port device. Connect your frequency converting device as shown in the following diagrams:

RETURN LOSS AND VSWR OF MIXER INPUT PORT

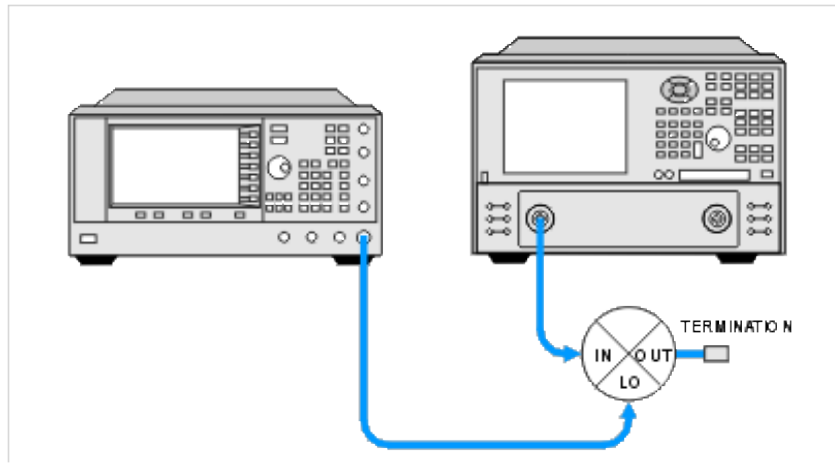

RETURN LOSS AND VSWR OF MIXER OUTPUT PORT

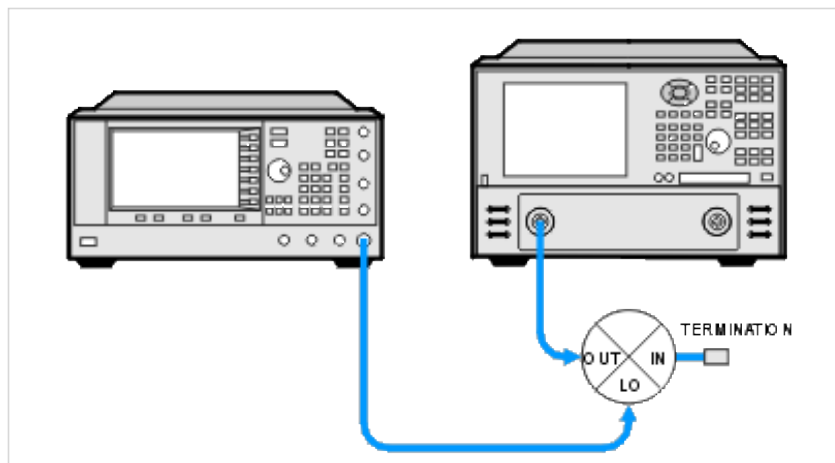

RETURN LOSS AND VSWR OF MIXER LO PORT

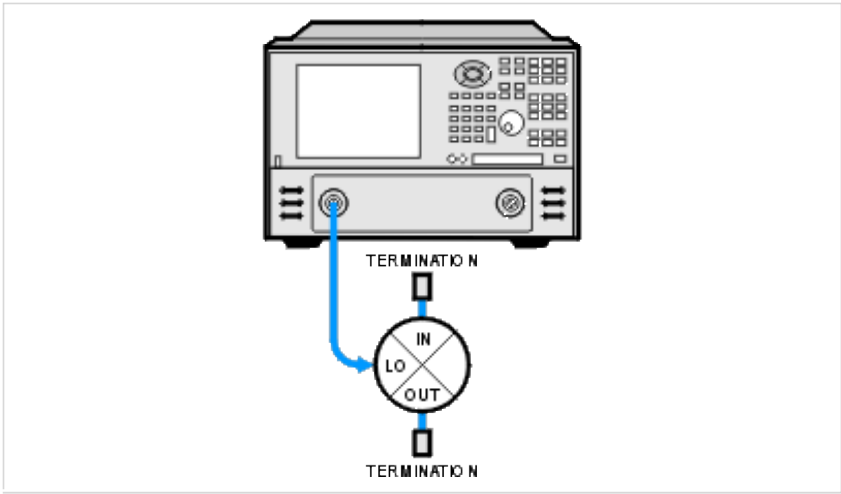

Vector-Mixer Calibration

- [Overview](#)
- [Characterizing Calibration Mixer \(with IF filter\)](#)
- [Executing Characterization of Calibration Mixer](#)
- [Characterizing Calibration Mixer \(with IF filter\) for Balance Mixer Measurement](#)
- [Executing Characterization](#)

Other topics about Mixer Calibration

Overview of VMC (Vector-Mixer Calibration)

The VNA has a vector-mixer calibration function for use in measuring frequency conversion devices.

The vector-mixer calibration allows you to measure the magnitude, phase and group delay of the mixer's conversion loss by using in combination calibration standards (OPEN/SHORT/LOAD) and calibration mixer with an IF filter, as well as the network de-embedding function incorporated in the VNA.

Note: For Fixed RF measurement (RF: Fixed, LO and IF: Swept), it is NOT possible to perform vector-mixer calibration because touchstone file, which defined with fixed frequency, can not be imported to ENA.

Note: For Fixed IF measurement (RF and LO: Swept, IF: Fixed), it is possible to perform vector-mixer calibration and to measure conversion loss and return loss, but NOT possible to measure group delay because IF frequency is fixed.

Note: For Swept IF measurement (RF and IF: Swept, LO: Fixed), it is possible to perform vector-mixer calibration and to measure conversion loss, return loss and group delay.

You can also perform balanced mixer measurements by using two calibrations mixers that each has an IF filter.

Vector-mixer calibration is implemented by eliminating the characteristics of the calibration mixer and IF filter by using the network de-embedding function after full 2-port calibration has been completed. Using the up/down conversion method allows you to specify the same sweep measurement frequency for the input and output ports, thus enabling full 2-port calibration at the end of the target port.

Consequently, only the characteristics of the measured mixer (DUT) can be obtained by using the network de-embedding function, after eliminating the characteristics of the calibration mixer with an IF filter from all measurement results.

Note: Since the up/down conversion method is used in vector-mixer calibration, the frequency-offset function is not used. But, option 009 is required to use the VMC macro, SG control, and etc.

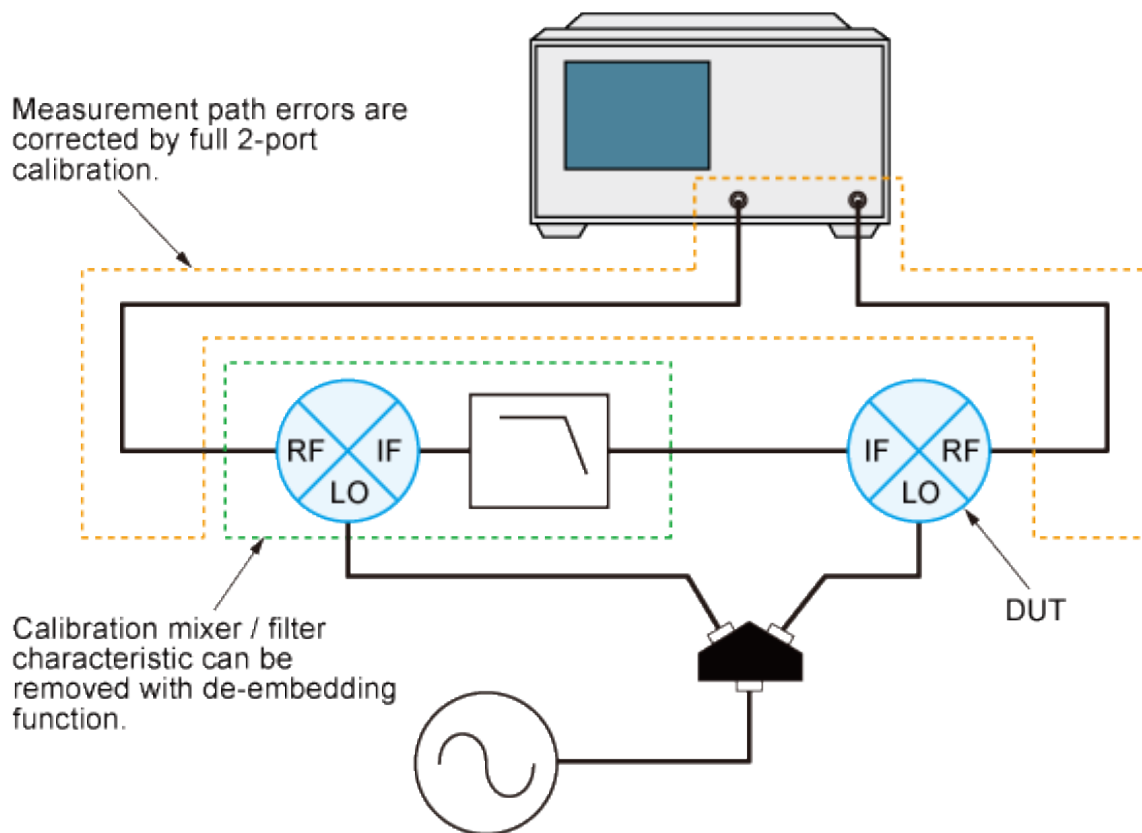

e5071c340

The vector-mixer calibration requires the characteristics data for the calibration mixer with IF filter.

Measured mixer

A measured mixer (DUT) signifies an unknown target mixer of measurement. However, a measured mixer meeting the requirements for a calibration mixer can be used as a calibration mixer.

Calibration mixer (with IF filter)

The calibration mixer is required for supporting the measurement system of the up/down conversion. You must also evaluate in advance the frequency response characteristics of the calibration mixer. The vector-mixer calibration method obtains the characteristics of the measured mixer alone by using the network de-embedding function to eliminate the characteristics of the calibration mixer from the

measurement result. You can use the IF filter to select any required frequency conversion component such as RF+LO, RF-LO, and LO-RF. The calibration mixer and IF filter can be seen as a part of the test system setup, just like the network analyzer and the test cable; they are connected at the same location during the entire calibration or measurement.

Note: The frequency range must be equal to or greater than that of the measured mixer. If you want to test multiple mixers with a single setup, select a wide range of calibration mixers that can cover all frequencies of the target test devices.

Characterizing Calibration Mixer (with IF filter)

In vector-mixer calibration, you must characterize the calibration mixer with the IF filter. As shown in the following figure, connect the target mixer (with IF filter) to the port of the network analyzer on which vector calibration has been performed and then connect an OPEN, SHORT or LOAD standard to the end of the IF filter to start reflection measurement. The signals measured at the test port include the reflection signal from the mixer's RF port, the IF signal (IF+) converted by the mixer and then reflected by the IF filter, and the IF signal (IF-) passing through the IF filter and then reflected by the calibration standard.

The characteristics of the calibration mixer can be described in a 1-port error model, and each error item can be determined from Γ_O , Γ_S , and Γ_L , which are obtained in the reflection measurement of individual standards.

Characteristics evaluation of calibration mixer (with IF filter)

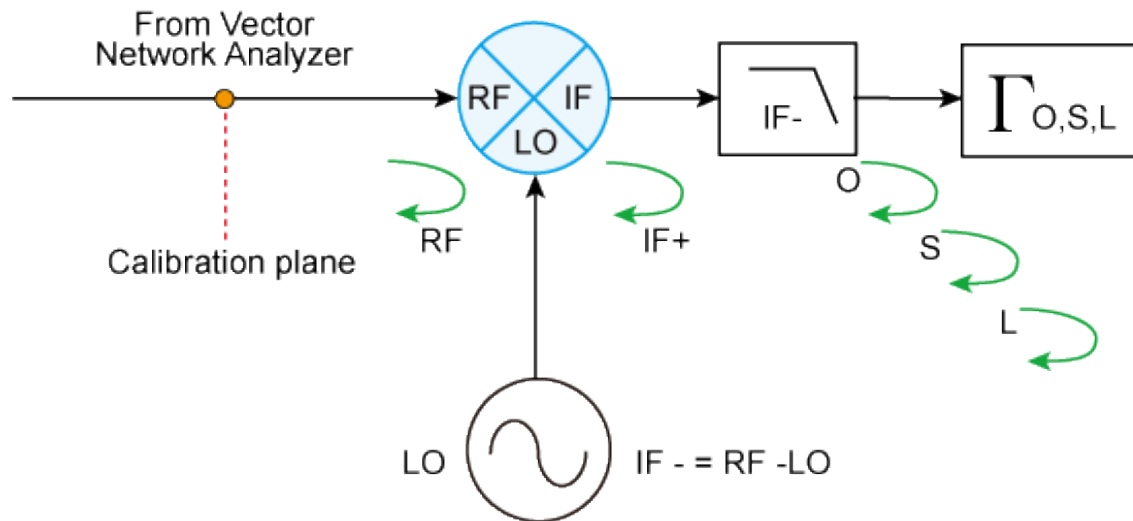

e5071c458

Note: The calibration mixer must be reciprocal. The term "reciprocal" means the magnitude and phase of the conversion loss are equal both in the forward and reverse directions. The forward conversion loss occurs during the measurement of the output signal at the IF port while inputting measurement signals into the RF port. In contrast, the reverse conversion loss occurs during measurement of the output signal at the RF port while inputting measurement signals into the IF port.

Note: For precise calibration, the conversion loss in each direction must be less than 10 dB using a calibration mixer and IF filter in combination. Exceeding 15 dB of the conversion loss in any direction may deteriorate the calibration accuracy significantly.

Characterizing procedure for calibration mixer (with IF filter)

Executing Characterization of Calibration Mixer

1. Setting Stimulus Conditions

Set the stimulus conditions for the channel you want to calibrate. You must also set the **external signal source** in advance.

2. Opening VMC dialog box

Note: Full 2-port calibration is recommended for characterizing the calibration mixer with the IF filter, although 1-port calibration is also available. This is because using full 2-port calibration simplifies the evaluation procedures.

1. In Standard measurement class, clicking **Cal** > **Other Cals** > **Mixer Characterization....**

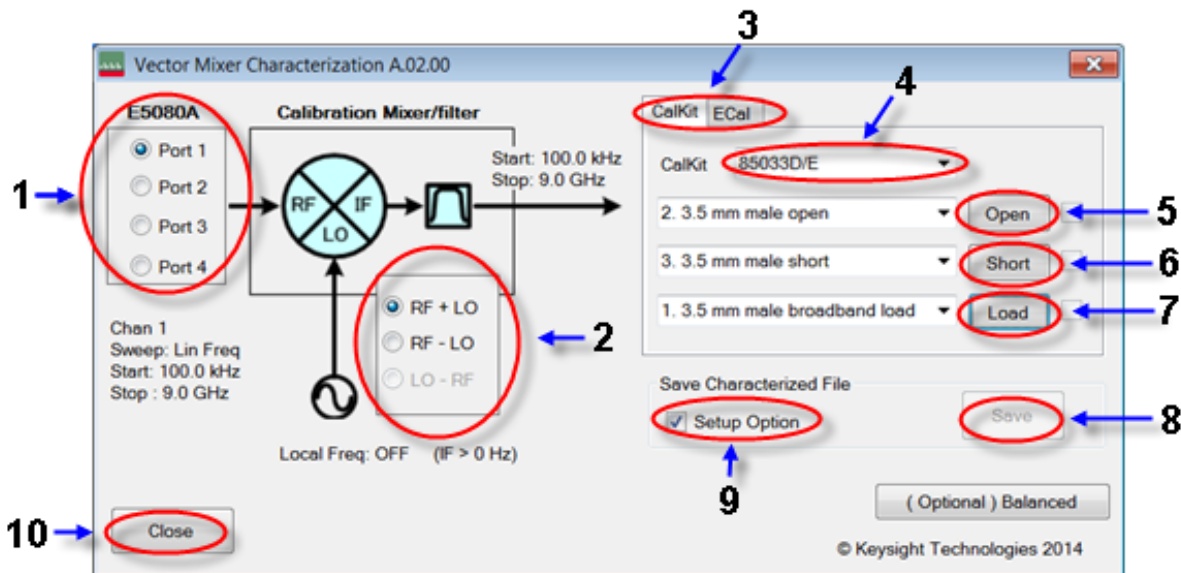

3. Selecting Measurement Port

Select the 1-port calibration port (1 in menu).

4. Setting IF Frequency

Select IF frequency from RF+LO, RF-LO and LO-RF (2 in menu), depending on the IF frequency of the calibration mixer.

Note: The number displayed in the Vector Mixer Characterization macro is the frequency set in the VNA and read from it. You must also set the minimum IF frequency at more than 0 kHz. IF BW must be set to much smaller value than IF frequency.

5. Selecting a Calibration Kit

Select a calibration kit (3 in menu).

Note: The mechanical calibration kit displayed in the Vector Mixer Characterization macro is the frequency registered in the VNA and read from it. If an ECal module is connected to the VNA, ECal will be selected automatically.

6. Measuring Calibration Mixer with IF Filter (when using calibration kit)

Connect the calibration mixer to one of the test ports on which 1-port calibration has been done, as shown in the following figure.

Connection of calibration mixer (with IF filter)

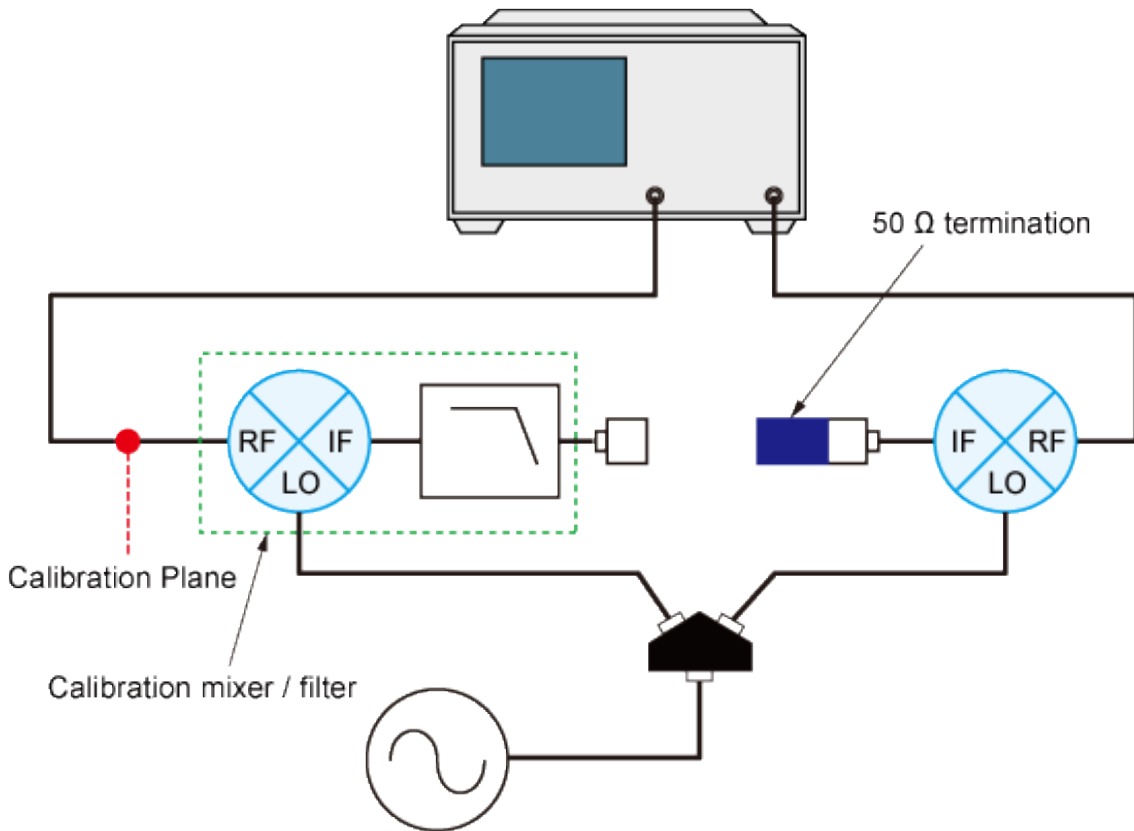

e5071c341

Note: Select any port if full 2-port calibration is set.

Note: We recommend that you characterize the calibration mixer with an IF filter when the power splitter for distributing the LO signal is connected to the measured mixer. In vector-mixer calibration, where the up/down conversion method is used, the power of the LO signal is distributed to the calibration mixer and the measured mixer through the power splitter. During a characteristics evaluation of the calibration mixer, the LO power level used by the drive of the calibration mixer must be equal to the LO power level with the measured mixer connected. This is because the mixer's conversion loss and reflection coefficient are significantly affected by the power level of the LO signal.

1. Select CalKit (3 in menu).
2. Select the type number of the calibration kit from CalKit menu (4 in menu).
3. Click the Open button (5 in menu) to start measurement in OPEN.
4. Click the Short button (6 in menu) to start measurement in SHORT.
5. Click the Load button (7 in menu) to start measurement in LOAD.

7. Measuring Calibration Mixer with IF Filter (when using ECal module)

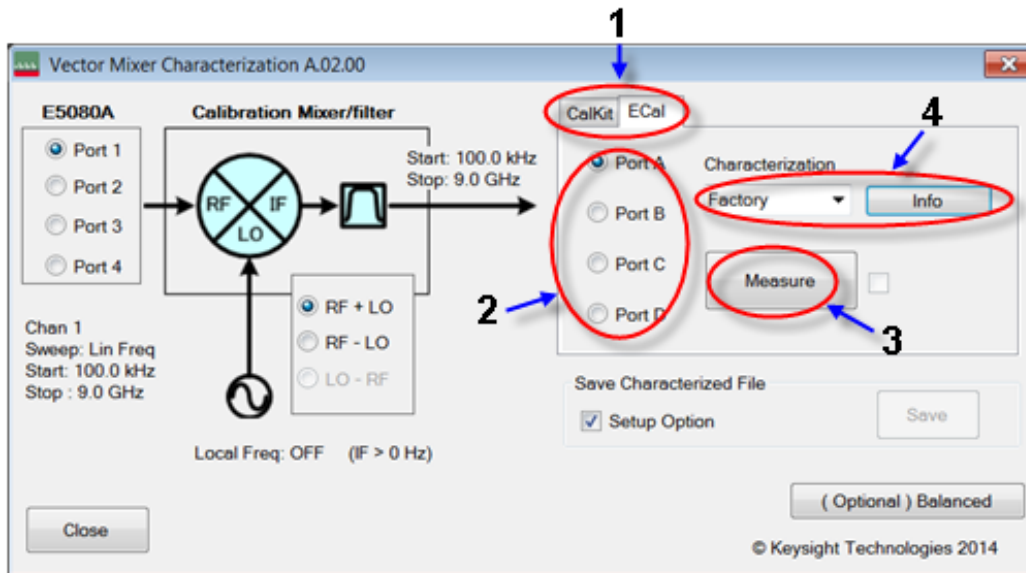

1. Select ECal (1 in menu).
2. Select the port used for the ECal module (2 in menu).
3. Click the Measure button (3 in menu) to start measurement.
4. Select the property and click info (4 in menu) to see the measurement.

8. Saving Characteristic Data and Closing Macro

1. Press the Save button (8 in menu) to open the Save screen.
2. Press the Save button to specify a name for the characteristic data of the calibration mixer with IF filter. Then save it to a Touchstone file. If you check the Setup Option (9 in menu), the saved characteristic data will be set for the specified port of the active channel as the characteristic data file of the network de-embedding, and the fixture simulator function will be enabled. If unchecked, only the characteristic data will be saved.
3. Click the Close button (10 in menu) to exit the macro.

Characterizing Calibration Mixer (with IF filter) for Balance Mixer Measurement

The Vector Mixer Characterization macro provided with the VNA allows you to characterize the calibration mixer (with IF filter) to be used for the balanced mixer measurement. The characterizing procedures of the calibration mixer with IF filter used for balance mixer measurement are basically the same as those used for normal mixer measurement; however, two characteristic data of the calibration

mixer with IF filter are required for balanced mixer measurement, as shown in the following figure.

Connect the target calibration mixer (with IF filter) to the port of the network analyzer on which calibration has been performed and then connect the OPEN, SHORT and LOAD standards to the end of the IF filter to start reflection measurement and characterization. For a balanced mixers, the phase difference of the LO signals between the calibration mixers with IF filter will remain as an error, since each calibration mixer with IF filter is characterized independently. Therefore, you must calibrate the phase difference between the two characterized calibration mixers with IF filters.

Characteristics evaluation of calibration mixer (with IF filter) for balance mixer

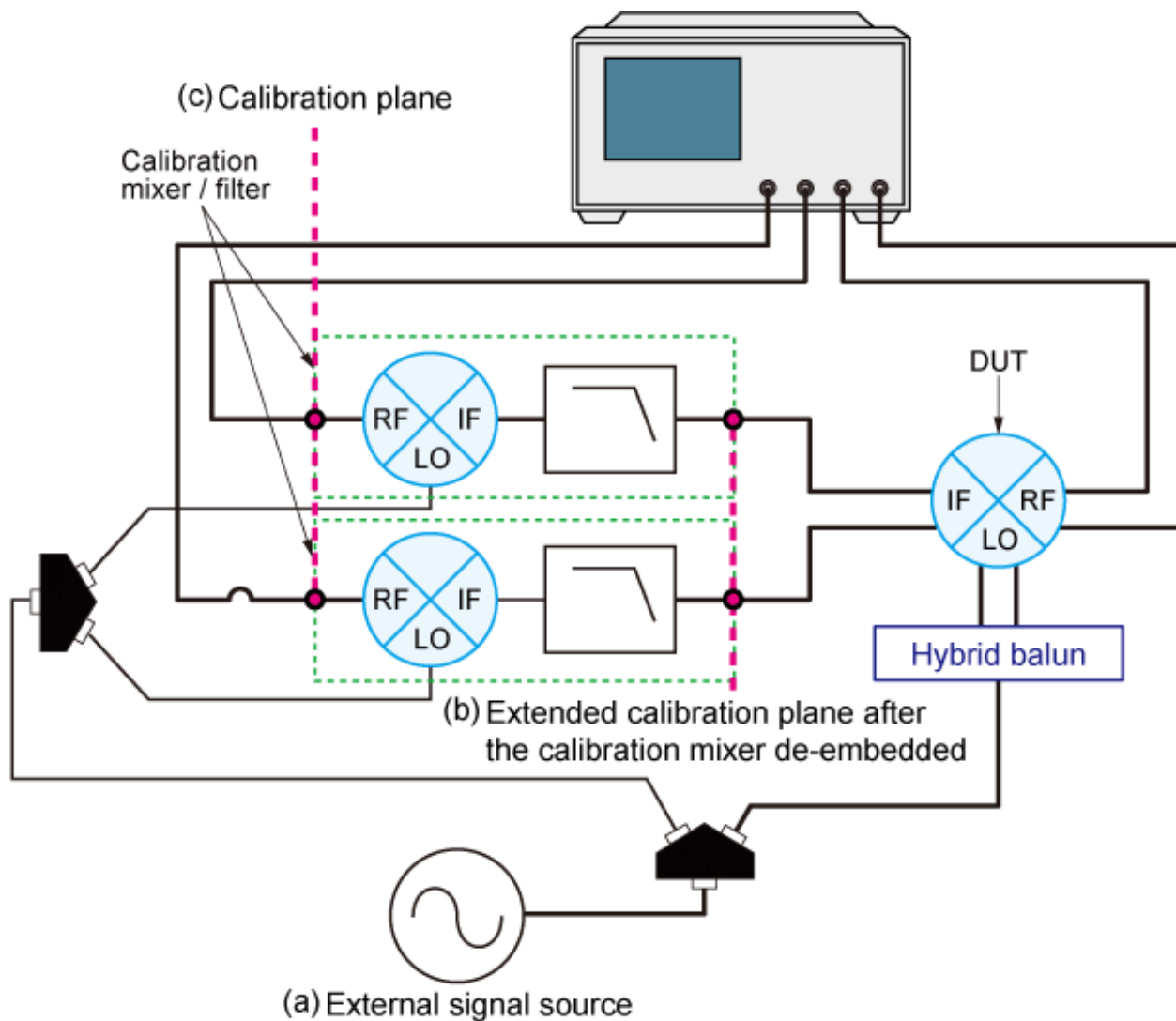

e5071c342

Note: We recommend that you use the same products of calibration mixers, IF filters and cables between the balanced ports to which each calibration mixer (with IF filter) is connected. You should keep the following electrical lengths the same between the two ports to which the

calibration mixer is connected as much as possible - the electrical length from the external signal source output port (a) to the extended calibration plane (b), and the electrical length from the calibration plane (c) to the extended calibration plane (b). Large electrical length differences between the two ports to which the calibration mixer is connected could raise 180 degrees phase value error between the two IF ports even though the Balanced Mixer Calibration Macro is executed. You can verify it by swapping the IF cable connections with each other.

Executing Characterization

1. Characterizing Calibration Mixer (with IF filter)

Measure the characteristic data of each calibration mixer with the IF filter used for balanced mixer measurement, using any two ports.

Set the stimulus conditions for the channel you want to calibrate. You must also set the **external signal source** in advance.

Note: If you characterize a calibration mixer with an IF filter, we recommend that you perform full 4-port calibration in advance, since it simplifies the evaluation procedures.

1. Press Macro > Macro 1 > VMC.
2. Select Port 1 (1 in menu) to characterize the calibration mixer 1 with IF filter. In this case, the data are saved to a temporary file (MIXER_1.s2p).
3. Select Port 2 (1 in menu) to characterize calibration mixer 2 with IF filter. Here, the data are also saved to a temporary file (MIXER_2.s2p).

Note: For detailed information on characterizing the calibration mixer, see **Characterizing procedure for calibration mixer (with IF filter)**.

4. Click (Optional) Balanced Mixer (2 in menu).

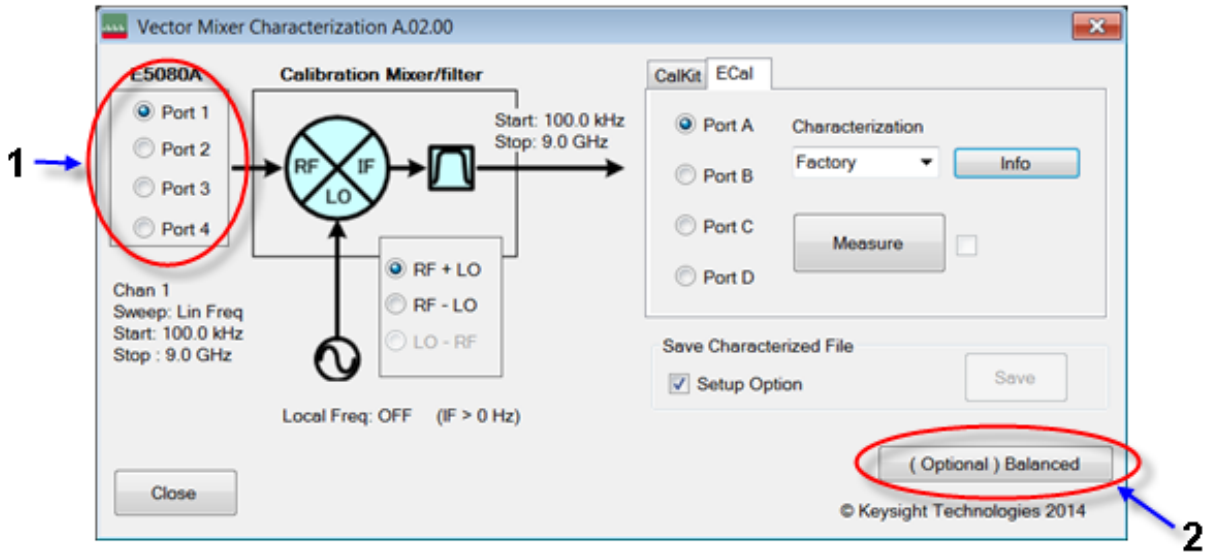

- As the Vector Mixer Characterization Macro is running, the data files of the pre-measured calibration mixer with IF filter (MIXER_1.s2p, MIXER_2.s2p) are read automatically into the macro (1 in menu).

Note: If failure occurs when reading the data file for the calibration mixer with IF filter, the characterization may have done by using only one port instead of using two ports.

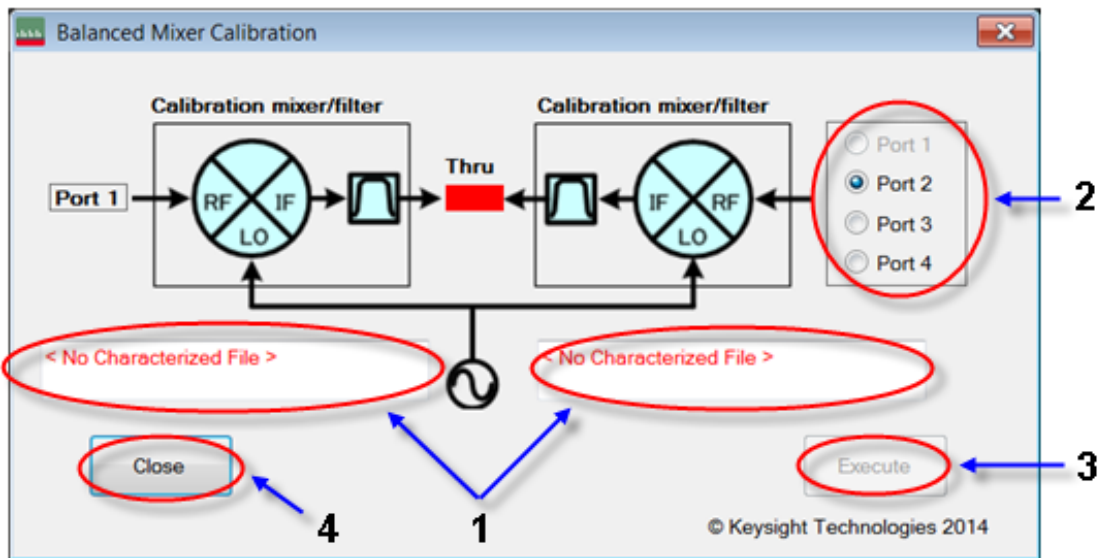

- Select the measurement port (2 in menu) and then connect a THRU between the IF ports of the calibration mixers to correct the phase difference of the LO signals for the calibration mixers with IF filters.

2. Pressing the Execute (3 in menu) button executes a phase error correction and overwrites the results on the original data file.
 - You cannot run the Execute function when selecting the measurement port if the data file of the calibration mixer with IF filter (*.s2p) has not been set for the network removal function of the fixture simulator.
 - The phase error correction data reflects the phase difference of the LO signals for the phase information of the calibration mixer's data file, which is registered in any two ports.
3. Press the Close button (4 in menu) to exit macro.

Gain Compression for Amplifiers GCA (Opt S9x086A 086)

Note: The M937xA/P937xA does not support this function.

- [Features, Requirements, and Limitations](#)
- [Gain Compression Concepts](#)
- [Understanding the GCA Displayed Traces](#)
- [Gain Compression Parameters](#)
- [Compression Methods](#)
- [Acquisition Modes](#)
- [Using Gain Compression App](#)
 - [Frequency tab](#)
 - [Power tab](#)
 - [Compression tab](#)
 - [Safe Sweep Mode dialog](#)
- [Compression Analysis](#)
- [Saving GCA Data](#)
- [GCA Measurement Tips](#)
- [Macros](#)

See Also

- [GCA Calibration](#)
- [Programming commands](#)
- **App Note** [Amplifier Linear and Gain Compression Measurements](#)

Other VNA Applications

Features, Requirements, and Limitations

Features

- Fast, easy, and complete Gain Compression measurements for amplifiers.
- Many **compression parameters** to choose from, including gain, input power at compression, output power at compression, input match, and compression level.
- Several **compression methods** to choose from, including deviation from linear gain, deviation from max gain, back-off, and X/Y, and compression from saturation.
- Three **acquisition methods** to choose from: Power per Freq, Freq per Power, and SMART Sweep
- **SMARTCal Calibration Wizard** to guide you through Full 2-Port or Enhanced Response calibration, plus Source Power calibration.
- **Compression Analysis** allows traditional power sweep view at a selected frequency.
- **Receiver Leveling** provides continuous source power accuracy.
- Supports Wideband (NOT Narrowband) Pulse measurements using the new integrated **Pulse setup dialogs**.

Requirements

- Option S9x086A (software option only) **must be enabled**.
- When performing an optional calibration:
 - ECal module or Calibration Kit
 - Power meter/sensor

Limitations with GCA

- Number of points limited to 100,001 for two-dimensional acquisitions, 50,000 points for SMART Sweep.
- Standard CW power sweep is NOT supported in a Gain Compression channel.
- Independent IFBW, Power Levels, Shift LO, or Sweep Time in a **segment table** is NOT supported.
- Stepped sweep mode only.
- Linear, Log, and Segment frequency sweep modes only.

The following VNA Features are **NOT** Available in a Gain Compression channel:

- Unratioed receiver measurements (A, B, R)
- ECal User Characterization
- Some Fixturing Features
- FOM or FCA
- External Test Set Control
- Interface Control
- CW Time sweep
- Balanced measurements
- Save Auto Formatted Citifile data.
- Narrowband Pulse measurements using the Integrated Pulse App

Gain Compression Application Concepts

What is Gain Compression

An amplifier has a region of linear gain, where the gain is independent of the input power level. This gain is commonly referred to as small signal gain. As the input power is increased to a level that causes the amplifier to approach saturation, the gain will decrease. The 1 dB gain compression is defined as the input power level that causes amplifier gain to drop 1 dB relative to the linear gain.

You can quickly measure the gain compression using a **compression marker** on a power sweep trace.

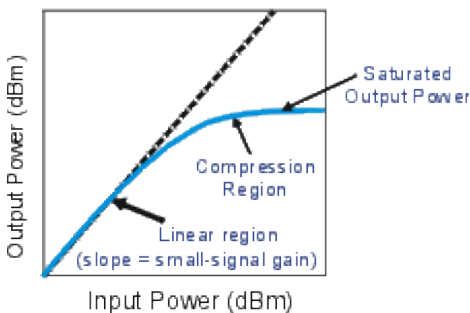

Terms used in GCA

Linear Power Level The specified input power that yields linear gain (also known as 'small-signal gain') in the amplifier.

Reference gain The measured gain that is used as a reference for determining compression level. The

Compression Method that is used could cause this value to be different.

Compression level The specified amount of gain reduction from the reference gain.

Target gain The gain at the specified compression level. Although this term does not appear in GCA, it is important to understand when discussing the various compression parameters.

For example, when using **Compression from Linear Gain** method with the following settings:

- Linear gain (measured at Linear Input power) = 10.2 dB
- Compression level (specified) = 1 dB
- Target gain = 9.2 dB

This is called 'Target' gain because GCA will search for the closest measured gain to 9.2000 dB. It may not measure this gain exactly.

Compression point The operating point at which the measured gain is closest to the Target Gain. All **compression parameters** report data for this operating point.

Understanding the GCA Displayed Traces

One of the most important concepts to remember with GCA is that, each frequency data point represents many measurements using different input power levels.

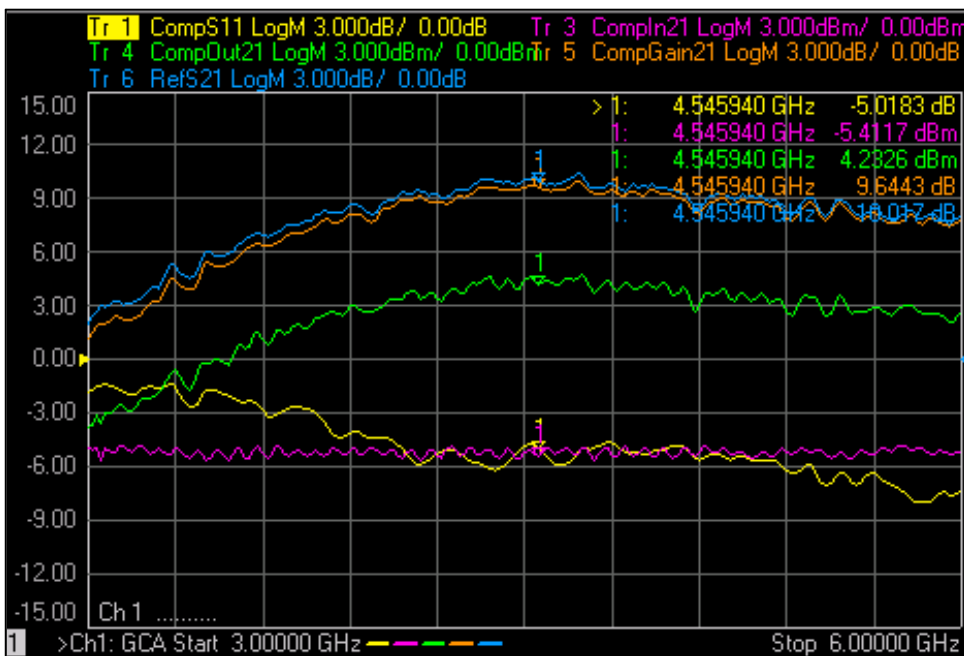

Some things to notice about how GCA displays **compression** data:

1. The X-axis values are ALWAYS frequency. Imagine behind each frequency data point, a traditional power sweep curve with corresponding measurements and calculations to find the specified compression point.
2. The Y-axis values are always reported at the **compression point**. The value that is displayed depends on the **compression** parameter that you choose. The **S-parameters** that are displayed in a GCA channel are always measured at the **linear and reverse** power level.

Example: Five of the six GCA **compression parameters** are displayed in the above image. The missing trace, **DeltaGain21** is discussed below.

- Markers are placed at 4.549 GHz for all of the parameters.
- **Tr 3 CompIn21** (Input power at the compression point) shows the marker value to be **-5.4117 dBm**. This is the power into the DUT that was required to achieve the compression point. Notice that this is about the same input power required to achieve the specified compression at ALL frequencies.
- **Tr 5 CompGain21** (Gain at the compression point) shows the marker value **9..6443 dB**. This is the measured gain at the compression point.
- To see the gain at a different input power at this frequency, use the **Compression Analysis** feature.

Create a GCA Measurement

1. Press **Meas > S-Param > Meas Class....**
2. Select **Gain Compression**, then either:
 - **OK** delete the existing measurement, or
 - **New Channel** to create the measurement in a new channel.

Gain Compression Parameters

There are several Gain Compression parameters, as well as standard S-parameters and ADC parameters, that can be measured in a GCA channel.

How to add GCA Parameters

Using **Hardkey/SoftTab/Softkey**

1. Press **Trace**, then select trace.
2. Press **Meas**, then select a parameter.

Using a mouse

1. Click **Instrument, Trace, Add Trace**.
2. Click **Response, Meas**, then select a parameter.

◀ Programming Commands ▶

Linear S-Parameters

For convenience, the standard S-parameters are offered in a GCA channel. S11 and S21 are measured at the specified Linear Input level. S22 and S12 are measured at the specified Reverse power level.

Note: When a **DC meter** is added, it will be displayed in the New Trace dialog and **SMART Sweep Safe Mode** dialog (in DC Parameters pull down menu).

Parameter	Description	When Measured
S11	Input Match	Always
S21	Gain	Always
S22	Output Match	See Reverse
S12	Reverse Isolation	See Reverse
AI1	Linear AI1	
AI2	Linear AI2	

Compression Parameters

Note: The following table assumes: DUT **Input** = VNA **port 1** and DUT **Output** = VNA **port 2**.

When the Port mapping is different, the parameters in GCA are updated accordingly. For example, with Input = port 2 and Output = port 1, then "CompIn12" would be displayed.

The raw data for these parameters are always measured.

Parameter	Description
CompIn21	Input power at the compression point.
CompOut21	Output power at the compression point.
CompGain21	Gain at the compression point.
CompS11	Input Match at the compression point.
RefS21	Linear Gain value used to calculate the compression level. This is calculated differently depending on the compression method.
DeltaGain21	CompGain21 MINUS Linear Gain (in Log Mag format). This trace can be used to learn a lot about the DUT compression point. Learn more.

Compression Methods

GCA offers the following methods to find the compression point of an amplifier using GCA:

Compression from Linear Gain

The Reference Gain is measured using the specified Linear (Input) Power Level. The Target Gain is calculated as the Linear Gain minus the specified Compression Level. For example 8.3 dB - 1 dB = 7.3 dB.

Compression from Max Gain

The linear region of an amplifier gain may not be perfectly linear. The highest gain value that is found at each frequency is used as the Reference (S21) Gain. The **Target Gain** is found in the same way as Compression from Linear Gain.

Compression from Saturation

This method is used to better find the compression point when measuring amplifiers with non-linear gain as shown in the following image:

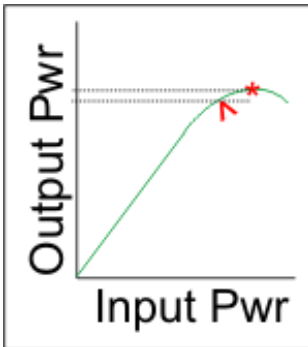

The Max power out value * is found at each frequency. Then input power is lowered until the output power decreases by the specified 'From Max Pout' value. This is the compression point.^

Backoff and X/Y method

These two compression methods are very similar.

- Both methods specify a difference in input power (X axis) between the linear region and compression point.
- For the Y-axis difference:
 - **Backoff method** specifies Compression Level which is a difference in **Gain**.
 - **X/Y method** specifies Delta Y which is a difference in **Output Power**.

GCA searches for these points differently for **2D sweeps** and **SMART sweep**.

The following images show how Backoff and X/Y method is calculated at ONE frequency.

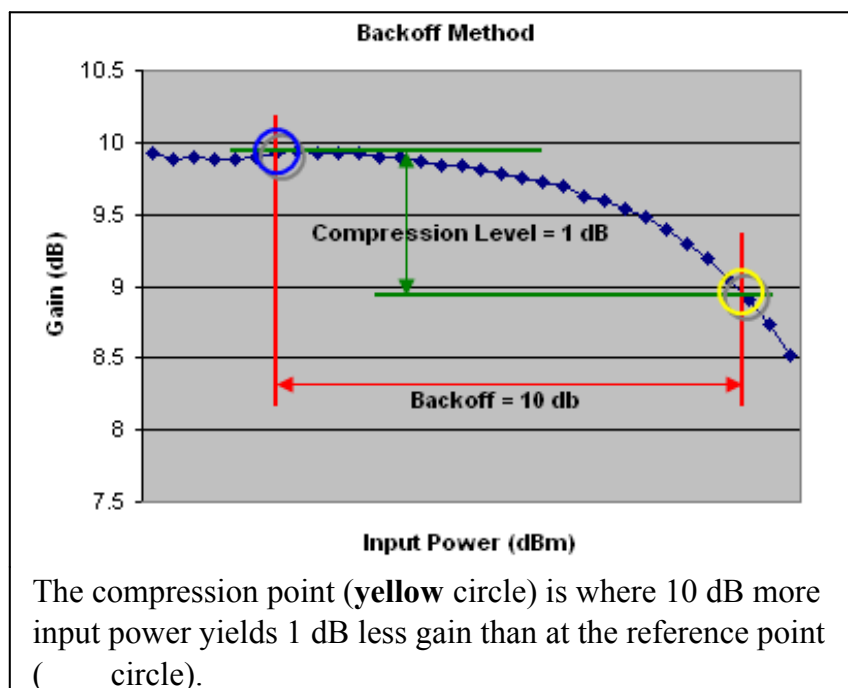

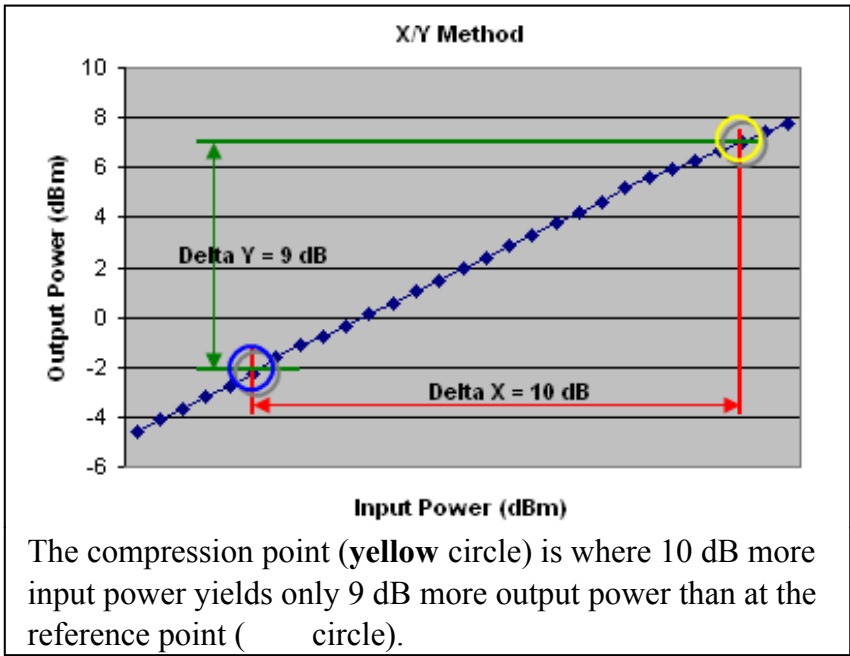

Acquisition Modes

The GCA offers three modes for data acquisition: Two 2D sweep modes, and **SMART sweep**.

To see a traditional power sweep at a single frequency, use the Compression Analysis feature. [Learn more.](#)

2D (two-dimensional) Sweeps

This is the easiest method to understand, and the least efficient for finding the compression point. Both 2D sweep modes work as follows:

1. All GCA measurements begin by measuring S-parameters at the specified Linear Power level. Reverse parameters are measured ONLY if Full 2-port calibration is applied or if a reverse parameter is displayed. [Learn more about Cal choices.](#)
2. Gain measurements are then made at ALL of the specified frequency and power values. Although these are conceptually 2-Dimensional sweeps, a single sweep is constructed in firmware. [See Data Points Limit.](#)
3. After data has been measured, a search is performed to find the compression point. You can choose to interpolate between the two measured points closest to the target gain. [Learn more.](#)

As each sweep is performed, dots are plotted next to the **Ch** indicator in the lower left corner of the display to indicate progress for the current sweep.

Note: For **Backoff and X/Y compression method**, GCA does not verify that the specified Start - Stop power

range is at least the size of the specified Backoff or X value. The closest compression point is always reported.

Note: SMU Hardware List trigger mode is NOT supported in GCA 2D sweeps.

2D Sweep Modes

- **2D Sweep Power per Frequency** - Input power is stepped from **Start to Stop** at each specified frequency. From the following example you can see that the device is exposed to the highest power level (p3) at the first frequency (f1). This could heat the device early in the measurement and affect compression results.

The following examples show (frequency, power) values for three frequency points and three power points, resulting in a total of 9 measurements:

1	2	3	4	5	6	7	8	9
f1,p1	f1,p2	f1,p3	f2,p1	f2,p2	f2,p3	f3,p1	f3,p2	f3,p3

- **2D Sweep Frequency per Power** - Frequency is swept from start to stop at each specified power level as follows:

1	2	3	4	5	6	7	8	9
f1,p1	f2,p1	f3,p1	f1,p2	f2,p2	f3,p2	f1,p3	f2,p3	f3,p3

Viewing and Saving 2D Data

It is NOT possible to plot ALL of the 2D measurement data on the VNA display. However, it can be saved to a *.csv file and then read into an Excel spreadsheet. The initial S-parameter measurement data is not saved to this file. [Learn more.](#)

You can also view on the VNA all power sweep information at a selected frequency using the [Compression Analysis](#) feature.

SMART Sweep

SMART Sweep is usually the fastest and most accurate method to measure Gain Compression. Unlike the 2D acquisition modes which measure all of the specified frequency / power points, SMART Sweep performs a series of power search iterations. At each frequency, an 'intelligent guess' of input power is made to find the compression level that is within tolerance. This guess is further refined with each successive power search iteration sweep.

SMART Sweep continues to iterate until one of the following conditions occur:

1. ALL data points are within tolerance. When the compression level for a data point achieves the specified

tolerance, it continues to be measured and input power changed to improve the measurement within tolerance.

2. The specified compression level can NOT be achieved for the remaining frequencies that are not in tolerance. Either the Start power is too high or the Stop power is too low.
3. Maximum iterations have been achieved. If a measured gain is not within the specified tolerance before the specified **Max** number of **Iterations** has been reached, then the **last** power reading is used as the compression point.

The Iteration Counter, Dots, and Bangs(!)

Next to the Ch indicator, in the lower left corner of a GCA window, the following annotation appears:

- An **iteration counter** is incremented each time input power is adjusted.
- A **dot** appears when another 10% of the frequency points are within tolerance.
- **!** (bangs) are displayed after the last iteration. Each bang represents 10% of the data points that are NOT within tolerance.

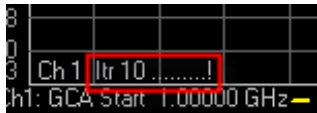

SMART Sweep and Compression Method

The intelligent guess process works differently depending on the compression method. This is important because Backoff and X/Y compression methods subject the DUT to significant changes in input power during an iteration sweep. This can affect the DUT and the measurement results.

[Learn all about Backoff and X/Y compression methods.](#)

ALL GCA measurements begin by measuring S-parameters at the specified Linear Power level. Reverse parameters are measured ONLY if Full 2-port calibration is applied or if a reverse parameter is displayed. [Learn more about Cal choices.](#)

- **Backoff and XY** Because both compression methods specify the separation between the "linear" region and the "compressed" region, each iteration requires a single sweep at **two dramatically** different power levels over the same frequency range. The first half of the sweep measures the DUT at the **Backoff** or **X** power level. The second half of the sweep measures the DUT at the compressed power level, specified by the **Start and Stop** power range. At the beginning of the second half, the power level rises by the **Backoff** or **X** value. The specified **Settling Time** is applied at this point to allow the DUT time to react to this significant change in power level. **Safe Sweep** does **NOT** minimize this change in input power. However, Safe Sweep with Backoff and XY methods **DOES** prevent the DUT from being exposed to too much input power.

- **Compression From Linear Gain** After the reference gain is measured at the linear input power, the next iteration measures the DUT at a higher power level which attempts to push the DUT well into compression. Subsequent sweeps, depending upon the compression level of the DUT, either increases or decreases the power in order to reach the desired compression level. Usually, by the third iteration sweep, a curve-fit algorithm is utilized to precisely find the compression point.

Note: The DUT can be subject to significant changes in power from one iteration sweep to the next. This can be minimized by the use of **SAFE Sweep** and careful selection of the corresponding settings.

- **Compression from Max Gain** The maximum gain that is found at each frequency is stored and used to calculate the compression point. SMART Sweep does NOT perform extra iterations to search for the maximum possible gain of the amplifier at each frequency.
- **Compression from Saturation** The maximum power out that is found at each frequency is stored and used to calculate the compression point. SMART Sweep does NOT perform extra iterations to search for the maximum possible power out of the amplifier at each frequency.

Using the Gain Compression Application

The following is a general procedure for performing a GCA measurement. The challenge with GCA is configuring a measurement that yields the true compression performance of YOUR DUT. This requires knowledge of the Gain Compression settings and knowledge of the DUT.

See specific dialog boxes below.

1. Disconnect the DUT if preset or default power levels may damage the VNA or DUT.
2. **Preset** the VNA, or configure a suitable **User Preset** that will be safe in case the DUT is connected.
3. Create a GCA channel. **Learn how**. The default trace is S21.
4. Start **GCA Setup dialog** and configure the measurement settings based on the DUT, adapters, attenuators, booster amplifiers, and fixtures to be used in the measurement.
5. Save the **instrument state** (optional).
6. Connect DUT and apply bias and RF power as appropriate. The default measurement for a GCA channel is S21 (amplifier gain). Inspect the gain measurement to ensure the DUT is operating as expected.
7. Add GCA compression parameter traces. **Learn how**.
8. Adjust the measurement settings to yield satisfactory compression parameters. **See GCA Measurement Tips**.
9. Start and complete the **GCA Calibration wizard**.

How to start the Gain Compression Setup dialog

Using **Hardkey/SoftTab/Softkey**

1. Press **Freq** > **Main** > **GCA Setup...**

Using a mouse

1. Click **Stimulus**
2. Select **GCA Setup...**

Programming Commands

Frequency tab - Gain Compression -dialog box help

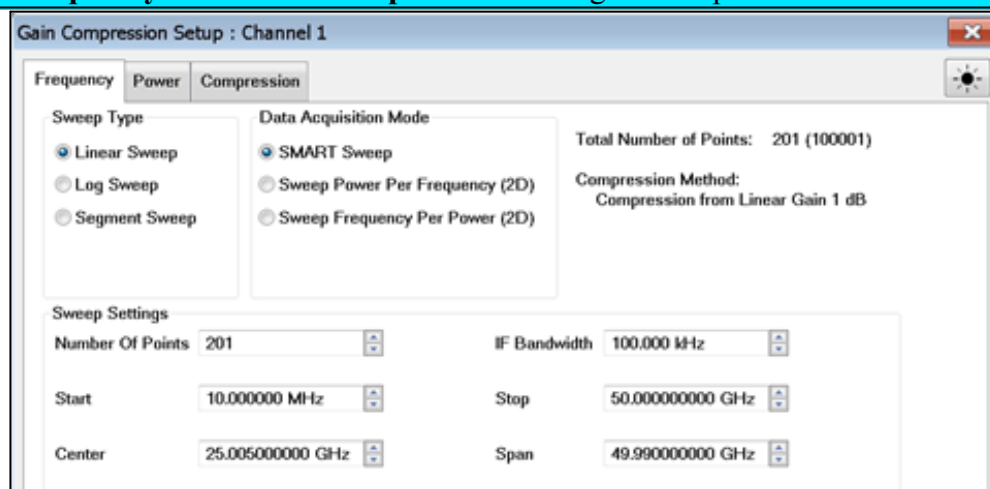

Configures the frequency settings over which Gain compression is to be measured, as well as the measurement method.

Sweep Type

Choose a method in which to sweep frequency: Linear, Log, and Segment Sweeps. This setting applies to all data acquisition modes.

Notes

- CW Sweep is NOT available in GCA. However, to see a traditional power sweep at a single frequency, use the [Compression Analysis](#) feature.

Segment Sweep Notes (GCA ONLY)

- The segment table shown on the dialog is **'READ-ONLY'**.
- Learn how to [Create and edit the Segment Sweep table](#).
- **Independent IFBW** and **Power** are NOT available.
- [X-axis point spacing](#) is available beginning with A.09.10.

Data Acquisition Mode

Specifies HOW the gain compression data is collected.

SMART Sweep

- At each frequency, input power is 'intelligently' adjusted to find a measured gain equal to the target gain.
- Faster and more accurate than 2D sweeps to measure Gain Compression point at a number of frequencies.
- [Learn ALL about SMART Sweep](#)

2D (two-dimensional) Sweeps

- **Sweep Power per Frequency** Performs a series of power sweeps at each successive frequency.
- **Sweep Frequency per Power** Performs a series of frequency sweeps at each successive power level.
- [Learn ALL about 2D sweeps](#)

Sweep Settings

Click each to learn more about these settings.

- **Number of points** Number of frequency points to measure. The Frequency points may be limited due to the number of specified Power points. [See Data Points Limit](#).
- **IF Bandwidth** Set this value to yield acceptable trace noise when measuring gain at the linear power

level. This level of noise contributes directly to the accuracy of compression point. A lower value (narrower IFBW) allows for more accurate, but slower, measurements. See [GCA Measurement Tips](#) to see how to best set IFBW.

- **Start / Stop, Center / Span** frequencies. Set the frequency range over which to measure Gain compression.

Data Points Limit

The maximum number of measurement data points depends on Acquisition method and Compression method as follows:

	SMART sweep	2D sweep
Compression method	Number of frequency points is reduced to ensure the total number of data points does not exceed the specified limit. Frequency points = $\text{maxpoints}/2$.	Number of power points is reduced to ensure the total number of data points does not exceed the specified limit.
• Compression from linear gain	Data points = freq points Max = 100,001	Data points = (freq. points) * (power points) Max power points = 2,001 Max data points = 100,000
• Compression from max gain	Data points = freq points Max = 100,001	
• X/Y and Backoff	Data points = 2 * freq points Max = 100,001	
• Compression from Saturation	Data points = freq points Max = 100,001	

Note: Although the dialog box will allow you to enter any number of frequency or power points, the values are checked when **OK** or **Apply** is pressed. If a limit is exceeded, the relevant data points are reduced to the maximum allowable number **without warning**.

Power tab - Gain Compression dialog box help

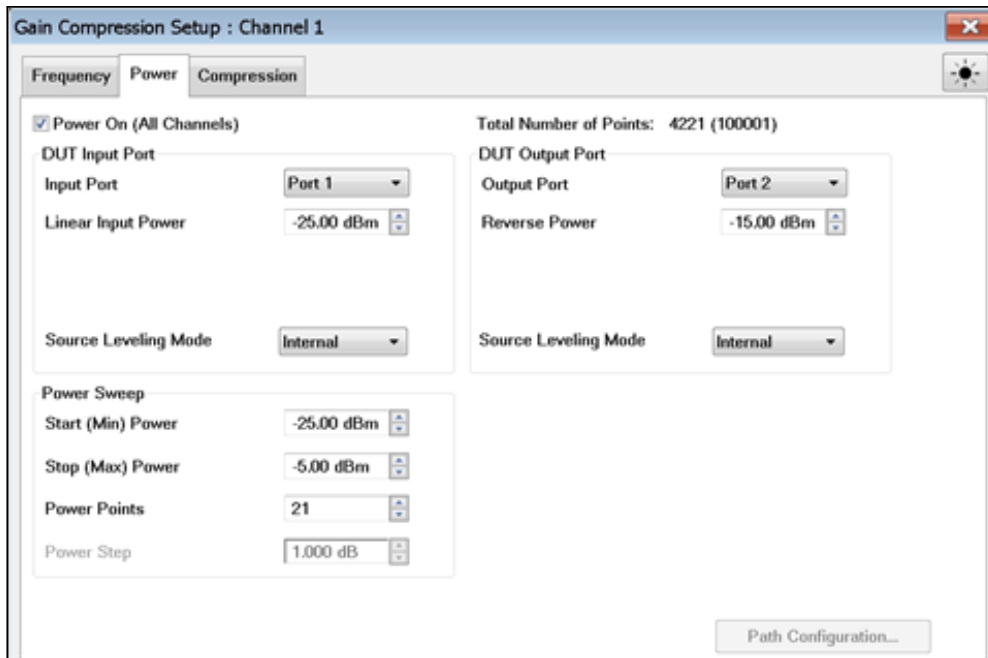

Configures RF power and Power Sweep settings for Gain Compression measurement.

Power ON (All channels) Check to turn RF Power ON or clear to turn power OFF for all channels.

Input Port

Select the VNA port that is connected to the DUT Input.

Linear Power Level The input power that yields the linear gain of the DUT. The linear gain is used as the reference gain when calculating the **Compression from Linear Gain**. Input match is also measured at this power level.

Output Port

Select the VNA port that is connected to the DUT Output.

Reverse Output Power Sets power level into the output of the DUT for reverse sweeps. Port power is automatically uncoupled.

Reverse power is applied to the DUT ONLY under the following conditions. Otherwise, this setting is ignored.

- When Linear Output Match or Linear Reverse Isolation parameters are requested.
- When Full 2-port correction is used. You can perform a full 2-port cal and downgrade to an Enhanced Response Cal to prevent reverse power from being applied to the DUT. [Learn](#)

more.

Receiver Attenuator Specifies the attenuator setting for the receiver associated with the DUT output port.(This only applicable for PNA and M9485A)

Source Leveling Specifies the leveling mode. Choose from: Internal (normal operation) or Open Loop (used only for **Wideband Pulse measurements**).

Power Sweep

Power Points Number of power points to measure for 2D acquisition modes. The Power Points may be limited due to the number of frequency data points. **See Data Points Limit**. This setting is NOT available in SMART Sweep, which uses only enough power points to find the specified compression level.

Start and Stop Power

- **2D sweep** In Backoff, X/Y, and Compression from Max Gain methods, sets the range of power levels that are applied to the DUT to find BOTH the **Reference Gain** and **Compression point**. Make sure this range is wide enough to include both. For example, if the Backoff level is 10 dB, then the power range must be greater than 10dB. Otherwise, GCA will report a compression value using the closest reference gain and compression point, which may be inaccurate. In Compression from Linear Gain, the reference gain is measured at the Linear Power Level, so the Start and Stop power levels are used to find the compression point.
- **SMART sweep** Sets the range of power over which GCA will search for the compression point. The reference gain is found using the Linear Power Level, Backoff, and X values, depending on the Compression Method. To reduce the number of iterations that are required to find the compression point, limit the Start / Stop power range to the input levels that will achieve compression. Do not include the linear region.

Power Step (Size) Calculated value from current Start, Stop, and Points settings. This setting can NOT be changed directly.

Compression tab - Gain Compression dialog box help

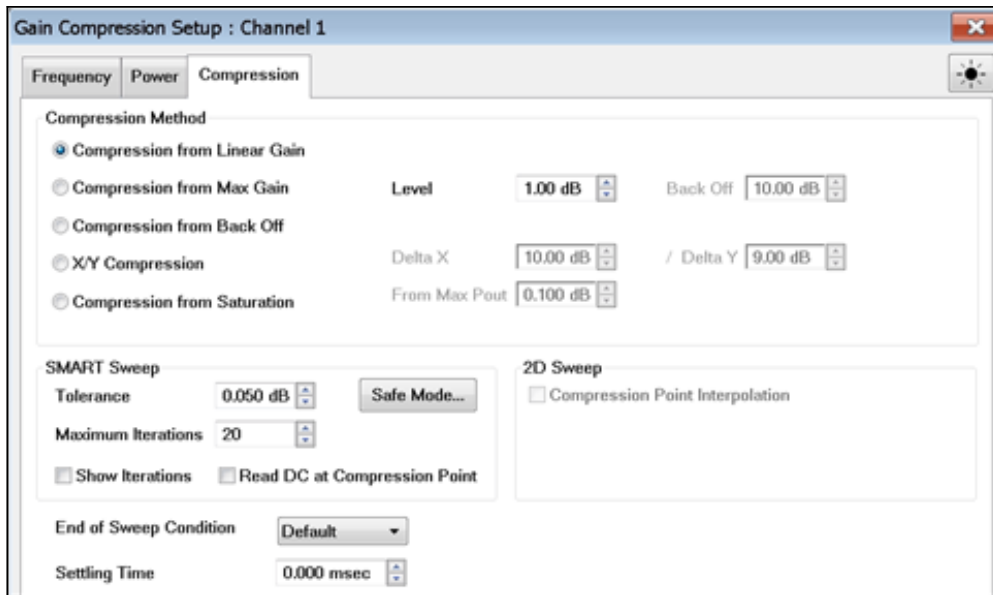

Compression Method

Learn ALL about these Compression Methods

- **Compression from Linear Gain** The specified compression level is measured from the linear gain. The linear gain is measured using the **Linear Power Level** that is specified on the **Power tab**.
- **Compression from Max Gain** The specified compression level is measured from the maximum gain level. In SMART sweep, the Max Gain value is updated as each iteration occurs. To increase the chances of measuring the actual maximum gain of the amplifier, **Safe Sweep** should be invoked using low Coarse and Fine increments.
- **Compression from Back Off** This compression method uses the Compression Level and Back Off values for finding the compression point.
- **X/Y Compression** This compression method uses the specified parameters (X and Y) as the criterion for finding the compression point.
- **Compression from Saturation** Similar to Compression from Max Gain, except the specified compression level is measured from the maximum power out level. Use this method to better find the compression point when measuring amplifiers with non-monotonic gain. In SMART sweep, the Max power out value is updated as each iteration occurs. To increase the chances of measuring the actual maximum power out of the amplifier, **Safe Sweep** should be invoked using low Coarse and Fine increments

SMART Sweep

Learn ALL about Smart Sweep.

Tolerance Specifies an acceptable range for measuring the compression level. Reducing this value can significantly increase the number of iterations that are required to find the compression point.

Maximum Iterations Specifies the maximum number of power search iterations SMART Sweep is allowed. Reducing this value can cause SMART sweep to terminate before all compression levels are found to within the specified tolerance.

Show Iterations When checked, the compression parameter traces are updated at the completion of each power search iteration. When cleared, compression parameter traces are updated when SMART Sweep completes the power search iteration process.

2D Sweep - Compression Point Interpolation

When a 2D Sweep is selected (on the **Frequency tab**), check this box to calculate and display interpolated compression traces.

The **Target gain** is calculated using a complex linear ratio between the two closest measured values. All compression parameters are then interpolated using this same ratio.

Clear the box to display compression parameters for the closest compression point, either high or low, to the level specified in the Compression Method setting.

End of Sweep Condition Specifies the power level applied to the DUT at the completion of a GCA measurement.

GCA performs numerous power and frequency sweeps on the DUT during the overall measurement process. This setting has no affect on these intermediate sweeps. This setting only applies at the end of the very last sweep in the GCA channel.

In addition, this setting applies **ONLY** to the GCA channel. All other channels operate independently of this setting. Therefore, the power applied to the DUT after all channels have been measured may be different from this setting.

Choose from:

- **Default** Use the default VNA method. [Learn more.](#)
- **RF OFF** RF power is turned off when GCA completes a measurement cycle.
- **Start Power** RF power is set to the start power level.
- **Stop Power** RF power stays at the stop power level.

Settling Time

Used **ONLY** in SMART Sweep when Back Off or X/Y compression algorithms are selected.

This setting allows additional dwell time when the input power changes from the back-off level to the compression level. [Learn more.](#)

SMART Sweep Safe Mode dialog box help

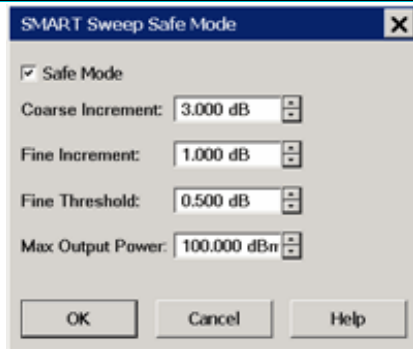

For use with SMART Sweep ONLY.

When enabled, Safe Sweep increases the input power to the DUT by the specified amounts, allowing the compression point to be achieved gradually. While this will increase the number of iterations required to achieve compression, it also minimizes the possibility of driving the DUT too far into compression.

Note: Safe Sweep does **NOT** minimize the dramatic change in input power with Backoff and XY method. However, Safe Sweep with Backoff and XY methods **DOES** prevent the DUT from being exposed to too much input power. [Learn more.](#)

Safe Mode (Enable) Check to enable Safe Sweep.

Coarse Increment Sets the maximum change in input power, up or down, which will be applied to the DUT from one iteration to the next. Default = 3.0 dB.

Without Safe Sweep, the maximum change in input power can be the entire Backoff or X value when using these compression methods.

Fine Increment Once the Fine Threshold has been achieved, this becomes the maximum change in input power, up or down, which will be applied to the DUT. Default = 1.00 dB

Fine Threshold Specifies the compression level in which Safe Sweep changes from the COARSE to the FINE increment. Default = 0.5 dB. This means that, by default, the VNA uses the Fine Increment adjustment when compression reaches 0.5 dB.

Max Output Power To protect the VNA from damage, when the VNA port that is connected to the DUT Output measures the specified value, the input power to the DUT is no longer incremented at that frequency. In these cases, the compression point would probably not be achieved.

Note: When a **DC meter** is added, it will be displayed in the New Trace dialog and **SMART Sweep Safe Mode** dialog (in DC Parameters pull down menu).

Compression Analysis

Compression Analysis changes the current trace into a power sweep trace at a specified CW frequency. The current parameter and acquisition method is unchanged. For example, with a CompGain21 trace displayed and SMART Sweep selected, enable Compression Analysis. The trace becomes a power sweep trace at the specified CW frequency. The Y-axis displays S21 Gain at each X-axis power point.

When Smart sweep is used, a complete power sweep is not performed, but only the data points that are required to find the compression point. To see a traditional power IN vs power OUT compression sweep, use one of the **2-D acquisition methods**.

You can create PNOP or PSAT markers on a CompOut trace with Compression Analysis mode ON. [Learn more.](#)

How to perform Compression Analysis

With any **compression parameter** (such as CompGainS21) displayed:

Using **Hardkey/SoftTab/Softkey**

1. Click **Math > Analysis > Compression Analysis...**

Using a mouse

1. Click **Response**
2. Select **Math**
3. Select **Compression Analysis**

Programming Commands

Compression Analysis dialog box help

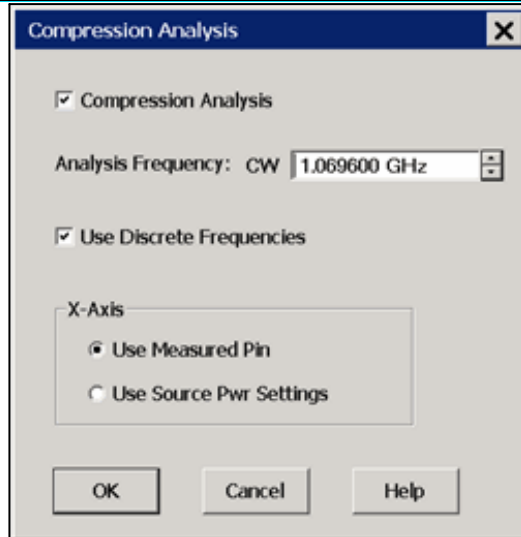

Notes: When an S21 or S11 trace is active, any **compression parameter** (such as CompGainS21) must also be displayed.

Compression Analysis is NOT allowed for S12 or S22 traces.

Scroll up to [learn more about Compression Analysis](#).

Analysis Frequency: CW Enter a frequency to use for the compression analysis trace.

Compression Analysis Check to perform compression analysis. A compression trace is displayed at the Analysis (CW) Frequency.

Use Discrete Frequencies Check to allow Analysis Frequencies at only the discrete points where data is measured. Clear to allow Analysis CW Frequencies that are interpolated from the data points. Then select ANY CW frequency between the start and stop frequencies of the GCA channel.

X-Axis

- **Use Measured Pin** The X-axis displays the actual power that is applied to the DUT after match correction and R-channel drift correction.
- **Use Source Pwr Settings** The X-axis displays the power level of the stimulus.

Saving GCA Data

Beginning with VNA release A.08.20, GCA data can be saved to a *.csv file in both 2D and SMART Sweep modes (previously only 2D modes). Also, a Delta Gain, AI1, and AI2 columns have been added

to the data. [Learn about ADC parameters.](#)

How to save GCA data

With a GCA **Compression** trace active:

Using **Hardkey/SoftTab/Softkey**

1. Press **Save Recall** > **Save Other** > **Save Data...**
2. File Type= CSV Formatted Data (*.csv).

Using a mouse

1. Click **File**
2. Select **Save Data**
3. File Type= CSV Formatted Data (*.csv).

Programming Commands

Notes

- This data type can be read by spreadsheet programs, such as Microsoft Excel.
- Data from the last **complete** sweep is saved to the specified *.csv file.
- If calibration is turned **ON** when the file is saved, then all data is calibrated. Otherwise, raw data is saved.
- All *.csv data saves include a reference power level sweep at the beginning of each frequency data.

	A	B	C	D	E	F	G	H	I	J	K
1	Agilent Technologies_N5242A_US46290053_Z 08 04 12										
2	Date: Thursday, April, 10, 2008 14:15:28										
3											
4	Calibration State OFF*										
5	Num Freq	3									
6	Num Iterat	5									
7											
8	Frequency S11	Pin Data			Pout Data			S21		Delta Gain	
9	<Hz>	<LogMag (<Phase (D	<LogMag (<Phase (D	<LogMag (<Phase (D	<LogMag (<Phase (D	<LogMag (<Phase (D
10	4.00E+09	-4.6375	152.421	-25	0	-17.2892	-34.3579	7.71076	-34.3579	4.44E-16	1.52E-15
11	4.00E+09	-4.6154	152.473	-19.7657	-132.092	-12.0009	-166.651	7.76495	-34.5593	0.054092	-0.20141
12	4.00E+09	-4.61091	152.572	-16.7746	-54.5945	-8.99388	-88.9208	7.78073	-34.3263	0.069968	0.031649
13	4.00E+09	-4.6083	152.424	-13.7818	160.191	-6.00358	125.667	7.77822	-34.5231	0.067459	-0.16519
14	4.00E+09	-4.59279	152.327	-10.7716	152.283	-3.00766	117.78	7.76391	-34.5024	0.053151	-0.14452
15	4.25E+09	-5.43633	-125.845	-25	0	-15.7527	4.97897	9.24726	4.97897	0	4.20E-16
16	4.25E+09	-5.46401	-125.925	-19.979	-118.327	-10.727	-113.371	9.252	4.95641	0.004746	-0.02256
17	4.25E+09	-5.45105	-125.983	-16.978	-141.044	-7.71819	-136.062	9.25981	4.98213	0.012559	0.003156
18	4.25E+09	-5.47133	-126.249	-13.9561	80.5926	-4.7118	85.3736	9.24425	4.78099	-0.003	-0.19798
19	4.25E+09	-5.46864	-126.271	-10.9578	-68.4214	-1.74774	-63.6055	9.2101	4.81595	-0.03716	-0.16302
20	4.50E+09	-6.37248	-34.7728	-25	0	-14.521	52.0538	10.4789	52.0538	-8.88E-16	9.26E-16
21	4.50E+09	-6.377	-35.0287	-20.0535	-142.773	-9.59433	-90.7553	10.4691	52.0174	-0.00982	-0.03642
22	4.50E+09	-6.349	-34.9226	-17.0636	-165.799	-6.56493	-113.678	10.4987	52.1201	0.019756	0.066347
23	4.50E+09	-6.36875	-35.0064	-14.055	55.4364	-3.57836	107.509	10.4766	52.073	-0.00234	0.019178
24	4.50E+09	-6.36475	-34.91	-11.0519	-94.0431	-0.59745	-41.9732	10.4545	52.0699	-0.02445	0.016094

SMART Sweep data with 5 iterations and 3 frequency points. The yellow highlight is added here for readability.

When saving or recalling 2D data:

- When Linear Input Power EQUALS Start Power, then the number of data points (rows)/ freq = num power points.
- When Linear Input Power does NOT EQUAL Start Power, the number of data points (rows)/ freq = num power points + 1.
- Make these selections on the GCA/GCX **Power** tab dialog.

GCA Measurement Tips

There are many settings in the Gain Compression Application. Here are a few tips when using GCA to learn as much as possible about the compression characteristics of your DUT in the most efficient manner.

DUT Compression Characteristics and GCA

Although GCA provides excellent results with a wide variety of amplifiers, it works best with amplifiers which have a monotonic compression curve. In some cases where the compression curve is not monotonic, for example if the amplifier gain expands before it compresses, the correct compression level may not be found.

To help a SMART sweep find the correct compression point, limit the Start and Stop power levels around the anticipated compression point. [Learn more.](#)

The following two power-sweep traces are examples of non-monotonic gain:

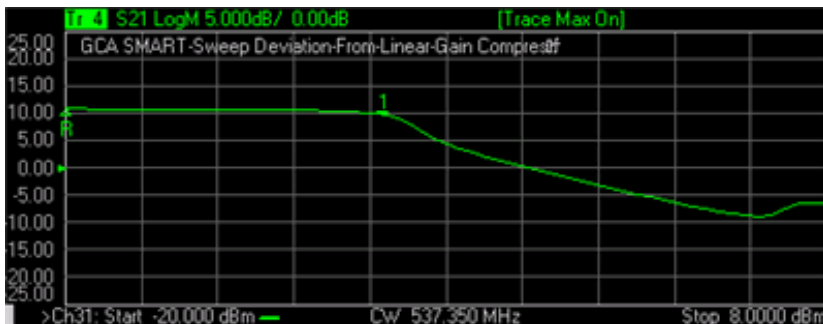
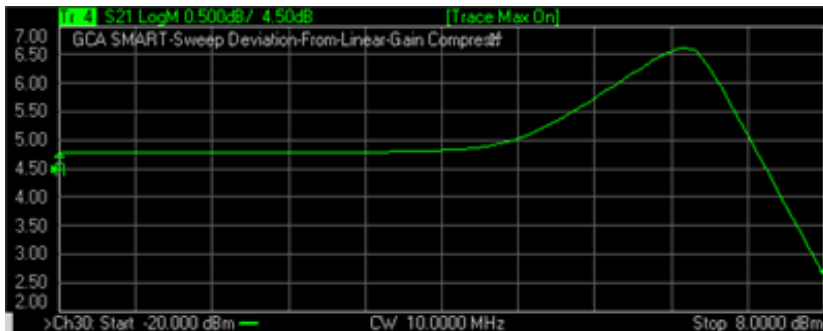

DeltaGain

A DeltaGain trace is the best way to see how closely GCA is actually measuring to the desired compression level. In addition, you can view the phase of DeltaGain to see the phase deviation between the **compressed gain** and the **reference gain**. DeltaGain is calculated as:

- $\text{DeltaGain} = \text{Measured Gain (watts)} / \text{Ref Gain (watts)}$
- In LogMag format: $\text{DeltaGain} = (\text{Measured Gain}) - (\text{Ref Gain})$

With SMART Sweep, DeltaGain (in LogMag format) shows how soon certain frequencies achieve the specified tolerance. [Learn more.](#)

Some other settings which may be helpful:

- Trigger source: Manual allows you to analyze data and make adjustments while allowing the device to cool.
- Construct Limit Lines around the compression point at the tolerance level.

The following image shows a DeltaGain21 trace using SMART Sweep. The Limit Lines were added manually.

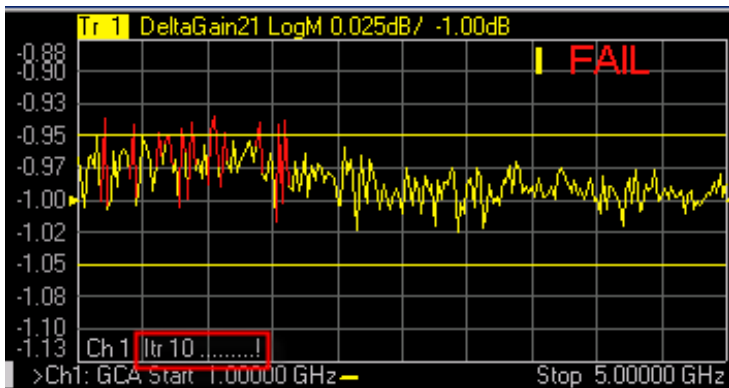

In the above image:

Relevant Settings	<p>Method = Compression From Linear Gain</p> <p>Compression level = 1</p> <p>Iteration Tolerance = 0.05 dB.</p> <p>Maximum Iterations = 10</p>
Displayed Results	<p>A data point on -1.00 indicates that, at that frequency, the exact compression level (1 dB) was measured.</p> <p>Several frequencies did not achieve the specified tolerance (0.05 dB) before the Max Iterations (10) was reached.</p> <ul style="list-style-type: none"> • FAIL and red data points outside the limit lines. • Nine dots (...) indicate that 90% of the data points achieved the specified compression level. • one ! indicates that 10% of the data points did not achieve compression. • Learn more about the Iteration Counter and annotation.

SMART Sweep Tips

- Compression from Linear Gain is the easiest compression method to understand and control in SMART Sweep. [Learn more.](#)
- If SMART Sweep requires more than twenty iterations, this is an indication that something is wrong. Try changing the Tolerance setting, Frequency Range, Start / Stop power range, IF bandwidth, or [Dwell Time](#).
- If the number of iterations required to achieve the desired compression level changes significantly from one set of measurements to the next, this could be due to other effects, such as heating. Try increasing the dwell time or using a [wideband pulse](#) measurement configuration.
- If the DUT should not be significantly overdriven into compression, or the changes in the input power should be limited, use [Safe Sweep](#) mode with Deviation from Linear Gain compression method.

Single Frequency Macros

The macros perform a single power sweep on the DUT using a standard channel with corresponding stimulus settings. The macro can show measurement differences from the compression analysis traces due to bias/thermal/settling effects of the DUT. So, the macro can help confirm a DUT is exhibiting some type of settling behavior which will need to be handled in some way.

Also, the macro is a great GCA programming example.

With a 2D sweep (NOT SMART Sweep) a script that is stored on the VNA hard drive automatically creates a traditional power sweep measurement in a standard channel using the same stimulus setting as the GCA channel. Use a marker in the GCA channel to specify the frequency for the measurement.

The script has two modes of operation:

1. **View Mode** displays all of the previous 2D sweep data at that frequency.
2. **Measure Mode** performs a new measurement at that frequency.

Both modes create a new S-Parameter channel using the same stimulus settings as the GCA channel, including port power, attenuator, IF Bandwidth, and dwell settings. The new channel does not support calibration or pulse characteristics.

To see noise on a measurement, use the **Measure** macro in continuous sweep. Adjust the IFBW and averaging until the noise versus sweep speed meets your needs.

To see other effects of your DUT at a specific frequency, use the **View** macro and the **Measure** macro with 2D sweep mode. Both macros present data using a standard channel. The View macro shows 2D data at a specific frequency, while the Measure macro shows freshly-measured data at the same frequency. Ideally, the data from these two would be identical. However, changes in your DUT behavior due to heating or other effects can cause these to be different. If significant differences exist, try:

- Using the 2D Frequency per Power setting rather than Power per Frequency
- Adjusting the dwell time
- Adjusting IFBW
- Use a **wideband pulse configuration**

How to setup the Macros

Each macro must be setup separately.

1. Press **Macro** > **Key Setup** > **Macro Setup....**
2. Select a blank line, then click **Edit**.
3. In **Macro Title**, type a short description such as Meas GCA or View GCA.
4. Click **Browse**, then navigate to C:/Program Files/Keysight/Network Analyzer/Applications/GCA/GCA.vbs

5. In Macro run string parameters:

1. Type **M** for the Measure macro or **V** for View macro.
2. Optional: Supply the following additional parameters in any order:
 - To run the program from a remote computer, specify the full computer name of the VNA .
 - Channel in which to create the measurement. If not specified, Measure is created in Ch30 and View is created in Ch31.
 - Example: Run string parameters for the Measure macro run from a remote computer in Channel 5.----
M MyVNA 5.

6. Click **OK**.

How to run the Macros

On a GCA channel:

1. Create a 2D sweep. Either Power per Freq or Freq per Power. Both macros always create a power sweep at the frequency of interest.
 2. Create a Compln trace.
 3. On the Compln trace, right-click and select **Add Marker**. Drag the marker to the frequency of interest.
 4. Press **Macro**, then select either by the short description your provided in Step 3.
-

Gain Compression Calibration

Note: The M937xA/P937xA does not support this function.

The GCA Calibration Wizard guides you through a calibration of GCA or GCX channel. The procedure is the same regardless of the Gain Compression Settings. Option 086 or S9x086A/B is required.

- A **Source Power Calibration** is performed first.
- Then, **your choice of a Full 2-port Cal or an Enhanced Response Cal.**

See Also

[Gain Compression Application](#)

[Calibration Programming commands](#)

How to start a GCA Calibration

Using **Hardkey/SoftTab/Softkey**

1. Press **CAL** > **Main** > **Smart Cal...**

Using a mouse

1. Click **Response**
2. Select **Cal**
3. Select **Smart Cal...**

[Programming Commands](#)

Overview - GCA Source Power Cal

The GCA Calibration Wizard first performs a Source Power Cal. The GCA Source Power Cal is a little different from a standard Source Power Cal. Although GCA measurements are performed at many power levels, the GCA source power cal is performed at a **single power level** over the specified frequency span of your GCA measurement. The required source correction from that single power level is applied to ALL power levels. This method ensures that the 'absolute' power level being applied to the DUT is within the PNA-X source power linearity specification.

Although it is important for GCA to be able to **set** the absolute power level to the DUT, it is MOST important to be able to exactly **measure** the actual incident power. Therefore, during the GCA Source Power Cal, a receiver calibration is applied to the port 1 reference receiver, and indirectly to both test

port receivers during the S-parameter calibration, correcting for impedance mismatch between the power meter and the VNA source, and the DUT and the VNA source.

Although the cal process is also at a single power level, the dynamic accuracy of the PNA-X receivers is typically about +/- .05 dB, which is comparable to the accuracy of Keysight's best power sensors. This allows GCA to **very accurately** measure and report ALL power levels that are actually applied to the DUT.

Full 2-port or Enhanced Response (ER) Cal

By default, a full 2-port calibration is performed as part of a GCA and GCX calibration. However, you can change to an **Enhanced Response** Cal. The following issues may help you decide between these two Cal types:

- **Accuracy** A full 2-port correction is more accurate than ER when GCA measures linear gain. However, for non-linear measurements, ER yields identical compression values as a full 2-port cal, so this may not be a significant factor.
- **Measurement speed** An ER correction only requires measurements in the forward direction. The reverse parameters (usually S22 and S12) are not measured unless requested. With a full 2-port cal applied, all four S-parameters are measured, which requires an additional reverse sweep. [Learn more.](#)
- **Ease** A full 2-port cal is easiest with an ECal module. An ER Cal requires a **Defined Thru** or a **Flush Thru Cal** method. If these are possible, then an ER cal is easiest when using a mechanical Cal Kit.
- **High power** The test port damage level of a standard PNA-X is +30 dBm. Therefore, external attenuation may be required on the output of high power amplifiers, which degrades calibration accuracy for reverse (full 2-port) measurements. In addition, the external attenuation improves the DUT output / load match error, which allows a better uncorrected response and makes an Enhanced Response Cal the better choice.
- **DUT limitations** With an ER Cal applied, reverse measurements on the DUT are not performed unless requested.

How to select Enhanced Response Cal

At the [Select DUT Connectors](#) page of the GCA Cal Wizard:

1. Check **Modify Cal**, then click **Next**.
2. A **Defined Thru** or a **Flush Thru Cal** method must be selected.
3. Click **Cal Type/Std**
4. Under Calibration type, select **EnhResp** (2 <= 1 refers to the receive port 2 and source port 1).

Downgrade a Full 2-port Cal to Enhanced Response Cal if you prefer to perform a Full 2-port cal,

but not perform reverse sweeps on the DUT.

To change the correction on the channel from Full 2-port to Enhanced Response:

1. Press **CAL** > **Main** > **Correction Methods**.
2. Select **GCA EnhResp**, then **OK**.

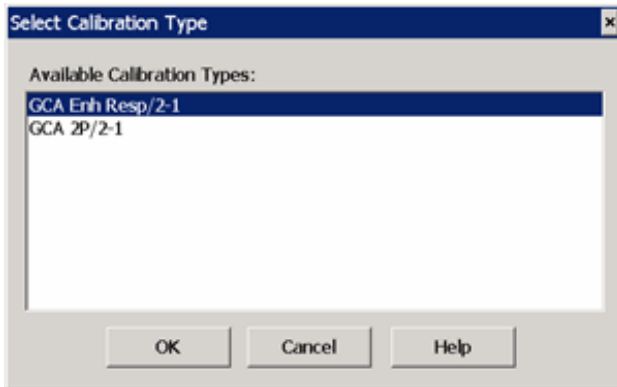

GCA Cal Wizard

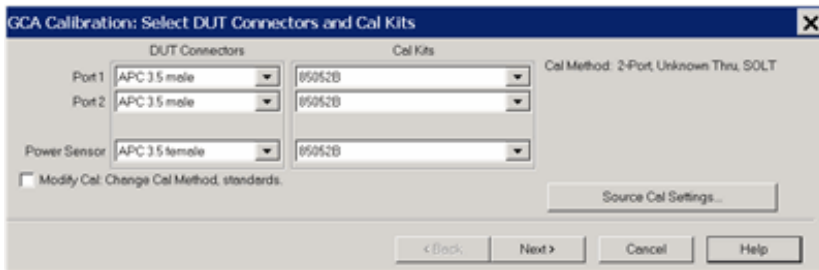

Select DUT Connectors and Cal Kits - GCA Cal dialog box help

This is a **standard Cal Wizard** page except for the following:

Power Sensor Specify the connector type and gender of the power sensor. When the power sensor connector is not the same type and gender as the DUT Port 1 connector, then an adapter is required to connect the power sensor to the port 1 reference plane during the Source Power Cal. An extra 1-port cal is performed to measure and correct for the adapter. No characterization S2P files are required.

- Select **Ignored** (at the bottom of the DUT Connectors list) to NOT compensate for the adapter.
- Select the Cal Kit that will be used for that process.

Modify Cal Check, then click **Next**, to Modify Cal (Standards AND Thru Method).

Source Cal Settings Click to launch the **Source Cal Settings** dialog.

[Learn more about GCA Source Power Calibration](#)

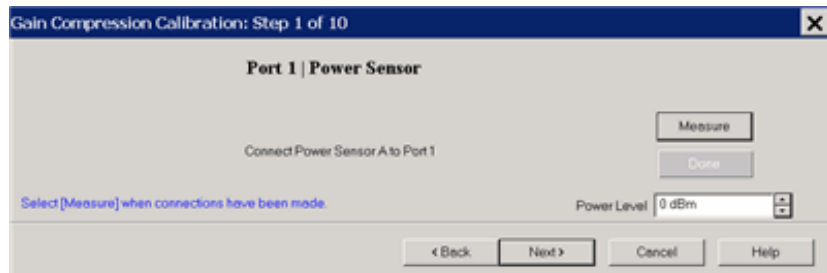

Gain Compression Calibration Step 1 dialog box help

Power Level at which to perform the Source Power Cal.

It is usually best to perform the Source Power Cal at 0 dBm because the power sensor is calibrated at that level.

However, if the Gain Compression measurement is performed entirely below or above 0 dBm, then perform the Source Power Cal at the **Stop** power which probably has the lowest level of measurement noise.

[Learn more about GCA Source Power Calibration](#)

The remaining Gain Compression Cal dialogs are the same as the standard **SmartCal** dialogs.

Return to [Gain Compression Application](#).

Integrated Pulse Measurements

Note: The M937xA/P937xA does not support this function.

The Pulse Setup dialogs shown in this topic are now integrated in the VNA firmware and are available with S9x025A or M9485A-025.

Note: (M980xA/P50xxA) In addition to S9x025A, option 021 (pulse modulation hardware) is required in order to output a pulsed modulated source signal. Option 021 is useless without S9x025A. In the multi-module configuration, the modules without option 021 output the source signal without pulse modulation. This function is not available in SA mode.

External pulse generators can be used along with the VNA internal pulse generators. [Learn more.](#)

In this topic

- [Hardware Setup](#)
- [Pulse Setup](#)
- [Pulse Generator Setup](#)
- [Pulse Trigger Tab](#)
- [Pulse Gens and IF Block Diagram](#)
- [Calibration in Pulse](#)

See Also (separate topics)

- [Configure and Use External Pulse Generators](#)
- [Programming commands](#)

App Note: [Active-Device Characterization in Pulsed Operation Using the PNA-X \(1408-21\)](#)

Hardware Setup for Pulsed-RF measurement

M9485A

Connect the cable (p/n M9485-61604) between M9310A Trig 1 connector and one of the four pulse output pins (connectors). See [Handler I/O Connector \(M9485A\)](#) for pulse output pins.

M980xA/P50xxA

If pulse signals are required for an external device, **Y1731A I/O adapter** is necessary.

How to start the Pulse Setup dialog

Using **Hardkey/SoftTab/Softkey**

1. Press **Sweep** > **Source Control** > **Pulse Setup...**

Using a mouse

1. Click **Stimulus**
2. Select **Sweep**
3. Select **Sweep Control**
4. Select **Pulse Setup...**

Programming Commands

Pulse Setup dialog box help

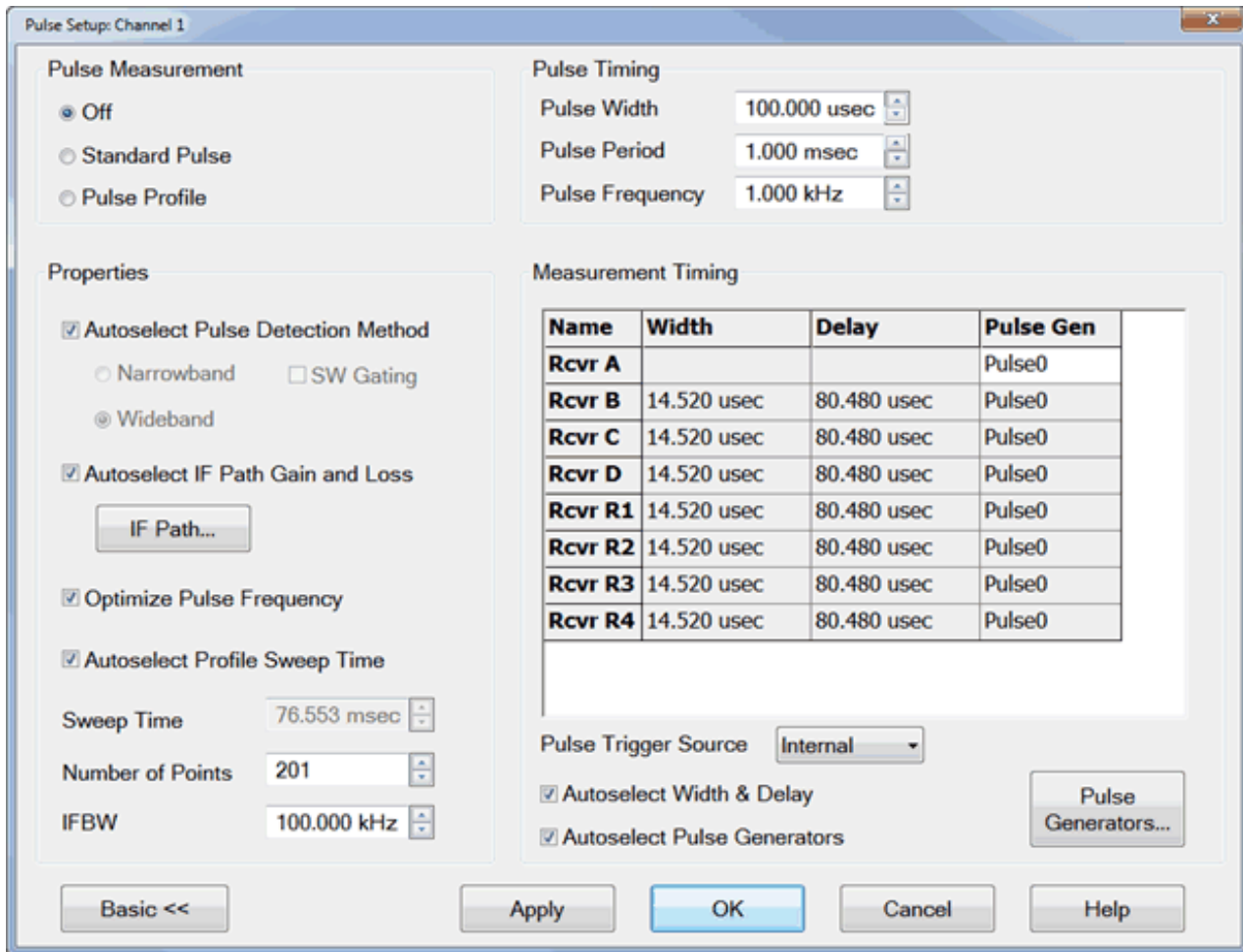

Note: The M937xA does not support this function.

The Basic controls allow simple pulse measurements using the default (Autoselect) settings in the Advanced section of the dialog.

Several VNA measurement settings are controlled by the Pulse setup, such as sweep type, number of points, and so forth.

Pulse Measurement

Off - Source and Receivers are NOT pulsed

Standard Pulse - With pulsed RF, the VNA can be configured to sweep in frequency, power sweep, and CW time.

- To make 'Point-in-Pulse' measurements, narrow the receiver pulse width and enter delay.

- To make 'Pulse-to-Pulse' measurements, select **Stimulus**, then **Sweep**, then **Sweep type = CW** in the VNA menu.

Pulse Profile - Pulse profile measurements provides a time domain (CW frequency) view of the pulse envelope. Profiling is performed using a measurement technique that "walks" a narrow receiver "snapshot" across the width of the pulse. This is analogous to using a camera to take many small snapshots of a wide image, then piecing them together to form a single, panoramic view.

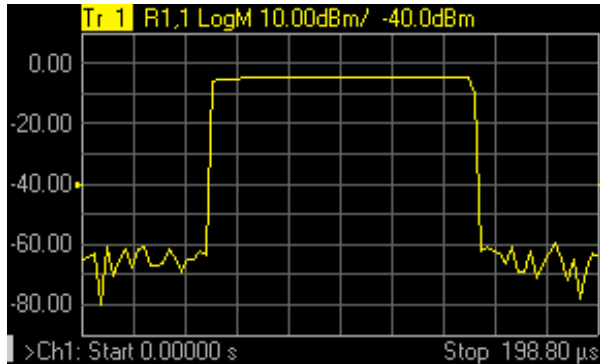

Pulse Profile measurement using default settings and R1 receiver.

- Pulse Profiling can be performed using ratioed or unratioed measurements. You can preview the pulse on port 1 by using an R1 receiver measurement.
- Pulse Profiling is performed at a single CW frequency in Wideband mode.
- To select the CW Frequency, click **Stimulus**, then **Sweep Type**.
- In **Wideband** mode, the receiver is walked across the pulse by making a sequence of closely-spaced measurements in real-time.

Pulse Timing

Pulse Width - Sets the width of the source pulse. See [measurement timing](#) to learn how to control the receiver width and delay.

Pulse Period The time to make one complete pulse.

Pulse Frequency (PRF) The reciprocal of Period ($1/\text{Period}$). See [Internal Pulse Generators](#) to learn more.

By default, these settings configure Pulse Gen 1 to drive Source Modulators 1 and 2. This can be changed from the Advanced Settings [Pulse Generator Setup](#) dialog.

----- **Advanced Settings** -----

The following settings allow maximum control of a Pulse measurement.

Properties

Autoselect pulse detection method - This function is not available. Only Wide band is available in M9485A/M980xA/P50xxA/E5080B.

In Standard Pulse:

- **Wideband** - used when the (source) Pulse Width is WIDER than the fastest receiver acquisition time. This allows the receiver to measure all pulse ON time - no pulse OFF time. The VNA will select Wideband whenever possible.

In Pulse Profile:

- **Wideband** - used when the (source) Pulse Width is greater than 1.600 us. This allows the receiver make several sequential measurements to measure the entire pulse.

Autoselect IF Path Gain and Loss - For future use.

Optimize Pulse Frequency - Automatically selects the Pulse Frequency and Pulse Period. (This function is not available)

Autoselect Profile Sweep Time - In Pulse Profile mode, adjusts the default X-axis start time to zero and the stop time double the Pulse Width. This allows you to see one complete pulse. If unchecked, the Sweep Time will not be changed.

To adjust the X-axis manually, click OK to close the dialog. Then press [Sweep](#) > [Main](#), then change the [Start Time](#) and [Stop Time](#).

Sweep Time - Sets the time the analyzer takes to complete one sweep.

Number of Points - Sets the number of data points for the measurement.

IFBW - Select the IFBW for the measurement.

- In Wideband, this setting determines the receiver acquisition time - approximately 1/ IFBW.

Measurement Timing

Source1 - Used as RF Source Modulation Drive.

- **Width** - source pulse width.

- **Delay** - source pulse delay relative to the pulse generator clock.
- **Pulse Gen** - Pulse generator used to modulate the source. Select **CW** to have NO source modulation.

Pulse Trigger Source Choose from:

- **Internal** - Default setting. The pulse generator is triggered by an internal pulse clock.
- **External** - External pulse input from PULSE SYNC IN is used for pulse trigger.
- **<External Pulse Gen name>** - Available when a 81110A is **configured as an External Device** and **Master Mode** is checked on the **pulse generator properties dialog**. See how to make this setting using **SCPI**.

Autoselect Width and Delay - When checked, for Wideband mode and Pulse Gen = Pulse Trigger, the default setting for the receiver is adjusted to approximately 75% of the source pulse width, with 20% delay. This leaves approximately 5% of the source pulse ON after acquisition is complete.

Autoselect Pulse Generators - When checked:

- Pulse1 is selected for Modulator Drive.

Pulse Generators... Click to launch the **Pulse Generators Setup** dialog.

Pulse Generators Setup dialog box help

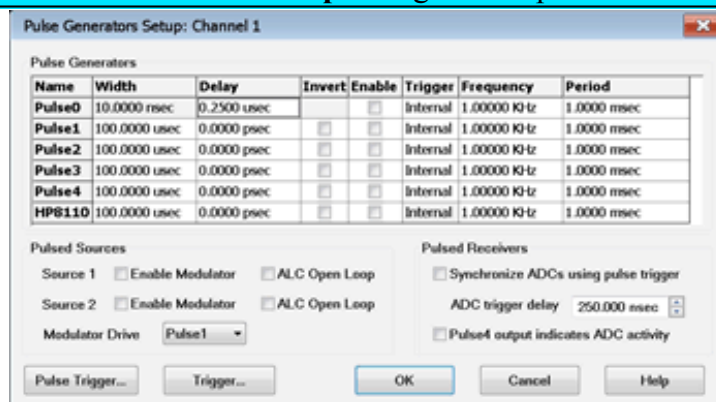

This dialog is available with Option S9x025A/B (pulse generators).

To see this dialog, press **Pulse Generators...** on the [Pulse Setup dialog](#).

Pulse Generators

Configure the Pulse Generators to be used for your measurement. The pulse 0 is for the receiver. The pulse 1 is for source and P1 output and pulse 2 to 4 are for P2 to P4 output signal, receptively.

When configured, external pulse generators appear in this list. [Learn more](#).

Delay defines the delay between the pulse clock and when the receiver begins to make a measurement. [Learn more](#).

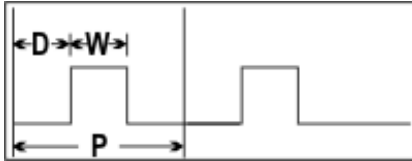

- **D** = Delay; the time before each pulse begins
- **W** = Width; the time the pulse is ON
- Duty Cycle = W/P
- **P** = Period; one complete pulse cycle
- Pulse Frequency (PRF) = $1 / \text{Period}$

Important: If **D + W** is greater than **P**, then undefined VNA behavior results. There is NO error message or warning. **$P - (D + W) > 120 \text{ ns}$** should be satisfied (M9485A)

Invert Check to cause the pulse ON time to be active low and OFF be active high.

Enable Check to enable individual pulse generators.

Trigger Choose from: (When ONE of these is changed, they ALL change. The internal Pulse Generators can NOT be triggered individually).

- Internal - Pulse generators are triggered by the internal pulse clock.
- External - Pulse generators are triggered by an external pulse generator.

Frequency - Set the pulse frequency of each generator.

- Pulse Frequency (PRF) = $1 / \text{Period}$

- **P** = Period; one complete pulse cycle

Period - Set the period of each generator.

Learn more about the Pulse Generators.

Pulsed Sources

Check to enable internal source modulators. (Only source 1 is available)

Important: When internally modulating the sources, **source leveling is automatically set to Open-loop (ALC Open Loop** box will be checked automatically).

Modulator Drive - Choose the pulse generator to modulate the specified source. Choose from **CW** (NO pulse), Pulse 1, 2, 3, 4, External.

Offset Pulses

Offset Pulses using ADC Delay Check Box

- If checked (default), adds delays to the Pulse Generator:
 - Pulse0 adds (ADC Delay) + (Modulator Delay).
 - Pulse Output used as the Modulator Drive adds no delay.
 - All other Pulse Outputs add Modulator Delay.
- RF Modulator Delay
 - Defines the RF delay of the source modulator. This is the time lag between the pulse drive signal and the actual RF output. This may indicate the lag for either an internal or external source.
 - The default is 40 ns, which is the average delay of the internal RF modulators. The internal modulator below 3.2 GHz is slower than the internal modulator above 3.2 GHz. Therefore, the average value is chosen.
- ADC Delay
 - The ADC starts on the rising edge of Pulse0. Due to the data pipeline, the ADC begins measuring data 210 ns before the rising edge of Pulse0 occurred. Since the ADC measurement leads Pulse0, Pulse0 is delayed by this amount of time. This value cannot be

changed.

Offset Pulse Example

Assume Pulse1 is used to modulate the RF signal, all Pulse outputs are enabled, all are set to zero delay, and all are set to the same width. The first timing diagram below is with offsets off and the second timing diagram is with offsets on.

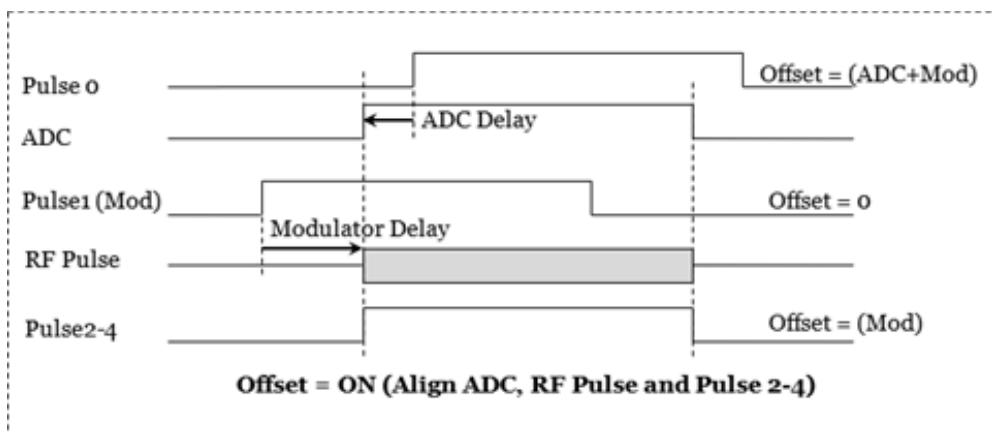
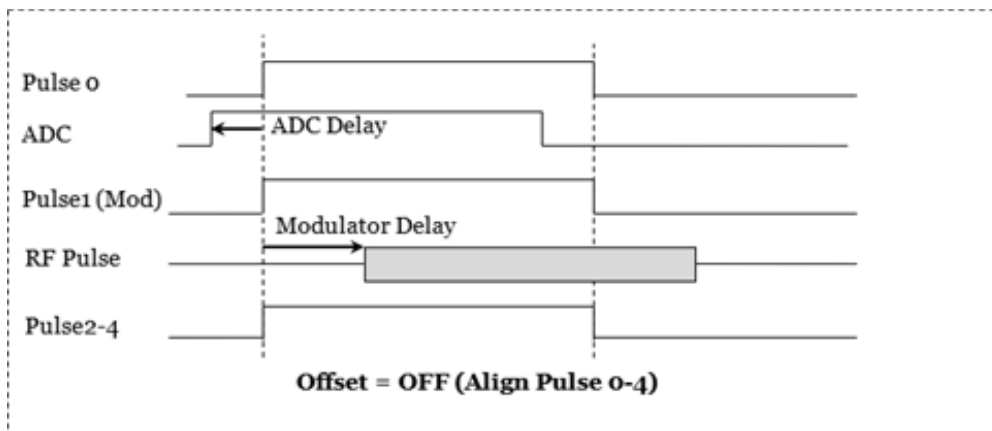

Pulsed Receivers

Synchronize ADCs using Pulse Trigger - Check to enable triggering used to gate the ADC for wideband receiver measurements. This is the same as **Pulse0 Enable**. The Width can NOT be configured.

Pulse4 Output Indicates ADC Activity - Check to use an oscilloscope connected to the pulse 4 to display when the ADC is making measurements.

Pulse Trigger.. - Click to start the [Pulse Trigger dialog](#).

Trigger... - Accesses the Trigger dialog for setting up triggering. [Learn more](#).

Pulse Trigger Tab - Trigger dialog box help

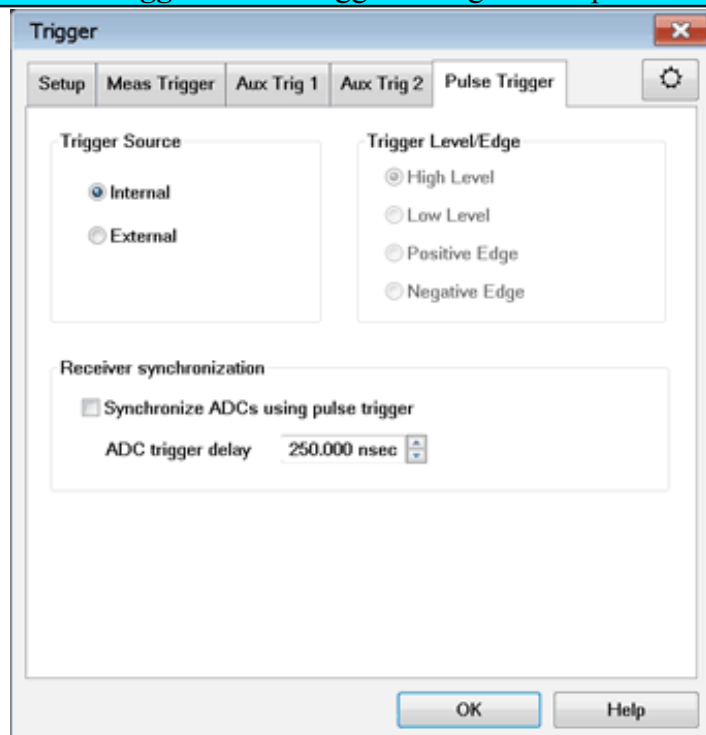

To see this dialog, press **Pulse Trigger** on the [Pulse Generator Setup dialog](#) or select **Stimulus**, then **Trigger** from the VNA Menu.

Trigger Source

Select **Internal** or **External** to provide sync capability for the internal pulse generators.

- **Internal** - The pulse generator is internally triggered and puts out a periodic pulse train with a period defined by the [Pulse Generator Setup dialog](#).
- **External** - The internal pulse generator puts out one set of pulses (P0-P4) per external trigger. All five pulse outputs have unique delay and pulse width settings.

(M9485A) The PULSE SYNC IN pin provides a configurable trigger signal into the Pulse

Generators. Only one set of pulses is emitted when edge triggering is used. The length of time that it takes to emit one set of pulses is the end time of the last enabled pulse (largest of width + delay of all the pulses P0-P4).

Trigger Level/Edge

Sets the edge of the trigger signal to which the internal pulse generators will respond when being externally triggered at the PulseSyncIn pin. The level selection is not available.

Positive = rising edge; Negative = falling edge.

Receiver synchronization

Synchronize ADCs using pulse trigger - Check to enable triggering used to gate the ADC for wideband receiver measurements. The Width can NOT be configured.

ADC trigger delay - Set the amount of time to wait before triggering the ADC to begin acquisition.

Using External Pulse Generators

Setup the External Pulse Generator as an External Device.

Calibration in Pulse Mode

To perform a calibration in pulse mode, first configure and apply the pulse parameters (PRF, Pulse Width, Delays, IF gating, and so forth) **before** calibrating the system. This will ensure the VNA is configured properly during the calibration and measurement.

Noise Figure Application

Note: The M937xA/P937xA does not support this function.

Note: (M9808A, P5008A, P5028A) Noise Figure can be measured at 45 GHz and below.

The Noise Figure Application makes fast, easy, and accurate noise figure measurements. This function is available with Opt 028, S9x029A/B, or S93027B.

The information presented in this topic pertains to Noise Figure measurements on BOTH Amplifiers and Converters unless stated otherwise.

- Noise Figure Hardware and Software Options Explained (028, S9x029A/B)
- Features, Requirements, and Limitations
- Noise Concepts
- How the Noise Figure Application Works
- M9485A External Switch Setup
- M980xA/P50xxA External Switch Setup
- Noise Parameters that are Offered
- Using Noise Figure App
 - Connect Tuner and Noise Source
 - Create a Noise Figure Measurement
 - Make Noise Figure Settings
 - Perform Calibration (separate topic)
 - Save Noise Data
- Noise Figure Measurement Tips
- Using Noise Figure Traces in Equation Editor
- Noise Model and the Noise Correlation Matrix

See Also

Noise Figure Calibration

Programming commands

Noise Figure and TRL Cal

See other VNA Applications

Noise Figure Hardware and Software Options Explained

- **S9x029A/B** - Noise figure measurement application.
- **M9485A-028** - Noise figure measurement application. A Noise tuner and noise figure measurement of frequency translating devices are not supported.

Noise Figure Application Features

- Cold noise method includes correction for imperfect system source match for highly accurate noise figure measurements.
- During calibration, ENR values are interpolated for frequencies between the supplied data points.

Noise Figure Application Requirements

- Noise Tuner - Required for vector noise figure measurements. Not required for scalar noise figure .
 - ONLY the N4690 Series ECal modules are supported. The N4691B m-f is recommended.
- Recommended: An accurate thermometer. [Learn more](#) .

Noise Source

When using a Noise Source, the following requirements apply:

- The 346C Noise Source (recommended) produces ENR values to 26.5 GHz.
- The 346B Noise Source can be used up to 18 GHz.
- The 346A Noise Source can also be used up to 18 GHz, but requires more averaging for calibration.
- The 346C K01 (50 GHz) Noise Source typically has about 6 dB of ENR at 50 GHz which may NOT yield an adequate calibration, depending on how many noise averages are used. An alternative approach calibrates the noise receivers using a power sensor-based method. Select **Use Power Meter** for the noise figure calibration. .
- An adapter may be necessary to connect the Noise Source to the VNA port 2 reference plane during calibration . Cal Kit (or second ECal module) with same connector type and gender as DUT connectors.

Limitations with the Noise Figure Application

The following features are NOT supported in a noise figure channel:

- FCA or Frequency Offset
- Analog sweep . All frequency sweeps are STEPPED.
- Independent IFBW, Power Levels, or Sweep Time in a segment table is NOT supported.
- Receiver calibration .
- Enhanced Response Cal
- ECal User Characterization .
- Some Fixturing Features
- Auto Port Extensions
- Auto Formatted Citifile data.
- External DC Devices
- Pulsed noise figure measurements are supported with the following limitations:

- Minimum 300 microsecond pulse width using 24 MHz noise bandwidth
- Narrower noise bandwidths cause larger minimum pulse widths
- A drop-out may occur at start of sweep and at 3 GHz. This is corrected by a 1 ms pulse width at 24 MHz Noise BW.

Noise Concepts

The following conceptual information is a short summary taken from the Keysight Noise Figure App Note 57-1 .

All electronic circuits have some degree of random noise. The most common form is thermal noise, which increases as the temperature of the circuit increases.

The signal-to-noise (S/N) ratio of components in a communications system is a very important parameter. To improve the S/N ratio, it is usually easier and more cost-effective to reduce noise than to increase signal power. In order to reduce noise, an accurate method to measure noise is required.

Noise Figure

Noise Figure is the degradation in the signal-to-noise ratio as a signal passes through a device. For example, in the following images:

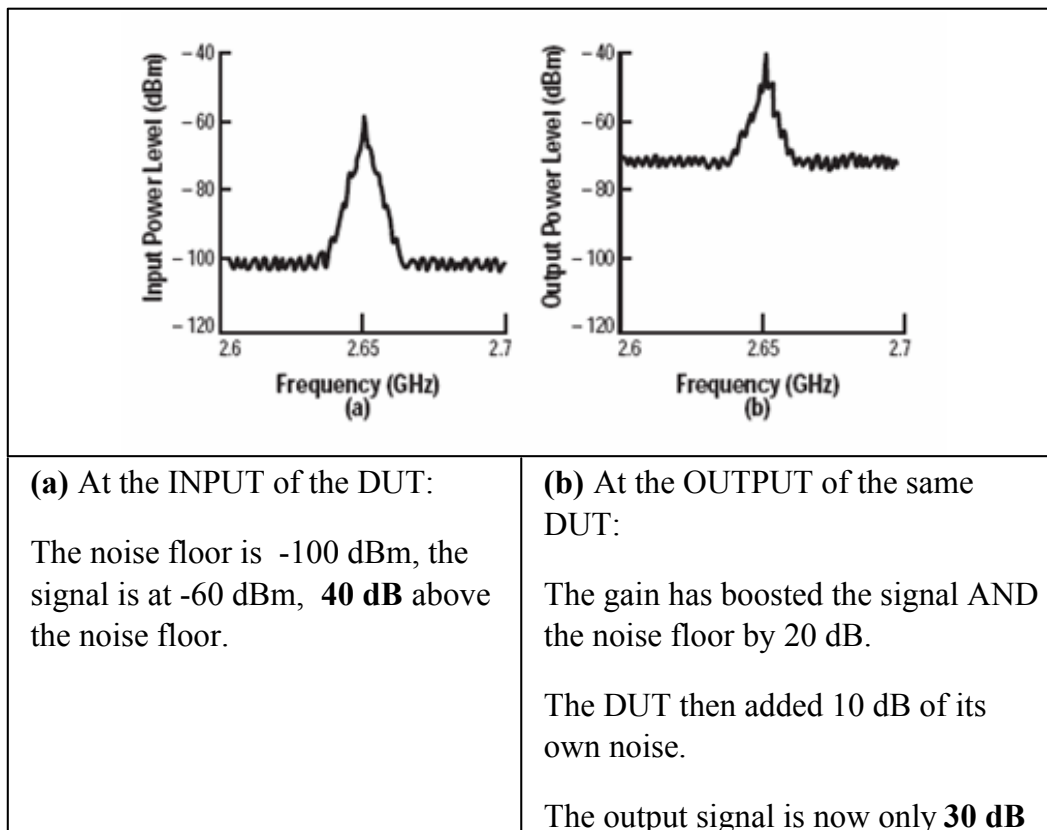

above the noise floor.

Since the degradation in signal-to-noise ratio is 10 dB, the DUT has a **10 dB noise figure**.

For consistency, noise measurements are calculated as if using a 1 Hz bandwidth, although measurements are almost always made at higher bandwidths.

The following formula shows the lowest possible noise power in dBm at 290°° K (room temperature). The only way to measure noise lower than this is to make the measurement at a lower temperature.

- $P = 10\text{LOG}(4.0 \times 10^{-21} \text{ watts}/.001 \text{ watt})$
- $P = -174 \text{ dBm} / \text{Hz}$

How the Noise Figure Application Works

The goal of the noise figure application is to accurately measure the noise that is generated by the DUT.

The standard receivers are always calibrated using a power meter and a measurement of the receivers effective noise bandwidth. [Learn more about the noise calibration process](#).

Some noise measurement error is caused by a poor source match presented to the DUT input. Therefore, during every measurement, the noise figure application uses an ECal module to present at least four different impedances at the input of the DUT. This "Noise Tuner" is connected to the VNA port 1. From the measurements at various impedance states, the VNA calculates the noise out of the DUT as though the VNA were exactly 50 ohms. No assumptions are made regarding the input impedance of the DUT.

Here is how a vector noise figure measurement is made using Option 029. The sweep numbers are annotated on the VNA display as they occur.

1. With the noise tuner in the THRU state, S-parameter measurements are made to accurately characterize the gain of the DUT. This requires sweeps in both forward and reverse directions. (sweep #1 and #2).
2. The noise measurements are performed next. VNA source power is turned OFF and the noise tuner is switched to the first impedance state.
3. At each frequency, the noise receiver samples a large number of readings in order to attain **one** valid measurement. If Noise Averaging is selected, the specified number of measurements are made and averaged together to obtain one noise measurement. This continues for all frequencies (sweep #3).

4. The next noise tuner impedance state is switched IN and the noise measurements in step 3 are repeated. This occurs until measurements are made at all impedance states. At least four impedance states must be used. (sweeps #4, #5, #6+)
5. Calibration error terms are applied and calculations made to simulate the measurement with a perfect 50 ohm input impedance. The sweep result is plotted on the VNA display.
6. The VNA begins sweeping again with step 1.

Scalar Noise Figure Measurements

Note: M9485A does not support the noise tuner.

As described above, the noise tuner is switched to at least four different impedance states before a sweep is plotted. These sweeps are NOT made in a scalar noise figure measurement, resulting in much faster measurements. Of course, a scalar noise figure measurement is NOT as accurate as a vector noise figure measurement because scalar noise figure measurements assumes that all impedances are 50 ohms. Measurement accuracy can be improved by adding an attenuator as close to the DUT input as possible. This improves the effective system source match. The effect of the attenuator loss is removed during the calibration process.

With scalar noise figure, it is not necessary to connect the noise tuner. If a noise tuner remains connected, it is switched to the THRU state for scalar noise figure measurements. This results in a small amount of loss which slightly degrades measurement accuracy. To increase measurement accuracy, manually switch the noise tuner switch to the INTERNAL position. Learn how.

Select **Scalar Noise** at the first page of a Noise Figure calibration .

M9485A External Switch Setup

When you make a Noise Figure measurement with the M9485A, the external source switch is required to avoid inputting the noise into DUT from the source signal.

Case 1: Use External Source and Amp & Switch Module

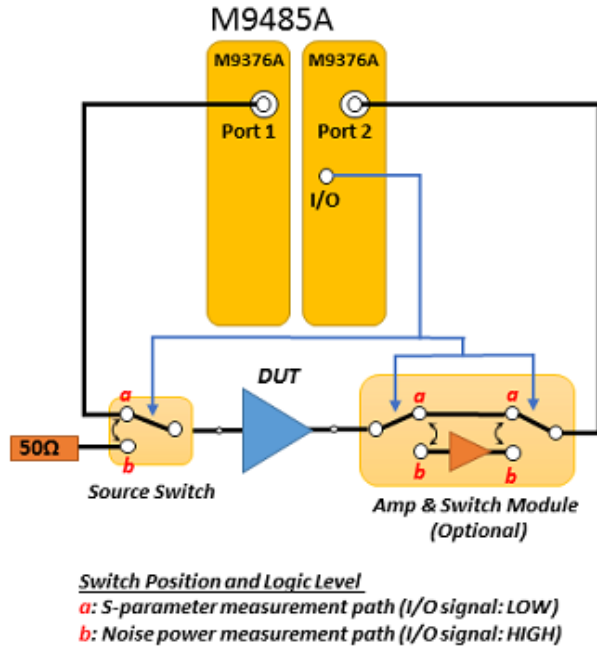

Case 2: Use M9379A and M9161D

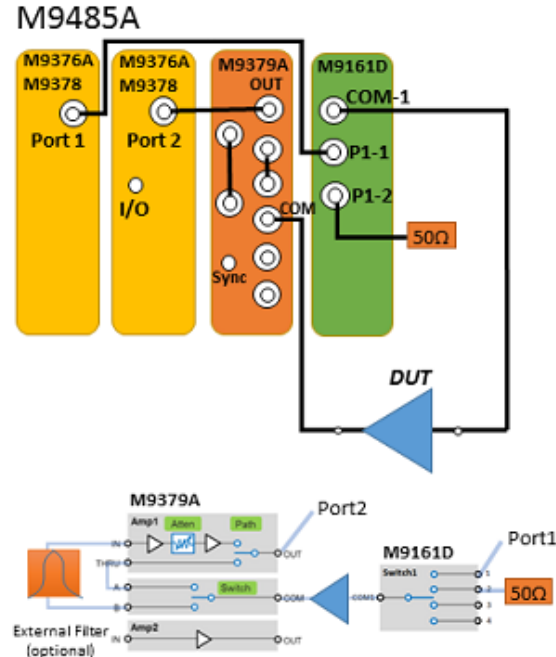

Case 1

The external source switch is controlled by I/O output signal . So that, the path a should be selected during S-parameter measurement and The path b is selected during noise power measurement. Amp & Switch module can be used in order to improve the noise figure measurement sensitivity

Recommended Noise Source and Pre-Amplifier Gain

Receiver configuration	Input noise power at receiver input port (*1)	External preamp gain (*2)	
		For noise source calibration (*3)	For power meter calibration
M9376A	<-1 dBm	30 dB to 50 dB	< 25 dB
M9377A & M9378A/B (Standard configuration)	<-5 dBm	25 dB to 45 dB	< 20 dB
M9377A & M9378A/B (Wide dynamic range configuration)	< -21 dBm	10 dB to 30 dB	< 5 dB

(*1) For example, DUT(gain =20dB, NF= 5dB) with 25dB gain external preamp will output -24 dBm noise power.

(*2) When M9379A is used as external preamp, select configuration(1-stage or 2-stage) and internal

ATT setting appropriately to avoid unexpected receiver compression during calibration and measurement.

(*3) Recommend to use 346B or 346C (nominal ENR = 15 dB).

Case 2

When you use M9379A RF Amplifier module and M9161D switch module, you can setup a Noise Figure measurement more easily. The VNA firmware can control each module automatically.

Example:

The M9161D Switch 1 is used as RF source switch. (DUT should be connected with P1-1. 50 ohm termination should be connected with P1-2.)

The M9379A Out is connected with port N (N=2, 3, ...)

Switch Module Control Setup: **Switch 1 > NF Source**

RF Amplifier Module Control Setup: **PATH > NF Receiver**, **Switch > NF Receiver**, **Atten > 0 dB**
(Recommended)

M980xA/P50xxA External Switch Setup

When you make a Noise Figure measurement with the M980xA/P50xxA, the external source switch is required to avoid inputting the noise into DUT from the source signal.

Scalar Noise Figure Setup

Case 1: Use External Source and Amp & Switch Module

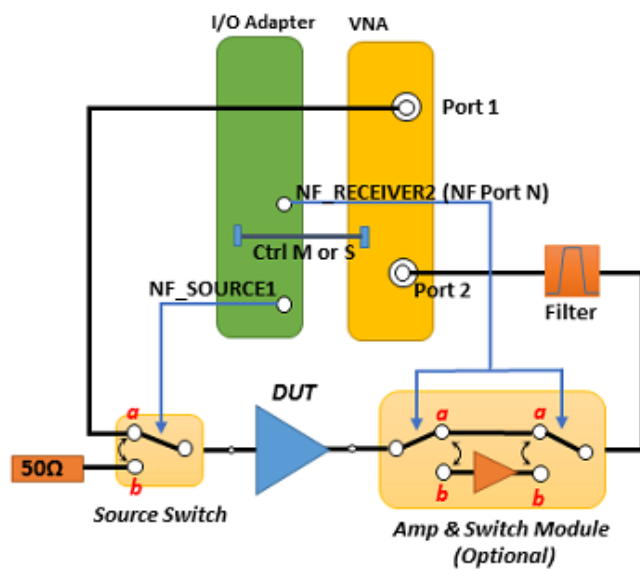

Switch Position and Logic Level

- a:** S-parameter measurement path (I/O signal: LOW)
- b:** Noise power measurement path (I/O signal: HIGH)

Case 2: Use M9379A and M9161D

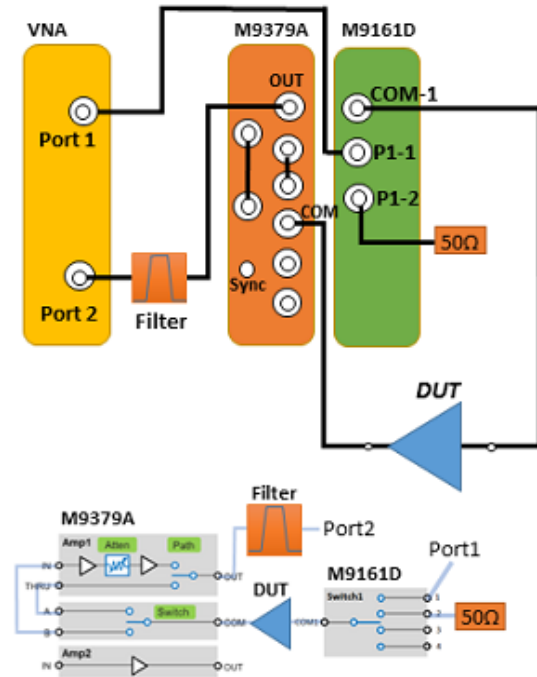

Vector Noise Figure Setup

The Noise Tuner is required for vector noise figure measurements. See Noise Tuner requirements

Case 1: Use External Source and Amp & Switch Module

Case 2: Use M9379A

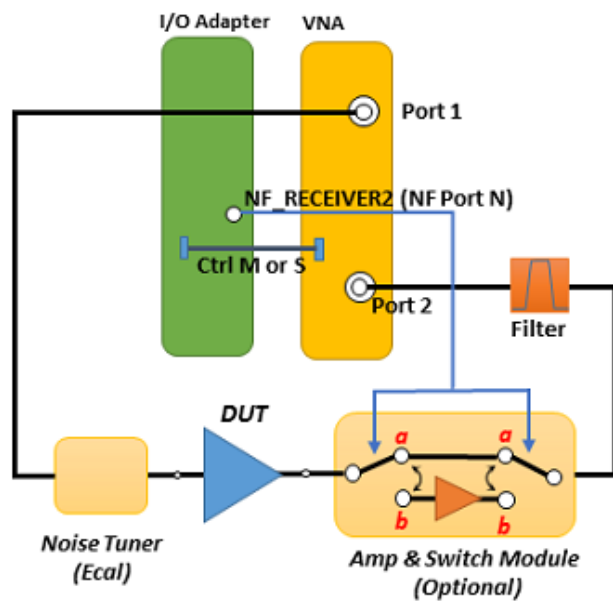

Switch Position and Logic Level

- a:** S-parameter measurement path (I/O signal: LOW)
- b:** Noise power measurement path (I/O signal: HIGH)

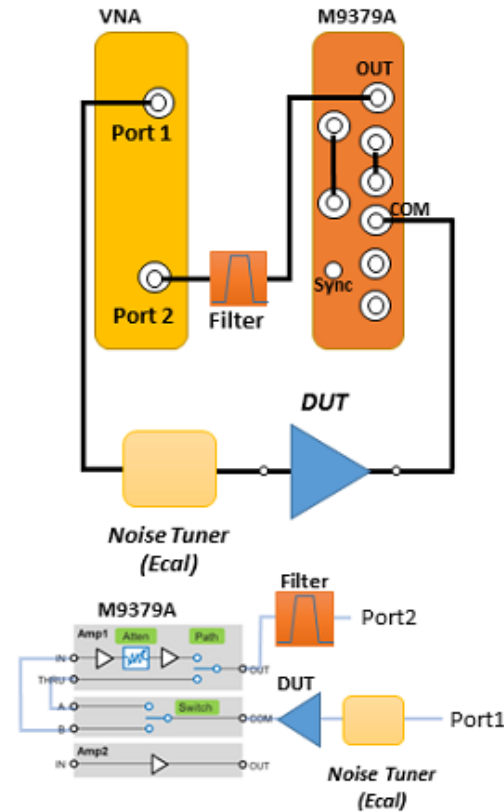

Harmonic Mixing Rejection Filter

It is recommended to place filters at the receiver port. The required characteristic is shown below. Both high and low pass filters are required above 20 GHz.

Measurement Frequency	High pass filter	Low pass filter
50 MHz frequency 20 GHz	Not required	Passband < 2.7 × frequency
20 GHz < frequency 45 GHz	Passband > 0.7 × frequency	Passband < 1.2 × frequency

If the filter is not placed, the noise at the harmonic frequencies may be added up on the measurement result and causes the inaccurate result.

Case 1

The external source switch is controlled by I/O Adapter . So that, the path a should be selected during S-parameter measurement and The path b is selected during noise power measurement. Amp & Switch module can be used in order to improve the noise figure measurement sensitivity

Recommended Noise Source and Pre-Amplifier Gain

Input noise power at receiver input port (*1)	External preamp gain (*2)	
	For noise source calibration (*3)	For power meter calibration
<-23 dBm	15 dB to 28 dB	< 16 dB

(*1) For example, DUT(gain =20 dB, NF= 5 dB, Frequency span=10 GHz) with 25 dB gain external preamp will output -24 dBm noise power.

(*2) When M9379A is used as external preamp, select configuration(1-stage or 2-stage) and internal ATT setting appropriately to avoid unexpected receiver compression during calibration and measurement.

(*3) Recommend to use 346B or 346C (nominal ENR = 15 dB).

Case 2

When you use M9379A RF Amplifier module (13.5 GHz), you can setup a Noise Figure measurement more easily. The VNA firmware can control each module automatically.

Example:

The M9379A Out is connected with port N (N=2, 3, ...)

RF Amplifier Module Control Setup: **PATH > NF Receiver** , **Switch > NF Receiver**, **Atten > 0 dB**
(Recommended)

Using the Noise Figure Application

Use the following general procedure to make noise figure measurements:

1. Connect Tuner and Noise Source .
2. Create a Noise Figure Measurement .
3. Make Noise Figure Settings .
4. copy your Noise Source ENR file to the VNA "C:/Program Files/Keysight/Network Analyzer/Noise folder"
5. Perform Calibration
6. Connect the DUT. Learn more about DUT input and output ports.

7. Measure Noise Figure.
8. **Optional** Click **File** , then **Save** to save noise figure data. Learn more .

Connect Noise Tuner and Noise Source

- Connect the noise source and DC source.



Configure the DC source using Configure a DC Device .

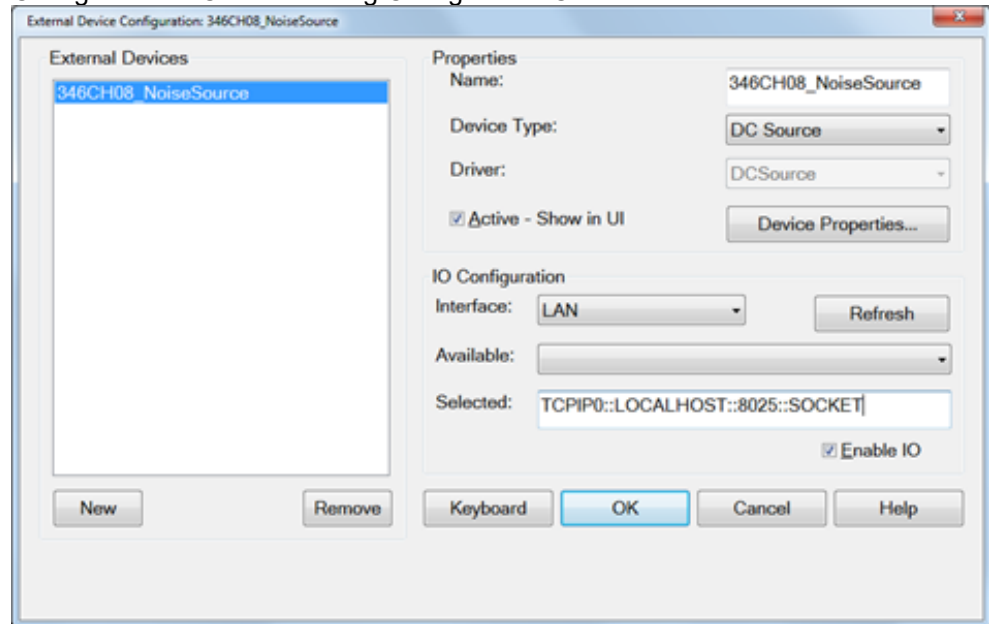

Click **Device Properties** to set up waiting time and commands as required. Set "Timeout" and "Dwell Before Sweep". VNA doesn't use other settings for noise source control.

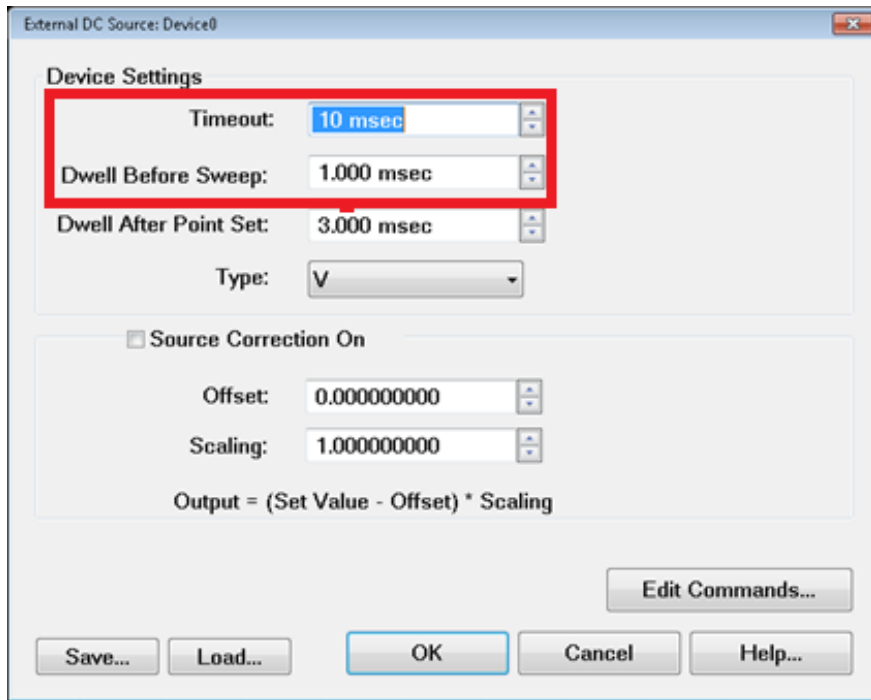

- When 346CH08 is used, Click **Load** and select 346CH08.xml file .
Click **Edit Commands** to input commands for setting the noise source on into “Before sweep” and “After sweep”. Other settings are ignored for noise source control.

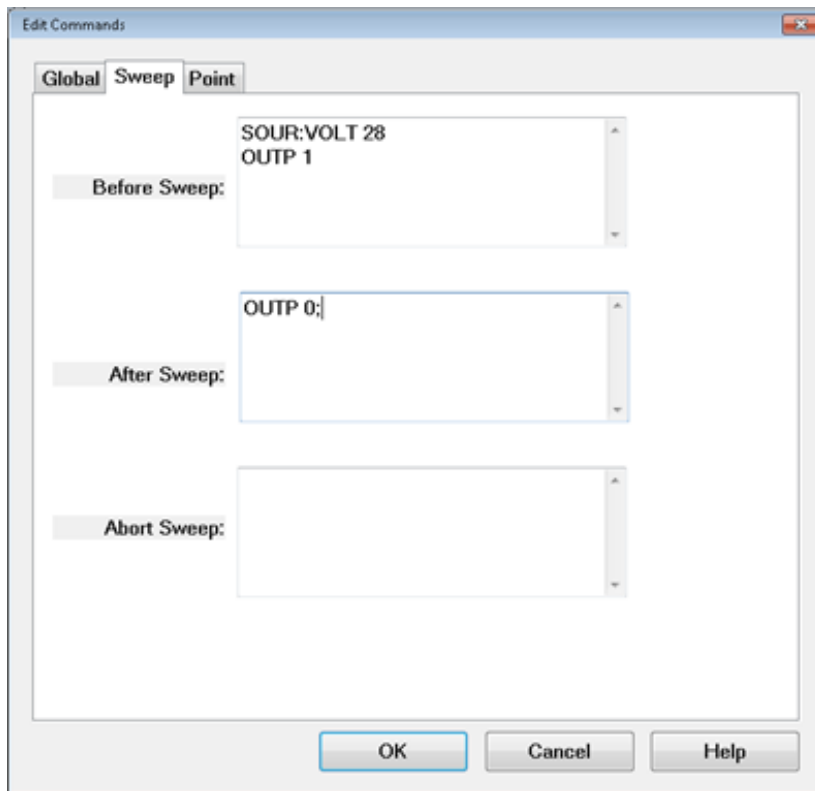

- Connect the **noise tuner** (ECal module). See Noise Tuner requirements . See M980xA/P50xxA Noise Figure Setup . (M9485A does not support this function)

Create a Noise Figure Measurement

1. On the VNA front panel, press **Meas** > **S-Param** > **Meas Class...** .
2. Select **Noise Figure Cold Source**, then either:
 - **OK** delete the existing measurement, or
 - **New Channel** to create the measurement in a new channel.
3. A noise figure measurement is displayed. The following shows how to select or change displayed parameters.

Noise Parameters

Several noise parameters, as well as standard parameters, can be measured in the same Noise channel.

How to add Noise Parameters

1. Create a Noise Figure channel.
2. Then do the following:

Using **Hardkey** /**SoftTab** /**Softkey**

1. Press **Trace** > **Trace N** > **Trace N** .
2. Press **Trace** > **Trace Setup** > **Measure...** .

Using a mouse

1. Click **Instrument**
2. Select **Trace**
3. Select **Add Trace**
4. Click **Instrument**
5. Select **Trace**
6. Select **Measure...**

How to CHANGE Noise Parameters

1. Create a Noise Figure channel.

2. Select the parameter to change.

3. Then do the following:

1. Select a trace by pressing **Trace** > **Trace N** > **Trace N** .

2. Press **Trace** > **Trace Setup** > **Measure...** .

3. Select a parameter.

1. Right-click on a trace.

2. Select a parameter

Programming Commands

Noise Measurements that are offered

The following three categories of noise measurements can be made with the VNA:

1. **Noise Figure** is the amount of noise that the DUT is adding in a 50 ohm test setup. This is explained in detail in Noise Concepts .
2. Noise Power Parameters show the amount of noise coming out of the DUT in a 50 ohm test setup. With gain measurements of the DUT, these noise power parameters are used to calculate noise figure.
3. Noise Parameters are models of the noise that is generated in a DUT, similar to how S-parameters model how RF flows through a DUT.

-
- **Noise Figure (NF)** - Explained in Noise concepts .
 - **Excess Noise Ratio** - Select when measuring the noise source. Compare with the ENR table to validate accuracy of the system. ENR is calculated as:

$$\text{ENR (in dB)} = 10 \log_{10}((T_{\text{hot}} T_{\text{cold}}) / T_0), \text{ where } T_0 = 290\text{K}.$$

Learn more about the ENR table and Noise Source. Learn more about Noise Source ENR measurements.

- **T-Effective** - The effective temperature, in Kelvin, of the measured noise level. For example:

$$290^{\circ}\text{K} = -174 \text{ dBm/Hz}.$$

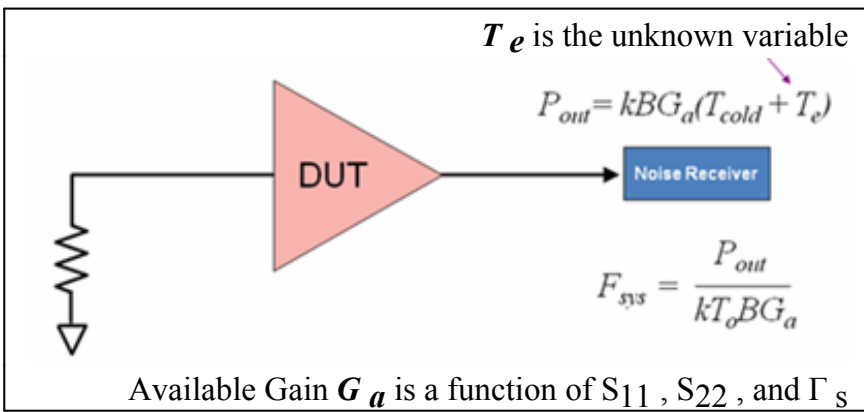

Noise Power Parameters

The Noise Power parameters below are offered in the following two formats:

- **Available Noise Power** The calculated power that is based on an ideal impedance match at the output of the DUT. These parameters have always been offered in the VNA noise figure App.
 - **Incident Noise Power** - An 'I' is appended to the end of the Available Noise Power parameter. The calculated power into a perfect 50 ohm noise receiver, regardless of the output impedance of the DUT.
-
- **SYSNPD / SYSNPDI** - System Noise Power Density: Total noise power available at the ADC, including the noise contributed by both the DUT and the internal noise receiver. This is generally expressed as an absolute power measurement in dBm, but can also be expressed in Watts or Kelvin.

$$\text{dBm} = 10 \log_{10} (k * T * B * 1000)$$

where:

k = Boltzmann's constant

T = the measured noise temperature

B = bandwidth

1000 = conversion from milliwatts

- **SYSRNP / SYSRNPI** - System Relative Noise Power: The noise temperature of the combined DUT and receiver relative to 290 Kelvin. This is generally reported as a ratio in dB. Therefore a perfectly quiet device would render a trace at 0 dB.

$$\text{dB} = 10 \log_{10} (T/290)$$

- **DUTNPD / DUTNPDI** - DUT Noise Power Density: When correction is ON, this trace exhibits the available noise power, best described as the maximum power available from the DUT where the impedance of the

noise port is equal to the output match of the DUT. To be more precise, this occurs when the noise port match is equal to the conjugate of the output match of the DUT. The noise power contributed by the receiver is removed.

When correction is OFF, the trace exhibits what is more accurately described as delivered power. Delivered power is the power actually seen by the ADC. Any mismatch between the receiver and the DUT is ignored. The noise power contributed by the receiver is removed.

This measurement is generally expressed in dBm, normalized to a 1 Hz bandwidth. For convenience, marker and trace readout shows **dBm**.

You could display the power in a different bandwidth using Equation Editor.

$$\text{dBm/Hz} = 10 \log_{10} \left(\frac{(\text{DUT Temperature} - \text{Receiver Temperature}) * B * 1000}{1000} \right)$$

where:

B = bandwidth

1000 = conversion from milliwatts

- **DUTRNP / DUTRNPI** - DUT Relative Noise Power: This measurement is rendered as a ratio of the DUT temperature to 290 Kelvin. It is generally expressed in dB. The same comments apply with respect to available versus delivered power as described above for DUTNPD.

$$\text{dB} = 10 \log_{10} (\text{DUT Temperature} - \text{Receiver Temperature})$$

Noise Model, Noise Parameters, and the Noise Correlation Matrix

Noise Parameters are models of the noise that is generated in a DUT, similar to how S-parameters model how RF flows through a DUT.

Noise Model

The noise wave model of any linear 2-port network may be represented by the following image:

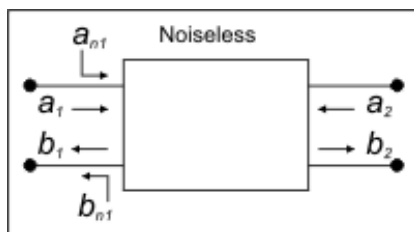

This shows a noiseless 2-port network with noise waves (a_{n1} and b_{n1}) added to the input terminals. The a_1 , a_2 and b_1 , b_2 are standard S-parameter waves.

The noise correlation matrix relates to the noise waves as follows:

$$C_i = \begin{bmatrix} \overline{|a_{n1}|^2} & \overline{a_{n1} b_{n1}^*} \\ \overline{b_{n1} a_{n1}^*} & \overline{|b_{n1}|^2} \end{bmatrix} = \begin{bmatrix} C_{11} & C_{12} \\ C_{21} & C_{22} \end{bmatrix}$$

Where:

- $\overline{|a_{n1}|^2}$ and $\overline{|b_{n1}|^2}$ are time-averaged noise power in 1 Hz bandwidth.
- $\overline{a_{n1} b_{n1}^*}$ and $\overline{b_{n1} a_{n1}^*}$ are time-averaged cross correlation terms, correlation of a_{n1} to b_{n1} .
- Overbars represent time-averaging
- Star superscripts represent complex conjugation

Noise Parameters

- **Gamma Opt** (Optimum Complex Reflection Coefficient) - The optimal impedance for the noise figure measurement. Select the data format to display GammaOpt in terms of Log Mag, Lin Mag, Phase, Unwrapped Phase, Real, Imaginary, Polar, or on a Smith Chart.
- **NF min** - The minimum noise figure that occurs at GammaOpt . NFmin is a scalar quantity that can be displayed as Log Mag, Lin Mag, or Real.
- **R n** (Noise Resistance) - Specifies the rate of change of the level of noise when varying the source impedance. Rn is a scalar quantity in units of ohms that should be displayed in Lin Mag or Real format.
- **NCorr_11, NCorr_21, NCorr_12, NCorr_22** - The NCorr_11 and NCorr_22 terms are effective noise temperature, normalized to 290 K. Both terms are time-averaged, noise-wave powers referred to the input of the DUT, where NCorr_11 is the forward wave (noise going through the device towards the output), and NCorr_22 is the reverse noise wave (noise coming out of port 1 of the DUT, going back towards the source).
 - To convert to available noise power, multiply the terms by 290*k*B where:
 - k = Boltzmanns constant
 - B = system bandwidth

Standard Parameters that are offered (Amplifiers-only)

- **S-parameters** : S11, S21, S22, S12
- **Unratioed parameters** using the following notation: (Receiver, source port). These parameters REPLACE the active measurement. To do this (from front-panel ONLY), press **MEAS** , then **[More]** , then **[Receivers]** .
 - (R1,1), (R2,2), (A,1), (A,2), (B,1), (B,2)

Save Noise Data

To save noise data, click **File** , then **Save Data As** . Then select from the following **Save As Types**:

- **(*.prn), (*.cti), (*.csv), (*.mdf)** - Noise Figure data can be saved ONLY with these choices. PRN saves only the active trace. CITI formatted, CSV Formatted, and MDF can save all displayed traces. Learn more about these formats.
- **(*.s2p)** - Saves S-parameter data only after performing a Noise calibration. This data is saved regardless of which noise measurement is active or displayed. Learn more about *.s2p data .
- **Trace and Noise parameter (*.s2p)** - Saves S-parameter data, then the Noise Parameters . This data is saved regardless of which noise measurement is active or displayed. When the vector calibration is not enabled or if the noise parameters are not realizable, then the noise parameters have no calculated value. In this instance, the following values are displayed instead:
 - **Gamma Opt = 0**
 - **NF min = 50 ohm noise figure**
 - **$R_n = Z_0 / 4 * (F - 1)$** . This equation is how R_n is currently calculated for ill-conditioned data. F is the noise factor where F is related to the noise correlation value ct_{11} and the normalized noise temperature T_n by $F = 1 + ct_{11} = 1 + T_n$ so that $R_n = (Z_0 / 4) * ct_{11}$
- **NoiseCorr (*.nco)** - Saves Noise Correlation data regardless of which noise measurement is active or displayed. The *.nco file is a noise correlation matrix expressed in T-parameter form (**Ct11, Ct21, Ct12, Ct22**) . These parameters are exactly the same as the Noise parameters **NCorr_11, NCorr_21, NCorr_12, NCorr_22** that can be displayed as traces.
- When the vector calibration is not enabled, this data is set to -200 dBm.

How to start the Noise Figure Setup dialog

Using **Hardkey** / **SoftTab** / **Softkey**

1. **Freq** > **Main** > **NF Setup...** .

Using a mouse

1. Click **Stimulus**
2. Select **NF Setup...**

Programming Commands

Noise Figure Setup dialog box help

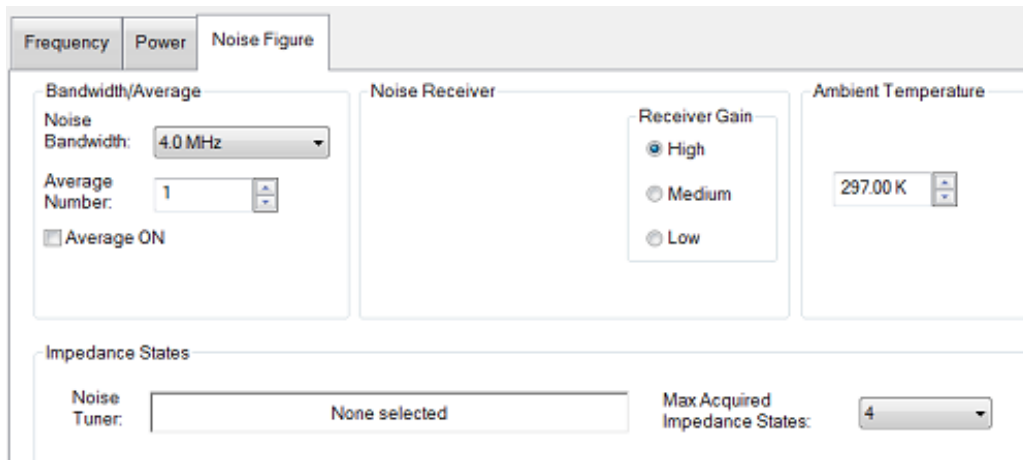

Note: In this topic, the term **Jitter** is used to describe the trace-to-trace fluctuations in a measurement. In other topics, this is called 'trace noise'.

Bandwidth/Average

The following settings work together to achieve the optimum balance of measurement accuracy versus speed:

Noise Bandwidth Increase the bandwidth to reduce the amount of trace noise on the noise power or noise figure measurement (jitter). However, a wider setting reduces the frequency resolution of the measurement. The noise bandwidth setting should always be smaller than the bandwidth of the DUT. The noise bandwidth setting is used only while measuring noise powers, and is independent from the IF bandwidth setting used to measure S-parameters. Noise figure is calculated from noise power and S-parameter measurements.

The calibration and measurement should be performed using the SAME noise bandwidth. When the noise bandwidth is changed after calibration, noise figure measurements can change by 0.5 dB or more, depending on the DUT frequency range, gain, and noise figure.

M9485A/M980xA/P50xxA Sweep Time for Noise BW (@ Noise Average = 1)

Noise BW	Sweep Time (μ)	Noise BW	Sweep Time (μ)
800 kHz	500	8 MHz	50
1 MHz	400	12 MHz	30.3
2 MHz	200	24 MHz	16.7
4 MHz	100		

Average Number Increase the number of averages to reduce jitter. This also reduces measurement speed. For maximum accuracy, use the following recommendations for the noise calibration. When using the noise receivers, 10 noise averages is recommended. When using the standard receivers, at least 100 averages are recommended.

During a measurement, the gain of the DUT helps overcome the noise of the VNA receivers, so the number of noise averages can be reduced to improve measurement speed with minimal or no degradation to measurement accuracy.

Use Narrowband Compensation

Note: This function is not supported.

Receiver Gain

Note: M9485A does not support this function.

With knowledge of your DUT gain, set the appropriate amount of receiver gain in order to optimize the power level at the noise receiver.

The following values reflect the SUM of the DUT gain (dB) **PLUS** NF (dB). For example: DUT gain = 20 dB; NF = 10 dB; SUM = 30 dB.

- Select **High** if the SUM is relatively low (<30 dB).
- Select **Medium** if the SUM is about average (20 dB to 45 dB).
- Select **Low** if the SUM is relatively high (>35 dB).

There is considerable overlap in these settings. Because all three gain settings are calibrated with each Noise Calibration, this setting can be changed after calibration to achieve the least amount of jitter without overpowering the noise receiver.

One of following messages appears when too much power is detected at the noise receiver:

- **Compression in noise receiver: excess signal** - The noise receiver is likely compressing. NF results are possibly not accurate. Select a lower gain setting.
- **Compression in noise receiver: gain has been limited** - The gain has been limited to avoid damage to the receiver. NF results are NOT accurate. Select a lower gain setting.
- **ADC over-range in noise receiver: excess signal** - Often caused by a CW signal, an oscillation, or LO feedthru during an NF measurement. Find and correct the cause, or try a lower gain setting.

Only ONE gain setting can be used for the entire frequency range of your noise measurement.

Therefore, it may be necessary to use two noise channels with different frequency ranges and gain settings to achieve the very highest noise figure accuracy.

Ambient Temperature

Note: This setting is only used for calibrated noise figure measurements, but has no effect in an uncalibrated noise figure channel. The default value is used for uncalibrated measurements.

Enter the equivalent port 1 temperature at the time of the measurement, in Kelvin (K). One can use a thermometer to measure the temperature of the input cable.

In the case of full vector correction, it is the temperature of the Ecal Tuner (31 °C or 304.15K) minus the loss effect of the cable from the tuner to the DUT; both internal and external Ecals used as tuners have the same internal heater to heat to 31 °C.

For scalar it is the temperature of the external switch attached to port 1 minus the loss of the cable, typically around 297K.

The cable loss compensation is computed from $T_{\text{ambient_setting}} = T_{\text{pna_source}} * |S_{21}|^2 + (1 - |S_{21}|^2) * T_{\text{cable}}$ where S_{21} is the loss of the port 1 cable, T_{cable} is the temperature of the cable, and $T_{\text{pna_source}}$ is the temperature of the either the Ecal used as a tuner, for full vector, or the temperature of the external switch for scalar calibration. T_{ecal} is typically 304.15K; the external switch is typically around 297K

This ambient temperature number has an inverse relationship to the noise figure. When using the effective noise temperature (T_e) format, a 3 degree increase in the ambient temperature will make the calibration measurement result drop 3 degrees, which will then have an effect on subsequent noise figure measurements. One can directly measure the port 1 equivalent temperature by connecting port 1 to port 2 with a low loss through, and measuring the mean value directly. Because the noise value is quite low, averaging or using trace statistics should be used to find this value.

Impedance States

Note: M9485A does not support this function.

Noise Tuner Displays the ECal module to be used as a noise tuner. Select the Noise Tuner during calibration on the Select Cal Method dialog.

Max Acquired Impedance States Select the number of impedance states in which to make noise measurements. At least FOUR impedance states are required. [Learn more](#) .

Frequency Tab - Noise Figure dialog box help

The screenshot shows a dialog box with three tabs: 'Frequency' (highlighted), 'Power', and 'Noise Figure'. The 'Sweep Type' section contains five radio buttons: 'Linear Sweep' (selected), 'Log Sweep', 'Power Sweep', 'CW Frequency', and 'Segment Sweep'. The 'Sweep Settings' section contains six spinners: 'Number Of Points' (201), 'IF Bandwidth' (1.000 kHz), 'Start' (10.000000 MHz), 'Stop' (26.50000000 GHz), 'Center' (13.25500000 GHz), and 'Span' (26.49000000 GHz).

These settings can also be made from the normal VNA setting locations. Click links below to learn how.

Sweep Type

Choose a sweep type. [Learn more.](#)

Segment Sweep Notes:

- The segment table shown on the dialog is '**READ-ONLY**' .
- Learn how to Create and edit the Segment Sweep table .
- **Independent IFBW** and **Power** are NOT available.

Sweep Settings

Click each to learn more about these settings.

- Number of points
- IF Bandwidth This setting is important for improving noise measurement accuracy. [Learn more.](#)
- Start / Stop , Center / Span frequencies.

Power Tab - Noise Figure dialog box help

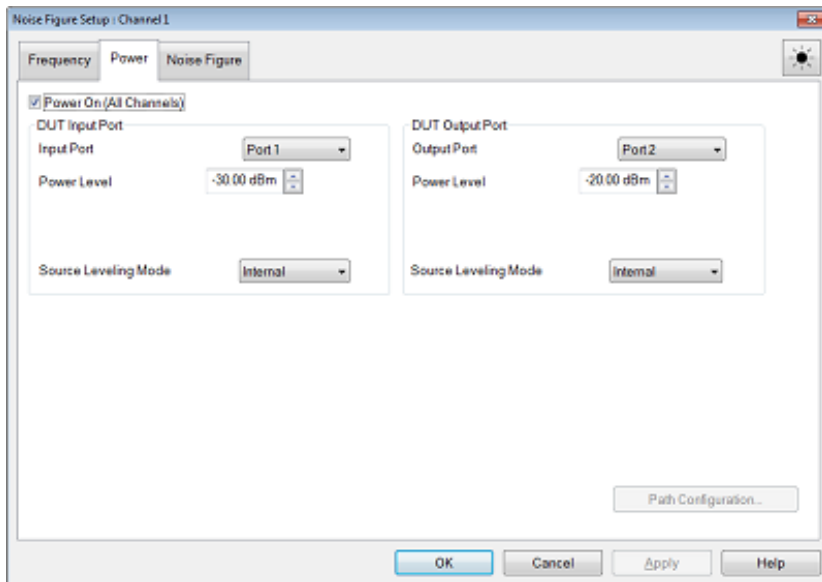

Note: S-parameter power settings are critical for accurate noise figure measurements. See Noise Figure Measurement Tips.

Configures RF power settings for the S-parameter measurements that occur before noise measurements. Input power to the DUT is turned OFF during noise measurements.

These settings can also be made from the normal Power setting locations.

Power ON (All channels) Check to turn RF Power ON for all channels.

DUT Input Port

Select a VNA port to be connected to the DUT input.

Power Level The input power to the DUT during S-parameter measurements.

Receiver Attenuator Specifies the receiver attenuator setting for input port. (M9485A with M9377A only)

NOTE: When the M9377A DRA receiver is used, Receiver Attenuator is available. 0 dB attenuator is recommended for Noise Figure measurement.

Source Leveling Specifies the leveling mode .

DUT Output Port

Select a VNA port to be connected to the DUT output.

Output Power Sets power level in to the output port for reverse sweeps. Port power is

automatically uncoupled. Reverse sweeps are always applied to the DUT when Full 2-port correction is applied. Enhanced Response Cal is NOT available for noise figure measurements.

Receiver Attenuator Specifies the receiver attenuator setting for the output port. Learn more about Receiver Attenuation. (M9485A with M9377A only)

NOTE: When the M9377A DRA receiver is used, Receiver Attenuator is available. 0 dB attenuator is recommended for Noise Figure measurement.

Source Leveling Specifies the leveling mode .

Noise Figure Measurement Tips

Note: In this topic, the term **Jitter** is used to describe the trace-to-trace fluctuations in a measurement. In other topics, this is called 'trace noise'.

IF Bandwidth

Jitter is further reduced by narrowing the IF bandwidth. If the calibration needs to be performed at a low source power, or with receiver attenuation due to high DUT gain, the IF bandwidth should be reduced during the calibration to reduce jitter. The IF bandwidth can then be increased to improve measurement speed. The CA annotation can be ignored when changing IFBW after calibration.

Noise Settings

See Noise Figure dialog box help for a complete description of these important settings.

Temperature

Noise Figure measurements are extremely sensitive to temperature. As such, there are two settings that require an accurate temperature measurement: At the DUT input , and at the Noise Source connector.

Interference

When measuring the noise figure of an unshielded device, like an amplifier on a printed-circuit board, it is very common to pick up interference from external signals such as cellular phones, wireless LAN, or mobile radios. This interference shows up as non-repeatable spikes in the measurement, as shown below.

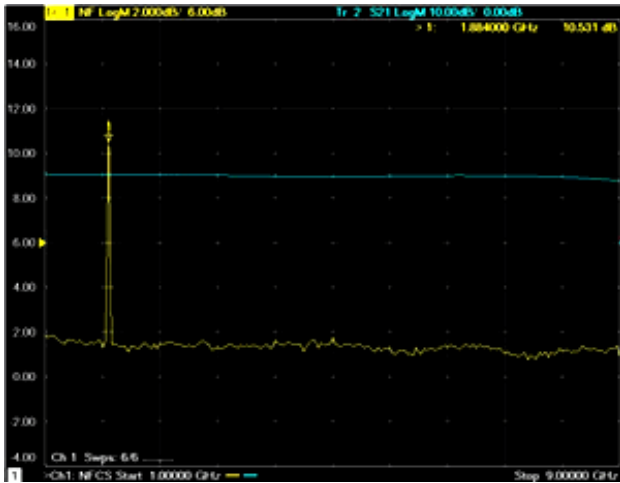

Usually, the interference adversely affects the noise figure measurement only at the frequency where it occurs. However, if the interference is large enough and present all of the time, it can cause the noise receivers to compress, which results in inaccurate measurements at many frequencies. In this case, the noise figure measurements should be done in a shielded environment like a screen room.

Using Noise Figure Traces in Equation Editor

In a Noise Power trace, the underlying unit is noise temperature.

$$10 \cdot \log_{10}(\text{temperature} * 1000\text{mw/w} * 1.38\text{e-23})$$

(**1.38e-23** is Boltzmanns constant)

Any time you use Equation Editor on a Noise Power trace, the LogMag formatting will apply the above equation. Therefore, first select **REAL** format and then generate the equation.

The following screen is an example showing three traces: DUTNPD (DUT Noise Power Density), NF (Noise Figure), and S11 with the equation set to "***=10". Note that formatting for noise figure measurements is different than noise power measurements or temperature measurements.

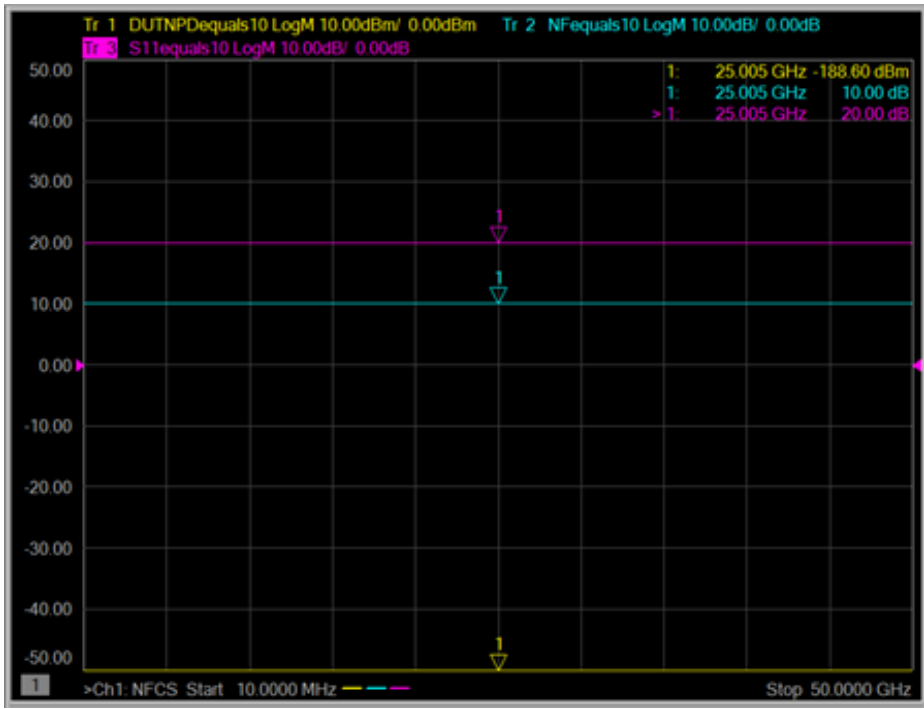

Calibration for Noise Figure on Amplifiers

Note: The M937xA/P937xA does not support this function.

This topic discusses calibration for both Noise Figure on Amplifiers .

- [Overview](#)
- [How to Perform a Noise Figure Cal](#)
 - [Select Calibration Method](#)
 - [Configure Noise Source](#)
 - [Select DUT Connectors and Cal Kits](#)
 - [Measure Standards Steps](#)
 - [Validate Noise Source Cal](#)

See Also

[Noise Figure and TRL Cal](#)

See [Noise Figure Applications](#)

Noise Figure Calibration Overview

Note: Noise Figure results are NOT at all accurate without a Noise Figure calibration.

Calibrating the Noise Receivers

Note: The term 'noise receiver' is used here to refer to the receiver that is used to measure noise.

The noise figure calibration process is different depending on if a Noise Source or a VNA source (calibrated with a power meter) is used to calibrate the noise receiver.

Using a Power Meter

When 'Use Power Meter' is selected on the 'Select Cal Method' dialog, a power meter is used in place of a noise source to characterize the noise receiver. The process happens in three steps:

1. A Source Power Cal is performed at the port connected to the DUT's input, with a power level that is specified on the **first measurement step** of the calibration wizard.
2. A THRU connection is made from the calibrated source port to the specified noise receiver port. The gain of the noise receiver is then measured, as well as the receiver's noise floor.
3. With the THRU connection in place, the swept-frequency response of the noise bandwidth filter is measured. Since the noise receiver uses double-sideband homodyne mixing, the user sees a symmetrical response representing the low- and high-side responses, with a notch in the middle that nulls out the DC response. From the measured filter shape, the equivalent noise bandwidth is calculated. This information combined with the data from step 2 gives the gain-bandwidth product and noise figure of the noise receiver.

The following are variations to this process .

- a. Step 3 (measure the frequency response of the noise bandwidth filter) is always performed, over the frequency range specified in the noise figure channel.
- b. The gain-bandwidth information is contained within the noise figure calset.
- c. Noise averaging is not automatically turned on.

Using a Noise Source (See Noise Source requirements).

A Noise Source is a device that generates two very consistent levels of noise over its operating frequency range:

- Hot (On) - the Noise Source is biased in order to provide a high level of noise.
- Cold (Off) - the Noise Source is unbiased to provide ambient temperature noise level.

These levels are measured by the Noise Source manufacturer and provided in table and electronic format with each Noise Source by serial number. The electronic file is known as the ENR (Excess Noise Ratio) file.

1. The Noise Source is connected to the noise receiver through test port 2.

Note: For highest accuracy, the noise source should be connected as close as possible (the least amount of electrical loss) to the VNA port 2 connector. This causes the largest difference between the Noise Source HOT (on) and COLD (off) settings.

- The Noise Source is measured by the noise receivers at each measurement frequency. The differences between the known ENR noise levels and the measured noise levels are the noise error terms. These values are removed from subsequent noise measurements.
- During the Noise Source measurements, noise averaging and noise bandwidth is automatically turned ON to the values that you specify. [Learn more about Noise Averaging.](#)

Following the Noise Receiver Cal

- A **2-port S-parameter calibration** is performed on the noise figure channel. This is because S-parameters are measured at each frequency step before a noise measurement. Also during the S-parameter cal, at least FOUR different impedance states are presented at port 2 in order to later characterize the noise generated by the noise receiver. This cal can be either a SOLT or **TRL cal**. See [Noise Figure and TRL Cal](#).
- After calibration, correction is automatically turned ON. The VNA **status bar** shows **VNC_2P** (for Vector) or **SMC_2P** (for Scalar).

How to Perform a Noise Figure Calibration

- Make the noise figure channel the active channel.
- Connect the noise figure Tuner to the VNA (for Vector noise figure cal).

Using **Hardkey/SoftTab/Softkey**

- Press **CAL > Main > Smart Cal....**

Using a mouse

- Click **Response**
- Select **Cal**
- Select **Smart Cal...**

Programming Commands

The following Cal Wizard pages are unique to noise figure calibration. The remaining pages that are presented are the same as those in the standard [Cal Wizard SmartCal](#).

Select Calibration Method dialog box help

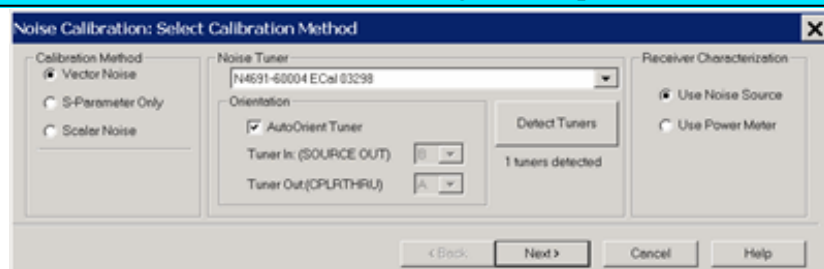

Calibration Method

- Vector Noise - Comprehensive noise figure calibration (Not available on M9485A)
- S-Parameter Only - Does NOT calibrate the noise receivers. (Not available on M980xA/P50xxA)
- Scalar Noise - Calibration for scalar noise figure measurements. [Learn more.](#)

Noise Tuner

Note: The M9485A does not support this function.

- Not available when Scalar Noise is selected.
- Select from the ECal modules that are connected to the USB.

Orientation

Note: The M9485A does not support this function.

AutoOrient Tuner Check to allow the noise tuner orientation to be auto-detected. When cleared, use the following two fields to provide manual orientation of the noise tuner.

Tuner In (SOURCE OUT) / Tuner Out (CPLRTHRU): Specify the ECal module labels that are connected to the VNA front panel jumper connectors. [Learn how to connect the noise tuner.](#)

Detect Tuners Click to re-detect the Noise Tuners (ECal modules) that are connected to the USB. If the ECal module is not detected, check the USB connection, then click this button. The label below the button indicates the total number of ECal modules that are connected to the USB.

Receiver Characterization - [Learn more about this process.](#)

- **Use Noise Source** - A noise source is used to characterize the low-noise receivers.
- **Use Power Meter** - A Power Meter/Sensor is used to calibrate a VNA source, which then is used to characterize either the low-noise receivers or a VNA receiver. This selection is made for you and can NOT be changed when **NA Receiver** is selected on the [Noise Figure Setup dialog](#).

Note: (M9485A) Select Internal for Power > Leveling & Offsets > ALC Hardware setting

Configure Noise Source dialog box help

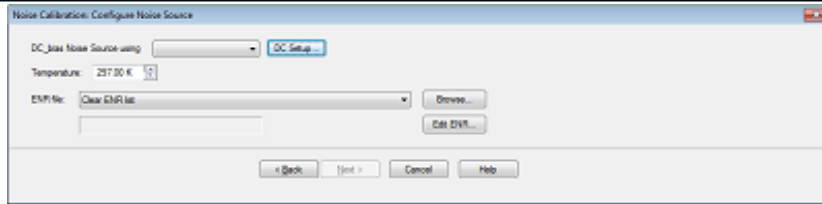

DC Bias Noise Source using Select the required noise source from selection.

DC Setup Setup the **external DC source**.

Temperature Specify the current temperature at the Noise Source connector. The Noise source is kept ON during noise figure measurements. This results in the Noise Source being a few degrees warmer than Ambient temperature, and a more accurate calibration. See **Noise Figure tips** to learn more about the significance of temperature.

ENR File Select the Noise Source ENR file. If not already there, copy your Noise Source ENR file to the VNA C:/Program Files/Keysight/Network Analyzer/Noise folder. Then click **Browse** to find the ENR file.

Clear ENR List Scroll to the bottom of the ENR list, then click to remove the selected ENR file. Then browse or select to find a new file.

Edit ENR Click to launch the **ENR Editor** dialog box which is used to change or create ENR files. This is NOT usually necessary.

See Noise Source requirements.

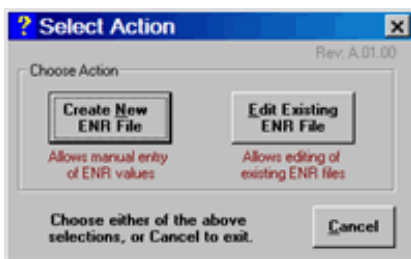

Click either Create or Edit to launch the same dialog box, shown below.

- **Edit** populates all fields with existing data which can then be edited and stored.
- **Create** has empty fields except for frequencies.

Edit / Create ENR File dialog box help

MHz	ENR
10	13.816
100	13.642
1000	13.536
2000	13.321
3000	13.282
4000	13.316
5000	13.425
6000	13.609
7000	13.862
8000	14.142
9000	14.49
10000	14.71
11000	14.792
12000	14.993
13000	14.934
14000	15.041
15000	15.019
16000	14.961
17000	14.747
18000	14.679
19000	14.597
20000	14.65
21000	14.914

ENR Numeric Data

Use **Previous** and **Next** buttons to scroll to **Entry #** to edit. Type **ENR** value in dB, then press **Enter**.

Done Click when finished editing all values. Then click **Store ENR File** to save the file.

Identifying Data

Model # of the Noise Source. This can NOT be changed.

Serial # of the Noise Source.

Temperature and Humidity in which the Noise Source was calibrated. This is for information only. The ENR data is always normalized to 290 Kelvin.

KeyBd launches a mouse-driven keyboard.

Store ENR File Click to launch a dialog to save the new or edited ENR file.

Select DUT connectors and Cal Kits dialog box help

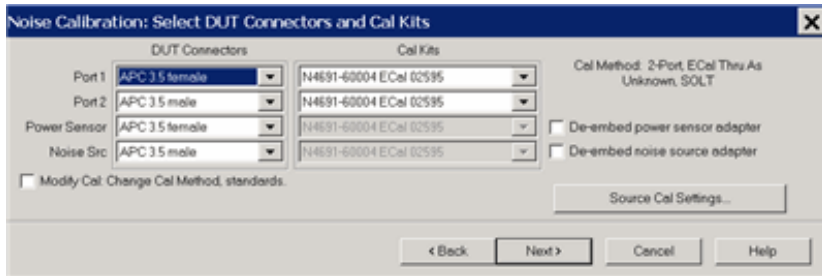

Port 1 and Port 2

DUT (Device Under Test) Connectors Specify the connector and gender of the **DUT**.

Cal Kits Select the Cal Kit to be used to calibrate each test port. The list for each DUT Port displays kits having the same connector type as the DUT. Using incorrect calibration standards can significantly degrade measurement accuracy. [Learn more](#).

Power Sensor Used to calibrate the source port. Specify the connector and gender of the Power Sensor.

Noise Src Used to calibrate the noise receivers. Specify the connector and gender of the Noise Source. The Keysight 346C has an "APC 3.5 male" connector.

Note: For highest accuracy, the noise source should be connected as close as possible to the VNA port 2 connector. This causes the largest difference between the Noise Source HOT (on) and COLD (off) settings.

For both Cal devices (power sensor and noise source, specify the connector type and gender. When the Cal device connector is **NOT** the same type and gender as the DUT Port connector, then for optimum accuracy, extra cal steps are used to measure and correct for the adapter that is used to connect the Cal device to the reference plane.

Select **Ignored** (at the bottom of the DUT Connectors list) to NOT compensate for the adapter.

Select the Cal Kit that will be used for that process.

De-embed power sensor adapter / noise source adapter / thru adapter The VNA uses the connector type and gender of the DUT along with the connector type and gender of the cal device to determine if an adapter removal operation is taking place AND whether or not that removal operation requires an additional cal step.

However, the use of the connector type can, in special cases, hide the need for the extra cal step. Check the "De-embed..." box in these cases to inform the VNA that the extra step is needed.

Such a case is illustrated below where the noise source is connected close to test port 2 for higher accuracy. If unchecked, the VNA would assume in this case that the Noise Source is connected to

the Thru standard at the port 1 (DUT input) reference plane.

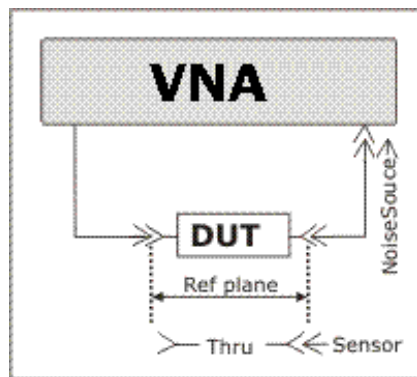

Source Cal Settings Click to launch the **Source Power Cal (for apps)** dialog. This dialog is used to set Power Meter / Sensor settings for both the Port 1 Power Cal, and the optional LO Power Cal.

Modify Cal Check, then click **Next**, to Modify Cal (Standards AND Thru Method).

Note: **Enhanced Response Calibration** is NOT supported with noise figure.

Measure Standards Steps dialog box help

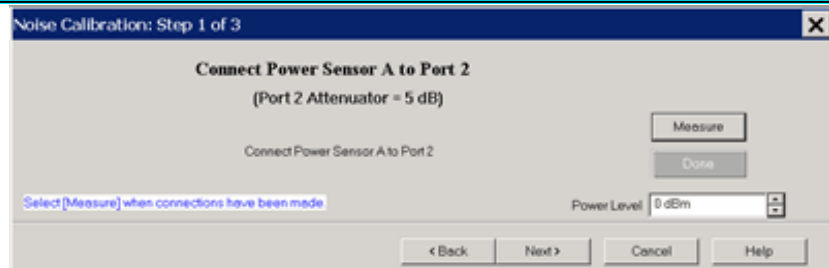

Power Level at which to perform the Power Cal.

It is usually best to set power level to 0 dBm at the power sensor because the power sensor is calibrated at that level. Lower power levels will yield a slower and noisier calibration.

However, with 20 dB of source attenuation (default NF setting), the VNA may not be capable of achieving this power level at higher frequencies. To check the max leveled power, view an **R1 (port 1 reference receiver) trace** over the frequency range of interest, then increase the power until roll-off appears. Power levels at the test port may be approximately 2 dB lower than at the R1 receiver.

If an external component is used between the VNA test port and the calibration reference plane,

then adjust the power level so that the power at the sensor is about 0 dBm if possible.

The current source attenuation value is shown on the dialog.

Connect Noise Source to the Port 2 measurement (reference) plane

When the "**De-embed Adapter..**" boxes are checked, additional cal steps are required.

Subsequent Steps

Connect Port 1 to Port 2 - Connect port 1 reference plane to the port 2 reference plane using the required Thru standard or adapter.

Connect ECal to Ports 1 and 2 - Connect the ECal module between the port 1 reference plane and the port 2 reference plane.

Validate Noise Source Cal

To validate a Noise Source calibration, connect the Noise Source to Port 2 and measure ENR.

Compare the measured values to the values in the ENR table.

How to manually turn the Noise Source ON | OFF

1. Press **Power** > **Main** > **Noise Source**.
-

Noise Figure and TRL Cal

Note: The M937xA/P937xA does not support this function.

When performing a TRL (or LRL, LRM) Cal as the 2-port S-parameter calibration of a **Scalar or Vector Noise Figure** measurement, you may see an error message that states that there are not enough standards for the cal.

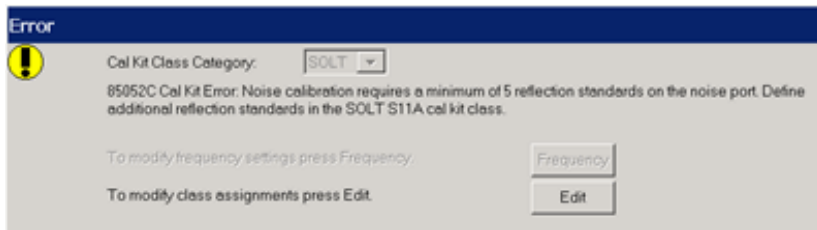

This appears because, during the TRL calibration, at least **FIVE** impedance states must be presented to the Noise Receiver port. A typical TRL Cal Kit does not have 5 standards with the same connector type and gender as the DUT output port, and with different impedances.

To correct this situation, you must define additional standards for your TRL Cal Kit using the **Edit Cal Kit dialog**.

Notes

- Extra impedance standards are NOT required when you select and use an ECal module to perform the **De-embed noise source adapter**. In this case the ECal module is used to present five different impedance states to the Noise Receiver port.
- You can view the impedance match by measuring the standard over the frequency range of interest while viewing the Smith Chart format. Ideally, all five standards should have a response at different areas of the **Smith Chart**.

To Modify the Cal Kit

If the TRL Cal Kit is also defined as an SOLT kit, those **Selected Standards** will also be searched for an appropriate Reflect Standard.

1. Click **Edit** on the Error dialog, or **Cancel**.
2. Press **CAL > Cal Sets & Cal Kits > Cal Kit....**
3. Select the Cal Kit to be edited, then click **Edit....**

4. On the Edit Kit dialog, click the **TRL** tab.
5. For each of the following **Calibration Kit Classes**, note the **ID** number in the **Selected Standards** field:
 - TRL THRU
 - TRL REFLECT
 - TRL LINE/MATCH

For example, in the following image two shorts are defined as TRL REFLECT standards: ID numbers **7** and **14**. Because they are already being used, you can NOT use these IDs for the additional standards required by the Noise Cal. You must select other standards available in the kit or you can define new standards.

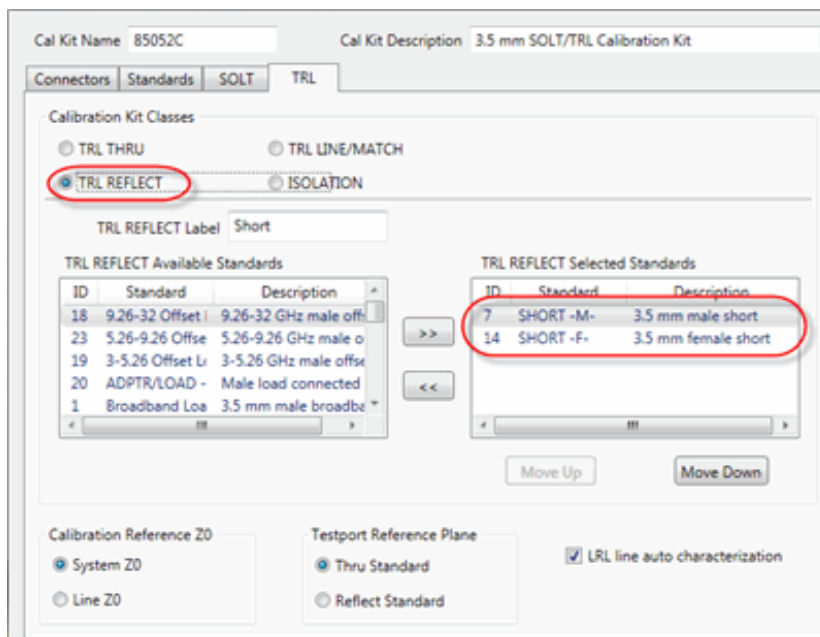

6. Select the SOLT tab, then select any of the following Calibration Kit Class definitions:
 - a. **SA** (Open)
 - b. **SB** (Short)

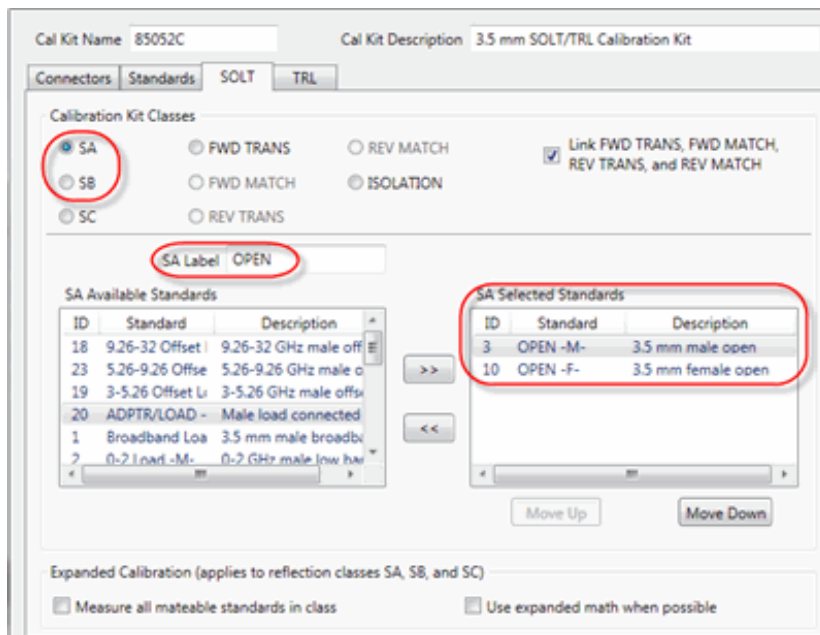

7. In the **Available Standards** field, find a standard that is NOT one of the TRL IDs noted above. In this image, two opens are already assigned as SOLT standards, but because they are NOT assigned as TRL reflection standards, they are eligible to be additional standards.

8. If necessary, click >> to add it to the **Selected Standards**.

Note: Be sure to choose standards with the **same** connector gender as the DUT output port.

If no others exist, the following are good options:

- Offset Short
- Offset Open

If your TRL Cal Kit does NOT have FIVE standards

You can create a new device by reusing the LINE standard. However, instead of connecting both ends of the line, leave the line unterminated.

Although the following example creates an Open standard, during the calibration you will connect any line standard to the Noise Receiver port. The standard or definition is not important. It is simply another impedance state.

The following is an example of how to create this device.

1. On the Standards tab, click **Add**.

The following dialog appears:

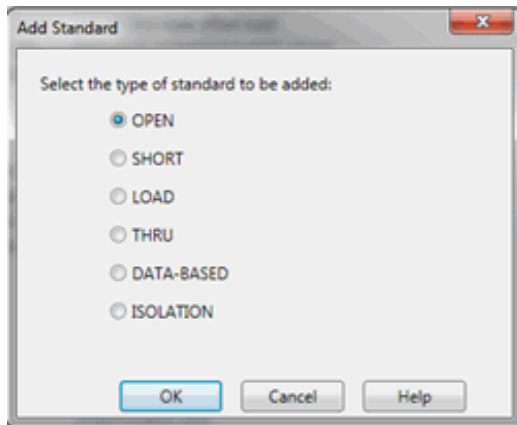

2. Select **OPEN**, then click **OK**.
The following dialog appears:

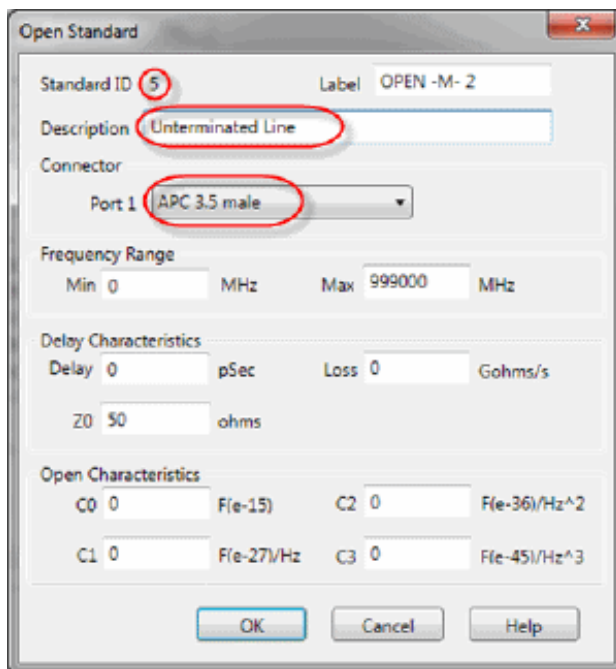

3. Change the description to **Unterminated Line**. This will provide a prompt during the calibration.
4. Change **Connector** to match your physical line standard.
5. Note the new **Standard ID** number.
6. In the same manner as step 6 (above), on the **SOLT** tab, select **SA**.

7. Assign the new standard ID to the Selected Standards.

Important: Leave the new standard at the bottom of the Available standards list to which it was added. That way it will have no effect of the SOLT calcs using that kit.

Spectrum Analyzer

The Spectrum Analyzer function is available with Sx090A/B.

Note: (M980xA/P507xA) In addition to S9x090A/B, option 090 (spectrum analysis hardware) must be equipped with the module. In multi-module configuration, the spectrum analysis measurement works on only the ports of the module with opt.090.

In this topic:

- Features, Requirements, and Limitations
- Spectrum Analyzer Setup Overview
- How to make SA Measurements
 - SA Setup Dialog
 - Source Setup Dialog
 - Advanced Settings Dialog
 - IF Dialog
 - Trigger Dialog
 - Processing Dialog
 - ADC & LO Dialog
 - Data Dialog
 - Source Frequency Settings Dialog
 - Source Power Settings Dialog
 - Measurement Parameters
- SA Markers
- Calibrating an SA Channel
- Gated SA
- SA Warning Messages
- Spectrum Analyzer Measurement Examples (Separate topics)
 - Amplifier Harmonics Measurement
 - Converter Spurious Measurement
 - Gated Measurement

See Also

Programming commands

Spectrum Analyzer mmWave Measurements

Other VNA Applications

Features, Requirements, and Limitations

Features

- General purpose spectrum analysis for component measurements
- Add multi-channel spectrum analysis (multiple receivers/frequencies)
- Perform fast spurious search in broad frequency band
- Enable spectrum analysis at calibration plane using VNA calibration and Fixturing (de-embedding)
- Single-connection, multiple measurements
- Internal, manual, and external triggering - learn more
- Marker -> SA available in Standard, SMC, and Swept IMD channels
- Gating - learn more
- Coherence Image Rejection for multi-tones and repetitive test signals
- Export data
- All VNA with SA option (S9x090xA/B, S9x090A/B) are supported.
- Broadband and Banded millimeter-wave systems are supported - learn more
- External DC meter configuration is supported for a SA measurement channel.
- Massive Multiports: 5 ports (VNA max ports). Allow unlimited traces in the same channel.

Requirements

- Spectrum Analyzer software option S9x090xA/B and hardware option 090.
- Windows 7 or Windows 10 operating system

SA Setup Overview

1. Configure SA settings.
2. Set up the SA source frequency and power.
3. Define the measurement parameters.
4. Select markers.

5. Calibrate the SA channel using the Cal All wizard.

How to make SA Measurements

Create a Spectrum Analysis Channel

1. On the VNA front panel, press **Meas** > **S-Param** > **Meas Class...** .
2. Select **Spectrum Analysis**, then either:
 - **OK** delete the existing measurement, or
 - **New Channel** to create the measurement in a new channel.
3. A **Spectrum Analysis** measurement is displayed.

Configure SA settings

Using **Hardkey** /**SoftTab** /**Softkey**

1. Press **Freq** > **Main** > **SA Setup...** .

Using a mouse

1. Click **Stimulus**
2. Select **SA Setup...**

SA Setup Dialog tab help

Programming Commands

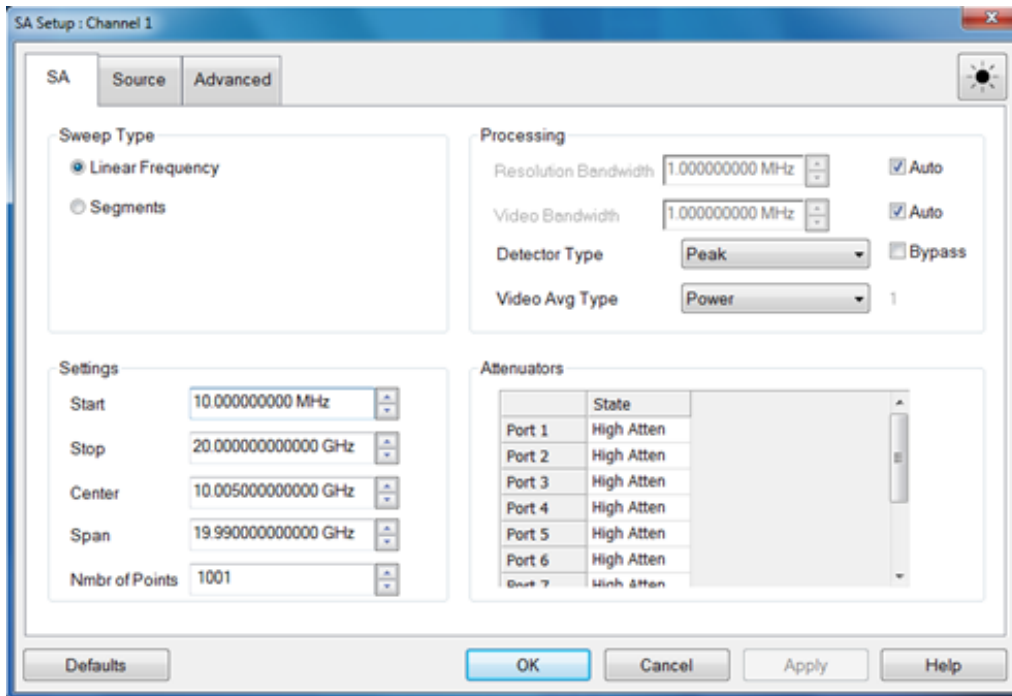

Sweep Type - Sets the spectrum analysis sweep type. See Type (Sweep).

Show segments - Displays the segment table at the bottom of the display.

Hide segments - Hides the segment table.

Processing

Resolution Bandwidth - Provides the ability to resolve, or see closely spaced signals. The narrower (lower) the Resolution Bandwidth, the better the spectrum analyzer can resolve signals. In addition, as the Resolution Bandwidth is narrowed, less noise is measured by the spectrum analyzer ADC and the noise floor on the display lowers as a result. This allows low level signals to be seen and measured. However, as the Resolution Bandwidth is narrowed, the sweep speed becomes slower.

Auto - Check to couple Resolution Bandwidth to the frequency span in a ratio based on the Span/RBW setting. As the frequency span is narrowed, the Resolution Bandwidth is also narrowed providing increased ability to resolve signals. Clear to uncouple the settings.

Video Bandwidth - Sets the video averaging factor. The averaging operation is applied after the DFT (Discrete Fourier Transform) and before the image rejection. The trace data is smoothed with the method selected by the Video Averaging Type. More smoothing occurs as the Video BW is set lower. However, as the Video BW is narrowed, the sweep speed becomes slower. The Video Bandwidth can be set from 3 Hz to 3 MHz when Auto is deselected.

Auto - Check to couple the Resolution Bandwidth to the Video Bandwidth in a ratio based on the RBW/VBW setting. Clear to uncouple the settings.

Detector Type - A "detector" is an algorithm used to map DFT bins into display buckets. There are typically several DFT bins in a single display bucket, and the detector determines how to translate the multiple DFT values into a single display value.

Peak - Displays the maximum value of all the measurements in each bucket. This setting ensures that no signal is missed. However, it is not a good representation of the random noise in each bucket.

Average - Displays the Root Mean Squared (RMS) average power of all the measurements in each bucket. This is the preferred method when making power measurements.

Sample - Displays the center measurement of all the measurements in each bucket. This setting gives a good representation of the random noise in each bucket. However, it does not ensure that all signals are represented.

Normal - Provides a better visual display of random noise than Positive peak and avoids the missed-signal problem of the Sample Mode. Should the signal both rise and fall within the bucket interval, then the algorithm classifies the signal as noise. An odd-numbered data point displays the maximum value encountered during its bucket. An even-numbered data point displays the minimum value encountered during its bucket. If the signal is NOT classified as noise (does NOT rise and fall) then Normal is equivalent to Positive Peak.

NegPeak- Displays the minimum value of all the measurements in each bucket.

Peak Sample - Attempts to determine if the display bucket contains an actual signal, or just noise. If a signal is present, the Peak detector is used, otherwise Sample is applied.

Peak Average - Attempts to determine if the display bucket contains an actual signal, or just noise. If a signal is present, the Peak detector is used, otherwise Average is applied.

Bypass - Check to bypass the Detector Type to view all display points from the DFT. This is only available if the total number of DFT points can be handled by the display.

Video Averaging Type - Determines how to compute the video average. When Auto is selected, the optimum type of averaging for the current instrument measurement settings is selected. It averages the magnitude of the DFT bins. Averaging only applies if the video bandwidth is less than the resolution bandwidth.

Voltage - Selects averaging of the detected signal's magnitude and returns the result.

Power - Selects averaging of the detected signal's squared magnitude and returns the square root of the result.

Log - Selects averaging of the detected signal's natural logarithm of the magnitude and returns the exponentiated value of the result.

Voltage Max - Returns the maximum voltage (signal magnitude) measured during the averaging period.

Voltage Min - Returns the minimum voltage (signal magnitude) measured during the averaging period.

Averaging Count - Reads the number of Video bandwidth sweeps that are averaged together. This readout is displayed to the right of the **Averaging Type** selection (the small "1" shown in the dialog above). It can be read with the remote interface using the SENS:SA:BAND:VID:AVER:COUNT? command.

Settings

Sets the SA (receiver) frequency range when running Linear Frequency sweep type . Use either of the following pairs of settings to determine the frequency range.

Start /Stop - Specifies the beginning and end frequency of the swept receiver range. Start is the beginning of the X-axis and Stop is the end of the X-axis. When the Start and Stop frequencies are entered, then the X-axis annotation on the screen shows the Start and Stop frequencies.

Center /Span - Specifies the value at the center and frequency range. The Center frequency is at the exact center of the X-axis. The Frequency Span places half of the frequency range on either side of center. When the Center and Frequency Span values are entered, then the X-axis annotation on the screen shows the Center and Span frequencies.

Number of Points - Selects the number of trace points on the display. When the Detector is bypassed, the number of display points is read only, it shows the current DFT points to cover the RF span.

Note: When running Segments, the frequency ranges are set by the segment table.

Attenuators

Receiver Attenuation is used to protect the test port receivers from damage or compression. Receiver attenuation causes the applied power at the receiver to be less than the power at the test port by the specified amount of attenuation.

Type or select independent attenuation values for each test port receiver.

A preference can be set to mathematically offset (or NOT) the reported power at the test port receivers by the amount of receiver attenuation. By default, All VNA models offset the display. Learn how to set the preference .

SA Source Setup tab help ▶ **Programming Commands** ◀

SA Setup : Channel 1

SA Source Advanced IF Trigger Processing ADC & LO Data

Power On (All Channels) Port Powers Coupled

Name	State	Type	Frequency	Power	Phase	Modul.
Port 1	OFF	CW	CW Freq 1.0000000000000000 GHz	0.00 dBm	+0.0	OFF
Port 2	OFF	CW	CW Freq 1.0000000000000000 GHz	0.00 dBm	+0.0	OFF

RF source sweep order: Frequency Power Phase

Path Configuration... Power and Attenuator... Pulse Setup... External Devices...

Defaults OK Cancel Apply Help

Power On (All Channels) Check to enable source power for all channels. Only turns power ON if the port State setting is ON.

Port Powers Coupled

- **Coupled** (checked) The power levels are the same at each test port. Set power at any test port and all test ports change to the same power level.
- **Uncoupled** (cleared) The power levels are set independently for each test port. Uncouple power, for example, if you want to measure the gain and reverse-isolation of a high-gain amplifier. The power required for the input port of the amplifier is much lower than the

power required for the output port. A power sweep can also be performed with uncoupled power. Learn more about Setting Independent Port Power .

Source Cells

Name - Lists the test ports through which an internal source is available. If an external source has been configured, it will appear at the bottom of the list.

State

- **ON** Source power is ALWAYS ON. Turning ON port 1 will also turn ON port 2 and vice versa. The same is true for port 3 and port 4. Learn about internal second source restrictions.
- **OFF** Source power is never ON, regardless of the measurement requirements. Use this setting to prevent damage to a sensitive DUT test port.
- **No Control** Available ONLY on external sources. The SA application will NOT control the external source.

Type (Sweep)

CW - The source is set to a CW frequency.

LinFreq - The source is set to sweep from the Start to Stop frequency.

Power - The source is set to a power sweep.

LinF+Pwr - The source is set to sweep from the Start to Stop frequency and power sweep. The order is determined by the **Sweep Order** selection below.

Segments - The source is set to sweep in frequency sub-sweeps. For each segment you can define independent power levels, IF bandwidth, and sweep time.

Frequency - Click in the cell, then click **Edit** , to start the Frequency Settings dialog (below).

Power - Sets the power level at the output of the source. Click in the cell, then click **Edit** , to start the Power Settings dialog (below).

Phase - Control source phase of a VNA source or external source. Learn more.

Pulse - Enable/disable pulse measurements. Learn more .

IQMod. - Modulated I/Q file. Clicking Edit accesses a dialog for setting up an I/Q modulated file that is sent to a source for measuring Noise Power Ratio (NPR). Refer to the Noise Power Ratio (NPR) Settings topic for descriptions of the modulation dialogs.

RF source sweep order

Frequency Power Phase - Sweep from Start to Stop frequency first then sweep power then sweep phase.

Power Frequency Phase - Sweep power first then sweep from Start to Stop frequency then sweep phase.

Phase Frequency Power - Sweep phase first then sweep from Start to Stop frequency then sweep power.

Phase Power Frequency - Sweep phase first then sweep power then sweep from Start to Stop frequency.

Frequency Phase Power - Sweep from Start to Stop frequency first then sweep phase then sweep power.

Power Phase Frequency - Sweep power first then sweep phase then sweep from Start to Stop frequency.

Buttons

Path Configuration [Learn more](#)

Pulse Setup [Learn more](#)

External Devices [Learn more](#)

Power and Attenuator [Learn more](#)

[Programming Commands](#)

[Advanced Settings Dialog tab help](#)

[Programming Commands](#)

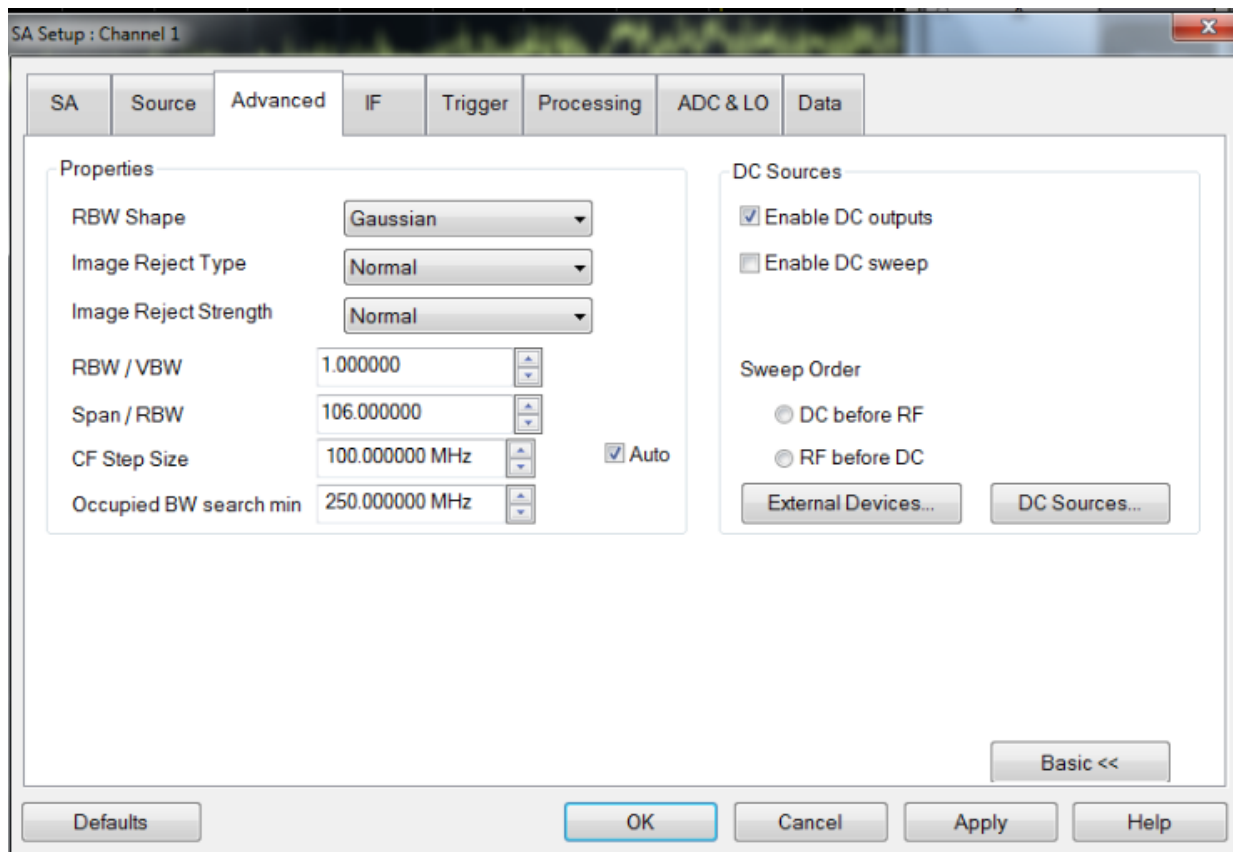

Properties

RBW Shape - Selects the digital filter (window) to apply to the time domain IF signal. The filter effectively "shapes" the signal before application of the DFT to help avoid discontinuities which add unwanted frequency content to the spectrum. Each filter has its own advantages and disadvantages.

Gaussian - Selects a Gaussian window. The Gaussian window has good frequency separation and moderate amplitude accuracy. This window provides higher dynamic range because it has much lower side lobes. It is used for general-purpose measurements and when high dynamic range is required.

Flat Top - Selects the flat top window for amplitude measurement of sinusoidal frequency components. The flat top window has moderate frequency separation and excellent amplitude accuracy. It is typically used for narrowband signals when measuring the amplitude of a particular frequency component with greater amplitude accuracy.

Kaiser - Selects the Kaiser window which is an approximation of a Slepian window using Bessel functions. This window has a relatively high dynamic range and is similar to the Blackman window.

Blackman - Selects the Blackman window. This window has a relatively high dynamic range

and is similar to the Kaiser window.

No Window - The No Window selection does not modify the time-domain data in any way before applying the DFT. This selection is very fast but may yield a significant number of side lobes in the frequency domain because of spectral leakage. This selection has a rectangular shape and does not attenuate any portion of the time record.

Image Reject Type - Sets the minimum number of distinct DFT acquisitions to use when computing an actual signal. As the number of DFT acquisitions increases from the **None**, **LO Low** setting to the **Max** setting, an increased number of erroneous signals are eliminated. Therefore, the **Better** and **Max** settings provide the highest confidence that what remains are actual signals, at the expense of slower measurements.

None, LO High - Selects 1 acquisition with the LO higher than the receiver frequency.

Note: Selecting None, LO High with full span is not possible. See SA Warning Messages.

None, LO Low - Selects 1 acquisition with the LO lower than the receiver frequency.

Note: Selecting None, LO Low with full span is not possible. See SA Warning Messages.

Min - Selects 2 acquisitions.

Normal - Selects 4 acquisitions.

Better - Selects 6 acquisitions.

Max - Selects 8 acquisitions.

Image Reject Strength - Sets the image rejection strength. During the image rejection process, several LO acquisitions overlap at the same RF frequency (depending on the Image Reject Type). As a result, different RF signal values can be returned. This feature sets the acceptable power differences between measurements performed with different LOs in determining actual signals. Possible values are Weak, Normal, Strong. Weak accepts more difference between measurements, and strong less difference.

RBW/VBW - Sets the ratio of Resolution Bandwidth to Video Bandwidth when the Video Bandwidth is in Auto mode.

Span/RBW - Sets the ratio of Span to Resolution Bandwidth when the Resolution Bandwidth is in Auto mode.

CF Step Size - Manually sets the amount Center frequency change that occurs when $\frac{1}{4}$ is clicked (next to the value).

Auto - Each press of the \leftarrow / \rightarrow arrows increments or decrements the Center frequency by 5% of the current frequency span.

Occupied BW search min - Sets the minimum search frequency to use during an Occupied BW search measurement. Power below this frequency is ignored. See Occupied BW Ratio for information about setting up this measurement type.

DC Sources

DC source control allows the spectrum to be measured at multiple DC source settings.

Enable DC Outputs - Enables all DC source outputs that are turned ON in the DC Source dialog. This same selection is found in the DC Source Dialog.

Enable DC Sweep - Enables the DC sources to sweep between their start and stop voltages. If not selected, then the DC sources will be set to their start voltages.

Number of DC levels - Defines the number of voltage levels in the DC sweep.

The following settings apply to the measurement loop order. The SA may be programmed to loop through a series of spectrum measurements at multiple RF source frequencies, multiple RF source powers, and multiple DC voltages. These radio buttons determine whether the DC sources are swept before the RF power and frequencies are swept, or whether the DC sources are swept after the RF power and frequencies are swept.

Sweep Order

DC before RF - Sweep through each DC voltage step first then sweep through the next frequency.

RF before DC - Sweep through each frequency step first then sweep through the next DC voltage.

External Devices... button - Learn more .

DC Sources... - Configure internal DC sources. **Learn more** .

Advanced >> button - Accesses the **IF** , **Trigger** , **Processing** , **ADC & LO** , and **Data** dialogs.

IF Dialog tab help

Programming Commands

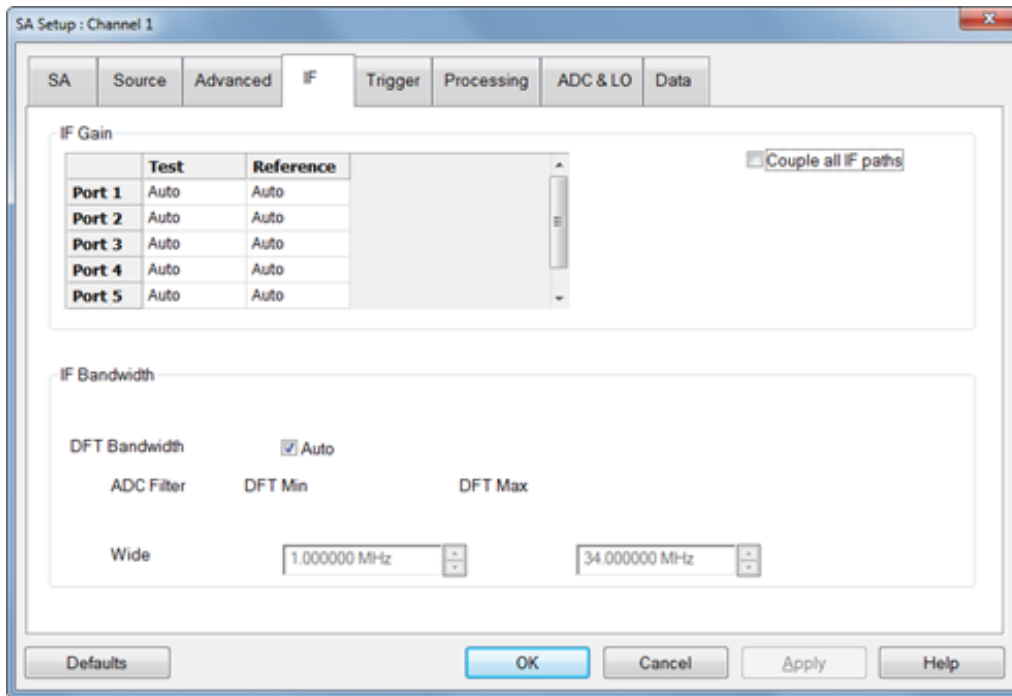

IF Gain

Auto - Selects the appropriate amount for gain versus RF frequency bands for each receiver IF Path.

Or select a specific amount of gain (in dB) for IF receiver paths.

Couple all IF paths - When checked, all receivers assume the same setting. When cleared, each receiver can assume an individual setting.

IFConfig - Accesses the IF Path Configuration dialog. Learn all about IF Path Configuration.

IF Bandwidth

DFT Bandwidth Auto - Enables the default values for DFT bandwidth.

With **Auto** checked, the default values are:

Wide - 1 MHz to 30 MHz

With **Auto** unchecked, the values can be entered manually. The ranges are:

Wide - 500 kHz to 44 MHz

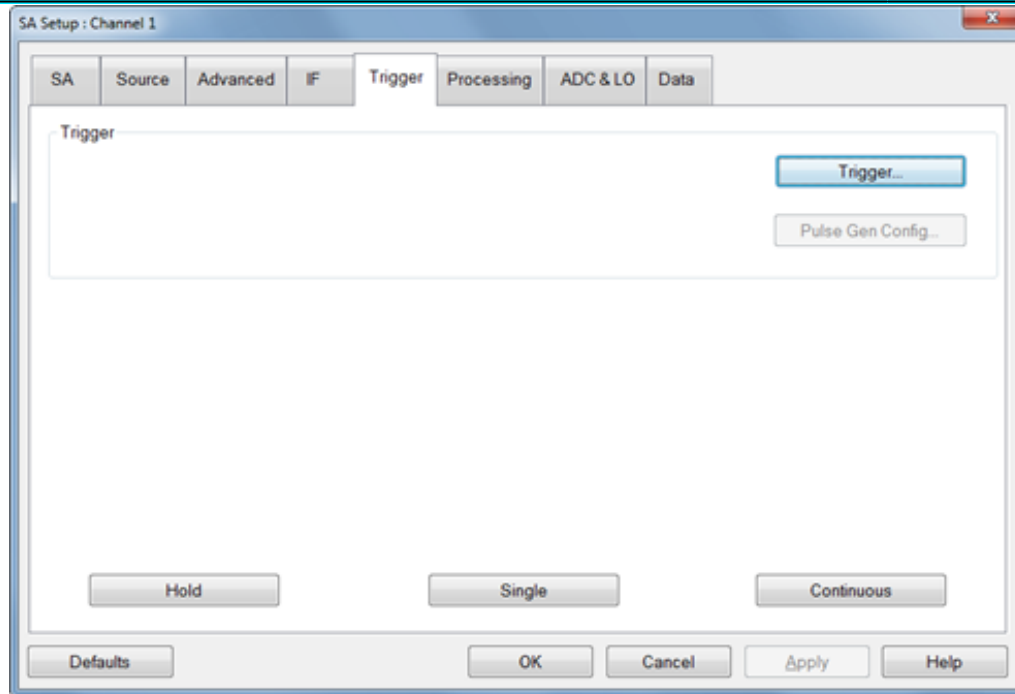

ADC Triggering

Trigger... - Accesses the Trigger dialog for setting up triggering.

Hold - The channel accepts NO trigger signals.

Single - The channel accepts ONE trigger signal, then goes into Hold.

Continuous - The channel accepts an infinite number of trigger signals.

Pulse Gen Config... - Accesses the Pulse Generator Setup dialog for setting up pulse measurements.

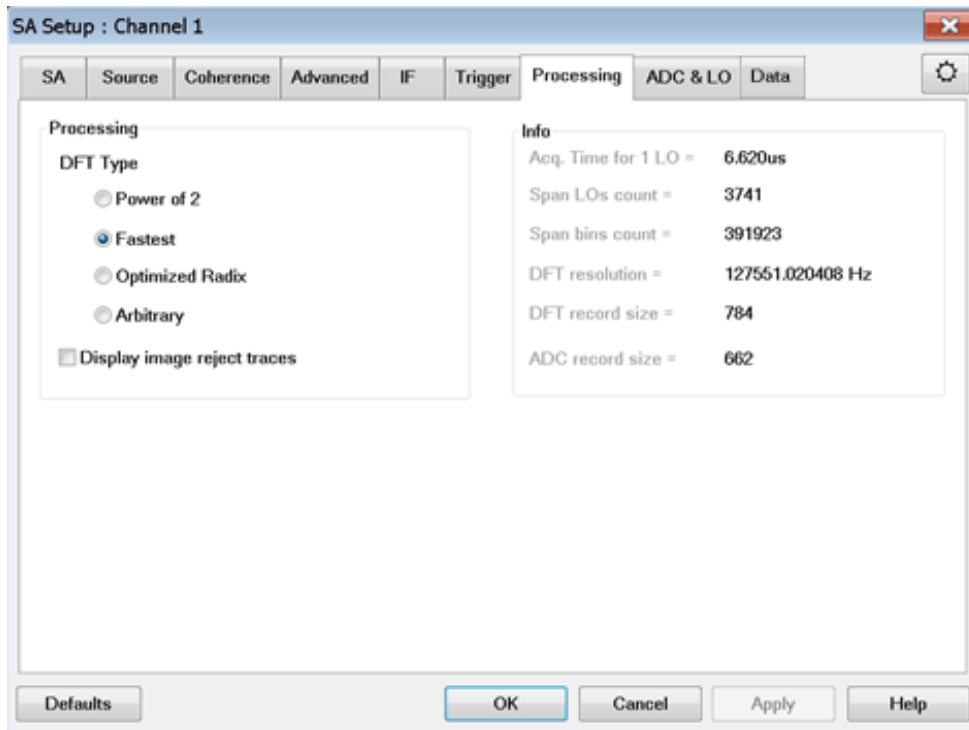

Processing

DFT Type - Sets the DFT record size type. The types include:

Power of 2 - Sets the DFT record size to the next power of 2 greater than or equal to the current ADC record size.

Fastest - Sets the DFT record size as close as possible to the ADC record size (larger or equal) while optimizing processing speed.

Optimized Radix - Sets the DFT record size to the minimum integer number larger or equal than the ADC record size that can be decomposed with 2,3,5,7,11,13 radices.

Arbitrary - Sets DFT record size equal to the ADC record size. If the current ADC record size is a large prime number, then the DFT can be very slow.

Display image reject traces - Check to display the data acquired by each LO. The minimum number of meaningful traces is determined by the "Image Reject" setting (described in the Advanced dialog above).

About Image Reject Traces

These traces display the spectral content of the measured signal for each LO frequency used in the acquisition. The number of ImageReject traces you want to look at is tied to the 'Image Reject' setting. For example, 'Normal' setting is at least 4 ImageReject traces,

and 5 more generally .

This function is intended to be used as a diagnostic tool if something looks suspicious.

Note: Mixer calibration and user calibration are not applied to the image rejection traces, thus the amplitude readout value is not accurate.

Info

Acq. Time for 1 LO - Displays the LO acquisition time which is the ADC Record Size x ADC Sampling Frequency (10 nsec or 40 nsec) x (1 + Stacking) x (Video Averaging Coefficient). When settings affecting this value are changed, the displayed value is not updated automatically and will become grayed out. To update the value, close then open this dialog. The analyzer must be sweeping to update values.

Span Acq. Time - Displays the total acquisition time to perform a SA sweep. For simple cases, it is the acquisition time of one LO multiplied by the number of LOs. When running Multiple recording coherent pulse mode, the acquisition time here takes into account the duty cycle of the pulses.

Span LOs count - Displays the number of LO acquisitions determined by the Image Reject selection and the span. When settings affecting this value are changed, the displayed value is not updated automatically and will become grayed out. To update the value, close then open this dialog. The analyzer must be sweeping to update values.

Span bins count - Displays the current span DFT bin count, the number of DFT points processed across the total RF span. When the Detector is bypassed, this is the number of points that are sent to the display.

DFT resolution - Displays the DFT resolution.

DFT record size - Displays the current DFT record size.

ADC record size - Displays the ADC record size value.

ADC with average - Displays the ADC acquisition time of one LO multiplied by the averaging (vector averaging or video averaging) factor. It is the straight ADC acquisition time that has to go into the ADC memory for further processing.

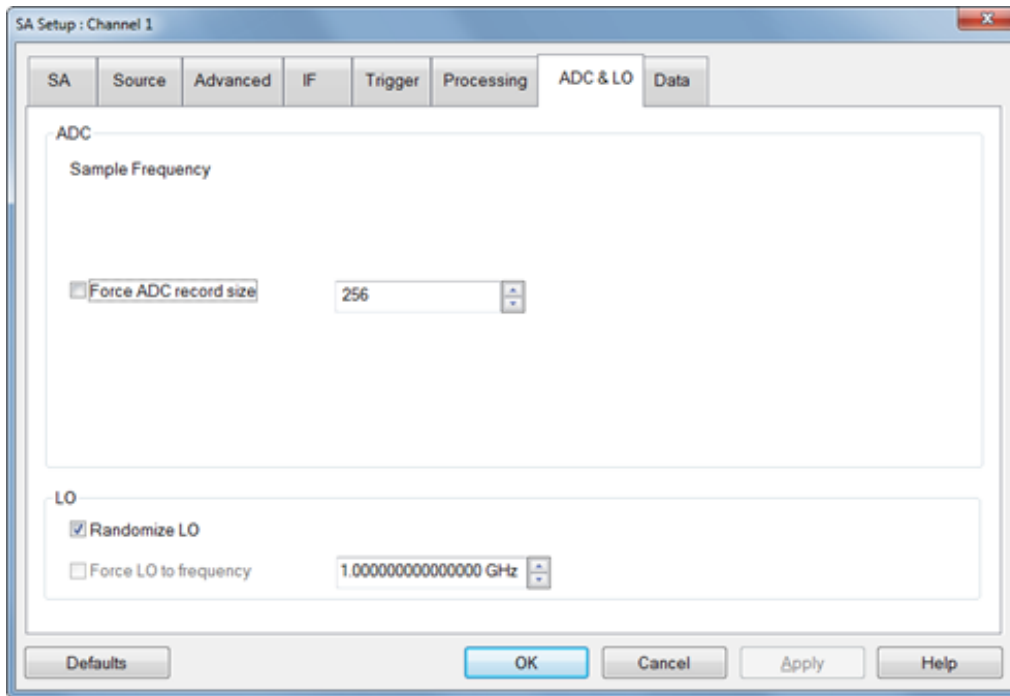

ADC

Force ADC record size - Sets the ADC record size which is dependent on the Resolution Bandwidth and ADC Sampling Frequency:

$$ADC \text{ Record Size} = \frac{1}{ResBW} \times ADC \text{ Sampling Frequency} \times \text{Window Expansion Factor}$$

Check box - Check to enable the ADC record size to be specified manually. Doing so sets the resolution bandwidth. The size range is 64 Samples to 32 or 64 MegaSamples depending on the selected receivers. The DFT size will be recomputed accordingly to the DFT Type setting. When not checked, the value displayed is the current ADC record size. This feature is not compatible with Coherent Multitone mode.

LO

Randomized LO - Check to allow dithering of the LO values used when taking a sweep. Allowing randomized LO makes it less likely that erroneous signals will appear in the final measurement.

Force LO to Frequency - Sets the LO to a specified frequency. This check box can only be set if **Image Reject** is set to **None, LO Low** or **None, LO High**.

Check box - Check to enable the LO frequency to be specified manually.

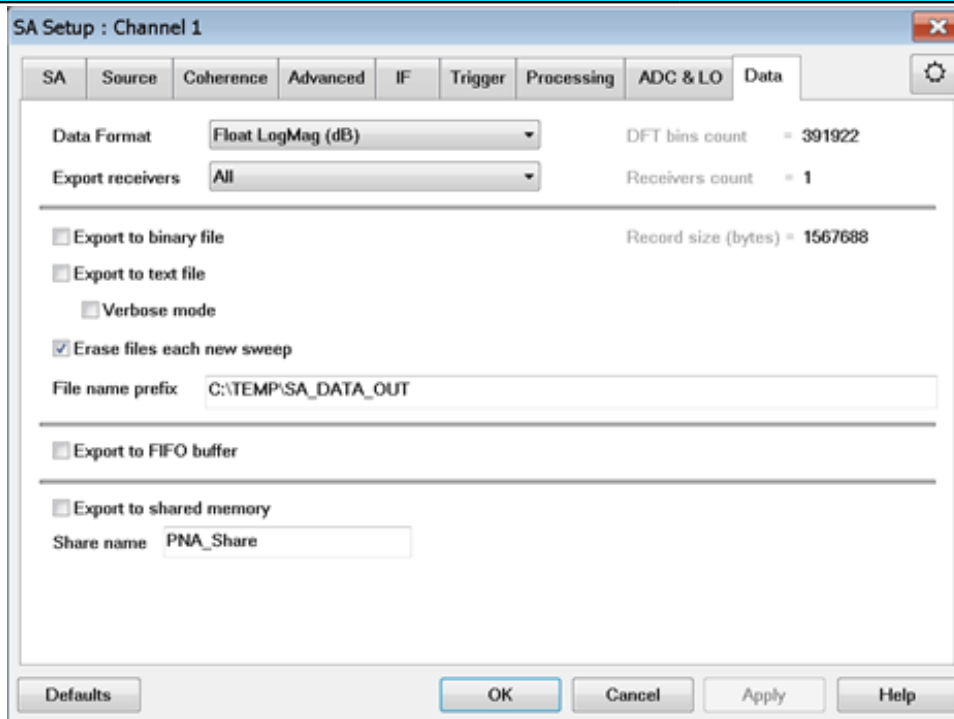

Data Format -

Float LogMag (dB) - Sets the data format to log magnitude in dBm.

Float LinMag - Sets the data format to linear magnitude in volts.

Integers - Sets the data format to Packed Integers (each value is a short 16 bit integer, the equation to compute the dBm value is: $\text{dBm} = \text{Xshort}/200.0 - 36.165$).

Export receivers - Select the data to export from a specific receiver or all receivers.

Don't save data below threshold - Set data level threshold mode and threshold level in dBm. For text file output with verbose mode, only the frequencies with power greater than this threshold setting will be written to the file.

DFT bins count - Displays the current DFT bin count, the number of DFT points processed across the total RF span. When the Detector is bypassed, this is the number of points that are sent to the display.

Receivers count - Displays how many receivers are currently being exported. The number here can be less than the number of receivers specified in Export Receivers, if some of

them at not selected in the channel.

Export to binary file - Set data to be exported to a binary file. Data is not exported until the next new sweep occurs.

Export to text file - Exports data only. Data is not exported until the next new sweep occurs.

Verbose mode - Exports frequency and data. Data is not exported until the next new sweep occurs.

Erase files each new sweep - Selecting this option will erase the data after each sweep. If this option is not checked, the data from each sweep will continue to be appended to the output data file which can create a very large file size (and fill the disk, with many unwanted consequences).

File name prefix - The receiver selected in Export receivers will be appended to the prefix name specified in this field with either ".txt" if a text file is exported or ".bin" if a binary file is exported. For example, if C:\Temp\SA_DATA_OUT is entered into the **File name prefix** field and the "B" receiver data is exported to a text file, the data will be exported to a file called SA_DATA_OUT_B.txt .

Record size (bytes) - This is the byte size of binary data output.

Export markers - Adds marker data to the text file (*.txt) output.

Export to FIFO buffer - Exports data to the FIFO (First-IN, First-OUT) data buffer . FIFO is a circular buffer that allows very fast Read-Write access.

Export to shared memory - Exports data to shared memory (Microsoft Windows feature) which is the fastest way to transfer data between applications. The application that is retrieving data has to register itself to Microsoft Windows with the same share name.

Share name - Assigns a specified name to the shared data.

In the SA Setup Source Tab (above):

> When (Sweep) Type = **CW** , set the CW Frequency.

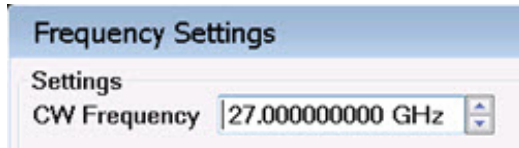

> When (Sweep) Type = **Linear** , the following dialog appears:

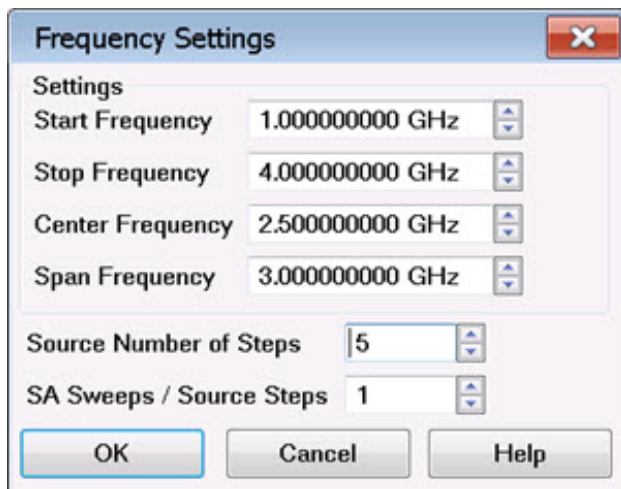

Settings

Sets the source frequency range. Use either of the following pairs of settings to set the frequency range.

Start /Stop - Specifies the beginning and end frequency of the swept range.

Center /Span - Specifies the value at the center and frequency range.

Source Number of Steps - Sets the number of steps the source will make across the specified source frequency range.

SA Sweeps / Source Step - Sets the number of SA (receiver) sweeps for each Source Step. This setting is common to all sources.

In the SA Setup Source Tab (above):

> When (Sweep) Type = **CW**, or **LinFreq** , set the power level.

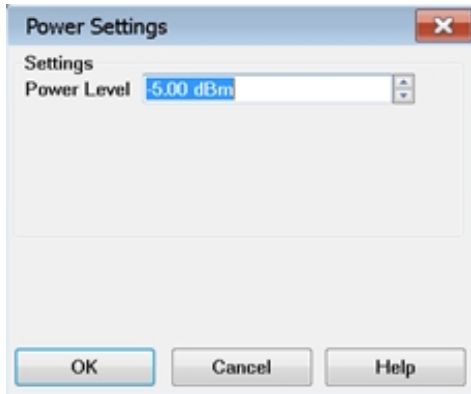

> When (Sweep) Type = **Power** or **LinF+Pwr** , the following dialog appears:



Settings

Sets the source power range. Use either of the following pairs of settings to set the power range.

Start /Stop - Specifies the beginning and end power of the swept range.

Center /Span - Specifies the value at the center and power range.

Source Number of Steps - Sets the number of steps the source will make across the specified source power range.

SA Sweeps / Source Step - Sets the number of SA (receiver) sweeps for each Source Step. This setting is common to all sources.

Measurement Parameters

How to select and configure Measurement Parameters

Using **Hardkey** / **SoftTab** / **Softkey**

1. Select a trace by pressing **Trace** > **Trace N** > **Trace N** .
2. Press **Trace** > **Trace Setup** > **Measure...** .
3. Select a parameter.

Using a mouse

1. Right-click on a trace.
2. Select a parameter

Measure Dialog

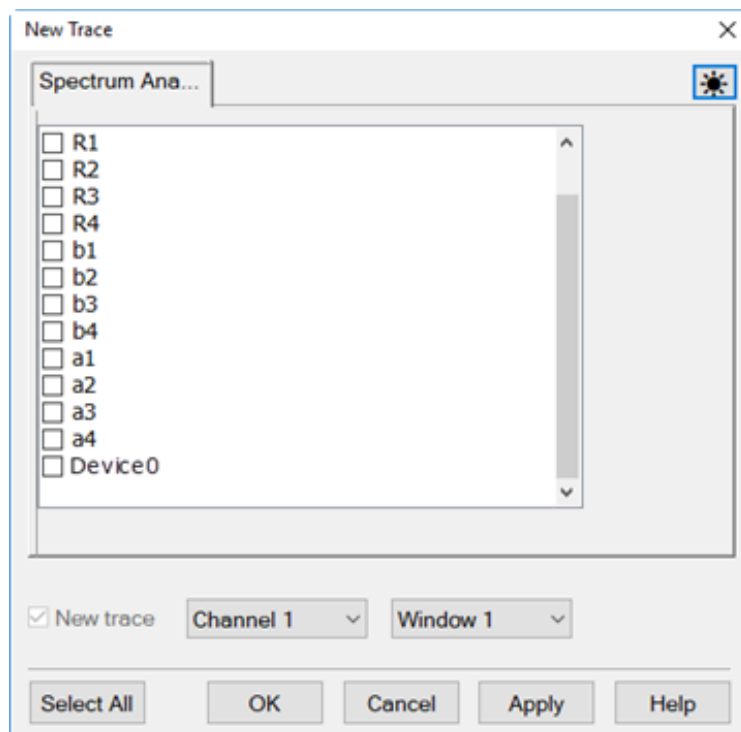

Select one of the test port receivers to make a measurement. Test ports are identified in both traditional VNA notation and Receiver Notation. Learn more .

Or select an ImageReject measurement, if the Display Image Reject Traces checkbox has been set.

New Trace - Add a new trace.

Channel N - Select a channel number for the new SA trace.

Window N - Select to create the new trace in an existing window or new window.

Select All - Select all measurement parameters.

Note: Configuring an external DC meter for a SA channel is supported. DC is read at the end of a sweep. Only one point is read and the entire trace is filled with this point reading regardless of the number of channel points.

SA Markers

Programming Commands

The following marker-related features are unique to SA.

Marker -> SA

This feature is supported in Standard, SMC or Swept IMD measurement classes (channels) ONLY. In this section, these are called **NA** channels.

On a standard channel with a marker residing on a trace in an NA channel, Marker -> SA creates a new SA channel in full frequency span. Refer to the following for swept IMD and SMC:

Swept IMD: $\text{span} = 10 * \text{delta frequency}$

SMC: SA channel uses receiver frequency range

A marker is created on the trace at the same frequency as the NA channel marker. This is a quick way to see the frequency spectrum of the NA channel at a specific frequency.

- The same source that is used for the trace in the NA channel is turned ON in the SA channel in CW mode at the marker frequency.
- The same receiver that is used for the NA channel is used for the SA channel.
- For each new NA channel, a new SA channel is created. Subsequent markers in the same NA channel use the same SA channel.
- In general, Marker -> SA creates a new measurement on the SA channel only if the measurement does not already exist. For example, if a marker is used on an S11 measurement in a standard channel, Marker -> SA creates a measurement using test receiver "A" with port 1 as the source. If Marker -> SA on an S12 measurement is then performed, the same test receiver "A" is used except that port 2 becomes the source. In this case, a new SA trace will not be created.

How to use Marker =>SA

With a marker residing on a trace in a standard channel...

- With a mouse: Right-click on a marker, then select **Functions** , then **Marker -> SA** .
- With a keyboard: With the relevant marker active (selected), **Alt+M, F, A** .
- Without mouse or keyboard: With the relevant marker active (selected), Press **Marker** , **Marker -> Functions** , then **Marker -> SA** .

Band Markers

The following marker types provide a readout of the total power, noise, or density within a selectable frequency span. The span is marked by vertical posts that appear on either side of the marker.

- **Band Power** - These markers provide a readout of the total power within a specified frequency span defined by Band Span.
- **Band Density** - Select **Off** , **Noise** (dBm/Hz), **Power** (dBm/Hz), or **Tone** (dBm/Tone).
 - **Noise** density is calculated over the frequency span defined by Band Span.
 - **Power** density is calculated over the frequency span defined by Band Span and is normalized to the bandwidth defined by Density BW. This feature is useful for measuring a wide band signal with a notch (or with multiple notches) but normalize to a narrower bandwidth because there is no power in the notches. The notch power readings are subtracted from the band power reading making this feature useful for Noise Power Ratio measurements.
 - **Tone** density is calculated the same as Power density, but is normalized to the tone spacing frequency rather than 1 Hz.

Band Power and Band Density Noise Markers

Note: If a Band Power or Band Density Noise marker is selected, Discrete mode is turned OFF to allow precise measurements over the desired frequency range.

The span is marked by vertical dotted lines that appear on either side of the marker. The marker's y-axis value is set to the measured power value.

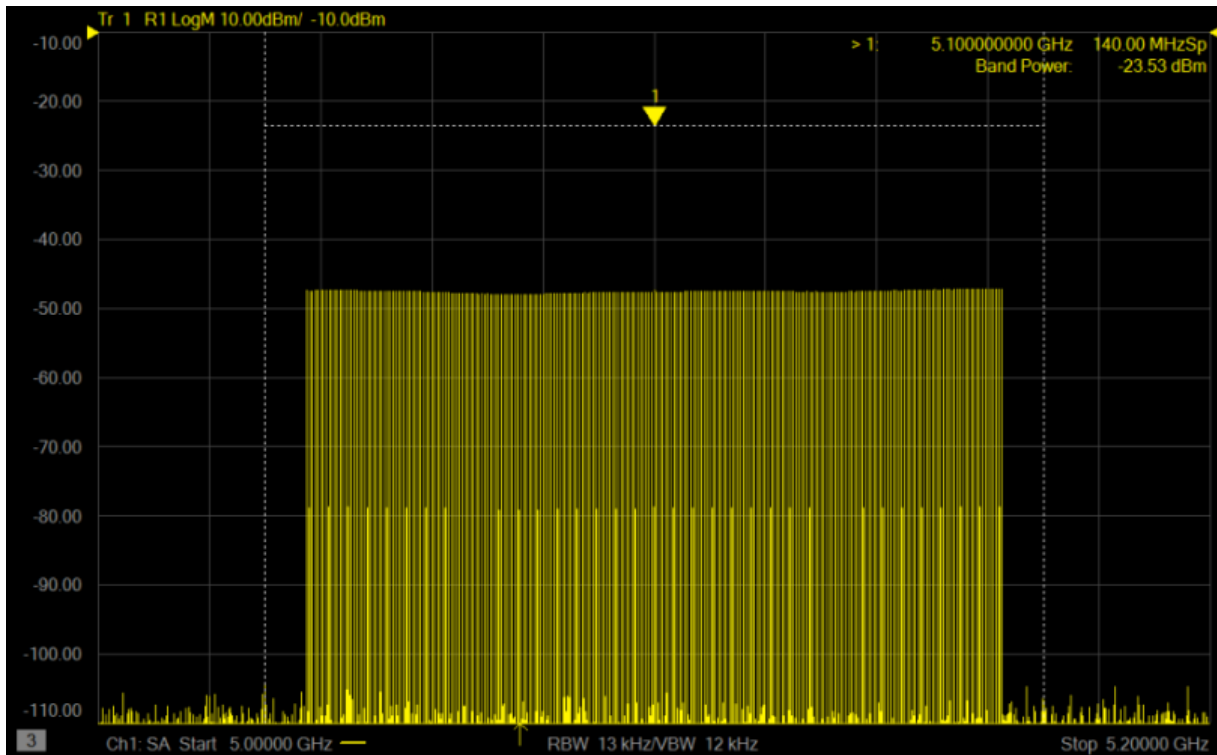

If a Band Power or Band Density Noise marker is in Delta mode , the difference between the Band Power or Band Noise marker and the reference marker is displayed with a leading delta symbol.

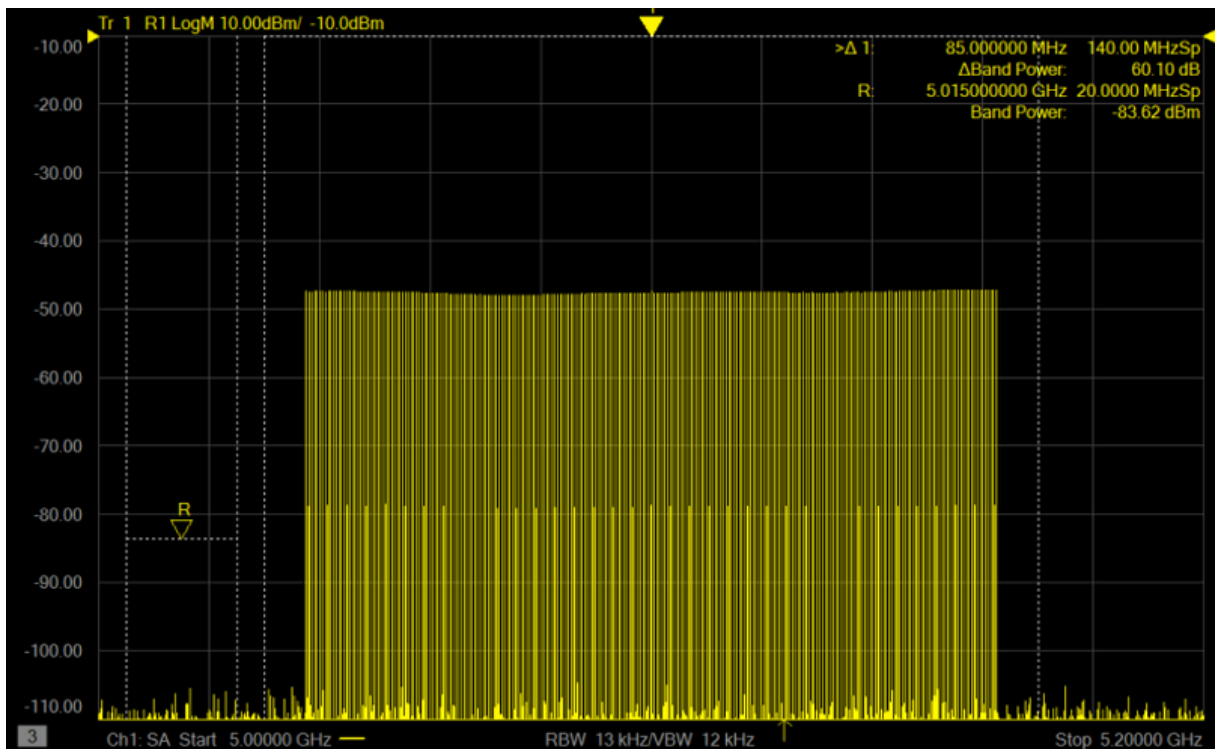

Band Density Power Markers

The **? 1** marker displays the notch frequency relative to the center frequency. In this example the notch is in the center so the frequency is 0 Hz. Also displayed is the notch span (100 MHz).

The **?Tones** is the difference between the average tone power at the Reference (**> R**) marker and the average tone power at the bottom of the notch.

The **> R** marker displays the center frequency (16 GHz) and the signal span (1.5 GHz).

The **Band Power** displays the total power within the signal span.

The **Tones (1.40 GHz)** displays the average tone power across the 1.5 GHz signal span minus the average tone power across the notch (1.5 GHz - 100 MHz = 1.4 GHz)

The total modulation span defined by Band Span is marked by the outer vertical dotted lines.

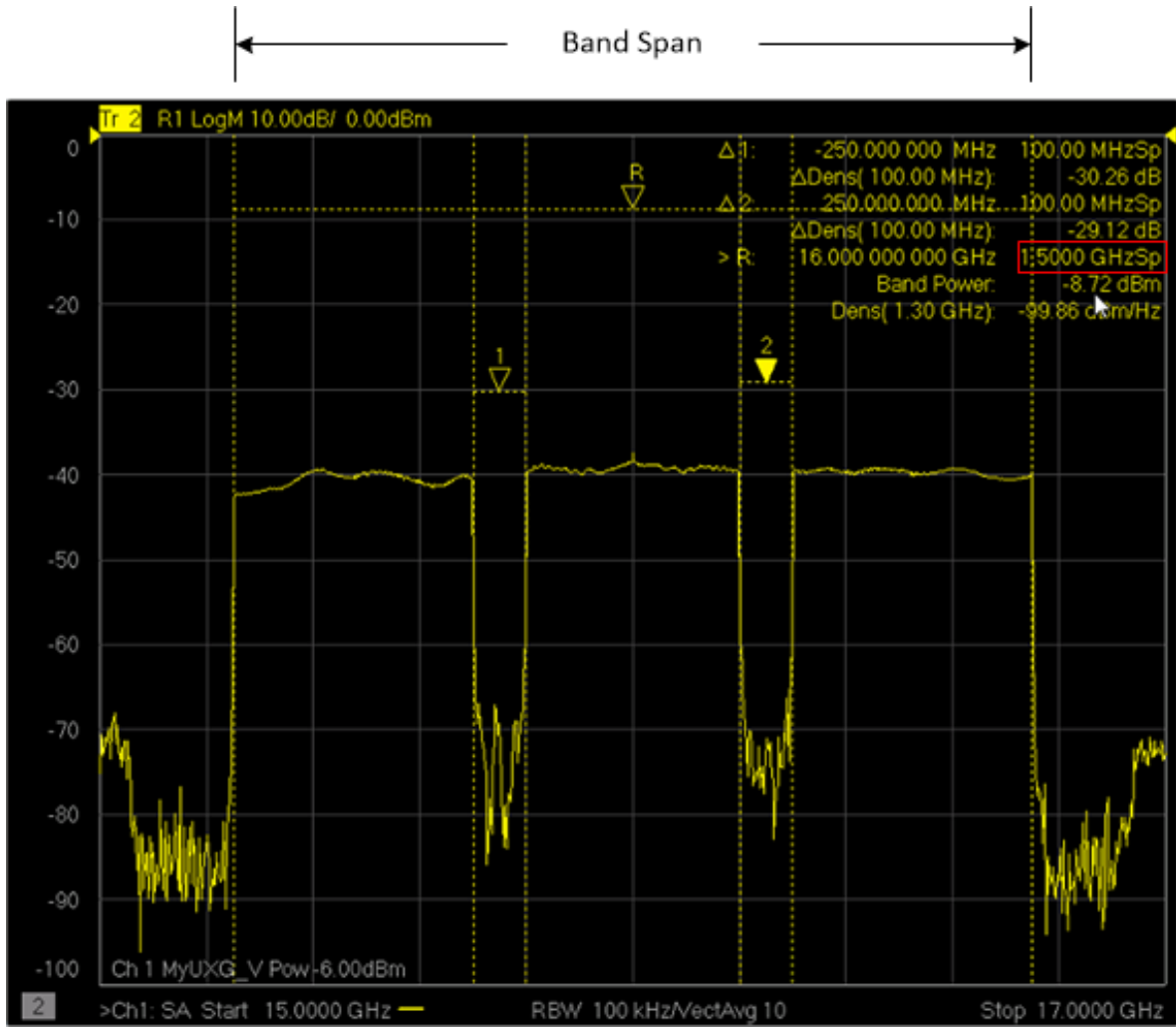

Each notch is also marked with vertical dotted lines defined by Density BW.

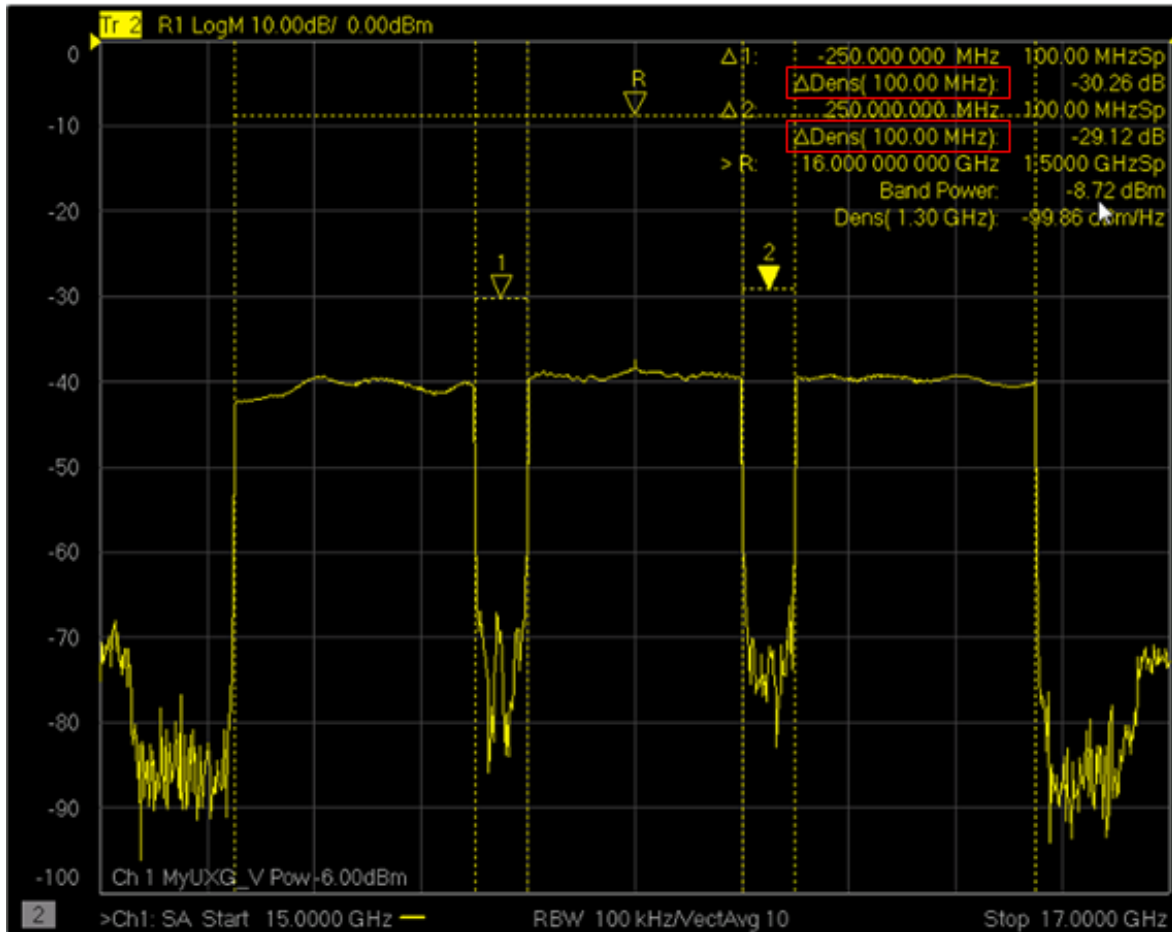
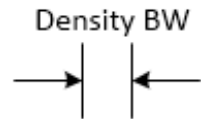

How to select Band Markers

1. Press **Marker** > **SA Analysis** .
2. Another method of selecting band markers is to right-click on a marker on the display then select **Search...** from the menu. The following dialog appears:



3. For information on the settings for different SA search types, refer to SA Analysis Markers .

If a Band Power or Band Noise measurement cannot be made, the marker readout will display -999 dBm (for Band Power), or -999 dBm/Hz (for Band Noise). There are two reasons why this may happen:

1. The band span (from marker frequency – span/2 to marker frequency + span/2) is outside the frequency range of the channel.
2. The Band Power or Noise marker was created while the channel was in Hold mode. At least one sweep must be taken after creating such a marker. The marker can be moved taking a sweep while in Hold mode. However, the marker readout will not change. To update the marker readout to the new marker location, a re-sweep is required.

Occupied BW Ratio

The Occupied BW Ratio is the frequency band in the measurement that contains a specific percentage of the total power in the measured frequency span. The marker readout provides the occupied band center frequency, percentage of the band span to measure, and the occupied band power. See also Occupied BW search min for setting the minimum frequency to start a search.

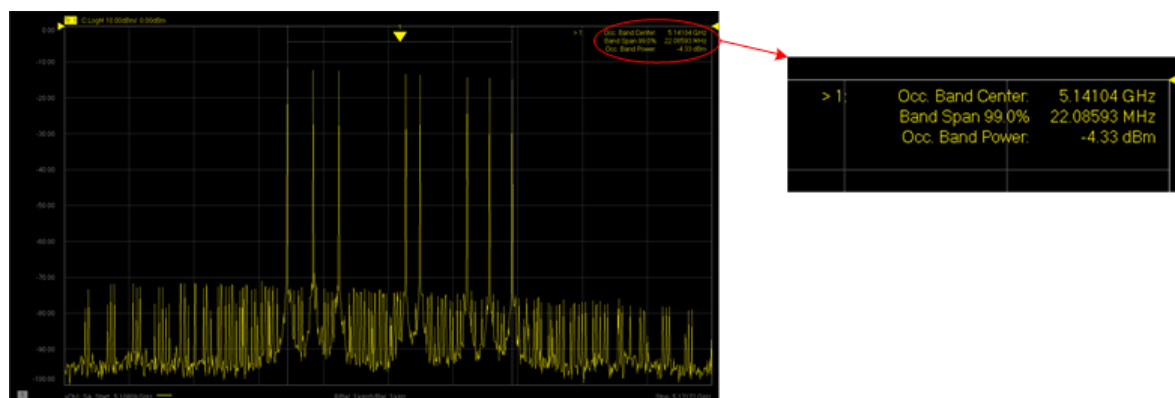

The span is marked by vertical dotted lines that appear on either side of the marker indicating the percentage of span. The marker's y-axis value is set to the measured power value.

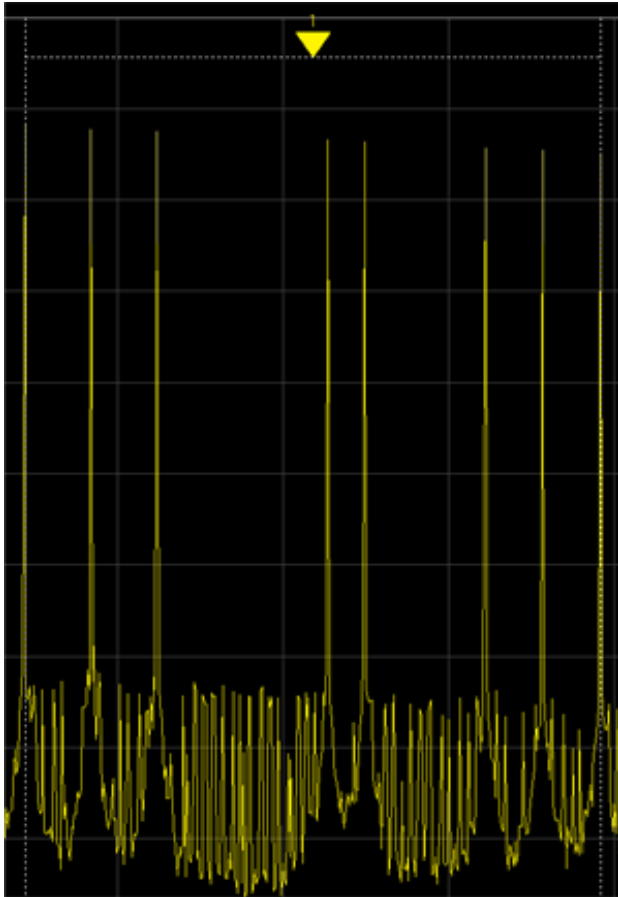

How to select Occupied BW Ratio

1. Select one of three ways to enable Occupied BW Ratio:
 - a. Move the cursor on a marker, right-click on the marker, select **Search** , then **Occupied BW** .
 - b. Press **Marker** , then **SA Analysis** , then **Occupied BW ON** .
 - c. Select **Response** , then **Search...**

The following dialog appears

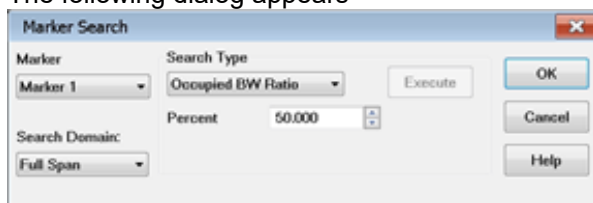

2. If the **Marker Search** dialog is used, perform the following steps:
 - a. Select an existing marker.
 - b. For **Search Type** , select **Occupied BW Ratio** .
 - c. For **Percent** , enter a percentage of the band span to search.
 - d. For **Search Domain** , either select **Full Span** (default) or define a **User Span** by selecting **User N** then specifying the **Start** and **Stop** frequencies.
 - e. Click **OK** .

Calibrating an SA Channel

A calibration can be performed on the SA Channel using the Cal All Wizard when corrected results are required to improve amplitude accuracy.

Note: Calibration is performed over the currently specified spectrum analyzer frequency range only.

Another method of calibration is to import an existing Cal Set. An imported Cal Set must contain the Receiver Response terms for the measurement port on the SA channel. In addition, if the imported Cal Set covers a narrower frequency range than the SA channel, the error terms in the imported Cal Set are extrapolated.

The Cal Plane Manager can be used to characterize adapters, cables, and fixtures used to connect a DUT to the VNA to remove their effects from the measurement. See the detailed procedure.

SA Warning Messages

Warning messages appear when the measurement cannot be performed with the current settings. Messages are displayed in blue for three seconds and the channel is placed in hold (not sweeping).

SA Warning: Image Reject Max and Better are not allowed if $RBW > 1\text{MHz}$ and Narrow IF Filter.

SA Warning: Image Reject Max is not allowed if $RBW > 1\text{MHz}$.

SA Warning: Image Reject Better is not allowed if $RBW > 2\text{MHz}$.

SA Warning: Image Reject Max and Better are not allowed below 20 MHz if $RBW > 1\text{MHz}$ and Wide IF Filter.

SA Warning: Cannot run Image Reject None LO High at high end of RF frequencies.

SA Warning: Cannot run Image Reject None LO Low at low end of RF frequencies.

SA Warning: Cannot force Narrow IF Filter if $RBW > 1\text{MHz}$.

Time Domain

Note: Time Domain measurements are only available on analyzers with S9x010A or Option 010. See [Configurations](#)

Time Domain allows you to view a device response as a function of time. The following are discussed in this topic:

- [Overview](#)
- [How the Analyzer Measures in the Time Domain](#)
- [Calibration for Time Domain](#)
- [Transmission Measurements](#)
- [Measurement Response Resolution](#)
- [Measurement Range and Alias Responses](#)
- [How to make Time Domain Settings](#)
- [Gating](#)
- [Advanced Settings](#)

See the updated **App Note:** [Time Domain Analysis Using a Network Analyzer](#).

Overview

In normal operation, the analyzer measures the characteristics of a test device as a function of frequency. With Time Domain (opt S9x010A, 010), the frequency information is used to calculate the inverse Fourier transform and display measurements with time as the horizontal display axis. The response values appear separated in time, allowing a different perspective of the test device's performance and limitations.

The graphic below compares the same cable reflection measurement data in both the frequency and time domain. The cable has two bends. Each bend creates a mismatch or change in the line impedance.

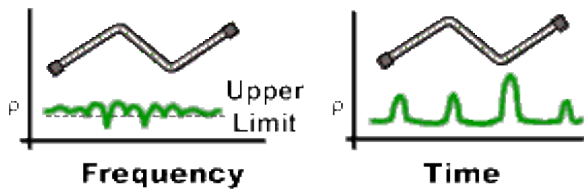

- The frequency domain S11 measurement shows reflections caused by mismatches in the cable. It is impossible to determine where the mismatches physically occur in the cable.
- The time domain response shows both the location and the magnitude of each mismatch. The responses indicate that the second cable bend is the location of a significant mismatch. This mismatch can be **gated out**, allowing you to view the frequency domain response as if the mismatch were not present. Distance Markers can be used to pinpoint the distance of the mismatch from the reference plane.

How the Analyzer Measures in the Time Domain

Time domain transform mode simulates traditional Time-Domain Reflectometry (TDR), which launches an impulse or step signal into the test device and displays the reflected energy on the TDR screen. By analyzing the magnitude, duration, and shape of the reflected waveform, you can determine the nature of the impedance variation in the test device.

The analyzer does not launch an actual incident impulse or step. Instead, a Fourier Transform algorithm is used to calculate time information from the frequency measurements. The following shows how this occurs.

A single frequency in the time domain appears as a sine wave. In the following graphic, as we add the fundamental frequency (F_0), the first harmonic ($2F_0$), and then the second harmonic ($3F_0$), we can see a pulse taking shape in the Sum waveform. If we were to add more frequency components, the pulse would become sharper and narrower. When the analyzer sends discrete frequencies to the test device, it is in effect, sending individual spectral pieces of a pulse separately to stimulate the test device.

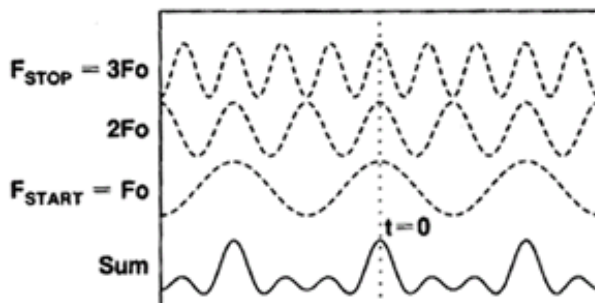

During an S11 reflection measurement, these incident signals reflect from the test device and are measured at the A receiver. This is when the time domain transform calculations are used to add the separate spectral pieces together.

For example, consider a short length of cable terminated with an open. All of the power in the incident signal is reflected, and the reflections are 'in-phase' with the incident signal. Each frequency component is added together, and we see the same pattern as the simulated incident would have looked (above). The magnitude of the reflection is related to the impedance mismatch and the delay is proportional to the distance to the mismatch. The x-axis (time) scale is changed from the above graphic to better show the delay.

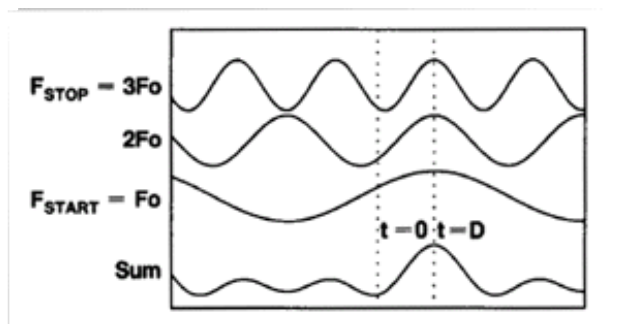

Alternately, the same cable terminated with a short also reflects all of the incident power, but with a phase shift of 180 degrees. As the frequency components from the reflection are added together, the sum appears as a negative impulse delayed in time.

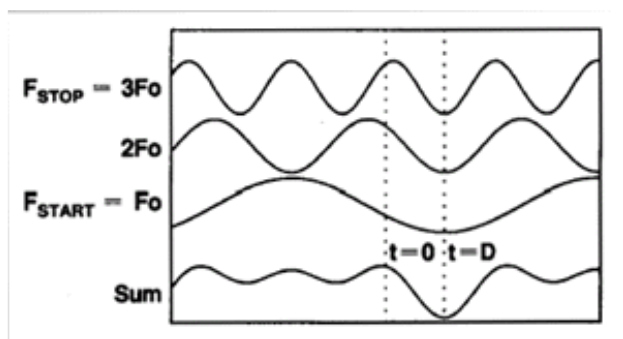

Calibration for Time Domain

For simplicity, we have discussed incident signals reflecting off discontinuities in the test device. By far the most common network analyzer measurement to transform to time domain is a **ratioed S11** measurement. An S11 reflection measurement does not simply display the reflections measured at the A receiver - it displays the ratio (or difference) of the A receiver to the Reference receiver. In addition, the S11 measurement can also be calibrated to remove **systematic errors** from the ratioed measurement. This is critical in the time domain as the measurement plane, the point of calibration, becomes zero on the X-axis time scale. All time and distance data is presented in reference to this point. As a result, both magnitude and time data are calibrated and very accurate.

The following shows where the time domain transform occurs in the analyzer data flow: (see [Data Access Map](#))

1. Acquire raw receiver (A and R1) data
2. Perform ratio (A/R1)
3. Apply calibration
4. Transform data to time domain
5. Display results

Therefore, although a time domain trace may be displayed, a calibration is always performed and applied to the frequency domain measurement which is not displayed.

Transmission Measurements

The most common type of measurement to transform is an S11 reflection measurement. However, useful information can be gained about a test device from a transformed S21 transmission measurement. The frequency components pass through the test device and are measured at the B receiver. If there is more than one path through the device, they would appear as various pulses separated in time.

For example, the following transmission measurement shows multiple paths of travel within a Surface Acoustic Wave (SAW) filter. The largest pulse (close to zero time) represents the propagation time of the shortest path through the device. It may not be the largest pulse or represent the desired path. Each subsequent pulse represents another possible path from input to output.

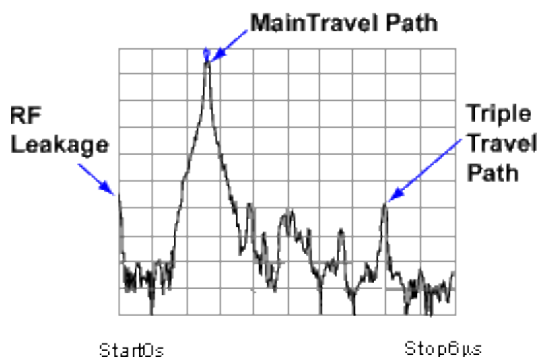

Triple travel is a term used to describe the reflected signal off the output, reflected again off the input, then finally reappearing at the output. This is best seen in a time domain S21 measurement.

Measurement Response Resolution

In the previous paragraphs, we have seen that using more frequency components causes the assembled

waveform to show more detail. This is known as measurement response resolution, which is defined as the ability to distinguish between two closely spaced responses.

Note: Adjusting the **transform time settings** improves **display** resolution, but not measurement resolution.

The following graphic shows the effect of both a narrow and wide frequency span on the response resolution. The wider frequency span enables the analyzer to resolve the two connectors into separate, distinct responses.

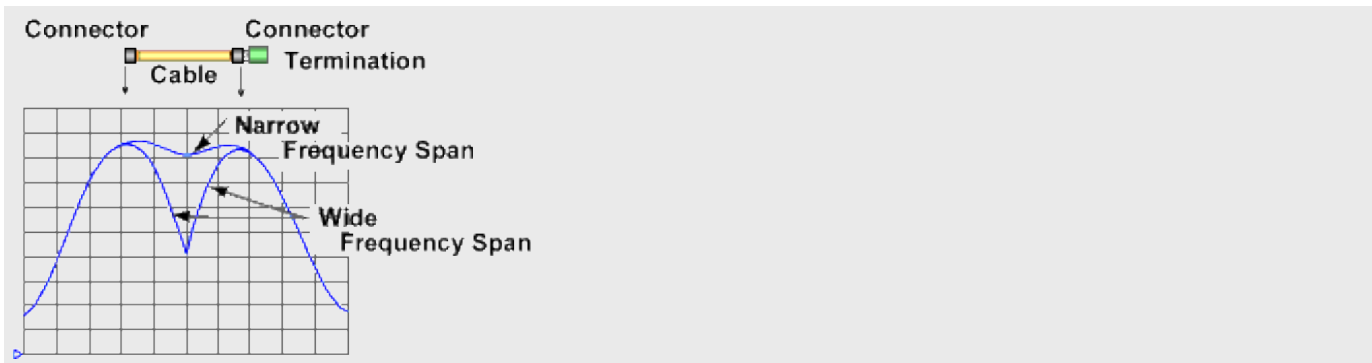

Resolution Formula

For responses of equal amplitude, the response resolution is equal to the 50% (-6 dB) points of the impulse width, or the step rise time which is defined as the 10 to 90% points as shown in the following image.

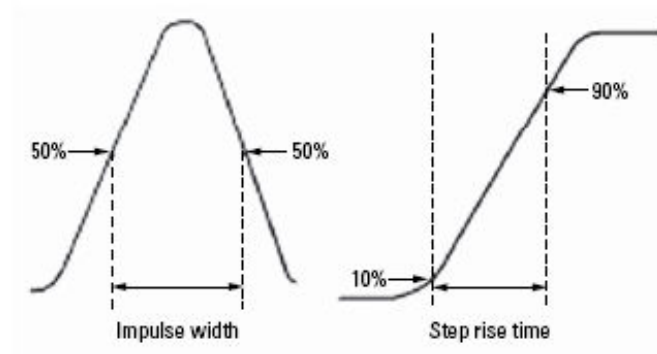

The following table shows the **approximated** relationship between the frequency span and the window selection on response resolution for responses of equal amplitude.

Window	Low-pass step (10% to 90%)	Low-pass impulse (50%)	Bandpass impulse
Minimum	0.45 / f span	0.60 / f span	1.20 / f span
Normal	0.99 / f span	0.98 / f span	1.95 / f span
Maximum	1.48 / f span	1.39 / f span	2.77 / f span

For example, using a 10 GHz wide frequency span and a normal window in Bandpass impulse mode, response resolution (in time) equals:

- Time Res = 1.95 / frequency span
- Time Res = 1.95 / 10 GHz
- Time Res = 195 ps

To calculate the physical separation (in distance) of the responses which can be resolved, multiply this value times the speed of light (c) and the relative velocity (Vf) of propagation in the actual transmission medium. In this case, Vf = 0.66 for polyethylene dielectric.

- Distance Res = 195 ps x c x Vf
- Distance Res = 195 ps x (2.997925 E8 m/s) x .66
- Distance Res = 38 mm

For reflection measurements, because of the 2-way travel time involved, this means that the minimum resolvable separation between discontinuities is half of this value or 19 mm.

Although a wider frequency span causes better measurement resolution, the **measurement range** becomes limited. Also, increasing the frequency range can cause a measurement calibration to become invalid. Be sure to adjust the frequency span BEFORE performing a calibration.

Measurement Range and Alias Responses

Measurement range is the length in time in which true time domain responses can be seen. The measurement range should be large enough to see the entire test device response without encountering a repetition (alias) of the response. An alias response can hide a true time domain response.

To increase measurement range in both modes, change either of these settings:

- Increase the number of points

- Decrease the frequency span

Notes:

- After making these settings, you may need to adjust the **transform time settings** to see the new measurement range.
- Decreasing the frequency span degrades **measurement resolution**.
- Make frequency span and number of points settings BEFORE calibrating.
- Maximum range also depends on loss through the test device. If the returning signal is too small to measure, the range is limited regardless of the frequency span.

Alias Responses

An alias response is not a true device response. An alias response repeats because each time domain waveform has many periods and repeats with time (see **How the Analyzer Measures in the Time Domain**). Alias responses occur at time intervals that are equal to 1/ frequency step size.

The analyzer adjusts the **transform time settings** so that you should only see one alias free range on either side (positive and negative) of zero time. However, these settings are updated only when one of the toolbar settings are changed.

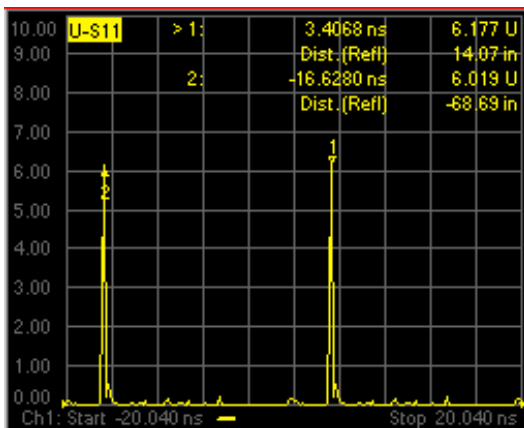

To determine if a response is true, put a marker on the response and change the frequency span. A true device response will not move in time. An alias response will move.

For example, in the above graphic, the marker 1 response occurs at 14.07 inches. When the frequency span is changed, this response remains at 14.07 inches. The marker 2 response moves.

Range Formula

You can calculate the alias-free measurement range (in meters) of the analyzer using the following

formula for **TDR** (reflection) measurements:

$$\text{Range (meters)} = (1/\Delta f) \times V_f \times c$$

Where:

- Δf = frequency step size (frequency span/number of points-1)
- V_f = the velocity factor in the transmission line
- c = speed of light = 2.997925 E8 m/s

For example: For a measurement with 401 points and a span of 2.5 GHz, using a polyethylene cable ($V_f = 0.66$)

- Range = $(1 / (2.5E9 / 400)) \times 2.997925 \text{ E8 m/s} \times 0.66$
- Range = $6.25E6 \times 2.997925 \text{ E8 m/s} \times 0.66$
- Range = 32 meters

In this example, the range is 32 meters in physical length. To prevent the time domain responses from overlapping or aliasing, the test device must be 32 meters or less in physical length for a transmission measurement.

To calculate the one-way distance for a reflection measurement rather than round-trip distance, simply divide the length by 2. In this case, the alias-free range would be 16 meters.

How to make Time Domain Settings

Using **Hardkey/SoftTab/Softkey**

1. Press **Math** > **Time Domain** > **Time Domain Setup...**

Programming Commands

Transform dialog box help

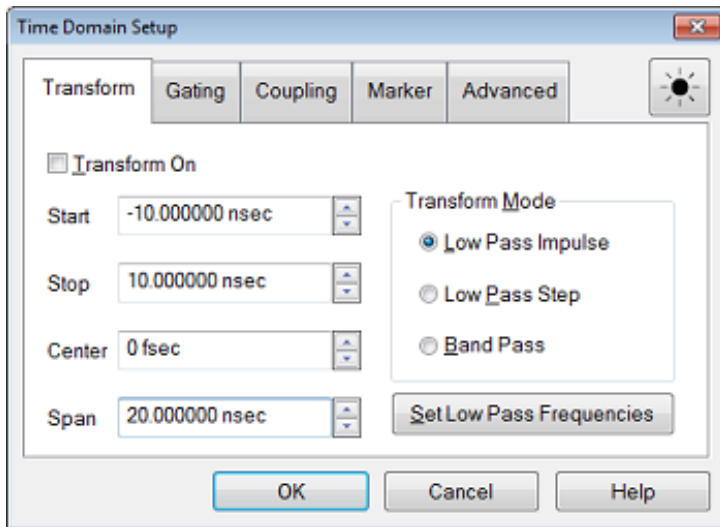

Transform On Turns time domain transform ON and OFF.

Time Settings

The following settings adjust the **display resolution**, allowing you to zoom IN or OUT on a response. They do NOT adjust **measurement range** or **measurement resolution**.

These settings automatically update (when one of these values are updated) to limit the display to one **alias-free response** on either side of zero time.

Start Sets the transform start time that is displayed on the analyzer screen.

Note: Zero (0) seconds is always the **measurement reference plane**. Negative values are useful if moving the reference plane.

Stop Sets the transform stop time that is displayed on the analyzer screen.

Center Sets the transform center time that is displayed in the center of the analyzer screen.













Span Sets the transform span time that is split on either side of the Center value.

Transform Mode

Transform modes are three variations on how the time domain transform algorithm is applied to the frequency domain measurement. Each method has a unique application.

Mode	Benefit - application	Limitation
Low pass Impulse	Highest resolution. Most useful for seeing small responses in devices that pass low frequencies, such as cables.	In both Low pass modes, frequencies down to DC and negative frequencies are extrapolated. Therefore, the Start frequency is adjusted when you click Set Freq.Low Pass Because this will affect calibration accuracy, be sure to calibrate AFTER completely setting up your time domain measurement.
Low pass Step	Easiest to identify inductive and capacitive discontinuities in devices that pass low frequencies, such as cables.	
Band pass Impulse	Easiest method - can be used with any frequency sweep. Most useful for measuring band limited devices such as filters and DC blocked cables.	Does NOT show capacitive and inductive reactance For the same frequency span and number of points, band pass mode has twice the impulse width, which hides closely spaced responses degrading the response resolution.

The following chart shows how to interpret results from various discontinuity impedances using Low pass Step and either Low pass or Band pass Impulse modes.

IMPEDANCE	STEP RESPONSE	IMPULSE RESPONSE
OPEN	 Unity Reflection	 Unity Reflection
SHORT	 Unity Reflection = 180	 Unity Reflection = 180
RESISTOR $R > Z_0$		
RESISTOR $R < Z_0$		
INDUCTOR		
CAPACITOR		

Effect on Measurement Range

Band pass mode - measurement range is inversely proportional to frequency step size.

Low pass mode - measurement range is inversely proportional to the fundamental (start) frequency AFTER clicking Set Freq. Low Pass.

Set Low Pass Frequencies USE ONLY IN LOW PASS MODES

Recomputes the start frequency and step frequencies to be harmonics of the start frequency. Start frequency is computed by the following formula: **Low Pass Start Frequency = Stop Frequency / Number of points.**

The computed value must always be greater than or equal to the analyzer's minimum frequency.

Note: The number of points or stop frequency may be changed in order to compute this value.

Gating

Perhaps the most beneficial feature of time domain transform is the Gating function. When viewing the time domain response of a device, the gating function can be used to "virtually" remove undesired responses. You can then simultaneously view a frequency domain trace as if the undesired response did not exist.. This allows you to characterize devices without the effects of external devices such as connectors or adapters.

Note: When a discontinuity in a test device reflects energy, that energy will not reach subsequent discontinuities. This can "**MASK**", or hide, the true response which would have occurred if the previous discontinuity were not present. The analyzer Gating feature does NOT compensate for this.

The following measurements images show a practical example how to use and perform gating. The test device is a 10inch cable, then a 6 dB attenuator, terminated with a short. The following four discontinuities are evident in window 2, from left to right:

1. A discontinuity in the test system cable which appeared after calibration. It is identified by marker 2 at -10.74 inches (behind the reference plane).
2. A discontinuity in the 10 inch device cable shortly after the reference plane.
3. The largest discontinuity is the attenuator and short shown by marker 1 at -12.67 dB (6 dB loss in both forward and reverse direction).
4. The last discontinuity is a re-reflection from the device cable.

We will gate IN the attenuator response. All other responses will be gated OUT.

Window 1. Create original S11 frequency domain trace. Shows ripple from all of the reflections.

Window 2. Create a new S11 trace - same channel; new window. Turn Transform ON.

Window 3. On the transformed trace, turn gating ON. Center the gate on the large discontinuity (2.500ns). Adjust gate span to completely cover the discontinuity. Select Bandpass gating type.

Window 4. On the original frequency measurement, turn Gating ON (Transform remains OFF). View the measurement without the effects of the two unwanted discontinuities. The blue trace is a measurement of the 6 dB attenuator with the unwanted discontinuities PHYSICALLY removed. The difference between the two traces in window 4 is the effect of "masking".

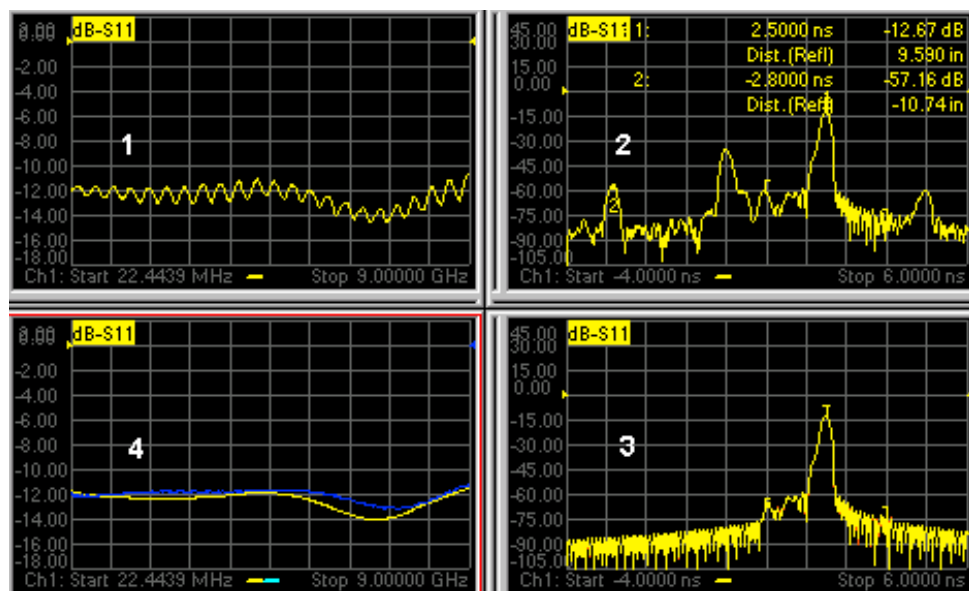

Learn how to launch the Transform dialog box

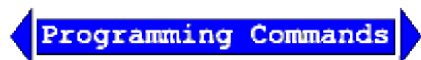

Transform Gating dialog box help

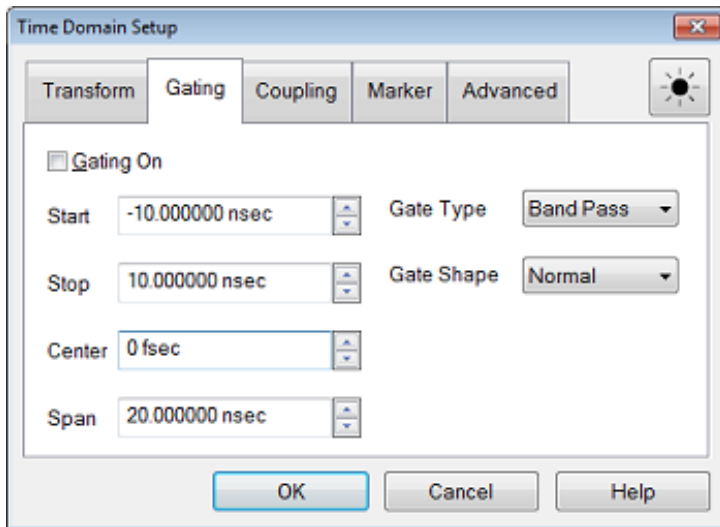

Gating Turns Gating ON and OFF.

Start Specifies the start time for the gate.

Stop Specifies the stop time for the gate.

Center Specifies the value at the center of the area that is affected by the gating function. This value can be anywhere in the analyzer range.

Span Specifies the range to either side of the center value of area that is affected by the gating function.

Gate Type Defines the type of filtering that will be performed for the gating function. The gate start and stop flags on the display point toward the part of the trace you want to keep.

- **Bandpass** - KEEPS the responses within the gate span.
- **Notch** - REMOVES the responses with the gate span.

Gate Shape Defines the filter characteristics of the gate function. Choose from Minimum, Normal, Wide, Maximum

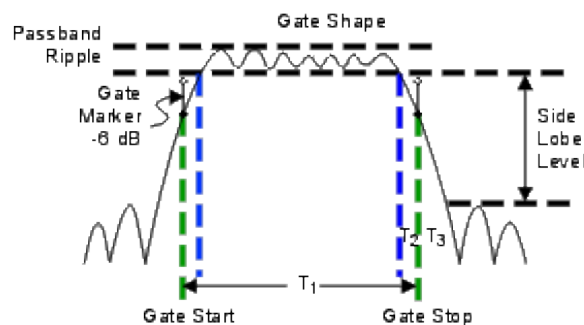

Gate Shape	Passband Ripple	Sidelobe Levels	Cutoff Time	Minimum Gate Span
Minimum	±0.1 dB	-48 dB	1.4/Freq Span	2.8/Freq Span
Normal	±0.1 dB	-68 dB	2.8/Freq Span	5.6/Freq Span
Wide	±0.1 dB	-57 dB	4.4/Freq Span	8.8/Freq Span
Maximum	±0.01 dB	-70 dB	12.7/Freq Span	25.4/Freq Span

Cutoff time -- is the time between the stop time (-6 dB on the filter skirt) and the peak of the first sidelobe. The diagram below shows the overall gate shape and lists the characteristics for each gate shape.

- T₁ is the gate span, which is equal to the stop time minus the start time.
- T₂ is the time between the edge of the passband and the 6 dB point, representing the cutoff rate of the filter.
- T₃ is the time between the 6 dB point and the edge of the gate stopband.
- For all filter shapes T₂ is equal to T₃, and the filter is the same on both sides of the center time.

Minimum gate span -- is twice the cutoff time. Each gate shape has a minimum recommended gate span for proper operation. This is a consequence of the finite cutoff rate of the gate. If you specify a gate span that is smaller than the minimum span, the response will show the following effects:

- distorted gate shape that has no passband
- distorted shape
- incorrect indications of start and stop times
- may have increased sidelobe levels

To launch the Coupling dialog box, click Coupling tab on the **Time Domain Setup** dialog box.

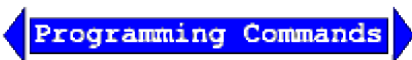

Trace Coupling Settings dialog box help

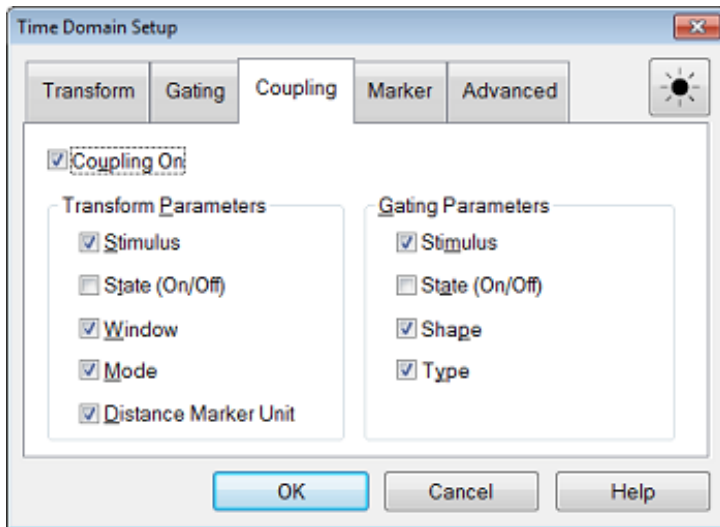

Trace coupling allows you to change time domain parameters on a measurement, and have the same changes occur for all other measurements in the channel.

For example:

If you are simultaneously viewing a frequency domain measurement and time domain measurement,

and **Coupling** is enabled in this dialog box,

and ALL **Gating Parameters** are checked in this dialog box,

and on the time domain measurement you change the **Gate Span** parameter,

Then the frequency domain measurement will automatically change to reflect the time domain gated span.

Note: Trace coupling applies ONLY to the Y-axis scale/reference settings. There are no changes to your data as a result of trace coupling.

Coupling On Check to enable coupling. All of the measurements in the active channel are coupled.

The following parameters are available for coupling:

Transform Parameters

Stimulus Start, Stop, Center, and Span TIME settings.

State (On/Off) Transform ON and OFF

Window Kaiser Beta / Impulse Width

Mode Low Pass Impulse, Low Pass Step, Band Pass

Gating Parameters

Stimulus Start, Stop, Center, and Span TIME settings.

State (On/Off) Gating ON and OFF

Shape Minimum, Normal, Wide, and Maximum

Type Bandpass and Notch

To launch the Distance marker dialog box, click **Dist. Marker Settings** on the **Transform** dialog box.



Distance Marker Settings dialog box help

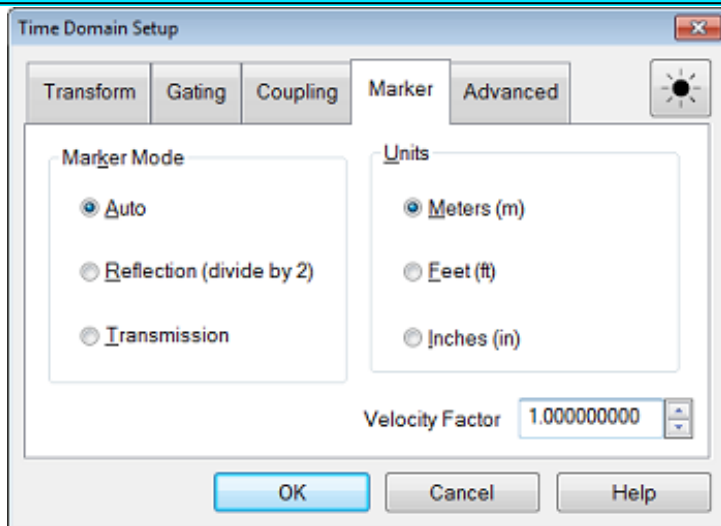

When markers are present on a time domain measurement, distance is automatically displayed on the marker readout, **marker table**, and **print copy**. To learn how to create markers on your measurement see **marker settings**.

You can read out impedance versus time by creating a marker on a Time Domain trace, then changing the marker format to R+jX. **Learn how**.

This dialog box allows you to customize the time domain distance marker readings.

These settings affect the display of ALL markers for only the ACTIVE measurement (unless **Distance Marker Unit** is coupled on the [Trace Coupling dialog box](#)).

Marker Mode Specifies the measurement type in order to determine the correct marker distance.

- Select **Auto** for [S-Parameter](#) measurements.
- Select **Reflection** or **Transmission** for [arbitrary ratio](#) or [unratioed](#) measurements.

Auto If the active measurement is an S-Parameter, automatically chooses reflection or transmission. If the active measurement is a non S-Parameter, reflection is chosen.

Reflection Displays the distance from the source to the receiver and back divided by two (to compensate for the return trip.)

Transmission Displays the distance from the source to the receiver.

Units Specifies the unit of measure for the display of marker distance values.

Velocity Factor Specifies the velocity factor that applies to the medium of the device that was inserted after the measurement calibration. The value for a polyethylene dielectric cable is 0.66 and 0.7 for PTFE dielectric. 1.0 corresponds to the speed of light in a vacuum. This is useful in Time Domain for accurate display of time and distance markers.

This setting can also be made from the [Electrical Delay](#) and [Port Extensions](#) dialog boxes.

Advanced Settings



Transform - Advanced dialog box help

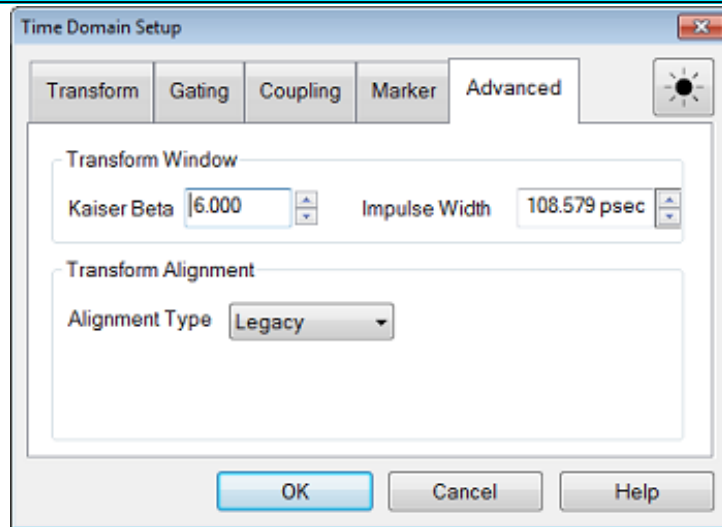

The following methods set window size. For best results, view the time domain response while making these settings.

- **Kaiser Beta** Changes window size using a Kaiser Beta value
- **Impulse Width** Changes window size using an Impulse Width value

Transform Alignment

Alignment Type

- **Legacy** - The DC value is extrapolated using three data points. The transform offset is calculated using the delay of the first frequency point. This is the same algorithm used in the HP 8510 network analyzer.
- **Normalize** - The DC value is extrapolated using three data points. The transform offset is set to zero at $t=0$ minus six rise-times. This mode requires that a good S-parameter calibration has been performed, which can be verified by observing a flat time-domain response at $t=0$ when measuring a load located at the physical point corresponding to $t=0$. Setting the time domain trace to zero at a time before $t=0$ stabilizes the trace for determining impedances after time $t=0$, resulting in improved behavior compared to Legacy mode. This method is similar to that used with PLTS, and is very useful in determining the time-domain-transform response of transmission lines and printed-circuit-board characteristics.

How to launch the **Time Domain Toolbar**

Using **Hardkey/SoftTab/Softkey**

1. Math > **Time Domain** > TD Toolbar

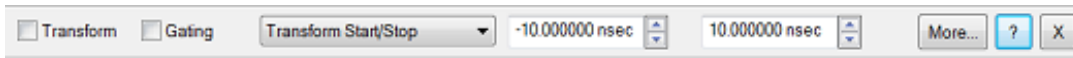
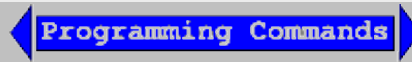

On the toolbar, click **More...** to launch the **Time Domain dialog** box

Overview

The N5252A is a banded network analyzer solution that uses compact remote frequency extenders with the PXI based VNA, extending the frequency coverage from 60 GHz to 90 GHz.

In its standard configuration the N5252A consists of the following key components:

- M9374A or M9375A with option 551 (1 Module per system VNA port)
- N5252AW12 Frequency Extenders

In this topic:

- [Features](#)
- [Capabilities](#)

Features

- Up to 4 millimeter wave ports can be configured
- Wide receiver and system dynamic range
- All ports configured for use at millimeter wave frequencies

Capabilities

- ONLY the applications listed in the [Supported Applications](#) table are supported
 - Power level adjustment at the output of the Frequency Extenders is only available after completing an [Installation Calibration](#).
 - The actual power level can be corrected during a Smart Cal with the Calibrate source and receiver power option selected.
 - Power calibration requires an appropriate power sensor and meter.
 - Frequency extender modules cannot be HOT swapped.
 - All ports must be configured for use with frequency extenders.
 - Trace noise for Receiver and Wave measurements will degrade for IF bandwidths < 100 Hz.
-

Supported Applications

The following table shows which applications the Millimeter system supports.

Application	Software Option
Time Domain	010

Starting and Exiting Millimeter Wave Mode

In this topic:

- Starting the Soft Front Panel (SFP)
- Starting Millimeter Wave Mode
- Exiting Millimeter Wave Mode

Starting the Soft Front Panel (SFP)

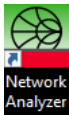

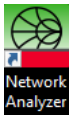
1. Click  on the host controller desktop to start the Soft Front Panel (SFP). The following Launcher dialog appears.

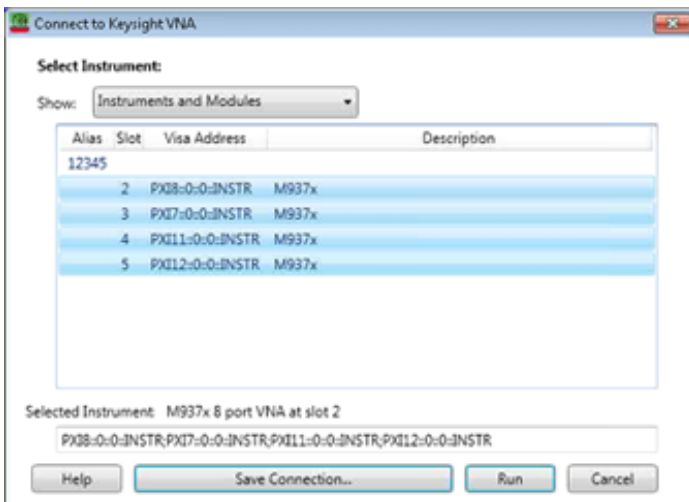

2. Select the desired modules (one millimeter port per module) then click **Run**.

Starting Millimeter Wave Mode

How to start Millimeter Wave Mode

Using a mouse

1. Click **Instrument**
2. Select **Setup**
3. Select **External Hardware**
4. Select **Millimeter Config...**
5. In the **Millimeter Configuration** dialog, select a banded or broadband configuration.
6. Configure the system then click **OK**.

Programming Commands

Exiting Millimeter Wave Mode

How to exit Millimeter Wave Mode

Using a mouse

1. Click **Instrument**
2. Select **Setup**
3. Select **External Hardware**
4. Select **Millimeter Config...**
5. In the **Millimeter Configurationn** dialog, select **Standard PNA**.
6. Click **OK**.

Programming Commands

Millimeter Configuration

This topic describes the Millimeter Configuration dialog functions used to configure the N5252A for banded measurements.

In this topic:

- [Accessing Millimeter Configuration Dialog](#)
- [Banded Millimeter Configuration Dialog](#)

Accessing Millimeter Configuration Dialog

- Press **Setup** > **External Hardware** > **Millimeter Config**.

Banded Millimeter Configuration Dialog

Banded Millimeter Module Configuration dialog box help

Programming Commands

	Start	Stop	Multiplier
Module RF IN	10.000000000 GHz	15.000000000 GHz	6
Module LO IN	10.000000000 GHz	15.000000000 GHz	6
Module Test Port	60.000000000 GHz	90.000000000 GHz	

Select Configuration Lists the Standard VNA configuration and other configurations that you have created.

- Click **New** for first-time use.
- Select **Standard PNA** to exit the Millimeter Configuration dialog.

Name Shows the currently selected configuration. Edit this field to change the configuration name. Type a unique name using only alphanumeric characters and underscore.

New Click to create a new Millimeter configuration. A name is automatically selected. Edit the Name field to change the configuration name.

Remove Deletes a Millimeter Configuration.

Properties

Max Power Limit at Module RF IN The maximum mmWave module RF input is limited to this value.

Offset Sets the loss of the cables. The mmWave module RF input is adjusted by this amount. Positive offset increases the power.

Slope Helps compensate for cable and test fixture power losses at increased frequency. The mmWave module RF input power increases as the sweep frequency increases in dB/GHz. The slope is defined relative to the mmWave module RF input frequency. The slope starts at 0 Hz and a positive slope will increase the power level. Range is +/- 2 dB/GHz.

Installation Cal... The installation calibration adjusts the source power at the output of the Frequency Extender. These can change each time a frequency extender is moved from one port to another, or from one system to another. This calibration should be done each time a change is made to the configuration. For a procedure, refer to [Installation Cal.](#)

Enable Installation Cal When checked will use the calibration data from the installation calibration.

Frequency Settings

Module RF IN RF Frequency Range (displayed in grey fields) multiplied by the multiplier value equals module test port frequency range.

Module LO IN LO Frequency Range (displayed in grey field) multiplied by this value equals the module test port frequency.

Module Test Port Set the Start and Stop frequencies of the selected configuration at the test ports. This becomes the displayed Start and Stop frequency of the VNA.

Important Notes

- To set Test Port Frequency, first set the appropriate **Multiplier** values that are specified in your mmWave module documentation.
- Ensure that the RF and LO Frequencies are within the frequency range of the sources. The VNA offers no warning if they are NOT.

Cancel Closes dialog box without saving changes.

OK Saves the configuration and the **VNA is Preset** before making the appropriate settings.

Installation Cal

This topic describes how to perform an Installation Cal, which should be done each time a change is made to the configuration.

Note: The Installation Cal must be performed before the **Smart Cal** procedure.

Installation Cal

- If power level control is required, perform Installation Calibration.
- The Installation Calibration should be done each time a change is made to the physical configuration, i.e. a cable change, a change in millimeter head, or a PXI module change.
- The Installation Calibration characterizes the input/output power relationship for each millimeter module.
- The Installation Calibration results in a +/- 5 dB source power calibration.
- The Installation Calibration does NOT provide any calibration of the VNA receivers.
- The Installation Calibration is applied system wide. It can be enabled and disabled, but only on a system wide basis. It cannot be enabled or disabled on a channel by channel basis.

The following example is for a system with 4 ports. The sequence will be different for different port counts.

1. Press **Setup** > **External Hardware** > **Millimeter Config**. The Millimeter Configuration dialog is displayed.

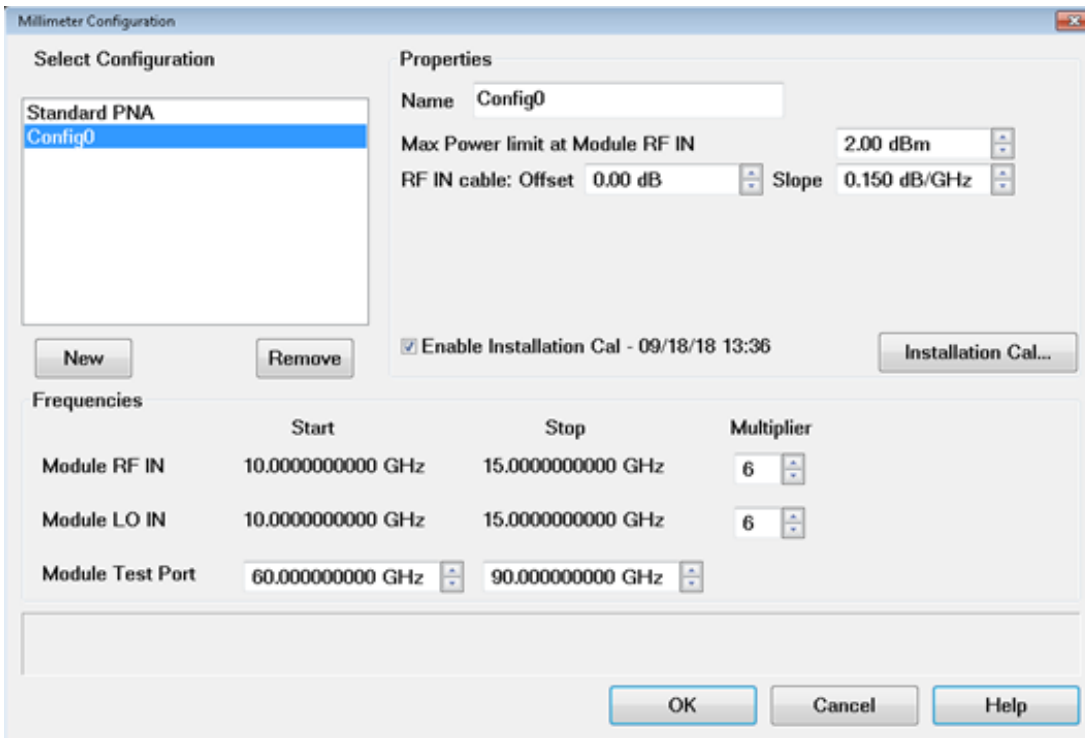

2. Select an existing millimeter configuration from the list under **Select Configuration**. For information on creating a millimeter configuration, refer to the [Banded Millimeter Configuration Dialog](#) help.
3. Click on **OK** to enable the configuration.
4. Press **Setup** > **External Hardware** > **Millimeter Config** to get back to the Millimeter Configuration Dialog.
5. Click on the **Installation Cal...** button to launch the calibration. The following dialog is displayed. This dialog displays the calibration date for each port if calibration was previously performed. Otherwise, "Not Available" will be shown in the Cal Date column. Also, "Not Available" will be shown for the Model number, as the supported Frequency Extenders do not provide their Model numbers electronically.

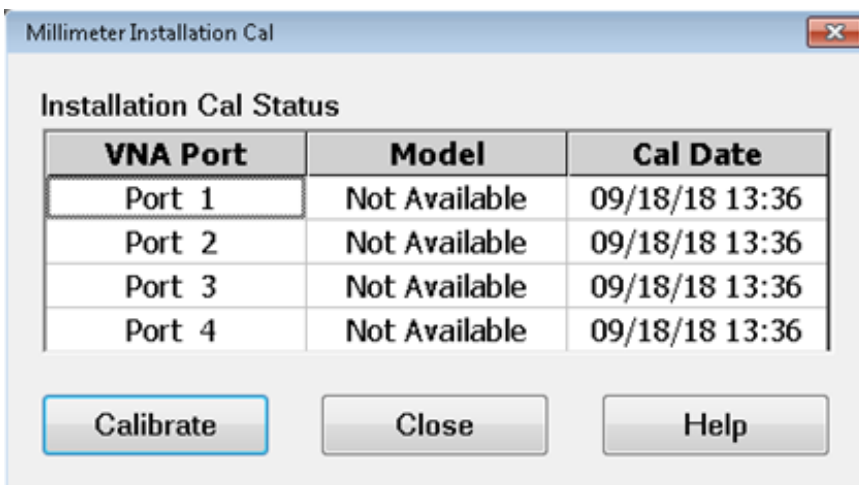

- Click on the **Calibrate** button to begin the calibration.

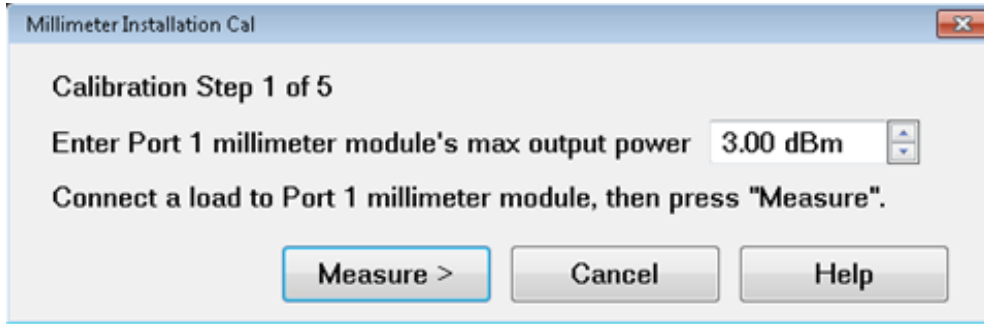

- In the USB drive supplied with the millimeter wave module is a file containing maximum output power data. Open this file to find the maximum output power for the module and enter this value in the **Enter Port 1 millimeter module's max output power** field. It is important to enter the correct maximum power to get a good Installation Calibration. The following is an example of a section of this file.

	A	B	C	D	E
1	Note: Out of band data is not guaranteed to be accurate				
2	Freq(GHz)	Power(dBm)			
3	60	13.41787144			
4	60.3	13.43646114			
5	60.6	13.16246568			
6	60.9	12.98881625			
7	61.2	13.01168937			
8	61.5	13.31570338			
9	61.8	13.47160264			
10	62.1	13.35698759			
11	62.4	13.20574798			
12	62.7	13.11622703			
13		13.00000000			

- Connect a waveguide load to Port 1.
- Click the **Measure** button. The following dialog is displayed.

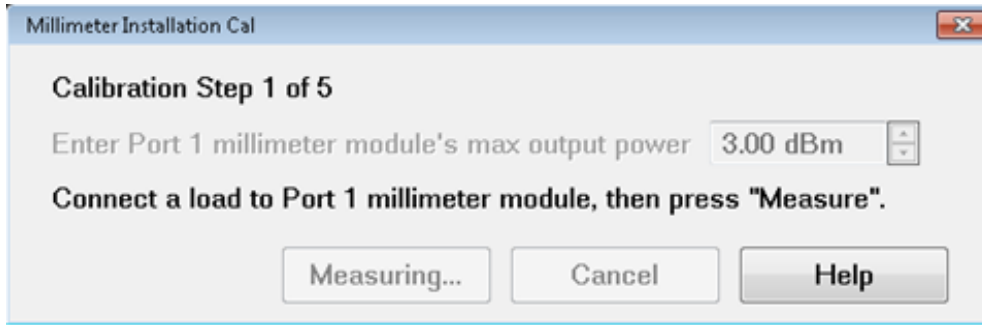

10. Follow the prompts to calibrate each port. Remember to enter the correct maximum power for each module.
11. When finished, the following dialog is displayed. Click the **Finish** button.

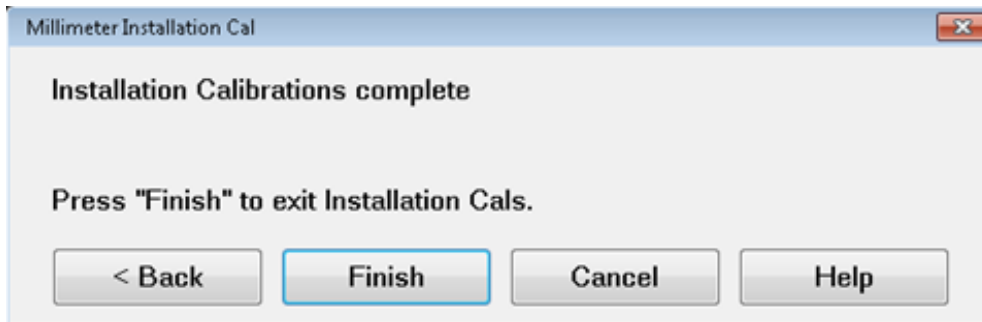

12. When finished, **Enable Installation Cal** in the **Millimeter Configuration** dialog should be checked and the calibration date/time displayed.

Enable Installation Cal - 10/16/18 12:39

Calibration

The procedure in this topic describes how to perform a calibration using the Smart Cal method. This is an example of one way to calibrate the system. There are others available. The example includes source and receiver calibration. This requires a power meter and appropriate power sensor. There must be an Installation Calibration on the system to perform the source and receiver calibration.

Smart Cal Procedure

1. Press **Cal** > **Main** > **Other Cals** > **Smart Cal** ... to launch the following dialog.

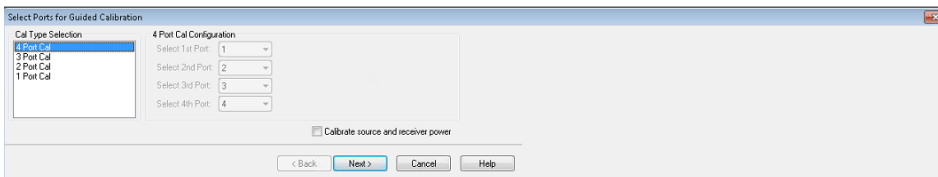

2. Select the type of calibration under **Cal Type Selection** .
3. Select the **Calibrate source and receiver power** check box if source and receiver power calibrations are desired .
4. Click **Next** .
5. Select the waveguide connector for each port under **DUT Connectors** . The DUT connector and cal kit information is in a file supplied with the cal kit. See Manage Cal Kits for information on how to import a cal kit.

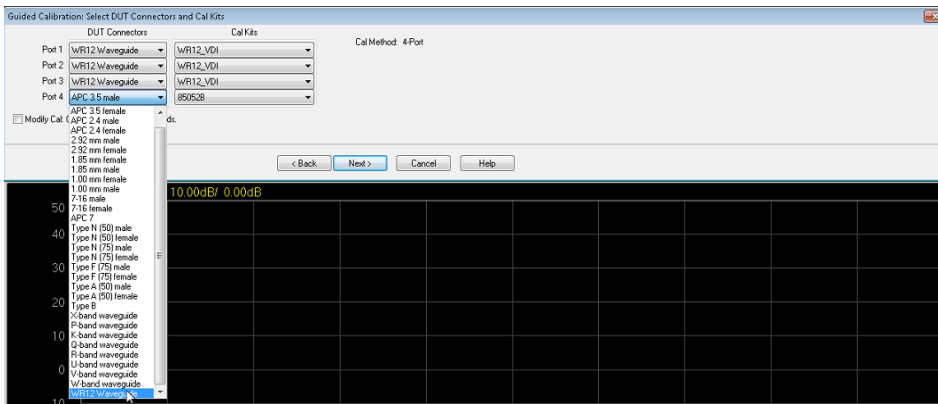

6. Click **Next** . The **Power Cal Settings** dialog is displayed.

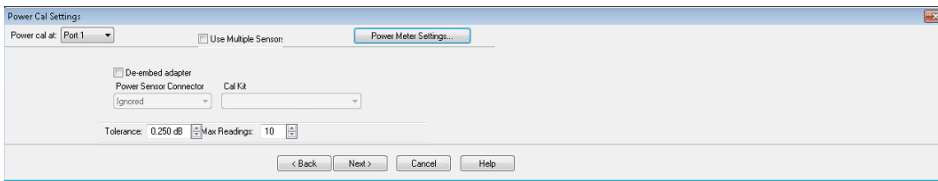

7. The Tolerance should be set to > 0.25 dB for the 60-90 GHz millimeter system.

8. In the **Power Cal Settings** dialog, click on the **Power Meter Settings** button and confirm that the power meter address is correct.



- In the **Power Meter Settings** dialog, click on the **Sensors** button. The **Connect Power Sensor** dialog is displayed.

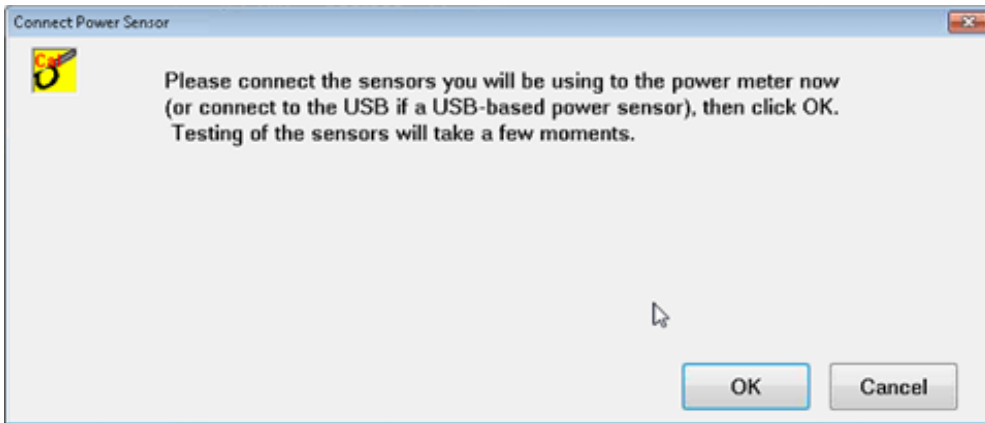

- Click **OK** in the **Connect Power Sensor** dialog to access the **Power Sensor Settings** dialog.
- Confirm that the power sensor has been detected as shown in the **Power Sensor Settings** dialog.

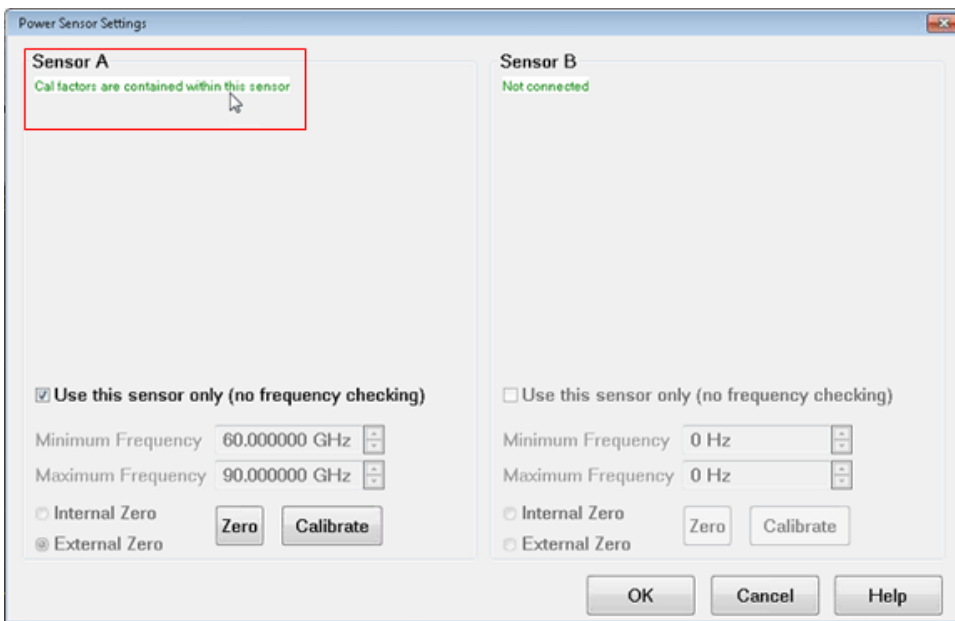

- Zero** and **Calibrate** the power meter as necessary.
- Click **OK** in the **Power Meter Settings** dialog to return to the **Power Cal Settings** dialog.
- Click **Next** . The **Guided Calibration Step 1 of 11** dialog is displayed.

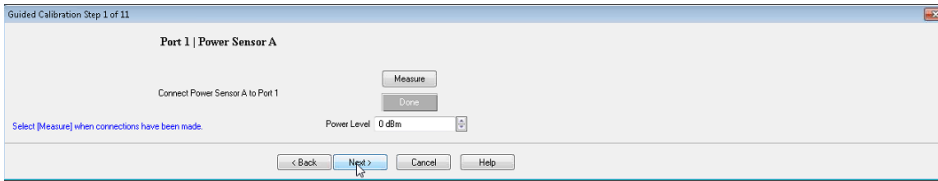

15. Set the **Power Level** to something lower than the lowest value for the maximum output power of the millimeter wave head. If the power level cannot be achieved, errors will result.
16. Connect the power sensor to Port 1 then click **Measure** .
17. Follow the on-screen prompts to complete the calibration.
18. When finished, click on the **Save As User CalSet** button to save this calset to a file.

1.

Troubleshooting the VNA

By running a few checks, you can identify if the analyzer is at fault. Before calling Keysight Technologies or returning the instrument for service, please make the following checks.

- [Check the Basics](#)
- [Check Error Terms](#)
- [Check the Service Guide](#)
- [Error Log](#)

Other Support Topics

Check the Basics

A problem can often be solved by repeating the procedure you were following when the problem occurred. Before calling Keysight Technologies or returning the instrument for service, please make the following checks:

1. Is there power at the power socket? Is the instrument plugged in?
2. Is the instrument turned on? Check to see if the front panel line switch and at least one of the LED rings around the test ports glows green. This indicates the power supply is on.
3. If you are experiencing difficulty with the front-panel keypad or peripherals, the USB bus may be overloaded. Remove the USB devices, restart the VNA, and reconnect the USB devices. See [Power-up](#).
4. If other equipment, cables, and connectors are being used with the instrument, make sure they are connected properly and operating correctly.
5. Review the procedure for the measurement being performed when the problem appeared. Are all the settings correct?
6. If the instrument is not functioning as expected, return the unit to a known state by pressing the **Preset** key.
7. Is the measurement being performed, and the results that are expected, within the [specifications](#) and capabilities of the instrument?
8. If the problem is thought to be due to firmware, check to see if the instrument has the [latest firmware](#) before starting the troubleshooting procedure.
9. Check that the measurement calibration is valid. See [Accurate Measurement Calibrations](#) for more

information.

Check Error Terms

If you print the error terms at set intervals (weekly, monthly, and so forth), you can compare current error terms to these records. A stable, repeatable system should generate repeatable error terms over long time intervals, for example, six months. If a subtle failure or mild performance problem is suspected, the magnitude of the error terms should be compared against values generated previously with the same instrument and calibration kit. See the [procedure for monitoring error terms](#).

- A long-term trend often reflects drift, connector and cable wear, or gradual degradation, indicating the need for further investigation and preventative maintenance. Yet, the system may still conform to specifications. The cure is often as simple as cleaning and gaging connectors or inspecting cables.
- A sudden shift in error terms reflects a sudden shift in systematic errors, and may indicate the need for further troubleshooting.

Consider the following while troubleshooting:

- All parts of the system, including cables and calibration devices, can contribute to systematic errors and impact the error terms.
- Connectors must be clean and gauged, and within specification for error term analysis to be meaningful. See the Chapter 2 in the VNA Service Guide for information on cleaning and gaging connectors.
 - Avoid unnecessary bending and flexing of the cables following measurement calibration, thus minimizing cable instability errors.
 - Use good connection techniques during the measurement calibration. The connector interface must be repeatable. See the VNA Service Guide for information on connection techniques.
- It is often worthwhile to perform the procedure twice (using two distinct measurement calibrations) to establish the degree of repeatability. If the results do not seem repeatable, check all connectors and cables.
- Use error-term analysis to troubleshoot minor, subtle performance problems. See Chapter 3, "Troubleshooting," in the VNA Service Guide if a blatant failure or gross measurement error is evident.

Check the Service Guide

Check the VNA Service Guide for specific troubleshooting procedures to help identify problems. You can download a copy of the Service Guide from our Web site:

www.keysight.com/find/vna

Error Log

Some VNAs create automatic log of data for troubleshooting purpose. The log file stores data related to the total power ON time, number of times of power ON, results of power ON test and so on. For security reasons, if this data needs to be deleted, then **SERVice:LOGGing:CLEar** command can be used to clear the log recorded by the instrument.

Analyzer Error Messages

- [500 - 750 Calibrate](#)
- [770 - 1000 Hardware](#)
- [1000 - 1200 Measure](#)
- [1281 - 1535 Parser](#)
- [1536 - 1650 Display](#)
- [1700 - 2000 Channel](#)
- [2001 - 3021 General](#)
- [Standard SCPI Errors](#)

See Also: [About Error Messages](#)

Memory Overflow Error

Memory overflow. Trigger state set to Hold. Lower the IF bandwidth, or increase dwell or sweep time.

Severity: Informational

Further explanation: The measurement that you are currently making requires that data be stored faster than it can be processed. Very few customers will experience this situation.

Suggestions: To limit the amount of data to be stored, try lowering the IF Bandwidth, slow the sweep time, increase the dwell time, or limit the number of data points. There are many other settings that can be adjusted to solve this problem.

EventID:

Cal Errors

Message: 512

"A secondary parameter (power, IFBW, sweep time, step mode) of the calibrated state has changed."

Severity: Informational

Further explanation: The calibration is questionable when any of these secondary parameters change

after the calibration is performed.

Suggestions: If you require an accurate measurement with the new settings, repeat the calibration.

EventID: 68020200 (hex)

Message: 513

"Calibration cannot be completed until you have measured all the necessary standards for your selected Cal Type."

Severity: Informational

Further explanation: You probably received this message because you attempted to turn correction on without first measuring all of the calibration standards

Suggestions: Finish measuring the cal standards

EventID: 68020201 (hex)

Message: 514

"Calibration set has been recalled using a file previously saved on an analyzer that had a different hardware configuration."

Severity: Informational

Further explanation:

Suggestions:

EventID: 68020202 (hex)

Message: 515

"Calibration is required before correction can be turned on. Channel number is <x>, Measurement is <x>."

Severity: Informational

Further explanation: There are no error correction terms to apply for the specified channel and measurement.

Suggestions: Perform or recall a calibration

EventID: 68020203 (hex)

Message: 516

"Critical parameters in your current instrument state do not match the parameters for the calibration set, therefore correction has been turned off. The critical instrument state parameters are sweep type, start frequency, frequency span, and number of points."

Severity: Informational

Further explanation: None

Suggestions: You can either recalibrate using the new settings or change back to the original setting that was used when the calibration was performed.

EventID: 68020204 (hex)

Message: 517

"Interpolation is turned off and you have changed the stimulus settings of the original calibration, so correction has been turned off."

Severity: Informational

Further explanation: The most accurate calibration is maintained only when the original stimulus settings are used.

Suggestions: If reduced accuracy is OK, set interpolation ON to allow stimulus setting changes.

EventID: 68020205 (hex)

Message: 518

"Interpolation is turned off and you have selected correction ON. Correction has been restored with the previous stimulus settings."

Severity: Informational

Further explanation: None

Suggestions: None

EventID: 68020206 (hex)

Message: 519

"Stimulus settings for your current instrument state exceeded the parameters of the original calibration, so correction has been turned off."

Severity: Informational

Further explanation: Correction data outside the stimulus settings does not exist.

Suggestions: Perform a broadband calibration, with increased numbers of points with interpolation ON, to maintain calibration over the widest possible stimulus frequency settings.

EventID: 68020207(hex)

Message: 520

"Cal Type is set to NONE for Channel <x>, Measurement <x>; please select Calibration menu or press Cal hard key."

Severity: Informational

Further explanation: A cal operation can not proceed until a calibration exists or the cal type is selected. This error can occur if the calibration can not be found. Also this error can happen if a calibration type is not specified before attempting to programmatically execute cal acquisitions.

Suggestions To find a calibration, select a Cal Set that contains the calibration needed for the current measurements. OR specify the cal type before beginning a calibration procedure.

EventID: 68020208 (hex)

Message: 521

"The measurement you set up does not have a corresponding calibration type, so correction has been turned off or is not permitted."

Severity: Informational

Further explanation: The calibration for the channel may apply only to certain S-Parameters. For example, a 1-Port calibration for S11 can not be applied to a 1-Port calibration applied to S22.

Suggestions: Select a calibration type, such as full 2-Port cal, that can be applied to all the measurements to be selected.

EventID: 68020209 (hex)

Message: 522

"The calibration type you selected cannot be set up."

Severity: Informational

Further explanation: "Please use the SCPI command ROUTe:PATH:DEFine:PORT <num>,<num> for full 2 port type port assignment."

Suggestions:

EventID: 6802020A (hex)

Message: 523

"The calibration path you selected cannot be set up because it is not valid for the current measurement."

Severity: Informational

Further explanation: "Please use the SCPI command ROUTe:PATH:DEFine:PORT <num>,<num> for full 2 port type port assignment related to your current measurement."

Suggestions:

EventID: 6802020B (hex)

Message: 524

"The source power calibration is complete."

Severity: Informational

Further explanation:

Suggestions:

EventID: 6802020C (hex)

Message: 525

"You have specified more than 7 standards for one or more calibration classes."

Severity: Informational

Further explanation: These have been truncated to 7 selections.

EventID: 6802020D (hex)

Message: 526

"No user calibration found for this channel."

Severity: Informational

Further explanation: A cal operation can not proceed until a calibration exists.

Suggestions: To find a calibration, you can select a Cal Set that contains the calibration needed for the

current measurement.

EventID: 6802020E (hex)

Message: 527

"You do not need to acquire this standard for this calibration type."

Severity: Informational

Further explanation: This error can happen as a result of PROGRAMMATICALLY requesting the measurement of an un-needed calibration standard during a calibration procedure.

Suggestions: Check the specified cal type or eliminate the request for the measurement of the standard.

EventID: 6802020F (hex)

Message: 528

"Could not configure the Electronic Calibration system. Check to see if the module is plugged into the proper connector."

Severity: Informational

Further explanation: During an ECal operation, communication could not be established with the ECal module. The calibration will not be initiated until the presence of the ECal module is verified.

Suggestions: Verify the USB cable is connected properly. Disconnect and re-connect the cable to ensure the analyzer recognizes the module.

EventID: 68020210 (hex)

Message: 529

"DATA OUT OF RANGE: Design Limits Exceeded"

Severity: Error

Further explanation:

Suggestions:

EventID: E8020211(hex)

Message: 530

"EXECUTION ERROR: Could not open ECal module memory backup file"

Severity: Error

Further explanation:

Suggestions:

EventID: E8020212 (hex)

Message: 531

"EXECUTION ERROR: Access to ECal module memory backup file was denied"

Severity: Error

Further explanation:

Suggestions:

EventID: E8020213 (hex)

Message: 532

"EXECUTION ERROR: Failure in writing to ECal module memory backup file"

Severity: Error

Further explanation:

Suggestions:

EventID: E8020214 (hex)

Message: 533

"EXECUTION ERROR: Failure in reading from ECal module memory backup file"

Severity: Error

Further explanation:

Suggestions:

EventID: E8020215 (hex)

Message: 534

"EXECUTION ERROR: Array index out of range"

Severity: Error

Further explanation:

Suggestions:

EventID: E8020216 (hex)

Message: 535

"EXECUTION ERROR: Arrays wrong rank"

Severity: Error

Further explanation:

Suggestions:

EventID: E8020217 (hex)

Message: 536

"EXECUTION ERROR: CPU"

Severity: Error

Further explanation:

Suggestions:

EventID: E8020218 (hex)

Message: 537

"EXECUTION ERROR: Cannot ERASE module"

Severity: Error

Further explanation:

Suggestions:

EventID: E8020219 (hex)

Message: 538

"EXECUTION ERROR: Cannot WRITE module"

Severity: Error

Further explanation:

Suggestions:

EventID: E802021A (hex)

Message: 539

"EXECUTION ERROR: Entry Not Found"

Severity: Error

Further explanation:

Suggestions:

EventID: E802021B (hex)

Message: 540

"EXECUTION ERROR: Invalid command while system is busy"

Severity: Error

Further explanation:

Suggestions:

EventID: E802021C (hex)

Message: 541

"Electronic Cal: Unable to orient ECal module. Please ensure the module is connected to the necessary measurement ports."

Severity: Error

Further explanation: There is no RF connection to the ECal module during a calibration step. An ECal orientation measurement has been attempted but the signal was not found.

Suggestions: Connect the ECal module RF connections to ports specified for the calibration step. The ECal module typically requires at least -18dBm for measurements. If your measurement requires the power level to be less than that, clear the **Do orientation** checkbox to bypass the automatic detection step.

EventID: E802021D (hex)

Message: 542

"EXECUTION ERROR: NO SPACE for NEW CAL, DELETE A CAL"

Severity: Error

Further explanation:

Suggestions:

EventID: E802021E (hex)

Message: 543

"EXECUTION ERROR: No More Room"

Severity: Error

Further explanation:

Suggestions:

EventID: E802021F (hex)

Message: 544

"EXECUTION ERROR: Other array error"

Severity: Error

Further explanation:

Suggestions:

EventID: E8020220 (hex)

Message: 545

"EXECUTION ERROR: Ranks not equal"

Severity: Error

Further explanation:

Suggestions:

EventID: E8020221 (hex)

Message: 546

"EXECUTION ERROR: Too few CONSTANT ranks"

Severity: Error

EventID: E8020222 (hex)

Message: 547

"EXECUTION ERROR: Too few VARYing ranks"

Severity: Error

EventID: E8020223 (hex)

Message: 548

"EXECUTION ERROR: Unknown error"

Severity: Error

EventID: E8020224 (hex)

Message: 549

"EXECUTION ERROR: ecaldrv.dll bug or invalid module #"

Severity: Error

EventID: E8020225 (hex)

Message: 550

"EXECUTION ERROR: unexpected error code from ecal driver"

Severity: Error

EventID: E8020226 (hex)

Message: 551

"EXECUTION ERROR: unexpected internal driver error"

Severity: Error

EventID: E8020227 (hex)

Message: 552

"HARDWARE ERROR: Can't access ECal Interface Module"

Severity: Error

EventID: E8020228 (hex)

Message: 553

"HARDWARE ERROR: Can't release LPT port, reboot"

Severity: Error

EventID: E8020229 (hex)

Message: 554

"HARDWARE ERROR: VNA Error"

Severity: Error

EventID: E802022A (hex)

Message: 555

"HARDWARE ERROR: not enough data read from ECal module"

Severity: Error

EventID: E802022B (hex)

Message: 556

"OPERATION ABORTED BY HOST COMPUTER"

Severity: Error

EventID: E802022C (hex)

Message: 557

"OPERATION ABORTED BY USER"

Severity: Error

EventID: E802022D (hex)

Message: 558

"OUT OF MEMORY"

Severity: Error

EventID: E802022E (hex)

Message: 559

"QUERY INTERRUPTED:Message(s Abandoned"

Severity: Error

EventID: E802022F (hex)

Message: 560

"QUERY UNTERMINATED: INCOMPLETE PROGRAM Message"

Severity: Error

Further explanation:

Suggestions:

EventID: E8020230 (hex)

Message: 561

"QUERY UNTERMINATED: NOTHING TO SAY"

Severity: Error

Further explanation:

Suggestions:

EventID: E8020231 (hex)

Message: 562

"QUEUE OVERFLOW"

Severity: Error

EventID: E8020232 (hex)

Message: 563

"SETTINGS CONFLICT: ADDITIONAL STANDARDS ARE NEEDED"

Severity: Error

EventID: E8020233 (hex)

Message: 564

"SETTINGS CONFLICT: Adapter Cal is NOT possible"

Severity: Error

EventID: E8020234 (hex)

Message: 565

"SETTINGS CONFLICT: COMMAND OUT OF SEQUENCE"

Severity: Error

EventID: E8020235 (hex)

Message: 566

"SETTINGS CONFLICT: Cal STOPPED - VNA SETUP CHANGED"

Severity: Error

EventID: E8020236 (hex)

Message: 567

"SETTINGS CONFLICT: Calibration is NOT in progress"

Severity: Error

EventID: E8020237 (hex)

Message: 568

"SETTINGS CONFLICT: Can't find specified GPIB board"

Severity: Error

EventID: E8020238 (hex)

Message: 569

"SETTINGS CONFLICT: Can't find/load gpib32.dll"

Severity: Error

EventID: E8020239 (hex)

Message: 570

"SETTINGS CONFLICT: Can't find/load sicl32.dll"

Severity: Error

EventID: E802023A (hex)

Message: 571

"SETTINGS CONFLICT: Can't initialize VNA (bad address?"

Severity: Error

EventID: E802023B (hex)

Message: 572

"SETTINGS CONFLICT: Can't load LPT port driver or USB driver DLL"

Severity: Error

EventID: E802023C (hex)

Message: 573

"SETTINGS CONFLICT: Invalid Calibration Sweep Mode."

Severity: Error

EventID: E802023D (hex)

Message: 574

"SETTINGS CONFLICT: Invalid Calibration Type"

Severity: Error

EventID: E802023E (hex)

Message: 575

"SETTINGS CONFLICT: Invalid Calibration"

Severity: Error

EventID: E802023F (hex)

Message: 576

"SETTINGS CONFLICT: Invalid GPIB board number specified"

Severity: Error

EventID: E8020240 (hex)

Message: 577

"SETTINGS CONFLICT: Invalid GPIB board type specified"

Severity: Error

EventID: E8020241 (hex)

Message: 578

"SETTINGS CONFLICT: Invalid Module Status"

Severity: Error

EventID: E8020242 (hex)

Message: 579

"SETTINGS CONFLICT: Invalid States"

Severity: Error

EventID: E8020243 (hex)

Message: 580

"SETTINGS CONFLICT: LPT port must be between 1 and 4"

Severity: Error

EventID: E8020244 (hex)

Message: 581

"Could not configure the Electronic Calibration system. Check to see if the module is properly connected."

Severity: Error

EventID: E8020245 (hex)

Message: 582

"SETTINGS CONFLICT: Specified LPT port does not exist"

Severity: Error

EventID: E8020246 (hex)

Message: 583

"SETTINGS CONFLICT: Use frequency domain for cal"

Severity: Error

EventID: E8020247 (hex)

Message: 584

"SETTINGS CONFLICT: Use step sweep type for cal."

Severity: Error

EventID: E8020248 (hex)

Message: 585

"SETTINGS CONFLICT: VNA address must be between 0 and 30"

Severity: Error

EventID: E8020249 (hex)

Message: 586

"SETTINGS CONFLICT: Wrong LPT port driver or USB driver DLL"

Severity: Error

EventID: E802024A (hex)

Message: 587

"SYNTAX ERROR: ECAL:DELAY command must have 2 numbers"

Severity: Error

EventID: E802024B (hex)

Message: 588

"SYNTAX ERROR: INCORRECT SYNTAX"

Severity: Error

EventID: E802024C (hex)

Message: 589

"SYNTAX ERROR: UNKNOWN COMMAND"

Severity: Error

EventID: E802024D (hex)

Message: 590

"Wrong port of module in RF path"

Severity: Error

EventID: E802024E (hex)

Message: 591

"User characterization not found in module"

Severity: Error

EventID: E802024F (hex)

Message: 592

Severity: Informational

"No source power calibration found for the channel and source port of the current measurement."

Further explanation: You tried to turn on source power cal but there is no source power cal data.

Suggestions: Perform a source power calibration

EventID: 68020250 (hex)

Message: 593

Severity: Informational

"A source power calibration sweep was not performed, so there is no correction for the channel and

source port of the current measurement."

Further explanation: You tried to turn on source power cal but there is incomplete source cal data.

Suggestions: Perform a complete source power calibration

EventID: 68020251 (hex)

Message: 594

Severity: Informational

"A new trace could not be added to the active window for viewing the source power cal sweep, because it would have exceeded the limit on number of traces/window. Please remove a trace from the window before proceeding with source power cal."

Further explanation: The source power cal attempts to add a data trace to the active window. The active window already contains four traces.

Suggestions: Make the active window contain less than four traces.

EventID: 68020252 (hex)

Message: 595

Severity: Informational

"A new measurement could not be added for performing the source power cal sweep, because the limit on number of measurements has been reached. Please remove a measurement before proceeding with source power cal."

Further explanation: The source power cal attempts to add a measurement. The analyzer already has the maximum number of measurements.

Suggestions: Delete a measurement.

EventID: 68020253 (hex)

Message: 596

Severity: Informational

"The calibration power value associated with the source power calibration of Port %1 on Channel %2 was changed with the calibration on. The calibration was not turned off, but the power value might no longer represent the calibration."

Further explanation: The source power cal accuracy is questionable.

Suggestions: If high accuracy is required, perform another source power calibration.

EventID: 68020254 (hex)

Message: 597

Severity: Informational

- Message that is passed from the power meter driver for a source power calibration. -

Further explanation: This error is generated by the power meter driver and passed through the analyzer.

EventID: 68020255 (hex)

Message: 598

"During the acquisition of the sliding load standard, the slide was not properly moved to perform a circle fit. The standard's raw impedance was used to determine the directivity for one or more points."

Severity: Informational

Further Explanation: To accurately characterize the standard, the sliding load must be move sufficiently to ensure enough samples around the complex circle or Smith Chart. Under-sampling will cause an inaccurate result.

Suggestions: For best results when using a sliding load, be sure to use multiple slide positions that cover the full range of movement from front to back of the slot.

EventID: 68020256 (hex)

Message: 599

"This feature requires an unused channel, but could not find one. Please free up a channel and try again."

Severity: Informational

Further Explanation: You attempted to view an item within a calset. However, the calset viewer requires that the result be displayed in a channel that is not currently in use. All the channels are currently used. The view can not display the requested item.

Suggestions: You must delete at least one channel that is currently in use.

EventID: 68020257 (hex)

Message: 600

"Interpolation of the original calibration is not allowed since it was performed using Segment Sweep. Correction has been turned off."

Severity: Informational

EventID: 68020258 (hex)

Message: 601

"Cal preferences saved. Cal preference settings can be changed from the 'Cal Preferences' drop down Cal menu."

Severity: Informational

EventID: 68020259 (hex)

Message: 608

"CalType not set."

Severity: Error

Further explanation: A cal operation can not proceed until a calibration exists or the proper cal type is selected.

Suggestions: This error can happen if the calibration can't be found. To find a calibration, you can select a Cal Set that contains the calibration needed for the current measurements. This error can also happen if a calibration type is not specified before attempting to programmatically execute cal acquisitions. Specify the cal type before beginning a calibration procedure.

EventID: E8020260 (hex)

Message: 609

"The Calibration feature requested is not implemented."

Further explanation: The specified cal type can be one of many choices. For example, response calibrations require single standards, 1-Port calibrations require 3 standards, and 2-Port calibrations require up to 12 standards.

Suggestions: Be sure to measure only the standards needed for the specified cal type.

EventID: E8020261 (hex)

Message: 610

"The Calibration Class Acquisition requested is not valid for the selected Calibration Type. Please

select a different acquisition or a different Calibration Type."

EventID: E8020262 (hex)

Message: 611

"The Calibration Standard data required for the selected caltype was not found."

Severity: Error

Further explanation: An unsuccessful attempt was made to retrieve a specified standard from the raw measurement buffer. The buffer should contain the raw measurements of cal standards stored during a calibration procedure.

Suggestions: Be sure the requested standard is required for the current cal type. Not all standards are needed for all cal types.

EventID: E8020263 (hex)

Message: 612

" The Error Term data required for the selected caltype was not found."

Severity: Error

Further explanation: An unsuccessful attempt was made to retrieve a specified error term from the error correction buffer. The buffer should contain the error correction arrays for the current calibration.

Suggestions: Be sure the requested error term is required for the current cal type. Not all error terms are needed for all cal types.

EventID: E8020264 (hex)

Message: 613

The Calibration data set was not found.

Severity: Error

Further explanation: An unsuccessful attempt to access a cal set has been made. This may indicate a calset has been deleted or has been corrupted.

Suggestions: Try again or select another cal set. If the cal set appears in the cal set list, it may need to be deleted.

EventID: E8020265 (hex)

Message: 614

"The specified measurement does not have a calibration valid for Confidence Check. Please select a different measurement, or recall or perform a different Calibration Type."

Severity: Error

Further explanation: The measurement choice is prevented so that calibration will not be turned off. Not all cal types support all measurements. For example, an 1-Port cal on S11 can not be used to calibrate an S12 measurement. When a measurement is selected that does not have a calibration which can be applied, an informational message is displayed and calibration is turned off.

Suggestions: Use a full 2-Port calibration to be compatible with any S-Parameter.

EventID: E8020266 (hex)

Message: 615

" New calset created."

Severity: Informational message.

Further explanation: The newly created cal set will be automatically named and time stamped. If this is the beginning of a calibration procedure, the cal set will not be stored to memory until the calibration has completed successfully. The new cal set will be deleted if the calibration is canceled or does not otherwise complete successfully.

Suggestions: Informational

EventID: 68020267

Message: 617

The calset file: <x> appears to be corrupted and cannot be removed. Exit the application, remove the file, and restart.

Severity: Error

Suggestions: The cal set file is stored in the application home directory C:/Program Files/Keysight/Network Analyzer/analyzerCalSets.dat. Remove this file, then restart the application.

EventID: E8020269 (hex)

Message: 634

"The calset file: <x> load failed."

Severity: Error

Further explanation: The calset file contains a collection of calsets. The file resides on the hard drive.

Suggestions: Try restarting the application. If the failure persists, you may have to delete the cal set data file and restart the application. The cal set file is stored in the application home directory.

C:/Program Files/Keysight/Network Analyzer/analyzerCalSets.dat. Remove this file, then restart the application.

EventID: E802027A (hex)

Message: 635

"The calset file: <x> save failed."

Severity: Error

Further explanation: The file operation detected an error. The save operation was aborted.

Suggestions: Retry.

EventID: E802027B (hex)

Message: 636

"A calset was deleted."

Severity: Informational

Further explanation: One of the calsets has been successfully deleted from the collection of calsets available. This can happen as the result of a user request or intentional operation.

Suggestions: None

EventID: 6802027C (hex)

Message: 637

"The version of the calset file: <x> is not compatible with the current instrument."

Severity: Error

Further explanation: A versioning error can prevent a calset from being used. This can happen as a result of instrument firmware upgrades.

Suggestions: If the versioning error is the result of firmware upgrade, you will have to re-install the old version of firmware to re-use the calset file. Or you can re-create the calsets with the current

version of firmware.

The cal set file is stored in the application home directory C:/Program Files/Keysight/Network Analyzer/analyzerCalSets.dat. Remove this file, then restart the application.

EventID: E802027D (hex)

Message: 638

"Incompatible CalSets found: <x> of <y> stored calsets have been loaded."

Severity: Error

Further explanation: Errors were found on some of the calsets stored in the calset file. The errors may have been caused by versioning issues that may have corrupted the various calset keys.

Suggestions: Use the calset viewer to look at the contents of calset files. Delete the files that are corrupted.

EventID: 6802027E (hex)

Message: 639

"The Calset file: <x> was not found. A new file has been created."

Severity: Informational

Further explanation: The calset file should be stored on the hard drive. When the application is started, a search is done and the file is loaded if it can be found. If the file is not found, the analyzer will create a new file and display this message.

Suggestions: None

EventID: 6802027F (hex)

Message: 640

"The Calset specified is currently in use."

Severity: Error

Further explanation: This may indicate a conflict between multiple calset users attempting calibration tasks.

Suggestions: Save the instrument state. Preset the analyzer and recall the instrument state. This may abort any processes that may be in progress.

EventID: E8020280 (hex)

Message: 641

"The calset specified has not been opened."

Severity: Error

Further explanation: Multiple users may be attempting to access the calset.

Suggestions: Close multiple calset users so that only one user will access the calset.

EventID: E8020281 (hex)

Message: 642

"The maximum number of cal sets has been reached. Delete old or unused cal sets before attempting to create new ones."

Severity: Error

Suggestions: You may also delete the calsets data file.

The cal set file is stored in the application home directory. C:/Program Files/Keysight/Network_Analyzer/analyzerCalSets.dat. Remove this file, then restart the application.

EventID: E8020282 (hex)

Message: 643

The requested power loss table segment was not found.

Severity: Error

EventID: E8020283 (hex)

Message: 644

"A valid calibration is required before correction can be turned on."

Severity: Error

Further explanation: This usually indicates a calibration procedure has not run to completion or that the selected measurement does not have a valid calibration available from within the currently selected cal set.

Suggestions: To find a calibration, you can select a Cal Set that contains the calibration needed for the current measurements. This error can happen if a calibration type is not specified before attempting to

programmatically execute cal acquisitions. Specify the cal type before beginning a calibration procedure.

EventID: E8020284 (hex)

Message: 645

The cal data for <x> is incompatible and was not restored. Please recalibrate."

Severity: Warning

Further explanation: None

Suggestions: None

EventID: A8020285 (hex)

Message: 646

"CalSet not loaded, version is too new."

Severity: Error

Further explanation: An old version of firmware is attempting to run with a new calset version. The version is incompatible.

Suggestions: The calset can be removed. You may also delete the calsets data file if you are migrating between various firmware revisions often and you would like to avoid this error. The cal set file is stored in the application home directory. C:/Program Files/Keysight/Network Analyzer/analyzerCalSets.dat. Remove this file, then restart the application.

EventID: E8020286 (hex)

Message: 647

"Custom cal type not found."

Severity: Error

Further explanation:

Suggestions:

EventID: E8020287 (hex)

Message: 648

"Custom correction algorithm defers to the client for interpolation."

Severity: Informational

EventID: 68020288 (hex)

Message: 649

"Custom cal dll threw an exception."

Severity: Error

EventID: E8020289 (hex)

Message: 650

"Could not load the ecal.dll library"

Severity: Error

EventID: E802028A (hex)

Message: 656

"The argument specified is not a valid cal type."

Severity: Error

EventID: E8020290 (hex)

Message: 657

"The function found existing interpolated data"

Severity: Informational

EventID: 68020291 (hex)

Message: 658

"The function computed new interpolation values."

Severity: Informational

EventID: 68020292 (hex)

Message: 659

"The source power measurement failed."

Severity: Error

Suggestions: Please check GPIB, power meter settings and sensor connections.

EventID: E8020293 (hex)

Message: 660

"Duplicate session found. Close session and retry."

Severity: Error

EventID: E8020294 (hex)

Message: 661

"The session does not exist. Open the session and try again."

Severity: Error

Further explanation:

EventID: E8020295 (hex)

Message: 662

"Attempt to launch a custom calibration failed."

Severity: Error

Further explanation:

EventID: E8020296 (hex)

Message: 663

"Request to measure a cal standard failed."

Severity: Error

Further explanation: Please ensure you are requesting to measure standards which are defined for this calibration.

EventID: E8020297 (hex)

Message: 664

"Since Electronic Calibration Kit is selected, Mechanical Cal Kit parameter cannot be changed."

Severity: Error

Further explanation:

EventID: E8020298 (hex)

Message: 665

"Frequencies of the active channel are below minimum or above maximum frequencies of the ECal module factory characterization."

Suggestions: Change the channel frequencies, or select another ECal module.

Severity: Error

EventID: E8020299 (hex)

Message: 666

"Calset chosen for characterizing the ECal Module Ports %1 does not contain a calibration for analyzer Ports %2."

Severity: Error

Suggestions: Go back to select another calset or to perform another cal.

EventID: E802029A (hex)

Message: 667

"ECal module only has sufficient memory remaining to store a maximum of %1 points in User Characterization %2."

Severity: Error

Suggestions: Decrease your number of points, or choose to overwrite another user characterization.

EventID: E802029B (hex)

Message: 668

Input values are non-monotonic. Cannot interpolate.

Severity: Error

EventID: E802029C (hex)

Message: 669

Interpolation target is out of range. Cannot interpolate.

Severity: Error

EventID: E802029D (hex)

Message: 670

Guided Calibration Error: <>

Severity: Error

EventID: E802029E (hex)

Message: 671

The first call to the guided calibration interface must be Initialize.

Severity: Error

EventID: E802029F (hex)

Message: 672

The selected thru cal method was not recognized.

Severity: Error

EventID: E80202A0 (hex)

Message: 673

Could not generate the error terms.

Severity: Error

EventID: E80202A1 (hex)

Message: 674

Guided calibration must be performed on the active channel

Severity: Error

EventID: E80202A2 (hex)

Message: 675

You can not start using calibration steps until you have successfully called **generate steps**.

Severity: Error

EventID: E80202A3 (hex)

Message: 676

The step number given is out of range. Step numbers should be between 1 and the number of steps. 0 is not a valid step number.

Severity: Error

EventID: E80202A4 (hex)

Message: 677

A calset was selected for channel: <n> without restoring stimulus.

Severity: Informational

EventID: 680202A5 (hex)

Message: 678

A calset was selected for channel: <n> restoring stimulus.

Severity: Informational

EventID: 680202A6 (hex)

Message: 679

The selected calset stimulus could not be applied to the channel.

Severity: Informational

EventID: 680202A7 (hex)

Message: 680

You attempted to measure power at a frequency outside the frequency range defined for the specified power sensor. Select another sensor or adjust the range for this sensor.

Severity: Error

EventID: E80202A8 (hex)

Message: 681

Specified frequency is outside the frequency ranges currently defined for the power meter's sensors.

Severity: Error

EventID: E80202A9 (hex)

Message: 682

Additional Calibration Standards need to be acquired in order to calibrate over the entire frequency range currently being measured.

Severity: Informational

EventID: 680202AA (hex)

Message: 683

The analyzer failed to convert cal kits for use by unguided calibrations. The recommended action is to restore Cal Kit defaults.

Severity: Error

EventID: E80202AB (hex)

Message: 684

The analyzer failed to convert cal kits for use by unguided calibrations. CalKit defaults have been restored.

Severity: Error

EventID: E80202AC (hex)

Message: 685

Power meter is reserved by a source power cal acquisition already in progress.

Severity: Error

EventID: E80202AD (hex)

Message: 686

Source power calibration has not been performed or uploaded for the specified channel and source port.

Severity: Error

EventID: E80202AE (hex)

Message: 687

Source power calibration data array size for the specified channel and source port does not match it's associated stimulus number of points.

Severity: Error

EventID: E80202AF (hex)

Message: 688

Source power calibration of Port <n> on Channel <n> was turned off because the correction array no longer exists.

Severity: Error

EventID: E80202B0 (hex)

Message: 689

This command can only be used on a measurement created with a specified calibration loadport.

Severity: Error

EventID: E80202B1 (hex)

Message: 690

Interpolation is turned off and you have changed the stimulus settings of the original calibration, so correction has been turned off.

Severity: Error

EventID: E80202B2 (hex)

Message: 691

Stimulus settings for your current instrument state exceeded the parameters of the original calibration, so correction has been turned off.

Severity: Error

EventID: E80202B3 (hex)

Message: 692

Fixturing: the requested S2P file cannot be read. Possible formatting problem.

Severity: Error

EventID: E80202B4 (hex)

Message: 693

Fixturing: the requested S2P file cannot be opened.

Severity: Error

EventID: E80202B5 (hex)

Message: 694

Fixturing: the requested S2P file cannot be interpolated. This is usually because the frequency range in the file is a subset of the current channel frequency range.

Severity: Error

EventID: E80202B6 (hex)

Message: 695

Cal Registers can only be used by one channel: the channel conveyed in the name of the cal register. The name cannot be changed.

Severity: Error

Further explanation: See [Cal Registers](#)

EventID: E80202B7 (hex)

Message: 696

Fixturing: cannot be enabled with Response Calibrations and has been turned off.

Severity: Error

EventID: E80202B8 (hex)

Message: 697

The selected calibration cannot be performed for this measurement.

Severity: Error

EventID: E80202B9 (hex)

Message: 698

Fitting: RemoveAllConnectors() should be called prior to calling AddConnector after a fit has been attempted.

Severity: Error

EventID: E80202BA (hex)

Message: 699

An attempt was made to acquire calibration data before the system was properly initialized.

Severity: Error

EventID: E80202BB (hex)

Message: 700

Use IGuidedCalibration for multipoint calibration types.

Severity: Error

EventID: E80202BC (hex)

Message: 701

Guided calibration requires number of thru measurement paths be at least equal to the number of calibration ports minus 1.

Severity: Error

EventID: E80202BD (hex)

Message: 702

A thru path was specified that includes a port which the calibration was not specified to include.

Severity: Error

EventID: E80202BE (hex)

Message: 703

One or more of the ports to be calibrated was not found in the set of specified thru paths.

Severity: Error

EventID: E80202BF (hex)

Hardware Errors

Message: 770

Input power too high. Source power is off.

Severity: Warning

EventID: A8030302 (hex)

Message: 771

Source power restored.

Severity: Informational

EventID: 68030303 (hex)

Message: 772

"The spampnp.sys driver is not working. Check system hardware. ! Data will be simulated. !"

Severity: Error

Further explanation: The Network Analyzer application cannot locate the DSP board. Hardware or a driver may be malfunctioning. This is also common when attempting to run the Network Analyzer on a workstation.

EventID: E8030304 (hex)

Message: 773

"Instrument Serial Bus Not Working."

Severity: Error

Further explanation: The instrument EEPROM appears to contain either all ones or all zeros. A serial bus hardware failure prevents reading the EEPROM.

EventID: E8030305 (hex)

Message: 784

Unleveled, source <n>, out <n>.

Severity: Error

Further explanation: The analyzer was unable to set the power on port <n> to the desired level

Message: 848

"Phase lock lost"

Severity: Error

Further explanation: The instrument source was not able to lock properly. This can be the result of broken hardware, poor calibration, or bad EEPROM values.

Suggestions: Perform source calibration. Click System / Service / Adjustments / Source Calibration

EventID: E8030350 (hex)

Message: 849

Phaselock restored.

Severity: Success

EventID: 0x28030351 (hex)

Message: 850

"Unknown hardware error."

Severity: Error

Further explanation: Hardware malfunctioned prevents communication with the DSP.

EventID: E8030352 (hex)

Message: 851

DSP communication lost.

Severity: Error

EventID: E8030353 (hex)

Message: 852

RF power off.

Severity: Error

EventID: E8030354 (hex)

Message: 853

RF power on.

Severity: Success

EventID: 28030355 (hex)

Message: 854

Hardware OK.

Severity: Success

EventID: 28030356 (hex)

Message: 855

"Source unlevelled."

Severity: Error

Further explanation: The source was unable to properly level at the requested power. The indicated power may not be accurate.

Suggestions: Try a different power level. Recalibrate source, if problem persists.

EventID: E8030357 (hex)

Message: 856

Source leveled.

Severity: Success

EventID: 28030358 (hex)

Message: 857

Input overloaded.

Severity: Error

EventID: E8030359 (hex)

(M9485A) Noise power in source signal may cause the overload. Reducing the noise power level at the receiver by adjusting the gain of peripherals and increasing full scale of the receiver may solve the overload.

Message: 858

Input no longer overloaded.

Severity: Success

EventID: 2803035A (hex)

Message: 859

"Yig calibration failed."

Severity: Error

Further explanation: Internal self-calibration of YIG oscillator tuning failed.

EventID: E803035B (hex)

Message: 860

Yig calibrated.

Severity: Success

EventID: 2803035C (hex)

Message: 861

"Analog ramp calibration failed."

Severity: Error

Further explanation: Internal analog sweep ramp calibration has failed.

EventID: E803035D (hex)

Message: 862

Analog ramp calibrated.

Severity: Success

EventID: 2803035E (hex)

Message: 864

Source temperature OK.

Severity: Success

EventID: 28030360 (hex)

Message: 865

"EEPROM write failed."

Severity: Error

Further explanation: Attempt to store calibration data to EEPROM has failed. There is a possible hardware failure.

EventID: E8030361 (hex)

Message: 866

EEPROM write succeeded.

Severity: Success

EventID: 28030362 (hex)

Message: 867

Attempted I/O write while port set to read only.

Severity: Error

Further explanation: Attempt to write to an I/O data port while the port set to input/read only.

Suggestions: Set data port to write/output before attempting to write to port.

EventID: E8030363 (hex)

Message: 868

" Attempted I/O read from write only port.

Severity: Error

Further explanation: Attempt to read from an I/O data port while the port set to output/write only.

Suggestions: Set data port to read/input before attempting to read from port.

EventID: E8030364 (hex)

Message: 869

Invalid hardware element identifier.

Severity: Error

EventID: E8030365 (hex)

Message: 870

Invalid gain level setting.

Severity: Error

EventID: E8030366 (hex)

Message: 871

Device driver was unable to allocate enough memory. Please try rebooting.

Severity: Error

EventID: E8030367 (hex)

Message: 872

DSP Error. Please Contact Keysight Support. Technical Information: DSP Type 1

Severity: Error

EventID: E8030368 (hex)

Message: 873

DSP Error. Please Contact Keysight Support. Technical Information: DSP Type 2

Severity: Error

EventID: E8030369 (hex)

Message: 874

DSP Error. Please Contact Keysight Support. Technical Information: DSP Type 3

Severity: Error

EventID: E803036A (hex)

Message: 875

DSP Error. Please Contact Keysight Support. Technical Information: DSP Type 4

Severity: Error

EventID: E803036B (hex)

Message: 876

DSP Error. Please Contact Keysight Support. Technical Information: DSP Type 5

Severity: Error

EventID: E803036C (hex)

Message: 910

The trigger connection argument was not recognized as valid by the firmware.

Severity: Error

EventID: 0xE803038E (hex)

Message: 911

The trigger connection specified does not support this trigger behavior

Severity: Error

EventID: E803038F (hex)

Message: 912

The trigger behavior specified was not recognized as valid by the firmware.

Severity: Error

EventID: E8030390 (hex)

Message: 913

The trigger connection specified does not physically exist on this network analyzer

Severity: Error

EventID: E8030391 (hex)

Message: 914

Cannot set "Accept Trigger Before Armed", since this hardware configuration does not support edge triggering.

Severity: Error

EventID: E8030392 (hex)

Message: 915

Cannot set "Trigger Output Enabled", since this hardware configuration does not support BNC2.

Severity: Error

EventID: E8030393 (hex)

Message: 916

Exceeded maximum trigger delay.

Severity: Error

EventID: E8030394 (hex)

Message: 917

Exceeded minimum trigger delay.

Severity: Error

EventID: E8030395 (hex)

Measure Errors

Message: 1024

If you are going to display or otherwise use a memory trace, you must first store a data trace to memory.

Severity: Warning

EventID: A8040400 (hex)

Message: 1025

"The measurement failed to shut down properly. The application is in a corrupt state and should be shut down and restarted."

Severity: Error

Further explanation: This message is displayed if the analyzer application becomes corrupt. If you continue to get this error, please call customer service

EventID: E8040401 (hex)

Message: 1026

The measurement failed to shut down properly. The update thread failed to exit properly.

Severity: Warning

EventID: A8040402 (hex)

Message: 1027

"Group Delay format with CW Time or Power sweeps produces invalid data."

Severity: Warning

Further explanation: Group Delay format is incompatible with single-frequency sweeps. Invalid data is produced.

Suggestions: Ignore the data or choose a different format or sweep type.

EventID: A8040403 (hex)

Message: 1028

Severity: Informational

"MSG_LIMIT_FAILED"

Further explanation: Limit line test failed.

EventID: 68040404 (hex)

Message: 1029

Severity: Informational

"MSG_LIMIT_PASSED"

Further explanation: Limit line test passed.

EventID: 68040405 (hex)

Message: 1030

"Exceeded the maximum number of measurements allowed."

Severity: Warning

Further explanation: See [Traces, Channels, and Windows on the analyzer](#) for learn about maximum measurements.

EventID: A8040406 (hex)

Message: 1031

"Network Analyzer Internal Error. Unexpected error in AddNewMeasurement."

Severity: Warning

Further explanation: If you continue to get this message, contact product support.

EventID: A8040407 (hex)

Message: 1032

"No measurement was found to perform the selected operation. Operation not completed."

Severity: Warning

Further explanation: None

Suggestions: Create a measurement before performing this operation.

EventID: A8040408 (hex)

Message: 1033

The Markers All Off command failed.

Severity: Warning

EventID: A8040409 (hex)

Message: 1034

"A memory trace has not been saved for the selected trace. Save a memory trace before attempting

trace math operations."

Severity: Warning

Further explanation: Must have a memory trace when trying to do Trace Math,

EventID: A804040A (hex)

Message: 1035

"MSG_SET_AVERAGE_COMPLETE"

Severity: Informational

Further explanation: Informational for COM programming. Averaging factor has been reached.

EventID: 6804040B (hex)

Message: 1036

"MSG_CLEAR_AVERAGE_COMPLETE"

Further explanation: Informational for COM programming. Averaging factor has NOT been reached.

EventID: 6804040C (hex)

Message: 1037

"Time Domain transform requires at least 3 input points. The transform has been deactivated."

Severity: Informational

Further explanation: None

Suggestions: Increase the number of points.

EventID: 6804040D (hex)

Message: 1038

Smoothing requires a scalar format, and has been deactivated.

Severity: Informational

EventID: 6804040E (hex)

Message: 1039

A receiver power calibration in this instrument state file cannot be recalled into this firmware version.

Severity: Warning

EventID: A804040F (hex)

Message: 1047

Could not achieve target power.

Severity: Error

Further explanation: This indicates that the analyzer was unable to find a source power during the THRU step of the cal sufficiently high to boost the measured noise power on port 2 to 6 dB above the noise floor.

Message: 1056

ERROR: The given LO number is out of range. For a one stage mixer, this number must be 1. For a two stage mixer, this number can be 1 or 2.

Severity: Error

Further explanation: None

Message: 1063

"The trigger connection argument was not recognized as valid by the firmware."

Severity: Error

Further explanation: This indicates that the analyzer was unable to find a source power during the THRU step of the cal sufficiently high to boost the measured noise power on port 2 to 6 dB above the noise floor.

Message: 1073

"Unexpected error"

Severity: Error

Further explanation: None

Message: 1084

"User Preset was issued, but no user preset state had been set."

Severity: Error

Further explanation: None

Message: 1100

"Exceeded limit on number of measurements."

Severity: Error

Further explanation: See [Traces, Channels, and Windows on the analyzer](#) for measurement limits.

EventID: E8040450 (hex)

Message: 1104

"Exceeded limit on number of measurements."

Severity: Error

Further explanation: See [Traces, Channels, and Windows on the analyzer](#) for measurement limits.

EventID: E8040450 (hex)

Message: 1105

"Parameter not valid."

Severity: Error

Further explanation: A measurement parameter that was entered programmatically is not valid.

EventID: E8040451 (hex)

Message: 1106

"Measurement not found."

Severity: Error

Further explanation: Any of these could be the cause:

Trying to calibrate but already have maximum measurements.

Trying to do a confidence check but there is not a measurement.

Trying to create, activate, or alter a measurement through COM that has been deleted through the front panel.

Trying to use a trace name through programming that is not unique.

EventID: E8040452 (hex)

Message: 1107

"No valid memory trace."

Severity: Error

Further explanation: Must have a memory trace when trying to do Trace Math,

Suggestions: Store a memory trace.

EventID: E8040453 (hex)

Message: 1108

"The reference marker was not found."

Severity: Error

Further explanation: Attempted to create a delta marker without first creating a reference marker (COM only).

EventID: E8040454 (hex)

Message: 1109

"Data and Memory traces are no longer compatible. Trace Math has been turned off."

Severity: Error

Further explanation: Warning - channel setting has changed while doing trace math.

Suggestions: Store another memory trace and turn trace math back on.

EventID: A8040455 (hex)

Message: 1110

"Data and Memory traces are not compatible. For valid trace math operations, memory and data traces must have similar measurement conditions."

Severity: Error

Further explanation: Tried to do trace math without compatible data and memory traces.

Suggestions: Store another memory trace.

EventID: E8040456 (hex)

Message: 1111

"Marker Bandwidth not found."

Severity: Error

Further explanation: Could not find a portion of trace that meets the specified bandwidth criteria.

EventID: E8040457 (hex)

Message: 1112

"The peak was not found."

Severity: Error

Further explanation: Could not find portion of trace that meets peak criteria.

Suggestions: See Marker Peak criteria.

EventID: E8040458 (hex)

Message: 1113

"The target search value was not found."

Severity: Error

Further explanation: Could not find interpolated data point that meets search value.

EventID: E8040459 (hex)

Message: 1114

"Reflection measurement, such as S11, must supply an auxiliary port to disambiguate 2-port measurements on multiport instruments."

Severity: Error

Further explanation:

EventID: E804045A (hex)

Message: 1115

"The receiver power calibration has been turned off because the type of measurement or source port has

changed, so the calibration is no longer valid."

Severity: Warning

Further explanation:

EventID: A804045B (hex)

Message: 1116

"Receiver power cal requires the active measurement to be of unratiod power."

Severity: Warning

Further explanation:

EventID: A804045C (hex)

Message: 1117

"There is currently no source power calibration associated with the channel and source port of the active measurement. A source power cal should be performed or recalled before performing a receiver power calibration."

Severity: Warning

Further explanation:

EventID: A804045D (hex)

Message: 1118

"The attempted operation can only be performed on a standard measurement type."

Severity: Error

Further explanation:

EventID: E804045E (hex)

Message: 1119

"The custom measurement cannot be loaded because it is not compatible with the Network Analyzer hardware."

Severity: Error

Further explanation:

Suggestions:**EventID:** E804045F (hex)**Message: 1120**

"The custom measurement cannot be loaded because it is not compatible with the Network Analyzer software."

Severity: Error**Further explanation:****EventID:** E8040460 (hex)**Message: 1121**

"The custom measurement load operation failed for an unspecified reason."

Severity: Error**Further explanation:****EventID:** E8040461 (hex)**Message: 1122**

"The custom measurement data processing has generated an unhandled exception, and will be terminated. The analyzer software may be in an unstable state and it is recommended that the analyzer software be shutdown and restarted."

Severity: Error**Further explanation:****EventID:** E8040462 (hex)**Message: 1123**

"The attempted operation can only be performed on a custom measurement type."

Severity: Error**Further explanation:****EventID:** E8040463 (hex)**Message: 1124**

"The requested custom measurement is not available."

Severity: Error

Further explanation:

EventID: E8040464 (hex)

Message: 1125

"The requested custom algorithm was not found."

Severity: Error

Further explanation:

EventID: E8040465 (hex)

Message: 1126

"Normalization cannot be turned on because the measurement does not have a valid divisor buffer."

Severity: Error

Further explanation:

EventID: E8040466 (hex)

Message: 1127

"The Raw Data requested by the measurement could not be provided."

Severity: Warning

Further explanation:

EventID: A8040467 (hex)

Message: 1128

"The selected Sweep Type does not allow Transform and Gating. Transform and Gating disabled."

Severity: Error

Further explanation:

EventID: E8040468 (hex)

Message: 1129

"Memory trace can not be applied to this measurement"

Severity: Error

EventID: E8040469 (hex)

Message: 1130

"ERROR: This feature is not available on this model of hardware."

Severity: Error

Message: 1131

"The data provided has an invalid number of points. It could not be stored."

Severity: Error

EventID: E804046B (hex)

Message: 1132

"The measurement stored in the save/recall state has an invalid version. It could not be loaded."

Severity: Error

EventID: E804046C (hex)

Message: 1133

"This data format argument for this operation must be "naDataFormat_Polar"

Severity: Error

EventID: E804046D (hex)

Message: 1134

This data format argument for this operation must be a scalar data format

Severity: Error

EventID: E804046E (hex)

Message: 1135

The memory trace is not valid for the current measurement setup.

Severity: Error

EventID: E804046F (hex)

Message: 1136

This measurement is incompatible with existing measurements in this channel. Choose another channel.

Severity: Error

EventID: E8040470 (hex)

Message: 1137

Port extension correction is not available for offset frequency measurements. Port extension correction has been disabled.

Severity: Error

EventID: E8040471 (hex)

Message: 1138

Physical port number assignments for logical port mappings must be unique.

Severity: Error

EventID: E8040472 (hex)

Message: 1140

"Power saturation back-off value was not found"

Severity: Error

Further explanation: None

Suggestions: None

Message: 1141

"Power normal operating point was not found"

Severity: Error

Further explanation: None

Suggestions: None

Message: 1147

"Specified external device was not found."

Severity: Error

Further explanation: None

Suggestions: None

Message: 1179

"Commas are not allowed."

Severity: Error

Further explanation: None

Suggestions: None

Parser Errors

Message: 1281

"You have sent a read command to the analyzer without first requesting data with an appropriate output command. The analyzer has no data in the output queue to satisfy the request."

Severity: Error

EventID: 68050501 (hex)

Message: 1282

"You must remove the active controller from the bus or the controller must relinquish the bus before the analyzer can assume the system controller mode."

Severity: Error

EventID: E8050502(hex)

Message: 1283

"The analyzer did not receive a complete data transmission. This is usually caused by an interruption

of the bus transaction."

Severity: Error

EventID: E8050503 (hex)

Message: 1284

"The instrument status byte has changed."

Severity: Informational

EventID: 68050504 (hex)

Message: 1285

"The SCPI command received has caused error number %1: "%2"."

Severity: Informational

EventID: 68050505 (hex)

Message: 1286

"The INET LAN server has been started as process number %1."

Severity: Informational

EventID: 68050506 (hex)

Message: 1360

"Execution of the SCPI command has failed"

Severity: Error

EventID: E8050550 (hex)

Message: 1361

" The INET/LAN device is not accessible."

Severity: Error

EventID: E8050551 (hex)

Message: 1362

"The INET/LAN driver was not found. "

Severity: Error

EventID: E8050552 (hex)

Message: 1363

"The INET/LAN driver was not found."

Severity: Error

EventID: E8050553 (hex)

Message: 1364

"The INET/LAN device is unable to acquire the necessary resources. "

Severity: Error

EventID: E8050554 (hex)

Message: 1365

"The INET/LAN device generated a generic system error. "

Severity: Error

EventID: E8050555 (hex)

Message: 1366

"Invalid address for the INET/LAN device."

Severity: Error

EventID: E8050556 (hex)

Message: 1367

"The INET I/O library was not found. "

Severity: Error

EventID: E8050557 (hex)

Message: 1368

"An error occurred in the INET system. "

Severity: Error

EventID: E8050558 (hex)

Message: 1369

"Access to the INET/LAN driver was denied. "

Severity: Error

EventID: E8050559 (hex)

Message: 1370

"Could not load error system message dll."

Severity: Error

EventID: E805055A (hex)

Message: 1371

"ErrorSystemMessage.dll does not export the right function."

Severity: Error

EventID: E805055B (hex)

Message: 1372

"Custom scpi library was not able to be knitted"

Severity: Error

EventID: E805055C (hex)

Message: 1373

"Could not knit the scpi error messages from the ErrorSystemMessage lib"

Severity: Error

EventID: E805055D (hex)

Message: 1374

Command is obsolete with this software version.

Severity: Error

EventID: E808055E (hex)

Message: 1375

CALC measurement selection set to none. Use [Calc:Par:Sel](#)

Severity: Error

EventID: E808055F (hex)

Message: 1535

"Parser got command: %1."

Severity: Informational

EventID: 680505FF (hex)

Display Errors 1536 - 1621

Message: 1536

"Exceeded the maximum of 4 traces in each window. The trace for <x> will not be added to window <x>."

Severity: Warning

Further explanation: None

Suggestions: Create the trace in another window. See the [analyzer window limits](#).

EventID: A8060600 (hex)

Message: 1537

"Exceeded the maximum of 16 data windows. New window will not be created."

Severity: Warning

Further explanation: None

Suggestions: Create the trace in an existing window. See the [analyzer window limits](#).

EventID: A8060601 (hex)

Message: 1538

"No Data Windows are present. Unable to complete operation."

Severity: Warning

Further explanation: Your remote SCPI operation tried to create a new measurement while there were no windows present

Suggestions: Create a new window before creating the measurement. See example [Create a measurement using SCPI](#)

EventID: A8060602 (hex)

Message: 1539

"No data traces are present in the selected window. Operation not completed."

Severity: Warning

Further explanation: None

EventID: A8060603 (hex)

Message: 1540

"Cannot complete request to arrange existing measurements in <x> windows due to the limit of <x> traces per window."

Severity: Informational

Further explanation: The arrange window feature cannot put the existing traces into the number of windows you requested because only 4 traces per window are allowed. See [Arranging Existing Measurements](#)

Suggestions: Either create more windows or delete some traces.

EventID: 68060604 (hex)

Message: 1541

"Unable to establish a connection with the specified printer."

Severity: Warning

Further explanation: None

Suggestions: Refer to Printer Help

EventID: A8060605 (hex)

Message: 1542

"Printout canceled."

Severity: Informational

EventID: 68060606 (hex)

Message: 1616

"Window not found."

Severity: Error

Further explanation: A window was specified in your program which does not exist.

Suggestions: Query the name of your window before specifying.

EventID: E8060650 (hex)

Message: 1617

"Duplicate window ID specified."

Severity: Error

Further explanation: None

EventID: E8060651 (hex)

Message: 1618

"Exceeded limit on number of windows."

Severity: Error

Further explanation: There is a limit of 4 windows per screen.

EventID: E8060652 (hex)

Message: 1619

"Exceeded limit on number of traces/window."

Severity: Error

Further explanation: There is a limit of 4 traces per window. See the [Traces, Channels, and Windows on the analyzer](#).

Suggestions: Create the trace in another window

EventID: E8060653 (hex)

Message: 1620

"Trace not found."

Severity: Error

Further explanation: Your program tried to communicate with a non-existing trace.

Suggestions:Query the trace ID before writing to it.

EventID: E8060654 (hex)

Message: 1621

"The operating system does not recognize this printer."

Severity: Warning

EventID: A8060655 (hex)

Message: 1622

Duplicate trace ID specified.

Severity: Error

EventID: E8060656 (hex)

Channel Errors 1792 -1878

Message: 1792

"Sweep Complete."

Severity: Informational

Further explanation: None

Suggestions:None

EventID: 68070700 (hex)

Message: 1793

"All triggerable acquisitions have completed."

Severity: Informational

Further explanation:

EventID: 68070701 (hex)

Message: 1794

"The last trigger produced an aborted sweep."

Severity: Informational

Further explanation:

EventID: 68070702 (hex)

Message: 1795

"The segment list must be adjusted to have at least one active segment with more than 0 points to use segment sweep."

Severity: Informational

Further explanation: You attempted to change **Sweep type** to Segment sweep, but there is either no segments defined or no sweep points in the defined segments

Suggestions: Define at least one segment with at least one measurement point. See Segment sweep for more information

EventID: 68070703 (hex)

Message: 1796

"MSG_SET_CHANNEL_DIRTY"

Severity: Informational

Further explanation: This informational message occurs when a channel setting has changed but the channel still has data that was taken with the previous setting. The following CLEAR message occurs when new channel data is taken.

EventID: 68070704 (hex)

Message: 1797

"MSG_CLEAR_CHANNEL_DIRTY"

Severity: Informational

Further explanation: The previous SET message occurs when a channel setting has changed but the channel still has data that was taken with the previous setting. This CLEAR message occurs when new channel data is taken.

EventID: 68070705 (hex)

Message: 1798

Sweep time has changed from Auto to Manual mode. If desired to return to Auto mode, enter sweep time value of 0.

Severity: Informational

EventID: 68070706 (hex)

Message: 1799

"Set Sweep Completed"

Severity: Informational

Further explanation: This event occurs when a sweep and it's associated sweep calculations finish. This is typically when all sweeps on a channel complete.

EventID: 68070707 (hex)

Message: 1800

"Clear Sweep Completed"

Severity: Informational

Further explanation: This event occurs immediately after the SET SWEEP COMPLETED event. These two events set and clear the "Sweep Completed" bit (bit 4) on the SCPI Device Status register.

EventID: 68070708 (hex)

Message: 1801

"All Sweeps Completed and Processed"

Severity: Informational

Further explanation: This event occurs when all of the sweeps and sweep calculations are complete for a channel.

EventID: 68070709 (hex)

Message: 1802

Low Pass : Frequency limits have been changed.

Severity: Informational

EventID: 6807070A (hex)

Message: 1803

Low Pass : Number of points have been changed.

Severity: Informational

EventID: 6807070B (hex)

Message: 1804

Low Pass : Frequency limits and number of points have been changed.

Severity: Informational

EventID: 6807070C (hex)

Message: 1805

"Channel created"

Severity: Informational

EventID: 6807070D (hex)

Message: 1806

"Channel deleted"

Severity: Informational

EventID: 6807070E (hex)

Message: 1872

"Channel not found."

Severity: Error

Further explanation: A non-existent channel is being referenced under program control.

Suggestions: Query the channel number, then refer to it by number.

EventID: E8070750 (hex)

Message: 1873

"The requested sweep segment was not found."

Severity: Error

Further explanation: A non-existent sweep segment is being referenced under program control.

EventID: E8070751 (hex)

Message: 1874

"The sweep segment list is empty."

Severity: Error

Further explanation: Segment Sweep cannot be specified unless there is at least one defined segment. This error will only occur under remote control.

EventID: E8070752 (hex)

Message: 1875

"The number of points in active sweep segment list segments is 0."

Severity: Error

Further explanation: Segment Sweep cannot be specified unless there is at least data point specified in a segment. This error will only occur under remote control.

EventID: E8070753 (hex)

Message: 1876

"The specified source attenuator is not valid."

Severity: Error

Further explanation: You tried to set the Attenuator property on the Channel object on a analyzer that doesn't have a source attenuator.

EventID: E8070754 (hex)

Message: 1877

"Log Frequency sweep cannot be selected with the current Number of Points. Please reduce Number of Points."

Severity: Error

Further explanation: The maximum number of points that can be used for Log sweep is 401.

EventID: E8070755 (hex)

Message: 1878

"The requested Number of Points is greater than can be selected for Log Frequency sweep."

Severity: Error

Further explanation: The maximum number of points that can be used for Log sweep is 401.

EventID: E8070756 (hex)

Message: 1879

"Response frequencies exceeded instrument range so Frequency Offset has been turned off."

Severity: Error

Further explanation: This error is returned whenever the instrument detects that the stimulus sweep setup and Frequency Offset settings result in computed response frequencies that exceed instrument limits. When this occurs, the instrument automatically turns off Frequency Offset to avoid the out-of-range conditions.

Suggestions: When this condition has occurred, change settings for either the stimulus frequencies or Frequency Offset so that the Response frequencies are within instrument bounds. Once this is done, Frequency Offset can once again be turned on.

EventID: E8070757 (hex)

Message: 1880

The total number of points for all the given segments exceeds the maximum number of points supported. The segments were not changed.

Severity: Error

EventID: E8070758 (hex)

Message: 1881

This instance of the Channels object was not used to place the channels in Hold, so no channels were resumed.

Severity: Error

EventID: E8070759 (hex)

Message: 1882

The port number was outside the range of allowed port numbers.

Severity: Error

EventID: E807075A (hex)

Message: 1883

More ports than are present are required for this operation.

Severity: Error

EventID: E807075B (hex)

General Errors

Message: 2009

"Channel is not a mixer channel."

Severity: Error

Further explanation: None

Suggestions: None

Message: 2010

"The external testset type is invalid."

Severity: Error

Further explanation: None

Suggestions: None

Message: 2011

"No ports were specified"

Severity: Error

Further explanation: None

Suggestions: None

Message: 2012

"Cannot couple primary domain range."

Severity: Error

Further explanation: None

Suggestions: None

Message: 2015

"The copy channel operation failed because the target channel exists and is incompatible with the source channel."

Severity: Error

Further explanation: None

Suggestions: None

Message: 2019

"Invalid sweep number."

Severity: Error

Further explanation: None

Suggestions: None

Message: 2020

"IMD channel tracking not enabled."

Severity: Error

Further explanation: None

Suggestions: None

Message: 2022

"Compression analysis not enabled due to invalid parameter(s)"

Severity: Error

Further explanation: None

Suggestions: None

Message: 2023

"External receiver configuration not available."

Severity: Error

Further explanation: None

Suggestions: None

Message: 2025

"Error term data not found."

Severity: Error

Further explanation: None

Suggestions: None

Message: 2028

"The PNA platform does not support ON mode for virtual bridge. The only supported modes are AUTO and OFF."

Severity: Error

Further explanation: None

Suggestions: None

Message: 2048

"The function you requested requires a capability provided by an option to the standard analyzer. That

option is not currently installed."

Severity: Error

Further explanation: None

Suggestions: To view the options on your analyzer, click **Help / About Network Analyzer**. For more information see [analyzer Options](#)

EventID: 68080800 (hex)

Message: 2049

"The feature you requested is not available on the current instrument."

Severity: Error

Further explanation: None

EventID: 68080801 (hex)

Message: 2050

"The feature you requested is incompatible with the current instrument state."

Severity: Error

Further explanation: None

Suggestions: None

EventID: 68080802 (hex)

Message: 2051

"File<x> has been saved."

Severity: Informational

Further explanation: None

EventID: 68080803 (hex)

Message: 2052

"Attempt to save <x> failed."

Severity: Error

Further explanation: None

Suggestions: If using a floppy disk, ensure it is inside the drive and the disk is not full. Check the filename for special characters.

EventID: E8080804 (hex)

Message: 2053

"Attempt to recall file failed because <x> was not found."

Severity: Error

Further explanation: None

EventID: E8080805 (hex)

Message: 2054

"<x> has a bad header."

Severity: Error

Further explanation: None

Suggestions: Recopy the file and / or delete the file.

EventID: E8080806 (hex)

Message: 2056

"Request to enter hibernate state."

Further explanation: None

EventID: 68080808 (hex)

Message: 2057

"Power up from automatic hibernate state. Program received PBT_APMRESUMEAUTOMATIC Message."

Further explanation: None

EventID: 68080809 (hex)

Message: 2058

"Power up from suspend hibernate state. Program received PBT_APMRESUMESUSPEND Message."

Further explanation: None

EventID: 6808080A (hex)

Message: 2059

"Power up from suspend hibernate state. Program received PBT_APMRESUMECRITICAL Message."

Severity: Warning

Further explanation: None

EventID: A808080B (hex)

Message: 2060

"Power up from unknown hibernate state UI recovery called. Program received no PBT_Message within the time allotted and is attempting recovery."

Severity: Warning

Further explanation: None

EventID: A808080C (hex)

Message: 2061

"<x> already exists. File is being overwritten."

Further explanation: Used only for remote applications

EventID: 6808080D (hex)

Message: 2062

"File has not been saved."

Severity: Error

Further explanation: Used only for remote applications

EventID: E808080E (hex)

Message: 2063

"File <x> has been recalled."

Further explanation: Used only for remote applications

EventID: 6808080F (hex)

Message: 2064

"State version in <x> is considered obsolete by this version of this code."

Severity: Error

Further explanation: You attempted to recall a file that is no longer valid.

Suggestions: You must recreate the file manually.

EventID: E8080810 (hex)

Message: 2065

"State version in <x> is newer than the latest version supported by this code."

Severity: Error

Further explanation: You attempted to recall a file that was created by a later version of the analyzer application.

Suggestions: You must recreate the file manually.

EventID: E8080811 (hex)

Message: 2066

"Error occurred while reading file <x>"

Severity: Error

Further explanation: The file may be corrupt.

Suggestions: Try to recreate the file.

EventID: E8080812 (hex)

Message: 2067

"Windows shell error: <x>"

Severity: Error

Further explanation: None

EventID: E8080813 (hex)

Message: 2068

Send message timed out returning: <x>.

Severity: Error

Further explanation: None

EventID: E8080814 (hex)

Message: 2069

"Changing GPIB mode to System Controller."

Severity: Informational

Further explanation: None

EventID: 68080815 (hex)

Message: 2070

"Changing GPIB mode to Talker Listener."

Severity: Informational

Further explanation: None

EventID: 68080816 (hex)

Message: 2071

"The Network Analyzer can not be put in GPIB System Controller mode until the GPIB status is Local. Stop any remote GPIB programs which may be using the Network analyzer, press the Macro/Local key and try again. "

Severity: Informational

Further explanation: See **LCL and RMT Operation**

Suggestions: Press the Macro/Local key and try again.

EventID: 68080817 (hex)

Message: 2120

"This method can not be invoked through a late-bound COM call."

Severity: Error

Further explanation: None

Suggestions: Use the alternate method described in the COM programming documentation

EventID: E8080878 (hex)

Message: 2128

"The specified format is invalid."

Severity: Error

Further explanation: None

EventID: E8080850 (hex)

Message: 2129

"WINNT exception caught by Automation layer."

Severity: Error

Further explanation: None

EventID: E8080851 (hex)

Message: 2130

"Bad port specification."

Severity: Error

Further explanation: None

EventID: E8080852 (hex)

Message: 2131

"Failed to find a printer."

Severity: Error

Further explanation: None

Suggestions: See [Connecting to a Printer](#)

EventID: E8080853 (hex)

Message: 2132

"Manual trigger ignored."

Severity: Error

Further explanation: None

EventID: E8080854 (hex)

Message: 2133

"Attempt to set trigger failed."

Severity: Error

Further explanation: None

EventID: E8080855 (hex)

Message: 2134

"Macro execution failed."

Severity: Error

Further explanation: None

EventID: E8080856 (hex)

Message: 2135

"Specified macro definition is incomplete."

Severity: Error

Further explanation:

EventID: E8080857 (hex)

Message: 2137

"Block data length error."

Severity: Error

Further explanation: See [Getting Data from the Analyzer](#)

EventID: E8080859 (hex)

Message: 2139

"Requested data not found."

Severity: Error

Further explanation: None

EventID: E808085B (hex)

Message: 2142

"The parameter supplied was out of range, so was limited to a value in range before being applied to the instrument."

Severity: Success

Further explanation: None

Suggestions: View range limits before sending programming commands.

EventID: 2808085E (hex)

Message: 2143

The parameter supplied was out of range, so was limited to a value in range before being applied to the instrument.

Severity: Error

EventID: E808085F (hex)

Message: 2144

"Request failed. The required license was not found."

Severity: Error

Further explanation: None

EventID: E8080860 (hex)

Message: 2145

"A remote call to the front panel has returned hresult <x>"

Severity: Error

Further explanation: This may indicate a problem with the front panel

Suggestions: Contact Technical support

EventID: E8080861 (hex)

Message: 2146

The recall operation failed.

Severity: Error

Further explanation:

EventID: E8080862 (hex)

Message: 2147

Attempt to save file failed.

Severity: Error

Further explanation:

EventID: E8080863 (hex)

Message: 2148

Recall attempt failed because file was not found.

Severity: Error

Further explanation:

EventID: E8080864 (hex)

Message: 2149

Recall file has a bad header.

Severity: Error

Further explanation:

EventID: E8080865 (hex)

Message: 2150

Recall file version is obsolete and no longer compatible with this instrument.

Severity: Error

Further explanation:

EventID: E8080866 (hex)

Message: 2151

The recall file contains an istate version newer than this instrument. A remote call to the front panel has returned hresult %1

Severity: Error

Further explanation:

EventID: E8080867 (hex)

Message 2152

"Front Panel <x>

Severity: Error

Further explanation: None

EventID: E8080868 (hex)

Message 2153

"Front Panel message"

Severity: Informational

Further explanation: None

EventID: 68080869 (hex)

Message 2154

"Power Service <x>

Severity: Error

Further explanation: There is more than 1 instance of powerservice running. There should only be one running. This might happen after running install shield - especially when upgrading the CPU

board.

Suggestions: Try rebooting. If this persists, please call [Customer Support](#).

EventID: E808086A (hex)

Message 2155

"Power Service <x>

Severity: Informational

Further explanation: None

EventID: 6808086B (hex)

Message 2156

"The Keysight Technologies GPIB driver can not be loaded or unloaded."

Severity: Error

Further explanation: None

Suggestions: If the problem persists, from the analyzer desktop, right-click on My Computer. Click Properties, Click Hardware Tab. Click Device Manager Button. Expand GPIB Devices. Right-click and click Uninstall all GPIB interfaces devices. Reboot the analyzer.

EventID: E808086C (hex)

Message 2157

"The National Instruments GPIB driver can not be loaded or unloaded."

Severity: Error

Further explanation: None

Suggestions: If the problem persists, from the analyzer desktop, right-click on My Computer. Click Properties, Click Hardware Tab. Click Device Manager Button. Expand GPIB Devices. Right-click and click Uninstall all GPIB interfaces devices. Reboot the analyzer.

EventID: E808086D (hex)

Message 2158

"The Keysight GPIB driver is loaded but it can not start its parser."

Severity: Error

Further explanation: None

EventID: E808086E (hex)

Message: 2159

The front panel is in remote mode.

Severity: Warning

EventID: A808086F (hex)

Message: 2160

The Registry Key specified could not be found.

Severity: Error

EventID: E8080870 (hex)

Message: 2161

An overcurrent condition has been detected on a probe plugged into the front panel.

Severity: Warning

EventID: A8080871 (hex)

Message: 2162

The operation timed out.

Severity: Error

EventID: E8080872 (hex)

Message 2163

"The Network Analyzer executed a preset."

Severity: Informational

Further explanation: None

EventID: 68080873 (hex)

Message 2164

"Access to file denied."

Severity: Error

Further explanation: This means that the system can not open an output file for writing. Most likely because the file is write protected.

Suggestions: Pick another file name or file directory, check floppy disk hard disk write access.

EventID: E8080874 (hex)

Message 2165

"File type is structured storage."

Severity: Informational

Further explanation: None

EventID: 68080875 (hex)

Message 2166

"The trigger operation failed."

Severity: Error

Further explanation: None

EventID: E8080876 (hex)

Message 2167

"Argument out of range error."

Severity: Error

Further explanation: None

Suggestions: None

EventID: E8080877 (hex)

Message: 2169

The given COM object is not a custom application

Severity: Error

EventID: E8080879 (hex)

Message: 2170

The eventID supplied was not recognized as a valid analyzer eventID

Severity: Error

EventID: E808087A (hex)

Message: 2171

The operation was canceled.

Severity: Error

EventID: E808087B (hex)

Message: 2172

High security level cannot be disabled directly. Only an instrument preset or recall of lower security instrument state will reset this security level.

Severity: Error

EventID: E808087C (hex)

Message: 2173

Local lockout mode is on. The analyzer application will not accept input from front panel, keyboard or mouse until this mode is turned off from a remote interface.

Severity: Error

EventID: E808087D (hex)

Message: 2174

The SnP request is not valid for the selected measurement.

Severity: Error

EventID: E808087E (hex)

Message: 2175

Preset is not supported while this dialog or wizard is open. Close the dialog or wizard and then try again.

Severity: Error

EventID: E808087F (hex)

Message: 2176

The function you requested requires a capability provided by an option to the standard analyzer. That option is not currently installed.

Severity: Error

EventID: E8080880 (hex)

Message: 2177

Catastrophic error. Crash dump recorded at <n>

Severity: Error

EventID: E8080881 (hex)

Message: 2179

Failed to open gen.lic.

Severity: Error

EventID: E8080883 (hex)

Message: 3002

Bad port specification.

Severity: Error

About Error Messages

Analyzer errors and Operating System errors are displayed and logged in an error file. You can choose how to display errors, or choose to not display errors at all.

- [Error Display](#)
- [View Error Log](#)
- [List of VNA Errors](#)
- [SCPI Errors](#)

Other System topics

Error Display

By default, error messages appear on the screen for a brief period. You can choose to have them stay on the screen until you click an **OK** button, or have them not appear at all. When they stay on the screen, a Help button is available to provide further assistance.

How to select the display of Error Messages

Using [Hardkey](#)/[SoftTab](#)/[Softkey](#)

1. Press [System](#) > [Help](#) > [Error Display...](#)

[Programming Commands](#)

Error Display dialog box help

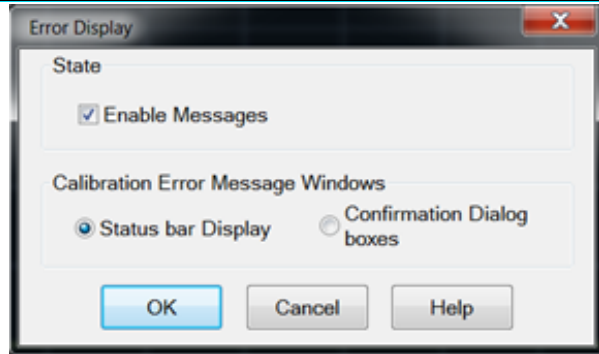

On Preset, these settings revert to their defaults (enabled, timed popups).

Enable Messages Check to display all error messages as they occur. Clear to suppress the display of error messages. You can still view them in the [error log](#).

Calibration Error Message Windows

Status bar Display Displays error messages on the screen for a duration of time proportional to the length of the message. You can then view the message in the [error log](#) and get further assistance.

Confirmation Dialog boxes Displays error messages in a standard dialog box. You then choose **OK** or **Cancel** to close the dialog box, or press **Help** to get further information on the error message.

View Error Log

The analyzer Error Log is a list of all events that have occurred. (Events are used in programming the analyzer using COM.) Analyzer errors are a subset of events. Only events with severity codes of ERROR are displayed on the screen as they occur. From the error log, you can access further help with an error by selecting the error and clicking Help.

How to view the Error Log

Using **Hardkey/SoftTab/Softkey**

1. Press **System** > **Help** > **View Error Log...**

No programming commands

Error Log dialog box help

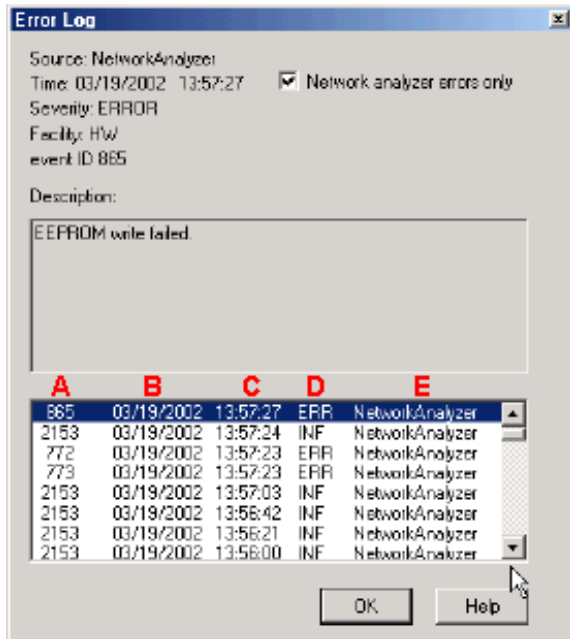

Network analyzer errors only Select to view only analyzer errors. Clear to view all errors that occur on all applications of the computer.

Description Error message that appears on the analyzer screen.

A - Event ID Error message number

B - Date the Error occurred

C - Time the Error occurred

D - Severity Code - All events have one of the following severity codes:

- SUCcess - the operation completed successfully
- INFormational - events that occur without impact on the measurement integrity
- WARning - events that occur with potential impact on measurement integrity
- ERRor - events that occur with serious impact on measurement integrity

E - Application in which the error occurred.

OK Closes the Dialog box

Help Provides further information on the selected Error message

To clear the Error Log:

1. From the **System** > **Main** menu click **Minimize Application**.
2. On the desktop, select **Start, Control Panel**
3. On the Control Panel, click **Administrative Tools**
4. On the Administrative Tools window, click **Event Viewer**
5. On the Event Viewer window, right-click **Application**
6. Select **Clear all Events**
7. If you want to save a file with the contents of the Event Log, click **Yes**. Otherwise, click **No**

To restore the VNA application, click on the VNA Analyzer taskbar button at the bottom of the screen.

Analyzer Accessories

- [Coax Mechanical Calibration Kits](#)
- [Waveguide Mechanical Calibration Kits](#)
- [Electronic Calibration \(ECal\)](#)
- [Mechanical Verification Kits](#)
- [Adapter and Accessory Kits](#)
- [Test Port Cables](#)
- [USB Peripherals](#)
- [Connector Care and ESD Supplies](#)

Other Support topics

For product and order information:

- Visit www.Keysight.com/find/accessories
- Use the search function to locate information about a particular accessory or view the entire RF and Microwave Test Accessories Catalog.

Accessories are available in these connector types:

- 50 ohm Type-N
- 75 ohm Type-N
- 3.5 mm
- 7 mm (APC-7)
- 7-16
- 2.92 mm
- 2.4 mm

- 1.85 mm
- 1 mm

Test port cables and a calibration kit are necessary for a complete measurement system.

A verification kit is used to verify corrected system performance.

Coax Mechanical Calibration Kits

Model	Connector Type	Frequency Upper Limit
85032B	Type-N (50 Ohm)	6 GHz
85032F	Type-N (50 Ohm)	9 GHz
85054B	Type-N (50 Ohm)	18 GHz
85036E	Type-N (75 Ohm)	3 GHz
85050B	7 mm	18 GHz
85033D	3.5 mm	6 GHz
85038A	7-16	7.5 GHz
85033E	3.5 mm	9 GHz
85052B	3.5 mm	26.5 GHz
85052C	3.5 mm TRL	26.5 GHz
85056K	2.92 mm	50 GHz
85056A	2.4 mm	50 GHz
85058B/E (data-based)	1.85 mm	67 GHz
85059A (data-based)	1.00 mm	DC to 110 GHz
85059B (data-based)	1.00 mm	DC to 120 GHz

Waveguide Mechanical Calibration Kits

Model	Connector Type	Frequency Range
X11644A	WR-90	8.2-12.4 GHz
P11644A	WR-62	12.4-18 GHz
K11644A	WR-42	18-26.5 GHz
R11644A	WR-28	26.5-40 GHz
Q11644A	WR-22	33-50 GHz
U11644A	WR-19	40-60 GHz
V11644A	WR-15	50-75 GHz

Electronic Calibration (ECal)

Model	Connector Type	Frequency Range
RF Two-Port		
85091C	7 mm (APC-7)	300 kHz-9 GHz
85092C	Type-N (50 ohm) Port B available with 3.5 mm or 7-16 ^a	300 kHz-9 GHz
85093C	3.5 mm Port B available with Type-N (50 ohm) or 7-16 ^a	300 kHz-9 GHz
85096C	Type-N (75 ohm)	300 kHz-3 GHz
85098C	7-16 ^a Port B available with Type-N (50 ohm) or 3.5 mm	300 kHz-7.5 GHz
85099C	Type-F	300 kHz-3 GHz
RF Four-Port		
N4431B	3.5mm (f) (four-port), Type-N (f) (four-port), Mixed connector types	9 kHz ^b -13.5 GHz
N4432A Option 020	Type-N (f) (four-port)	300 kHz-18 GHz (available Feb. 2006)
N4432A Option 030	APC 7 (four-port)	300 kHz-18 GHz (available Feb. 2006)

N4433A Option 010	3.5mm (f) (four-port)	300 kHz-20 GHz (available Feb. 2006)
Microwave Two-Port^c		
N4690D	Type-N (50 ohm)	DC/300 kHz-18 GHz
N4691D	3.5 mm	DC/300 kHz-26.5 GHz
N4692D	2.92 mm	DC/10 MHz-40 GHz
N4693D	2.4 mm	DC/10 MHz-50 GHz
N4694D	1.85 mm	DC/10 MHz-67 GHz
N4696D	7 mm	DC/300 kHz-18 GHz
N4690B	Type-N (50 ohm)	300 kHz-18 GHz
N4691B	3.5 mm	300 kHz-26.5 GHz
N4692A	2.92 mm	10 MHz-40 GHz
N4693A	2.4 mm	10 MHz-50 GHz
N4694A	1.85 mm	10 MHz-67 GHz
N4696BA	7 mm	300 kHz-18 GHz

a Limits ECal module high frequency to 7.5 GHz.

b Performance from 9 kHz to 300 kHz is valid only for the E5071C with firmware version A.09.10 and above, and E5080A with firmware A.11.70.03 and above.

c N469xD models are supported with firmware version A.12..60.02 and above.

Verification Kits

Model	Connector Type	Frequency Range
85055A	Type-N (50 Ohm)	300 kHz-9 GHz
85053B	3.5 mm	300 kHz-26.5 GHz
85057B	2.4 mm	.045-50 GHz
85059V	1.00 mm	DC to 120 GHz
R11645A	WR-28	26.5-40 GHz
Q11645A	WR-22	33-50 GHz

Adapters and Accessory Kits

Model	Description
11878A	Type-N to 3.5 mm Adapter Kit
11525A	Type-N (m) to 7 mm (APC-7)
11853A	Type-N Accessory Kit
11900B	2.4 mm (f) to 2.4 mm (f)
11900C	2.4 mm (f) to 2.4 mm (m)
85130G	Test Port Adapter Set, 2.4 mm (f) to 2.4 mm (m,f)
11901B	2.4 mm (f) to 3.5 mm (f)
11901D	2.4 mm (f) to 3.5 mm (m)
85130F	Test Port Adapter Set, 2.4 mm (f) to 3.5 mm (m,f)
11902B	2.4 mm (f) to 7 mm (APC-7)
11920A	1 mm (m) to 1 mm (m)
11920B	1 mm (f) to 1 mm (f)
11920C	1 mm (m) to 1 mm (f)
11921A	1 mm (m) to 1.85 mm (m)
11921B	1 mm (f) to 1.85 mm (f)
11921C	1 mm (m) to 1.85 mm (f)
11921D	1 mm (f) to 1.85 mm (m)
11922A	1 mm (m) to 2.4 mm (m)
11922B	1 mm (f) to 2.4 mm (f)
11922C	1 mm (m) to 2.4 mm (f)
11922D	1 mm (f) to 2.4 mm (m)

Test Port Cables

Model	Description
N4697E	1.85 mm (f) to 1.85 mm (rugged f) flexible (single)
N4697F	1.85 mm (rugged f, f) to 1.85 mm (rugged m, rugged f) flexible (set)
N6315A	Type-N (m) to Type-N (f), 16 in. (single)
N6314A	Type-N (m) to Type-N (m), 24 in. (single)
85133D	2.4 mm (f) to 2.4 mm (m,f) semi-rigid (set)
85133F	2.4 mm (f) to 2.4 mm (m,f) flexible (set)
85134D	2.4 mm (f) to 3.5 mm (m,f) semi-rigid (set)
85134F	2.4 mm (f) to 3.5 mm (m,f) flexible (set)

USB Peripherals

Model	Description
N4688A	CD RW drive - with USB cable.
N4689A	USB 4-port hub - for connecting additional USB peripherals.
82357A	USB/GPIB Interface - for controlling GPIB devices through USB. Learn more about using the 82357A with the VNA

Connector and ESD Supplies

[See ESD topic](#)

[See more Connector Care supplies](#)

Part Number	Description
9300-1367	Adjustable antistatic wrist strap
9300-0980	Antistatic wrist strap grounding cord (5 foot)
9300-0797	Static control table mat (2 foot x 4 foot) with earth ground wire
9300-1126	ESD heel strap
1401-0248	ESD Safe End-Cap, Type-N (m)
1401-0247	ESD Safe End-Cap, Type-N (f)
1401-0214	Standard End-Cap, Type-N (m)
1401-0225	Standard End-Cap, Type-N (f)

Firmware Update

VNA firmware updates are available to you at no cost in a self-extracting Install Shield file. The update includes the VNA application, Online help, and Service Utilities.

To manually check the version of firmware on the VNA, click **System** > **Help** > **About NA...**

Note: After a firmware update...

- Custom Cal Kits must be imported. [Learn more](#)
- If a different desktop icon named "Network Analyzer" exists, the shortcut to the VNA application will assume the same icon. Right-click on the desktop, then click **Refresh**.

Other Support Topics

Updating firmware

1. Download the latest firmware from or <http://www.keysight.com/find/na>
 2. Terminate the VNA application by pressing **System** > **Main** > **Exit**.
 3. Transfer the file from your PC to your VNA using LAN or USB Pen drive.
 4. Double-click the file on the VNA and follow the instruction.
-

PXIe/USB VNA Configurations and Options

Included with each M937x/P937xA Module is a mouse and keyboard.

- [Options](#)
- [Warranty Period](#)

See Also

- [M937x Series Configuration Guide \(requires an Internet connection\)](#)
- [P937x Series Configuration Guide \(requires an Internet connection\)](#)
- [M9485A Configuration Guide.](#)
- Click **Help** then **About Network Analyzer** to view the options that are installed on your analyzer.

Other Support Topics

Hardware Model/Options

M980xA PXIe VNA / P500xA USB VNA Series

Frequency

- M9800A/P5000A - 9 kHz to 4.5 GHz
- M9801A/P5001A - 9 kHz to 6.5 GHz
- M9802A/P5002A - 9 kHz to 9 GHz
- M9803A/P5003A - 9 kHz to 14 GHz
- M9804A/P5004A - 9 kHz to 20 GHz

Ports Option

- Option 200 - 2 port
- Option 400 - 4 port (M980xA only)

- Option 600 - 6 port (M980xA only)

Application Options

- Option 021 - Pulse Modulation Hardware (S9x025A is required)
- Option 090 - Spectrum Analysis Hardware (S9x090A is required)

M937x PXIe VNA / P937xA USB VNA Series

- M9370A/P9370A - 300 kHz to 4 GHz.
- M9371A/P9371A - 300 kHz to 6.5GHz.
- M9372A/P9372A - 300 kHz to 9 GHz.
- M9373A/P9373A - 300 kHz to 14 GHz.
- M9374A/P9374A - 300 kHz to 20 GHz.
- M9375A/P9375A - 300 kHz to 26.5 GHz.

M9485A Multiport PXIe VNA

See [M9485A Configuration Guide](#) for hardware options

Software Options

M937xA PXIe VNA / M9485A Multiport PXIe VNA

[Learn how to install options.](#)

Option	Required Model/Options	Description	Supported Model
010	None	Time Domain	M9485A, M937xA
007	None	Automatic Fixture Removal	M9485A, M937xA
009	None	Frequency offset mode	M9485A, M937xA
025	None	RF pulse measurement	M9485A
028	None	Noise Figure	M9485A
080	None	Frequency Offset	M9485A
086	None	Gain Compression Basic	M9485A
551	None	N port calibrated measurement	M9485A, M937xA

M980xA PXIe VNA

S95xxxA license is installed in your PC. The license can not be transfer to other PCs if the license is fixed type.

Model	Required Model/Options	Description
S95007A	None	Automatic Fixture Removal
S95010A	None	Time Domain
S95025A	021 Pulse Modulation Hardware <i>The option 021 is equipped with the module. The pulse modulation function for output signal works on only the ports on the module with the option 021. (This is not always necessary when an external source with pulse modulation is used.)</i>	Basic Pulsed-RF Measurements
S95029A	None	Noise Figure Measurements with Vector Correction
S95082A	None	Scalar Mixer Converter (SMC) measurements

S95084A	None	Embedded LO Capability
S95086A	None	Gain-Compression Measurements
S95090A	<i>090 Spectrum Analysis Hardware</i> <i>The option 090 is equipped with the module. The spectrum analysis function works on only the ports on the unit with the option 090.</i>	Spectrum Analysis
S95551A	None	N port configuration Allows P50xxA VNAs to be connected in multi-module configurations.

P50xxA / P937xA USB VNA

[Learn how to install options.](#)

S97xxxA license is installed in the USB VNA itself. The installed license is uploaded in Keysight License Manager on your PC automatically when you connect it with USB cable.

Note: S97xxxA can work with both P50xxA and P937xA.

Model	Required Model/Options	Description	Supported Model
S97007A	None	Automatic Fixture Removal	P937xA, P50xxA
S97010A	None	Time Domain	P937xA, P50xxA
S97025A	<i>021 Pulse Modulation Hardware</i> <i>The option 021 is equipped with the module. The pulse modulation function for output signal works on only the ports on the module with the option 021. (This is not always necessary when an external source with pulse modulation is used.)</i>	Basic Pulsed-RF Measurements	P50xxA
S97029A	None	Noise Figure Measurements with Vector Correction	P50xxA
S97082A	None	Scalar Mixer Converter (SMC) measurements	P937xA, P50xxA

			P50xxA
S97084A	None	Embedded LO Capability	P50xxA
S97086A	None	Gain-Compression Measurements	P50xxA
S97090A	<i>090 Spectrum Analysis Hardware The option 090 is equipped with the module. The spectrum analysis function works on only the ports on the unit with the option 090.</i>	Spectrum Analysis	P50xxA
S97551A	None	N port configuration Allows P937xA VNAs to be connected in multiport and multisite configurations. Allows P50xxA VNAs to be connected in multi-unit configurations.	P937xA, P50xxA

S96084A	E5080B	

*OPT? and Options COM Behavior

Some of the VNA option numbers returned when using the ***OPT?** SCPI command or **IApplication::Options** COM command are not the same as the option numbers returned when using the **SYST:CAP:LIC:CAT?** command or **IApplication::Licenses** COM command. The following table shows how the common option numbers map to the option numbers reported when using ***OPT?** command or the **IApplication::Options** COM command.

Software Product Number	*OPT? SCPI or Options COM Response	Description
S93007A/B,S95007A,S96007A, S97010A	007	Automatic Fixture Removal
S93010A/B,S95010A, S96010A, S97010A	010	Time-domain
S93015A/B	015	Dynamic Uncertainty for S-Parameters
S93025A/B	025	Add four internal pulse generators
S93026A/B, S95026A, S97026A	008	Integrated Pulsed Application
S93029A/B,	028	Noise Figure application only
S93029A/B,	028 + 080	Noise Figure application + Frequency Offset Mode (FOM) for converter applications
S95029A, S97029A	029	Noise Figure application + Noise Figure receiver or Noise Figure receiver only

S93080A/B	080	Frequency Offset Mode (FOM)
S93082A/B, S95082A, S96082A, S97082A	082 + 080 (Others), 082 (ENA)	Scalar Mixer Converter (SMC) + Frequency Offset Mode (FOM) for converter applications
S93083A/B, S95083A, S97083A	083 + 080	Frequency Converter Application (FCA) + Frequency Offset Mode (FOM) for converter applications
S93084A/B, S95084A, S97084A	084+ 080	Embedded LO + Frequency Offset Mode (FOM)
S93086A/B,	086 + 080	Gain Compression Application (GCA) + Frequency Offset Mode (FOM) for converter applications
S96086A, S95086A, S97086A	086	Gain Compression Application (GCA)
S93087A/B	087 + 080	Swept IMD and IM Spectrum + Frequency Offset Mode (FOM) for converter applications
S93088A/B	088	Source Phase Control
S93089A/B	089 + 080	Differential IQ + Frequency Offset Mode (FOM)
S95090A, S97090A	090 + 080	Spectrum analysis+ Frequency Offset Mode (FOM)
S930900A/B	090 + 900	Spectrum analysis, up to 8.5 GHz + Frequency Offset Mode (FOM)
S930901A/B	090 + 901	Spectrum analysis, up to 13.5 GHz + Frequency Offset Mode (FOM)
S930902A/B	090 + 902	Spectrum analysis, up to 26.5 GHz + Frequency Offset Mode (FOM)
S930904A/B	090 + 904	Spectrum analysis, up to 43.5 GHz + Frequency Offset Mode (FOM)
S930905A/B	090 + 905	Spectrum analysis, up to 50 GHz + Frequency Offset Mode (FOM)
S930907A/B	090 + 907	Spectrum analysis, up to 67 GHz + Frequency Offset Mode (FOM)

S930909A/B	090 + 909	Spectrum analysis, up to 90 GHz + Frequency Offset Mode (FOM)
S93093A/B	093 + 080	Extend Spectrum Analyzer to 110 GHz + Frequency Offset Mode (FOM)
S93094A/B	094 + 080	Extend Spectrum Analyzer to above 110 GHz+ Frequency Offset Mode (FOM)
S93118A/B	118	Fast CW Mode
S93460A/B	460	iTMSA
S93551A/B, S95551A, S97551A	551	N-port capabilities
S96790A	790	Measurement Wizard Assistant Software
S93898A/B	898	Built-in performance test software
S94510A/B	510	Nonlinear component characterization
S94511A/B	511	Nonlinear component characterization, restricted to 50 GHz
S94514A/B	514	Nonlinear X-parameters
S94518A/B	518	Nonlinear pulse envelope domain
S94520A/B	520	Arbitrary load-impedance X-parameters
S94521A/B	520	Arbitrary load-control, X-parameters
S94522A/B	520	Arbitrary load-control, device characterization

VNA Warranty Period

The actual warranty on your instrument depends on the date it was ordered as well as whether or not any warranty options were purchased at that time. To determine the exact warranty on your instrument, contact **Keysight Technologies** with the model and serial number of your instrument.

For online information about Keysight's service and support products visit:

www.Keysight.com/find/tm_services.

Option Enable

The software option can be installed by yourself.

On your PC

1. Visit <http://www.keysight.com/find/softwaremanager>
2. Log in or register your name if first time log-in.
3. Click "You can add a new certificate"

The image consists of three screenshots from the Keysight Software Manager web application. The top screenshot shows the main dashboard with a navigation bar and a sidebar. A callout box highlights the 'Add another entitlement certificate to your profile' button. The middle screenshot shows the 'Add Certificate' form with a progress indicator (1: Enter Certificate, 2: Review and Submit). The 'Order Number' and 'Certificate Number' input fields are highlighted, and a table of existing certificates is visible. The bottom screenshot shows the 'Software Entitlement Certificate' with the 'Keysight Order Number: 2025524_TEST' and 'Keysight Certificate Number: TV6V-QPCR' highlighted.

4. Locate the **Software License Entitlement Certificate**.
5. Enter your "Order Number" and "Certificate Number" on Software Entitlement Certificate.
6. Follow the instructions to register the ordered software licenses.
7. Click "You can request new licenses"
8. Select your required license (ex. S9xxxxxx)

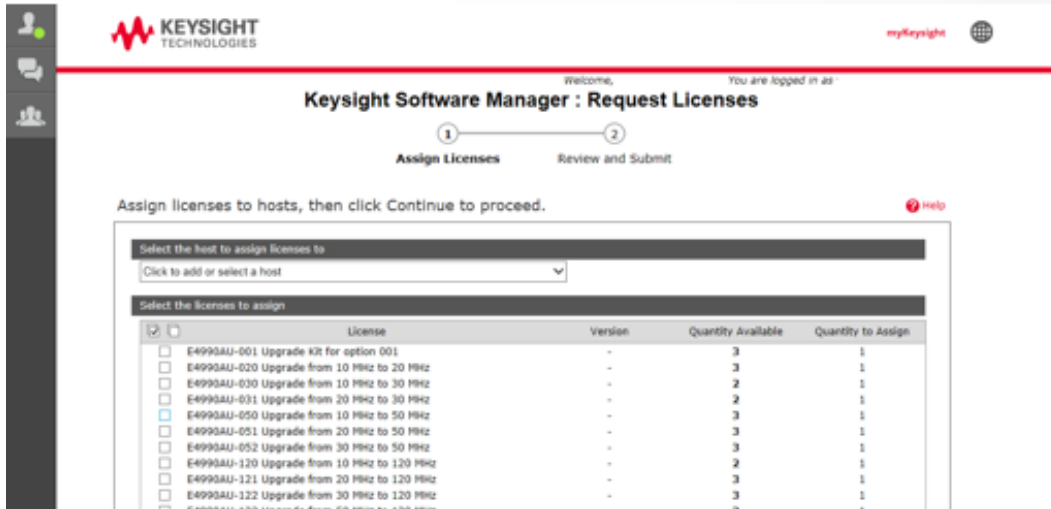
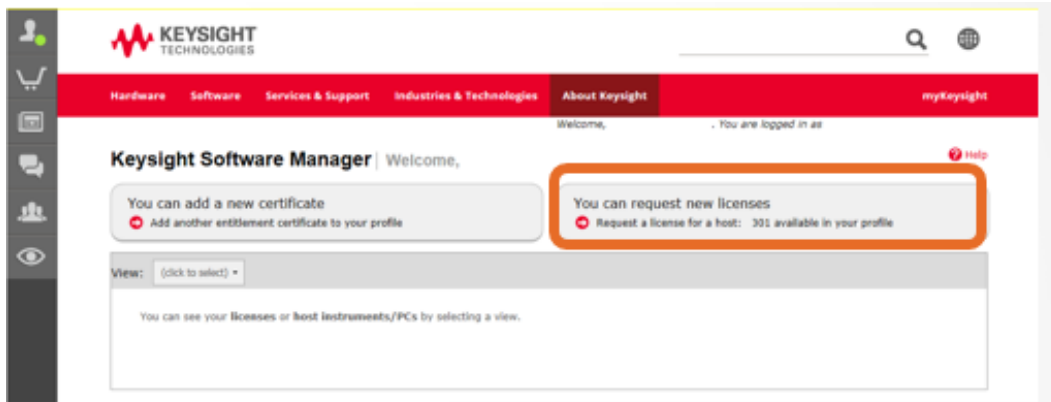

9. Add your **HOST ID**.

Example:
PXI VNA

Select the host to assign licenses to

Enter new host information: [? How do I find my Host ID?](#)

Model Number : 5, 6, or 7 characters. Example: X1234A or PCSERNO

Serial Number: Example: US12345678

Bench Top VNA

Select the host to assign licenses to

Enter new host information: [? How do I find my Host ID?](#)

Model Number : 5, 6, or 7 characters. Example: X1234A or PCSERNO

Serial Number: Example: US12345678

USB VNA

Select the host to assign licenses to

Enter new host information: [How do I find my Host ID?](#)

Enter a valid model number,serial number,hardware id :

Valid model numbers are: P6001A, P6002A, and P6004A

Example:
P6001A,US00984701,XBD57478F33730641

10. Click “Assign License” at the bottom.
11. Follow the instructions.
12. The message with license file (.lic) is sent to your email address.

On the analyzer or controller for analyzer

1. Execute the Keysight License Manager from Start Menu in Windows
2. Click “What if I have a license file to install”, then follow the instruction to install the license file.

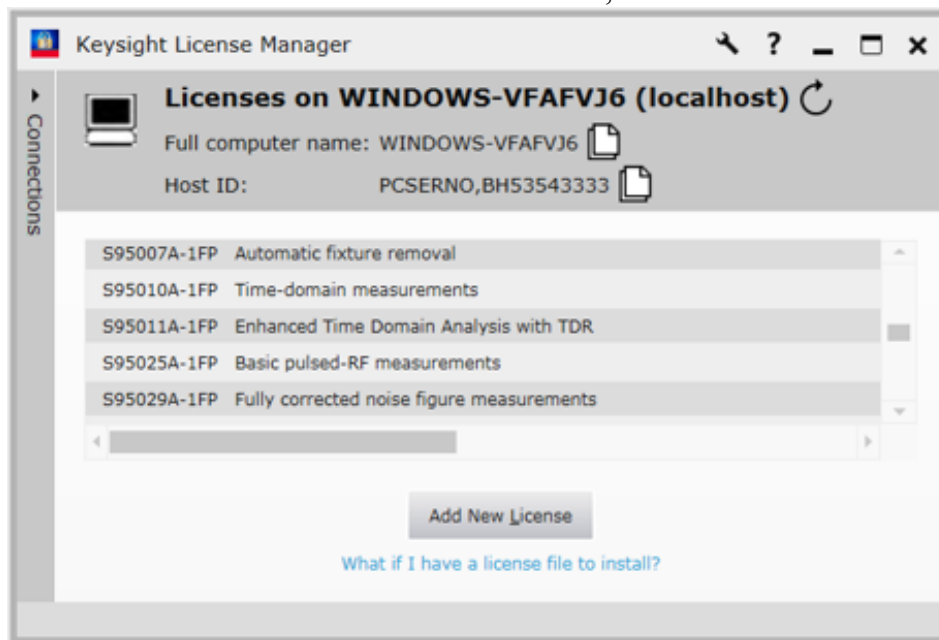

Detailed instructions can also be found in the Keysight License Manager help.

About HOST ID

The HOST ID will be asked when you get the license file.

PXI VNA/Bench Top VNA

HOST ID is shown in the Keysight License Manager. Keysight License Manager can be executed from Start Menu in Windows.

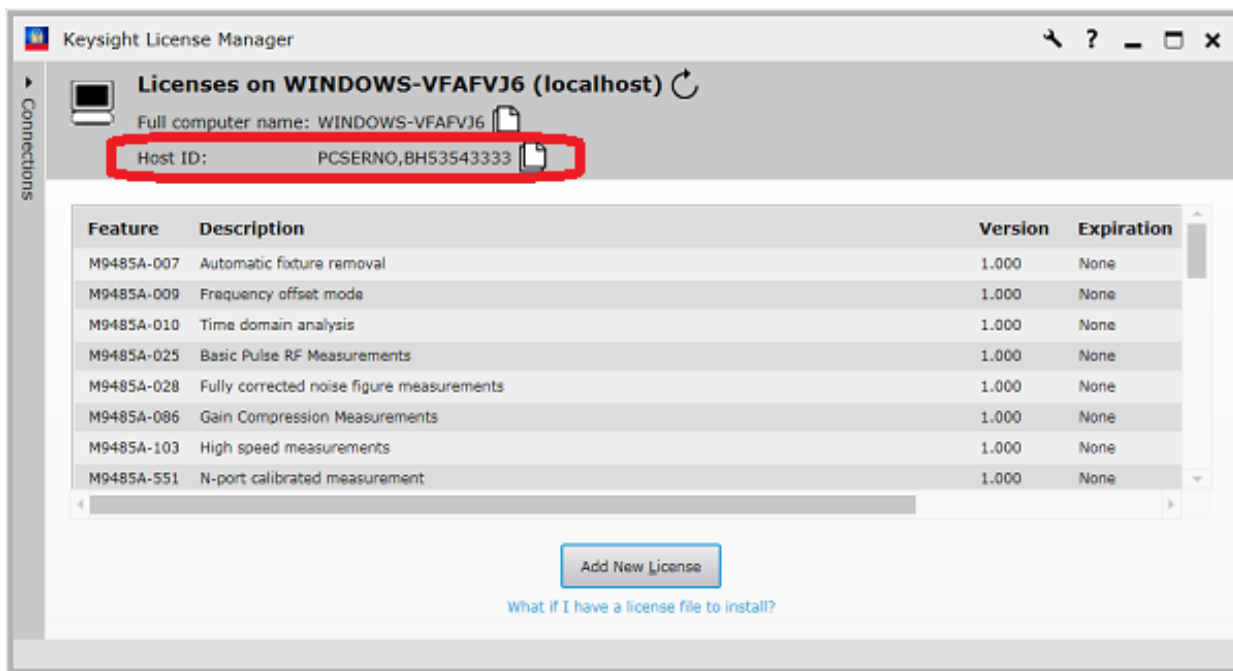

USB VNA

HOST ID is shown in About NA by clicking **System** > *Help* > **About NA...**



PXI Network Analyzer

P5004A, 9 kHz to 20 GHz

© Keysight Technologies 2000-2018

Serial Number: MY57401089

Options:

- P5004A [---] 9KHz to 20GHz vector network analyzer
- S97007A-1FP [007] Automatic fixture removal
- S97010A-TRL [010] Time-domain analysis
- S97082A-TRI [082] Scalar mixer/converter measurements

Select USB VNA

PXI Modules:

Module 1 PXI10::CHASSIS3::SLOT1::FUNC0::INSTR

- Host ID P6001A,MY57401089,XD10646724B13BF07
- FPGA 1 version: 00.16 FPGA 2 version: 00.14
- Last verification date: not specified
- Next verification date: not specified
- 200 [200] 2 ports
- 021 [021] Plused Modulation Hardware

Application Code Version: Z.13.39.61 (64 bit)

Computer Name: KBSHARE01

Build: 443.0 (release)

Workspace: tf-ctd-adm_3748_975_pnabld2

Branch: DivaSQ

MATLAB. (c) 1984 - 2010 The MathWorks, Inc.

Host ID: P5004A,MY57401089

More

Close

Do not use this.



Option Enable - M937xA

The Option Enable utility allows you to perform the following activities on your M937xA.

- Enable or remove software options and some hardware options.
- Recover option data if the hard drive or other data-containing assembly is replaced.
- Input or change a serial number.

The following items are discussed in this topic:

- [Keywords](#)
- [Running the Program](#)
- [Removing an Option](#)
- [Installing an Option](#)
- [Repairing and Recovering Option Data](#)
- [Installing or Changing the Serial Number](#)

See Also

[Configurations and Options](#)

Keywords

To add certain options, you need a keyword that is provided by Keysight. There are two types of keywords:

- Option Keywords add a software option.
- Model Keywords may be required if you replace multiple assemblies.

Keywords are linked to the PNA Host ID, which is displayed on the Option Enable dialog box (below).

Temporary and Permanent Options

Any software option can also be installed on a temporary basis for a specified amount of time. This allows you to evaluate a specific feature or capability at no cost.

If the license key provided by Keysight has an expiration date, you must select the "temporary" option and enter the expiration date exactly as stated in the license statement. If you decide to make this option permanent, Keysight will provide a new keyword that converts the option to permanent status.

For either permanent or temporary software options, a provided keyword must be entered.

Running the Program

On the PNA, press System, then Service, then Option Enable.

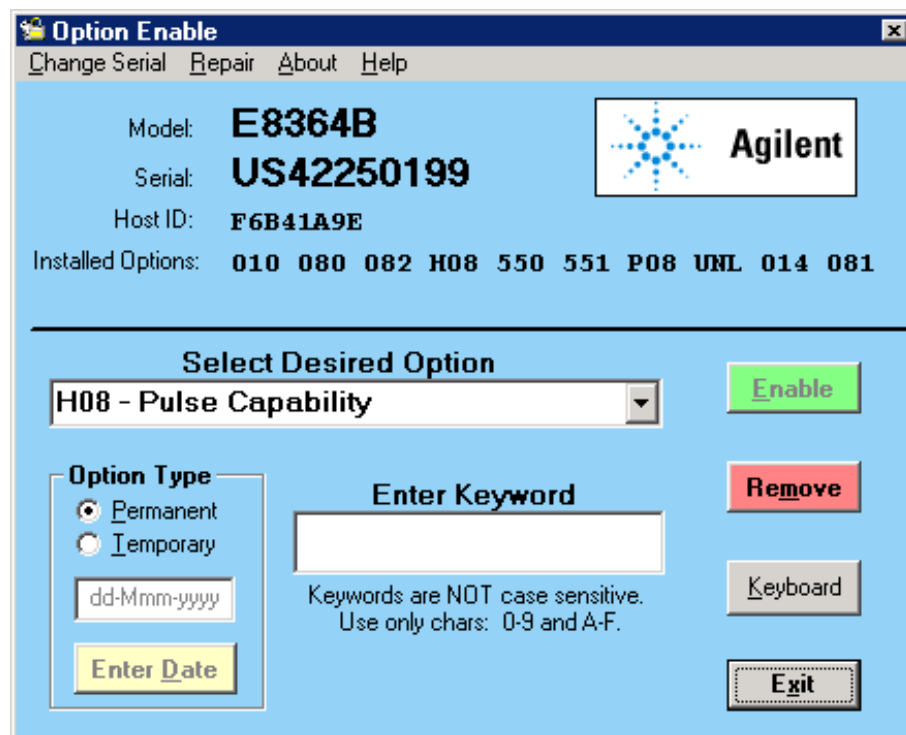

1. To enable or remove an option, select it from the drop-down list of available options. If the desired option is not listed, select the last choice in the list, labeled Enter Unlisted Option.
2. Enter the 3-character option name and click Enter

If a software option was chosen, the following occurs.

- The Remove button will be enabled.
- The keyword entry area becomes visible.
- The permanent/temporary selection is enabled.

If a hardware option is selected, the following occurs.

- With the hardware option already installed, the Remove button is enabled.
- With the hardware option not installed, the Enable button is enabled.

Removing an Option

1. To remove an option, click Remove.
2. After the option is removed, restart the network analyzer application for the changes to take effect.

Note: Removal of a licensed option (such as Option 010, Time Domain) will permanently remove the license keyword. If this option may be needed in the future, then record the license keyword before removing the option. Do this by copying the file “gen.lic” to another location (such as a floppy disk), or print it using notepad. The file, located at "c:\users\public\network analyzer\" contains all the information needed to recreate the license.

Installing an Option

1. If the keyword entry area is visible, enter a keyword. (The keyword is not case sensitive.)
2. Click Enable.
3. After the option is installed, restart the network analyzer application for the changes to take effect.

Note: If a desired option is not visible, it may be because a prerequisite option has not yet been installed. For example, Option 083 will not be visible if Option 080 is not already present. [See Configurations and options.](#)

Repairing and Recovering Option Data

Use this part of the Option Enable Utility in the following situations:

- If the hard drive is replaced
- If the frequency reference assembly is replaced

This routine rebuilds the option information contained on the hard drive and frequency reference assembly (primary and backup).

1. Select Repair from the Option Enable menu bar.

Note: If you are unsure if this routine needs to be done, run it; no harm will result.

2. The model and serial number are displayed, along with four check boxes.
3. Select the boxes that apply.
4. Click Begin Repair. The routine checks all data files and performs any needed repairs. You may be asked to verify certain information and processes.
5. If the routine finds that the model number is incorrect or invalid, you will be asked to select the correct model number.
 - o Along with this model number, a model keyword will be required. If this is not labeled on the analyzer, or is not otherwise known, contact Keysight
 - o After you have entered the requested data, click Change Model. This process takes about 30 seconds.
6. When done, click Exit Repair.
7. If you do not need to install any other options, click Exit.

Installing or Changing the Serial Number

It may be necessary to install or change a serial number if certain assemblies are replaced.

1. To change the serial number, select Change Serial from the Option Enable menu bar. The current serial number will be displayed. If no serial number has previously been entered, the word "NONE" will be displayed.
2. Type the new serial number into the space provided, and click Change Serial. (The serial number is not case sensitive.)

Note: Use extreme care when entering the serial number; only one entry chance is allowed!

3. To change an incorrect serial number, a clear-code password is required. Contact Keysight to obtain this clear code and have the existing serial number available. Enter the clear code in the space provided, along with the new serial number, then click Change Serial.

Instrument Calibration

An instrument calibration is a process where the analyzer performance is measured to ensure that it operates within specifications. If any performance parameter does not conform to the published specifications, adjustments are made to bring the performance into conformance.

See Also: [Instrument Calibration Verification \(Sticker\)](#)

Why Should I Get an Instrument Calibrated?

Over time, the active components in the analyzer age and the performance may degrade or drift.

To ensure that the analyzer is performing to the published specifications, you should have an instrument calibration performed periodically.

How Often Should I Get an Instrument Calibrated?

It is your responsibility to determine the calibration period which best meets your requirements. However, a 12 to 18 month calibration cycle is appropriate for most users.

There are two things to consider: performance drift and connector wear.

- The instrument specifications are set to consider the performance drift that may occur over a 24 month period. Therefore, getting the instrument calibrated at 24 month intervals ensures that the analyzer maintains performance within the operating specifications. If you need the analyzer to maintain more consistent operation, you may want to have the instrument calibrated more often than the recommended 24-month interval.
- Connector wear is a bigger factor and depends on the number of connections that are made. The test ports become noticeably worn after 500 to 700 connections. This could represent about 12 months with average use. With more frequent connections, the calibration cycle should be sooner. You can extend the time between calibrations and thereby save money by using [connector savers](#) and by performing proper [Connector Care](#).

How Do I Get an Instrument Calibrated?

To get the instrument calibrated, send it to one of the Keysight Technologies service centers. See [Technical Support](#).

To perform the instrument calibration yourself, you must have the following required items:

- Instrument Calibration Test Equipment
- Performance Test Software

What Are My Choices of Instrument Calibration?

The following types of instrument calibration are available from Keysight Technologies at the time of initial order:

- Standard** Includes a certificate of calibration stating the instrument has been calibrated and is operating within the published specifications.
- Option UK6** Available ONLY at the initial shipment. Includes the test data from the calibration and the certificate of calibration stating the instrument has been calibrated and is operating within the published specifications.
- Option A6J** Available ONLY at the initial shipment. Includes the test data and measurement uncertainties from the calibration and the certificate of calibration stating the instrument has been calibrated using a process in compliance with ANSI Z540 and is operating within the published specifications.
- Option 1A7** Available ONLY at the initial shipment. Includes the test data and measurement uncertainties from the calibration and the certificate of calibration stating the instrument has been calibrated using a process in compliance with ISO 17025 and is operating within the published specifications.

The following types of instrument calibration are available from Keysight Technologies service center:

- Keysight Calibration** Includes the test data from the calibration and the certificate of calibration, stating the instrument has been calibrated and is operating within the published specifications.
- ANSI Z540 Calibration** Includes the test data from the calibration and the certificate of calibration, stating the instrument has been calibrated using a process in compliance with ANSI Z540.1 and is operating within the published specifications.
- ISO 17025 Calibration** Includes the test data from the calibration and the certificate of calibration, stating the instrument has been calibrated using a process in compliance with ISO 17025 and is operating within the published specifications.

For more information on these options, visit www.Keysight.com/find/calibration.

Other Resources

The following network analysis resources are also available.

Document Resources

[Application Notes](#)

Third-Party Resources

For information about test fixtures and part handlers, contact:

Inter-Continental Microwave

www.icmicrowave.com

For information about probing equipment and accessories, contact:

Cascade Microtech, Inc.

www.cascademicrotech.com

SCPI Errors

SCPI Errors

- -100 to -200 Command Errors
- -200 to -299 Execution Errors
- -300 to -399 SCPI Specified Device-Specific Errors
- -400 to -800 Query and System Errors
- 100 to 230 VNA-specific Errors

See Also

[Analyzer Error messages.](#)

-100 to -200 Command Errors

A command error indicates that the test set's GPIB parser has detected an IEEE 488.2 syntax error. When one of these errors is generated, the command error bit in the event status register is set.

-100 std_command	Command - This event bit (Bit 5) indicates a syntax error, or a semantic error, or a GET command was entered, see IEEE 488.2, 11.5.1.1.4.
-101 std_invalidChar	Invalid character - Indicates a syntactic elements contains a character which is invalid for that type.
-102 std_syntax	Syntax - Indicates that an unrecognized command or data type was encountered. For example, a string was received when the device does not accept strings.
-103 std_invalidSeparator	Invalid separator - The parser was expecting a separator and encountered an illegal character. For example, the semicolon was omitted after a program message unit.
-104 std_wrongParamType	Data type -The parser recognized a data element different than one allowed. For example, numeric or string data was expected but block data was encountered.
-105 std_GETNotAllowed	GET not allowed - Indicates a Group Execute Trigger was received within a program message. Correct the program so that the GET does not occur within the program code.

-108	std_tooManyParameters	Parameter not allowed - Indicates that more parameters were received than expected for the header. For example, *ESE common command only accepts one parameter, so *ESE 0,1 is not allowed.
-109	std_tooFewParameters	Missing parameter - Indicates that less parameters were received than required for the header. For example, *ESE requires one parameter, *ESE is not allowed.
-110	std_cmdHeader	Command header - Indicates an error was detected in the header. This error is used when the device cannot detect the more specific errors -111 through -119.
-111	std_headerSeparator	Header separator - Indicates that a character that is not a legal header separator was encountered while parsing the header.
-112	std_IDTooLong	Program mnemonic too long - Indicates that the header contains more than twelve characters, see IEEE 488.2, 7.6.1.4.1.
-113	std_undefinedHeader	Undefined header - Indicates the header is syntactically correct, but it is undefined for this specific device. For example, *XYZ is not defined for any device.
-114	std_suffixOutOfRange	Header suffix out of range - Indicates the value of a header suffix attached to a program mnemonic makes the header invalid.
-120	std_numericData	Numeric data - This error, as well as errors
-121	std_invalidCharInNumber	Invalid character in number - Indicates an invalid character for the data type being parsed was encountered. For example, an alpha in a decimal numeric or a "9" in octal data.
-123	std_exponentTooLarge	Exponent too large - Indicates the magnitude of an exponent was greater than 32000, see IEEE 488.2, 7.7.2.4.1.
-124	std_decimalTooLong	Too many digits - Indicates the mantissa of a decimal numeric data element contained more than 255 digits excluding leading zeros, see IEEE 488.2, 7.7.2.4.1.
-128	std_numericNotAllowed	Numeric data not allowed - Indicates that a legal numeric data element was received, but the device does not accept one in this position for the header.
-130	std_suffix	Suffix - This error, as well as errors -131 through -139, are generated when parsing a suffix. This particular error message is used if the device cannot detect a more specific error.
-131	std_badSuffix	Invalid suffix - Indicates the suffix does not follow the syntax described in IEEE 488.2, 7.7.3.2, or the suffix is inappropriate for this device.
-134	std_suffixTooLong	Suffix too long - Indicates the suffix contain more than 12 characters, see IEEE 488.2, 7.7.3.4.

-138 std_suffixNotAllowed	Suffix not allowed - Indicates that a suffix was encountered after a numeric element that does not allow suffixes.
-140 std_charData	Character data - This error, as well as errors
-141 std_invalidCharData	Invalid character data - Indicates that the character data element contains an invalid character or the particular element received is not valid for the header.
-144 std_charDataTooLong	Character data too long - Indicates the character data element contains more than twelve characters, see IEEE 488.2, 7.7.1.4.
-148 std_charNotAllowed	Character data not allowed - Indicates a legal character data element was encountered where prohibited by the device.
-150 std_stringData	String data - This error, as well as errors
-151 std_stringInvalid	Invalid string data - Indicates that a string data element was expected, but was invalid, see IEEE 488.2, 7.7.5.2. For example, an END message was received before the terminal quote character.
-158 std_stringNotAllowed	String data not allowed - Indicates that a string data element was encountered but was not allowed by the device at this point in parsing.
-160 std_blockData	Block data - This error, as well as errors -161 through -169, are generated when parsing a block data element. This particular error message is used if the device cannot detect a more specific error.
-161 std_badBlock	Invalid block data - Indicates a block data element was expected, but was invalid, see IEEE 488.2, 7.7.6.2. For example, and END message was received before the end length was satisfied.
-168 std_blockNotAllowed	Block data not allowed - Indicates a legal block data element was encountered, but not allowed by the device at this point in parsing.
-170 std_expr	Expression - This error, as well as errors -171 through -179, are generated when parsing an expression data element. This particular error message is used if the device cannot detect a more specific error.
-171 std_invalidExpression	Invalid expression - Indicates the expression data element was invalid, see IEEE 488.2, 7.7.7.2. For example, unmatched parentheses or an illegal character.
-178 std_exprNotAllowed	Expression data not allowed - Indicates a legal expression data was encountered, but was not allowed by the device at this point in parsing.

-180 std_macro	Macro - This error, as well as error -181 through -189, are generated when defining a macro or execution a macro. This particular error message is used if the device cannot detect a more specific error.
-181 std_validOnlyInsideMacro	Invalid outside macro definition - Indicates that a macro parameter place holder was encountered outside of a macro definition.
-183 std_invalidWithinMacro	Invalid inside macro definition - Indicates that the program message unit sequence, sent with a *DDT or a *DMC command, is syntactically invalid, see IEEE 488.2, 10.7.6.3.
-184 std_macroParm	Macro parameter - Indicates that a command inside the macro definition had the wrong number or type of parameters.

-200 to -299 Execution Errors

These errors are generated when something occurs that is incorrect in the current state of the instrument. These errors may be generated by a user action from either the remote or the manual user interface

-200 std_execGen	Execution - This event bit (Bit 4) indicates a PROGRAM DATA element following a header was outside the legal input range or otherwise inconsistent with the device's capabilities, see IEEE 488.2, 11.5.1.1.5.
-201 std_invalidWhileInLocal	Invalid while in local
-202 std_settingsLost	Settings lost due to rtl
-203 std_commandProtected	Command protected - Indicates that a legal password-protected program command or query could not be executed because the command was disabled.
-210 std_trigger	Trigger
-211 std_triggerIgnored	Trigger ignored
-212 std_armIgnored	Arm ignored
-213 std_initIgnored	Init ignored
-214 std_triggerDeadlock	Trigger deadlock
-215 std_armDeadlock	Arm deadlock
-220 std_parm	Parameter - Indicates that a program data element related error occurred.
-221 std_settingsConflict	Settings conflict - Indicates that a legal program data element was parsed but could not be executed due to the current device state.

-222	std_dataOutOfRange	Data out of range - Indicates that a legal program data element was parsed but could not be executed because the interpreted value was outside the legal range defined by the devices
-223	std_tooMuchData	Too much data - Indicates that a legal program data element of block, expression, or string type was received that contained more data than the device could handle due to memory or related device-specific requirements.
-224	std_illegalParmValue	Illegal parameter value - Indicates that the value selected was not part of the list of values given.
-225	std_noMemoryForOp	Out of memory - The device has insufficient memory to perform the requested operation.
-226	std_listLength	Lists not same length - Attempted to use LIST structure having individual LIST's of unequal lengths.
-230	std_dataCorruptOrStale	Data corrupt or stale - Indicates invalid data, a new reading started but not completed since the last access.
-231	std_dataQuestionable	Data questionable - Indicates that measurement accuracy is suspect.
-232	std_invalidFormat	Invalid format
-233	std_invalidVersion	Invalid version - Indicates that a legal program data element was parsed but could not be executed because the version of the data is incorrect to the device. For example, a not supported file version, a not supported instrument version.
-240	std_hardware	Hardware - Indicates that a legal program command or query could not be executed because of a hardware problem in the device.
-241	std_hardwareMissing	Hardware missing - Indicates that a legal program command or query could not be executed because of missing device hardware. For example, an option was not installed.
-250	std_massStorage	Mass storage - Indicates that a mass storage error occurred. The device cannot detect the more specific errors described for errors -251 through -259.
-251	std_missingMassStorage	Missing mass storage - Indicates that a legal program command or query could not be executed because of missing mass storage.
-252	std_missingMedia	Missing media - Indicates that a legal program command or query could not be executed because of missing media. For example, no disk.
-253	std_corruptMedia	Corrupt media - Indicates that a legal program command or query could not be executed because of corrupt media. For example, bad disk or wrong format.
-254	std_mediaFull	Media full- Indicates that a legal program command or query could not be executed because the media is full. For example, there is no room left on the disk.

-255	std_directoryFull	Directory full - Indicates that a legal program command or query could not be executed because the media directory was full.
-256	std_fileNotFound	File name not found - Indicates that a legal program command or query could not be executed because the file name was not found on the media.
-257	std_fileName	File name - Indicates that a legal program command or query could not be executed because the file name on the device media was in error. For example, an attempt was made to read or copy a nonexistent file.
-258	std_mediaProtected	Media protected - Indicates that a legal program command or query could not be executed because the media was protected. For example, the write-protect switch on a memory card was set.
-260	std_expression	Expression
-261	std_math	Math in expression
-270	std_macroExecution	Macro - Indicates that a macro related execution error occurred.
-271	std_macroSyntax	Macro syntax - Indicates that a syntactically legal macro program data sequence, according to IEEE 488.2, 10.7.2, could not be executed due to a syntax error within the macro definition.
-272	std_macroExec	Macro execution - Indicates that a syntactically legal macro program data sequence could not be executed due to some error in the macro definition, see IEEE 488.2, 10.7.6.3.
-273	std_badMacroName	Illegal macro label - Indicates that the macro label was not accepted, it did not agree with the definition in IEEE 488.2, 10.7.3
-274	std_macroPlaceholderMa	cro parameter - Indicates that the macro definition improperly used a macro parameter placeholder, see IEEE 488.2, 10.7.3.
-275	std_macroTooLong	Macro definition too long - Indicates that a syntactically legal macro program data sequence could not be executed because the string of block contents were too long for the device to handle, IEEE 488.2, 10.7.6.1.
-276	std_macroRecursion	Macro recursion - Indicates that a syntactically legal macro program data sequence could not be executed because it would be recursive, see IEEE 488.2, 10.7.6.6.
-277	std_cantRedefineMacro	Macro redefinition not allowed - Indicates that redefining an existing macro label, see IEEE 488.2, 10.7.6.4.
-278	std_macroNotFound	Macro header not found - Indicates that a legal macro label in the *GMS?, see IEEE 488.2, 10.13, could not be executed because the header was not previously defined.
-280	std_program	Program
-281	std_cantCreateProgram	Cannot create program

-282	std_illegalProgramName	Illegal program name
-283	std_illegalVarName	Illegal variable name
-284	std_programRunning	Program currently running
-285	std_programSyntax	Program syntax
-286	std_programRuntime	Program runtime
-290	std_memoryUse	Memory use
-291	std_execOutOfMemory	Out of memory
-292	std_nameNotFound	Referenced name does not exist
-293	std_nameAlreadyExists	Referenced name already exists
-294	std_incompatibleType	Incompatible type

-300 to -399 SCPI Specified Device-Specific Errors

A device-specific error indicates that the instrument has detected an error that occurred because some operations did not properly complete, possibly due to an abnormal hardware or firmware condition. For example, an attempt by the user to set an out of range value will generate a device specific error. When one of these errors is generated, the device specific error bit in the event status register is set.

-300	std_deviceSpecific	Device specific - This event bit (Bit 3) indicates that a device operation did not properly complete due to some condition, such as overrange see IEEE 488.2, 11.5.1.1.6.
-310	std_system	System
-311	std_memory	Memory - Indicates some physical fault in the devices memory, such as a parity error.
-312	std_PUDmemoryLost	PUD memory lost - Indicates protected user data saved by the *PUD command has been lost, see IEEE 488.2, 10.27.
-313	std_calMemoryLost	Calibration memory lost - Indicates that nonvolatile calibration data used by the *CAL? command has been lost, see IEEE 488.2, 10.2.
-314	std_savRclMemoryLost	Save/recall memory lost - Indicates that the nonvolatile data saved by the *SAV command has been lost, see IEEE 488.2, 10.33.
-315	std_configMemoryLost	Configuration memory lost - Indicates that nonvolatile configuration data saved by the device has been lost.
-320	std_storageFault	Storage fault - Indicates that the firmware detected a fault when using data storage. This is not an indication of physical damage or failure of any mass storage element.
-321	std_outOfMemory	Out of memory - An internal operation needed more memory than was available
-330	std_selfTestFailed	Self-test failed - Indicates a problem with the device that is not covered by a specific error message. The device may require service.

-340	std_calFailed	Calibration failed - Indicates a problem during calibration of the device that is not covered by a specific error.
-350	std_queueOverflow	Queue overflow - Indicates that there is no room in the queue and an error occurred but was not recorded. This code is entered into the queue in lieu of the code that caused the error.
-360	std_comm	Communication - This is the generic communication error for devices that cannot detect the more specific errors described for error -361 through -363.
-361	std_parity	Parity in program message - Parity bit not correct when data received for example, on a serial port.
-362	std_framing	Framing in program message - A stop bit was not detected when data was received for example, on a serial port (for example, a baud rate mismatch).
-363	std_inputBufferOverrun	Input buffer overrun - Software or hardware input buffer on serial port overflows with data caused by improper or nonexistent pacing.

-400 to -800 Query and System Errors

A Query error is generated either when data in the instrument's GPIB output queue has been lost, or when an attempt is being made to read data from the output queue when no output is present or pending.

-400	std_queryGen	Query - This event bit (Bit 2) indicates that an attempt to read data from the Output Queues when no output is present or pending, to data in the Output Queue has been lost see IEEE488.2, 11.5.1.1.7.
-410	std_interrupted	Query INTERRUPTED - Indicates the test set has been interrupted by a new program message before it finishes sending a RESPONSE MESSAGE see IEEE 488.2, 6.3.2.3.
-420	std_terminated	Query UNTERMINATED - Indicates an incomplete Query in the program see IEEE 488.2, 6.3.2.2.
-430	std_deadlocked	Query DEADLOCKED - Indicates that the Input Buffer and Output Queue are full see IEEE 488.2, 6.3.1.7.
-440	std_responseNotAllowed	Query UNTERMINATED after indefinite response - Indicates that a query was received in the same program message after a query requesting an indefinite response was executed see IEEE 488.2, 6.5.7.5.
-500	std_powerOn	Power on
-600	std_userRequest	User request
-700	std_requestControl	Request control
-800	std_operationComplete	Operation complete

Analyzer-Specific (Positive) SCPI Errors

100	dupWindNum	"Duplicate window number"
101	windNumNotFound	"Window number not found"
102	failedWindCreate	"Window creation failed"
103	noCalcParamSelection	"CALC measurement selection set to none"
		See CALC:PAR:SEL
104	dupMeasName	"Duplicate measurement name"
105	dataNotFound	"Requested data not available"
106	measNotFound	"Requested measurement not found"
107	traceNotFound	"Requested trace not found"
108	notImplemented	"Mnemonic not yet implemented"
109	noDocument	"No measurement container found"
110	dupTraceNum	"Duplicate trace number"
111	titleStrTooLong	"Title string exceeds 50 characters"
112	memoryNotFound	"Requested memory not found"
113	exceedMaxTraces	"Exceeded the maximum number of traces per window"
114	SerNumNotFound	"The serial number was not found. Please store the serial number."
115	LoadFailed	"The state was not loaded. Please check the file name."
116	StoreFailed	"The state was not stored. Please check the file and path names."
117	File	"An in the File operation occurred. Please check file and path names."
118	measChanConflict	"Measurement does not belong to specified channel."
119	exceedMaxWindows	"Exceeded the maximum number of data windows"
120	markerNotFound	"The specified marker was not found."
121	diagnostic	"Diagnostic ."
122	channelNotFound	"The specified channel was not found."
123	exceedMaxMeasurements	"Exceeded the maximum number of allowed measurements."
124	parameterOutOfRange	"The specified value was out of range."
125	userRangeNotValid	"The currently selected user range is not valid."
126	referenceMarkerNotFound	"The reference marker is not active."
127	sweepSegmentNotFound	"The sweep segment was not found."
128	markerNotDelta	"The specified marker is not a delta marker."
129	printoutFailed	"Attempt to output to a printer failed."
130	memory_trace_not_compatible	"Memory not compatible. Trace Math not applied."
131	trace_math_reset	"Memory not compatible. Trace Math turned off."
132	hw_read_failed	"Hardware read failed."

133	hw_write_failed	"Hardware write failed."
134	dsp_active	"Failed because DSP was not halted."
135	secure_memory	"Attempt to access secure memory region."
136	snum_protected	"The serial number is protected."
137	snum_format_bad	"The serial number format is bad."
138	snum_already_set	"The serial number is already set."
139	hw_setting_failed	"Hardware setting failed."
140	cal_access_failed	"Calibration data access failed."
141	db_access_failed	"Database access failed."
142	memory_range_exceeded	"Command exceeds usable memory range."
143	lost_phase_lock	"Phase lock has been lost."
144	over_power	"Detected too much power at input."
145	ee_wrt_failed	"EEPROM write failed."
146	yig_cal_failed	"YTO calibration failed."
147	ramp_cal_failed	"Analog ramp calibration failed."
148	dspcom_bad	"DSP communication failed."
149	no_license_found	"Request failed. The required license was not found."
150	argLimited	"The argument was out of range"
151	markerBWNotFound	"The Marker Bandwidth was not found."
153	peakNotFound	"The Peak was not found."
154	targetNotFound	"The Target search value was not found."
155	calNotImpl	"The Calibration feature requested is not implemented."
156	calClassNotValidForCalType	"SENS:CORR:CCH measurement selection set to none"
158	calNotValidForConfidenceChe	"Selected measurement does not have a calibration valid for Confidence Check"
159	invalidPort	"Specified port is out of range"
160	invalidPortPath	"ROUT:PATH:DEF:PORT x, y does not match measurement; setting to defaults"
161	ioInvalidWrite	"Attempted I/O write while port set to read only."
162	ioInvalidRead	"Attempted I/O read from write only port."
163	calsetNotFound	"Requested Cal Set was not found in Cal Set Storage."
164	noCalSetSelected	"There is no Cal Set currently selected for the specified channel."
165	cantDeleteCalSetInUse	"Cannot delete a Cal Set while it is being used."
166	calsetStimChange	"Channel stimulus settings changed to match selected Cal Set."
167	exceedMaxCalSets	"Exceeded the maximum number of cal sets."

168	calCouldNotTurnOn	"A valid calibration is required before correction can be turned on."
169	standardMeasurementRequired	"The attempted operation can only be performed on a standard measurement type."
170	noDivisorBuffer	"A valid divisor buffer is required before normalization can be turned on."
171	InvalidReceiverPowerCalParagraph	"Receiver power cal requires the measurement to be of unratiod power."
172	ecalCouldNotConfigure	"Could not configure the Electronic Calibration system. Check to see if the module is plugged into the proper connector."
173	measHasNoMemoryAlg	"This measurement does not support memory operations"
174	measHasNoNormalizeAlg	"This measurement does not support normalize operations."
175	userCharacterizationNotFound	"User characterization was not found in the Electronic Calibration module."
176	measInvalidBufferSize	"The data provided has an invalid number of points. It could not be stored."
179		"The source power measurement failed. Please check GPIB, power meter settings and sensor connections."
182		"The custom cal type does not support remote sessions."
185		"An unexpected error occurred in the custom cal module."
191		"The specified cal kit file does not exist or the file format is not recognized."
192		"Guided cal initialization failed."
194		"Security level of High or greater can only be disabled by instrument preset or recall of lower security instrument state."
196		"An instrument option that is required for this command is non installed."
202		"Parameter not valid."
208		"Fixturing: the requested S2P file cannot be opened."
212		"A user calset with this name already exists."
225		"An attempt was made to acquire calibration data before the system was properly initialized."
226		"Requested to measure a cal standard connection step undefined for this cal. Please check number of connection steps and their descriptions."
227		"A request was made for control of a testset which does not appear to be connected."
230		"The requested operation is not valid for the current sweep type."

236	"Could not generate the error terms."
247	"The connector specified is invalid."
248	"The Calibration Kit specified is invalid."
251	"The requested feature is not available in the current context."
254	"Cannot load error terms into the calibration sequence for the requested port, because the cal sequence does not involve that port."
258	"The hardware does not support the ALC mode specified."
261	"Invalid path element."
266	"The specified trigger connection is not available."
268	"Unleveled, source 1, out 1."
305	"Trace trigger requires point sweep mode, no internal triggers and must be in channel scope."
308	"Could not detect the specified ECal module. Please ensure that it is connected and that you are specifying its ID."
311	"The INITiate command must be successfully issued before steps of a remote ECal user characterization can be accessed."
324	"The specified calibration kit name is not recognized as a kit that has a definition factory-installed on the PNA."
336	"Power calibration must be enabled for the guided calibration before the power calibration settings can be modified."
341	"The property value specified is not valid in this context."
348	"The requested interface is not configured for this instrument."
368	"Illegal parameter(s) in the SCPI command."

Technical Support

Click on the region of interest.



For more contact information, visit <http://www.Keysight.com/find/contactus>

Other Support Topics

United States:

(tel) (+1) 800-829-4444

(alt) (+1) 303 662 3999

(fax) (+1) 888 900 8921

Canada

(tel) 1 877 894 4414

(fax) 1 (905) 206 4120

Europe:

Austria

(tel) 0820 87 44 11*

(fax) 0820 87 44 22

Belgium

(tel) (+32) (0)2 404 9340

(alt) (+32) (0)2 404 9000

(fax) (+32) (0)2 404 9395

Denmark

(tel) (+45) 7013 1515

(alt) (+45) 7013 7313

(fax) (+45) 7013 1555

Finland

(tel) 08 0052 4000

(alt) (+358) 10 855 2100

(fax) (+358) 92 536 0176

France

(tel) 0825 010 700*

(alt) (+33) (0)1 6453 5623

(fax) 0825 010 701*

Germany

(tel) 01805 24 6333*

(alt) 01805 24 6330*

(fax) 01805 24 6336*

Ireland

(tel) (+353) (0)1 890 924 204

(alt) (+353) (0)1 890 924 206

(fax) (+353) (0)1 890 924 024

Israel

(tel) (+972) 3 9288 500

(fax) (+972) 3 9288 501

Italy

(tel) (+39) (0)2 9260 8484

(fax) (+39) (0)2 9544 1175

Luxemburg

(tel) (+32) (0)2 404 9340

(alt) (+32) (0)2 404 9000

(fax) (+32) (0)2 404 9395

Netherlands

(tel) (+31) (0)20 547 2111

(alt) (+31) (0)20 547 2000

(fax) (+31) (0)20 547 2190

Russia

(tel) (+7) 095 797 3963

(alt) (+7) 095 797 3900

(fax) (+7) 095 797 3901

Spain

(tel) (+34) 91 631 3300

(alt) (+34) 91 631 3000

(fax) (+34) 91 631 3301

Sweden

(tel) 0200 88 22 55*

(alt) (+46) (0)8 5064 8686

(fax) 020 120 2266*

Switzerland (French)

(tel) 0800 80 5353 opt. 2*

(alt) (+33) (0)1 6453 5623

(fax) (+41) (0)22 567 5313

Switzerland (German)

(tel) 0800 80 5353 opt. 1*

(alt) (+49) (0)7031 464 6333

(fax) (+41) (0)1 272 7373

Switzerland (Italian)

(tel) 0800 80 5353 opt. 3*

(alt) (+39) (0)2 9260 8484

(fax) (+41) (0)22 567 5314

United Kingdom

(tel) (+44) (0)7004 666666

(alt) (+44) (0)7004 123123

(fax) (+44) (0)7004 444555

Japan:

(tel) 0120 421 345

(alt) (+81) 426 56 7832

(fax) 0120 421 678

Latin America:

Mexico

(tel) (+52) 55 5081 9469

(alt) 01800 5064 800

(fax) (+52) 55 5081 9467

Brazil

(tel) (+55) 11 4197 3600

(fax) (+55) 11 4197 3800

Australia:

((tel) 1800 629 485

(alt) 1800 143 243

(fax) 1800 142 134

New Zealand

(tel) 0 800 738 378

(fax) 64 4 495 8950

Asia Pacific:

China

(tel) 800 810 0189

(alt) (+86) 10800 650 0021

(fax) 800 820 2816

Hong Kong

(tel) 800 930 871

(alt) (+852) 3197 7889

(fax) (+852) 2 506 9233

India

(tel) 1600 112 929

(fax) 000800 650 1101

Malaysia

(tel) 1800 888 848

(alt) 1800 828 848

(fax) 1800 801 664

Singapore

(tel) 1800 375 8100

(fax) (+65) 6836 0252

South Korea

(tel) 080 769 0800

(alt) (+82) 2 2004 5004

(fax) (+82) 2 2004 5115

Taiwan

(tel) 0800 047 866

(alt) 00801 651 317

(fax) 0800 286 331

Thailand

(tel) 1800 226 008

(alt) (+66) 2 268 1345

(fax) (+66) 2 661 3714

Licenses

Open Source Software License

JPEG Software Package

This software is based in part on the work of the Independent JPEG Group.

TightVNC

Redistribution of TightVNC is licensed under the General Public License version 2. Source code of TightVNC and a copy of the GPLv2 may be found in the directory of \opensource\TightVNC.

Portions of this software are distributed under one or more Open Source terms and are not warranted and supported by Keysight. This disclaimer does not affect any statutory rights that may exist in any country of distribution. The disclaimed Open Source software portions include the following software package(s): TightVNC. The text of the license for each software package is contained in a directory reflecting the name of the Open Source software that is found in the "\opensource" directory. The author and not Keysight grants a license to use and further distribute the Open Source software. Any license to use and further distribute the Open Source software is granted by the author(s) of such Open Source software in their Open Source license, not by Keysight in this license instrument. The author(s)'s license terms, if any, are found in text files and, if applicable, the source code of the separate Open Source software packages.

TO THE EXTENT PERMITTED BY LOCAL LAW:

Keysight provides the Open Source software listed above "as is" and any express or implied warranties, including, but not limited to any warranty of non-infringement, the implied warranties of merchantability, satisfactory quality, reasonable care and skill, and fitness for a particular purpose are expressly disclaimed; and

Keysight shall not be liable for any direct, indirect, incidental, special, exemplary, or consequential damages (including: procurement of substitute goods or services; loss of use, data, or profits; or business interruption) arising from the use of open source software, however caused and regardless of whether such claims are based upon contract, strict liability or tort (except gross negligence or willful misconduct of Keysight), or any other legal theory even if advised of the possibility of such damage and even if it has been ensured that such data can be reconstructed with reasonable expenditure from data material provided in machine-readable form.

Commercial Software License

MathWorks MATLAB Compiler Runtime v7.14

MathWorks MATLAB Compiler ; Permission to use the MatLab MCR library is defined in a license agreement between MatLab and you, the Licensee. A copy of the license agreement may be found in “c:\Program Files (x86)\MATLAB\MATLAB Compiler Runtime” directory.

Diagnostic Tools, Utilities, and Adjustments

The following Tools, Utilities, and Adjustments are available to help you keep your VNA at peak performance.

Diagnostic Tools

- [Operators Check](#)
- [System Verification](#)

Utilities

- [Receiver Display](#)
- [Restore ECal Memory](#)
- [Receiver Temperature](#)

Adjustments

Not all of the adjustments listed below are valid for every VNA model. Only the adjustments needed for each particular VNA will be listed.

To access the service adjustments on the VNA, click **Utility**, then **System**, then **Service**, then **Adjustment Routines...**

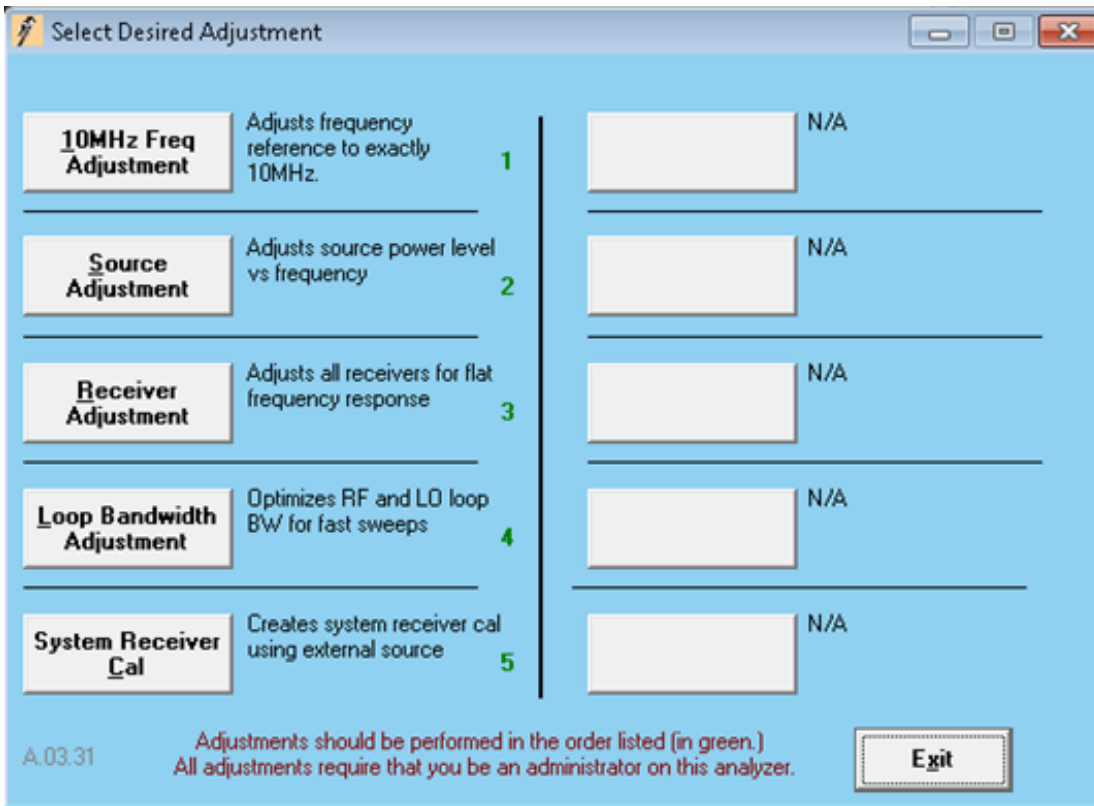

- 10 MHz Reference Frequency Adjustment
- Source Adjustment
- Receiver Adjustment
- Loop Bandwidth Adjustment
- System Receiver Cal

System Verification

The performance of the network analyzer is specified in two ways: system specifications, and instrument specifications. It is the end user's responsibility to determine which set of specifications is applicable to their use of the analyzer.

A network analyzer measurement "system" includes the analyzer, calibration kit, test cables, and any necessary adapters. The system verification software in the analyzer is used to verify the system's conformance to the "system" specifications. A "pass" result demonstrates that the analyzer, test cables, and adapters, perform correctly as a system. It DOES NOT demonstrate that any one component performs according to its individual specifications. A change to any part of this measurement system requires a re-verification of the system.

Instrument specifications specify the network analyzer's uncorrected measurement port characteristics and its output and input behavior. The analyzer performance tests are used to verify the analyzer's conformance to "instrument" specifications.

The system verification utility verifies the analyzer system specifications by automatically measuring the magnitude and phase for all four S-parameters for each verification device, and comparing the values against the following:

- Factory measured data from files on the verification disk
- Limit lines based on the measurement uncertainty

System Verification requires the use of a calibration kit and verification kit which has been certified within the past 12 months by Keysight. System Verification can NOT be used to perform this kit certification.

Operator's Check should also be performed to verify the basic operation of the analyzer.

- **Equipment Used in the System Verification**
- **Precautions for Handling Airlines**
- **Flow Diagram of Procedure**
- **Procedure for System Verification**
- **If the System Fails the Verification Test**
- **Interpreting the Verification Results**

Notes

- Although the performance for all S-parameters is measured, the S-parameter phase uncertainties are less important for verifying system performance. Therefore, the limit lines will not appear on the printouts.
- System Verification can NOT be run with a Multiport test set enabled.
- The M9485A supports only ports 1 to 4. When the M9485A has any M9377As, system verification is not supported.

Equipment Used in the System Verification

VNA Models with 3.5 mm test ports

Equipment Type	3.5 mm	Type-N
Calibration kit	85052C/D, 85033D/E	85054D,85032B/E/F
or		
ECAL Module	N4691A	N4690A
Verification kit	85053B	85055A
RF Cable(s)	Single: 85131C/E Pair: 85131D/F	Single: 85132C/E Pair: 85132D/F
Adapters	None	Single: 85130C and one 7mm-to-Type-N from 85054B cal kit <u>Pair</u> : Two 7mm-to-Type-N from 85054B cal kit

Cable Substitution

The test port cables specified for the analyzer have been characterized for connector repeatability, magnitude and phase stability with flexing, return loss, insertion loss, and aging rate. Since test port cable performance is a significant contributor to the system performance, cables of lower performance will increase the uncertainty of your measurement. It is highly recommended that the test port cables be regularly tested.

If the system verification is performed with a non-Keysight cable, ensure that the cable meets or exceeds the operation of the specified cable. Refer to the cable User's Guide for specifications.

Cable Flex Factor

Flex Factor determines how much of the cable phase uncertainty to include in determining the limit lines.

- Set to **0% (zero)** if the cables are held down in a fixture and are not allowed to move during the calibration

and verification.

- Set to **100%** if the cables are allowed to move a lot.

Calibration Kit Substitution

Non-Keysight calibration kits are not recommended nor supported.

Precautions for Handling Airlines

When you are using the airlines in the verification kit, observe the following practices to ensure good measurement techniques.

- Be very careful not to drop the airline's center or outer conductor. Damage will result if these devices are dropped.
- Use proper Electro-Static Discharge (ESD) procedures.
- Clean your hands or wear gloves as skin oils will cause a change in electrical performance.

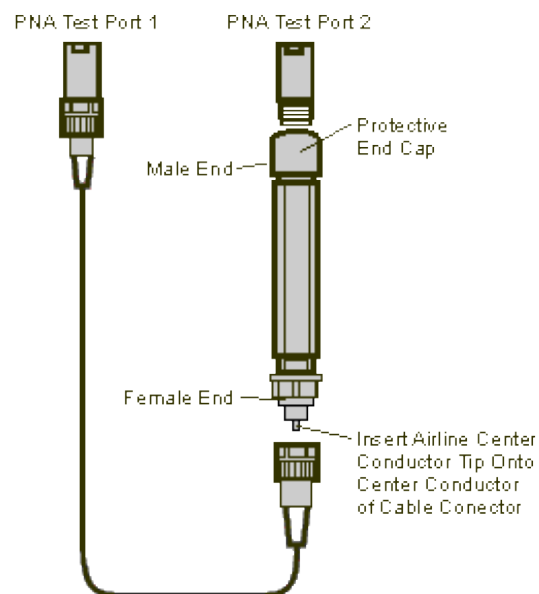

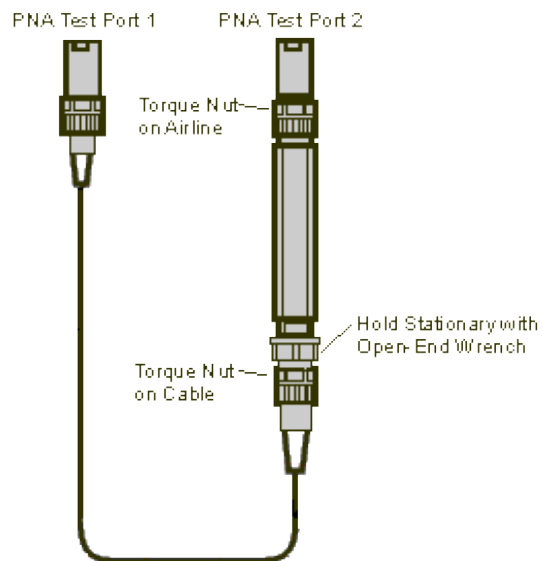

Flow Diagram of Procedure

The operational flow of the software is depicted by the flowchart shown below.

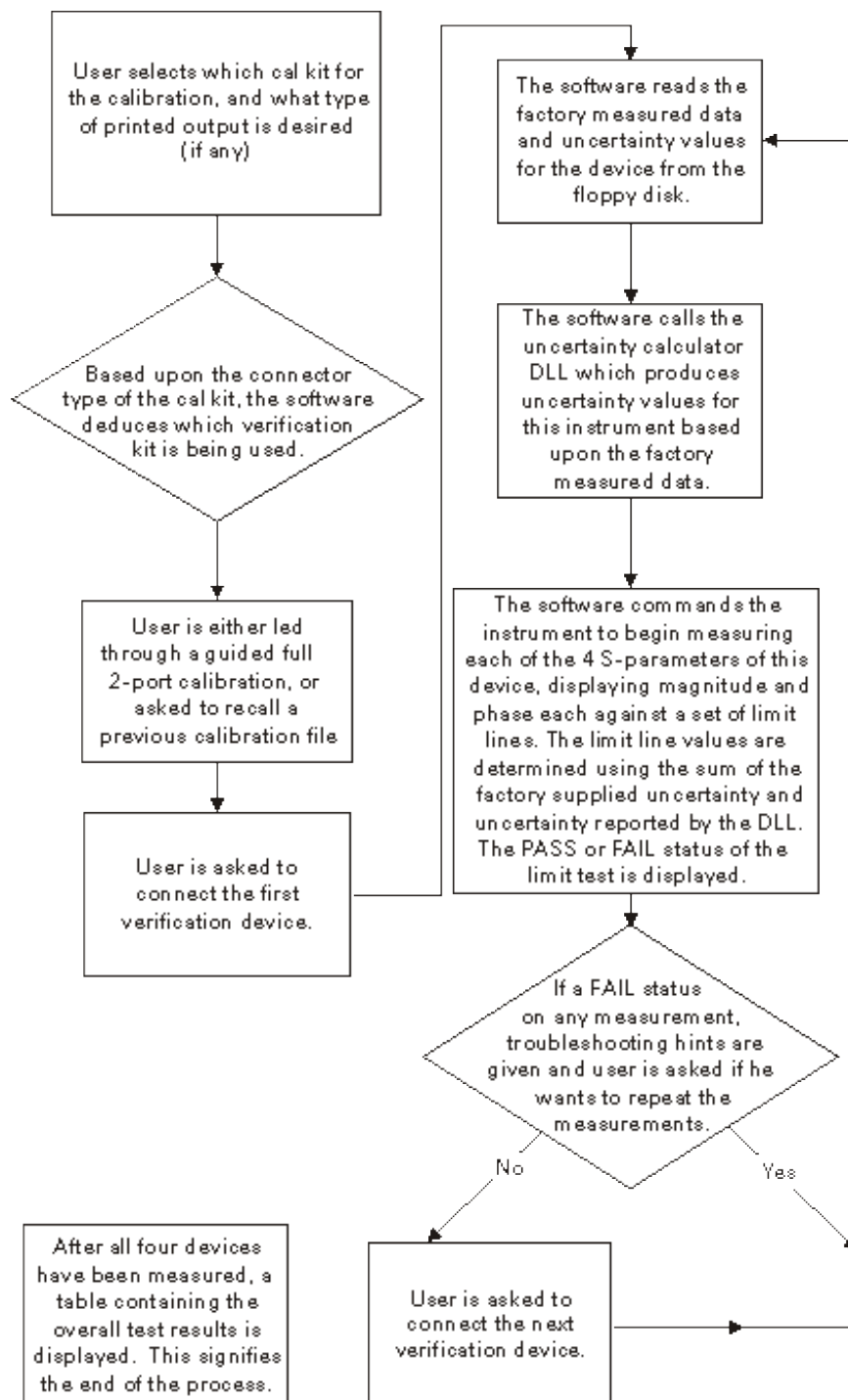

Procedure for System Verification

1. If you want printed test outputs, connect a printer to the analyzer. Let the analyzer warm up for at least 30 minutes.

2. Insert the verification kit USB memory into the analyzer USB port.
3. Press **System** > **Service** > **Verification** > **System Verification** . The System Verification window similar to this will be displayed.

System Verification Dialog

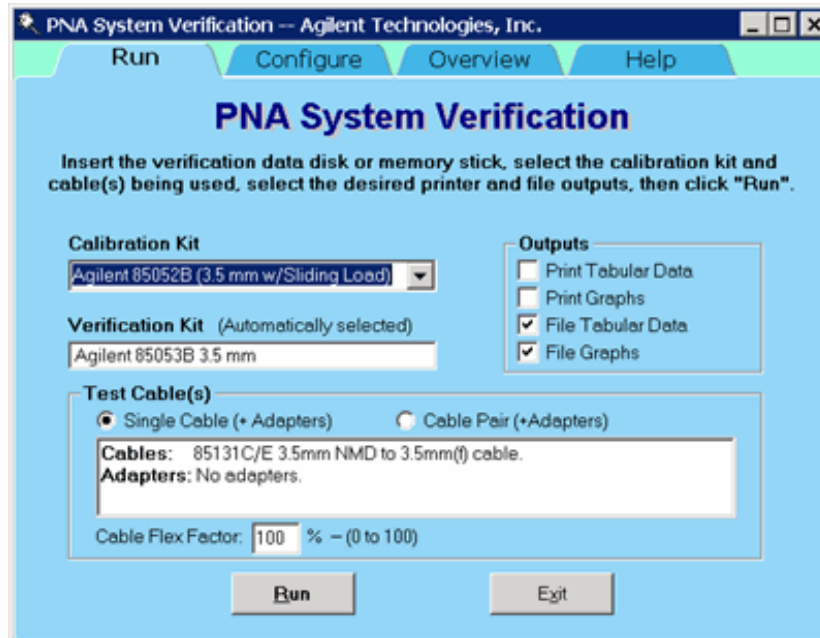

4. In the **Calibration Kit** box, select the calibration kit or ECal module that is being used. The corresponding verification kit to use appears in the **Verification Kit** box.
5. Under **Printer Output** click on any of the following options.
 - **Print Tabular Data:** Prints the verification data in tabular form which includes measured data and uncertainty limits. Refer to a tabular data example, later in this topic.
 - **Print Graphs:** Prints the verification data in graphical form. The graphic form includes the measured data trace, factory supplied data trace and uncertainty limits. Refer to a plot data example, later in this topic.
 - **File Tabular Data:** Writes the verification data in tabular form to a text file in the D:\ directory.
 - **File Graphs:** Saves a screen image in .PNG format in the D:\ directory.

Note: If you want printed output, it is assumed you have already installed the Windows driver for your particular printer, and have tested that you can print to the printer from the network analyzer. This software is designed to print to whichever printer is currently set as the Default printer (see Printers in the Windows Control Panel).

6. To modify the number of ports to be verified, to change the number of devices to measure, or to use a previously stored verification calibration, click on the **Configure** tab and make the desired selections.
 - o For the system verification to be truly adequate, the software must measure all devices in the kit with a recent calibration applied. Removing and reattaching any test port cables or adapters invalidates all previous calibrations.
7. Click **Run**.
8. Follow the instructions on the analyzer for performing the system verification, inserting the verification devices as prompted.

Note for 3 Port analyzer:

The System Verification Procedure is **repeated three times**. The first time, **Ports 1 and 2** are measured as a pair; then **Ports 1 and 3** are measured; and lastly, **Ports 2 and 3** are measured.

Note for 4 Port analyzer:

The System Verification Procedure is **repeated two times**. The first time, **Ports 1 and 2** are measured as a pair, then **Ports 3 and 4** are measured.

Step-by-Step Process Description

1. Depending upon the selected choice in the Calibration submenu of the Configure menu, the user is either prompted to recall a previous calibrated instrument state, or is guided through a full 2-port calibration using the selected calibration kit. For ECal, the ECal module is connected just once; a standby message is posted while the software is performing the calibration.
2. The user is prompted to connect the first verification device.
3. The software reads the factory measured data for that device and uncertainty values for that data (CITIfiles) from the floppy disk supplied with the verification kit.
4. The software sends the factory measured data, calibration kit and instrument state information to the uncertainty calculator DLL, which generates uncertainty values specific to the analyzer.
5. The analyzer first sets up for magnitude measurements of all four S-parameters, each parameter in a separate window (lin mag for S₁₁ and S₂₂, log mag for S₂₁ and S₁₂). Each of the factory measured S-parameters are fed to the appropriate window as a memory trace. Limit line offsets are calculated as the sum of the factory measured data uncertainties and analyzer uncertainties reported by the DLL. Upper and lower limits are displayed (factory measured data + uncertainty sum, factory measured data - uncertainty sum). The analyzer takes a sweep, limit test is turned on and PASS/FAIL status is reported in each of the four windows.
6. The user clicks a button when ready to view phase measurements. The four windows get updated for phase format, phase memory traces, phase limits and PASS/FAIL result.
7. If the limit test of any of the four S-parameters (magnitude or phase) indicates a FAIL status, the software

suggests troubleshooting tips and asks if the user would like to repeat measurement of that device or proceed to the next device. If proceeding to the next device, the factory measured data and uncertainties for the next device are read from floppy, the uncertainty DLL gets called with this next set of factory measured data, and the four measurement windows get updated for magnitude measurement of the next device.

8. The software follows this same process until all selected devices have been measured, at which point a summary window is displayed containing the set of PASS/FAIL results for all four parameters of each device.

If the System Fails the Verification Test

IMPORTANT: Inspect all connections. Do not remove the cable from the analyzer test port. This will invalidate the calibration that you have done earlier.

1. Repeat this verification test. Make good connections with correct torque specifications for each verification device.
2. Disconnect, clean and reconnect the device that failed the verification test. Then measure the device again.
3. If the analyzer still fails the test, check the measurement calibration by viewing the error terms as described in "Front Panel Access to Error Terms" on page 4-7 of the Service Guide.
4. Refer to the graphic below, for additional troubleshooting steps.

Verification Fails Flowchart

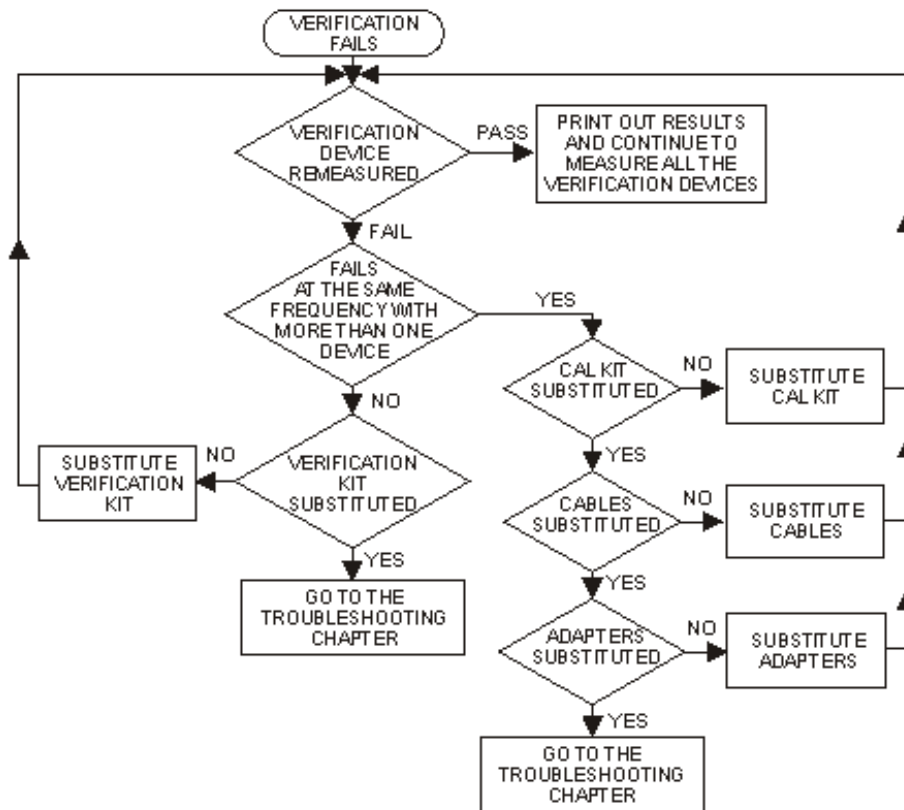

Interpreting the Verification Results

The graphic below shows an example of typical verification results with **Tabular Data** selected in the **Printer Output** area of the **System Verification** window. A graphic later in this topic shows an example of typical verification results with **Measurement Plots** selected in the **Printer Output** area of the **System Verification** windows. These printouts include a comparison of the data from your measurement results with the traceable data and corresponding uncertainty specifications. Use these printouts to determine whether your measured data falls within the total uncertainty limits at all frequencies.

The tabular data consists of:

- Frequency of the data points (in MHz).
- Lower limit line as defined by the total system uncertainty specification.
- Results of the measurement.
- Upper limit line as defined by the total system uncertainty specification.
- Test status (PASS or FAIL) of that measurement point.

Printout of Tabular Verification Results

The image shows a printed document with two tables of tabular verification results. The tables are arranged vertically, with the second table partially overlapping the first. Each table has a header row and multiple data rows. The columns in the tables include measurement parameters, upper and lower limit points, and measured data. The text is small and difficult to read, but the structure is consistent across both tables.

The printed graphical results show:

- Upper limit points as defined by the total system uncertainty specifications.
- Lower limit points as defined by the total system uncertainty specifications.
- Data measured at the factory.
- Results of measurements.
- Measurement parameter names and formats (Lin Mag or Log Mag).
- Serial number of device (00810).
- Device being measured (Sys Ver 20 dB attenuator).

Printout of Graphical Verification Results

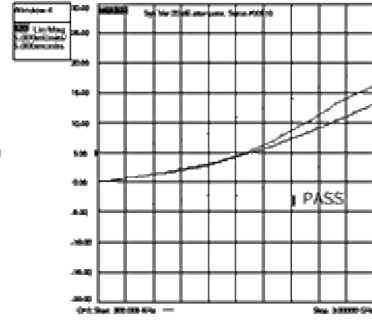
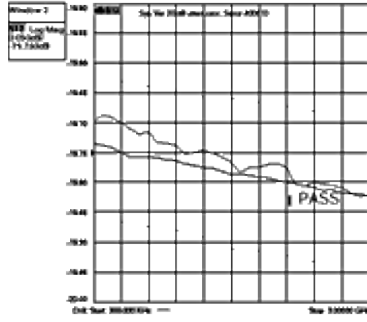
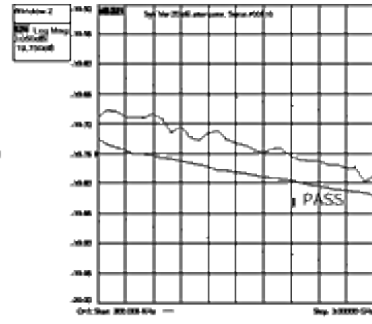
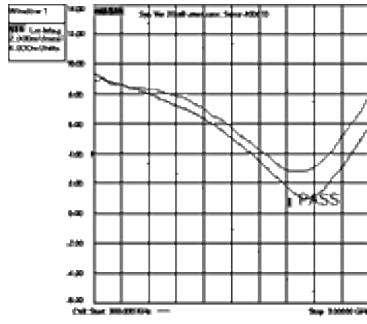

Operator's Check

- [Overview](#)
- [How to Run the Operator's Check](#)
- [Operators Check Dialog Box Help](#)

Tip: Use Move App to Back to cause the VNA application to move behind this application on the screen.

Overview

The Operator's Check should be performed when you first receive your VNA, and any time you wish to have confidence that the VNA is working properly.

Notes

- The Operator's Check does not verify performance to specifications. To verify VNA performance to specifications, run [System Verification](#).
- Allow the VNA to warm up for 30 minutes before considering a failed test to be valid.

How to Run the Operator's Check

Using [Hardkey](#)/[SoftTab](#)/[Softkey](#)

1. Press [System](#) > [Service](#) > [Operator's Check](#).

1. Follow the instructions to proceed with the test.

M9485A

The Operator's Check is executed at power on at default. It can be selected at [preference](#). No tool is required. Generally, no dialog box are shown if the test passed. If some tests are failed, see [Troubleshooting Hint for M9485A](#)

M9371A, M9372A, M9373A, M9374A, M9375A, and P937xA

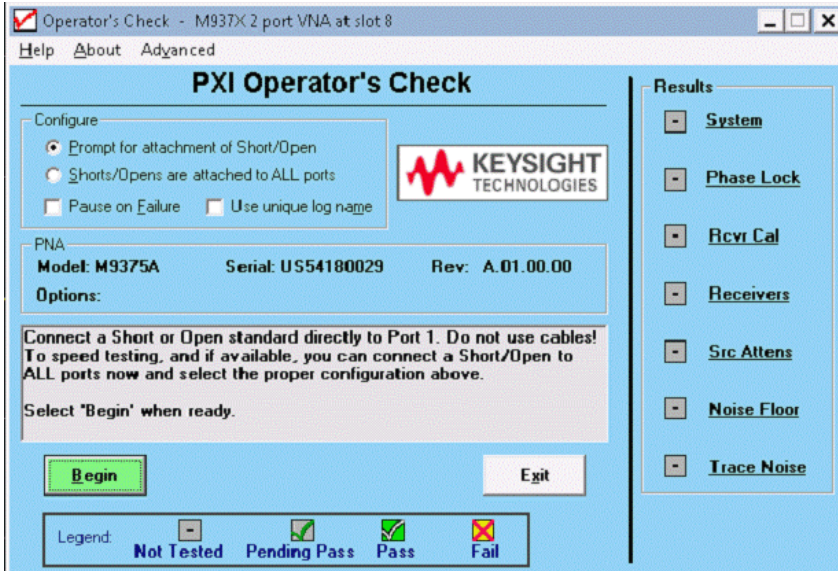

This dialog box will look slightly different, depending on VNA model number and installed options. Some of the tests are not run if the appropriate option is not installed.

To learn about how each test is performed, click one of the tests on the right of the dialog. For example, the following information dialog is launched when **Leveling** is clicked:

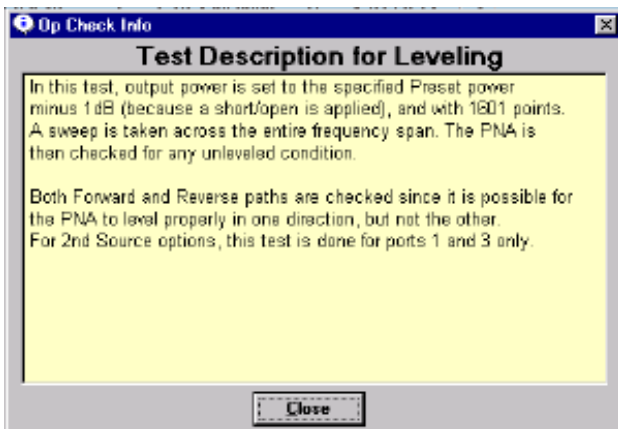

Operators Check dialog box help

Note: It is normal for a momentary unlevelled condition to appear during portions of the Operators Check.

Configure

Prompt for attachment of Short / Open If you do not have enough shorts or opens for all test ports, you will be prompted to move the standard to the next test port. Connect either a short or open to port 1, then click Begin.

Shorts / Opens are attached to all ports Connect either a short or open for each test port, then click Begin. All ports are tested without interruption. You can mix shorts and opens on the test ports.

VNA Shows information about the VNA that is being tested.

Legend Shows the status icons used in the Operator's Check and their meaning. **Pending Pass** means that a portion of the testing has been completed successfully.

Results Shows the current status of each test. Click on the test name to learn how that test is performed. This may help in troubleshooting failed tests. If any tests Fail, refer to Chapter 3 of the VNA service guide.

Begin Starts the Operator's Check.

View Results Shows all results in text format. Failed items are preceded by ==>>>.

This text file can be printed or saved with a unique file name to compare results with previous or subsequent testing.

Exit Ends the program and closes the window.

Troubleshooting Hint for M9485A

Trouble on Launcher

When you encounter a problem on the M9485A launcher such as the modules cannot be displayed, execute the following steps.

1. Close the M9485A SFP launcher.
2. Execute the Connection Expert.
3. Click "Rescan" button at the top left in the Instrument tab.
4. Execute the M9485A SFP launcher.
5. If it is still not resolved, reboot the system (chassis and PC).
6. If it is still not resolved, reinstall the IO library.

Operator's check or Start up Self Test Fail

When the operator's check or start up self test is failed, read the dialog message and check the cable connection first. The cable connection includes not only cable itself but also the divider and smp-smp adapter which connects between receiver modules and divider.

The operator's check consists of the following three parts.

- Module Check
- Digital Connection Check
- Analog Connection Check

The following figure shows the flow. When a test is failed, an error message is displayed and store the failed information into the log file.

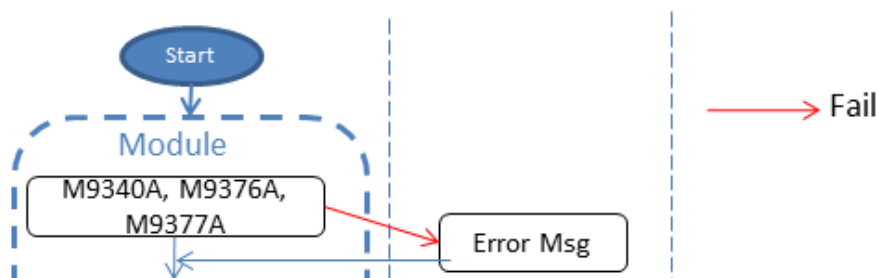

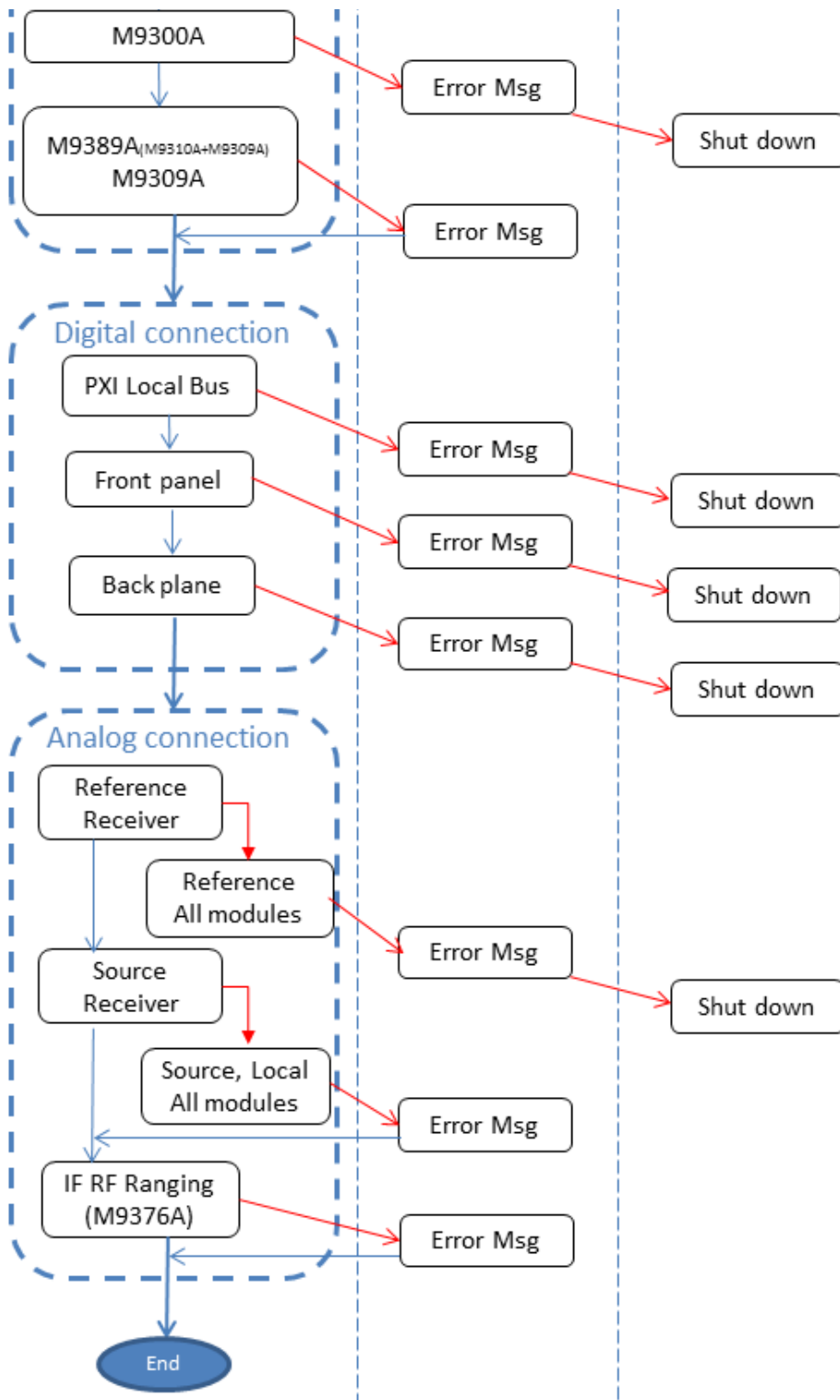

Digital Connection Check

PXI Local Bus

When you have this error, replace the module into the other slot. If the failed slot is still the same, the

chassis is suspicious.

Front Panel

Check the front panel cable connections.

Back Plane

Check the Connection Expert to confirm if the chassis is detected correctly.

When you are using non-Keysight chassis and digital connection test failed, check the trigger bus routing of chassis. See FAQ of M9485A in the Keysight web page for non-Keysight chassis setup. The trigger bus routing for the Keysight chassis is defined automatically, however, check the chassis SFP to confirm if the trigger bus routing is correct. Refer to the Trigger Bus Routing below. If it is not correct, see Trouble_on_Launcher .

Module and Analog Connection Test

If multiple failures occur, open the M9485A_SelftestLog.txt under C:\Users\Public\Public Documents\Network Analyzer. Check the failed test number (Rx, Sx or Lx) in the log file. See the following tables to find out the failure point.

- 1-Chassis Configuration
 - Trigger Bus Routing
- 2-Chassis Configuration
 - Trigger Bus Routing

Here are notes for troubleshooting.

- When both module and analog connection checks are failed at the same time, refer to the module test first and check it. When both Sxx and Lxx are failed at the same time in analog connection check, refer to Lxx first and check it. If it seems good, refer to Sxx result.
- When PXI trigger bus connection test is failed, confirm if the Connection Expert detects the chassis by clicking "Rescan" in its Instrument tab, then restart Soft Front Panel (SFP) again. If it is still failed, the chassis may have problem. If you are using non-Keysight chassis, see FAQ of M9485A in the Keysight web page for non-Keysight chassis setup.
- When the self test is passed but the absolute measurement is noisy, confirm if the unused output ports on the M9340A are terminated with 50 Ω loads.
- If you have some same modules, swapping the modules will help to isolate the module.

1-Chassis Configuration

***: Most suspicious, ** : Middle, *: Low

F: Fail, Blank: Pass, NC: Pass or Fail

Reference Test

- R6: M9309A Synthesizer Module 100MHz Output Test (Left one, for source signal)
- R7: M9310A Source Output Module 100MHz Input Test

Test No.	Suspicious Points
R6 R7	M9309A (Left one, Source) Connection between M9309A (Left one, Source) M9310A and M9310A
F F	***
F	** *

- R11: M9376A/M9377A Receiver Module{1-12} 100MHz In 100MHz Input Level Test
- R12: M9376A/M9377A Receiver Module{1-12} 100MHz In 100MHz Input Frequency Test

Test No.	Suspicious Points
R11 R12	Connection between M9300A and M9376A/M9377A M9376A/M9377A
F F	** *
F	***

Source Test

- S19: M9310A Source Output Module Output Amp Test1
- S20: M9310A Source Output Module Output Amp Test2
- S4: M9340A Distributor Module A In Source Input Level Test
- S5: M9340A Distributor Module A In Source Frequency Test
- S6: M9340A Distributor Module A Out1/2/3 Source Output Test
- S7: M9376A/M9377A Receiver Module{1-12} Source In Source Input Test

- S8: M9376A/M9377A Receiver Module{1-12} Source Connection Test
- S9: M9376A Receiver Module{1-12} Test Port Test (No test for M9377A)

Test No.		Suspicious Points										
S19	S20	S4	S5	S6	S7	S8	S9	M9310A	Connection between M9310A and M9340A	M9340A	Connection between M9340A and M9376A/M9377A	M9376A/M9377A
F	F	F	F	F	F	F	F	***				
	F	F	F	F	F	F	F	***				
		F	F	F	F	F	F	*	**	*		
			F	F	F	F	F		***			
				F	F	F	F			***		
					F	F	NC					***
						F	NC				***	
							F					***
						F	NC				***	
LO Test												

- L1: M9309A Synthesizer Module LO Output Test (Right one, for LO signal)
- L2: M9340A Distributor Module B In LO Input Level Test
- L3: M9340A Distributor Module B In LO Input Frequency Test
- L4: M9340A Distributor Module B Out1/2/3 LO Output Test
- L5: M9376A/M9377A Receiver Module{1-12} LO In LO Input Test
- L6: M9376A/M9377A Receiver Module{1-12} LO In LO Connection Test

Test No.	Suspicious Points
----------	-------------------

	L1	L2	L3	L4	L5	L6	Connection M9309A (Right one, LO)	between M9309A (Right one, LO) and M9340A	Connection between M9340A and M9376A/M9377A	M9376A/M9377A
F	F	F	F	F	F	F	***			
	F	F	F	F	F		**	*		
		F	F	F	F		***			
			F	F	F			***		
				F	F				***	
					F					***
						F				***

Cable Connections for M9376A configuration

If your configuration includes M9377A, refer to the installation guide.

**12 Port
Config.**

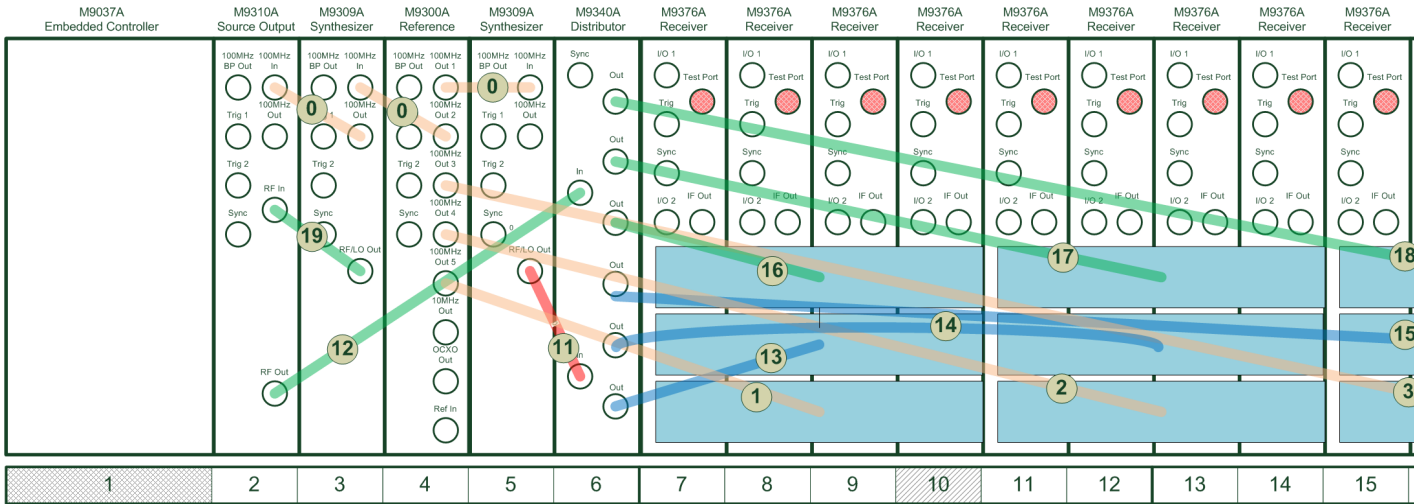

Chassis Trigger Bus Routing

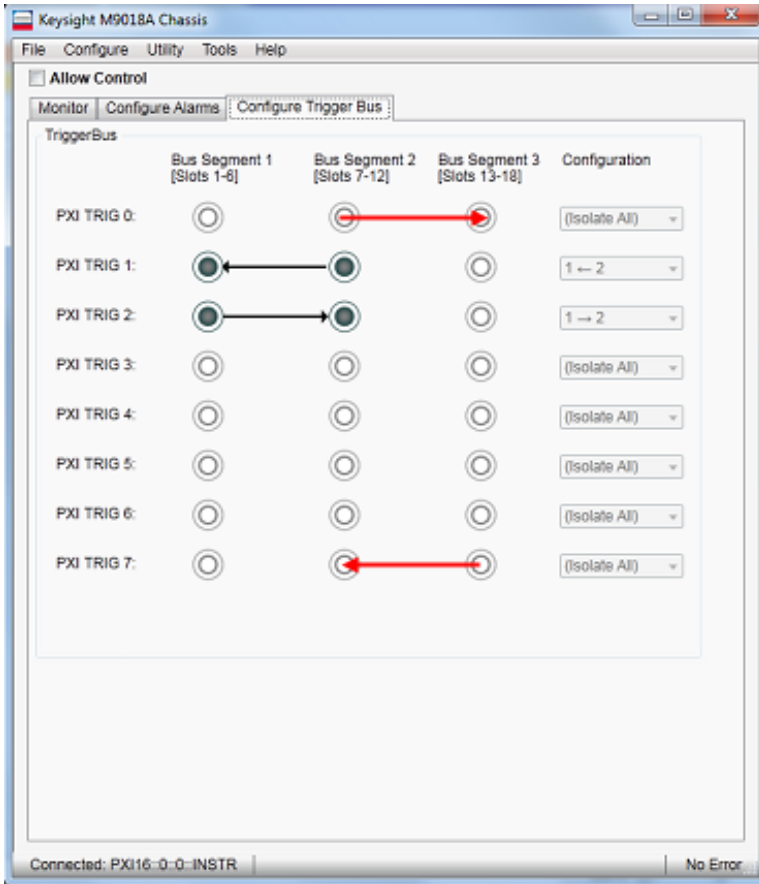

When the number of receivers is equal and more than 7, the red arrows should be connected.

2-Chassis Configuration

***: Most suspicious, ** : Middle, *: Low

F: Fail, Blank: Pass

Chassis A: has M9310A and M9309A

Chassis B: has M9300A

Note: Refer to PXI/AXIe Chassis tab in Keysight Connection Expert for chassis No. 1 or 2 in the error message.

Reference Test

- R6: M9309A Synthesizer Module 100MHz Output Test (Left one, for source signal)
- R7: M9310A Source Output Module 100MHz Input Test

Test No.	Suspicious Points
R6 R7	M9309A (Left one, Source) Connection between M9309A (Left one, Source) and M9310A M9310A

F F ***
F ** *

- R13: M9340A Distributor Module{1,3} B In 100MHz Input Level Test
- R14: M9340A Distributor Module{1,3} B In 100MHz Input Frequency Test
- R15: M9340A Distributor Module{1,3} B Out1/2/3 100MHz Output Test
- R11: M9376A/M9377A Receiver Module{1-24} 100MHz In 100MHz Input Level Test
- R12: M9376A/M9377A Receiver Module{1-24} 100MHz In 100MHz Input Frequency Test

Test No.	Suspicious Points
----------	-------------------

R13	R14	R15	R11	R12	Connection between M9300A and M9340A (Left one in Chassis A or Chassis B)	M9340A (Left one in Chassis A or Chassis B)	Connection between M9340A (Left one in Chassis A or Chassis B) and M9376A/M9377A	M9376A/M9377A
F	F	F	F	F	**	*		
	F	F	F	F	***			
		F	F	F		***		
			F	F			**	*
				F			***	

Source Test

- S19: M9310A Source Output Module Output Amp Test1
- S20: M9310A Source Output Module Output Amp Test2
- S10: M9340A Distributor Module1 A In Source Input Level Test

- S11: M9340A Distributor Module1 A In Source Input Frequency Test
- S12: M9340A Distributor Module1 A Out1/2/3 Source Output Test

Test No.	Suspicious Points
----------	-------------------

S19 S20 S10 S11 S12 M9310A	Connection between M9310A and M9340A (Left one in Chassis A) M9340A (Left one in Chassis A)
----------------------------	---

F	F	F	F	F	***			
	F	F	F	F	***			
		F	F	F	*	**		*
			F	F		***		
				F				***

- S4: M9340A Distributor Module{2,4} A In Source Input Level Test
- S5: M9340A Distributor Module{2,4} A In Source Frequency Test
- S6: M9340A Distributor Module{2,4} A Out1/2/3 Source Output Test
- S7: M9376A/M9377A Receiver Module{1-24} Source In Source Input Test
- S8: M9376A/M9377A Receiver Module{1-24} Source Connection Test
- S9: M9376A Receiver Module{1-24} Test Port Test (No test for M9377A)

Test No.	Suspicious Points	
S4 S5 S6 S7 S8 S9	Connection between M9340A (Leftt one in Chassis A) and M9340A (Right one in Chassis A and B)	Connection between M9340A (Right one in Chassis A and B) and M9376A/M9377A
F F F F F F	**	*
F F F F F	***	
F F F F		***
F F NC		***
F NC		***
F		***
F NC		***
LO Test		

- L1: M9309A Synthesizer Module LO Output Test (Right one, for LO signal)
- L7: M9340A Distributor Module3 A In LO Input Level Test
- L8: M9340A Distributor Module3 A In LO Input Frequency Test
- L9: M9340A Distributor Module3 A Out1/2/3 LO Output Test

Test No.	Suspicious Points
L1 L7 L8 L9	Connection between M9309A (Right one in Chassis A) and M9340A (Left one in Chassis B)
M9309A (Right one, LO)	
F F F F	***

F	F	F	**	*
	F	F	***	
		F		***

- L2: M9340A Distributor Module {2, 4} B In LO Input Level Test
- L3: M9340A Distributor Module {2, 4} B In LO Input Frequency Test
- L4: M9340A Distributor Module {2, 4} B Out1/2/3 LO Output Test
- L5: M9376A/M9377A Receiver Module {1-24} LO In LO Input Test
- L6: M9376A/M9377A Receiver Module {1-24} LO In LO Connection Test

Test No.						Suspicious Points								
						Connection between M9340 (Right one in M9340A (Right Chassis B) and M9340A (Left one in Chassis B)			Connection between M9340A (Right one in Chassis A and B) and M9376A/M9377A					
L2	L3	L4	L5	L6										
F	F	F	F	F		**		*						
	F	F	F	F		***								
		F	F	F				***						
			F	F									***	
				F									***	
					F								***	

Cable Connections for M9376A configuration

If your configuration includes M9377A, refer to the installation guide.

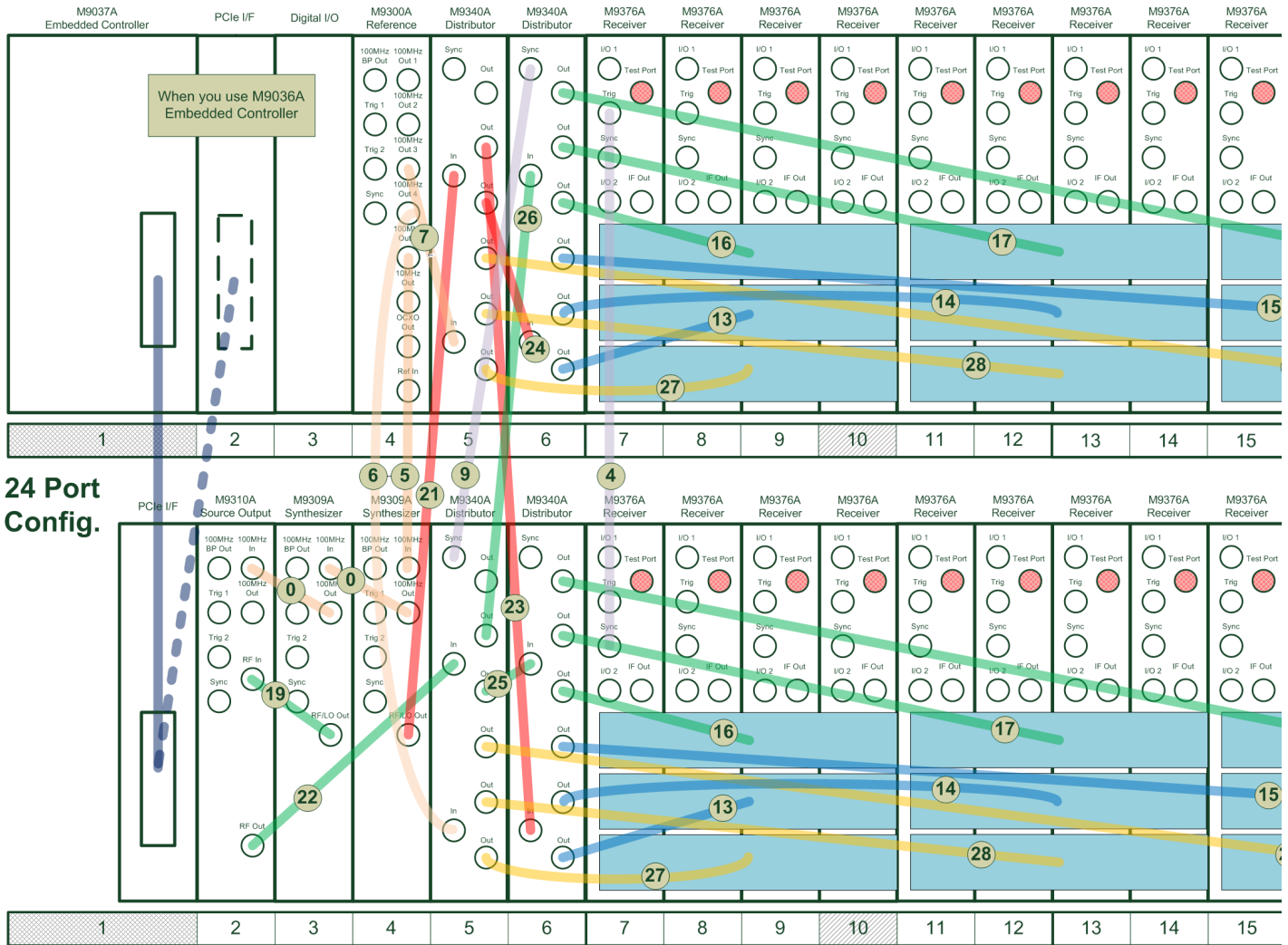

**Chassis Trigger Bus Routing
Chassis A**

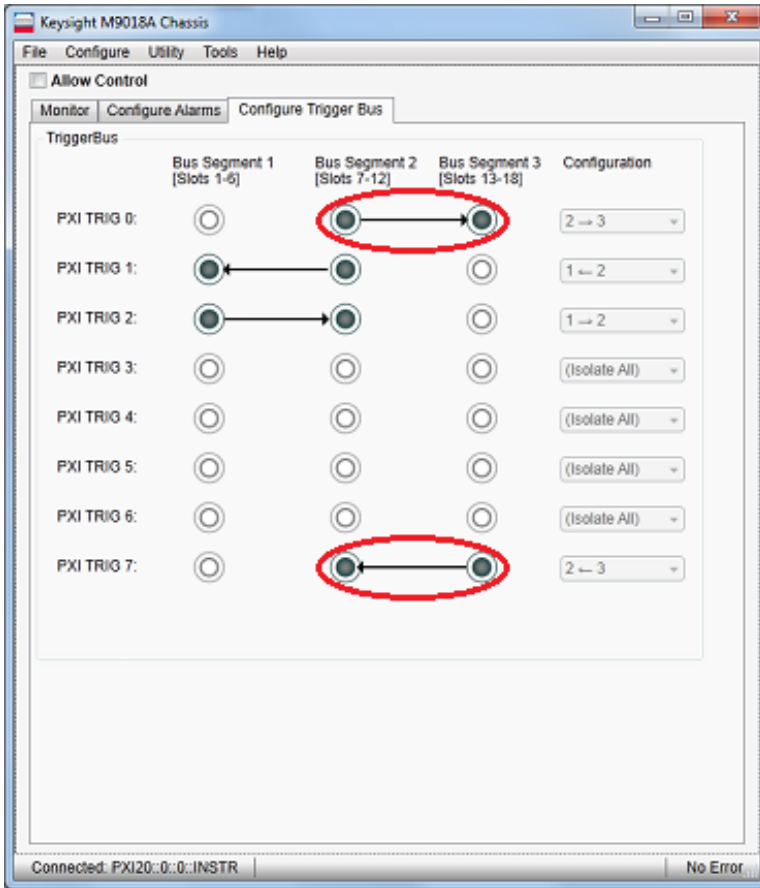

When the number of receivers is equal and more than 6, the arrows in red circle are not connected.

Chassis B

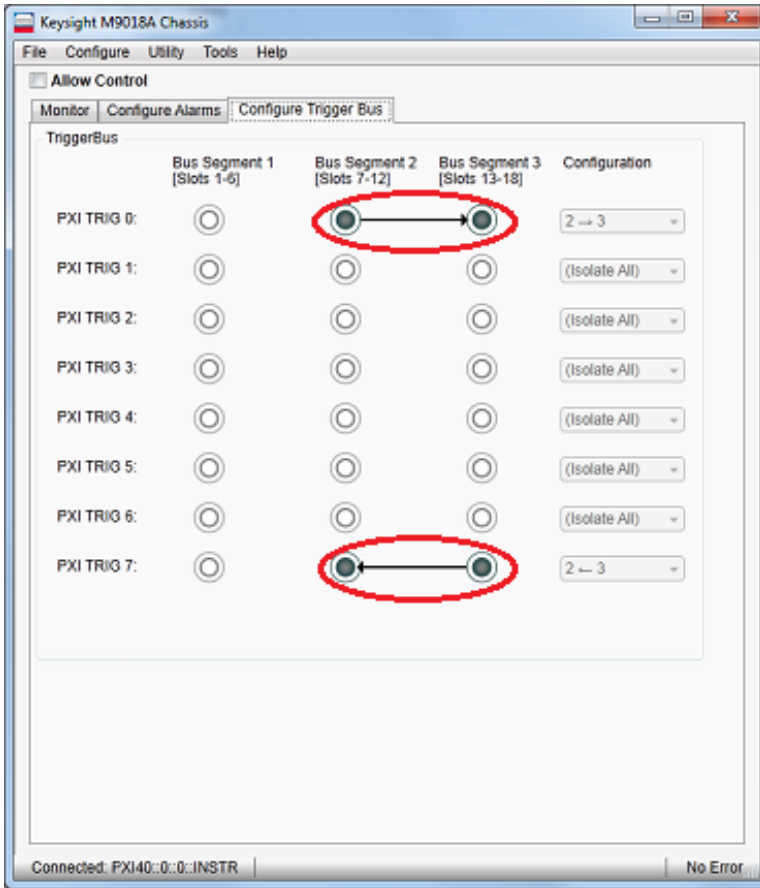

When the number of receivers is equal and more than 6, the arrows in red circle are not connected.

Last modified:

20-May-2019 New topic

10 MHz Reference Frequency Adjustment

This routine adjusts the analyzer's internal time-base to exactly 10 MHz by changing a DAC value. This DAC value is stored in the analyzer's non-volatile memory. This routine should only be necessary in the following situations:

- The frequency reference assembly is replaced.
- The 10 MHz reference has drifted significantly from the factory adjusted value.

WARNING: The range of this adjustment is only about 20 Hz. It is highly recommended that a very accurate frequency standard be used to measure this 10 MHz signal.

NOTE: This is not available for E5080, M980xA, P50xxA and M9485A. An adjustment software is provided as an external software.

Frequency Counter Compatibility

This procedure uses SCPI commands (over GPIB) to communicate with the frequency counter. It should work with the Keysight R5313xA, 5315xA, 53181A series of counters as well as the older 5350 series.

If no compatible counters are available, select the "Manual" mode of operation.

Procedures

Note: You must be logged onto the VNA as an Administrator to perform an adjustment. [Learn more.](#)

Click **Utility**, then **System**, then **Service**, then **Adjustment Routines...**

At the Adjustments selection, click **10 MHz Frequency Adjustment**

Procedure for GPIB Counters Only

1. Connect the analyzer rear panel 10 MHz Reference output to the frequency counter .
2. Connect a GPIB cable from the analyzer to the counter. Make sure no other controllers are active on the same connection.
3. If applicable, connect the house frequency standard to the counter reference input.

4. Set the counter GPIB address to 03. Ensure that the counter is the only device at this address.
5. On the VNA, press **System** > **Service** > **Adjustment Routines...**, then **10 MHz Freq. Adjust**.
6. Click **Begin Adj**. The application adjusts the internal reference for minimal error and stores the results.
7. Click **Read Freq** to trigger another reading of the 10 MHz signal.
8. Read the current DAC value stored in the analyzer's non-volatile memory (value = 0 - 4095).
9. When the status area indicates the adjustment is complete, click **Exit**.

Procedure for Non-GPIB Counters

1. Connect the counter input to the rear panel 10 MHz Reference Output.
2. Set the counter to at least 1 Hz resolution.
3. If applicable, connect the house-frequency standard to the counter reference input.
4. In the analyzer **System** > **Service** > **Adjustment Routines...**, then click **10 MHz Freq. Adjust**.
5. Under **Frequency Counter**, select **Manual**.

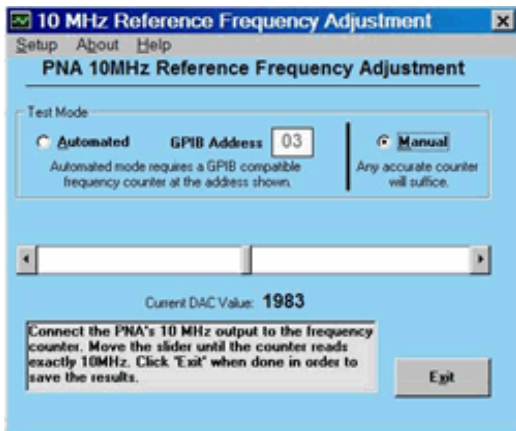

- Adjust the slider bar **arrows** until the frequency counter reads 10.0 MHz at your desired level of accuracy.
- Click **Exit** to save the results.

Data Storage

- The correction data is stored in the EEPROM on the 10MHz Ref board assembly.

Note: If the counter is misreading the frequency, it may be necessary to attenuate the input, or set the

input impedance to 50 ohms, or both.

Source Adjustment

Source Adjustment is a **SERVICE** Routine which should be performed when a component in the source chain is replaced, or when the VNA fails an annual calibration. It adjusts the VNA source power for flatness across its full frequency range.

This topic does **NOT** discuss [Source Power Calibration](#), which calibrates a VNA source over the current measurement range.

NOTE: This is not available for E5080A and M9485A. An adjustment software is provided as an external software.

Required Equipment

Note: The power sensor depends on the VNA frequency range. Depending on the VNA model, two power sensors may be required to test the full frequency range. The VNA front panel connector type will determine the cable used and if an adapter is required with the power sensor(s).

[See list of supported power meters and sensors.](#)

[See VNA Accessories](#)

Procedure

Note: You must be logged onto the VNA as an Administrator to perform an adjustment. [Learn more.](#)

1. Refer to your power meter documentation to ensure the proper calibration factors for the power sensor have been entered into the table on the power meter.
2. Connect a GPIB cable between the power meter and network analyzer (use the System Controller GPIB port if applicable.)
3. Ensure the power sensor(s) are connected to the power meter.
4. Click **Utility**, then **System**, then **Service**, then **Adjustment Routines...**
5. At the [Adjustments selection](#), click **Source Adjustment**.
6. There are 3 different versions of the Source Calibration software; all are slightly different. All have a button that is labeled "Calibrate" or "Adjust". This is the button that will begin the calibration process. Some versions will also have a button labeled "Verify" that will test the source calibration without making any changes. Other selections are for factory personnel use only.
7. Once begun, you must enter the power meter and sensor information. The software will verify the power meter and sensor. You are then prompted to connect the sensor(s) and cable as needed.

Additional Information

All ports are tested on all VNAs. Source calibration takes approximately 10 to 45 minutes to complete depending on the frequency range and model number of the VNA.

Troubleshooting

In the event there is a problem with Source Adjustment, please refer to the "Troubleshooting" chapter in the VNA Service Guide.

Data Storage

- The correction data is stored in the flash memory on the Test Set Mother Board.
-

Receiver Adjustment

This program adjusts the network analyzer receivers for a flat response across its full frequency range. This adjustment is for service only; not for measurement calibration.

NOTE: This is not available for E5080A and M9485A. An adjustment software is provided as an external software.

Required Equipment

See [list of supported power meters and sensors](#).

See [VNA Accessories](#)

Notes

- The power sensor depends on the VNA frequency range. Depending on the VNA model, two power sensors may be required to test the full frequency range. The VNA front panel connector type will determine the cable used and if an adapter is required with the power sensor(s).
- In this adjustment, a power sensor with a specified lower frequency limit of 50 MHz may be used on all instrument that have a lower frequency limit of 10 MHz. Any added uncertainty is negligible.
- If using an older style sensor (without built-in correction factors), refer to your power meter documentation to ensure the proper calibration factors for the power sensor have been entered into a table on the power meter.
- You must be logged onto the VNA as an Administrator to perform an adjustment. [Learn more](#).

Procedure

1. Click **Utility**, then **System**, then **Service**, then **Adjustment Routines...**
2. At the Adjustments selection, click **Receiver Adjustment**
3. Connect a GPIB cable between the power meter and network analyzer.
4. Ensure the power sensor(s) are connected to the power meter.
5. The software presents you with two choices:

- a. Click **Inspect Flatness** to observe flatness of receiver response versus frequency. Although there is no explicit specification for receiver flatness, Receiver Calibration should improve Transmission and Reflection Tracking error terms which are specified.
- b. Click **Calibrate** to begin the receiver calibration process. The software prompts you to connect the sensor(s), cable and adapter as needed.

Additional Information

- Receiver Adjustment tests all VNA receivers, taking approximately 15 and 45 minutes. Length is dependent on frequency range and number of ports.
- Upon completion of the Receiver Adjustment, a transmission measurement of a good quality cable should appear to be smooth, with slightly increasing loss versus frequency. A reflection measurement of a short or open should appear to be a flat line across the entire frequency range with only a dB or two of variation/ripple. If instead, you see variations of 10-40dB, then the VNA may have a mixer problem. Typically, this means the uncorrected low end frequency phase relative to other receivers is different. This causes the correction algorithm to "blow up" and provide wildly incorrect data. This is almost always a hardware problem and typically one or more receivers must be replaced. The adjustment procedure has a quick test for this and it will show a warning message if excess phase shift is detected, however this test is not definitive and may not always catch every problem.

Troubleshooting

In the event there is a problem with Receiver Adjustment, please refer to the "Troubleshooting" chapter in your VNA Service Guide.

Data Storage

- The correction data is stored in the flash memory on the Test Set Mother Board.
-

Receiver Display

- [The Receiver Display as a Troubleshooting Tool](#)
- [How to start the Receiver Display](#)

NOTE: The is not available for E5080A and M9485A. An adjustment software is provided as an external software.

Other Support Topics

The Receiver Display as a Troubleshooting Tool

The Receiver Display is a Troubleshooting Tool. It enables the analyzer to isolate faulty functional groups within its own Measurement System. Traces for each Receiver are Displayed in individual windows. Identifying discrepancies of the traces in these windows can help isolate the faulty assembly.

For a thorough description of Receiver Display and the troubleshooting steps see the Service Guide for your VNA. You can download the Service Guide from our website: <http://na.support.keysight.com/pna/> or <http://na.support.keysight.com/pxi/>

How to Start the Receiver Display

Using **Hardkey/SoftTab/Softkey**

1. Press **System** > **Service** > **Diagnostics** > **Receiver Display...**

Using a mouse

1. Click **Utility**
2. Select **System**
3. Select **Service**
4. Select **Diagnostics**
5. Select **Receiver Display...**

Programming Commands

RF Amplifier Module Control

Note: The P937xA does not support this function.

When you use the M9485A, you can control the M9379A amplifiers through the VNA firmware if the M9379As are included at launcher.

The Atten, Path, and Switch can be set independently for each channel when the connection for sync signal is made. Refer to [Handler I/O Connector \(M9485A\)](#). The independent settings (Atten/Path/Switch) for sweep segment are not possible.

WARNING: When connecting or disconnecting a cable to the module, do not touch the open end of the cable. Doing so may damage the module by electrostatic discharge (ESD).

Note: Place M9379A at just right after M9376A/7A/8AB, M9341A/B or M9161D modules or between them. Empty slot or the M9485A unsupported modules (other than M9376A/7A/8AB, M9341A/B, M9161D) is not allowed to locate between M9340A and M9379A.

How to Control RF Amplifier Module

Using [Hardkey/SoftTab/Softkey](#)

1. Press **Setup** > **Internal Hardware** > **PXI Device...**
2. Click **M9379 Amp Setup..** to control the M9379A amplifier.

Using a mouse

1. Click **Instrument**
2. Select **Setup**
3. Select **Internal Hardware**
4. Select **PXI Device..**
5. Select **M9379A Amp Setup..**

[Programming Commands](#)

M9379A Amp Setup dialog box help

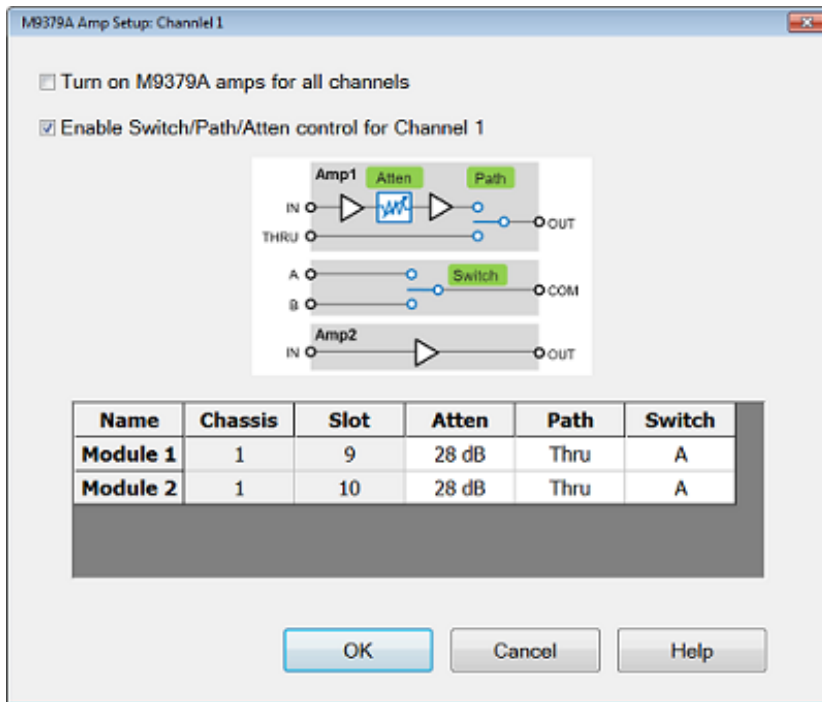

Turn on M9379A amps for all channels: Master switch for all amplifiers and switch of all M9379A modules. LED on the front panel is changed as follows.

- ON: Dark green
- OFF: Light green

Note: 45-minute warm up time after this switch ON is required to meet the specification accuracy.

Enable Switch/Path/Atten control for Channel n: The settings are applied for the selected channel. The setting of Switch/Path/Atten is independent for each channel.

Name: Module number.

Chassis: Chassis number where the module is located.

Slot: Slot number where the module is located.

Atten: Attenuator setting for the amplifier 1. This can be set from 0 to 28 dB with 2 dB step.

Path: Path for amplifier 1. Select **Thru** or **Amp**. When Noise Figure Cold Source is selected as Meas Class, **NF Receiver** can be selected.

- **NF Receiver:** The switch is used for pre-amp/thru selection between DUT and test port n. The **Thru** is selected during S parameter measurement. The **Amp** is selected during NF

measurement.

Switch: Path for switch. Select **A** or **B**. When Noise Figure Cold Source is selected as Meas Class, **NF Source**, **NF LO** or **NF Receiver** can be selected.

- **NF Source:** The switch is used as RF Out switch to terminate the DUT input with 50 ohm. RF out should be connected with port A. 50 ohm termination should be connected with port B. The port A is selected during S parameter measurement. The port B is selected during NF measurement.
- **NF LO:** The switch is used as Local selection for **dual band NF measurement**. (Option 720 only)
- **NF Receiver:** The switch is used for pre-amp/thru selection between DUT and test port n. The port A is selected during S parameter measurement. The port B is selected during NF measurement.

Note: Control the gain of M9379A properly in order to avoid saturation and overload from receivers due to amplified source signal noise by the M9379A. When the M9379A Amp1 is used with the M9377A DRA modules (receiver attenuator = 0 dB), It is recommended that the M9379A Amp1 attenuator sets at 10 dB or above. When the M9379A Amp2 is used, inserting 10 dB attenuator between Amp2 and the M9377A is recommended.

Limitations

- Changing the M9379A settings does not affect the **error correction level notation** on the status bar. The correction level is not changed even if the M9379A settings are changed. However, the M9379A setting may affect the correction. In that case, re-calibration is recommended.
- The state file can be recalled even if the number of M9379A module on save is different. When more M9379A modules are installed at recall, the additional modules are set at default. The slot number and M9379A serial number are not saved into the state file. Hence, the state is recalled even if you install it into any other slot or the other M9379A module. The M9379A configuration change does not affect the **error correction level notation**. Re-calibration may be required if your M9379A configuration is different from the time of save.

Switch Module Control

Note: The USB VNAs do not support this function.

When you use the PXIe VNAs, you can control the M9161D PXI Solid State Dual SP4T Switch Module through the VNA firmware if the M9161Ds are included at launcher.

The switch can be set independently for each channel. The independent settings for sweep segment are not possible. In NF measurement, the switch can be controlled automatically between S Parameter and NF measurement.

Note: (M9485A) Place M9161D at just right after M9376A/7A/8AB, M9341A/B, M9379A modules or between them.. Empty slot or the M9485A unsupported modules (other than M9376A/7A/8AB, M9341A/B, M9379A) is not allowed to locate between M9340A and M9161D.

How to Control RF Amplifier Module

Using **Hardkey/SoftTab/Softkey**

1. Press **Setup** > **Internal Hardware** > **PXI Device...**
2. Click **M9161D Switch Setup..** to control the PXI switch.

Using a mouse

1. Click **Instrument**
2. Select **Setup**
3. Select **Internal Hardware**
4. Select **PXI Device..**
5. Select **M9161D Switch Setup..**

◀ **Programming Commands** ▶

PXI Switch Setup dialog box help

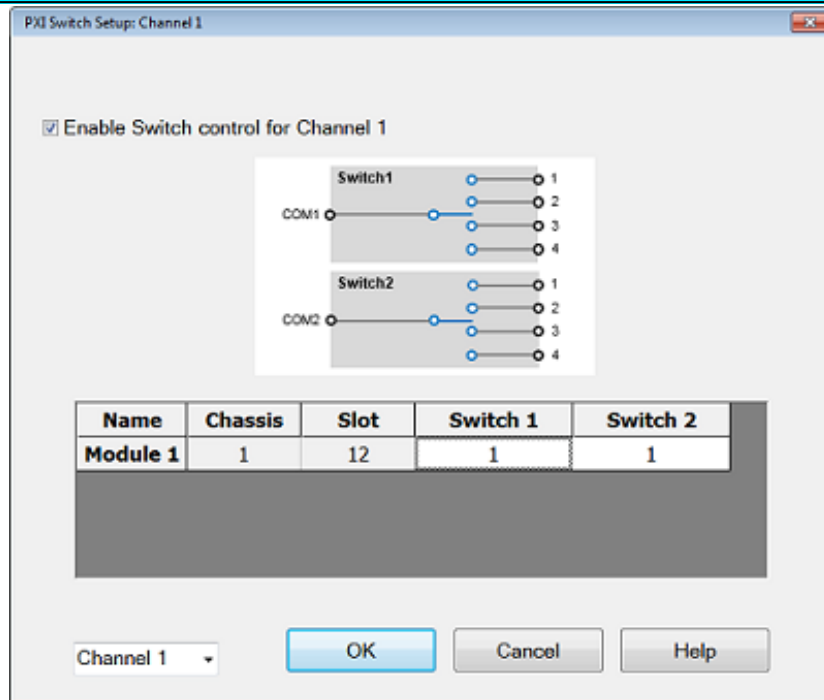

Enable Switch/Path/Atten control for Channel n: The settings are applied for the selected channel. The setting of Switch/Path/Atten is independent for each channel.

Name: Module number.

Chassis: Chassis number where the module is located.

Slot: Slot number where the module is located.

Switch1, Switch2: Path for switch 1. **1, 2, 3** or **4**. When Noise Figure Cold Source is selected as Meas Class, **NF Source**, **NF LO** or **NF Receiver** can be selected.

- **NF Source:** The switch is used as a NF source switch to terminate the DUT input with 50 ohm. VNA port should be connected with port 1 and 50 ohm termination should be connected with port 2. The port 1 is selected during S parameter measurement. The port 2 is selected during NF measurement.
- **NF LO:** The switch is used as Local selection for **dual band NF measurement**. (M9485A Option 720 only)
- **NF Receiver:** The switch is used for pre-amp/thru selection between DUT and VNA port. The port 1 is selected during S parameter measurement. The port 2 is selected during NF measurement.

DUT Control and 8 bit Digital I/O

Note: The P937xA does not support this function.

M9485A/M937xA with M9341B can control the device under test (DUT) directly with serial or parallel digital signals. For example, the signals from the M9341B can be applied to select operation modes of the RF front-end module which integrates power amplifiers, switches, low noise amplifiers, duplexer or filters in a single component. The operation can be synchronized with the sweep of VNA measurement.

Signa from 8-bit I/O can provide up to 4-channels RFFE-like interface with software selectable clock rate (25 MHz maximum).

The following five commands are supported.

- Register 0 Write
- Register Read
- Register Write
- Extended Register Read
- Extended Register Write

See also

- [M9341A/B Module Installation](#)
- [IO Module Front Panel](#)

How to configure DUT control and 8 bit digital I/O

Using **Hardkey/SoftTab/Softkey**

1. Press **Setup** > **Internal Hardware** > **PXI Device...**
2. Click **M9341 IO Control Setup..** to control the M9161Der.

Using a mouse

1. Click **Instrument**
2. Select **Setup**
3. Select **Internal Hardware**
4. Select **PXI Device..**
5. Select **M9341 IO Control Setup..**

Programming Commands

DUT Control dialog box help

This tab is displayed only when the M9341B is installed.

See [IO Module Front Panel](#) for 8 bit I/O port pin assignment and schematic.

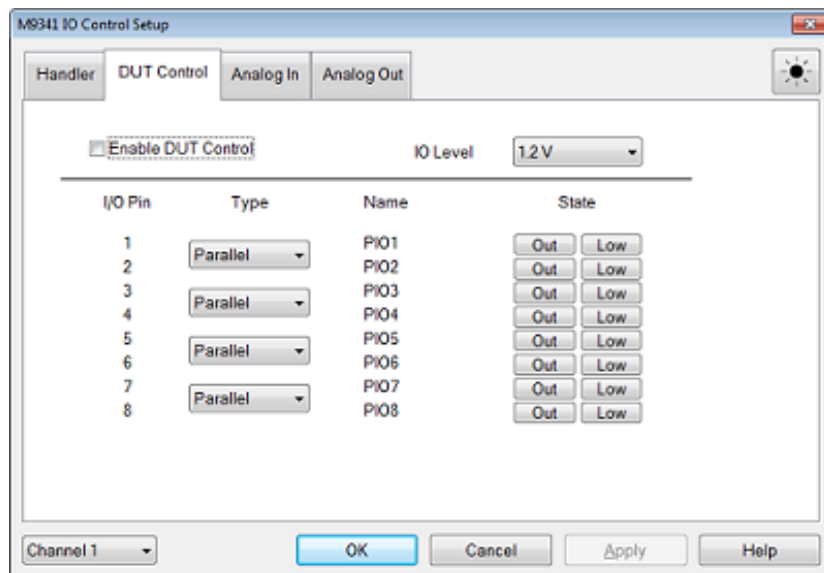

Enable DUT Control The settings are applied for the selected channel. The I/O configuration is independent for each channel.

IO Level Set the voltage level of Vout (ST40X Pin No. 9). This level defines the "HIGH" logic level of all I/O pins. The value range is 0.9 to 3.5 V with 0.05 V resolution.

Type Eight I/O pins are consists of 4 group of 2-pins pair: (Pins No. 1 and 2), (Pins No. 3 and 4), (Pins No. 5 and 6), (Pins No. 7 and 8). Each group can be assigned with Parallel or RFFE

Name: The name of assigned signal.

State

- When Parallel is selected:
 - **In** or **OUT** - Select the pin function from Input or Output.
 - **Low** or **High** - For input pin, show the current state. For output pin, select the level from Low or High
- When RFFE is selected:
 - Clicking **RFFE setup..** shows the RFFE setup dialog box.

RFFE Setup dialog box help

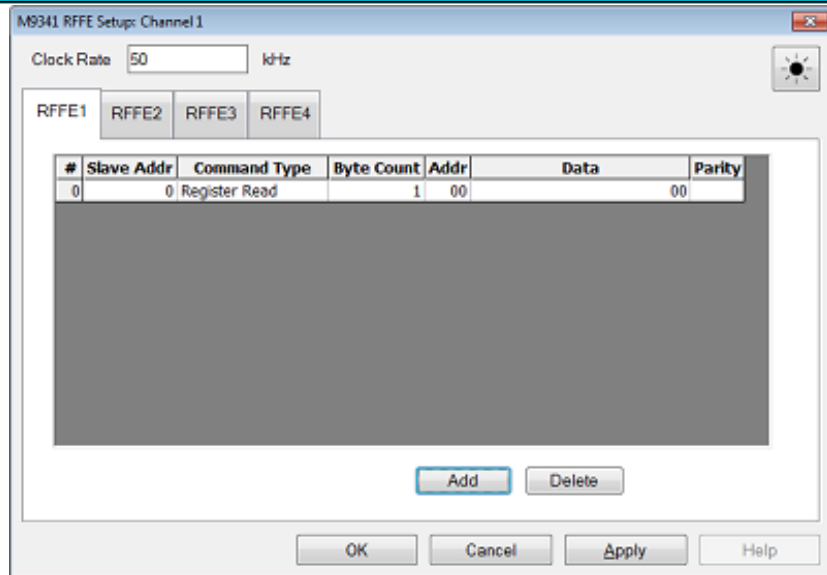

RFFE command sequence number up to 16

Clock Rate Specify the clock rate from 25 kHz to 25 MHz. Possible values are $50000/n$, with integer n , 2000 to 2.

Slave Addr Specify the slave address in decimal. Slave address should be from 0 to 15 (4 bits).

Command Type Select the RFFE command sequence type.

- RREad: Register Read
- RWRite: Register Write
- ERRead: Extended Register Read
- ERWRite : Extended Register Write

Byte Count Specify byte count value in decimal. The value range is depending on command sequence type setting.

Command sequence type	Byte count range
Register 0 Write	1
Register Read	
Register Write	
Extended Register Write	1 to 16
Extended Register Read	

Addr Specify the address value in hex Integer value. The value range is coupled with command sequence type setting.

Command sequence type	Addr range
Register 0 Write	0 (fixed)
Register Read	#h00 to #h1F (0-31)
Register Write	
Extended Register Write	#h00 to #hFF (0-255)
Extended Register Read	

Data Specify or read the data in hex value. Comma separated of data values. The value length is coupled with byte count setting

Parity Show the parity value for each data.

Configure a PXI Internal SMU

Note: The P937xA does not support this function.

PXI VNA application can control an PXI SMU M9111A.

How to Configure a PXI SMU

Using **Hardkey /SoftTab /Softkey**

1. Press **Setup** > **Internal Hardware** > **PXI Devices** > **M9111 SMU Setup...**

Using a mouse

1. Click **Instrument**
2. Select **Setup**
3. Select **Internal Hardware**
4. Select **PXI Devices**
5. Select **M9111 SMU Setup...**

◀ Programming Commands ▶

Output Tab help

The screenshot shows the 'M9111 SMU Setup' dialog box with the 'Output' tab selected. The 'Input' sub-tab is also visible. The 'Voltage Source Mode' is selected, with a range of 6V, bandwidth of LOW, and clamping limits of ±3.06 A. The 'Current Source Mode' is set to 3A with a 6.12 V clamp. Protection settings include 'Source On' status, 'Enable oscillation protection' (checked), and an overvoltage protection level of 14.4 V. Other options include 'Lock output relay closed for all channels' (checked), 'Enable source sequencing' (unchecked), and a setting time of 0 sec. The dialog box also shows 'SMU1 = Slot 12 in Chassis 1' and 'Channel 1' selected, with 'OK', 'Cancel', 'Apply', and 'Help' buttons at the bottom.

Either **Voltage or Current Source Mode** can be selected by toggle switch

Voltage Source Mode Selects voltage priority mode.

- **Range** Selects 6-V or 13-V output range.
- **Bandwidth** Selects one of four source bandwidths. To avoid output oscillation, ringing, overshoots, and poor transient response, refer to the following table for the correct bandwidth setting. The Low setting is the most stable, but has the slowest response. The High settings provide faster response times for the specified load capacitances.

Bandwidth Setting	Sensing	Load Capacitance (C_L)	ESR @100 kHz	Maximum distance from sense point to load capacitance (S_B)
Low	Local or remote	0–150 μ F	50 to 200 m Ω	Full lead length
High1	Remote only	0–1 μ F	50 to 200 m Ω	15 cm
High2	Remote only	1–7 μ F	50 to 200 m Ω	15 cm
High3	Remote only	7–150 μ F	50 to 200 m Ω	15 cm

- **+I Clamp** Sets the positive current limit. When the output source level exceeds this, the trace is clipped.
- **-I Clamp** Sets the negative current limit. When the output source level exceeds this, the trace is clipped.

Current Source Mode Selects current priority mode.

- **Range** Selects 1-mA or 3-A output range .
- **V Clamp** Specifies the voltage limit. When the output source level exceeds this, the trace is clipped.

Protection Status Show the current output status: Source On or Off

Reset Protection Resets a protection trip, after you clear the cause of the trip

Refresh Status Update the latest protection status.

Enable oscillation protection Enables or disables protection against oscillation of the output. This setting is used for all channels.

Overvoltage protection level Specifies the value at which overvoltage protection trips

Lock output relay closed for all channels When this box is checked, the relay in SMU is always closed even output is enabled or disabled. This function avoids its mechanical relay from abrasion. This setting is used for all channels.

Enable Source Sequence :

- Enable: At the beginning of the channel, it will turn on SMU outputs in order from lowest number to highest number, waiting the "Source Settling Time" between each SMU. At the end of the channel, it will turn off SMU outputs in order from highest number to lowest number, waiting the Source Settling time between each SMU.
- Disable: the SMUs will be turned on and off in the same order as described above, but there will be no settling time between the SMUs. However, the "source settling time" will be used to calculate the time to wait at the beginning of sweep after all SMUs are turned On and at the end of sweep after all SMUs are turned Off.
- This is set per-channel and the same for all SMUs.

Settling time :

- When the source voltage or source current is enabled/disabled/changed at the beginning or end of the sweep,
 - The VNA will check to see when it has settled, tThen it will wait the additional time indicated by the "Source Settling Time" before continuing with the measurement.
 - Note that if the source is turned off at the end of the sweep, then the VNA will wait for this settling time before continuing with the next sweep.
- "Settling Time" only affects timing at the beginning and end of the sweep. If the SMU output is changed during a sweep (per point), the "Settling Time" does not affect the settling timing for each point.
- This is set per-channel and the same for all SMUs.

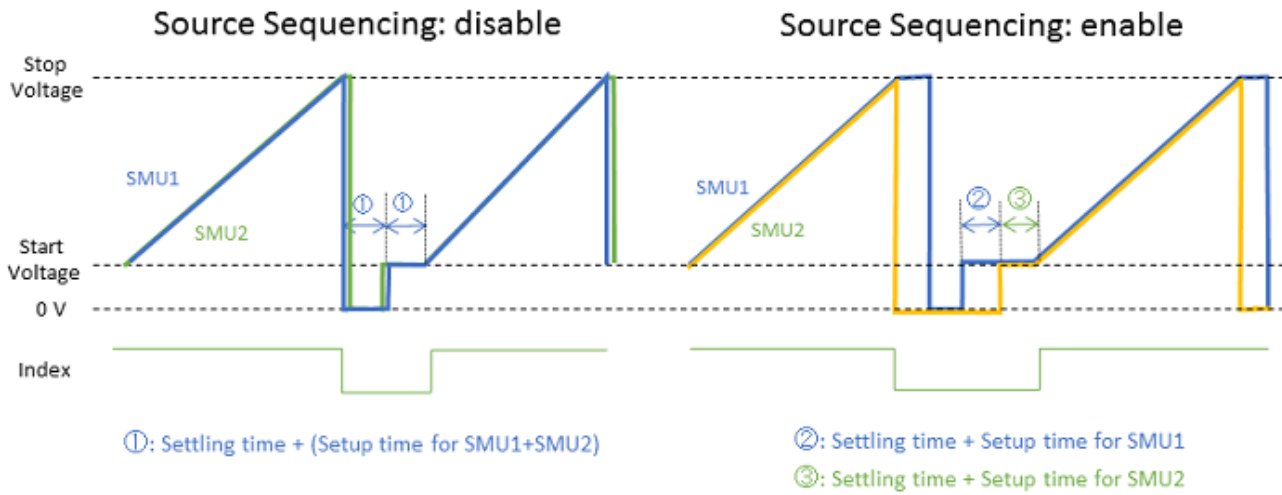

Channel Specifies the target channel to setup.

SMU Specifies the target SMU to setup

Set Output Level Open DC Source Dialog box to specify the output level

Input dialog box help

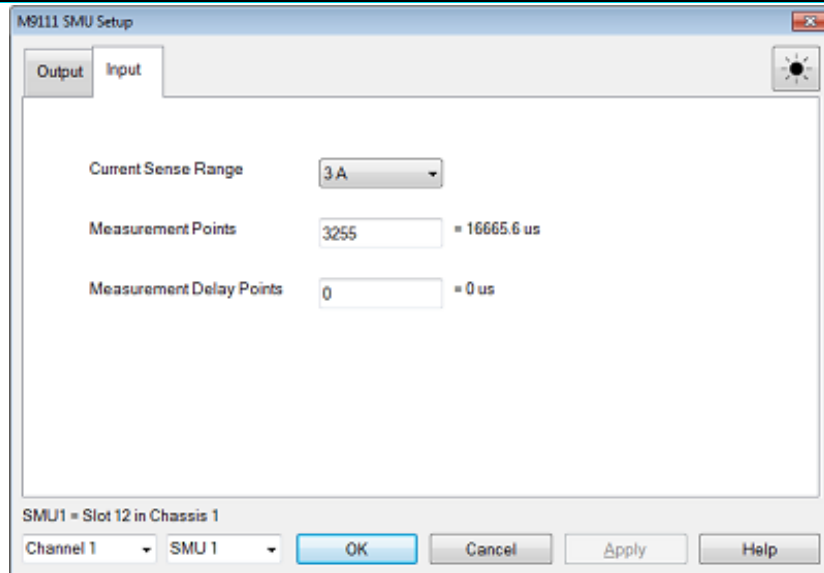

Current Sense Range Selects one of three current sense ranges

Measurement Points Sets the number of points to be measured, from 0 to 100,000

Measurement Delay Points Sets the number of offset points relative to the trigger

Channel Specifies the target channel to setup.

SMU Specifies the target SMU to setup

Configure an External Device

Once configured (as shown in this topic), an external device will appear in, and be controlled from, relevant VNA dialogs as though it were internal to the VNA.

- [External Device Configuration dialog](#)

The following (separate) topics discuss how to set properties for these types of devices:

- [External Source Properties](#)
- [Power Meter As Receiver \(PMAR\) Properties](#)
- [External Pulse Generator Properties](#)
- [Configure a DC Source/Meter](#)
- [Configure a PXI SMU](#) (This is an internal device)

How to access the External Device Configuration dialog

VNA Applications have additional methods of launching this dialog.

Using **Hardkey/SoftTab/Softkey**

1. Press **Setup** > **External Hardware** > **External Device...**

Using a mouse

1. Click **Instrument**
2. Select **Setup**
3. Select **External Hardware**
4. Select **External Device...**

 **Programming Commands**

See [Remotely Specifying a Source Port](#)

External Device Configuration dialog box help

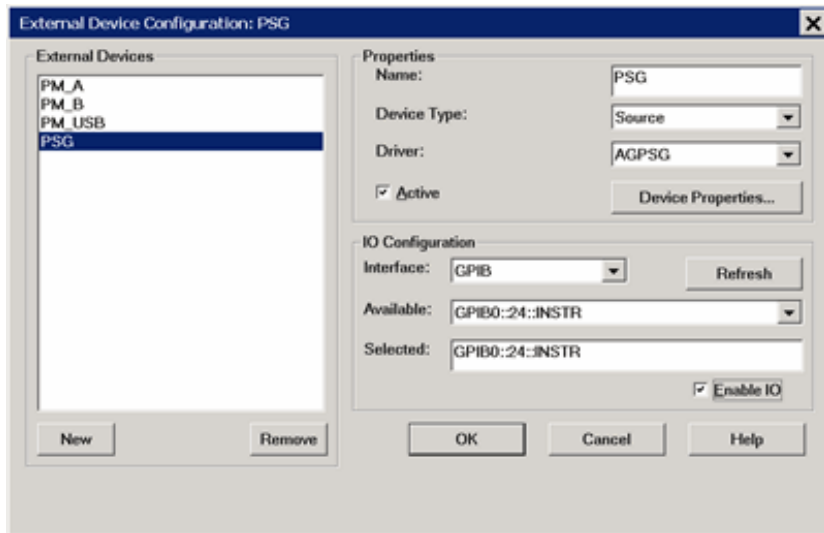

Important Notes

- This dialog is used to configure the following types of external devices:
 - **External Source Properties** requires FOM S9x080A, S9x082A or Option 009
 - **Power Meter As Receiver (PMAR) Properties**
 - **External Pulse Generator Properties**
 - **DC Power Analyzer**
- To configure an external source using this dialog, your VNA must have **FOM Option**. Without this option, you must control an external source manually.
- By default, an external device is **de-activated** when the VNA is Preset or when a Instrument State is recalled. This behavior can be changed with a **Preference setting** so that it remains active through a Preset or Instrument State recall.
- External Device properties are NOT saved in an Instrument State file. However, the reference to the External Device from relevant VNA dialogs IS saved. Therefore, recalling a state file that refers to a device that is NOT present will result in a “Device configuration not found” error.
- Multiple configurations for the same physical device can be Active. However, only one configuration for the same external source can have the **I/O Enabled**.

External Devices

The devices that are currently configured appear in this list. The number of devices that can be configured is limited by the specified Interface.

New Click to create a new device configuration. The default name is Device<n>, where <n> is

the next number for 'Device'.

Remove Click to remove the selected device from the list.

Properties

Name Enter a device name as it will appear when referring to this device in VNA dialog boxes. Edit the name at any time. Duplicate names are not allowed.

- Because External Devices can be used with FOM ranges, do NOT name an external device any of the following FOM range names: "primary", "receivers", or "source", "source1", "source2" and so forth. [Learn more about FOM ranges](#).
- Do NOT use a parameter name such as "S11" or "R1".
- DC Analyzer devices **MUST** use at least three characters in the name.

Device Type Select one of the following:

(Quotes are used when specifying in a remote program.)

- **"DC Source"** - [Learn more](#)
- **"Power Meter" (PMAR)** - [Learn more](#)
- **"Pulse Generator"** - Only the Keysight 81110A Pulse Generator is supported. [Learn more](#)
- **"Source" (RF)** - [Learn more](#)
- **"None"** - returned remotely before setting Device Type.

Driver Select the appropriate model to be configured.

(Quotes are used when specifying in a remote program.)

For **Source** Device Type choose from:

("AG" is short for Agilent.-

- **"AGESG"** (ESG)
- **"AGEXG"** (EXG) [See configuration note](#)
- **"AGPSG"** (PSG)
- **"AG836XX"** (8360 and 8340)

- **"AGMXG"** (MXG) The MXG must have at least firmware A.01.44 for FOM power sweep to work correctly.
- **"AGGeneric"** For sources that are NOT listed but can be controlled using SCPI. Click **Device Properties**, then **Edit Commands** to send commands to these sources. [Learn how.](#)

All other device types have only one driver.

Active Check to make the device available for use in the relevant dialogs. An instrument state that is saved with an Active device (checked) will include the device in the state file. Otherwise, if the Active box is cleared, the device will NOT appear in the state file. [Learn more about Instrument State files.](#)

Enable I/O Clear this box to disable communication with the selected device. Do this to configure a device that is not yet connected to the VNA.

- Communication with devices is attempted when **Enable I/O** is checked, **Active** is checked, and **OK** is pressed.
- When communication is attempted, devices with **Enable I/O** checked are queried for selected limits, such as frequency, power, and number of points. If there are limit problems, the VNA sends an error and the affected channels are put into Hold. These limits are enforced by the dialog box in which they are set. Resolve the reported limit problem and then restore the triggering.
- If communication with a device is lost the affected channels are put into Hold.

Device Properties Click to launch the Properties dialog for relevant Device type:

- [Configure External Sources](#)
- [Configure a Power Meter As Receiver](#)
- [Configure an External Pulse Generator](#)
- [Configure a DC Meter / Source](#)

IO Configuration

Interface Select the interface that is used to connect the device to the VNA. These devices will then appear in the 'Available' field. Choose from:

- **GPIB** - Devices connected to the System Controller GPIB port.
- **USB** - Devices connected to the VNA USB ports.

See Important First-time USB connection note.

- **Aliases** - Devices that are connected to ANY interface for which you created an alias. See [Configure Alias and LAN devices](#).
- **LAN** - Devices connected to a network using a LAN connection. The VNA must also be connected to the network.

Note: Devices connected to LAN must first be configured in Keysight IO libraries before they will appear on the Available list. See [Configure Alias and LAN devices](#).

Available Shows a list of devices that are connected to the specified IO Interface.

Refresh Click to rescan the specified interface for devices.

Selected Enter the IO configuration or select from the available list of IO Interfaces found.

Configure Alias and LAN Devices

Use this procedure to configure a device using a LAN interface. Also use for ANY device for which you want to set an alias (easily-recognized) name. The alias name appears in the Available field when Aliases is selected as the Interface.

1. On the VNA, minimize the VNA application (**System** > **Main** > **Minimize Application**).
2. In the system tray (lower-right corner) right-click the IO icon, then click **Keysight Connection Expert**.

To Add a LAN Device:

1. In **Keysight Connection Expert**, click **Manual Configuration** tab.
2. Select **LAN Instrument**
3. Click, then enter the IP address of the external source.
4. Click **Test This VISA Address** to verify communication.
5. Click **Accept**.

To create an Alias for a connected device:

1. In the list of connected instruments, click the instrument, then click **Add or Change Aliases**.
2. Enter the Alias Name to be used in the [External Device Configuration](#) dialog.

External Source Configuration

Once configured, an external source appears in VNA dialogs as though it were an internal source. This capability requires FOM Option S93080A.

In this topic:

- [How to Configure an External Source](#)
- [Important Notes](#)
- [Trigger Settings and Physical Connection diagrams](#)
- [Generic Source Commands dialog](#)

How to Configure an External Source

1. **Important:** Create an External Source device by name (one-time). [Learn how.](#)(Separate topic)
2. Then click **Device Properties** to [Configure the External Source](#). (This topic)

VNA Applications have additional methods of launching this dialog.

Using **Hardkey/SoftTab/Softkey**

1. Press **Setup** > **External Hardware** > **External Device...**
2. Click **Device Properties** to [Configure the External Source](#).

Using a mouse

1. Click **Instrument**
2. Select **Setup**
3. Select **External Hardware**
4. Select **External Device...**

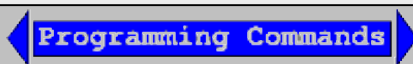

See [Remotely Specifying a Source Port](#)

External Source Configuration dialog box help

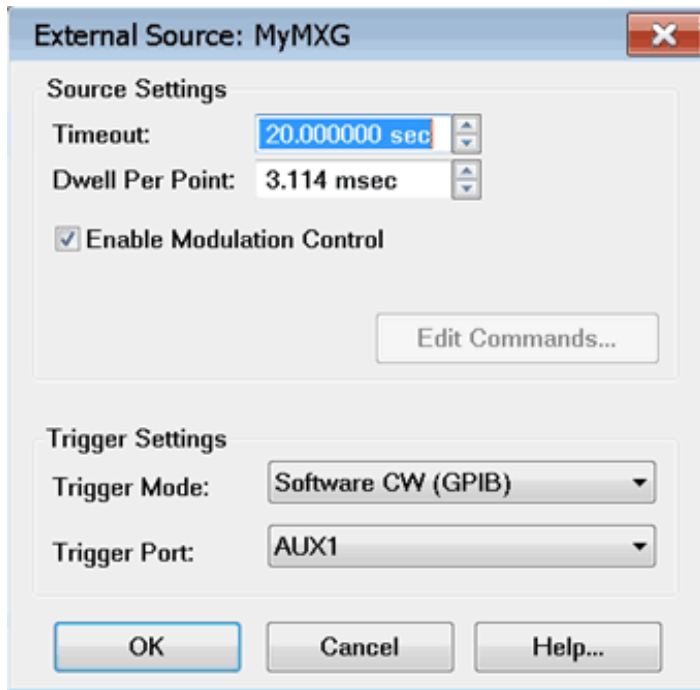

This dialog box is used to make external source settings.

Important Notes about External Sources

- First create an External Source (device) by name (one-time). [Learn how.](#)(Separate topic)
- Once you create and activate an external source from the [Configure an External Device](#) dialog, it becomes available from the following VNA dialog boxes as well as the softkeys and entry toolbar, as if it were an internal VNA source.
Use the following dialogs to set the state, frequency, and power level of the external RF source:
 - [Power and Attenuators dialog](#)
 - [FOM dialog](#)
 - [New Trace / Receivers tab dialog](#)
- By default, an external source is **de-activated** when the VNA is Preset or when a Instrument State is recalled. This behavior can be changed with a [Preference setting](#).
- External Keysight sources are usually limited to 1601 points with List-sweep mode. To 'work around' this limitation, divide the measurement among multiple channels. For example, to attain a sweep of 3200 points, create two channels of 1600 points. You can also use manual source control which supports Step-sweep mode. In this mode an external source can have up to 65,535 points. See [Synchronize an External Source](#) for help with manual source control.

- External sources should always share the same 10 MHz Reference signal as the VNA. Connect a BNC cable from the VNA 10 MHz Ref Output to the External Source Input.
- All newly-activated sources are preset, with source power OFF. Source power must be turned ON in the **Power dialog**. Frequency Offset must be enabled in the **FOM dialog**.
- The same source can NOT be used more than once in the same channel.
- The VNA automatically controls all trigger settings for the external source.
- See **EXG Sources configuration note**.

Source Settings

Timeout (sec) Sets the VISA timeout and will stop processing additional SCPI commands on the first error and will put the measurement into hold.

Dwell per point (ms) Applies a dwell in Hardware List triggering ONLY. Set the time (in milliseconds) the external source will wait before data acquisition.

Enable Modulation Control - Enables modulation of an external modulation source to be controlled from a source dialog.

Edit Commands Provides a method to send SCPI commands to **AGGeneric** (not listed) sources.

Trigger Settings and Physical Connection diagrams

Note: The VNA controls ALL external source trigger settings automatically (except for those on this dialog). All settings in the **External Trigger** dialog are ignored.

Trigger Mode

Software CW (GPIB) Slowest method.

- The external source receives each CW frequency from the VNA over GPIB, USB, or LAN. No other trigger cables are required. Although a Trigger Port selection may be available, it is NOT used.

Hardware List (BNC) Fastest method (not available in M937xA/P937xA).

- NOT available for AGGeneric (not listed) sources.
- The external source receives a list of CW frequencies from the VNA, then receives trigger signals through a rear-panel connector when appropriate from the VNA.

- If the number of data points used in the measurement exceeds the capability of the external source, the VNA automatically switches to Software CW (GPIB) trigger mode. This will slow the measurement significantly.

Trigger Port Used ONLY for Hardware List Trigger Mode. Select the VNA rear panel connector to be used for triggering. The sources must be connected as follows:

- For ONE or TWO external sources, connect each source to an AUX trigger pair. See rear panel Aux connectors.
 - Source Trig Out connects to VNA Aux Trig In
 - Source Trig In connects to VNA Aux Trig Out
- For more than TWO sources, some will need to be connected using the following daisy chain image. For example, with three external sources, two could be daisy-chained to Aux 1 while the third is connected by itself to Aux 2.

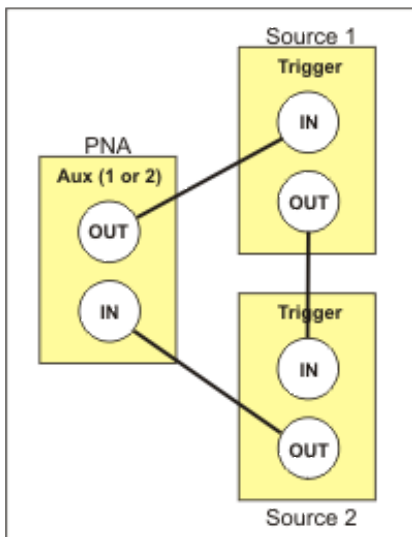

Notes

- Source 1, which receives the trigger out of the VNA, must be the first source listed on the **External Devices Configuration** dialog box. Devices are listed in the order in which they are created. You may have to delete, then re-create a source to move it down on the list.
- Connect **EXG sources** as follows:

- EXG rear-panel label TRIG 1 connects to VNA AUX TRIG 1 OUT
- EXG rear-panel label TRIG 2 connects to VNA AUX TRIG 1 IN

Note: The VNA AUX TRIG 2 can be used instead of VNA AUX TRIG 1.

Generic Source Commands dialog box help

The screenshot shows a dialog box titled "Generic Source Commands" with a close button (X) in the top right corner. The dialog contains the following fields and values:

- Operation complete (*OPC): *OPC
- Preset: *RST
- Set CW Frequency: FREQ:CW
- Set CW Sweep Mode: FREQ:MODE CW
- Set Power: POW
- Set Power State: POW:STAT

At the bottom of the dialog are two buttons: "OK" and "Cancel".

Enter the SCPI commands that control the following functions on your AGGeneric (not listed) source. A field without a SCPI command entered will be ignored and that function will not be set.

To launch this dialog, click **Edit Commands** on the [External Source Properties](#) dialog.

Operation Complete (*OPC) .

Preset Presets the source

Set CW Frequency Sets CW Frequency

Set CW Sweep Mode Sets source sweep mode

Set Power Sets source power

Set Power State Turns power ON or OFF

Configure DC Sources and DC Meters

Once configured, one or more DC Sources and DC Meters can be controlled by the VNA. DC Power Analyzers are also supported, but they must be configured as a separate Source and Meter.

The Keysight **N6700 series** and **B2900 series** DC Analyzers are supported with configuration files that can be loaded on the DC Meter and DC Source property page. Once loaded, the SCPI commands that control the DC device can be modified and saved. [Learn how](#).

NOTE: DC Meter is not supported on PXIe/USB VNAs and E5080.

See Also

[External DC Meter Data Conversion](#)

How to Configure a DC Meter or DC Source

1. **Important:** Create a DC Source / Meter device by name (one-time). [Learn how \(separate topic\)](#).
2. On the Configure an External Device dialog, click **Device Properties**. (This topic).

Using **Hardkey/SoftTab/Softkey**

1. Press **Setup** > **External Hardware** > **External Device...**
2. Click **Device Properties** to **Configure the External Source**.

Using a mouse

1. Click **Instrument**
2. Select **Setup**
3. Select **External Hardware**
4. Select **External Device...**

Once configured, set the DC source voltage and display DC meter measurements:

- **DC Sources:** DC Source control is available in Standard, **Gain Compression**, and **FCA** channels.
 - Set the Start and Stop voltage on the **DC Control dialog**. To access this dialog: Press **Sweep**, then **More**, then **DC Source**.
- **DC Meters (PNA Only):** DC meter measurements are available in Standard, **Gain Compression** /GCX, Swept IMD / IMDX, and **FCA** channels.

- In **Gain Compression /GCX**, Swept IMD / IMDX, and **FCA** channels, display DC parameters as you would an RF parameter, by clicking **Trace/Chan**, then **New Trace**.
- In a Standard channel, configure an unratiod measurement. Press **Meas**, then **More**, then **Receivers**. For Numerator, select the external (or internal) DC meter.
- Change the X-axis to display the DC Meter parameters, click **Response**, then **Display**, then **Labels**, then **Select X-Axis**, then select the DC Meter.

Programming Commands

DC Source / Meter Configuration dialog box help

The DC Source and DC Meter properties are almost identical in how they operate. Both are documented here.

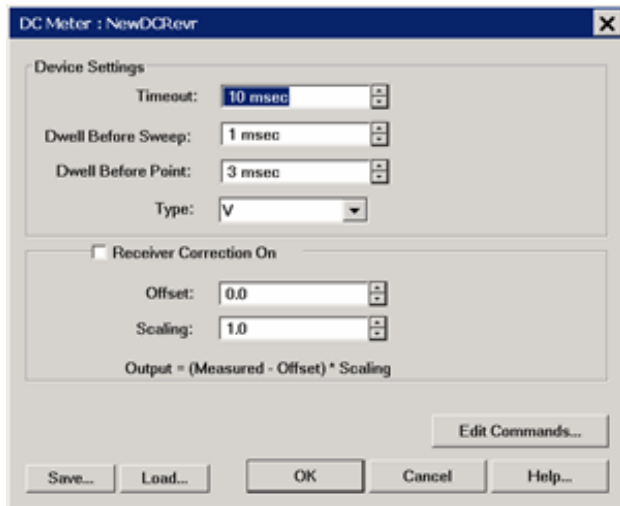

Device Settings

Timeout - Sets a time limit for the DC source or meter to make contact with the VNA. If this time limit is exceeded, the VNA stops the measurement and displays the following error message.

EXECUTION ERROR;OPC QUERY TIMEOUT ERROR

If this occurs, check the connections between your VNA and external device.

Dwell Before Sweep Wait time before making a sweep.

Dwell After Point

- **DC source** Wait time after setting the voltage/current at each data point.

- **DC meter** Wait time before measuring voltage/current at each data point.

Type: This setting changes the units that are displayed in the **DC Source dialog**, the X-axis display annotation, and the **underlying data format**. Use these settings with Receiver or Source Correction (Scaling and Offset) to display and scale measurements with these units. Choose from:

V (volts - default)	dBm	F (degrees)
A (amperes)	W (watts)	C (degrees)
		K (kelvin)

Note: To change the X-axis to display the DC Meter units, click **Response**, then **Display**, then **Labels**, then **Select X-Axis**, then select the DC Meter.

Receiver / Source Correction

- For a **DC source**, use the correction settings to scale and offset the output voltage.
- For a **DC Meter** (receiver), use the correction settings, along with Type, to display and scale measurements with appropriate units. For example:

Measure the voltage across a 5 ohm resistor, then display the results in A(mperes).

Using ohms law, $I = V / 5 \text{ ohms}$ or $I = V * .2$

For receiver correction, enter Scaling = .2; Offset = 0.

ON Check to apply the following correction factors to each measurement.

Offset: Enter the value to offset the DC Meter reading or set the DC Source voltage.

Scaling: Enter the value to scale the DC Meter reading or set the DC Source voltage.

Displayed Output = (Measured / Set value - Offset) * Scaling value.

Edit Commands - Click to start the Edit Commands dialog.

Important Note:

The Edit Commands dialogs (see below) **MUST** be completed. They are used to set the SCPI commands with which the VNA communicates with the DC device.

These commands are saved, along with other configuration settings, to configuration (*.xml) files. These files can then be loaded later when communicating with the same DC Device.

Configuration files for the Keysight N67xx and B29xx Power Analyzers and the other devices are pre-loaded on the VNA. Click **Load**, then navigate to: c:\users\public\network analyzer\documents\drivers.

Save - Press to save the current DC Source or DC Meter configuration to an *.xml file. The list of files is NOT filtered by "DCMeter" or "DCSource", so **use a descriptive filename**.

Load - Press to load an existing configuration.

DC Meter Edit Commands dialog box help

Global Tab

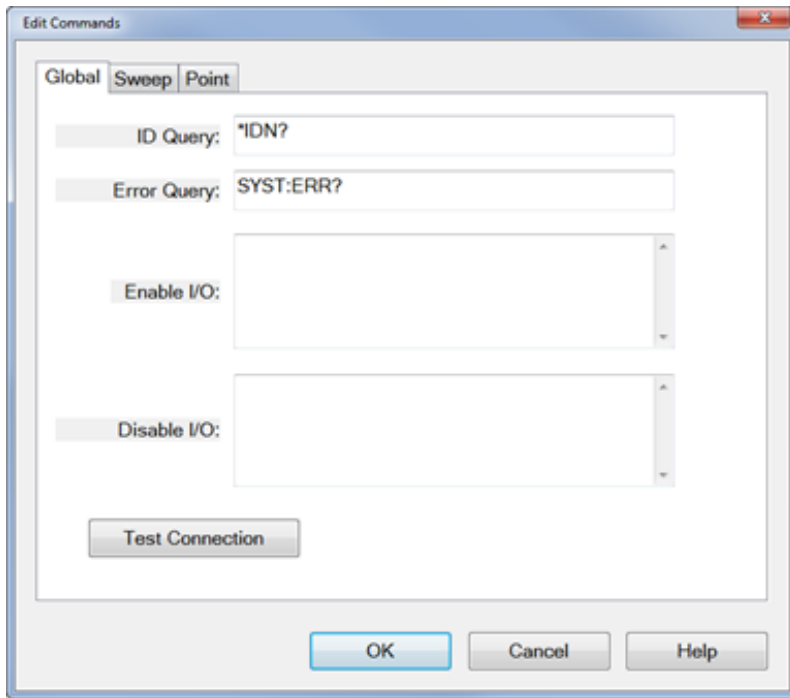

The Global tab includes the system settings for the DC Meter.

ID Query - Enter the SCPI command to return the ID string of the DC Meter. Typically ***IDN?**

Error Query - Enter the SCPI command that is used to return DC Meter errors. Typically **SYST:ERR?**

Enable I/O - Enter the SCPI commands that is used to enable the DC Meter to read voltages.

Disable I/O - Enter the SCPI commands that is used to disable the DC Meter from reading voltages.

Test Connection

Click to start the Test Connection dialog. You must first have entered the I/O Configuration settings and select Enable IO on the [External Device dialog](#).

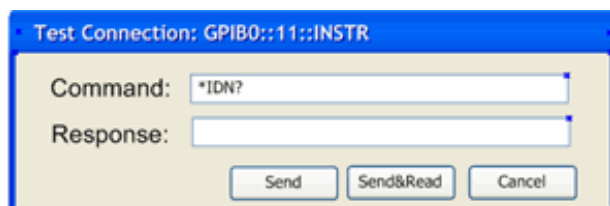

Enter a SCPI command, then click **Send** or **Send&Read** when a return value is expected.

Sweep Tab



Use the Sweep Tab to send SCPI commands to the DC Meter at the beginning or end of each sweep.

Abort Sweep - Enter the SCPI command that is used to Abort or reset the DC Meter. This would be necessary when the VNA sweep is aborted or terminated. The VNA will then send the command to the DC Meter.

Point Tab

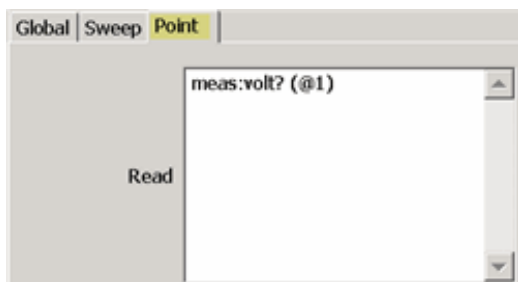

Read (commands) - Enter the SCPI command that is used to make a DC measurement at each data point.

Set (commands) - Use <%variable> to make a DC Meter setting.

DC Source Edit Commands dialog box help

Global Tab

The screenshot shows a software window with a 'Global' tab selected. It contains several input fields and sections:

- ID Query:** *IDN?
- Error Query:** SYST:ERR?
- Enable I/O:** OUTP ON, (@1)
- Disable I/O:** OUTP OFF, (@1)
- Maximum DC Output:**
 - Read Max Using
 - Define Max As: 10.000 V
- Minimum DC Output:**
 - Read Min Using
 - Define Min As: -10.000 V
- Test Connection** button

The Global tab includes the system settings for the DC Source.

ID Query - Enter the SCPI command to return the ID string of the DC Source. Typically ***IDN?**
This entry can be left blank.

Error Query - Enter the SCPI command that is used to return DC Source errors. Typically **SYST:ERR?**

Enable I/O - Enter the SCPI commands that is used to enable the DC Source to output voltages.

Disable I/O - Enter the SCPI commands that is used to disable the DC Source from outputting voltages.

Maximum / Minimum DC Output

Read Max / Min Using - Select, then enter the commands used to return the output limits of the DC source.

Define Max / Min As - If the DC Source has no commands to return these values, or you would rather define the limit for your DC Source, select then enter the Max and Min voltage limits.

Test Connection

Click to start the Test Connection dialog. You must first have entered the I/O Configuration settings and select Enable IO on the **External Device dialog**.

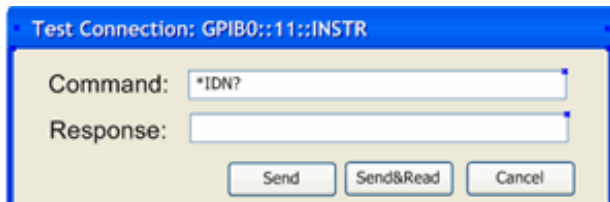

Enter a SCPI command, then click **Send** or **Send&Read** when a return value is expected.

Sweep Tab



Use the Sweep Tab to send SCPI commands to the DC Source at the beginning or end of each sweep.

Typically, you might send the output ON at the beginning of each sweep, and output OFF at the end of each sweep as shown above.

Abort Sweep - Enter the SCPI command that is used to Abort or reset the DC Source. This would be necessary when the VNA sweep is aborted or terminated. The VNA will then send the command to the DC Source.

Point Tab

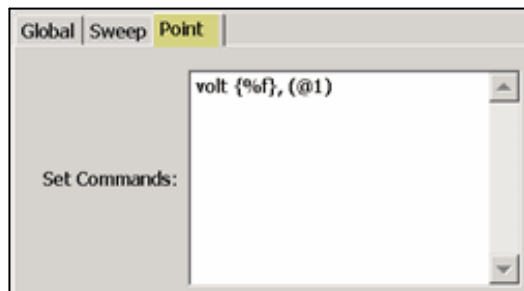

Note: The DC Source output voltages are configured on the **DC Source dialog**.

This dialog is used to configure the commands that are used to communicate with the DC Source.

Set commands - Enter the SCPI command, enclosed in {curly brackets} to output (set) a voltage/current from the DC Source for each data point.

- **{%f}** - The value is a double value. (Most common).
- **{%d}** - The value is a integer. This would be used when the voltage controls a remote switch. For example, you can program the value to: "0,1,0,1,0,1...". where "0" = OFF and "1" = ON.

Configure a Power Meter As Receiver (PMAR)

When a power meter is configured as a VNA receiver (in **standard measurement channels ONLY**), you can...

- Extend the number of measurement receivers.
- Use the power meter as a scalar detector.
- Monitor the power at any point in a measurement system.
- Use multiple power meters in a **Guided Power Cal** to cover a wide frequency range.
- Use the power meter to level the stimulus power at any point in a measurement system.
- Use the power sensor as a PMAR device to confirm the accuracy of a Source Power Cal. [Learn how.](#)

Note: PMAR is not compatible with **Point Sweep** mode.

Once configured, a power meter can be used like any other VNA receiver in the following dialogs:

- **New Trace / Meas dialog** - used in Ratioed and Unratioed measurements.

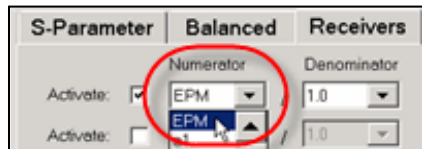

- **Receiver Leveling**
- **Frequency Offset Mode** - Extend frequencies beyond VNA

See Also

- **Supported Power Meters**
- Important first-time USB connection note.

How to Create and Configure a PMAR Device

1. Create a PMAR device by name (one-time).
2. Then click **Device Properties** to **configure the Power Meter/Sensor**.

VNA Applications have additional methods of launching this dialog.

Using **Hardkey/SoftTab/Softkey**

1. Press **Setup** > **External Hardware** > **External Device...**
2. Click **Device Properties** to **configure the Power Meter/Sensor**.

Using a mouse

1. Click **Instrument**
2. Select **Setup**
3. Select **External Hardware**
4. Select **External Device...**

← **Programming Commands** →

External Device Configuration dialog box help

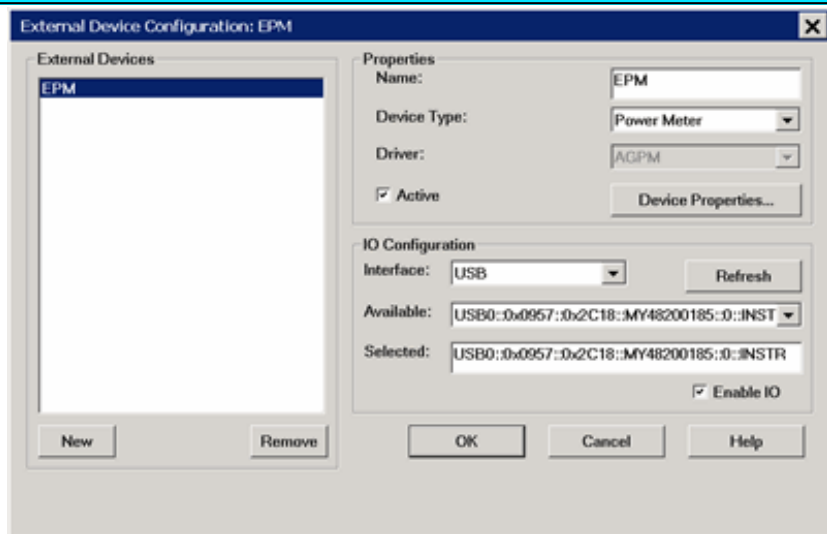

This dialog allows you to create and configure a power meter to be used as a receiver by the VNA. Once you create and configure a power meter from this dialog box, it becomes available from VNA dialog boxes as well as the softkeys and entry toolbar, as if it were an internal VNA receiver.

- This dialog is ALSO used to configure an **External Source**. [Learn more](#).
- To configure a single power meter for a Source Power Cal, use the **Power Meter Settings** dialog.

Important Notes

- By default, an external PMAR device is **de-activated** when the VNA is Preset or when an Instrument State is recalled. This behavior can be changed with a **Preference setting** so that it remains active through a Preset or Instrument State recall.
- PMAR configuration is NOT saved in an Instrument State file. Therefore, recalling a state file that refers to a device that has been removed, or recalling a state file on a different VNA will result in a "Device configuration not found" error.

External Devices

The devices that are currently configured appear in this list. The number of devices that can be configured is limited by the specified Interface.

New Click to create a new PMAR configuration. The default name is Device<n>, where <n> is the next number for 'Device'.

Remove Click to remove the selected device from the list.

Properties

Name Enter a device name as it will appear when referring to this device in all VNA dialog boxes. Edit the name at any time. Duplicate names are not allowed.

Notes

- Because External Devices can be used with FOM ranges, do NOT name an external device any of the following FOM range names: "primary", "receivers", or "source", "source1", source2" and so forth. **Learn more about FOM ranges.**
- Do NOT use a parameter name, such as "S11, or "R1".

Device Type Select **Power Meter**.

Driver Use **AGPM** for all Keysight Power Meters. See **Supported Power Meters**

Active Check to make the device available for use in the FOM, New Trace, and Receiver Leveling dialogs. An instrument state that is saved with an Active device (checked) will include the device in the state file. Otherwise, if the Active box is cleared, the device will NOT appear in the state file.

Note: Multiple PMAR configurations for the same physical device can be Active and Enabled.

Device Properties Click to launch the [Configure Power Sensor](#) dialog.

IO Configuration

Interface Select the interface that is used to connect the device to the VNA. These devices will then appear in the 'Available' field. Choose from:

- **GPIB** - Devices connected to the System Controller GPIB port.
- **USB** - Devices connected to the VNA USB ports. See Important First-time USB connection note.
- **Aliases** - Devices that are connected to ANY interface for which you created an alias. See [Configure Alias and LAN devices](#).
- **LAN** - Devices connected to a network using a LAN connection. The VNA must also be connected to the network. **Note:** Devices connected to LAN must first be configured in Keysight IO libraries before they will appear on the Available list. See [Configure Alias and LAN devices](#).

Available Shows a list of devices that are connected to the specified IO Interface.

Refresh Click to rescan the specified interface for devices.

Selected Enter the IO configuration or select from the available list of IO Interfaces found.

Enable I/O Clear this box to disable communication with the selected device. You would do this to configure a device that is not yet connected to the VNA.

- Communication with devices is attempted when **Enable I/O** is checked, **Active** is checked, and **OK** is pressed.
- If communication with a device is lost, the affected channels are put into Hold.
- When communication is attempted, devices with **Enable I/O** checked are queried for limits for frequency, power, and number of points. If there are limit problems, the VNA sends an error and the affected channels are put into Hold. These limits are enforced by the dialog box in which they are set. Resolve the reported limit problem and then restore the triggering.
- Communication is also attempted when clicking the **Settings** button on the [Configure Power Sensor](#) dialog. You can not change any of the sensor settings unless **Enable I/O** and **Active** are checked and communication is possible with the sensor.

Configure Alias and LAN Devices

Use this procedure to configure a device using a LAN interface. Also use for ANY device for which you want to set an alias (easily-recognized) name. The alias name appears in the Available field

when Aliases is selected as the Interface.

1. On the VNA, minimize the VNA application.
2. In the system tray (lower-right corner) right-click the IO icon, then click **Keysight Connection Expert**

To Add a LAN Device:

1. In **Keysight Connection Expert**, click **Manual Configuration** tab.
2. Select **LAN Instrument**
3. Click, then enter the IP address of the external source.
4. Click **Test This VISA Address** to verify communication.
5. Click **Accept**.

To create an Alias for a connected device:

1. In the list of connected instruments, click the instrument, then click **Add or Change Aliases**.
2. Enter the Alias Name to be used in the **External Device Configuration** dialog.

Power Sensor Configuration dialog box help

Programming Commands



To launch this dialog, with the PMAR device selected in the **External Device Configuration** dialog, click **Device Properties** .

This dialog is used to configure a power meter / sensor for use as a receiver.

To configure a single power meter for a Source Power Cal, use the [Power Meter Settings](#) dialog.

About Power Sensor Calibration

PMAR traces are NOT calibrated using standard VNA calibrations, including response corrections.

PMAR traces are calibrated using methods that are appropriate for the selected sensor. Follow the proper guidelines for zeroing or calibrating the sensors that are in use. Check to ensure that the selected sensor is appropriate for the frequency range and the power level at which PMAR measurements occur.

The VNA does not automatically prompt you to perform a calibration.

To calibrate a power sensor, click **Settings** on this dialog box, then click **Zero/Calibrate Sensor**. [Learn more](#).

Note: By default, a PMAR is de-activated when the VNA is Preset or when a Instrument State is recalled. This behavior can be changed with a [Preference setting](#).

Sensor

For power sensors that are connected to a power meter, select a sensor to configure.

Settings Click to launch the [Power Sensor Settings](#) dialog.

When pressed, communication with the sensor is tested. Sensor settings can NOT occur unless **Enable I/O** is checked on the [External Device Configuration dialog](#), and the sensor is properly connected and configured.

Sensor Settling

Each power meter reading is "settled" when either:

- two consecutive meter readings are within this Tolerance value **or**
- when the Max Number of Readings has been met.

The readings that were taken are averaged together to become the "settled" reading.

Tolerance When consecutive power meter readings are within this value of each other, then the

reading is considered settled.

Max Number of Readings Sets the maximum number of readings the power meter will take to achieve settling.

Sensor Loss Compensation

Use Loss Table Select this checkbox to apply loss data to Source Power calibration correction (such as for an adapter on the power sensor).

Edit Table Invokes the **Power Loss Compensation** dialog box.

Power Meter Uncertainties

Note: This is not supported by M980xA/P50xxA.

Uncertainty... Select this button to set up power meter uncertainties for power uncertainty calibrations. Then, when the **Use uncertainties** option is selected during a guided calibration, uncertainty power values will include the uncertainty of the power meter.

Clicking on the **Uncertainties...** button opens a dialog to either select a specific power meter from a list or load a custom file of power meter uncertainties.

Power Sensor Settings dialog box help

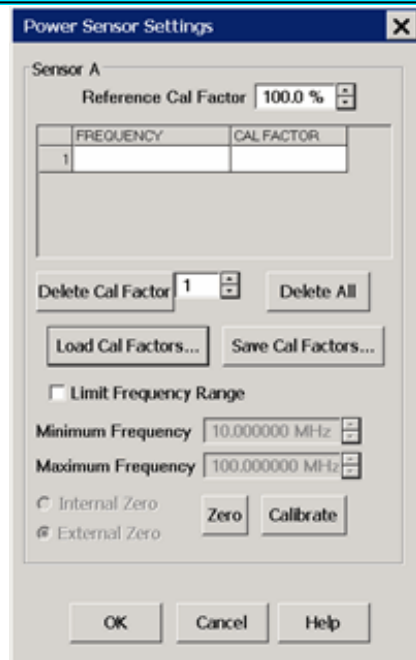

This dialog appears when you click the **Settings** button on the **Configure Power Sensor** dialog.

Note: Be sure that the frequency range of your power sensor covers the frequency range of your measurement. This does NOT occur automatically.

Sensor A (B) Displays one of the following messages depending on type of sensor.

- **Not connected** The VNA is not detecting a power sensor.
- **Sensor Data** Allows the following entries for power sensor data:
 - **Reference Cal Factor** Specifies the Cal Factor for the 50 MHz reference signal.
 - **Cal Factor Table** Specifies the frequency and corresponding Cal Factor for the sensor.
 - **Delete Cal Factor** Deletes the indicated row in the table.
 - **Delete All** Deletes all data in the table.
 - **To Add a Row** to the table, click on a row in the table and press the down arrow on either the VNA front panel or keyboard. A row is added to the bottom of the table. The table is automatically sorted by frequency when OK is pressed.
- **Cal factors are contained within this sensor** Internal Reference Cal Factor and Cal Factor data are loaded automatically and the following dialog appears.



- **Use Internal Cal Factors** This box only appears when internal cal factors have been detected for the sensor and by default will be checked. Clear this box to not use internal cal factors.

Load Cal Factors Click to load cal factors from a *.csv file that you create from the cal factors that appear on the sensor. The first line of the file **MUST** have the reference Cal Factor (typically 100), followed by Freq / Cal Factor pairs as show in the following image:

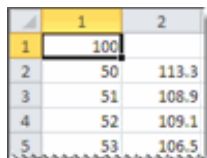

	1	2
1	100	
2	50	113.3
3	51	108.9
4	52	109.1
5	53	106.5

Save Cal Factors Click to save the cal factor table to a *.csv file.

Limit Frequency Range

- Check to limit the use of the power sensor to those within the Minimum and Maximum frequency values.
- Clear to use the power sensor for all measurements. If the measurement frequency is not within the Minimum and Maximum frequency values, the closest min or max correction data is used for the measurement.

Minimum Frequency Specifies the minimum frequency range for the sensor.

Maximum Frequency Specifies the maximum frequency range for the sensor.

Zero and Calibrate the Power Sensor

For highest accuracy, Zero AND Calibrate the power sensor before measuring data. Follow prompts that may appear.

Zero - If the following settings are 'greyed', Internal or External zeroing is selected automatically based on the power meter/sensor model. Otherwise, select the appropriate type of zeroing to perform, then press **Zero**.

- **Internal Zero** - A switch inside the power sensor removes the sensor from the incident power.
- **External Zero** - Requires that you physically remove the sensor from incident power.

Note for the U2000 Series USB power sensors

Calibration is NOT available. Select External Zero ONLY when the power to be measured is **below** the specified level. Otherwise, the U2000 series performs internal zeroing automatically when needed. See your power sensor documentation for more details.

- U200xA - below -30 dBm
- U200xH - below -20 dBm
- U200xB - below 0 dBm

If your U2000 power sensor 'hangs' when external zeroing, upgrade the power sensor firmware to Rev. A.01.02.00 or higher to fix this problem.

Calibrate - Available when the selected sensor has calibration capability. Calibration involves measuring an internal 1 mW source.

- Keysight P-Series sensors have an internal reference so you can calibrate them without connecting to the meter's reference port.
- Keysight U2000 USB power sensors do not require calibrating.
- For other sensors, refer to the documentation to determine if it has calibration capability.

Press **Calibrate**, then follow the prompts.

Power Loss Compensation dialog box help

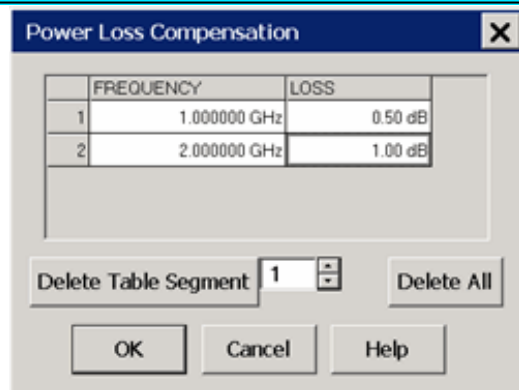

To Add a Row to the table, click on a row in the table and press the down arrow on either the VNA front panel or keyboard.

To Edit a value, double-click in the cell to be edited.

Compensates for losses that occur when using an adapter or coupler to connect the power sensor to the measurement port. These components will be removed when the calibration is complete. To account for components that will remain during the measurement, use the **Power Offset setting**.

The Frequency / Loss pairs define the amount of loss for the entire frequency range. For example, using the entries in the above dialog image:

- 0.5 dB is used to compensate power sensor measurements up to 1 GHz.
- Each data point between 1 GHz to 2 GHz is linearly interpolated between 0.5 dB and 1 dB.
- 1 dB is used above 2 GHz.
- A single frequency/loss segment is applied to the entire frequency range.

Beginning with A.09.80, enter up to **9999** segments to achieve greater accuracy. Previously the limit was 100.

Note: Large segment counts with one or more power sensors can result in long load and close times for the VNA Application.

Frequency Enter a frequency in Hz.

Loss Enter a loss as a POSITIVE value in dB. To compensate for gain, use NEGATIVE values.

Delete Table Segment Deletes row indicated in the field.

Delete All Deletes all data in the table.

The Power Loss Compensation table survives VNA Preset and Power OFF. To NOT use Loss compensation, clear the Use Loss table checkbox on the **Configure Power Sensor** dialog.

Use a PMAR Device to confirm a Source Power Cal

[Learn how to create and configure PMAR device.](#)

After a Source Power Cal has been performed, use the same sensor as a configured PMAR to analyze the accuracy of the Calibration.

1. Create a PMAR device with the power sensor that will be used for the Source Power Cal.
 2. Perform a Source Power Cal. [Learn how](#).
 3. Create an unratiod measurement with the PMAR device. [Learn how](#).
 4. With the power sensor still connected to the test port, monitor the corrected source power using [Min and Max markers](#) or the [Trace Statistics peak-to-peak](#) feature.
-

Configure and Use External Pulse Generators

Once configured, one or more 81110A External Pulse Generators can be accessed from the VNA [Integrated Pulse Application](#). The external pulse generators can be used without Opt. S93025A/B (internal pulse generators). However, the Integrated Pulse App is available ONLY with Opt. S9x025A/B.

Only the 81110A Keysight Pulse Generator is supported.

In this topic:

- [How to Configure an External Pulse Generator](#)
- [Pulse Generator Configuration dialog box help](#)
- [Using External Pulse Generators with the Integrated Pulse App](#)

See Also

[Integrated Pulse Application](#)

[81110A Quick Start Guide](#).

How to Configure an External Pulse Generator

1. **Important:** Create an External Pulse Generator device by name (one-time). [Learn how \(separate topic\)](#).
2. On the [Configure an External Device dialog](#), click **Device Properties** (this topic).
3. Setup the external pulse generator in the [Integrated Pulse Application](#).

Using [Hardkey/SoftTab/Softkey](#)

1. Press **Setup** > **External Hardware** > **External Device...**

Using a mouse

1. Click **Instrument**
2. Select **Setup**
3. Select **External Hardware**
4. Select **External Device...**

[Programming Commands](#)

Tip: In the [External Device Configuration dialog](#), you can configure the same 81110A twice; once for each output module. For example:

- Name = "81110A-1" Output = **Out1**
- Name = "81110A-2" Output = **Out2**

Pulse Generator Configuration dialog box help

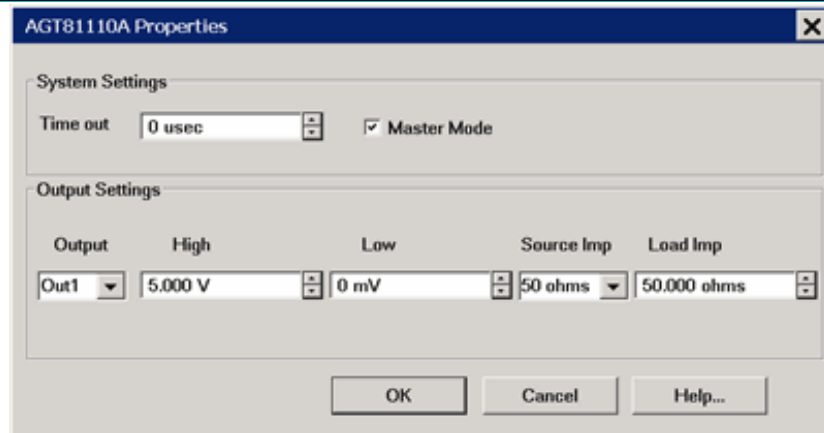

System Settings

Time out - Set the amount of time allowed to communicate with the external pulse generator. If communication has not been established before this amount of time has elapsed, a Timeout message will appear. Check connection settings on the [External Device dialog](#).

Master Mode - When checked, the 81110A trigger mode is set to Internal. This also causes the 81110A to appear as a selection on Integrated Pulse App, [Master Pulse Trigger](#) setting. When selected here and on that dialog, the timing of configured 'slave' pulse generators is controlled by the 81110A pulse generator. Although more than one configured pulse generator can have the Master Mode setting checked, only one pulse generator can be connected to the rear-panel Pulse connections. [Learn more about making physical connections](#).

When this setting is cleared, the 81110A trigger mode is set to External and can be configured as a 'slave' pulse generator to the VNA internal pulse generators or another external pulse generator.

Output Settings

The following are 81110A settings made by the VNA. Some settings may not be possible depending on the modules that are installed on the 81110A. Please refer to the [81110A Quick Start Guide](#) for more information.

Output - Select an output on the 81110A.

High/Low - Set the pulse voltage levels at the 81110A output.

Src Imp (Source Impedance) - Source impedance of the pulse generator output.

Load Imp (Load Impedance) - The load impedance value expected at the pulse generator output.

Using External Pulse Generators with the Integrated Pulse App

Once configured, an external pulse generator can be used with the Integrated Pulse App as though it were an internal pulse generator.

External Pulse Generators can be used for ONE OR MORE of the following pulsed functions within the Integrated Pulse Application.

- **Modulate the sources**
- **Trigger the ADC** to make receiver measurements (Wideband mode ONLY).

How to Modulate a Source with an External Pulse Generator

When using **internal** source modulators, the external pulse generator can drive the internal modulators in two ways:

- 81110A drives internal pulse generators, which drives the internal modulator.
 - **Connect:** 81110A to **Pulse Sync IN**, on **RPHandler I/O Connector (M9485A)**, **I/O Adapter (M98xxA/P50xxA)**
 - **Settings:**
 - On the Pulse Generator Configuration dialog (above) check **Master mode**.
 - On the **Pulse Setup** dialog, set **Master Pulse Trigger** to <ext pulse gen name> .

How to trigger the ADC with an External Pulse Generator

(Used ONLY in Wideband mode).

Pulse0 may be used to trigger the ADC. The following shows how P0 may be driven by an external

pulse generator.

- **Connect:** 81110A to **Pulse Sync IN**, on **RPHandler I/O Connector (M9485A)**, **I/O Adapter (M98xxA/P50xxA)**
 - **Settings:**
 - On the Pulse Generator Configuration dialog (above) check **Master mode**.
 - On the **Pulse Setup** dialog, set **Pulse Trigger Source** to <ext pulse gen name>.
 - On the **Pulse Setup** dialog, under **Measurement Timing**, for the receivers to be triggered, set Pulse Gen to **Pulse Trigger**. Set Delay for the Receivers.
-

Synchronize VNA/PNA-X with an External Source(s)

The VNA External Source Control feature can be used to automatically control external sources. However, this feature requires certain VNA options. [Learn more.](#)

Many VNA measurements require the use of at least two sources. If your VNA has only one internal source, an external source is required. For example, when measuring the insertion loss of a mixer, the LO must be swept at the same time as the RF input. This requires the VNA and external source to be synchronized.

The following procedure shows how to automatically synchronize the VNA/PNA-X with an Keysight external sources.

Hardware configuration

- Connect the VNA and External Source(s) Time Base (VNA/PNA-X 10 MHz OUT to External Source 10 MHz IN)

Connect the AUX Trigger I/O connectors as follows (for two sources):

- VNA/PNA-X AUX Trig-1 IN to External Source-1 Trigger OUT
- VNA/PNA-X AUX Trig-1 OUT to External Source-1 Trigger IN
- VNA/PNA-X AUX Trig-2 IN to External Source-2 Trigger OUT
- VNA/PNA-X AUX Trig-2 OUT to External Source-2 Trigger IN

[Learn more about the AUX Trigger capabilities.](#)

VNA/PNA-X Settings

- Refer to [External Source Configuration](#)

What is Happening?

The following is a flow diagram showing the handshake / synchronization process between the VNA/PNA-X and an External Source.

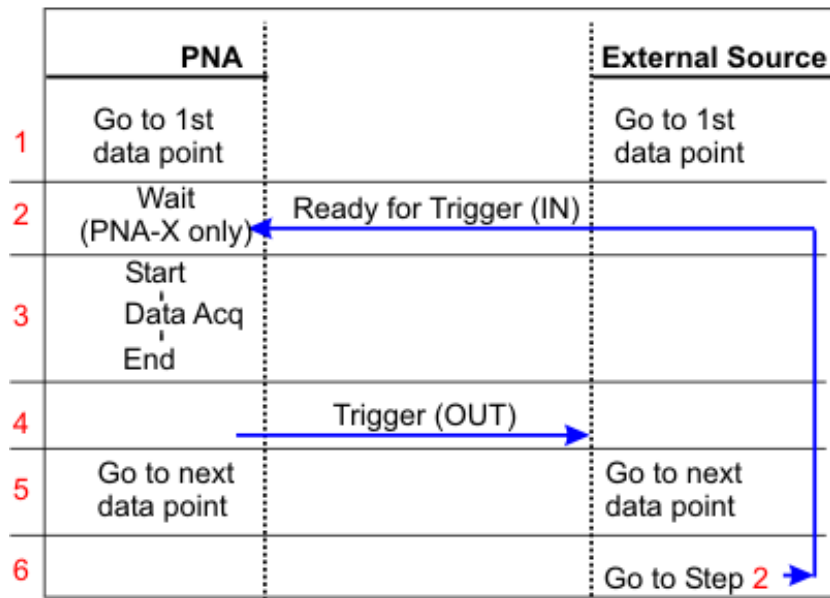

Text Description

1. VNA/PNA-X loads frequency points and source power information onto the external source(s).
2. A trigger signal from the source starts the first data point of the measurement.
3. VNA/PNA-X data acquisition (measurement) starts, and then stops AFTER the first data point acquisition.
4. The VNA/PNA-X sends a trigger signal out to the source telling it to move to the next frequency data point.
5. The external source and VNA/PNA-X move to the next data point. The source usually takes longer than the VNA.
6. The source sends the Ready for Trigger signal to the VNA/PNA-X for next data acquisition.
7. Back to step 4 until last data point.

Direct Receiver Access Configuration

You can make a Direct Receiver Access (DRA) Configuration when you use three ports of M980xA/P50xxA in order to make a better dynamic range and high power measurements. A sets of three physical ports are assigned as Source, Reference and Test ports, then they can be worked as one logical port.

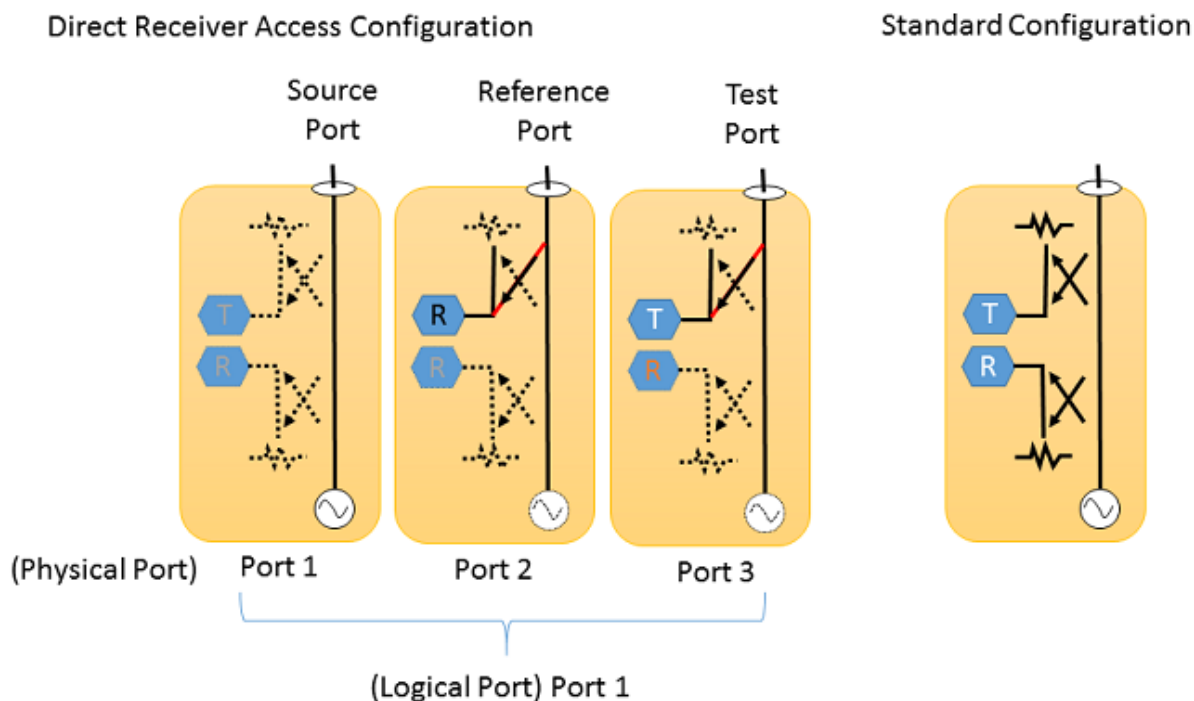

Note: Only the first instance can be assigned as a DRA configuration.

How to make DRA configuration

Use one of the following methods to make a DRA logical ports

Using **Hardkey** /**SoftTab** /**Softkey**

1. Press **Macro** > **Macro1** > **Port Config**

Using a mouse

1. Click **Utility** > **Macro** > **Port Config [portconfigura...]**

Note: When the macro button is not available, execute “C:\\Program Files\\Keysight\\Network Analyzer\\Service\\PortConfiguration.exe”

Port Configuration dialog box help

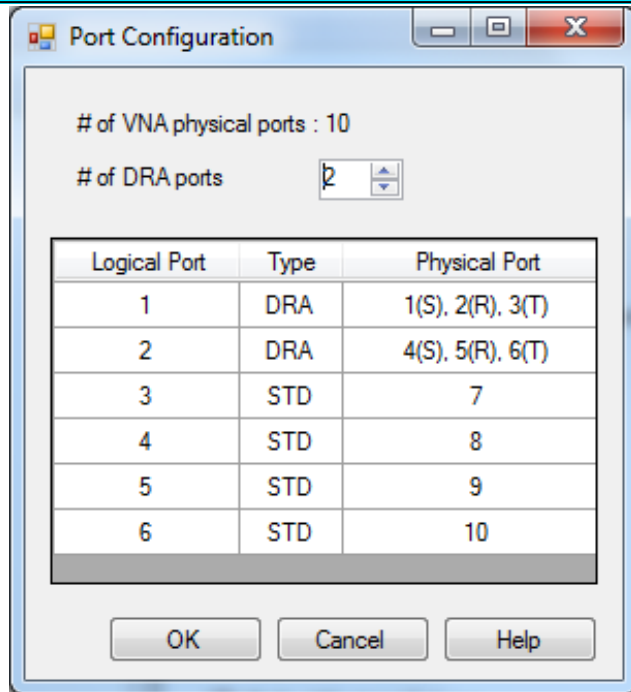

of VNA physical ports : the number of the detected physical port in your system

of DRA ports: The number of DRA ports you require. (# of VNA physical ports) should be greater than or equal to (# of DRA ports) * 3.

The table shows the logical port assignment. The DRA ports are assigned from the physical port 1. Hence, the STD ports come after DRA ports.

In the case above, the physical ports from 1 to 3 are assigned source (S), reference (R), and test (T), respectively, then make them logical port 1.

Display Colors

You can modify the colors that are used to draw various elements on the VNA screen and on a hardcopy print of the display.

See Also

[Print Preview](#)

How to modify DISPLAY Colors

These settings can also be accessed from the [Preferences dialog box](#).

Using [Hardkey](#)/[SoftTab](#)/[Softkey](#)

1. Press [System](#) > [System Setup](#) > [Preferences...](#) > [Colors...](#)
2. Click [Display Colors...](#) in the Customize Display dialog box.

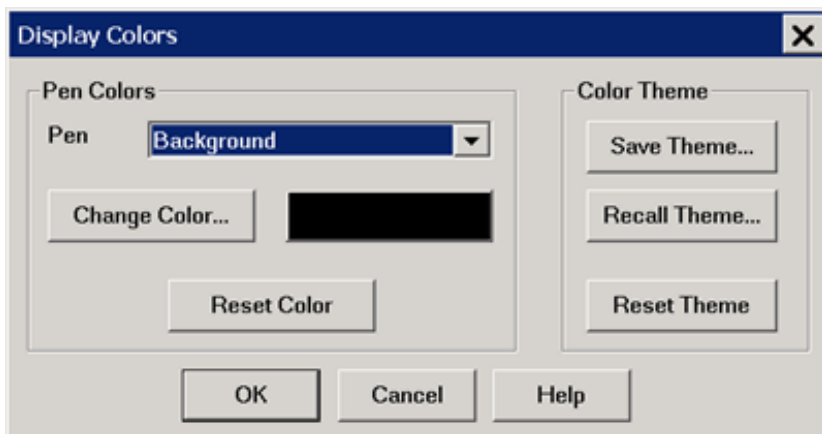

How to modify PRINT Colors

1. Press [System](#) > [System Setup](#) > [Preferences...](#) > [Colors...](#)
2. Click [Print Colors...](#) in the Customize Display dialog box.

[Programming Commands](#)

Display and Print Colors dialog box help

The Display Colors and Print Colors dialog boxes function in exactly the same manner. See [Print Preview](#) procedure below.

Pen

"Pen" is a term used to describe the various elements. Each pen can have a unique color.

You can change the color of the following pens:

- Background - The background color of the inactive windows.
- **New** Active Background - The background color of the active window.
- Grid - The inner lines of all grids in all windows, and the grid frame in inactive windows.
- Active Labels, Grid Frame - The labels and grid frame colors in the active window. **Note:** when this pen is selected, the current window becomes inactive. Therefore, changes for this pen color will not be visible until **OK** is pressed.
- Inactive Window Labels
- Failed Trace - **Limit Line** failed traces or failure indicators (dots) and the word Fail.
- The following pens for up to 8 Traces:
 - Data and Limits
 - Memory trace
 - Markers
 - Memory markers

About Trace Pens

'1st Trace' is NOT always Trace1 (**Tr1**). For example, the first trace in a window might be **Tr2** which is drawn with the "1st Trace" pen.

The first 8 traces are drawn with the defined pen colors. The next eight traces reuse the same colors, and so forth. For example, if all traces are numbered sequentially, the 9th and 17th traces are drawn using the same color as the 1st trace.

Change Color Click the button or the color swatch to launch the **Change Color** dialog.

Reset Color Restores the default color for the selected pen.

Color Themes

A theme is a complete set of pens and their colors. The current theme persists until you change it. Themes can also be saved to a file and then later recalled.

- **Save Theme** Click to save the current set of pens to a file.
- **Recall Theme** Click to recall and use a saved theme.
- **Reset Theme** Click to recall the default VNA color theme.

The colors for the following Display elements can NOT be changed: toolbars, softkeys, menus, dialogs and popup messages.

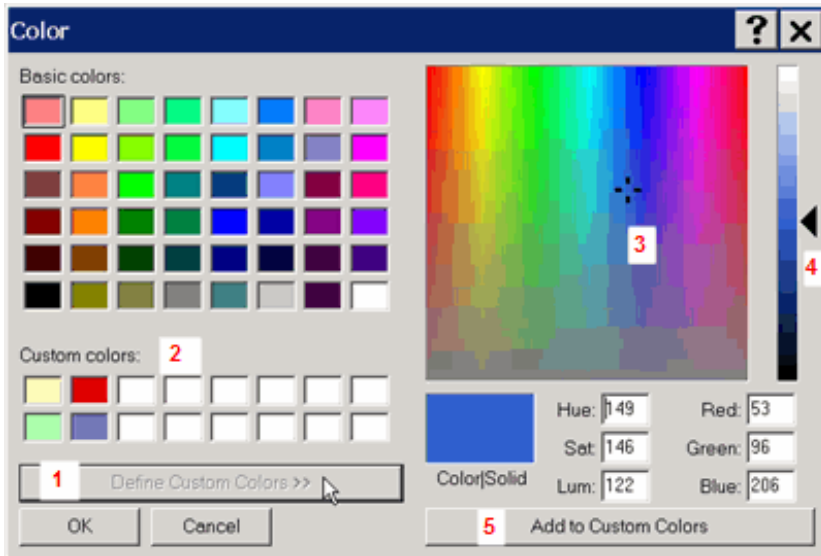

Change Color dialog box help

To use a basic color, click the color from the 'Basic colors' palette, then click **OK**.

To define and use a custom color:

1. Click **Define Custom Colors>>** to open the right side of the dialog.
2. Optionally, pick a Custom color slot to replace. Otherwise, the replacement will occur at the first slot location and continue with subsequent custom color definitions.
3. Click the color pane, or drag the crosshairs, to the location of the custom color.
4. Drag the arrow to the desired saturation level of the custom color.
5. Click **Add to Custom Colors**
6. Continue to define more colors, or click **OK** to close the Color dialog.

After a custom color has been assigned to a VNA pen, the custom color can be changed. The VNA pen color remains unchanged.

Print Preview Procedure

Use the following procedure to preview your Print Colors on the VNA screen:

1. From the Print Colors dialog, select **Reset Theme** then **Save Theme**. Name the new theme "MyPrintTheme.colors". This will give you a starting point equal to the default print colors.
 2. Launch the Display Colors dialog, select **Recall Theme**, then select "MyPrintTheme.colors". The display will now show the default print theme.
 3. Customize the display colors. You will be previewing how the hardcopy will appear when printed.
 4. Save the customized display colors to "MyPrintTheme.colors".
 5. Go to the Print Colors dialog and Recall "MyPrintTheme.colors".
-

Mechanical Devices

- [Overview](#)
- [How to access Mechanical Devices settings](#)
- [Mechanical Devices dialog](#)

Other System Configuration Topics

Overview

Note: To prevent premature wear, the VNA does not allow attenuators or other mechanical switches to switch continuously.

These mechanical devices are set for the entire channel. When more than one channel is used, and a mechanical device setting is NOT the same for all channels, only the ACTIVE channel is allowed to sweep. All other channels are **Blocked** - NOT allowed to sweep. Blocked channels will resume sweeping when they are made ACTIVE, or when the conflict is resolved.

Press **Trigger** > **Main** > **Restart** to cause ALL channels to sweep once. Then the active channel will resume sweeping continuously.

The Mechanical Devices dialog shows the settings of all of the switches and attenuators in the VNA. The settings for all active channels are shown side-by-side for easy comparison. This dialog allows you to determine the settings which would cause mechanical devices to switch between states on consecutive sweeps, potentially leading to device wear-out. It also allows you to determine if the conflict can be resolved to enable continuous sweeps on all channels.

The following are the mechanical devices that are potentially shown in the dialog. These components may not appear in your VNA model:

- Port 1 through Port 4 Bypass Switches
- Port 1 through Port 4 Source Attenuator settings
- Receiver A through Receiver R Attenuator settings
- Port 1 Noise Tuner Switch and Port 2 Noise Receiver Switch

How to access Mechanical Devices settings

Using **Hardkey/SoftTab/Softkey**

1. Press **Setup** > **Internal Hardware** > **Mechanical Devices...**

Using a mouse

1. Click **Instrument**
2. Select **Setup**
3. Select **Internal Hardware**
4. Select **Mechanical Devices...**

Remote commands

SCPI: **SENSe<num>:SWEep:BLOCKed?**

COM: IsBlocked Property

Mechanical Devices dialog box help

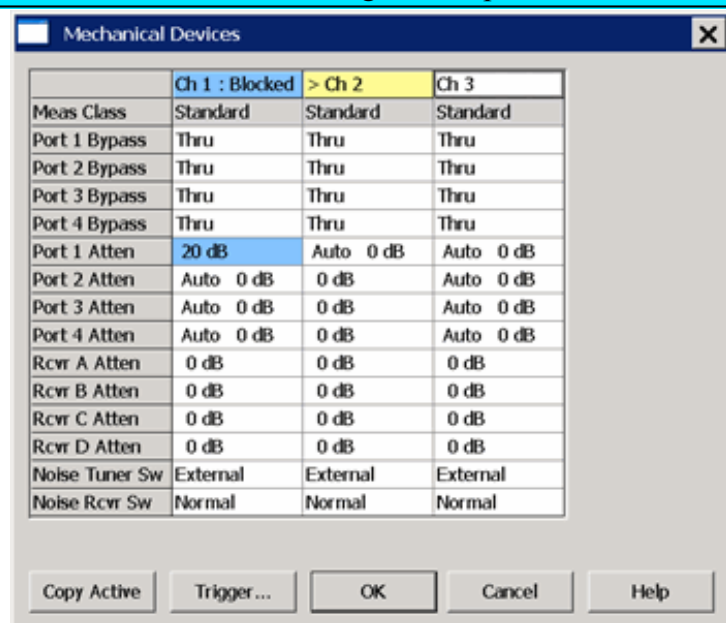

See [Mechanical Devices Overview](#) (scroll up)

The devices that appear in the table depend on the VNA model and options.

> **Yellow** highlighted cell indicates the Active channel.

Blue highlighted cells indicate the following:

- The channel is NOT able to sweep. **Blocked** is shown in the top row.

- The highlighted device settings differ from that of the sweeping channels.

To modify entries in the table, click a cell.

When a selection is changed, the new setting is applied immediately.

If **Port Power is coupled**, a dialog prompts if coupling should be turned OFF.

Limitations

- **Measurement Class** can NOT be changed from this dialog.
- The dialog does NOT report device settings for multiport test sets.
- This dialog does NOT report device settings for **external sources**.

Copy Active Available ONLY when there is a conflict which causes at least one channel to be Blocked. When clicked, the mechanical device settings of the **Active** channel are copied to the Blocked channels. A warning message appears to remind you that power to one or more channels may be increased. **Exception:** When one or more Noise channels are present, then the settings of the two Noise switches are determined by the lowest-numbered Noise channel if none are the active channel.

Trigger Launches the Trigger dialog box.

OK Closes the dialog box.

Cancel Does not apply changes that were made, and closes the dialog box.

Power Limit and Power Offset

- [Overview](#)
- [How to access Power Limit and Power Offset settings](#)

Other System Topics

Overview

Power Limit (Global scope)

Global power limit sets a maximum source power level for individual test ports. This value limits port power for all channels and all applications. Power levels that attempt to exceed the power limit is clipped at the limit.

Notes

- The power limit can NOT be set for power levels which are below the power level that is required by the analyzer to achieve phase lock - approximately -30 dBm.
- Because **Fast Sweep mode** allows power spiking, it is NOT allowed when a power limit is enabled.
- Components that are added to the RF path are accounted for by entering their loss (negative) or gain (positive) in the **Power Offset** section of the dialog box.
- Power limiting does NOT clip power spikes that may occur during **frequency band crossings**.

Power Offset (Channel scope)

Power Offset provides a method of compensating port power for added attenuation or amplification in the source path. The result is that power at the specified port, all dialogs, and annotation, reflects the added components.

How to access the Offsets and Limits settings

Also accessed through the [Preferences](#) dialog.

Using [Hardkey](#)/[SoftTab](#)/[Softkey](#)

1. Press **Power** > **Leveling & Offsets** > **Offsets and Limits...**

Using a mouse

1. Click **Stimulus**
2. Select **Power**
3. Select **Offsets and Limits...**

◀ **Programming Commands** ▶

Offsets and Limits dialog box help

	Power Limit		Power Offset: Channel 1			
	State	Limit	Source Power	Power Offset	Port Power	Source Cal
Port 1	On	0.00 dBm	-15.00 dBm	3.00 dB	-12.00 dBm	Off
Port 2	Off	100.00 dBm	-15.00 dBm	0.00 dB	-15.00 dBm	Off
Port 3	Off	100.00 dBm	-15.00 dBm	0.00 dB	-15.00 dBm	Off
Port 4	Off	100.00 dBm	-15.00 dBm	0.00 dB	-15.00 dBm	Off
Port 1 Src2	Off	100.00 dBm	-15.00 dBm	0.00 dB	-15.00 dBm	Off

Click a **WHITE** cell to change values. **Shaded cells** can **NOT** be changed.

[Remote commands](#) can be sent to lock and unlock the dialog box (UI) settings.

Power Limit

Limits the source power at each test port for ALL channels. Use this feature to protect DUTs that are sensitive to overpowering at the input. Power levels that exceed the limit at the specified port are clipped at the limit and an error message is displayed on the screen.

The Power Limit settings survive [Instrument Preset](#). When an Instrument State is [recalled](#), the current Power Limit settings are applied to the recalled state.

To learn more, see [Power Limit Overview](#) (scroll up).

State / Limit

- **ON** - Power is limited to the adjacent value at the specified source port.
- **OFF** - Power is NOT limited to this value, but to the maximum power of the source.

Power Offset

Power Offset provides a method of compensating port power for added attenuation or amplification in the source path. The result is that power at the specified port, all dialogs, and annotation reflects the added components.

- For amplification, use positive offset.
- For attenuation, use negative offset.

Optionally change the Source Power or Port Power values so that the following equation reflects your requirement:

$$\text{Source Power} + \text{Power Offset} = \text{Port Power}$$

Source Cal ON / OFF

Notes

- Power Offset can be used with **Power Sweeps**. When a power sweep is enabled, the Start and Stop power levels are reported in this dialog.
- When port power offsets are used, port powers are automatically **uncoupled**. Port powers may not be coupled again until all port offsets are zero.
- Cal All does not automatically use the specified power offset during a calibration. To use a power offset for one or more ports when performing a Cal All, you must set the power offset value in the Cal All wizard.

OK Closes the dialog box.

Receiver Temperature

This feature allows you to read the current temperature on the receiver microcircuit.

- To read temperature, press **System** > **Service** > **Diagnostics** > **Receiver Temperature...**
 - The temperature reading is updated with every sweep.
 - Temperature is available in Celsius and Fahrenheit.
 - Temperature can also be read using remote commands.
 - SCPI: **SENSe:TEMPerature?**
-

Source Power Alignment

This function is available on M980xA and P50xxA.

The Source Power Alignment is a tool to improve the power level linearity. The M980xA and P50xxA has a source step attenuator (5 dB step from 0 dB to 70 dB attenuation) for the power output level control. The power linearity may become worse at the point where the step attenuator setting is changed although it is within the specification. After executing this source power alignment, the linearity will be improved.

How to execute the source power alignment

Use one of the following methods

Using **Hardkey/SoftTab/Softkey**

1. Press **Macro** > **Macro1** > **Src Power Alignment**

Using a mouse

1. Click **Utility** > **Macro** > **Src Power Alignment [sourcepoweral...]**

Note: **System** > **System Setup** > **Remote Control** > Hislip must be enabled before the execution.

Note: When the macro button is not available, execute “C:\\Program Files\\Keysight\\Network Analyzer\\Service\\sourcepoweralignment.exe”

Source Power Alignment dialog box help

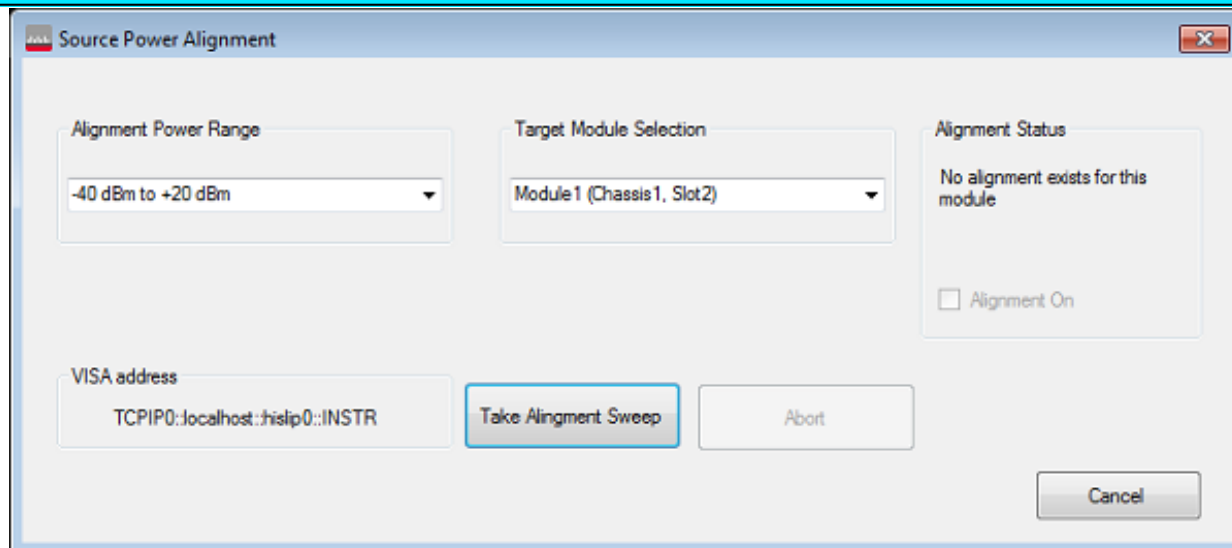

Alignment Power Range: select the power range you will use. Wider range will take longer time for execution.

Target Module Selection: select the required module

VISA address: display the VISA address for hislip.

Alignment Status: show the current status. Alignment On enable the alignment data you took.

Last modified:

20-May-2019 New topic

Setting System Impedance

The system impedance can be changed for measuring devices with an impedance other than 50 ohms, such as waveguide devices. The VNA mathematically transforms and displays the measurement data as though the VNA ports were the specified impedance value. Physically, the test ports are always about 50 ohms.

How to change the System Impedance

Using **Hardkey/SoftTab/Softkey**

1. Press **Scale** > **Constants** > **System Z0**

Programming Commands

System Z0 softtab help

Allows you to change the system impedance (default setting is 50 ohms).

Z0 Displays the current system impedance.

For 75 ohm devices:

1. Change the system Z0 to 75 ohms.
2. Connect minimum loss pads (75 ohm impedance) between the analyzer and the DUT to minimize the physical mismatch.
3. Perform a calibration with 75 ohm calibration standards.

For waveguide devices

When selecting a Cal Kit with an impedance other than 50 ohms (Waveguide = 1 ohm), it is **NO LONGER NECESSARY** to change the **System Impedance** setting before performing a calibration. The impedance for the calibration is now derived from the Cal Kit '**Connector**' impedance setting.

Application Notes

The following links require an **Internet connection**.

Note: Check out the multimedia VNA Demo presentations, including '[Network Analyzer Basics](#)'.

Calibrations

AN1287-11 [Specifying Calibration Standards and Kits for Keysight Vector Network Analyzers \(5989-4840EN\)](#)

PN8510-8A [TRL Calibration for Non-Coaxial Measurements \(5091-3645E\)](#)

[Calibrating Standards for In-Fixture Device Characterization \(White Paper\) \(5989-3245EN\)](#)

[Electronic vs. Mechanical Calibration kits: Calibration methods and accuracy \(White Paper\) \(5988-9477EN\)](#)

[On-Wafer Calibration Using a 4-port, 20 GHz PNA-L Network Analyzer \(N5230A Option 240/245\) \(5989-2287EN\)](#)

ECal

[Keysight Electronic vs. Mechanical Calibration Kits: Calibration Methods and Accuracy \(5988-9477EN\)](#)

[User Characterization: Electronic Calibration Feature Allows Users to Customize to Specific Needs \(5988-9478EN\)](#)

Embedding / De-embedding

[De-embedding and Embedding S-Parameter Networks Using a Vector Network Analyzer \(5980-2784EN\)](#)

Amplifier Measurements

AN1408-7 [Amplifier Linear and Gain Measurements \(5988-8644EN\)](#)

AN1408-8 [Amplifier Swept-Harmonic Measurements \(5988-9473EN\)](#)

AN1408-9 [Amplifier and CW Swept Intermodulation-Distortion Measurements \(5988-9474EN\)](#)

AN1408-10 [High-power measurements using the PNA \(5989-1349EN\)](#)

AN1408-16 [Power-Added Efficiency \(PAE\) 5989-7293EN](#)

AN1408-17 [Making Accurate IMD Measurements with the PNA-X Network Analyzer \(5989-7265EN\)](#)

AN1408-19 [High Power Amplifier Measurements Using NVNA](#)

Antenna Measurements

[Triggering PNA Microwave Network Analyzers for Antenna Measurements \(5988-9518EN\)](#)

New Network Analyzer Methodologies in Antenna/RCS Measurements (5989-1937EN)

Pulsed Antenna Measurements Using PNA Network Analyzers (5989-0221EN)

Antenna and RCS Configurations (White Paper) (5989-0220EN)

Radar Measurements (Application Note) (5989-7575EN)

Balanced Measurements (Although the following refer to the ENA, they are also relevant to the PNA.)

On-wafer Balanced Component Measurement with the Cascade Microtech Probing System (5988-5886EN)

Network De-embedding/Embedding and Balanced Measurement (5988-4923EN)

Backplane Differential Channel Microprobe Characterization in Time and Frequency Domains (White Paper) (5989-3248EN)

Mixer Measurements

AN1408-1 Mixer Transmission Measurements Using the Frequency Conversion Application (5988-8642EN)

AN1408-2 Mixer Conversion-Loss and Group Delay Measurement Techniques and Comparisons (5988-9619EN)

AN1408-3 Improving Measurement and Calibration Accuracy Using the Frequency Converter Application (5988-9642EN)

AN1408-18 Measuring Group Delay of Frequency Converters with Embedded Local Oscillators (5989-7385EN)

Comparison of Mixer Characterization using New Vector Characterization Techniques (5988-7827EN)

Novel Method for Vector Mixer Characterization and Mixer Test System Vector Error Correction (5988-7826EN)

Measuring Absolute Group Delay of Multistage Converters Using PNA Microwave Network Analyzers (5989-0219EN)

Pulsed Measurements

AN1408-11 Accurate Pulsed Measurements (5989-0563EN)

AN1408-12 Pulsed-RF S-Parameter Measurements Using Wideband and Narrowband Detection

AN1408-21 Active-Device Characterization in Pulsed Operation Using the PNA-x (5990-7781EN)

Pulsed Antenna Measurements Using PNA Network Analyzers (5989-0221EN)

Materials Measurements

Basics of Measuring the Dielectric Properties of Materials (5989-2589EN)

Split Post Dielectric Resonators for Dielectric Measurements of Substrates (5989-5384EN)

Other Measurements

AN1287-12 [Time Domain Analysis Using a Network Analyzer \(5989-5723EN\)](#)

AN1408-14 [Using the PNA Series to Analyze Lightwave Components \(5989-3385EN\)](#)

AN1408-15 [Using the PNA for Banded Millimeter-Wave Measurements \(5989-4098EN\)](#)

AN1408-19 [High Power Amplifier Measurements Using NVNA \(5990-5039EN\)](#)

AN1408-20 [High-Accuracy Noise Figure Measurements Using the PNA-X](#)

[MM-Wave Network Analyzers: Analysis of Cable Length on VNA System Performance \(5989-1941EN\)](#)

[Ultra-Low Impedance Measurements Using 2-Port Measurements \(White Paper\) \(5989-5935EN\)](#)

Modeling

[Utilizing TDR and VNA Data to Develop 4-port Frequency Dependent Models \(White Paper\) \(5989-0638EN\)](#)

[Advanced Measurements and Modeling of Differential Devices \(White Paper\) \(5989-4518EN\)](#)

Automation

AN 1408-13 [Introduction to Application Development using the PNA \(5980-2666EN\)](#)

[Connectivity Advances for Component Manufacturers \(5980-2782EN\)](#)

[The 'Need for Speed' in Component Manufacturing Test \(5980-2783EN\)](#)

Network Analyzer Basics

This self-paced two hour video discusses the basic concepts of Network Analysis.

From the Internet: http://na.support.keysight.com/pna/NaBasics/network_analysis_basics.htm in streaming format.

Electrostatic Discharge (ESD) Protection

Protection against electrostatic discharge (ESD) is essential while removing or connecting cables to the network analyzer. Static electricity can build up on your body and can easily damage sensitive internal circuit elements when discharged. Static discharges too small to be felt can cause permanent damage.

To prevent damage to the instrument:

- **Always** have a grounded, conductive table mat in front of your test equipment.
- **Always** wear a grounded wrist strap, connected to a grounded conductive table mat, having a 1 M Ω resistor in series with it, when making test setup connections.
- **Always** wear a heel strap when working in an area with a conductive floor. If you are uncertain about the conductivity of your floor, wear a heel strap.
- **Always** ground yourself before you clean, inspect, or make a connection to a static-sensitive device or test port. You can, for example, grasp the grounded outer shell of the test port or cable connector briefly.
- **Always** ground the center conductor of a test cable before making a connection to the analyzer test port or other static-sensitive device. This can be done as follows:
 1. Connect a short (from your calibration kit) to one end of the cable to short the center conductor to the outer conductor.
 2. While wearing a grounded wrist strap, grasp the outer shell of the cable connector.
 3. Connect the other end of the cable to the test port and remove the short from the cable.

See [Analyzer Accessories](#) for ESD part numbers.

Absolute Output Power

An absolute output-power measurement displays absolute power versus frequency.

- [What is Absolute Output Power?](#)
- [Why Measure Absolute Output Power?](#)
- [Accuracy Considerations](#)
- [How to Measure Absolute Output Power](#)

[See other Amplifier Parameters topics](#)

What is Absolute Output Power?

An absolute-output power measurement displays the power present at the analyzer's input port. This power is absolute-it is not referenced (ratioed) to the incident or source power. In the log mag format, values associated with the grid's vertical axis are in units of dBm, which is the power measured in reference to 1 mW.

- 0 dBm = 1 mW
- -10 dBm = 100 μ W
- +10 dBm = 10 mW

In the linear mag format, values associated with the grid's vertical axis are in units of watts (W).

Why Measure Absolute Output Power?

Absolute output power is measured when the amplifier's output must be quantified as absolute power rather than a ratioed relative power measurement. For example, during a gain compression measurement, it is typical to also measure absolute output power. This shows the absolute power out of the amplifier where 1-dB compression occurs.

Accuracy Considerations

The output power of the amplifier should be sufficiently attenuated if necessary. Too much output power could:

- o Damage the analyzer receiver
- o Exceed the input compression level of the analyzer receiver, resulting in inaccurate measurements.

Attenuation of the amplifier's output power can be accomplished using either attenuators or couplers

The amplifier may respond very differently at various temperatures. The tests should be done when the amplifier is at the desired operating temperature.

How to Measure Absolute Power

Do the following to measure absolute output power:

1. Preset the analyzer.
2. Select an unratiod power measurement (receiver B). [Learn how.](#)
3. Set the analyzer's source power to 0 dBm.
4. Select an external attenuator (if needed) so the amplifier's output power will be sufficiently attenuated to avoid causing receiver compression or damage to the analyzer's port-2.
5. Connect the amplifier as shown in the following graphic, and provide the dc bias.

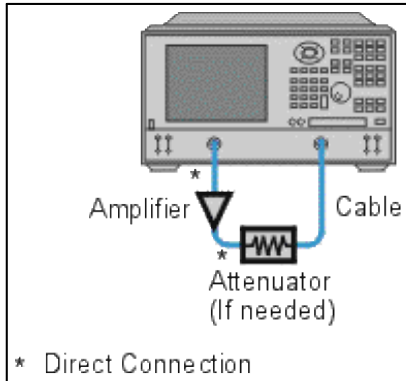

6. Select the analyzer settings for your amplifier under test.
7. Remove the amplifier and connect the measurement ports together. Store the data to memory. Be sure to include the attenuator and cables in the test setup if they will be used when measuring the amplifier.
8. Save the instrument state to memory.
9. Reconnect the amplifier.
10. Select the data math function Data/Memory.

11. Scale the displayed measurement for optimum viewing and use a marker to measure the absolute output-power at a desired frequency.
 12. Print or save the data to a disk.
-

AM-PM Conversion

The AM-PM conversion of an amplifier is a measure of the amount of undesired phase deviation (PM) that is caused by amplitude variations (AM) inherent in the system.

- [What Is AM-PM Conversion?](#)
- [Why Measure AM-PM Conversion](#)
- [Accuracy Considerations](#)
- [How to Measure AM-PM Conversion](#)

Other Tutorials topics

What Is AM-PM Conversion?

AM-to-PM conversion measures the amount of undesired phase deviation (PM) that is caused by amplitude variations (AM) of the system. For example, unwanted phase deviation (PM) in a communications system can be caused by:

Unintentional amplitude variations (AM)

- Power supply ripple
- Thermal drift
- Multipath fading

Intentional modulation of signal amplitude

- QAM
- Burst modulation

AM-to-PM conversion is usually defined as the change in output phase for a 1-dB increment in the power-sweep applied to the amplifier's input (i.e. at the 1 dB gain compression point). It is expressed in degrees-per-dB ($^{\circ}/\text{dB}$). An ideal amplifier would have no interaction between its phase response and the power level of the input signal.

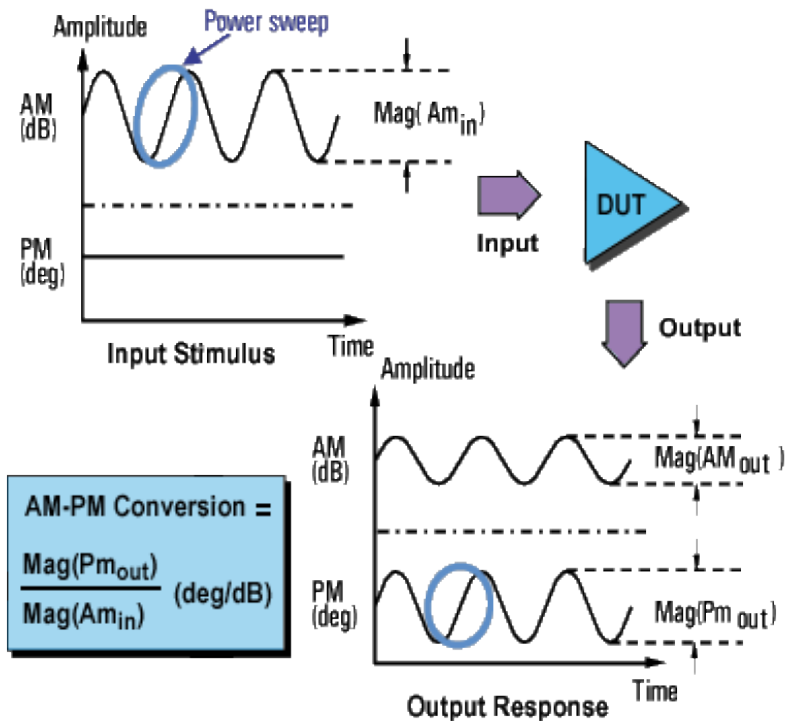

Why Measure AM-PM Conversion

AM-to-PM conversion is a critical parameter in systems where **phase** (angular) modulation is used, such as:

- FM
- QPSK
- 16QAM

It is a critical parameter because undesired phase deviation (PM) causes analog signal degradation, or increased bit-error rates (BER) in digital communication systems. While it is easy to measure the BER of a digital communication system, this measurement alone does not help you understand the underlying causes of bit errors. AM-to-PM conversion is one of the fundamental contributors to BER, and therefore it is important to quantify this parameter in communication systems.

Refer to the I/Q diagram below for the following discussion on how AM-to-PM conversion can cause bit errors.

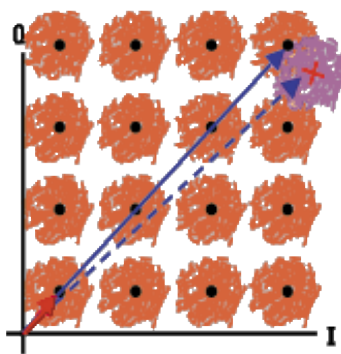

AM to PM conversion
can cause bit errors

- The desirable state change is from the small solid vector to the large solid vector.
- With AM-to-PM conversion, the large vector may actually end up as shown with the dotted line. This is due to phase shift that results from a change in the input power level.
- For a 64QAM signal as shown (only one quadrant is drawn), we see that the noise circles that surround each state would actually overlap, which means that statistically, some bit errors would occur.

Accuracy Considerations

With this method of measuring AM-to-PM conversion, the modulation frequency is approximately the inverse of the sweep time. Even with the fastest power sweep available on most network analyzers, the modulation frequency ends up being fairly low (typically less than 10 Hz). This could cause a slight temperature change as the sweep progresses, especially if the amplifier has low thermal mass, typical of an unpackaged device. Results using this method could differ slightly if the nonlinear behavior of an amplifier is extremely sensitive to thermal changes.

- The amplifier may respond very differently at various temperatures. The tests should be done when the amplifier is at the desired operating temperature.
- The output power of the amplifier should be sufficiently attenuated if necessary. Too much output power could:
 - damage the analyzer receiver
 - exceed the input compression level of the analyzer receiver, resulting in inaccurate measurements
- Attenuation of the amplifier's output power can be accomplished using:
 - Attenuators
 - Couplers

- The frequency-response effects of the attenuators and couplers must be accounted for during calibration since they are part of the test system. Proper error-correction techniques can reduce these effects.
- The frequency response is the dominant error in an AM-to-PM conversion measurement setup. Performing a thru-response measurement calibration significantly reduces this error. For greater accuracy, perform a 2-port measurement calibration.

How to Measure AM-PM Conversion

1. Preset the analyzer.
2. Select an S21 measurement in the power-sweep mode.
3. Enter the start and stop power levels for the analyzer's power sweep. The start power level should be in the linear region of the amplifier's response (typically 10-dB below the 1-dB compression point). The stop power level should be in the compression region of the amplifier's response.
4. Select an external attenuator (if needed) so the amplifier's output power will be sufficiently attenuated to avoid causing receiver compression or damage to the analyzer's port 2.
5. Connect the amplifier as shown in the following graphic, and provide the dc bias.

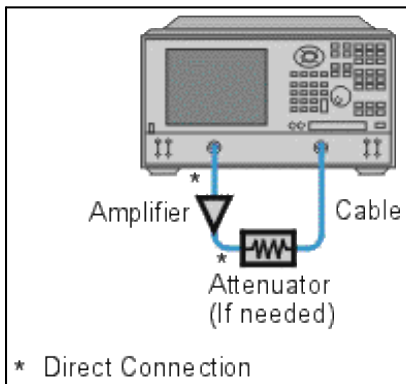

6. Select the analyzer settings for your amplifier under test in order to perform a swept-power gain compression measurement at a chosen frequency. See [Gain Compression](#).
7. Remove the amplifier and perform a measurement calibration. Be sure to include the attenuator and cables in the calibration setup if they will be used when measuring the amplifier.
8. Save the instrument state to memory.
9. Reconnect the amplifier.
10. Use a reference marker to target the amplifier's input power at the 1-dB gain compression point. Select a second marker and adjust its stimulus value until its response is 1-dB below the reference marker.

11. Change the S_{21} measurement from a log magnitude format to a phase format (no new calibration is required).
12. Find the phase change between the markers. The value is the AM-to-PM conversion coefficient at the 1-dB gain compression point.
13. Print the data or save it to a disk.

Amplifier Parameters Reference

- [Gain](#)
- [Gain Flatness](#)
- [Reverse Isolation](#)
- [Gain Drift Versus Time](#)
- [Deviation from Linear Phase](#)
- [Group Delay](#)
- [Return Loss \(SWR, \$\rho\$ \)](#)
- [Complex Impedance](#)
- [Gain Compression](#)
- [AM-to-PM Conversion](#)

See Also

- [High-Gain Amplifiers](#)

Gain

$$\tau = \frac{V_{\text{trans}}}{V_{\text{inc}}}$$
$$\text{Gain (dB)} = -20 \log_{10} |\tau|$$
$$\text{Gain (dB)} = P_{\text{out}} \text{ (dBm)} - P_{\text{in}} \text{ (dBm)}$$

The ratio of the amplifier's output power (delivered to a Z_0 load) to the input power (delivered from a Z_0 source). Z_0 is the characteristic impedance, in this case, 50Ω .

For small signal levels, the output power of the amplifier is proportional to the input power. Small signal gain is the gain in this linear region.

As the input power level increases and the amplifier approaches saturation, the output power reaches a limit and the gain drops. Large signal gain is the gain in this nonlinear region. See [Gain Compression](#).

Gain Flatness

The variation of the gain over the frequency range of the amplifier. See [Small Signal Gain and Flatness](#).

Reverse Isolation

The measure of transmission from output to input. Similar to the gain measurement except the signal stimulus is applied to the output of the amplifier. See [Reverse Isolation](#).

Gain Drift versus Time (temperature, bias)

The maximum variation of gain as a function of time, with all other parameters held constant. Gain drift is also observed with respect to other parameter changes such as temperature, humidity or bias voltage.

Deviation from Linear Phase

The amount of variation from a linear phase shift. Ideally, the phase shift through an amplifier is a linear function of frequency. See [Deviation from Linear Phase](#).

Group Delay

$$\begin{aligned}\tau_g (\text{sec}) &= - \frac{\Delta \theta}{\Delta \omega} \\ &= - \frac{1}{360} * \frac{\Delta \theta}{\Delta f}\end{aligned}$$

The measure of the transit time through the amplifier as a function of frequency. A perfectly linear phase shift would have a constant rate of change with respect to frequency, yielding a constant group delay. See [Group Delay](#).

Return Loss (SWR,)

$$\begin{aligned}\Gamma &= \frac{V_{\text{refl}}}{V_{\text{inc}}} = \rho \angle \theta \\ \text{Reflection coefficient} &= \rho \\ \text{Return loss (dB)} &= -20 \log_{10} \rho \\ \text{SWR} &= \frac{1+\rho}{1-\rho}\end{aligned}$$

The measure of the reflection mismatch at the input or output of the amplifier relative to the system Z_0 characteristic impedance.

Complex Impedance

$$Z = \frac{1+\Gamma}{1-\Gamma} * Z_0$$
$$= R + jX$$

Complex impedance (1+G). The amount of reflected energy from an amplifier is directly related to its impedance. Complex impedance consists of both a resistive and a reactive component. It is derived from the characteristic impedance of the system and the reflection coefficient. See [Complex Impedance](#).

Gain Compression

See [Gain Compression Application](#).

AM-to-PM Conversion Coefficient

$$\text{AM/PM} = \frac{\Delta \theta}{\Delta P}$$

The amount of phase change generated in the output signal of an amplifier as a result of an amplitude change of the input signal.

The AM-to-PM conversion coefficient is expressed in units of degrees/dB at a given power level (usually P_{1dB}, which is the 1 dB gain compression point). See [AM-PM Conversion](#).

Antenna Measurements

This topic describes how to setup a Keysight Vector Network Analyzer (VNA) to make S21 measurements on an array of antennas. Measurements can be made on up to 100 antenna arrays (Ports) and up to 15 discrete frequencies

Measurement Sequence

1. The VNA is set to a start frequency.
2. As the antenna moves, the VNA responds to each external trigger signal by measuring an antenna port.
3. When all ports are measured, the VNA increments to the next frequency
4. Again the VNA measures all ports, and so forth until all ports are measured at all frequencies in the forward direction.
5. As the antenna begins moving in the opposite direction, the same sequence occurs, except the VNA decrements in frequency until all ports are measured at all frequencies and the VNA is set back to the original start frequency.

Once setup, only external trigger signals are sent to the VNA. After each trigger, measurement data is stored in internal VNA memory.

How to set up the VNA

1. Press **Preset**
2. Press **Trigger** > **Main** > **Trigger Source** > **External**
3. Press **Trigger** > **Main** > **Trigger**
4. In the Trigger dialog under **Trigger Scope**, select **Channel**
5. Click **OK**

Forward Sweep

1. Press **Trace** > **Trace N** > **Trace N** to add a new trace.
2. Press **Trace** > **Trace Setup** > **Measure....**
3. Select **S21** then Channel Number **1**

4. Press **Trigger** > **Main** > **Trigger**
5. In the Trigger dialog under **Channel Trigger State**, set the Trigger Mode to **Point**
6. Click **OK**
7. Press **Sweep** > **Main** > **Sweep Type** > **Segment Sweep**
8. Click **OK**
9. Press **Sweep** > **Segment Table** > **Insert Segment**
10. Do this 15 times
11. For each Segment in the Segment table:
 1. Click **State**:and select **ON**
 2. Click both **START** and **STOP** Frequency: (each new segment ascends in frequency)
 3. Click **Points**: type Number of Ports (elements)

Reverse sweep

Repeat the following steps for each frequency: (up to 15)

- Increment the channel number (**X**) Starting with Channel 2
 - Decrement the frequency (**F**)
1. Press **Trace** > **Trace N** > **Trace N** to add a new trace.
 2. Press **Trace** > **Trace Setup** > **Measure....**
 3. Click **S21** then Channel Number **X**
 4. When a window contains four traces, press **Trace** > **Trace Setup** > **Add Trace** > **New Trace + Window**.
 5. Click **OK**
 6. Press **Trigger** > **Main** > **Trigger**
 7. In the Trigger dialog under **Channel Trigger State**, set the Trigger Mode to **Point**
 8. Click **OK**
 9. Press **Sweep** > **Main** > **Sweep Type** > **Segment Sweep**

10. Click **OK**
 11. Press **Sweep** > **Segment Table**
 12. In the Segment table
 1. Click **State:**and select **ON**
 2. Click both **START** and **STOP** Frequency **F**
 3. Click **Points:** type Number of Ports (elements)
-

Balanced Measurements

- What are Balanced Devices?
- Differential and Common Modes Model
- Measuring Mixed Mode (Balanced) S-Parameters
- Measuring Imbalance Parameters
- Measuring CMRR
- Port Mapping
- Calibrating Balanced Measurements
- How the analyzer makes Balanced Measurements

Other Measurement Setup Topics

What are Balanced Devices?

Standard **Single-ended devices** generally have one input port and one output port. Signals on the input and output ports are referenced to ground.

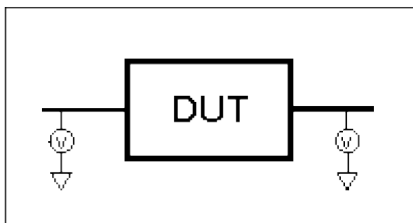

Balanced devices have two pins on either the input, the output, or both. The signal of interest is the difference and average of the two input or output lines, not referenced to ground.

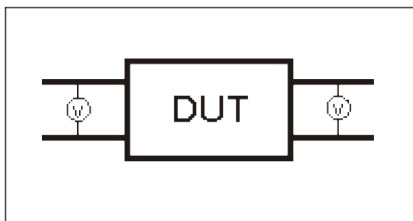

Differential and Common Modes Model

On balanced devices, the signal of interest is the **difference** and **average** of the two input or output lines. In balanced device terminology, these signals are known as the Differential and Common modes.

The following model shows how two signals (A and B) combine to create Differential and Common mode signals:

- **Signal A** is fixed at 1V peak
- **Signal B** is selectable
- **Differential** is calculated as **A minus B**
- **Common** is calculated as the **AVERAGE** of **A and B**

Note: Click **Signal B** selections to see various Differential and Common signals.

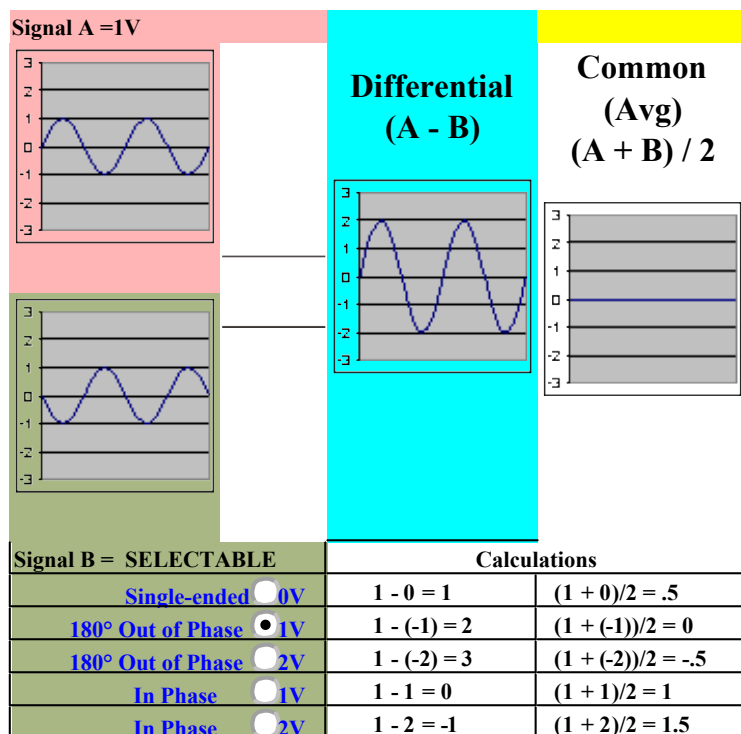

Notes:

- Even when Signal B is 0V, like a Single-ended signal, there is still a unique Differential and Common mode representation of the two individual signals.
- The above model does not show a DUT. The difference and average of two signals can be calculated for both the balanced INPUT and balanced OUTPUT of a device.

Measuring Mixed Mode (Balanced) S-Parameters

Mixed mode S-parameters combine traditional S-parameter notation with balanced measurement terminology.

Some balanced devices are designed to amplify the differential component and reject the common component. This allows noise that is common to both inputs to be virtually eliminated from the output. For example, a balanced device may amplify the differential signal by a factor of 5, and attenuate the common signal by a factor of 5. Using traditional S-parameter notation, an S21 is a ratio measurement of the device **Output** / device **Input**. Mixing this with balanced terminology, we could view the amplifier's Differential Output signal / Differential Input signal. To see this parameter on the analyzer, we would select an Sdd21 measurement using the following balanced notation:

Sabxy -

Where

a - device output mode

b - device input mode

(choose from the following for both a and b:)

- **d** - differential
- **c** - common
- **s** - single ended

x - device output "logical" port number

y - device input "logical" port number

See Also

[Logical port mapping](#)

Measuring Imbalance Parameters

Imbalance is a measure of how well two physical ports that make up a balanced port are matched. With a perfectly balanced port, the same amount of energy flows to both ports and the magnitude of the ratio of these ports is 1.

The notation is similar to traditional S-parameters. In the following diagrams, the letters a, b, c, and d are used because any analyzer port can be assigned to any logical port using the [port mapping process](#).

For example, in the following single-ended - balanced formula, **Sba** indicates the device output port is

logical port b and the input port is logical port a.

Imbalance parameter when measuring a **balanced** device.

Balanced

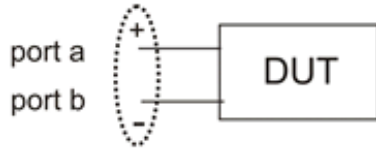

$$\text{Imbal} = - \frac{S_a}{S_b}$$

Imbalance parameter when measuring a **single-ended - balanced** device.

Single-ended

Balanced

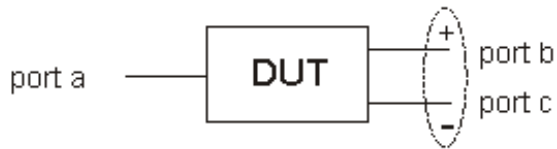

$$\text{Imbal} = - \frac{S_{ba}}{S_{ca}}$$

Imbalance parameter when measuring a **balanced - single-ended** device.

Balanced

Single-ended

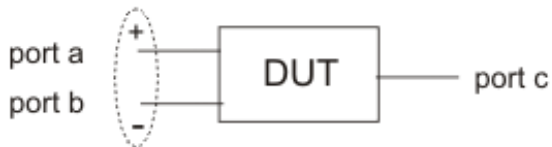

$$\text{Imbal} = - \frac{S_{ca}}{S_{cb}}$$

Imbalance1 and Imbalance2 parameters when measuring a **balanced - balanced** device.

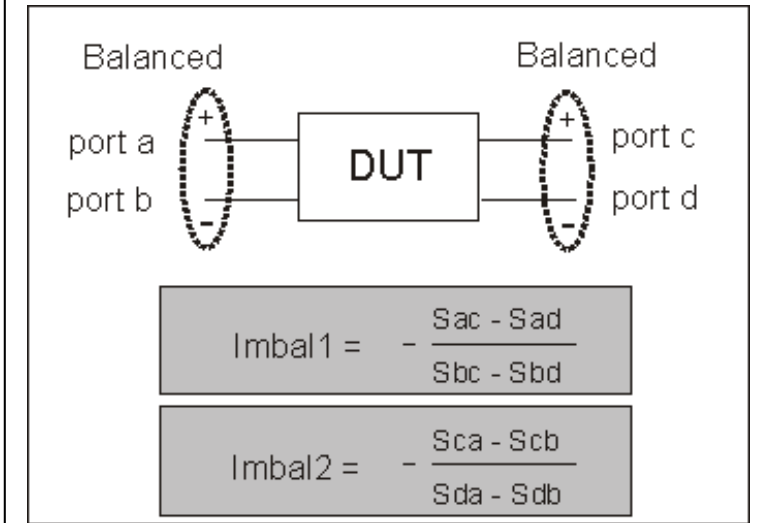

Imbalance1 and Imbalance2 parameters when measuring a **single-ended - single-ended - balanced** device.

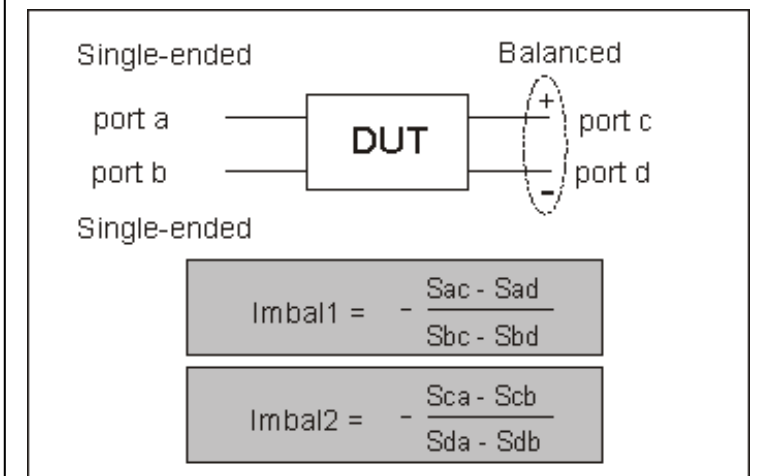

Measuring CMRR (Common Mode Rejection Ratio)

CMRR is a ratio of the transmission characteristic in differential mode over the transmission characteristic in the common mode of the balanced port as the measurement parameter. A high value indicates more rejection of common mode, which is desirable in a device that transmits information in the differential portion of the signal. The table below shows the CMRR parameter you can select when measuring each balanced device.

Single-ended - balanced device	Sds21 ----- Scs21	and	Ssd12 ----- Ssc12
Balanced - single-ended device	Ssd21 ----- Ssc21	and	Sds12 ----- Scs12
Balanced - balanced device	Sdd21 ----- Scc21		
Single-ended - single-ended - balanced device	Sds31 ----- Scs31	and	Sds32 ----- Scs32

Device Topology and Port Mapping

As we have seen on balanced inputs and outputs, the signal of interest is the difference or average of two BALANCED input or BALANCED output lines. It is also possible to have single-ended ports AND balanced ports on the same device. The two balanced input or output lines are referred to as a single "logical" port.

When configuring a balanced measurement on the analyzer, select a device 'topology'. Then map each test port to the DUT ports. The analyzer assigns "logical ports". [See how to set device topology.](#)

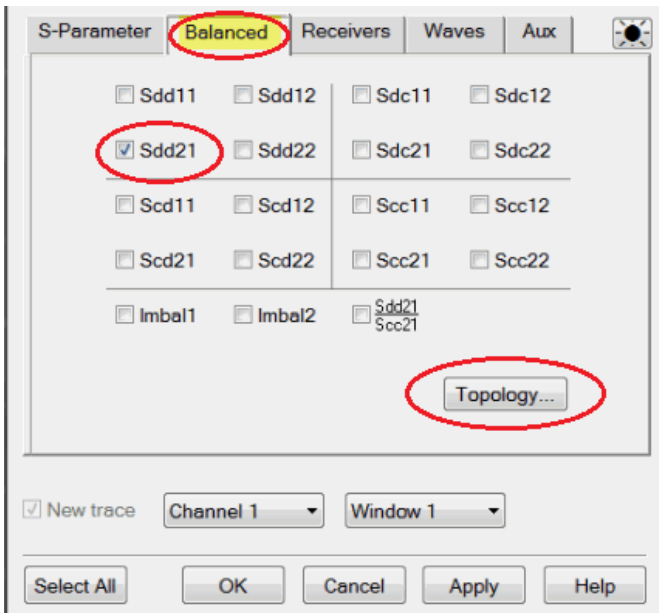

The following device topologies can be measured by a 4-port analyzer.

- **Balanced / Balanced**
(2 logical ports - 4 physical ports)

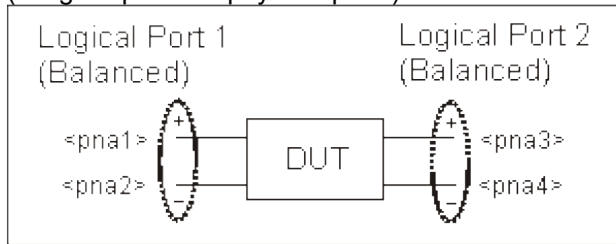

- **Single-ended / Balanced**
(2 logical ports - 3 physical ports)

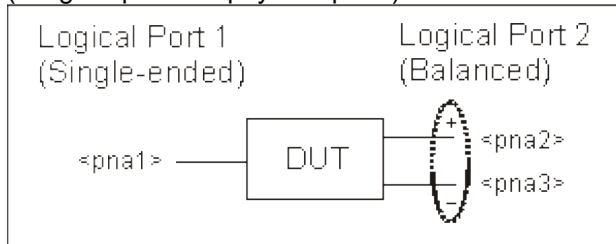

- **Balanced / Single-ended**
(2 logical ports - 3 physical ports)

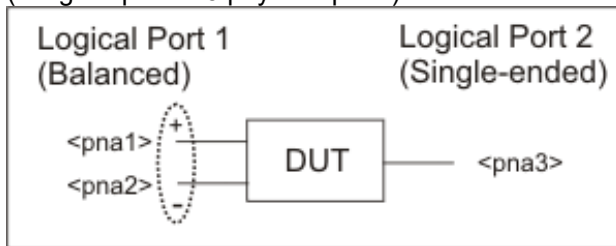

- **Single-ended - Single-ended / Balanced**
(3 logical ports - 4 physical ports)

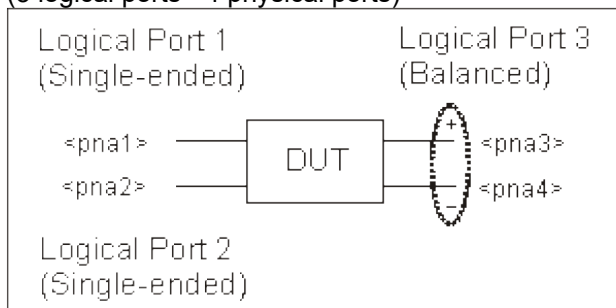

These topologies can be used in the reverse (\Leftarrow) direction to measure:

- **Balanced / Single-ended** topology
- **Balanced / Single-ended - Single-ended** topology

For example, to measure a **Balanced / Single-ended** topology, measure the S12 (reverse direction) of a **Single-ended / Balanced** topology.

Calibrating Balanced Measurements

Balanced measurements are calibrated in the same manner as single-ended (standard) measurements. However, for highest accuracy, you must choose Thru paths so that each **transmission path** of the balanced measurement is represented. For a Balanced/Balanced topology, this means that FOUR Thru connections should be made.

For example (see following image):

- Balanced Port 1 is ports 1 and 3
- Balanced Port 2 is ports 2 and 4
- Thru paths to be calibrated should be: 12, 14, 32, 34.
- Paths 13, and 24 are less important.

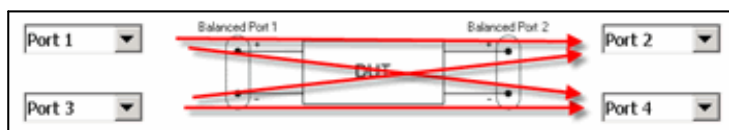

To select Thru paths:

1. From SmartCal, on the Select DUT Connectors and Cal Kits page, check **Modify Cal**.
2. Click **Next** to see the following Cal Wizard page:

Modify Cal				
	1st Port	2nd Port	Thru Cal Method	
Thru #1	1	2	Unknown Thru	Cal Type/Std...
Thru #2	1	4	Unknown Thru	Cal Type/Std...
Thru #3	3	4	Unknown Thru	Cal Type/Std...
Thru #4	2	3	Unknown Thru	Cal Type/Std...

How the analyzer makes Balanced Measurements

When using standard Balanced measurements, the analyzer does not provide true balanced measurements by stimulating both balanced inputs together and measuring both outputs relative to one another. Instead, the analyzer makes only Single-ended measurements. On a Balanced/ Balanced device, it stimulates each input and measures each output individually. From the output data, the analyzer calculates the Differential and Common outputs from the DUT using the same math formulas as the above model. However, all measurements and calculations are performed in frequency domain

using complex (magnitude and phase) data. The Balanced S-parameter display data is then calculated from the Differential and Common inputs and outputs.

Complex Impedance

When making an S_{11} or S_{22} measurement of your device under test, you can view complex-impedance data such as series resistance and reactance as well as **phase** and magnitude information. Complex impedance data can be viewed using either the Smith Chart format or the Polar format.

- [What Is Complex Impedance?](#)
- [Accuracy Considerations](#)
- [How to Measure Complex Impedance](#)

What Is Complex Impedance?

Complex-impedance data is information that can be determined from an S_{11} or S_{22} measurement of your device under test, such as:

- Resistance
- Reactance
- Phase
- Magnitude

The amount of power reflected from a device is directly related to the impedances of both the device and the measuring system. For example, the value of the complex reflection coefficient (Γ) is equal to 0 only when the device impedance and the system impedance are exactly the same (i.e. maximum power is transferred from the source to the **load**). Every value for Γ corresponds uniquely to a complex device impedance (as a function of frequency), according to the equation:

$$Z_L = [(1 + \Gamma) / (1 - \Gamma)] \times Z_0$$

where Z_L is your test device impedance and Z_0 is the measuring system's characteristic impedance.

Complex Impedance is best viewed using either **Polar** or **Smith Chart** format.

Accuracy Considerations

- The Smith chart is most easily understood when used with a full scale value of 1.0.

- For greater accuracy when using markers in the Smith chart or polar formats, activate the discrete marker mode.
- The uncertainty of reflection measurements is affected by:
 - Directivity
 - Reflection tracking
 - Source match
 - Load match (with 2-port devices)

With a 2-port calibration, the effects of these factors are reduced. A 1-port calibration provides the same accuracy if the output of the device is well terminated. Refer to the graphic below for the following discussion.

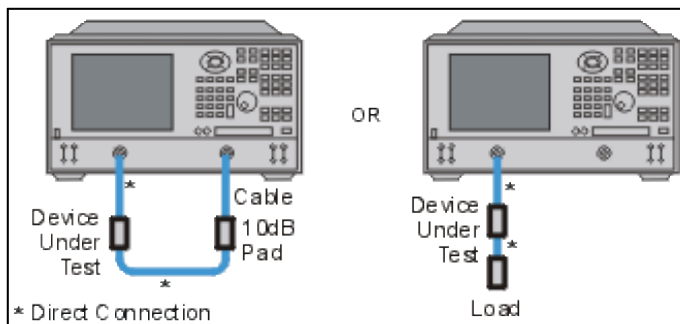

- If you connect the device between both analyzer ports, it is recommended that you use a 10 dB pad on the output of the device to improve measurement accuracy. This is not necessary if you use a 2-port calibration since it corrects for load match.
- If you connect a two-port device to only one analyzer port, it is recommended that you use a high-quality load (such as a calibration standard) on the output of the device.

How to Measure Complex Impedance

1. Connect the device as shown in the previous graphic.
2. Preset the analyzer.
3. Set up, calibrate, and perform an S11 or S22 measurement.
4. View impedance data:
 - a. Select the Smith Chart format.

- b. Scale the displayed measurement for optimum viewing.
 - c. Position the marker to read the resistive and reactive components of the complex impedance at any point along the trace.
 - d. Print the data or save it to a disk.
5. View the magnitude and phase of the reflection coefficient:
- a. Select the Smith chart format or the Polar format.
 - b. Select either Lin Marker or Log Marker formats.
 - c. Scale the displayed measurement for optimum viewing.
 - d. Position the marker to read the frequency, magnitude, and phase of the reflection coefficient (Γ) at any point along the trace.
 - e. Print the data or save it to a disk.

Comparing the VNA "Delay" Functions

The VNA has three Delay functions which are similar but are used in different ways.

1. **Group Delay format** is used to display the Group Delay of a network. Group Delay is defined as:

$$-d(\phi) / d(\omega) \text{ -- where } \phi \text{ is radian angle, and } \omega \text{ is radian frequency.}$$

Since it is defined by a derivative, the value must be determined from an analytic function. However, the VNA makes discrete measurements, so we approximate the group delay by taking the finite difference:

$$-(1/360) * \Delta(\phi) / \Delta(f) \text{ -- where } \phi \text{ is degree angle and } f \text{ is frequency in Hz. The } 1/360 \text{ does the proper conversion of degrees to radians and Hz frequency to radian frequency.}$$

From this we can see that, if the phase response of a network varies with frequency, then the Group Delay must vary as well. In fact, many filters are specified by the variation of their Group Delay.

If we measure the phase response of a lossless cable, it should be a straight line. But, of course, nothing is perfect. The phase response will have a small amount of noise. This is due to trace noise of the VNA, and the loss with real cables or transmission lines, which causes a small amount of non-linear phase change with frequency. So, if we look at the Group Delay of a cable, we will see a small amount of variation. Also, if the frequency spacing is small enough when you make the measurement, the $\Delta(f)$ in the denominator becomes very small, so the delay can have wide swings with just a little noise.

To overcome this issue, we sometimes add smoothing to a phase trace, which widens the effective $\Delta(f)$, called the aperture, and provides a less noisy Group Delay response. The Group Delay of a device is only valid for a given frequency aperture. [Learn more about Group Delay.](#)

2. **Electrical Delay** function. On many filters, the passband response is specified for a maximum value of "Deviation from Linear Phase". When looking at the passband of a multi-pole filter, one sees the phase changing very rapidly. This makes it difficult to determine the linearity of the phase response. The Electrical Delay function subtracts out a "LINEAR PHASE" equivalent to the delay time value computed as above. When you use this function, you dial in the Linear Delay such that a CONSTANT PHASE SLOPE is removed from the phase trace, until the phase trace is mostly flat. The remaining variation is the deviation from linear phase.

To make this task a little less tedious, the VNA has a marker function called **Marker =>> Delay**. This function computes the Group Delay value at the marker position, using a 20% smoothing aperture, then changes the Electrical Delay value to this value. Obviously, if the phase trace is not perfectly linear, moving the marker and recomputing the delay will result in different values. The phase slope added by

the electrical delay function applies only to the current measurement. That is, each measurement (S11, S22, S12, S21) can have its own value of electrical delay. [Learn more about Deviation from Linear Phase.](#)

3. Port Extension is a function that is similar to calibration. It applies to all the traces in a given channel. It compensates for the phase response change that occurs when the calibration reference plane is not the same as the measurement plane of the device.

Let's look at an example of a DUT that is mounted on a PCB fixture with SMA connectors. We can easily calibrate at the SMA connectors. But if we add the fixture to measure the board-mounted device, the apparent phase of the DUT is changed by the phase of the PCB fixture. We use port extensions to add a LINEAR PHASE (constant delay) to the calibration routines to shift the phase reference plane to that of the DUT. This is ONLY valid if the fixture consists of a transmission line with linear phase response, and this limitation is usually met in practice. The main reason that it is NOT met is that there is mismatch at the SMA-to-PCB interface. This mismatch was not removed with the error correction because it occurs AFTER the SMA connector. Ripple can be seen on the display as signals bounce back and forth between the mismatch and the DUT. If the DUT is well matched, the ripple effect is very small. However, when we use Automatic Port Extension (APE), and we leave the fixture open (the DUT removed), the reflection is large and we see larger ripples. That is why APE uses a curve fitting process to remove the effects of the ripple. For best effect, the wider the IF Bandwidth, the better we can "smooth-out" the ripples with curve fitting. Still, we are fitting a LINEAR PHASE SLOPE to the phase response, and thus we use only a single Port Extension Delay value to represent the phase slope.

The method used by older VNAs to get this same functionality was to add a mechanical line stretcher to the reference channel, which removed a fixed delay amount from the port. Port extensions give 1x the delay for transmission at each port, and 2x the delay for reflection, so it differs somewhat from Electrical Delay above, in that the math function depends upon the measurement being made. The signal passes twice through the fixture for reflection (out and back), but only once for each port on transmission. For S21, the phase slope added is the sum of the port 1 and port 2 Port Extension Delay values.

The "User Range" APE function is used in cases where a fixture has limited bandwidth, perhaps due to tuning elements or bias elements. In this case, the model of constant delay for the fixture over the whole bandwidth is not valid, so a narrower "User Range" of frequencies can be selected to compute the delay. Since the aperture is smaller, there is more uncertainty in the delay computation for port extension. Also, for those who had been using the [Marker ==> Delay](#) function to estimate the delay, we added the "Active Marker" selection to APE, which works exactly the same as [Marker->Delay](#). [Learn more about Automatic Port Extensions.](#)

Deviation from Linear Phase

Deviation from linear phase is a measure of phase distortion. The electrical delay feature of the analyzer is used to remove the linear portion of the phase shift from the measurement. This results in a high-resolution display of the non-linear portion of the phase shift (deviation from linear phase).

- [What Is Linear Phase Shift?](#)
- [What Is Deviation from Linear Phase?](#)
- [Why Measure Deviation from Linear Phase?](#)
- [Using Electrical Delay](#)
- [Accuracy Considerations](#)

See also [Comparing the Analyzer Delay Functions](#)

See other Tutorials

What Is Linear Phase Shift?

Phase shift occurs because the wavelengths that occupy the electrical length of the device get shorter as the frequency of the incident signal increases. *Linear* phase-shift occurs when the phase response of a device is linearly proportional to frequency. Displayed on the analyzer, the phase-versus-frequency measurement trace of this ideal linear phase shift is a straight line. The slope is proportional to the electrical length of the device. Linear phase shift is necessary (along with a flat magnitude response) for distortionless transmission of signals.

What Is Deviation from Linear Phase?

In actual practice, many electrical or electronic devices will delay some frequencies more than others, creating non-linear phase-shift (distortion in signals consisting of multiple-frequency components). Measuring deviation from linear phase is a way to quantify this non-linear phase shift.

Since it is only the deviation from linear phase which causes phase distortion, it is desirable to remove the linear portion of the phase response from the measurement. This can be accomplished by using the electrical delay feature of the analyzer to mathematically cancel the electrical length of the device under test. What remains is the deviation from linear phase, or phase distortion.

Why Measure Deviation from Linear Phase?

The deviation from linear phase measurement accomplishes the following:

- Presents data in units of phase rather than units of seconds (group delay). For devices that pass modulated signals, units of phase may be most practical.
- Provides a less noisy measurement than a **group delay** measurement.

Using Electrical Delay

The electrical delay feature is the electronic version of the mechanical "line stretcher" of earlier analyzers. This feature does the following:

- Simulates a variable-length lossless transmission line, which is effectively added to or removed from the reference signal path.
- Compensates for the electrical length of the device under test.
- Flattens the measurement trace on the analyzer's display. This allows the trace to be viewed at high resolution in order to see the details of the phase nonlinearity.
- Provides a convenient method to view the deviation from linear phase of the device under test. See the following graphic.

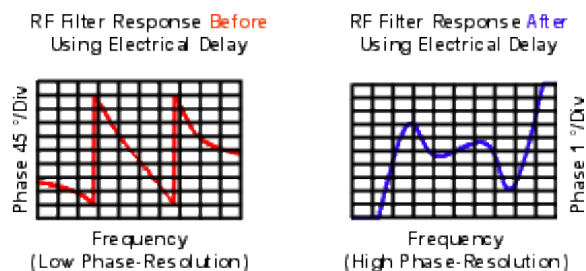

[Learn how to set Electrical Delay.](#)

Accuracy Considerations

The frequency response of the test setup is the dominant error in a deviation from linear phase measurement. To reduce this error, perform a 2-port measurement calibration.

How to Measure Deviation from Linear Phase:

1. Preset the analyzer.

2. If your device under test is an amplifier, it may be necessary to adjust the analyzer's source power:
 - o Set the analyzer's source power to be in the linear region of the amplifier's output response (typically 10-dB below the 1-dB compression point).
 - o Select an external attenuator (if needed) so the amplifier's output power will be sufficiently attenuated to avoid causing receiver compression or damage to the analyzer's port 2.
3. Connect the device under test as shown in the following graphic.

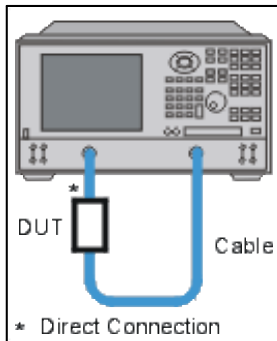

4. Select an S21 measurement.
 5. Select the settings for your device under test, including the following:
 - o **Format:** phase
 - o **Scale:** autoscale
 6. Remove the device and perform a calibration.
 7. Reconnect the device.
 8. Scale the displayed measurement for optimum viewing.
 9. **Create a marker** in the middle of the trace.
 10. Press **Marker > Marker -> Functions > Marker -> Delay** to invoke the **Marker to Electrical Delay** function. This flattens the phase trace.
 11. If desired, on the **Scale** menu, click **Electrical Delay** to fine-tune the flatness of the phase trace.
 12. Use the markers to measure the maximum peak-to-peak deviation from linear phase.
 13. Print the data or save it to a disk.
-

20 GHz Coupler Directivity Measurement Example

The purpose of this example is to show how to use the PNA Equation Editor to create a directivity measurement trace, in order to measure a directional coupler's directivity easily. Two different methods, using measurement trace data formatted differently are explained below. Results are displayed on the bottom left and bottom right hand side windows of the PNA screen. It's important to note that either approach produces the same end result, as shown with markers on both equation editor traces. Measurement trace selection and formatting are *critical* for making this work correctly. *A user would only need to use one method or the other, but both ways are explained.*

1. Set up the connections between the PNA and a directional coupler as shown below.



- a. Connect PNA Port 1 to coupler's input port.
- b. Connect PNA Port 2 to coupler's output port.
- c. Connect PNA Port 3 to coupler's coupled port.

2. Set up basic stimulus conditions for directional coupler's measurement.

- a. Preset the PNA.
- b. Set start frequency to 1 GHz.
- c. Set stop frequency to 20 GHz.
- d. Set power level to the default value.
- e. Set IFBW to 30 Hz.

3. Make window setup, trace measurement, and formatting selections.

Establish four measurement windows on the display screen. Set up windows and traces such that the left-hand side will show traces 1, 2, and 3 in upper left window, as well as trace 7 in lower-left window. Corresponding to the DUT connection diagram, traces 1, 2, and 3 will be S21, S31, and S32 measurements, respectively; and all *must* be formatted as **real**. Trace 7, an equation editor trace, will be log magnitude formatted. Trace 7 will be a S11 trace when it is created, but it will be modified to be a directivity equation trace later.

For the right-hand side of the display screen, create traces 4, 5, and 6 in upper-right window, as well as trace 8 in lower right window. Traces 4, 5, and 6, will also be S21, S31, and S32 measurements, respectively, but these traces are formatted in **linear magnitude**. Trace 8, an equation editor trace, will need to be log magnitude formatted, just like the lower-left window for equation Trace 7. Trace 8 will be a S11 trace when it is created, but it will be modified to be a directivity equation trace later, too.

4. Create the directivity traces for Tr 7 and Tr 8 with the equation editor.

Tr 7 will use **real** formatted data from Tr 1, Tr2, and Tr3 in the equation.

- a. Select Tr 7.
- b. From the **Marker/Analysis** menu, select **Analysis**, then **Equation Editor...**
- c. Enter the Equation as **Dir_from_REAL_Data=S32/(S31*S21)**.
- d. Check the **Enable Equation** box.
- e. Click on **OK**.

Tr 8 will use **linear magnitude** formatted data from Tr 4, Tr 5, and Tr 6 in the equation.

- a. Select Tr 8.
- b. From the **Marker/Analysis** menu, select **Analysis**, then **Equation Editor...**
- c. Enter the Equation as **Dir_from_LinMag_Data=Tr6/(Tr5*Tr4)**.
- d. Check the **Enable Equation** box.
- e. Click on **OK**.

Note: Window titles were added to show user comments about the traces in each window. This is strictly optional, but if desired, window titles can be added by doing the following:

- a. Select the **Response** menu, then choose **Display, Labels**, then **Window Title...**
- b. In the **Window Title** dialog box, enter a meaningful title.
- c. Check the **Enable** box.
- d. Click on **OK**.

Note: To demonstrate the equivalent results of both equation editor methods for directivity measurements, marker tables were set up for Tr 7 and Tr 8 in windows 3 and 4, respectively. Again, this is optional, but recommended.

5. Perform a 3-port calibration.

Note: An N4433A-010 ECal module was used in this example.

6. Display directivity measurement results.

- a. Initiate a single sweep.
- b. Observe that Tr 7 and Tr 8 are the same.

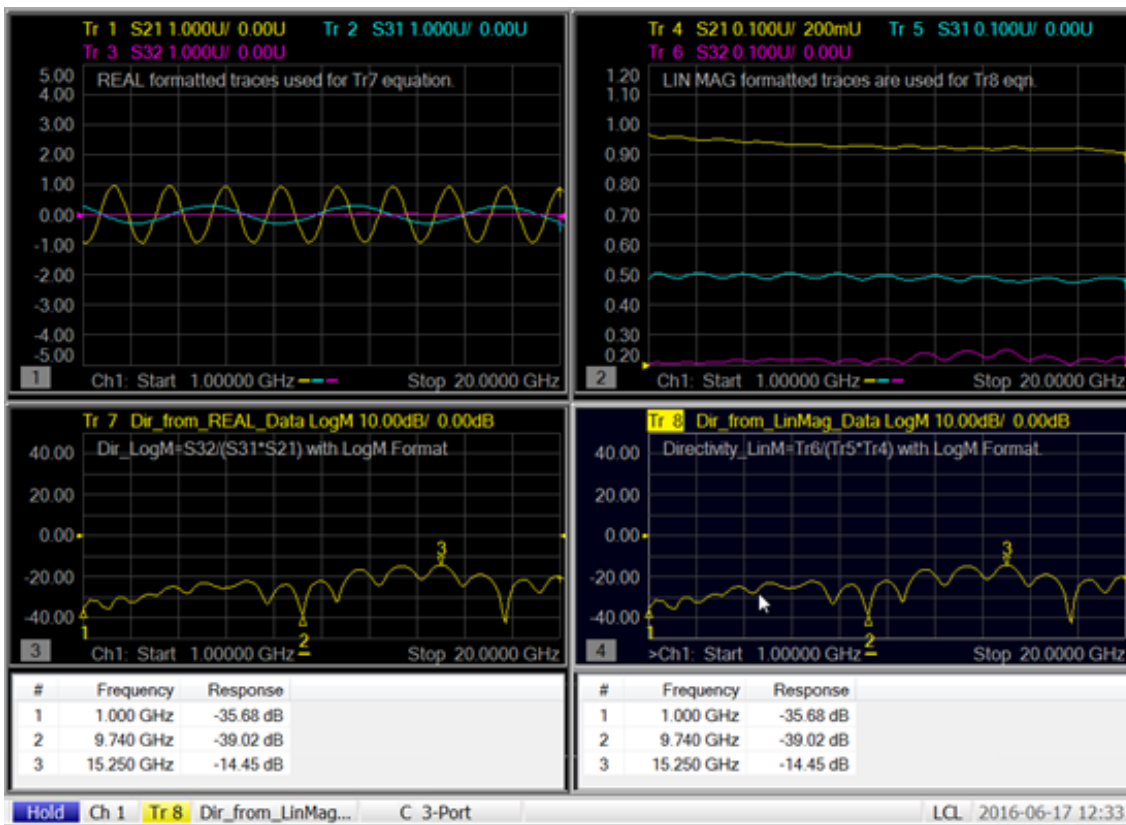

Discussion

In linear terms, the textbook equation for calculating a coupler's directivity is:

$$Directivity = Isolation - (Coupling + Loss)$$

Using log rules, this equation becomes:

$$\text{Directivity} = \text{Isolation} / (\text{Coupling} * \text{Loss})$$

The PNA equation editor has all the underlying data structures in complex real/imag (linear) values. All the math in the textbook is also in linear terms, so the equation needs to be $\text{Dir_from_LinMag_Data} = \text{Tr6}/(\text{Tr5} * \text{Tr4})$. That equation was implemented in Tr 8.

The equation editor also returns the complex data structure in real/imag, so to get directivity in dB, set the format to log magnitude for Tr 7 - just like Tr 8. (And the equation is complex, so phase will be preserved for directivity too, so you can think of this as directivity_re_im .)

For Tr 8 (in dB), the correct directivity is for isolation – (coupling + loss). But since you cannot form this equation in equation editor, you have to use the complex form. So you can refer to Tr 6, but the reference is to the last complex result, not to the formatted trace.

This equation, $\text{Directivity_LogM} = 20 * \log(\text{mag}(S32/(S31 * S21)))$, while correct (and not used in this example), will result in the complex value being formed in dB (you are formatting in the equation editor), so you would need to set the format to real to see the dB value, oddly enough. So, it is best to use $\text{Dir} = S32/(S31 * S21)$ and set the format as desired (e.g. Logmag) to get directivity in dB.

Dual Band Parallel Noise Figure Measurement

The M9485A Dual Band Parallel Noise Figure measurement can reduce the time of the noise measurement figure measurement in multi port measurement. This function is available when M9485A has option 028 and 720.

Configuration

The following figure shows an example of Dual Band Parallel Noise Figure measurement. The DUT has four power amplifiers and band-pass filters.

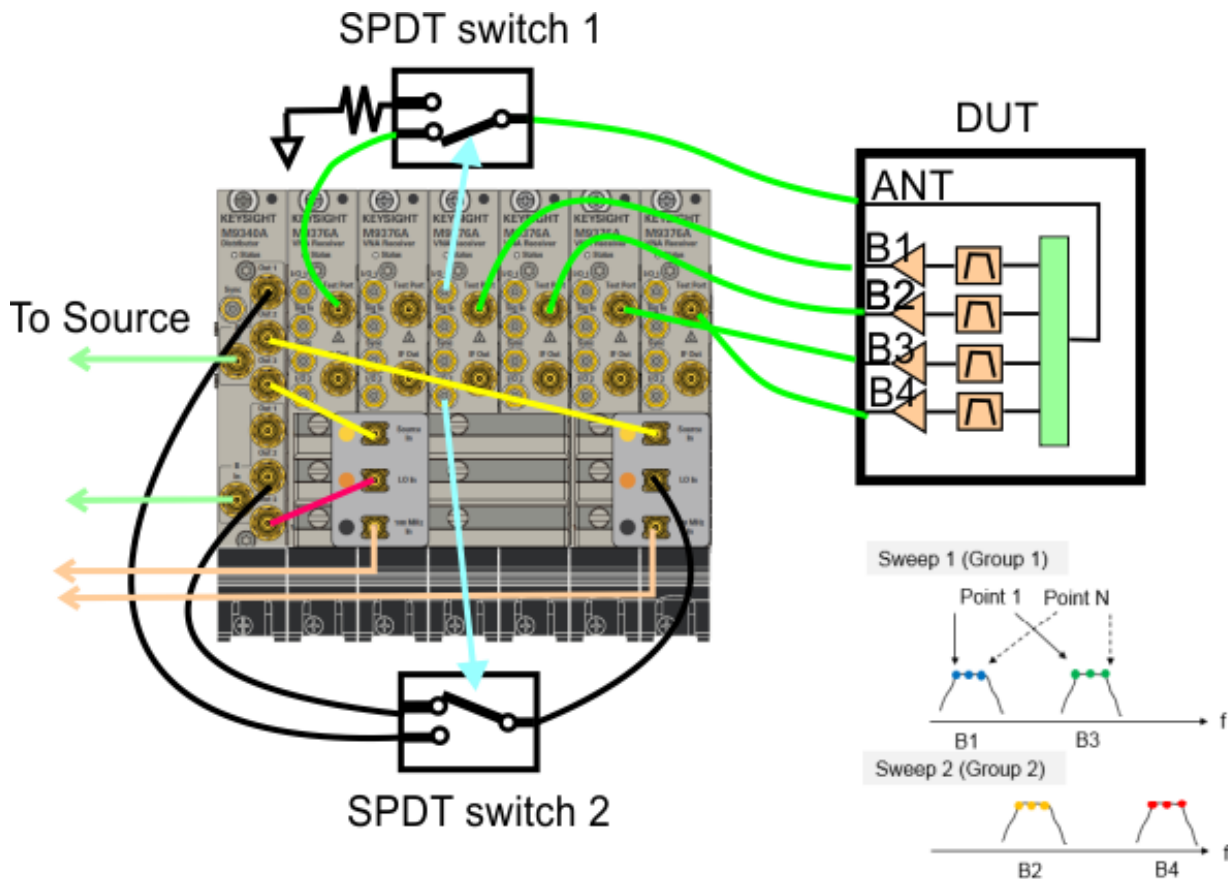

SPDT switch 1: This switch avoids the noise from the output of port 1 during the noise figure measurement. Controlled by RFOUT_N signal.

SPDT switch 2: This switch control the LO path in order to supply the different measurement

frequency for the noise measurements. The frequency f_1 is supplied to port 3 and the frequency f_2 is supplied to port 5. Controlled by NOISE_LO2 signal.

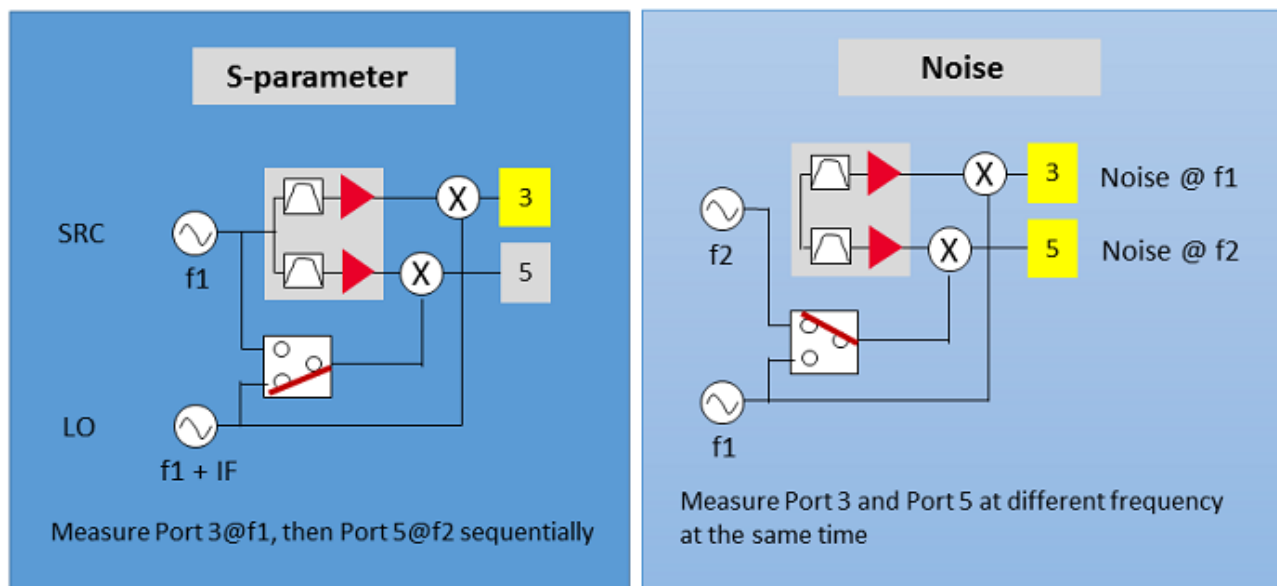

I/O Port Setup

The I/O port should be configured as follows in order to control the SPDT switches. Refer to RPHandler I/O Connector (M9485A).

Only the port 3 assignment is required to set. The other settings are default.

	PORT1	PORT2	PORT3	PORT4	PORT5	PORT6
I/O 1	READY FOR TRIGGER	SWEEP END	RFOUT_N	P3	N/A	N/A
Trig	EXTERNAL TRIGGER	INPUT 1	N/A	EXTERNAL TRIGGER	EXTERNAL TRIGGER	EXTERNAL TRIGGER
I/O 2	INDEX	OUTPUT1	NOISE_LO2	P4	SYNC	SYNC

File format example

3, RFOUT_N, , NOISE_LO2

Sequence

<p>Group 1 (Sweep 1)</p>	<p>Ch1: 1 GHz to 2 GHz</p> <p>Path: B1</p> <ul style="list-style-type: none"> • S31 • S33 • NF 1 to 3 	<p>Ch2: 5 GHz to 6 MHz</p> <p>Path: B3</p> <ul style="list-style-type: none"> • S51 • S55 • NF 1 to 5
<p>Group 2 (Sweep 2)</p>	<p>Ch3: 3 GHz to 4 GHz</p> <p>Path: B2</p> <ul style="list-style-type: none"> • S41 • S44 • NF 1 to 4 	<p>Ch2: 7 GHz to 8 GHz</p> <p>Path: B4</p> <ul style="list-style-type: none"> • S61 • S66 • NF 1 to 6

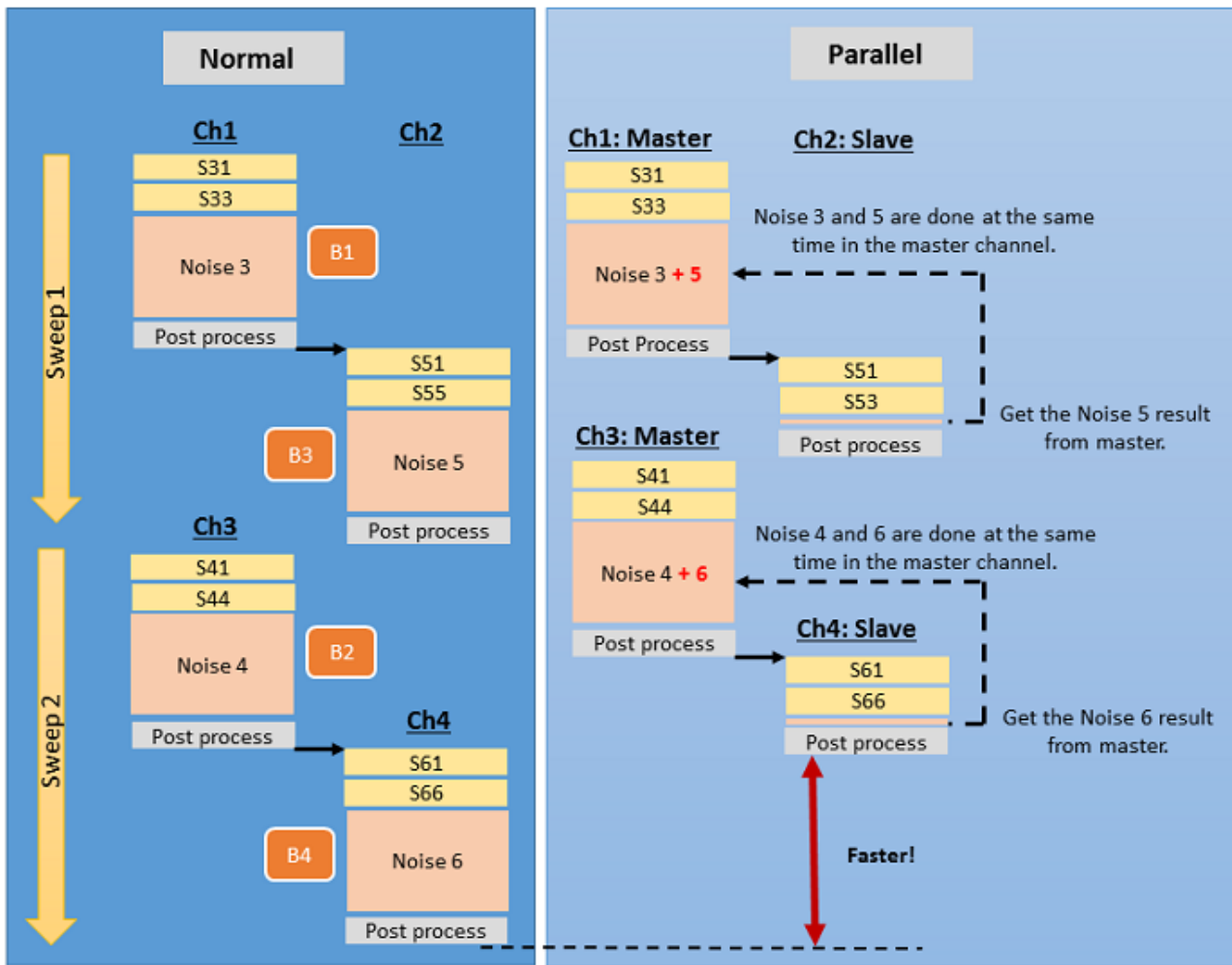

```
' Setup channels Ch1-S31, S33, NF and Ch2-S51, S55, NF for Group1.
```

```
SYST:PRES
```

```
CALC1:PAR:EXT "tr1","S31"
```

```
DISP:WIND1:TRAC1:FEED "tr1"
```

```
CALC1:PAR:EXT "tr2","S33"
```

```
DISP:WIND1:TRAC2:FEED "tr2"
```

```
CALC1:PAR:EXT "tr3","NF"
```

```
DISP:WIND1:TRAC3:FEED "tr3"
```

```
CALC2:PAR:EXT "tr4","S51"
```

```
DISP:WIND1:TRAC4:FEED "tr4"
```

```
CALC2:PAR:EXT "tr5","S55"
DISP:WIND1:TRAC5:FEED "tr5"
CALC2:PAR:EXT "tr6","NF"
DISP:WIND1:TRAC6:FEED "tr6"

' Setup channels Ch3-S41, S44, NF and Ch4-S61, S66, NF for Group1.
CALC3:PAR:EXT "tr7","S41"
DISP:WIND2:TRAC7:FEED "tr7"
CALC3:PAR:EXT "tr8","S44"
DISP:WIND2:TRAC8:FEED "tr8"
CALC3:PAR:EXT "tr9","NF"
DISP:WIND2:TRAC9:FEED "tr9"

CALC4:PAR:EXT "tr10","S61"
DISP:WIND2:TRAC10:FEED "tr10"
CALC4:PAR:EXT "tr11","S66"
DISP:WIND2:TRAC11:FEED "tr11"
CALC4:PAR:EXT "tr12","NF"
DISP:WIND2:TRAC12:FEED "tr12"

' Set channel coupling. Group1 has Ch1-2, Group2 has Ch3-4.
SYST:CHAN:NOIS:PAR:GROU 2,1,2,3,4
SYST:CHAN:COUP:STATE 1

' Set independent sweep settings for each groups.
SENS1:FREQ:START 1e9;STOP 2e9;
SENS2:FREQ:START 5e9;STOP 6e9;
SENS3:FREQ:START 3e9;STOP 4e9;
SENS4:FREQ:START 7e9;STOP 8e9;

' Turn on parallel measurement. First Ch1-2 sweeps at the same time. Then Ch3-4
```

sweeps .

SYST:CHAN:NOISe:PARAllel:ENABLe 1

Perform Multi DUT Parallel measurements

Small Signal Gain and Flatness

Small signal gain is the gain in the amplifier's linear region of operation. This is typically measured at a constant input power over a swept frequency. Gain flatness is the measure of the variation of gain over a specified frequency range.

- [What Is Gain?](#)
- [What Is Flatness?](#)
- [Why Measure Gain and Flatness?](#)
- [Accuracy Considerations](#)
- [How to Measure Gain and Flatness](#)

[See other Amplifier Parameter topics](#)

What Is Gain?

RF amplifier gain is defined as the difference in power between the amplifier output signal and the input signal. It is assumed that both input and output impedances of the amplifier are the same as the characteristic impedance of the system.

- Gain is called S_{21} using S-parameter terminology
- Gain is expressed in dB—a logarithmic ratio of the output power relative to the input power.
- Gain can be calculated by subtracting the input from the output levels when both are expressed in dBm, which is power relative to 1 milliwatt.
- Amplifier gain is most commonly specified as a minimum value over a specified frequency range. Some amplifiers specify both minimum and maximum gain, to ensure that subsequent stages in a system are not under or over driven.

What Is Flatness?

Flatness specifies how much the amplifier's gain can vary over the specified frequency range. Variations in the flatness of the amplifier's gain can cause distortion of signals passing through the amplifier.

Why Measure Small-Signal Gain and Flatness?

Deviations in gain over the bandwidth of interest will induce distortion in the transmitted signal because frequency components are not amplified equally. Small-signal gain allows you to quantify the amplifier's gain at a particular frequency in a 50-ohm system. Flatness allows you to view the deviations in the amplifier's gain over a specified frequency range in a 50-ohm system.

Accuracy Considerations

- The amplifier may respond very differently at various temperatures. The tests should be done when the amplifier is at the desired operating temperature.
- The output power of the amplifier should be sufficiently attenuated if necessary. Too much output power could:
 - damage the analyzer receiver
 - exceed the input compression level of the analyzer receiver, resulting in inaccurate measurements.

Attenuation of the amplifier's output power can be accomplished using:

- attenuators
- couplers

The frequency-response effects and mismatches of the attenuators and couplers must be accounted for during calibration since they are part of the test system. Proper error-correction techniques can reduce these effects.

- The frequency response is the dominant error in a small-signal gain and flatness measurement setup. Performing a thru-response measurement calibration significantly reduces this error. For greater accuracy, perform a 2-port measurement calibration.
- Reducing IF bandwidth or using averaging improves measurement dynamic range and accuracy, at the expense of measurement speed.

How to Measure Gain and Flatness

1. Preset the analyzer.
2. Select an S21 measurement parameter.
3. Set the analyzer's source power to be in the linear region of the amplifier's output response (typically 10-dB below the 1-dB compression point).

4. Select an external attenuator (if needed) so the amplifier's output power will be sufficiently attenuated to avoid causing receiver compression or damage to the analyzer's port-2.

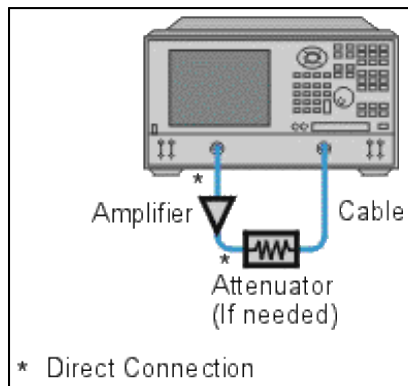

5. Connect the amplifier as shown in the following graphic, and provide the dc bias.
6. Select the analyzer settings for your amplifier under test.
7. Remove the amplifier and perform a measurement calibration. Be sure to include the attenuator and cables in the calibration setup if they will be used when measuring the amplifier.
8. Save the instrument-state to memory.
9. Reconnect the amplifier.
10. Scale the displayed measurement for optimum viewing and use a marker to measure the small signal gain at a desired frequency.
11. Measure the gain flatness over a frequency range by using markers to view the peak-to-peak ripple.
12. Print or save the data to a disk.

Gain Compression

Gain compression measures the level of input power applied to an amplifier that will cause a distorted output.

- [What Is Gain Compression?](#)
- [Why Measure Gain Compression?](#)
- [Accuracy Considerations](#)
- [How to Measure Gain Compression](#)

[See other Amplifier Parameter topics](#)

What Is Gain Compression?

Gain compression occurs when the input power of an amplifier is increased to a level that reduces the gain of the amplifier and causes a nonlinear increase in output power.

The analyzer has the ability to do power sweeps as well as frequency sweeps. Power sweeps help characterize the nonlinear performance of an amplifier. Refer to the graphic below (a plot of an amplifier's output power versus input power at a single frequency) for the following discussion.

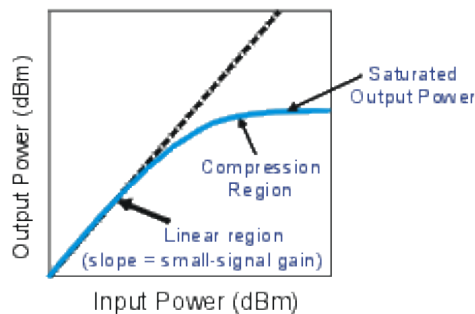

- The amplifier has a linear region of operation where gain is constant and independent of power level. The gain in this region is commonly referred to as "small-signal gain."
- As the input power increases, the amplifier gain appears to decrease, and the amplifier goes into compression.
- The most common measurement of amplifier compression is the 1-dB compression point. This is defined as the input power (or sometimes the output power) which results in a 1-dB decrease in amplifier gain (relative to the amplifier's small-signal gain).

Why Measure Gain Compression?

When driven with a sinusoid, the output of an amplifier is no longer sinusoidal in the compression region. Some of the amplifier output appears in harmonics, rather than occurring only at the fundamental frequency of the input signal.

As input power is increased even more, the amplifier becomes saturated, and output power remains constant. At this point, further increases in amplifier input power result in no change in output power.

In some cases (such as with TWT amplifiers), output power actually decreases with further increases in input power after saturation, which means the amplifier has negative gain.

Since gain is desired in amplifier operation, it is important to know the limit of input signal that will result in gain compression.

Accuracy Considerations

The network analyzer must provide sufficient power to drive the amplifier into saturation. If you need a higher input-power level than the source of the analyzer can provide, use a preamplifier to boost the power level prior to the amplifier under test. If using a preamplifier, you can increase measurement accuracy in the following ways:

- Use a coupler on the output of the preamplifier so that a portion of the boosted input signal can be used for the analyzer's reference channel. This configuration removes the preamplifier's frequency response and drift errors from the measurement (by ratioing).
- Perform a thru-response calibration including the preamplifier, couplers, and attenuators in the test setup.

The output power of the amplifier should be sufficiently attenuated if necessary. Too much output power could:

- Damage the analyzer receiver
- Exceed the input compression level of the analyzer receiver

Attenuation of the amplifier's output power can be accomplished using:

- Attenuators
- Couplers

The frequency-response effects of the attenuators and couplers must be considered during calibration since they are part of the test system. Proper error-correction techniques can reduce these effects.

- The frequency response is the dominant error in a gain compression measurement setup. Performing a thru-response measurement calibration significantly reduces this error.
- The amplifier may respond very differently at various temperatures. The tests should be done when the amplifier is at the desired operating temperature.
- Reducing IF bandwidth or using measurement averages improves accuracy, at the expense of measurement speed.

How to Measure Gain Compression

This procedure shows you how to make the following three measurements used to determine amplifier gain compression:

1. A **Swept-Frequency Gain Compression** measurement locates the lowest frequency at which the 1-dB gain compression first occurs.
2. A **Swept-Power Gain Compression** measurement shows the input power at which a 1-dB drop in gain occurs as a power ramp is applied to the amplifier at a particular frequency point (found in measurement 1).
3. An **Absolute Power** measurement shows the absolute power out (in dBm) at compression.

Swept-Frequency Gain Compression Measurement

A measurement of swept frequency gain compression locates the frequency point where 1-dB compression first occurs.

1. Preset the analyzer.
2. Select an S₂₁ measurement parameter.
3. Set the analyzer's source power to be in the linear region of the amplifier's output response (typically 10-dB below the 1-dB compression point).
4. Select an external attenuator (if needed) so the amplifier's output power will be sufficiently attenuated to avoid causing receiver compression or damage to the analyzer's port-2.
5. Connect the amplifier as shown in the following graphic, and provide the dc bias.
6. Select the analyzer settings for your amplifier under test. To reduce the effects of noise, you may want to specify a narrower IF bandwidth.

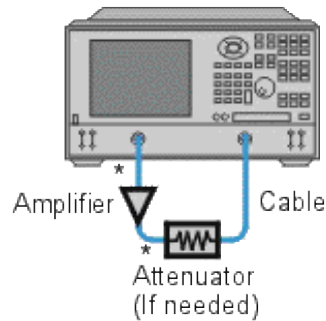

* Direct Connection

7. Remove the amplifier and perform a thru-response calibration. Be sure to include the attenuator and cables in the calibration setup if they will be used when measuring the amplifier.
8. Save the instrument-state to memory.
9. Reconnect the amplifier.
10. Position a marker at approximately mid-span.
11. Adjust the analyzer's scale to 1 dB per division.
12. Store the trace in memory and display Data/Mem.
13. Gradually increase the source power until a 1-dB decrease in gain is observed at the first frequency over some portion of the trace.
14. Use markers to locate the frequency where the 1-dB decrease in gain first occurs. Note this frequency for use in the following measurement.
15. Print the data or save it to a disk.

Swept-Power Gain Compression Measurement

A swept-power gain compression measurement shows the input power resulting in a 1-dB drop in gain as a power ramp at a particular frequency (found in step 13 of the previous measurement) is applied to the amplifier.

1. If not already done, perform the previous measurement of swept-frequency gain compression.
2. Setup an S_{21} measurement in the power-sweep mode. Include the following settings:
 - o Set the CW frequency to the frequency noted in step 14 of the previous measurement of swept-frequency gain compression.

- o Enter the start and stop power levels for the sweep. The start power should be in the linear region of the amplifier's response (typically 10 dB below the 1-dB compression point). The stop power should be in the compression region of the amplifier's response.
3. Adjust the scale to 1-dB per division.
 4. Use markers (including reference marker) to find the input power where the 1-dB decrease in gain occurs.
 5. Print the data or save it to a disk.

Absolute Output Power Measurement

An absolute-power measurement shows the absolute power-out (in dBm) of the amplifier at compression.

1. Select an unratiod (absolute) power measurement. Choose the B input if using the test setup in the previous graphic.
2. Retain the CW frequency used in the previous measurement of swept-power gain compression.
3. Set a marker to the input power level where the 1-dB decrease in gain occurs (found in step 4 of the previous measurement).
4. Scale the displayed measurement for optimum viewing.
5. Read the marker value to find the absolute output power of the amplifier (in dBm) where the 1-dB decrease in gain occurs.
6. Print the data or save it to a disk.

Note: The measurement calibration does not apply to absolute power. Therefore, if there is any attenuation external to the analyzer, you will have to correct for it manually.

Group Delay

Group delay is a measure of phase distortion. Group delay is the actual transit time of a signal through a device under test as a function of frequency. When specifying group delay, it is important to specify the aperture used for the measurement.

- [What is Group Delay?](#)
- [Group Delay versus Deviation from Linear Phase](#)
- [What Is Aperture?](#)
- [Accuracy Considerations](#)
- [How to Measure Group Delay](#)

See also [Comparing the Delay Functions](#).

[See other Amplifier Parameter topics](#)

What Is Group Delay?

Group delay is:

- A measure of device phase distortion.
- The transit time of a signal through a device versus frequency.
- The derivative of the device's phase characteristic with respect to frequency.

Refer to the graphic below for the following discussion:

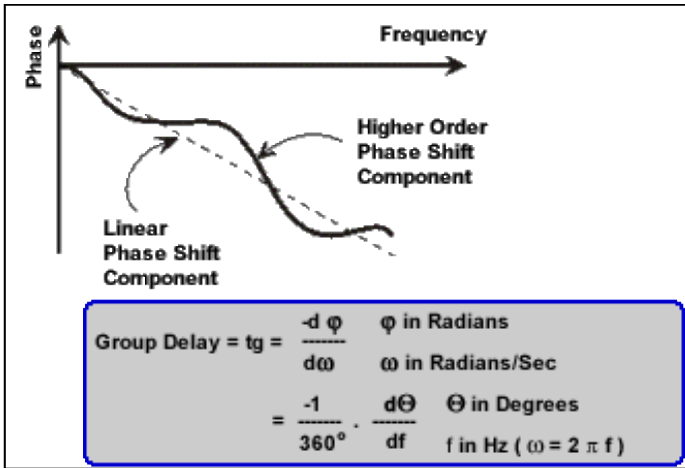

The phase characteristic of a device typically consists of both linear and higher order (deviations from linear) phase-shift components.

Linear phase-shift component:	Higher-order phase-shift component:
Represents average signal transit time.	Represents variations in transit time for different frequencies.
Attributed to electrical length of test device.	Source of signal distortion.

Refer to the graphic below for the following discussion:

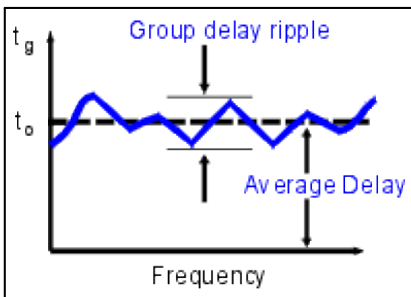

In a group delay measurement:

- The linear phase shift component is converted to a constant value (representing the average delay).
- The higher order phase shift component is transformed into deviations from constant group delay (or group delay ripple).
- The deviations in group delay cause signal distortion, just as deviations from linear phase cause distortion.
- The measurement trace depicts the amount of time it takes for each frequency to travel through the device under test.

Refer to the following equation for this discussion on how group delay is calculated:

$$\text{Group Delay} = \tau_g = \frac{-d\phi}{d\omega}$$

$$= \frac{-1}{360^\circ} \cdot \frac{d\Theta}{df}$$

ϕ in Radians
 ω in Radians/Sec
 Θ in Degrees
 f in Hz ($\omega = 2\pi f$)

- Phase data is used to find the phase change (-dφ).
- A specified frequency aperture is used to find the frequency change (dω).
- Using the two values above, an approximation is calculated for the rate of change of phase with frequency.
- This approximation represents group delay in seconds (assuming linear phase change over the specified frequency aperture).

Group Delay versus Deviation from Linear Phase

Group delay is often a more accurate indication of phase distortion than **Deviation from Linear Phase**.

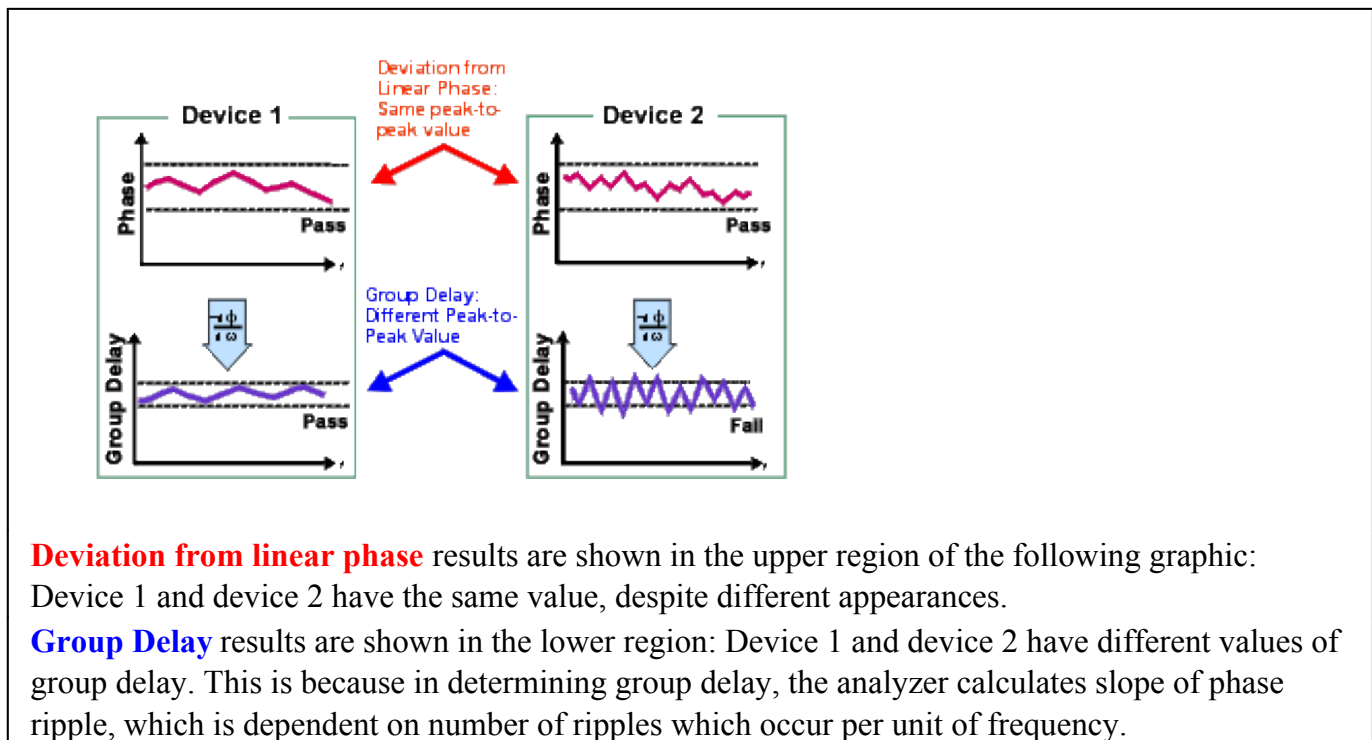

What Is Aperture?

During a group delay measurement, phase is measured at two closely spaced frequencies and then computes the phase slope. The frequency interval (frequency delta) between the two phase measurement points is called the aperture. Changing the aperture can result in different values of group

delay. The computed slope ($-\Delta\phi / \Delta f$) varies as the aperture is increased. This is why when you are comparing group delay data, you must know the aperture that was used to make the measurements.

Refer to the graphic below for the following discussion:

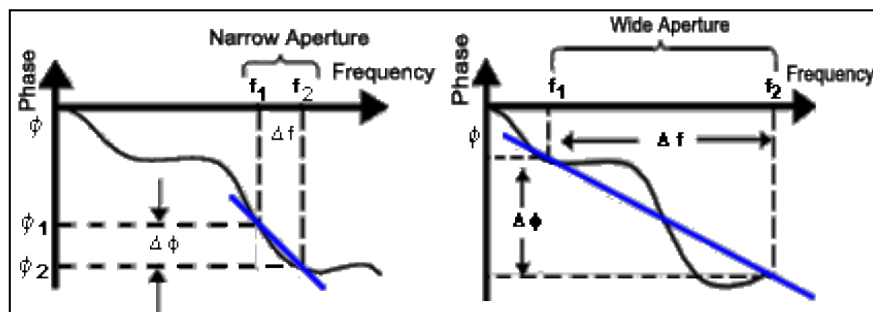

Narrow aperture:	Wide aperture:
Provides more detail in phase linearity.	Provides less detail in phase linearity because some phase response averaged-out or not measured.
Makes measurement susceptible to noise (smaller signal-to-noise ratio) and phase detector resolution.	Makes measurement less susceptible to noise (larger signal-to-noise ratio).

Group delay measurements can be made using the following sweep types:

- Linear frequency
- List frequency sweep segment - The group delay aperture varies depending on the frequency spacing and point density. Therefore the aperture is not constant in segment sweep. In segment sweep, extra frequency points can be defined to ensure the desired aperture.

How to set Group Delay Aperture

Using Hardkey/SoftTab/Softkey

1. Press **Format** > **Format 1** > **Group Delay Aperture...**

Using a mouse

1. Click **Response**
2. Select **Format**
3. Select **Group Delay Aperture**

Programming Commands

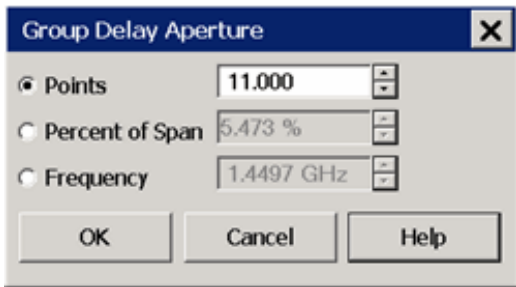

Group Delay Aperture dialog box help

Although the Group Delay Aperture is defined as the difference in frequency between two data points (see [What Is Aperture?](#)), the group delay calculation can be averaged over many adjacent data points, similar to the smoothing feature. The number of adjacent data points can be set using any of the following methods:

Note: You can change the default Group Delay Aperture to two points using a Preference. [Learn how.](#)

Points Number of adjacent data points to average. Default setting is 11 points. Choose a value between 2 and the current number of points in the channel.

Percent of Span The data points within this percentage of the current frequency span are averaged. Choose a value between (2 points / current number of points) and 100 percent. The span must contain at least two data points.

Frequency The data points within this frequency range are averaged. The frequency range must contain at least two data points.

When the frequency span or number of points is reduced so that the current Group Delay Aperture is NOT attainable, the Aperture is adjusted to the new frequency span or number of points.

OK Applies setting changes and closes the dialog box.

Cancel Closes the dialog. Setting changes are NOT applied.

Accuracy Considerations

It is important to keep the phase difference between two adjacent measurement points less than 180° (see the following graphic). Otherwise, incorrect phase and delay information may result. Undersampling may occur when measuring devices with long electrical length. You can verify that the phase difference measured between two adjacent points is less than 180° by adjusting the following settings until the measurement trace no longer changes:

- Increase the number of points
- Narrow the frequency span

Electrical delay may also be used to compensate for this effect.

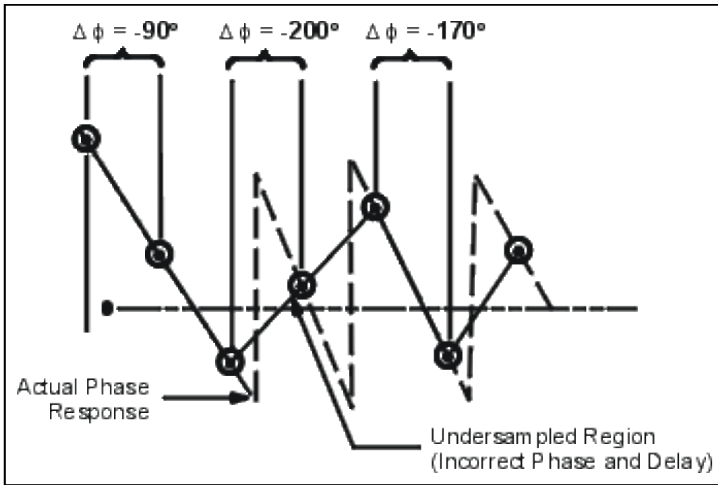

The frequency response is the dominant error in a group delay test setup. Performing a thru-response measurement calibration significantly reduces this error. For greater accuracy, perform a 2-port measurement calibration.

Particularly for an amplifier, the response may vary differently at various temperatures. The tests should be done when the amplifier is at the desired operating temperature.

How to Measure Group Delay

1. Preset the analyzer.
2. If your DUT is an amplifier, it may be necessary to adjust the source power:
 - o Set the source power to be in the linear region of the amplifier's output response, typically 10 dB below the 1 dB compression point.
 - o If needed, use an external attenuator so the amplifier output power will be sufficiently attenuated to avoid causing receiver compression or damage to test port 2.
3. Connect the DUT as shown in the following graphic.

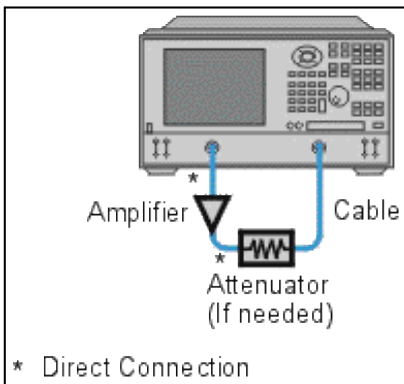

4. Select an S21 measurement.
 5. Select the settings for your DUT:
 - o frequency range
 - o number of measurement points.
 - o format: delay
 - o scale: autoscale
 6. Remove the DUT and perform a measurement calibration.
 7. Reconnect the DUT.
 8. Scale the displayed measurement for optimum viewing.
 9. Use the Group Delay Aperture setting to increase the aperture, reducing noise on the trace while maintaining meaningful detail.
 10. Use the markers to measure group delay (expressed in seconds) at a particular frequency of interest.
 11. Print the data or save it to a disk.
-

High-Gain Amplifier Measurements

When measuring High-Gain Amplifiers, errors in measuring any of the S-parameters during calibration can result in error in the S21 measurement. This is because all the S-parameters are used in the error correction math.

A particular problem occurs with high gain amplifiers because the source power is set very low. Thus, when making reverse measurements (S22, S12) the signal-to-noise is poor and the raw measurements can be dominated by noise. This noise in the raw measurements will result in a noisy trace appearing for corrected S21 or S11.

If you are using a large attenuator on port 2 (which improves output match), perform an Enhanced Response Calibration as follows. This corrects for the same errors as the full 2-port correction EXCEPT the interaction between the raw load match and the DUT output match.

1. There is NO need to Uncouple the port powers.
2. Set port powers to an acceptable level. Do NOT overpower the test port.
3. Perform Enhanced Response Cal. [Learn how](#). (Does not measure or correct for S12 or S22 port match).

If you want to do a full correction (for example, when your amplifier output match is poor so the Enhanced Response Cal above is not adequate), then...

1. Uncouple the port powers. [Learn how](#).
2. Set input (port 1) power to approximately the output power of the amplifier up to 0 dBm
3. Set reverse (port 2) power to the same power (for measuring isolation and S22)
4. Perform a Full 2-port Cal.
5. Re-set the input power (port 1) to a lower power level appropriate for driving the amplifier.

Additional Error due to Mismatch of DUT Output Match and Raw Load Match

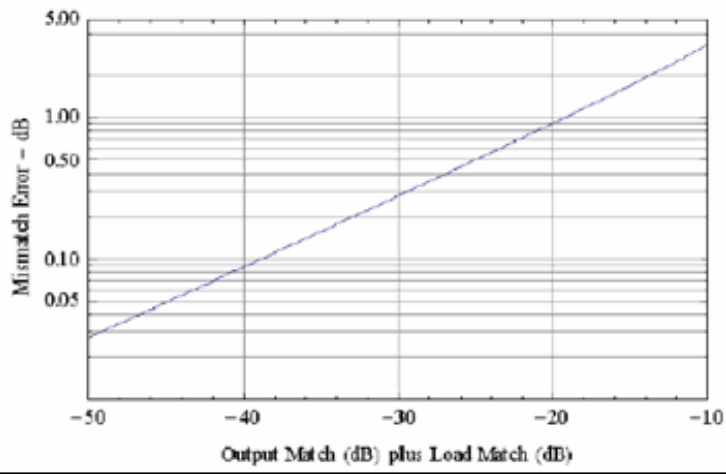

Phase Measurements

Knowledge of both magnitude and phase characteristics is needed for successful higher-level component integration.

- [What are Phase Measurements?](#)
- [Why Measure Phase?](#)
- [Using the Analyzer's Phase Format](#)
- [Types of Phase Measurements](#)

[See other Tutorials](#)

What are Phase Measurements?

Phase measurements are made using S-parameters, just like amplitude measurements. A phase measurement is a relative (ratio) measurement and not an absolute measurement. Phase measurements compare the phase of the signal going into a device (the incident signal) to the phase of the device's response signal. The response signal can be either reflected or transmitted. Assuming an accurate calibration has been performed, the difference in phase between the two signals (known as phase shift) is a result of the electrical characteristics of the device under test.

The following graphic shows the phase shift (in time or degrees) between an incident signal and a transmitted signal (as might be seen on an oscilloscope display).

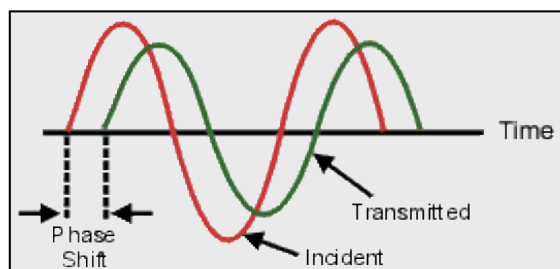

Why Measure Phase?

Measuring phase is a critical element of network analysis. The following graphic lists five reasons for measuring both magnitude and phase.

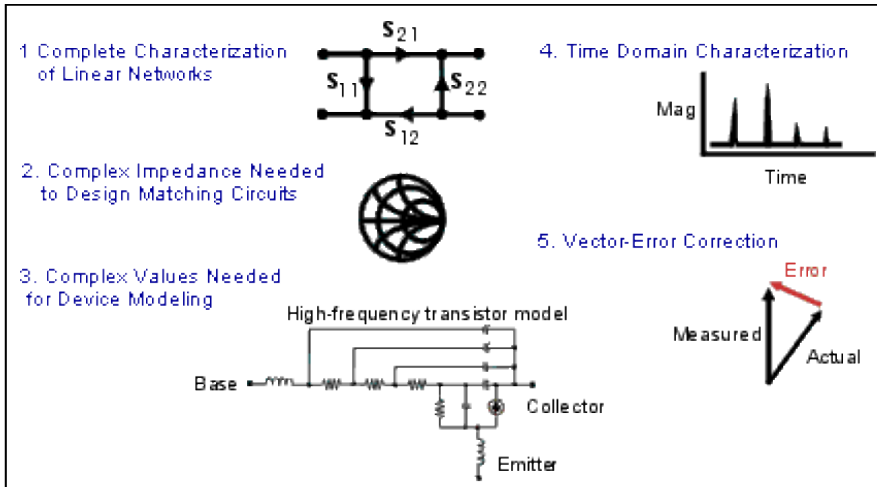

When used in communications systems to pass signals, components or circuits must not cause excessive signal distortion. This distortion can be:

- Linear, where flat magnitude and linear phase shift versus frequency is not maintained over the bandwidth of interest.
- Nonlinear, such as AM-to-PM conversion.

It is important to measure how reflective a component or circuit is, to ensure that it transmits or absorbs energy efficiently. Measuring the complex impedance of an antenna is a good example.

Using the Analyzer's Phase Format

The analyzer's phase format displays a phase-versus-frequency or phase-versus-power measurement. The analyzer does not display more than ± 180 degrees phase difference between the reference and test signals. As the phase value varies between $+180$ degrees and -180 degrees, the analyzer display creates the sawtooth pattern as shown in the following graphic.

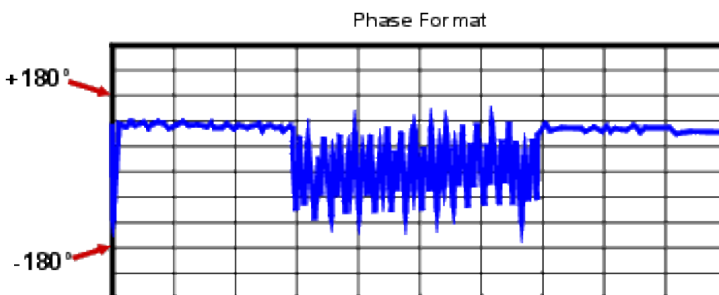

The sawtooth pattern does not always reach $+180$ degrees and -180 degrees. This is because the measurement is made at discrete frequencies, and the data point at $+180$ degrees and -180 degrees may not be measured for the selected sweep.

Types of Phase Measurements

- **Complex impedance** data is information such as resistance, reactance, phase, and magnitude that can be determined from an S11 or S22 measurement. Complex impedance data can be viewed using either the Smith Chart format or the Polar format.
- **AM-to-PM conversion** is a measure of the amount of undesired phase deviation (PM) that is caused by amplitude variations (AM) of the system. AM-to-PM conversion is usually defined as the change in output phase for a 1-dB increment in the input power to an amplifier (i.e. at the 1 dB gain compression point). This is expressed in degrees-per-dB ($^{\circ}/\text{dB}$).
- **Deviation from linear phase** is a measure of phase distortion caused by a device. Ideally, the phase shift through a device is a linear function of frequency. The amount of variation from this theoretical phase shift is known as its deviation from linear phase (also called phase linearity).
- **Group delay** is another way to look at phase distortion caused by a device. Group delay is a measure of transit time through a device at a particular frequency. The analyzer computes group delay from the derivative of the measured phase response.

Deviation from Linear Phase Versus Group Delay

Although deviation from linear phase and group delay are similar measurements, they each have their purpose.

The following are the advantages of deviation from linear phase measurements:

- Less noisy than group delay.
- Able to characterize devices that pass phase modulated signals, and show units of phase rather than units of seconds.

The following are the advantages of group delay measurements:

- More easily interpreted indication of phase distortion than deviation from linear phase.
- Able to most accurately characterize a device under test. This is because in determining group delay, the analyzer calculates the slope of the phase ripple, which is dependent on the number of ripples which occur per unit of frequency. Comparing two phase responses with equal peak-to-peak phase ripple, the response with the larger phase slope results in:
 - More group delay variation.
 - More signal distortion.

See also [Comparing the Analyzer Delay Functions](#).

Reverse Isolation

Reverse isolation is a measure of amplifier reverse transmission response- from output to input.

- [What is Reverse Isolation](#)
- [Why Measure Reverse Isolation?](#)
- [Accuracy Considerations](#)
- [How to Measure Reverse Isolation](#)

See other Tutorials

What is Reverse Isolation?

Reverse isolation is a measure of how well a signal applied to the device output is "isolated" from its input.

The measurement of reverse isolation is similar to that of forward gain, except:

- The stimulus signal is applied to the amplifier's output port.
- The response is measured at the amplifier's input port.

The equivalent S-parameter is S_{12} .

Why Measure Reverse Isolation?

An ideal amplifier would have infinite reverse isolation-no signal would be transmitted from the output back to the input. However, reflected signals can pass through the amplifier in the reverse direction. This unwanted reverse transmission can cause the reflected signals to interfere with the desired fundamental signal flowing in the forward direction. Therefore, reverse isolation is important to quantify.

Accuracy Considerations

Since amplifiers often exhibit high loss in the reverse direction, generally there is no need for any attenuation that may have been used to protect the port 2 receiver during forward transmission measurements. Removing the attenuation will:

- Increase the dynamic range, resulting in improved measurement accuracy.
- Require a new calibration for maximum accuracy.

The RF source power can be increased to provide more dynamic range and accuracy.

Note: With the attenuation removed and the RF source power increased, a forward sweep could damage the analyzer's port 2 receiver. Do not perform a forward sweep or use 2-port calibration unless the forward power is set low enough to avoid causing port 2 receiver compression or damage.

If the isolation of the amplifier under test is very large, the transmitted signal level may be near the noise floor or crosstalk level of the receiver. To lower the noise floor:

- Use or increase measurement averages.
- Reduce the IF bandwidth of the analyzer.

Note: Reducing IF bandwidth or using averaging improves measurement dynamic range and accuracy, at the expense of reduced measurement speed.

- When crosstalk levels affect the measurement accuracy, reduce the crosstalk error term by performing a response and isolation calibration. When performing the isolation part of the calibration it is important to use the same average factor and IF bandwidth during the calibration and measurement.
- The frequency response of the test setup is the dominant error in a reverse isolation measurement. Performing a thru-response measurement calibration significantly reduces this error. This calibration can be done as part of the response and isolation calibration.
- The amplifier may respond very differently at various temperatures. The tests should be done when the amplifier is at the desired operating temperature.

How to Measure Reverse Isolation

1. Connect the amplifier as shown in the following graphic.

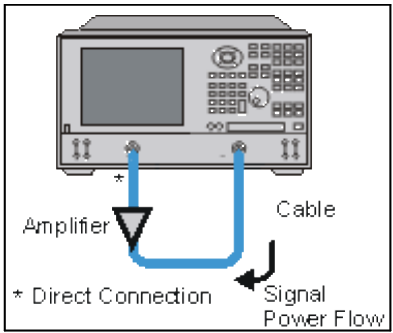

2. Preset the analyzer.
3. Select an S12 measurement.
4. Select the settings for your amplifier under test.
5. Remove the amplifier and perform a thru-response calibration or a response and isolation calibration.
6. Scale the displayed measurement for optimum viewing and use a marker to measure the reverse isolation at a desired frequency.
7. Print or save the data to a disk.

Reflection Measurements

Reflection measurements are an important part of network analysis.

- [What are Reflection Measurements?](#)
- [Why Make Reflection Measurements?](#)
- [Expressing Reflected Waves](#)
 - [Return Loss](#)
 - [VSWR](#)
 - [Reflection Coefficient](#)
 - [Impedance](#)
 - [Summary of Expressions](#)

[See other Tutorials](#)

What are Reflection Measurements?

To understand reflection measurements, it is helpful to think of traveling waves along a transmission line in terms of a lightwave analogy. We can imagine incident light striking some optical component like a clear lens. Some of the light is reflected off the surface of the lens, but most of the light continues on through the lens. If the lens had mirrored surfaces, then most of the light would be reflected and little or none would be transmitted.

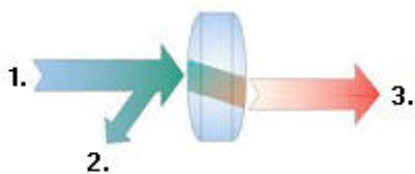

1. Incident 2. Reflected 3. Transmitted

With RF energy, reflections occur when the impedance of two mated devices are not the same. A reflection measurement is the ratio of the reflected signal to the incident signal. Network analyzers measure the incident wave with the R (for reference) channel and the reflected wave with the A channel. Therefore, reflection is often shown as the ratio of A over R (A/R). We can completely quantify the reflection characteristics of our device under test (DUT) with the amplitude and phase

information available at both the A and R channel. In S-parameter terminology, S11 is a reflection measurement of port1 of the device (the input port); S22 is a reflection measurement of the port 2 (the output port)

Why Make Reflection Measurements?

One reason we make reflection measurements to assure efficient transfer of RF power. We do this because:

1. RF energy is not cheap. When energy is reflected, that means less energy is transmitted to where it is intended to go.
2. If the reflected energy is large, it can damage components, like amplifiers.

For example, in the following graphic, the radio station on the left is not operating at peak efficiency. The amplifier impedance is not the same as the transmission line, and the transmission line impedance is not the same as the antenna. Both of these conditions cause high reflected power. This condition results in less transmitted power, and the high reflected power could damage the amplifier.

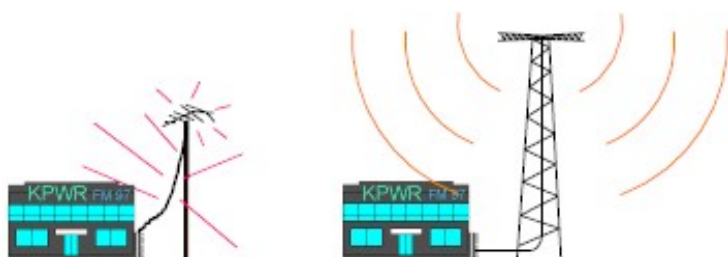

The radio station on the right installed properly "matched" transmission line and antenna. Very little of the transmitted signal is reflected, resulting in increased broadcast power, more listeners, more advertising revenue, and more profit. The amplifier, transmission, and antenna all need to be measured to ensure that reflected power is minimized.

Expressing Reflected Waves

After making a reflection measurement, the reflection data can be expressed in a number of ways, depending on what you are trying to learn. The various expressions are all calculated by the analyzer from the same reflection measurement data. Each method of expressing reflection data can be graphically displayed in one or more formats. For more information, see display formats.

Return Loss

The easiest way to convey reflection data is return loss. Return loss is expressed in dB, and is a scalar (amplitude only) quantity. Return loss can be thought of as the absolute value or dB that the reflected signal is below the incident signal. Return loss varies between infinity for a perfect impedance match

and 0 dB for an open or short circuit, or a lossless reactance. For example, using the log magnitude format on the analyzer, the measured reflection value on the screen may be -18dB. The minus sign is ignored when expressing return loss, so the component is said to have 18dB of return loss.

VSWR

Two waves traveling in opposite directions on the same transmission line cause a "standing wave". This condition can be measured in terms of the voltage standing wave ratio (VSWR or SWR for short). VSWR is defined as the maximum reflected voltage over the minimum reflected voltage at a given frequency. VSWR is a scalar (amplitude only) quantity. VSWR varies between one for a perfect match, and infinity for an open or short circuit or lossless reactance.

Reflection Coefficient

Another way of expressing reflection measurements is reflection coefficient gamma (Γ). Gamma includes both magnitude and phase.

The magnitude portion of gamma is called rho (ρ). Reflection coefficient is the ratio of the reflected signal voltage to the incident signal voltage. The range of possible values for ρ is between zero and one. A transmission line terminated in its characteristic impedance will have all energy transferred to the load; zero energy will be reflected and $\rho = 0$. When a transmission line terminated in a short or open circuit, all energy is reflected and $\rho = 1$. The value of rho is unitless.

Now for the phase information. At high frequencies, where the wavelength of the signal is smaller than the length of conductors, reflections are best thought of as waves moving in the opposite direction of the incident waves. The incident and reflected waves combine to produce a single "standing" wave with voltage that varies with position along the transmission line.

When a transmission line is terminated in its characteristic impedance (Z_0) there is no reflected signal. All of the incident signal is transferred to the load, as shown in the following graphic. There is energy flowing in one direction along the transmission line.

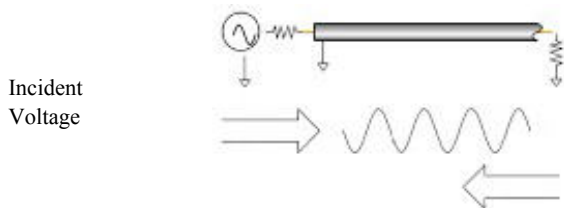

Z_0

Reflected Voltage = 0

(All the incident power is absorbed in the load)

When a transmission line is terminated in a short circuit termination, all of the energy is reflected back to the source. The reflected wave is equal in magnitude to the incident wave ($\rho = 1$). The voltage across any short circuit is zero volts. Therefore, the voltage of the reflected wave will be 180 degrees out of phase with the incident wave, canceling the voltage at the load.

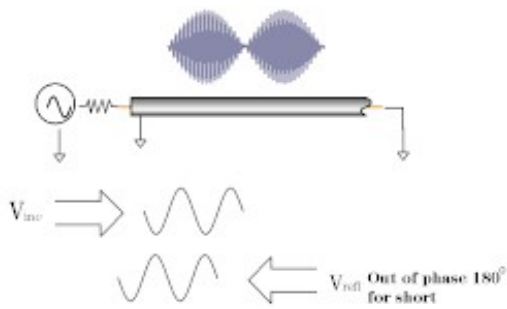

When a transmission line is terminated in an open circuit termination, all of the energy is reflected back to the source. The reflected wave is equal in magnitude to the incident wave ($\rho = 1$). However, no current can flow in an open circuit. Therefore, the voltage of the reflected wave will be in phase with the voltage of the incident wave.

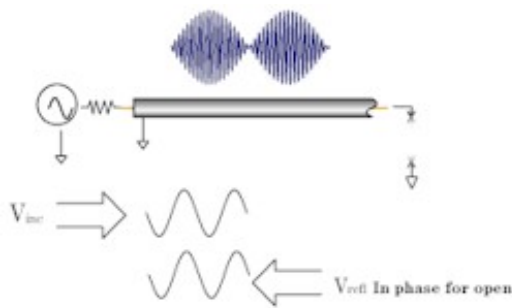

When a transmission line is terminated in a 25 ohm resistor, some but not all of the incident energy will be absorbed, and some will be reflected back towards the source. The reflected wave will have an amplitude 1/3 that of the incident wave and the voltage of the two waves will be out of phase by 180 degrees at the load. The phase relationship will change as a function of distance along the transmission line from the load. The valleys of the standing wave pattern will no longer go to zero, and the peaks will be less than that of the open / short circuit.

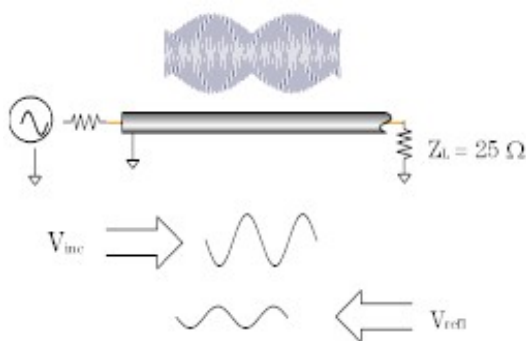

For more information, see [Phase Measurements](#).

Impedance

Impedance is another way of expressing reflection data. For more information on Impedance, see [Smith Charts](#).

Summary of the Expressions of Reflection Measurements:

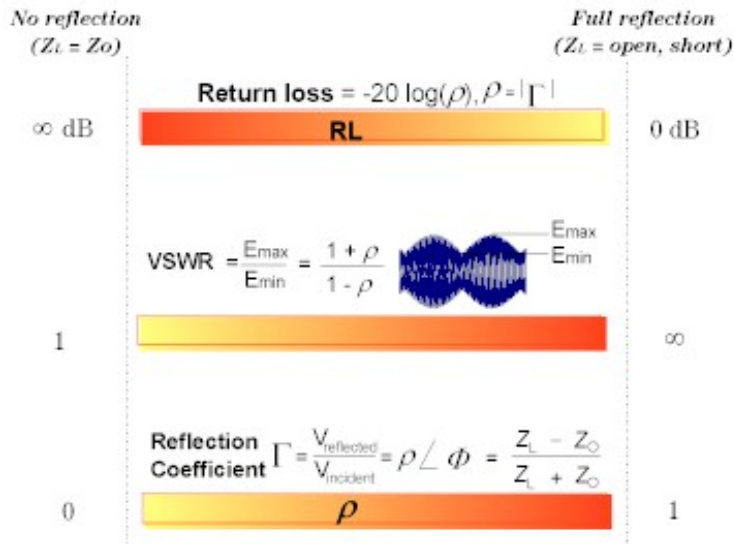

Avg BW

Standard

GCA

NF

Cal

Standard Cal

Gain Compression and Gain Compression Converters Cal

Noise Figure Cold Source and Noise Figure Converters Cal

Scalar Mixer/Converter Cal

Spectrum Analyzer Cal

Channel

Channel 1-8

- Channel 1-8

Channel Setup

- Select
- Meas Class...
- Add Channel
- Copy Channel
- Delete Channel

Display

Window 1-8

- Windows 1-8

Window Setup

- Select: *Select the desired window.*
- Window Title...
- Add Window
- Delete Window
- Move Window...
- Window Layout

Sheet Setup

- Select
- Sheet Title...
- Add Sheet
- Delete Sheet
- Sheet Layout

Display Setup

- Trace Maximize
- Window Max
- Show Table
- Customize Display...
- Display Update

Format

Format 1

- Log Mag
- Lin Mag
- Phase
- Delay
- Smith
- Polar
- SWR
- Group Delay Aperture...

Format 2

- Real
- Imaginary
- Unwrapped Phase
- Positive Phase
- Inverted Smith

Freq

Standard

Gain Compression

Noise Figure Cold Source

Scalar Mixer/Converter

Macro

Favorite1-3

- [Macro Setup...](#)

To Add a Favorite, press and hold any softkey for three seconds and select the desired Favorite number (Favorite 1 to 3).

Macro1-3

To Add a Macro, refer to [Using Macros](#).

Key Setup

- [Macro Setup...](#)
- Clear Favorites : *Clear all favorites items*

Marker

Marker 1-7

- Marker 1 to 7
- Reference

Marker 8-15

- Market 8 to 15

Marker Setup

- Delta
- Discrete
- Type
- Format
- Coupled
- Marker Display...
- Marker Table
- All Off

Marker -> Functions

- Marker -> Start
- Marker -> Stop
- Marker -> Center
- Marker -> Span
- Marker -> Ref Level
- Marker -> Delay
- Marker -> CW Freq

Math

Memory

- Data -> Memory
- Normalize
- Data Math
- Display
- 8510 Mode
- Interpolate

Analysis

- Conversions
- Equation Editor...
- Statistics...
- Limits...
- Limit Table

Time Domain

- Transform
- Start Time
- Stop Time
- Center Time
- Span Time
- TD Mode
- TD Toolbar
- Time Domain Setup...

Time Gating

- Gating
- Gate Start
- Gate Stop
- Gate Center
- Gate Span
- Gate Type
- Gate Shape
- Gating Setup...

Meas

Standard

Gain Compression

Noise Figure Cold Source

Scalar Mixer/Converter

Power

Standard

Gain Compression and Gain Compression Converters

Noise Figure Cold Source and Noise Figure Converters

Scalar Mixer/Converter

Preset

Main

- [Preset](#)
- [User Preset ...](#)
- [Confirm Preset](#)

Save Recall

Recall

- Recall State
- Recall State
- Recall State...
- Recall Register
- Recall Calset...
- Recall Data...
- Recall Order

Save State

- Save State
- Auto Save
- Save State As...
- Save Register
- Save Type
- Delete State

Save Other

- Save Calset...
- Save Data...
- Save Screen...
- Save User Preset...
- Manage Files...

Scale

Main

- Autoscale
- Autoscale All
- Scale
- Reference Level
- Reference Position
- Scale Coupling

Electrical Delay

- Delay Time
- Delay Distance
- Distance Units
- Velocity Factor
- Media
- Wavegd Cutoff

Constants

- System Z0
- Phase Offset
- Mag Offset
- Mag Slope

Search

Main

- Max Search
- Min Search
- Domain
- Domain Start
- Domain Stop
- Tracking

Peak

- Peak Search
- Peak Right >> Search
- << Peak Left Search
- Next Peak Search
- Threshold
- Excursion
- Peak Polarity
- Tracking

Target

- Target Search
- Target Right >> Search
- << Target Left Search
- Target Value
- Transition
- Tracking

Multi Peak & Target

- Multi Peak Search
- Peak Threshold
- Peak Excursion
- Peak Polarity
- Multi Target Search
- Target Value
- Transition
- Tracking

Bandwidth & Notch

- Bandwidth Search
- BW Ref To
- BW Level
- Notch Search
- Notch Ref To
- Notch Level
- Tracking

Comp & Sat

- Compression Search
- Comp Level
- Saturation Search
- Pmax Backoff
- Tracking

Normal Op Pt

- Normal OP Search
- Backoff
- Pin Offset
- Tracking

Setup

Standard

Gain Compression and Gain Compression Converters

Noise Figure Cold Source

Scalar Mixer/Converter + Phase and Vector Mixer/Converter

Spectrum Analyzer

Sweep

Standard

Gain Compression and Gain Compression Converters

Noise Figure Cold Source and Noise Figure Converters

Scalar Mixer/Converter

System

Main

- Show Taskbar: *Show the Windows Taskbar*
- Move App to Back
- Minimize Application
- Exit: *Exit the VNA application*
- Security...
- Control Panel... : *Open Windows Control Panel*
- Manage Files... : *Open Windows File Explore*

System Setup

- Next/Prev Keys : *Select Next/Previous window/channel/trace for the selected one*
- Preferences...
- Remote Interface...

Print

- Print...
- Print to File...
- Page Setup...
- Print Colors...

Help

- NA Help...
- On The Web... : *Connect to the Web on the keysight.com.*
- Error Display...

- [View Error Log...](#)
- [About NA...](#)

Service

- [Update Firmware](#)
- [Verification](#)
 - [Operator's Check](#)
 - [System Power Cal... \(M948xA only\)](#)
 - [System Verification](#)
- [Diagnostics](#)
 - [Receiver Temperature](#)
- [Option Enable](#)

Trace

Trace 1- 7/ 8-15

- Trace 1-15
- New Traces...

Trace Setup

- Select
- Measure
- Trace Title...
- Add Trace
- Delete Trace
- Trace Manager (Move Trace...)
- Trace Hold

Trigger

Main

- Hold
- Single
- Groups
- Continuous
- Manual Trigger
- Restart
- Trigger Source
- Trigger...

Undo

Main

- [Undo](#)
- [Redo](#)
- [Return To Task](#)
- [Clear Undo History](#)

Glossary

A B C D E F G H I J K L M
N O P Q R S T U V W X Y Z

12-Term Error Correction See [Error Correction, 12-Term](#).

1-Port Device A device with a single connector or path to the device's circuitry. Examples include an oscillator and a load.

2-Port Calibration, Full See [Error Correction, 12-Term](#).

2-Port Device A device with two connectors or other paths to the device's circuitry. Examples include filters, SAW devices, attenuators, matching pads, and amplifiers.

3-Term Error Correction See [Error Correction, 3-Term](#).

A

Active Channel The highlighted channel affected by front panel functions.

Active Function Readout The area of a display screen where the active function and its state are displayed. The active function is the one that was completed by the last key selection or remote programming command.

Active Hot Parameters (Option S9311xA/B) Measures the optimum Gamma that provides the maximum delivered power for nonlinear devices.

Active Marker The marker on a trace that can be repositioned either by front panel controls or by programming commands.

Active Trace A trace that is being swept (updated) with incoming signal information.

ADC Analog to Digital Converter

Address The identification (represented by a name, label, or number) for a register, location in storage, or any other data source or destination. Examples are the location of a station in a communications network, or a device on the GP-IB.

ADM Add-Drop Multiplexer

Admittance (Y) The inverse of an impedance (i.e. the ratio of current to voltage). Complex

admittances take the form $Y = G + jB(t)$.

ALC Automatic Level Control. See [Automatic Gain Control](#).

AM Amplitude Modulation

AM Group Delay A technique for the measurement of group delay through a device which utilizes an amplitude modulated (AM) source. Note: The actual delay of the modulation envelope is measured directly with an external scalar detector. Devices that distort the amplitude of a signal cannot be measured. These include amplifiers with automatic gain control (AGC) and devices subject to saturation or power limiting.

Amplitude Modulation The process, or result of the process, of varying the amplitude of a carrier signal. The resulting modulated carrier contains information that can be recovered by demodulation. See also [Modulation](#).

Analog The general class of devices or circuits in which the output varies as a continuous function of the input.

Annotation The labeling of specific information on the display (such as frequency or power).

ANSI American National Standards Institute: A national membership organization (open to manufacturers, organizations, users, and communications carriers) that approves standards, accredits standards development groups and certificate programs, and represents and coordinates US interests in non-treaty and non-government standards bodies.

Aperture The frequency span of the network analyzer used for calculating group delay. The narrower the aperture, the finer the resolution of the group delay variations, but noise is reduced by increasing the aperture.

Array A set of numbers or characters that represents any given function.

ASCII American Standard Code for Information Interchange

Attenuation Denotes a reduction in signal amplitude. The difference between transmitted and received power due to loss through equipment, lines, or other transmission devices; usually expressed in decibels.

Attenuator An RF or microwave device used to reduce the power level of a signal by precise, incremental amounts over its entire frequency range.

Automatic Calibration System AutoCal: Feature offered on Rohde&Schwarz network analyzers.

Automatic Gain Control (AGC) A circuit used in amplifiers and other active devices to keep its RF power level constant as other parameters change, such as frequency. Synonym: Automatic Leveling Control (ALC)

Autoscale An analyzer feature that evaluates waveforms and adjusts controls to stable and enhance the display.

AUX Auxiliary; refers to rear-panel input connector.

Averaging A noise reduction technique that computes each data point based on consecutive sweeps and weighted by a user-specified averaging factor. Each new sweep is averaged into the trace until the total number of sweeps is equal to the averaging factor.

B

B/R The ratio of data sampled at B to the data sampled at R.

Band Pass A range of frequencies that are passed through a device, such as a filter. Frequencies not within the band pass are limited or attenuated. See also [Cutoff Frequency](#).

Bandwidth (BW) The difference between the frequencies of a continuous frequency band within which performance of a device falls within specifications.

Bandwidth Limit The condition prevailing when the system bandwidth is exceeded and signal distortion occurs beyond specifications.

Bandwidth Selectivity A measure of a filter's ability to resolve signals unequal in amplitude. It is the ratio of the 60 dB bandwidth to the 3 dB bandwidth for a given resolution filter (IF). Bandwidth selectivity tells us how steep the filter skirts are. Bandwidth selectivity is sometimes called shape factor.

Binary A method of representing numbers in a scale of two (on or off, high-level or low-level, one or zero). A compact, fast format used to transfer information to and from the analyzer.

BMP Bit-Mapped

Brightness See [Color Brightness](#).

Broadband Device A device that operates over a very wide frequency range and exhibits only small variations in response over that range.

Buffer A storage device used when transmitting information to compensate for a difference in the rate of flow of information between two devices.

Burst Carrier A carrier that is periodically turned off and on. A burst carrier may or may not be modulated.

BUS Basic Utility System

Bus One or more conductors used as a path to deliver transmitted information from any of several sources to any of several destinations.

BW Bandwidth

Byte Eight bits of data representing one character processed as a unit.

C

CAD Computer Aided Design

CAE Computer Aided Engineering

Calibration In HP instrumentation, the process of periodically (usually annually) verifying an instrument is performing to specifications. A calibration certificate is awarded after verification.

In network analyzers, the process of removing systematic errors from measurements. See [Error Correction](#).

Calibration Kit Hardware and software required to perform error correction on a network analyzer for a specific measurement and/or test set.

Calibration, 2-Port See [Error Correction, 12-Term](#).

Calibration, Blackburn Calibrations of transmission path with corrected source match involving 15 calibration terms. Synonym: 15-term error correction

Calibration, Frequency Response The simplest error correction procedure to perform, but only corrects for a few of the twelve possible systematic error terms. Frequency response corrections can be made for reflection measurements, transmission measurements, and isolation measurements.

Calibration, Interpolation A user selectable network analyzer feature that calculates (interpolates) new error correction terms from existing terms when there is a change in network analyzer parameters, such as IF bandwidth, power, or sweep time. The resulting error correction is not as accurate as completing a full 2-port calibration.

Calibration, Port Extension See [Port Extension](#).

Calibration, Reference Plane See [Reference Plane](#).

Calibration, Set Z Sets the system impedance, usually 50 or 75 ohms.

Calibration, SOLT A calibration using four known standards: Short-Open-Load-Through. Also known as a full two-port calibration and 12-term error correction. See also [Error Correction](#).

Calibration, TRL and LRM A calibration used in environments where the DUT cannot be connected directly to the network analyzer ports, (MMIC, microstrip, beam-lead diodes etc.). Thru-Reflect-Line (TRL) and M (Match) standards are fabricated and used because known high-quality standards are not readily available. The requirements for characterizing these standards are less stringent, but the calibration is not as accurate as the traditional full two-port calibration using S-O-L-T standards. The terms are used interchangeably (TRL, LRL, LRM etc.) but they all refer to the same basic calibration method.

Characteristic Impedance The impedance looking into the end of an infinitely long lossless transmission line.

Color Brightness A measure of the intensity (brightness) of a color.

Command A set of instructions that are translated into instrument actions. The actions are usually made up of individual steps that together can execute an operation.

Continuous Sweep Mode The analyzer condition where traces are automatically updated each time trigger conditions are met.

Controller A device capable of specifying the talker and listeners for an information transfer. An external computer connected to an instrument to control its operation.

Corrected Measurements made after performing error correction.

Coupler See [Directional Coupler](#).

CPU Central Processing Unit

Crosstalk The occurrence of a signal at one port of a device being affected by a signal in any other path. Isolation is the measurement of crosstalk.

Cursor An electronically generated pointer that moves across the display to manipulate controls.

Cutoff Frequency In filters, the frequency at which attenuation is 3dB below the band pass signal level, known as the 3dB points.

CW Continuous wave: A single frequency (rather than a swept frequency).

D

DAC Digital to Analog Converter

dB Decibel: a relative unit of measure. The ratio in dB is given by: $10 \log_{10} (P_1/P_2)$ where P_1 and P_2 are the measured powers. The dB is preferred instead of arithmetic ratios or percentages because when components are connected in series, their effect on power, expressed in dB, may be arithmetically

added and subtracted. For example, if a 3dB attenuator is connected to a 10dB amplifier, the net gain of the two components is $(-3\text{dB} + 10\text{dB} = +7\text{dB})$.

dBm Absolute unit of measure in decibels: $0\text{dBm} = 1\text{ mW}$. The conventions of the dB (adding and subtracting) continue to apply.

DBMS Database Management System

DC Direct Current

Default A known set of conditions used in the absence of user-defined conditions.

Delay See [Group Delay](#).

Demodulation The process of recovering from a modulated carrier, information in the form of a signal having essentially the same characteristics as the original modulating signal. Recovery of the modulating signal accomplished by signal detection.

Detection The process of demodulating signal carriers. There are two basic ways of providing signal detection in network analyzers: Diode detectors (used in broadband applications) and heterodyning, (used in narrowband applications).

Detector, Diode A device used to convert a RF signal to a proportional DC level. If the signal is amplitude modulated, the diode strips the RF carrier signal from the modulation. Many sources used with scalar analyzers are amplitude modulated with a 27.778 kHz signal and then detected in the network analyzer. Phase information on the signal carrier is lost in diode detection.

Deviation from Linear Phase Linear phase refers to the nature of the phase shift of a signal through a device. The phase is linear if a plot of phase shift versus frequency is a straight line using linear scales. Deviation from linear phase causes signal distortion.

Digital Pertaining to the class of devices or circuits in which the output varies in discrete steps.

Digital Demodulation Describes a technique of extracting the information used to modulate a signal. Digital signal processing algorithms are used on the signal after it has been converted from an analog to a digital form (digitized).

Dimension To specify the size of an array. The number of array rows or columns.

Directivity In a 3-port directional coupler, the ratio of the power present at the auxiliary port when the signal is traveling in the forward direction to the power present at the auxiliary port when the same signal is traveling in the reverse direction.

Directional Coupler A 3-port device typically used for separately sampling the backward (reflected) wave in a transmission line.

Disk A circular, magnetic storage medium.

Display Noun: See [Screen](#).

Verb: To show annotation and measurement data on the display.

Display Detector Mode The manner in which analog, video information is processed prior to being digitized and stored in memory.

Display Dynamic Accuracy The amplitude uncertainty, usually in dB, over the display dynamic range.

Display Dynamic Range The amplitude range, in dB, over which the display dynamic accuracy applies.

Display Formats Graphical formats for displaying measurement data. These include single channel, overlay (multiple traces on one graticule), split (each trace on separate graticules).

Display Modes The ways in which measurement data can be presented graphically. On a network analyzer, the choices are Cartesian/rectilinear (XY plot with log or linear magnitude, phase, group delay, SWR, real and imaginary, and dBV, dBmV and dBuV), polar (magnitude and angle), magnitude and phase, and Smith chart. Not all display modes are available on all network analyzers. In addition, displays can present this information in various combinations of traces. Common modes are dual, (the ability to display more than one trace, usually over the same frequency range), and alternate, (the ability to display more than one trace, each with different frequency range and type).

Display Phase Dynamic Accuracy The phase measurement uncertainty, usually in degrees, for measurements whose units are in degrees.

Display Points The total number of measurement points made in a single measurement. The points can be in units of frequency, power, or time. The number of points often dictates measurement speed, resolution, and aperture.

Display Trace Noise, Magnitude The amplitude uncertainty of the trace, in dB, due to random noise in the test system.

Display Trace Noise, Phase The phase uncertainty of the trace, in degrees, due to random noise in the test system.

Display Type The type of display screen built into the analyzer. Data can be displayed as a raster drawing (a computer-like dot map) or as a vector drawing (lines drawn on the display). Color and display standard can also be specified as monochrome (single color), or color (two or more colors). The format standard may also be specified, such as VGA or SVGA, for IBM-compatible personal computers.

Distortion Deterioration of a signal's quality due to the nonlinear characteristics of a device or system

transfer function. Distortion is measured as a combination of the changes in amplitude, frequency and phase of signal at the output of a device or system as compared to the signal at the input.

Drift The slow change in signal frequency.

DSP Digital Signal Processing

DUT Device Under Test

DVM Digital Volt Meter

Dynamic Range In a receiver, the range of signal levels, from minimum to maximum, that can be reliably measured simultaneously. Dynamic range allows small signals to be measured in the presence of large signals. Source power and receiver compression usually limits the maximum boundary to dynamic range. Receiver residual responses and noise floor usually limit the minimum power boundary.

E

ECal See [Electronic Calibration](#).

Electrical Delay A simulated variable length of lossless transmission line, added to or subtracted from a receiver input, to compensate for interconnecting cables. The firmware equivalent of mechanical or analog "line stretchers" in other network analyzers.

Electronic Calibration (ECal) A calibration system for electronic calibration of RF and microwave vector network analyzers. The electronic calibration system creates a twelve-term, two-port error model and then provides a confidence check of the calibration. The Ecal system consists of a repeatable, variable-impedance, solid-state calibration standard and a mainframe control unit which interfaces with the 8510, 8720 series, and the 8753 network analyzers or a USB module which interfaces with the PNA series network analyzers.

EMC Electro-Magnetic Compatibility

EMI Electro-Magnetic Interference: Unintentional interfering signals generated within or external to electronic equipment. Typical sources could be power-line transients, noise from switching-type power supplies and/or spurious radiation from oscillators. EMI is suppressed with power-line filtering, shielding, etc.

Engage To activate a function.

Enter The process of inputting information.

EPROM Electronically Programmable, Read-Only Memory

Error Correction In network analyzers, a process that removes or reduces systematic (repeatable) measurement errors by measuring known standards from a calibration kit. Synonym: measurement calibration

Error Correction, 3-Term Used to remove systematic measurement errors on a device with one port, such as a load.

Error Correction, 12-Term Correction for a two port device using six parameters:

Directivity

Source match

Load match

Reflection frequency response

Transmission frequency response

Isolation

To completely characterize a two-port device, these six parameters must be characterized in the forward and reverse directions, making a total of 12 terms. The user usually has the option of omitting isolation from the correction process. Synonym: Full two-port error correction

Error Correction, 1-Port Corrects a test set for port 1 or port 2 directivity, frequency response, and source match errors. The process requires three known standard terminations, for example, open, short, and load.

Error Message A message on a display that indicates an error condition. Missing or failed hardware, improper user operation, or other conditions that require additional attention can cause an error condition. Generally, the requested action or operation cannot be completed until the condition is resolved.

ESD Electro Static Discharge

Ethernet A network that adheres to the IEEE 802.3 Local Area Network standard.

Ethernet address A hexadecimal number which is used to identify a machine on a network. Each analyzer is assigned a unique Ethernet address at the factory and it is stored in the analyzer's ROM.

External trigger signal A TTL signal that is input to an analyzer and initiates a measurement sweep or similar event, making the measurements synchronous with the external triggering source.

F

Filter A passive device that allows some frequencies to pass and attenuates others, depending on the type and specifications. A high-pass filter passes frequencies above the cutoff frequency, a low-pass filter passes frequencies below the cutoff frequency, and a band-pass filter passes frequencies between

two specific frequencies.

Firmware An assembly made up of hardware and instruction code. The hardware and instruction code is integrated and forms a functional set that cannot be altered during normal operation. The instruction code, permanently installed in the circuitry of the instrument, is classified as ROM (read only memory). The firmware determines the operating characteristics of the instrument or equipment.

Flatness The amplitude and phase response of a device under test (DUT), a signal source, a receiver, or a combination of these. See also [Frequency Response](#).

FM Frequency Modulation

Frequency The number of periodic oscillations, vibrations, or waves per unit of time, usually expressed in cycles per second, or Hertz (Hz).

Frequency Accuracy The uncertainty with which the frequency of a signal or spectral component is indicated, either in an absolute sense or relative to another signal or spectral component. Absolute and relative frequency accuracies are specified independently.

Frequency Range The range of frequencies over which a device or instrument performance is specified.

Frequency Resolution The ability of a network analyzer to measure device characteristics at closely spaced frequencies and display them separately. Resolution of equal amplitude responses is determined by IF bandwidth. Resolution of unequal amplitude responses is determined by IF bandwidth and bandwidth selectivity.

Frequency Response The peak-to-peak variation in the displayed amplitude response over a specified center frequency range. Frequency response is typically specified in terms of dB, relative to the value midway between the extremes.

Frequency Span The magnitude of the displayed frequency component. Span is represented by the horizontal axis of the display. Generally, frequency span is given as the total span across the full display. Some analyzers represent frequency span (scan width) as a per-division value.

Frequency Stability The ability of a frequency component to remain unchanged in frequency or amplitude over short and long-term periods of time. Stability refers to an oscillator's ability to remain fixed at a particular frequency over time.

Front Panel Key Keys that are located on the front panel of an instrument. The key labels identify the function the key activities. Numeric keys and step keys are two examples of front panel keys.

Full 2-Port Calibration See [Error Correction, 12-Term](#).

Function The action or purpose that a specific item is intended to perform or serve. The network

analyzer contains functions that can be executed via front panel key selections, or through programming commands. The characteristics of these functions are determined by the firmware in the instrument. In some cases, a DLP (downloadable program) execution of a function allows you to execute the function from front panel key selections.

Fundamental Frequency In any waveform, the lowest frequency component; all other components are harmonics. A pure sinusoid has only one component, the fundamental.

G

Gb Gigabit

GB Gigabyte

GHz Gigahertz

GIF Graphics Interchange Format - Standard graphic format to store bitmapped graphics files.

Giga Prefix for one billion.

GP I/O General Purpose Input / Output; a connector usually on the back of an instrument that allows communication with other test equipment, external test sets, switches, and computers that enable the instrument to be triggered or to trigger external equipment. An example is a foot switch that continues or cycles a measurement, allowing the operator to use both hands on the test hardware.

GPB General Purpose Interface Bus - IEEE 488 bus is interconnect bus and protocol, allows linking of instruments and computer.

Graticule (or Grid) Enclosed area where waveform is displayed on instrument. Tick marks, on frame or axis, are a scaling aid for making visual measurements.

Group Delay A measure of the transit time of a signal through a DUT versus frequency. Group delay can be calculated by differentiating the DUT's insertion-phase response with respect to frequency. See also [AM Group Delay](#) and [Deviation from Linear Phase](#).

GUI Graphical User Interface

H

Hardcopy Paper copy of data.

Hardkey A front-panel key, which engages a single analyzer function or presents a single menu of softkeys.

Horizontal Reference See [Reference Level](#).

Horizontal Resolution The analyzer's ability to take closely spaced horizontal data points over the full sweep.

Host Computer A computer or device on a network that provides end users with services such as computation and database access and that usually performs network control functions.

Host Name A unique name that is used to identify each host machine on a network. The host name is directly linked to, and can usually be used in place of, the IP address. The user or the system administrator usually creates the host name.

HP Hewlett-Packard Company

HPGL Hewlett-Packard Graphics Language

HP-IB Hewlett-Packard Interface Bus. A parallel interface that allows "daisy chaining" of more than one device to a port on a computer or instrument. Interface protocol is defined in IEEE 488.2; equivalent to the industry standard GPIB.

HTTP HyperText Transfer Protocol: Used to carry World Wide Web (WWW) traffic.

Hue The dimension of color referred to a scale of perceptions ranging from red through yellow, green, and blue, and back to red. A particular gradation of color, tint, shade.

I

I/O Input/Output

I/O Path Input/Output Path

IEEE Institute of Electrical and Electronic Engineers

IF Intermediate Frequency: the frequency at which a signal is processed after mixing.

Impedance The ratio of voltage to current at a port of a circuit, expressed in ohms.

Initialize The process that assigns information locations to a disk to prepare the magnetic media to accept files.

Input A path intended for putting a signal into an instrument.

Most network analyzers have either 3 (labeled A, B, and R) or 4 inputs (labeled A, B, R1, and R2). Inputs are not the same as channels.

Input Attenuator An attenuator between the input connector and the first mixer of a spectrum

analyzer (also called an RF attenuator). The input attenuator is used to adjust the signal level incident to the first mixer, and to prevent gain compression due to high-level or broadband signals. It is also used to set the dynamic range by controlling the degree of internally-generated distortion. For some analyzers, changing the input attenuator settings changes the vertical position of the signal on the display, which then changes the reference level accordingly. In Keysight microprocessor-controlled analyzers, the IF gain is changed to compensate for changes in input attenuator settings. Because of this, the signals remain stationary on the display, and the reference level is not changed.

Insertion Loss The difference between the power measured before and after the insertion of a device. The attenuation between the input and output of a device.

Intensity Brightness; emitting or reflecting light; luminosity.

Interface A connection that allows a common communication link between two or more instruments.

Intermodulation Distortion Undesired frequency components resulting from the interaction of two or more spectral components passing through a device having nonlinear behavior, such as a mixer or an amplifier. The undesired components are related to the fundamental components by sums and differences of the fundamentals and various harmonics. The algorithm is: $f_1 \pm f_2$, $2xf_1 \pm f_2$, $2xf_2 \pm f_1$, $3xf_1 \pm 2x f_2$, and so on.

Internet The connection of two or more distinct networks. Often a gateway or router is used to make the connection.

Interpolate To determine a value of a signal between two adjacent points by a procedure or algorithm.

IP Internet Protocol

IP Address Internet protocol address: a unique number that is assigned to each device which is to be connected to a TCP/IP network. Before using an analyzer on a network, your network administrator will need to assign an IP address. An IP address consists of a 32-bit value presented in decimal dot notation: 4 octets (bytes) separated by a dot.

ISDN Integrated Services Digital Network: A standard digital service capability that features one or more circuit-switched communication channels capable of carrying digital voice, data, or image signals, a packet-switched channel for out-of-band signaling and control. In addition, ISDN provides a collection of standard and optional features that support information productivity for the user, providing higher-speed Internet access than analog systems.

ISO International Standards Organization

Isolation A specification or measure of the immunity that one signal has to being affected by another adjacent signal. The occurrence is known as crosstalk.

Isolator An RF device used for providing isolation between paths and components. Made from a 3-port

circulator, the third port being terminated in a 50ohm load.

J

K

Kilo Prefix for one thousand.

KB Kilobyte

Kb/s Kilobytes per second

L

LAN Local Area Network

LANS Local Area Network System

LCD Liquid Crystal Display

LED Light Emitting Diode

LFE Low Frequency Extension

LIF Logical Interchange Format (used for older HP disk drives/computers)

Limit Lines Lines input by the user that overlay the analyzer's measurement data to allow automatic detection of data that is out of the acceptable range. Pass/Fail annotation, audio alarms, or electronic output can be triggered to notify the operator or on-line computer program of the over-limit condition.

Limit-Line File The user-memory file that contains the limit-line table entries.

Limit-Line Table The line segments of a limit line are stored in the limit-line table. The table can be recalled to edit the line segments, then restored in the limit-line file.

Linear Device A device in which the output is continuously proportional to the input.

LO Local Oscillator. In a superheterodyne system, the LO is mixed with the received signal to produce a sum or difference equal to the intermediate frequency (IF) of the receiver.

LO Feedthrough The response that in a superheterodyne system when the first local oscillator frequency is equal to the first IF.

Load A one port microwave device used to terminate a path in its characteristic impedance.

Load Match A measure of how close the device's terminating load impedance is to the ideal transmission line impedance. Match is usually measured as return loss or standing wave ratio (SWR) of the load.

Local Lock Out A condition or command that prevents analyzer front-panel entries (and disables the Local key).

Local Operation To operate manually from the front panel.

Log Logarithm

Log Display The display mode in which vertical deflection is a logarithmic function of the input signal amplitude. Log display is also called logarithmic display. The display calibration is set by selecting the value of the reference level position and scale factor in dB per division.

LRM Line-Reflect-Match. See [Calibration, TRL, and LRM](#).

M

Magnitude The amplitude of a signal measured in its characteristic impedance without regard to phase. See also [Scalar](#).

Marker A graphical symbol along a display trace that is annotated with measurement characteristics of that specific data point.

Marker Functions Mathematical or statistical computation on the data of one or more markers to provide the operator more information. For example, the marker delta function calculates and displays the difference between two markers.

Maximum Input Level The maximum signal power that may be safely applied to the input of an analyzer. The maximum input level is typically 1 W (+30 dBm) for Keysight spectrum analyzers.

MB Megabyte

Measurement Uncertainty The quantified amount of error in a measurement situation. Calibrations are intended to reduce the amount of uncertainty. The following are sources of measurement errors that lead to uncertainty:

- Systematic errors (imperfections in calibration standards, connectors, cables, and instrumentation)
- Random errors (noise, connector repeatability)
- Drift (source and instrumentation)

Mega Prefix for one million.

Memory A storage medium, device, or recording medium into which data can be stored and held until some later time, and from which the entire original data may be retrieved.

Memory Card A small memory device shaped like a credit card that can store data or programs.

Menu The analyzer functions that appear on the display and are selected by pressing front panel keys. These selections may invoke a series of other related functions that establish groups called menus.

MHz Megahertz

milli Prefix for one-thousandth.

Modem Modulator/Demodulator

Modulation The process, or the result of the process, of varying a characteristic of a carrier signal with an information-bearing signal, causing the carrier to contain the information. See **AM** and **FM**.

Modulation Distortion (Option S93070xB) Measures the nonlinear behavior of an RF microwave amplifier under a modulated signal.

Monitor Any external display.

Monochrome Having only one color (chromaticity).

ms Millisecond

mW Milliwatt: one thousandth of a watt

Multisync A type of monitor that can synchronize its horizontal sweep to various frequencies within a specified range.

N

Narrowband In network analysis, the frequency resolution of the analyzer's receiver that is sufficiently narrow to resolve the magnitude and phase characteristics of narrowband devices. The reduced receiver bandwidth usually decreases the noise floor of the receiver, providing more measurement amplitude range.

Narrowband Device A device whose transfer characteristics are intended to operate over a very narrow frequency range and are designed to provide well-defined amplitude responses in that range, such as a band pass filter.

Network Analysis The characterization of a device, circuit, or system derived by comparing a signal

input going into the device to a signal or signals coming out from the device.

NIST National Institute of Standards and Technology

Nit The unit of luminance (photometric brightness) equal to one candela per square meter.

Noise Random variations of unwanted or disturbing energy in a communications system from man-made and natural sources that affects or distorts the information carried by the signal. See also [Signal-to-Noise Ratio](#).

Noise Figure (F): For a two-port device, a measure of how the noise generated inside the device degrades the signal-to-noise ratio of a signal passing through the device at 290 degrees, usually expressed in dB.

Noise Floor The analyzer's internal displayed noise. The noise level often limits how small a signal magnitude can be measured. In network analysis, noise floor is measured with the test ports terminated in loads, full two-port error correction, 10 Hz IF bandwidth, maximum test port power, and no averaging during the test.

Non-Insertable Devices In measurement calibration, a device that cannot be substituted for a [Zero-Length Through Path](#). It has the same type and sex connectors on each port, or a different type of connector on each port.

Nonvolatile Memory Memory data that is retained in the absence of an ac power source. This memory is typically retained with a battery. Refer also to battery-backed RAM.

Normalize To subtract one trace from another to eliminate calibration data errors or to obtain relative information.

O

Offset To move or set off a determined amount. Used in instruments for offsetting frequencies, limits, delay, loss, impedance, etc.

Output Attenuation The ability to attenuate the signal, the source, in order to control its power level.

P

PC Personal Computer

PDF Portable Document Format (used on the Web)

Parser, Command Reads program messages from the input queue of a device in the order they were

received from the controller. The parser determines what actions the analyzer should take. One of the most important functions of the command parser is to determine the position of a program message in the analyzer SCPI command tree. When the command parser is reset, the next element it receives is expected to arise from the base of the analyzer command tree.

Peak Search A function on an analyzer that searches for the largest response and places a marker on it.

Phase The fractional part of a cycle through which an oscillation has advanced, measured from an arbitrary starting point; usually measured in radians or degrees. In network analysis, the phase response of the device under test is the change in phase as a function of frequency between the input stimulus and the measured response.

Port The physical input or output connection of an instrument or device.

Port Extension Redefining the reference plane to other than that established at calibration. A new reference plane is defined in seconds of delay from the test set port.

Positive Peak The maximum, instantaneous value of an incoming signal.

Postscript (.ps files) Stores bitmapped graphics files in an encapsulated format for direct use by postscript printers.

Power, Max Input The upper limit to input power for which the specifications apply. Some specifications may have different levels of maximum inputs. For example, compression power maximum is usually higher than the harmonic distortion maximum.

Power, Safe Input The input power, usually in dBm, allowed without damaging the instrument.

Preset A pre-defined instrument state (that also runs an analyzer self-test). The action of pushing the Preset key.

Protocol A set of conventions that specify how information will be formatted and transmitted on a network, and how machines on a network will communicate.

Q

Q or Q Factor The ratio of energy stored to energy lost in a resonant circuit. High Q indicates a sharp resonance response over frequency.

Query Any analyzer programming command having the distinct function of returning a response. These commands may end with a question mark (?). Queried commands return information to the computer.

R

$r + jx$ Expression for complex impedance, where r represents the resistive portion and x represents the reactive portion.

R Channel Reference Channel

RAM Random Access Memory, or read-write memory: A storage area allowing access to any of its storage locations. Data can be written to or retrieved from RAM, but data storage is only temporary. When the power is removed, the information disappears. User-generated information appearing on a display is RAM data.

ROM Read Only Memory: A storage area that can be read only; it cannot be written to or altered by the user. In instruments, the storage area that contains the "brains" or operational programming; the firmware.

Receiver A circuit or system designed for the reception and/or measurement of signals in a specified frequency spectrum.

Receiver Dynamic Range See [Dynamic Range](#).

Reference Level An instrument function that allows the user to set the amplitude value at the reference position. On network analyzers, the reference position is also selectable. On some spectrum analyzers, the reference position is fixed at the top of the display.

Reference Plane The electrical location at which a network analyzer assumes the system connectors and fixturing ends and the DUT begins. The reference plane is set by using calibration standards with known electrical length. The closer the reference plane is to the device under test (DUT), the better the characterization of the device because of the elimination of test system uncertainties.

Reference Receiver In a network analyzer, the receiver that measures signals as they come out of the source, before they are incident on the test port and DUT. Typically, these signals are used to compare with the signal at the Test Port Receiver, to determine the affect that the DUT has on the signal. In a 2-port network analyzer, these are typically named 'R1' (port 1) and 'R2' (port 2). [See a block diagram](#) of the receivers in your PNA.

Reflection The phenomenon in which a traveling wave strikes a discontinuity and returns to the original medium.

Reflection Coefficient The ratio of the reflected voltage to the incident voltage into a transmission line or circuit. If a transmission line is terminated in its characteristic impedance, the reflection coefficient is zero. If the line is shorted or open the coefficient is 1. See also [Return Loss](#) and [SWR](#).

Reflection Measurements Measurements that characterize the input and /or output behavior of the device under test (DUT). Measured as the ratio of the reflected signal to the incident signal as a

function of frequency. Parameters are called return loss, reflection coefficient, impedance, and standing wave ratio (SWR), all as a function of frequency. See also [S-Parameters](#).

Remote A mode of operation where another device (or computer) controls an instrument via the HP-IB. In this mode, the instrument front panel keys are disabled. Front panel operation is called local operation.

Remote Programming The automatic operation of an instrument by a computer, usually through a HP-IB, LAN, or RS-232 link.

Resolution The ability of a receiver to resolve two signals.

Resolution Bandwidth The ability of a spectrum analyzer to display adjacent responses discretely (Hertz, Hertz decibel down). This term is used to identify the width of the resolution bandwidth filter of a spectrum analyzer at some level below the minimum insertion loss point (maximum deflection' point on the display). Typically, it is the 3 dB resolution bandwidth that is specified, but in some cases the 6 dB resolution bandwidth is specified.

Return Loss The amount of dB that the reflected signal is below the incident signal. If zero signal is reflected, the impedance of the device is equal to the characteristic impedance of the transmission system, and return loss is infinite. If the entire incident signal is reflected, the return loss is zero. See also [S-Parameters](#), [Reflection Coefficient](#), and [SWR](#).

Reverse Measurement The measurement of a device from output to input.

RF Radio Frequency (from approximately 50 kHz to approximately 3 GHz). Usually referred to whenever a signal is radiated through the air.

ROM Read Only Memory

S

S/N Signal-to-Noise Ratio

Sampler An electronic component that captures the signal level and phase across a known impedance at a uniform rate. In Network Analyzers, this sampling rate must be sufficiently high and precisely timed to make accurate measurements. Network analyzers typically have three or four samplers or mixers.

Sampler Bounce The leakage or crosstalk between a network analyzer's samplers. Delay in this crosstalk caused by leakage transmission propagation, give the interference its "bounce" appearance. Sampler bounce causes an increase in the noise level of the affected channel, reducing the sensitivity of the analyzer.

Saturation The degree of color purity, on a scale from white to pure color.

Scalar A quantity that has magnitude but no phase. A network analyzer capable of measuring only magnitude.

Scale Factor The display vertical axis calibration in terms of units per division.

SCPI Standard Commands for Programmable Instruments

Screen The physical surface of the CRT or flat panel upon which the measurement results, setup information, softkey definitions, and other instrument communication is presented.

Self-Test A group of tests performed at power-up (or at preset) that verify proper instrument operation.

Sensitivity The minimum input signal required to produce a specified output signal having a specified signal-to-noise ratio, or other specified criteria.

On a spectrum analyzer, the level of the smallest sinusoid that can be observed, usually under optimized conditions of minimum resolution bandwidth, 0 dB input attenuation, and minimum video bandwidth.

The normalized change in YIG component's center frequency resulting from a change in tuning coil current, specified in MHz/mA.

Serial Prefix The five-character prefix that begins an instrument serial number; used to represent versions of firmware or hardware changes that have occurred.

Server A device that is configured to provide a service to other devices on a network, such as shared access to a file system or printer.

Signal-to-Noise Ratio SNR: The ratio of the amplitude of the desired signal to the amplitude of noise signals, usually expressed in dB and in terms of peak values for impulse noise and root-mean-square values for random noise.

Single Sweep Mode The spectrum analyzer sweeps once when trigger conditions are met. Each sweep is initiated by pressing an appropriate front panel key, or by sending a programming command.

Small Signal Gain Compression A situation when the input signal's measured amplitude is less than its actual level due to overloading of the network analyzer's input mixer; the analyzer is operating nonlinearly. For broadband analyzer detectors, a signal other than the one under test can put the analyzer into this gain compressed mode, thereby making even lower level signals appear at a lower level than actual. The broadband mode measures all the power incident to the analyzer, not just the signals at the frequency of interest.

Smith Chart A graphical mapping of the complex reflection coefficient into normalized complex impedance. Circles on the chart represent constant resistance and radiating lines orthogonal to the

circles represent constant reactance. The center of the chart represents the characteristic impedance of the transmission system. Any point on the chart defines a single complex impedance. A line on the chart represents changing impedance over frequency.

SOLT Short-Open-Load-Through calibration. See also [Calibration](#), [SOLT](#).

Source A device that supplies signal power; a sweep oscillator or synthesized sweeper.

Source Amplitude Accuracy The amplitude uncertainty, in dB, of the source power readout.

Source Amplitude Flatness The amplitude flatness, in dB, of the source power over the frequency range specified.

Source Frequency Resolution The smallest unit of frequency which can be set and/or measured, in Hz.

Source Frequency Time Base Accuracy A measure of the analyzer's frequency stability measured in parts per million (ppm. or 1 part in 10E6). For example, a stability of ± 5.0 ppm means that an analyzer will measure 1 MHz to an accuracy of $\pm 5 \times 10^{-6} \times 10^6 \text{ Hz} = \pm 5 \text{ Hz}$.

Source Frequency Time Base Stability A measure of the analyzer's time base accuracy over time and temperature. Typically the time base accuracy will be specified for 1 year. A typical temperature frequency stability is ± 10 ppm for $25^\circ \text{ C} \pm 50 \text{ C}$.

Source Harmonics The level of harmonics generated by the analyzer's signal source, in dBc from the fundamental.

Source Match A measure of how close the signal source impedance is to the ideal transmission line impedance of the test system. Match is usually measured as return loss or standing wave ratio (SWR) of the source.

Span The stop frequency minus the start frequency. The span setting determines the horizontal-axis scale of the analyzer display.

Span Accuracy The uncertainty of the indicated frequency separation of any two signals on the display.

S-Parameters (Scattering Parameters) A convention used to characterize the way a device modifies signal flow using a network analyzer. A two port device has four S-parameters: forward transmission (S21), reverse transmission (S12), forward reflection (S11), and reverse reflection (S22).

Spectrum Analyzer (Option Sx090A/B) Spectrum Analyzer function for component measurements.

Stop/Start Frequency Terms used in association with the stop and start points of the frequency measurement range. Together they determine the span of the measurement range.

Storage States The number of settings, programs, traces, and other parameters available to be saved, cataloged, and recalled at any one time.

Storage, Disk An internal or external digital storage disk for saving test data, instrument settings, IBASIC programs, and other measurement parameters. Storage formats include MS-DOS (R) and HPs standard LIF with binary, PCX, HP-GL, or ASCII data formats.

Structural Return Loss Poor return loss in cable due to a periodic fault such as a periodic dent caused by dropping the cable spool or by the cable pulling process during manufacture.

Supplemental Characteristics Typical but non-warranted performance parameters, denoted as "typical", "nominal" or "approximate".

Sweep The ability of the source to provide a specified signal level over a specified frequency range in a specified time period. Also see **Sweep Mode** and **Sweep Type**.

In data processing mode, a series of consecutive data point measurements, taken over a sequence of stimulus values.

Sweep Mode The way in which a sweep is initiated or selected, e.g., single, continuous, alternate, or chopped.

Sweep Type The method of sweeping the source, e.g., linear, log, or frequency step.

Sweeper A signal source that outputs a signal that varies continuously in frequency.

SWR Standing Wave Ratio, calculated as $(1 + \pi) / (1 - \pi)$ where π is the reflection coefficient.

Sync Synchronization, or Synchronized

Syntax The grammar rules that specify how commands must be structured for an operating system, programming language, or applications.

System Dynamic Range The difference between the maximum receiver input level and the receiver's noise floor. System dynamic range applies to transmission measurements only, since reflection measurements are limited by directivity.

T

TDR/TDT (Option S93011A/B) Time Domain Reflectometry/Time Domain Transmission.

T/R See **Transmission/Reflection**.

Termination A load connected to a transmission line or other device.

Test Limit The acceptable result levels for any given measurement.

Test Port See [Port](#).

Test Port Receiver In a network analyzer, the receiver directly behind the test ports, used to measure the signal as it is reflected off, or transmitted through, the DUT. This signal is typically compared with the signal at the [Reference Receiver](#) to determine how the DUT affects a signal. In a 2-port network analyzer, these are typically named 'A' (port 1) and 'B' (port 2). [See a block diagram](#) of the receivers in your PNA.

Test Set The arrangement of hardware (switches, couplers, connectors and cables) that connect a test device input and output to the network analyzer's source and receiver to make s-parameter measurements.

Third Order Intercept TOI: The power input to a non-linear device that would cause third order distortion at the same power level. TOI is a measurement to determine the distortion characteristics of a mixer or receiver. The higher the value, the more immune the receiver to internal distortion.

Thru Through line: A calibration standard. See [Calibration](#), [SOLT](#).

Tint A shade of color; hue.

Toggle To switch states, usually to change a function from on to off, or off to on.

TOM Thru-Open-Match: A Rohde&Schwarz term to describe a calibration method.

Trace A series of data points containing frequency and response information. The series of data points is often called an array. The number of traces is specific to the instrument.

Tracking The ability of the analyzer's receiver to tune to the source frequency over the measurement frequency range. Poor tracking results in amplitude and phase errors due to the receiver IF circuits attenuating and delaying the device under test output.

Transfer Function The ratio of the output signal to the stimulus signal, both as a function of frequency.

Transmission See [Transmission Measurements](#).

Transmission Intermodulation Spurious A measure of the capability of the transmitter to inhibit the generation of intermodulation distortion products. Intermodulation spurious is sometimes called intermodulation attenuation.

Transmission Measurements The characterization of the transfer function of a device, that is, the ratio of the output signal to the incident signal. Most common measurements include gain, insertion loss, transmission coefficient, insertion phase, and group delay, all measured over frequency. See also [S-Parameters](#).

Transmission/Reflection (T/R) Refers to the suite of measurements made by a scalar or vector network analyzer to characterize a device's behavior over frequency. See also [S-Parameters](#).

Transparent Something that is not visible to the user. Usually a procedure that occurs without the user's initiation or knowledge.

Trigger A signal that causes the instrument to make a measurement. The user can select several options for triggering, such as manual, continuous, or external (for synchronizing measurements to an external source).

TRL Through-Reflect-Line. See [Calibration, TRL and LRM](#).

TTL Transistor-Transistor Logic

Two-Port Error Correction See [Error Correction, 12-Term](#).

U

Uncorrected Measurements made without performing error correction.

Uncoupled Channels Stimulus or receiver settings allowed to be set independently for each channel.

UNI User-Network Interface: The point at which users connect to the network.

Units Dimensions on the measured quantities. Units usually refer to amplitude quantities because they can be changed. In analyzers with microprocessors, available units are dBm (dB relative to 1 mW dissipated in the nominal input impedance), dBmV (dB relative to 1 mV), dBW (dB relative to 1 W), V (volts), W (watts).

V

Variable A symbol, the value of which changes either from one iteration of a program to the next, or within each iteration of a program.

Vector A quantity that has both magnitude and phase.

A network analyzer capable of measuring both magnitude and phase.

VEE Visual Engineering Environment (Keysight software product)

Velocity Factor A numerical value related the speed of energy through transmission lines with different dielectrics (.66 for polyethylene). Used in making time domain measurements.

Vertical Resolution The degree to which an instrument can differentiate amplitude between two

signals.

Video An electrical signal containing timing, intensity, and often color information that, when displayed, gives a visual image.

Video Bandwidth In spectrum analyzers, the cutoff frequency (3 dB point) of an adjustable low-pass filter in the video circuit. When the video bandwidth is equal to or less than the resolution bandwidth, the video circuit cannot fully respond to the more rapid fluctuations of the output of the envelope detector. The result is a smoothing of the trace, or a reduction in the peak-to-peak excursion, of broadband signals such as noise and pulsed RF when viewed in broadband mode. The degree of averaging or smoothing is a function of the ratio of the video bandwidth to the resolution bandwidth.

Video Filter In spectrum analyzers, a post-detection, low-pass filter that determines the bandwidth of the video amplifier. It is used to average or smooth a trace. Refer also to [Video Bandwidth](#).

VNA Vector Network Analyzer

W

Waveform A representation of a signal plotting amplitude versus time.

Wireless A term that refers to a broad range of technologies that provide mobile communications for home or office, and "in-building wireless" for extended mobility around the work area, campus, or business complex. It is also used to mean "cellular" for in-or out-of-building mobility services.

WWW World Wide Web

X

Y

Z

Zero-Length Through Path In a measurement calibration, when the two test cables mate together directly without using adapters or a thru-line. See also [Non-Insertable Devices](#).

Specifications - Select the Analyzer Model

An internet connection is required to view ALL specifications documents online at www.keysight.com.

PXIe VNA Specifications

Doc Number	Model
M9370-90002	M9370A - 4 GHz
	M9371A - 6.5GHz
	M9372A - 9 GHz
	M9373A - 14 GHz
	M9374A - 20 GHz
	M9375A - 26.5 GHz
5992-0756	M9485A
5992-3596EN	M9800A - 4.5 GHz
	M9801A - 6.5 GHz
	M9802A - 9 GHz
	M9803A - 14 GHz
	M9804A - 20 GHz
	M9805A- 26.5 GHz
	M9806A - 32 GHz
	M9807A - 44 GHz
	M9808A - 53 GHz

USB VNA Specifications

Doc Number	Model
5992-2765EN	P9370A - 4 GHz
	P9371A - 6.5GHz
	P9372A - 9 GHz
	P9373A - 14 GHz
	P9374A - 20 GHz
	P9375A - 26.5 GHz
5992-3606EN	P5000A/P5020A - 4.5 GHz
	P5001A/P5021A - 6.5 GHz
	P5002A/P5022A - 9 GHz
	P5003A/P5023A - 14 GHz
	P5004A/P5024A - 20 GHz
	P5005A- 26.5 GHz
	P5006A - 32 GHz
	P5007A - 44 GHz
	P5008A - 53 GHz

See the [equations that are used to generate uncertainty curves](#).

Addenda

Applications

M9485A/M937xA Options

Option		Supported Model	Application
007		M9485A, M937xA	Automatic Fixture Removal
009		M9485A, M937xA	Frequency offset mode
010		M9485A, M937xA	Time Domain
028	*	M9485A	Noise Figure
080		M9485A	Frequency Offset
086	*	M9485A	Gain Compression
025		M9485A	Basic RF pulse measurement
551		M9485A, M937xA	N Port calibrated measurement

* These applications are selected from the **Measurement Class dialog** and can NOT coexist in a channel with other measurement classes.

Applications WITHOUT * CAN exist in all measurement classes unless they are explicitly restricted.

P937xA Options

Option		Supported Model	Application
S97007A		P937xA	Automatic Fixture Removal
S97010A		P937xA	Time Domain
S97080A		P937xA	Frequency offset measurements
S97082A	*	P937xA	Scalar Mixer Converter (SMC) measurements Requires Opt S97080A.
S97551A		P937xA	N port calibrated measurement Allows multiple P937xA VNAs to be connected together to add ports.

* These applications are selected from the [Measurement Class dialog](#) and can NOT coexist in a channel with other measurement classes.

Applications WITHOUT * CAN exist in all measurement classes unless they are explicitly restricted.

See Also

[All VNA Models and Options](#)

[External \(Banded\) Millimeter Modules](#)

[FIFO and other Antenna Features](#)

[Interface Control](#)

Home Frequency Offset Measurements

Frequency Offset measurements require the VNA source to tune to a different frequency than the VNA receiver.

This capability is offered as option 009 on the M937xA and option S97080A on the P937xA.

To view the options that are installed on your VNA, click **Help** then **About Network Analyzer**

SMC

[FCA Overview](#)

[SMC Measurements](#)

[Mixer Converter Setup](#)

[Frequency Offset Mode](#)

GCA_AvgBw

Main

Averaging
Averaging Restart
IF Bandwidth

Smoothing

Smoothing
Smooth Percent
Smooth Points

Delay Aperture

Aperture Percent
Aperture Points
Aperture Freq

GCA Freq

Main

Start, Stop, Center, Span, Step

CW

Frequency Offset...

GCA Setup...

GCA/GCX Cal

Main

Smart Cal...

GCA Cal...

Other Cals

Cal All...

Source Power Cal...

Correction

Factory Cal

Src Power Correct

Interpolation

Correction Methods

Correction Properties

Port Extension

Select

Port Extension

Time

Distance

Velocity Factor

DC Loss

Port Extensions...

Auto Port Extension...

Cal Sets & Cal Kits

Cal Set...

Cal Set Viewer

Cal Kit...

Ecal

Show Connected ECals...

Restore ECal Memory..

Cal Pod...

Fixtures

Apply Fixtures
Power Comp...
Fixture Setup

Port Match...
Port Z...
2-port DeEmbed...
Cal Plane Manager...

GCA/GCX Sweep

Main

- Number of Points
- Sweep Type
- Start (Frequency sweep, Power Sweep)
- Stop (Frequency sweep, Power Sweep)
- X-axis Type
- GCA Setup...
- GCX Setup... (M9485A does not support this)

Sweep Timing

- Sweep Time
- Dwell Time
- Sweep Delay
- Fast Sweep

Source Control

- Frequency Offset...
- Pulse Setup...

Segment Table

- Add Segment, Insert Segment, Delete Segment, Delete All Segment
- Segment Table...
- Show Table

GCA Meas

Compression

CompIn21/CompOut21

DeltaGain21

CompGain21

CompS11

RefS21

Other...

Meas Class...

S-Param

S11, S21, S12, S22

Other...

Auxiliary (Only with M9341B)

AuxIn(N) Source Port (N)

CompAI1/CompAI2

Other...

AuxIn(N) Range

Meas Setup

Conversions

Correction

Trace Hold

Equation Editor

Memory

Time Domain

Pulse Setup

GCA/GCX Power

Main

Linear Input Pwr

RF Power

Start Power

Stop Power

Power and Attenuators...

GCA Setup

GCX Setup (M9485A does not support this)

Compress Levels

Comp Method

Linear Input Pwr

Reverse Pwr

Compression Level

Back Off Level

Delta X

Delta Y

Saturation

Leveling & Offset

Select

Slope

Offset

Limit

Offset and Limits...

ALC Hardware

Receiver Leveling...

GCA/GCX Setup

Main

GCA Setup...

Meas Class...

Quick Start

Layout

New Trace

New Channel

New Window

New Sheet

Delete

Select

Measure

Meas Class...

System Setup

Next/Prev Keys : **Select Next/Previous window/channel/trace for the selected one**

Preferences...

Sound: **Turn On/Off beep sound**

Remote Interface...

Internal Hardware

RF Path Config...

IF Path Config...

Mechanical Devices...

Interface Control...

Ext Reference

External Hardware

External Device...

Power Meter Setup...

External Testset...

Multiport

Millimeter Config...

NF AvgBW

Main

- Averaging
- Averaging Restart
- Average Type
- IF Bandwidth
- Noise Avg
- Noise BW

Smoothing

- Smoothing
- Smooth Percent
- Smooth Points

Delay Aperture

- Aperture Percent
- Aperture Points
- Aperture Freq

NF Freq

Main

Start, Stop, Center, Span, Step

CW

Frequency Offset...

NF Setup...

NF Meas

Noise

- NF
- T-Eff
- ENR
- NFmin
- GammaOpt
- Rn
- Other...
- Meas Class...

Incident Noise Power

- Incident DUT Relative NPwr
- Incident DUT NPwr Density
- Incident Syst Relative NPwr
- Incident Syst NPwr Density
- Other...

Available Noise Power

- Available DUT Relative NPwr
- Available DUT NPwr Density
- Available Syst Relative NPwr
- Available Syst NPwr Density
- Other...

Noise Correlation

- NCorr_11
- NCorr_12
- NCorr_21
- NCorr_22
- Other...

S-Param

- S11
- S21
- S12
- S22
- Other...

Receivers

- A Source Port 1/2
- B Source Port 1/2

R1 Source Port 1

R2 Source Port 2

Other...

Meas Setup

Conversions

Correction

Trace Hold

Equation Editor

Memory

Time Domain

Pulse Setup

NF/NFX Cal

Main

Smart Cal...

Noise Figure Cal

Other Cals

Cal All...

Source Power Cal...

Correction

Factory Cal

Src Power Correct

Interpolation

Correction Methods

Correction Properties

Cal Sets & Cal Kits

Cal Set...

Cal Set Viewer

Cal Kit...

Ecal

Show Connected ECals...

Restore ECal Memory...

Cal Pod...

Uncertainty Setup...

Fixtures

Apply Fixtures

Power Comp...

Fixture Setup

Port Match...

Port Z...

2-port DeEmbed...

Cal Plane Manager...
Auto Fixture Removal

NF/NFX Power

Main

- Power Level
- RF Power
- Start Power
- Stop Power
- Noise Source
- Power and Attenuators...
- NF Setup...
- NFX Setup...

Port Power

- Select
- Power Level
- Start Power
- Stop Power
- Source State
- Coupling

Leveling & Offset

- Select
- Slope
- Offset
- Limit
- Offset and Limits...
- ALC Hardware
- Receiver Leveling...

Attenuators

- Source Port 1, 2, 3, 4
- Receiver A, B, C, D

NF/NFX Setup

Main

- NF Setup...
- NFX Setup...
- Meas Class...
- Quick Start

Layout

- New Trace
- New Channel
- New Window
- New Sheet
- Delete
- Select
- Measure
- Meas Class...

System Setup

- Next/Prev Keys : **Select Next/Previous window/channel/trace for the selected one**
- Preferences...
- Sound: **Turn On/Off beep sound**
- Remote Interface...

Internal Hardware

- NF Rcvr Gain (30 High, 15: Medium, 0: Low)
- Interface Control...

External Hardware

- External Device...
- Power Meter Setup...
- External Testset...
- Multiport
- Millimeter Config...

NF/NFX Sweep

Main (Noise Figure Cold Source and Noise Figure Converters)

Number of Points

Sweep Type

Start

Stop

X-axis Type

NF Setup...

NFX Setup...

Sweep Timing

Sweep Time

Dwell Time

Sweep Delay

Fast Sweep

Source Control

Frequency Offset...

Pulse Setup...

Embedded LO...

Segment Table

Add Segment, Insert Segment, Delete Segment, Delete All Segment

Segment Table...

Show Table

SA Cal

Port Extension

- Select
- Port Extension
- Time
- Distance
- Velocity Factor
- DC Loss
- Port Extensions...
- Auto Port Extension...

Cal Sets & Cal Kits

- Cal Set...
- Cal Set Viewer
- Cal Kit...
- Ecal

- Show Connected ECals...
- Restore ECal Memory...
- ECal Confidence Check...
- Characterize ECal...
- Manage ECal Disk Memory...

- Cal Pod...
- Uncertainty Setup...

Fixtures

- Apply Fixtures
- Power Comp...
- Fixture Setup

- Port Match...
- Port Z...
- 2-port DeEmbed...
- N-port DeEmbed...
- Differential Port Match...
- Differential Z...
- Common Z...
- Cal Plane Manager...

Auto Fixture Removal

SA Setup

Layout

- New Trace
- New Channel
- New Window
- New Sheet
- Delete
- Select
- Measure
- Meas Class...

System Setup

Next/Prev Keys : **Select Next/Previous window/channel/trace for the selected one**

Preferences...

Sound: **Turn On/Off beep sound**

Remote Interface...

Internal Hardware

Ext Reference

Interface Control...

External Hardware

External Device...

Power Meter Setup...

External Testset...

Multiport

Millimeter Config...

SMC Meas

S-Param

- S11
- SC21
- SC12
- S22
- Other...
- Meas Class...

Power

- IPwr
- OPwr
- RevIPwr
- RevOPwr
- Other...

Auxiliary (Only with M9341B)

- AuxIn(N) Source Port (N)
- Other...
- AuxIn(N) Range

Meas Setup

- Conversions
- Correction
- Trace Hold
- Equation Editor
- Memory
- Time Domain

SMC/VMC Cal

Other Cals

Cal All...

Source Power Cal...

Correction

Factory Cal

Interpolation

Correction Methods

Correction Properties

Cal Sets & Cal Kits

Cal Set...

Cal Set Viewer

Cal Kit...

Ecal

Show Connected ECals...

Restore ECal Memory...

Cal Pod...

Fixtures

Apply Fixtures

Power Comp...

Fixture Setup

Port Match...

Port Z...

2-port DeEmbed...

Cal Plane Manager...

SMC/VMC Freq

Main

Start, Stop, Center, Span

CW

SMC Setup...

SMC/VMC Power

Main

- Power Level
- RF Power
- Start Power
- Stop Power
- Power and Attenuators...
- SMC Setup...

Port Power

- Select
- Power Level
- Start Power
- Stop Power
- Source State
- Coupling

Leveling & Offset

- Select
- Slope
- Offset
- Limit
- Offset and Limits...

ALC Hardware (not available in M937xA/P937xA)

Receiver Leveling... (not available in M937xA/P937xA)

SMC/VMC Setup

Main

SMC Setup...

Meas Class...

Quick Start

Layout

New Trace

New Channel

New Window

New Sheet

Delete

Select

Measure

Meas Class...

System Setup

Next/Prev Keys : **Select Next/Previous window/channel/trace for the selected one**

Preferences...

Sound: **Turn On/Off beep sound**

Remote Interface...

Internal Hardware

PXI Devices

Pulse Gen Config...

Ext Reference

External Hardware

External Device...

Power Meter Setup...

Millimeter Config...

SMC/VMC Sweep

Main

Number of Points

Sweep Type

Start

Stop

X-axis Type

SMC Setup...

Sweep Timing

Sweep Time

Dwell Time

Sweep Delay

Source Control

Pulse Setup... (not available on M937xA/P937xA)

Embedded LO...

Standard Avg BW

Main

- Averaging
- Averaging Restart
- Average Type
- IF Bandwidth
- LF Auto BW

Smoothing

- Smoothing
- Smooth Percent
- Smooth Points

Delay Aperture

- Aperture Percent
- Aperture Points
- Aperture Freq

Standard Cal

Main

Basic Cal...

Other Cals

Cal All...

Smart Cal...

E Cal...

Receiver Power Cal... (not available in M937xA, P937xA)

Response Cal... (not available in M937xA and E5080A)

Source Power Cal... (not available in M937xA, P937xA)

Mixer Characterization... (When S9x082A/B or opt 009 is installed)

Correction

Factory Cal

Interpolation

Correction Methods

Correction Properties

Port Extension

Select

Port Extension

Time

Distance

Velocity Factor

DC Loss

Port Extensions...

Auto Port Extension...

Cal Sets & Cal Kits

Cal Set...

Cal Set Viewer

Cal Kit...

Ecal

Show Connected ECals...

Restore ECal Memory...

ECal Confidence Check...

Characterize ECal...

Manage ECal Disk Memory...

Cal Pod...

Fixtures

Apply Fixtures

Power Comp...

Fixture Setup

Port Match...

Port Z...

2-port DeEmbed...

N-port DeEmbed...

Differential Port Match...

Differential Z...

Common Z...

Cal Plane Manager...

Auto Fixture Removal

Standard Freq

Main

Start, Stop, Center, Span, Step

CW

Frequency Offset...

Standard Meas

S-param

Sxy

Meas Class...

Balanced

Sssxy, Sdsxy, Ssdxy, Sddxy

Topology

Receivers

A-D/R1-4 Source Port 1-4

Waves

a1-4/b1-4 Source Port 1-4

Auxiliary (Only with M9341B)

AuxIn(N) Source Port (N)

AuxIn(N) Range

Meas Setup

Conversions

Correction

Trace Hold

Equation Editor

Memory

Time Domain

Standard Power

Main

- Power Level
- RF Power
- Start Power
- Stop Power
- Power and Attenuators...

Port Power

- Select
- Power Level
- Start Power
- Stop Power
- Source State
- Coupling

Leveling & Offset

- Select
- Slope
- Offset
- Limit
- Offset and Limits...
- ALC Hardware (not available in M937xA/P937xA/M980xA/P50xxA)
- Receiver Leveling... (not available in M937xA/P937xA)

Standard Setup

Main

- Sweep Setup...
- Meas Class...
- Quick Start
- Device Expert...

Layout

- New Trace
- New Channel
- New Window
- New Sheet
- Delete
- Select
- Measure
- Meas Class...

System Setup

- Next/Prev Keys : **Select Next/Previous window/channel/trace for the selected one**
- Preferences...
- Sound: **Turn On/Off beep sound**
- Remote Interface...

Internal Hardware

- PXI Devices
- Receiver Gain (M980xA/P50xxA only)
- Pulse Gen Config...
- PXI Devices
- Ext Reference

External Hardware

- External Device...
- Power Meter Setup...

Standard Sweep

Main

- Number of Points
- Sweep Type
- Start (Frequency sweep, Power Sweep)
- Stop (Frequency sweep, Power Sweep)
- Sweep Setup...

Sweep Timing

- Sweep Time
- Dwell Time
- Sweep Delay
- Sweep Sequence

Source Control

- Frequency Offset...
- Pulse Setup... (not available in M937xA/P937xA)
- Balanced Source... (not available in M937xA/P937xA)
- Shift LO (not available in M937xA/P937xA)

Segment Table

- Add Segment, Insert Segment, Delete Segment, Delete All Segments
- Segment Table...
- Show Table

Millimeter Wave Configuration

Overview

Supported Applications

Starting and Exiting Millimeter Wave Mode

Millimeter Configuration

Calibration

Installation Cal

Remote Programming Commands

Accessing Data

See [8510 data processing mode](#).

See larger [Data Processing map](#).

Measurement - Receivers gather complex trace data which is ratioed if required by the parameter, such as S11 or A/B. Otherwise it is raw receiver data, such as A or B. See **Measurement Parameters**.

Averaging - If turned ON, data is averaged with specified number of measurement traces. See **Averaging**.

Data Access Point 0 - Get or Put RAW MEASUREMENT data using:

SCPI - Write data using [Calc:Data SDATA](#) - Read data from Data Access Point 1

COM - `getData` and `putDataComplex` - `naRawData (0)`

Formatting Note:

COM - `getData` allows you to request data from locations 0 to 5 in a format other than the displayed format. SMOOTHED data is only attainable from locations 2 & 4, and only when you request data in the same format as the displayed format.

SCPI - you can only request data in the displayed format.

Acquired Cal Data - Calibration standards are measured. When the calibration is complete, complex data is stored in a Cal Set.

Data Access Point 6 - Get or Put RAW CAL ACQUISITION data using:

SCPI - None

COM - `getStandardComplex` and `putStandardComplex`

Calculate Error Terms - Error terms are calculated from Acquisition data using formulas which are appropriate for the selected calibration method. Complex error terms are stored in a Cal Set. See **Systematic Errors**.

Data Access Point 5 - Get or Put ERROR TERM data using:

SCPI - [Calc:Data Error Terms](#)

COM - [Error Term commands](#)

Note: Normalization, formerly access location 5, no longer exists and was used ONLY by [Receiver Power Cal](#). That cal type now uses Acquire Cal Data and Calculate Error Terms like all other Cals.

Apply Error Terms - If error correction is ON, error terms are applied to the raw measurement data. Otherwise, this data is identical to Raw Measurement Data. In addition, the **Fixture Simulator** functions occur at the same time as the Apply Error Terms block.

Data Access Point 1 - Get or Put CORRECTED data using:

SCPI - Read data using **Calc:Data SDATA** - Write data to Data Access Point 0

COM - getData and putDataComplex - naCorrectedData (1)

See [Formatting Note](#)

Equation Editor - Allows custom equations to perform advanced math operations between data traces. See **Equation Editor**

See **Equation Editor Notes**:

SCPI: **Calc:Data**

COM: Get Data Method or Get DataByString Method.

Normalization - No longer available

Data Access Point 5 - - No longer available

Trace Math - When turned ON, memory data is combined with measurement data using the selected math function. Available functions are: Data+Mem, Data-Mem, Data*Mem, and Data/Mem. See **Math Operations**.

Memory - Data that is stored as a result of a **Data-To-Memory** operation. Each measurement can have one memory trace. The memory data parallels the measurement data through the remaining processing blocks. For example, turning smoothing ON will smooth both the measurement and memory traces.

Data Access Point 3 - Get or Put MEMORY data using:

SCPI - **Calc:Data SMEM**

COM - getData and putDataComplex - naRawMemory (3)

See [Formatting Note](#)

Gating - When turned ON, Filter Gating is applied to the measurement data. Gating "virtually" removes undesired responses from selected regions of the trace. See **Gating**.

Phase Correction - When turned ON, applies **electrical delay**, **phase offset**, and **port extensions**. These are all separate features that are controlled individually.

Magnitude Offset - When entered, offset values are applied to the magnitude (real) portion of the data. See **Magnitude Offset**.

Time Domain - When turned ON, transforms the data from the frequency domain to the time domain. See **Time Domain**

Formatter - Complex data is converted into scalar data formats for screen display and remote access. For smoothed data, request the data in the same format as the displayed data. See **Data Format**

Smoother - When turned ON, removes discontinuities in the measurement and memory trace. See **Smoothing**.

Display - Displays the processed measurement, memory data, or both, in the format of your choice.

Data Access Point 2 - Get or Put MEAS RESULT data using:

SCPI - **Calc:Data** FDATA

COM - getData and putDataComplex - naMeasResult (2)

Data Access Point 4 - Get or Put MEMORY RESULT data using:

SCPI - **Calc:Data** FMEM

COM - getData and putDataComplex - naMemoryResult (4)

See **Formatting Note**

CFCal Topic

[Unguided](#) | [SmartCal \(Guided\)](#) | [ECAL](#) | [Guided Power Cal](#) | [Cal All](#) | [Save-Recall](#) | [Cal Sets](#) | [Cal Types](#) | [Prefer's Correction](#) | [Port Ext](#) | [Fixturing](#) | [CPM](#) | [Cal Kits](#) | [Standards](#) | [Multiple Sensors](#) | [Source Pwr Cal](#) | [Power Sensors](#) | [Receiver Cal](#) | [Cal Data](#) | [CalPod](#) | [Custom Cal Window](#) | [AFR](#)

SCPI	
Description	See Also: Calibration commands for Apps
Perform an Unguided Calibration	
Launch Cal Wizard	SYSTem:CORRection:WIZard
Set Cal Type	SENSe:CORRection:COLLect:METhod
Select a Cal Kit	SENSe:CORRection:COLLect:CKIT
Get a Handle to the Active Cal Kit	None
Simultaneous 2-Port Calibration	SENSe:CORRection:TSTandards
Acquisition Direction	SENSe:CORRection:SFORward
Measure a Standard	SENSe:CORRection:COLLect
Calculate Errors	SENSe:CORRection:COLLect:SAVE
Do Isolation	SENSe:CORRection:COLLect
Perform and apply Response (Normalization) cal	SENSe:CORRection:COLLect:METhod

Perform a Guided Cal	
Initiate a Guided Cal	SENSe:CORRection:COLLect:GUIDed:INITiate
List valid Connector Types for a Port	SENSe:CORRection:COLLect:GUIDed:CONNector:CATalog?
List valid Cal Kits for a Connector type.	SENSe:CORRection:COLLect:GUIDed:CKIT:CATalog?
Select a Connector Type	SENSe:CORRection:COLLect:GUIDed:CONNector:PORT
Select a Cal Kit	SENSe:CORRection:COLLect:GUIDed:CKIT:PORT

Set cal method for each port pair.	SENSe:CORRection:COLLect:GUIDed:PATH:CMETHod
Set Thru Method for each port pair.	SENSe:CORRection:COLLect:GUIDed:PATH:TMETHod
Set Thru Port Pairs	SENSe:CORRection:COLLect:GUIDed:THRU:PORTs
Return Number of Steps in a Cal	SENSe:CORRection:COLLect:GUIDed:STEPs?
Return a Description of a Cal Step	SENSe:CORRection:COLLect:GUIDed:DESCRiption?
Measure a Cal Standard in a Guided Cal	SENSe:CORRection:COLLect:GUIDed:STAN
Save Cal	SENSe:CORRection:COLLect:GUIDed:SAVE
Return Number of Steps in a Cal	SENSe:CORRection:COLLect:GUIDed:LIST:COUNT?
Return number of standards for step[n]	SENSe:CORRection:COLLect:GUIDed:LIST:STEP:COUNT?
Return step description	SENSe:CORRection:COLLect:GUIDed:LIST:STEP:DESCRiption?
Return label for complete standard	SENSe:CORRection:COLLect:GUIDed:LIST:STEP:LABel?
Return number of ports on standard used in the step	SENSe:CORRection:COLLect:GUIDed:LIST:STEP:PORTs?
Return label for one of the standards in the step	SENSe:CORRection:COLLect:GUIDed:LIST:STEP:STANdard:LABel?
Return number of ports on one of the standards used in the step	SENSe:CORRection:COLLect:GUIDed:LIST:STEP:STANdard:PORTs?
Return the enumeration for the type of standard	SENSe:CORRection:COLLect:GUIDed:LIST:STEP:STANdard:STYPE?

Return list of VNA test ports to which one of the standards is attached	SENSe:CORRection:COLLect:GUIDed:LIST:STEP:STANdard:TPORts?
Return enumeration for the type of standard device used in the step	SENSe:CORRection:COLLect:GUIDed:LIST:STEP:STYPe?
Return list of VNA test ports to which the standard(s) in this step is attached	SENSe:CORRection:COLLect:GUIDed:LIST:STEP:TPORts?
Return measurement parameters measured in the specified step number of a guided calibration	SENSe:CORRection:COLLect:GUIDed:DATA:CATalog?
Set and return measurement data for a specified measurement parameter of a particular step of a guided cal	SENSe:CORRection:COLLect:GUIDed:DATA
Return list of ports being calibrated by an active calibration session	SENSe:CORRection:COLLect:GUIDed:PORTs?

Adapter settings for Unknown Thru or Adapter Removal	
Sets use of a THRU adapter	SENSe:CORRection:COLLect:GUIDed:ADAPter:CREate
Set adapter delay	SENSe:CORRection:COLLect:GUIDed:ADAPter:DELay
Set adapter description	SENSe:CORRection:COLLect:GUIDed:ADAPter:DESCRiption
Set port pairs for adapter	SENSe:CORRection:COLLect:GUIDed:ADAPter:PATHs

Clear the settings	<code>SENSe:CORRection:COLLect:GUIDed:ADAPter:COUNt:ZERO</code>
Return number of adapters	<code>SENSe:CORRection:COLLect:GUIDed:ADAPter:COUNt?</code>

Optional Guided Cal commands	
Auto-Orient ECal	<code>SENSe:CORRection:PREFerece:ECAL:ORientation</code>
Manual orient ECAL	<code>SENSe:CORRection:PREFerece:ECAL:PMAP</code>
Read orientation	<code>SENSe:CORRection:CKIT:ECAL:ORlent?</code>
Calculate Error Terms from a Guided Cal	<code>SENSe:CORRection:COLLect:GUIDed:SAVE</code>
Save Cal to an existing Cal Set GUID	<code>SENSe:CORRection:COLLect:GUIDed:SAVE:CSET</code>
Load Eterms during a cal	<code>SENSe:CORRection:COLLect:GUIDed:ETERms:LOAD</code>
Perform Isolation	<code>SENSe:CORRection:COLLect:GUIDed:ISOLation:PATHs</code>
Increment Avg for Isolation	<code>SENSe:CORRection:COLLect:GUIDed:ISOLation:AVERage:INCRement</code>
Abort Guided cal	<code>SENSe:CORRection:COLLect:GUIDed:ABORT</code>
Execute the Ecal calibration	<code>SENSe:CORRection:COLLect:GUIDed:ECAL:ACQuire</code>
Specifies the Ecal Kit for Ecal Calibration	<code>SENSe:CORRection:COLLect:GUIDed:ECAL:SElect</code>
Compute Error Terms	<code>SENSe:CORRection:COLLect:GUIDed:ETERms:COMPute</code>

Guided Power Cal	
Use standard Source Power commands to make advanced settings. Use Power Sensor commands to configure the power sensor.	
Perform power cal	<code>SENSe:CORRection:COLLect:GUIDed:PSEnSor</code>
Power sensor connector type	<code>SENSe:CORRection:COLLect:GUIDed:PSEnSor:CONNector</code>

Cal Kit for power cal	<code>SENSe:CORRection:COLLect:GUIDed:PSEnSor:CKIT</code>
Power Level for cal	<code>SENSe:CORRection:COLLect:GUIDed:PSEnSor:POWEr:LEVel</code>
Perform match-correction	<code>SENSe:CORRection:METhods:MATCh</code>
Sets and returns the selected ports to include in a full NPort correction.	<code>SENSe:CORRection:METhods:PORT:SUBSet:FULL[:VALue]</code>
Resets the full and response list to their default values.	<code>SENSe:CORRection:METhods:PORT:SUBSet:RESet</code>
Sets and returns the selected ports to be corrected with enhanced response calibration.	<code>SENSe:CORRection:METhods:PORT:SUBSet:RESPonse[:VALue]</code>
Set and return the ON/OFF subset correction state.	<code>SENSe:CORRection:METhods:PORT:SUBSet[::STATe]</code>
Load Power Table	<code>SENSe:CORRection:COLLect:GUIDed:PSEnSor:POWTable</code> Used with SMC on mmWave systems.

Perform Enhanced Response Cal	
Set guided Cal method	<code>SENSe:CORRection:COLLect:GUIDed:PATH:CMETHod</code>
Set guided Thru method	<code>SENSe:CORRection:COLLect:GUIDed:PATH:TMETHod</code>

Perform Sliding Load Acquisition

Set preference to not prompt	SENSe:CORRection:COLLect:GUIDed:PREFerence:SLIDingload
Read iteration step	SENSe:CORRection:COLLect:GUIDed:ITERations:COUNT?
Read minimum iterations	SENSe:CORRection:COLLect:GUIDed:ITERations:MINimum?
Reset iterations	SENSe:CORRection:COLLect:GUIDed:ITERations:RESet

Perform an ECAL	
Specify Module and Characterization	SENSe:CORRection:COLLect:ACQuire
Do ECAL 1-Port	SENSe:CORRection:COLLect:CKIT 99
Do ECAL 2-Port	SENSe:CORRection:COLLect:CKIT 99
Get ECAL Module Info	SENSe:CORRection:COLLect:CKIT:INFormation? SENSe:CORRection:CKIT:ECAL:INFormation?
Get list of ECal Modules attached to PNA	SENSe:CORRection:CKIT:ECAL:LIST?
Get list of characterizations in ECal module	SENSe:CORRection:CKIT:ECAL:CLISt?
Perform Module Orientation during calibration	SENSe:CORRection:PREFerence:ECAL:ORientation
Maps ECAL Module to PNA Ports	SENSe:CORRection:PREFerence:ECAL:PMAP
Reads ECal orientation	SENSe:CORRection:CKIT:ECAL:ORient?
Perform ECal Isolation	SENSe:CORRection:COLLect:ISOLation:ECAL
Increment Avg for ECal Isolation	SENSe:CORRection:COLLect:ISOLation:AVERage:INCRement
Return the ID string of ECals	SYSTem:COMMunicate:ECAL:CATalog?
Return a list of characterizations	SYSTem:COMMunicate:ECAL:CLISt?
Return the number of installed cal kits	SYSTem:COMMunicate:ECAL:COUNT?

Delete user characterizations from VNA disk memory	SYSTem:COMMunicate:ECAL:DMEMory:CLEar
Import file into VNA disk memory	SYSTem:COMMunicate:ECAL:DMEMory:IMPorT
Save existing ECal characterization to a file	SYSTem:COMMunicate:ECAL:EXPorT
Read identification and characterization information for ECal module	SYSTem:COMMunicate:ECAL:INForMation?
Read identification and characterization information from ECal module or VNA disk memory	SYSTem:COMMunicate:ECAL:KNAME:INForMation?
Return list of index numbers for ECal modules	SYSTem:COMMunicate:ECAL:LIST?
Return number of unique states for specified path name on selected ECal module	SYSTem:COMMunicate:ECAL:PATH:COUNt?

Perform ECal User Characterizations	
Perform User ECal Characterization	All SCPI commands
Manage PNA Disk Memory Characterizations	
Delete disk memory characterizations.	SENSe:CORRection:CKIT:ECAL:DMEMory:CLEar
Saves a disk memory characterization to an archive file.	SENSe:CORRection:CKIT:ECAL:EXPorT
Imports the ECal characterization from the specified archive file.	SENSe:CORRection:CKIT:ECAL:DMEMory:IMPorT
Reads the user-characterization info from ECal module or PNA disk memory.	SENSe:CORRection:CKIT:ECAL:KNAME:INForMation?

ECal Confidence Check	
Confidence Check Parameter	SENSe:CORRection:CCHeck:PARAmeter
Confidence Check Acquire	SENSe:CORRection:CCHeck
Confidence Check Done	SENSe:CORRection:CCHeck:DONE
Set/Read ECal State	
Sets the state of an ECAL module	CONTRol:ECAL:MODUle:PATH:STATe
Read ECal state data	SENSe:CORRection:CKIT:ECAL:PATH:DATA?
Read number of ECal states for specified path	CONTRol:ECAL:MODUle:PATH:COUNT? SENSe:CORRection:CKIT:ECAL:PATH:COUNT?

Calibrate All Channels	
Select the channels to be calibrated.	SYSTem:CALibrate:ALL:SElect
Set the IFBW	SYSTem:CALibrate:ALL:IFBW
Set the power level	SYSTem:CALibrate:ALL:PORT:SOURce:POWER
Set the power offset	SYSTem:CALibrate:ALL:PORT:SOURce:POWER:OFFSet
Set the receiver atten	SYSTem:CALibrate:ALL:PORT:RECeiver:ATTen
Set the source atten	SYSTem:CALibrate:ALL:PORT:SOURce:POWER:ATTen
Set the User Calset Prefix	SYSTem:CALibrate:ALL:CSET:PREFix
Read unique Cal properties	SYSTem:CAL:ALL:MCLass:PROPerTy:NAME:CATalog?

Read unique property values	SYSTem:CAL:ALL:MCLass:PROPerTy:VALue:CATalog?
Set property name/value	SYSTem:CAL:ALL:MCLass:PROPerTy:VALue
Read primary Cal channel	SYSTem:CALibrate:ALL:GUIDed:CHANnel[:VALue]?
Get GuidedCal handle	None
For each channel, sets the ports to be calibrated.	SYSTem:CALibrate:ALL:CHANnel:PORTs
Returns a final list of ports to be calibrated.	SYSTem:CALibrate:ALL:GUIDed:PORTs?
Read generated Cal Sets	SYSTem:CALibrate:ALL:CSET:CATalog?
Returns all cal all guided calibration channels	SYSTem:CALibrate:ALL:GUIDed:CHANnel:LIST?
Returns available ports for independent power calibration.	SYSTem:CALibrate:ALL:INDEpendent:SOURce:CALibrate:CATalog?
Adds a power cal range for a specific port <n>.	SYSTem:CALibrate:ALL:INDEpendent:SOURce:CALibrate:RANGe:AD D
Resets all ranges for the given source port <n>.	SYSTem:CALibrate:ALL:INDEpendent:SOURce:CALibrate:RANGe:CLE ar
Queries how many ranges are	SYSTem:CALibrate:ALL:INDEpendent:SOURce:CALibrate:RANGe:CO UNT?

included in the calibration for source port <n>.	
Sets and gets the number of points for range <m> for source port<n>.	SYSTem:CALibrate:ALL:INDePendent:SOURce:CALibrate:RANGe:POINts
Sets and gets the start frequency for range <m> for source port<n>.	SYSTem:CALibrate:ALL:INDePendent:SOURce:CALibrate:RANGe:START
Sets and gets the stop frequency for range <m> for source port<n>.	SYSTem:CALibrate:ALL:INDePendent:SOURce:CALibrate:RANGe:STOP

Recall / Save / Apply a Calibration or Error Term	
Recall a Calibration	SENSe:CORRection:CSET
Apply a Calibration to a measurement	SENSe:CORRection:CSET
Save a Calibration	SENSe:CORR:CSET:SAVE
Save or Recall an Error Term	CALCulate:DATA Scorr
Read/ Write Cal Set data	SENSe:CORRection:CSET:DATA

Apply an Error Term after Uploading	SENSe:CORRection:COLLect:APPLy
Cal Sets	
Quickly test a prototype of automation software	SENSe:CORRection:CSET:CREate:DEFault
Create a Cal Set	SENSe:CORRection:CSET:CREate
Delete a Cal Set	SENSe:CORRection:CSET:DELEte
List Cal Sets	CSET:CATalog?
List Cal Sets in VNA	None
Get Cal Set Information	None
List Cal Set Error Terms	SENSe:CORRection:CSET:ETERM:CATalog?
Return if a Cal Set exists	CSET:EXISts?
Converts calset to S-parameter plus power calibration	SENSe:CORRection:CSET:GENerate:RECeiver
Select a Cal Set by GUID	SENSe:CORRection:CSET:ACTivate
Apply a Cal Set to a channel	SENSe:CORRection:CSET:ACTivate
Copy a Cal Set	SENSe:CORRection:CSET:COpy
Save a Cal Set	SENSe:CORRection:CSET:SAVE
Save Cal Sets	None
Automatically save to User Cal Set	SENSe:CORRection:PREFErence:CSET:SAVE
Change the Description of a Cal Set	SENSe:CORRection:CSET:DESCRiption
Change the Name of a Cal Set	SENSe:CORRection:CSET:NAME
Recall a Cal File	MMEMory:LOAD
Save 'in-memory' Cal Set to disk.	SENSe:CORRection:CSET:FLATten
Create Cal Set with De-embedded fixture removed.	CSET:FIXTure:DEEMbed
Create Cal Set with Matching Network included.	CSET:FIXTure:EMBed

Adds stimulus data to a specific buffer.	None
Returns the stimulus values over which the specific error term was acquired.	None
Returns FOM stimulus values from a Calset.	SENSe:CORRection:CSET:STIMulus?
Returns the Cal Types from the calset.	None
Returns the properties of the calset.	None
Returns the numbers of the channels using the calset.	None
Unselect Cal Set	SENSe:CORRection:CSET:DEACTivate

Cal Set Items	
Returns names of the items in a cal set	SENSe:CORRection:CSET:ITEM:CAT?
Remove name-value pair from cal set	None
Read the value of the Cal Set item.	SENSe:CORRection:CSET:ITEM[:DATA]?
Enumerate name-value pair items in the cal set.	None

Apply Cal Types	
Catalog ALL Cal Types for the PNA	SENSe:CORRection:TYPE:CATalog?
Catalog Cal Types in the Cal Set	SENSe:CORRection:CSET:TYPE:CATalog?
Is a specific Cal Type contained in the Cal Set?	None
Set and return the measurement Cal Type	CALCulate:MEASure:CORRection:TYPE
Set port to measure QSOLT reflection standards.	None

Correction Settings	
Turn Correction ON OFF for a channel	SENSe:CORRection
Turn Correction ON OFF for a measurement	CALCulate:MEASure:CORRection[:STATe]
Interpolation ON OFF	SENSe:CORRection:INTerpolate
Returns the error correction state for the measurement	CALCulate:MEASure:CORRection:INDicator?

Preferences	
Set default Cal Set Save behavior	SENSe:CORRection:PREFeRence:CSET:SAVE
Sets behavior for simulated cal	SENSe:CORRection:PREFeRence:SIMCal
External or internal trigger during cal	SENSe:CORRection:PREFeRence:TRIG:FREE
Set ECal Auto-orient	SENSe:CORRection:PREFeRence:ECAL:ORlentation
Set ECal Port Map	SENSe:CORRection:PREFeRence:ECAL:PMAP
Set default Cal Type	None

Port Extensions	
Extensions ON OFF	SENSe:CORRection:EXTension
Port 1 Extensions Value	SENSe:CORRection:EXTension:PORT
Port 2 Extensions Value	SENSe:CORRection:EXTension:PORT
Set Freq 1 2	SENSe:CORRection:EXTension:PORT:FREQuency
Set Loss 1 2	SENSe:CORRection:EXTension:PORT:LOSS
Use 1 2	SENSe:CORRection:EXTension:PORT:INCLude
Set Loss at DC	SENSe:CORRection:EXTension:PORT:LDC

Relative Velocity	SENSe:CORRection:RVELOCITY:COAX
Port Ext in distance	SENSe:CORRection:EXTension:PORT:DIStance
Set distance units	SENSe:CORRection:EXTension:PORT:UNIT
Set Media per port	SENSe:CORRection:EXTension:PORT:MEDIum
Set waveguide cutoff freq per port	SENSe:CORRection:EXTension:PORT:WGCutoff
Set Velocity Factor per port	SENSe:CORRection:EXTension:PORT:VELFactor
Couple to system Velocity Factor	SENSe:CORRection:EXTension:PORT:SYSVelocity
Couple to system Media type	SENSe:CORRection:EXTension:PORT:SYSMedia

Auto Port Extensions	
Measure OPEN or SHORT for Auto Port Ext.	SENSe:CORRection:EXTension:AUTO:MEASure
Sets the frequencies used for Auto Port Ext. calculation.	SENSe:CORRection:EXTension:AUTO:CONFIg
Include loss correction in Auto Port Ext.?	SENSe:CORRection:EXTension:AUTO:LOSS
Include DC Offset in Auto Port Ext.?	SENSe:CORRection:EXTension:AUTO:DCOFFset
Enable specified port for Auto Port Ext..	SENSe:CORRection:EXTension:AUTO:PORT<n>
Clears old port extension delay and loss data.	SENSe:CORRection:EXTension:AUTO:RESet
Set user span start frequency for Auto Port Ext.	SENSe:CORRection:EXTension:AUTO:STARt
Set user span stop frequency for Auto Port Ext.	SENSe:CORRection:EXTension:AUTO:STOP

Fixturing Commands
 See also [Ground Loop De-embedding/Embedding](#) commands

Turn fixturing ON and OFF	CALCulate:FSIMulator:STATe
Change order of operations	CALCulate:FSIMulator:SENDEd:OORder
2and 4-port Extrapolate	CALCulate:FSIMulator:SNP:EXTRapolate
2-Port Fixturing	
Port matching ON and OFF	CALCulate:FSIMulator:SENDEd:PMCircuit:STATe
Reverse ports	CALCulate:FSIMulator:SENDEd:DEEMbed:PORT<n>:SNP:REVerse
Sets Port Matching circuit model.	CALCulate:FSIMulator:SENDEd:PMCircuit:PORT:TYPE
Sets Port Matching 'S2P' file name.	CALCulate:FSIMulator:SENDEd:PMCircuit:PORT:USER:FILEname
Sets Capacitance 'C' value.	CALCulate:FSIMulator:SENDEd:PMCircuit:PORT:PARAmeters:C
Sets Conductance 'G' value.	CALCulate:FSIMulator:SENDEd:PMCircuit:PORT:PARAmeters:G
Sets Inductance 'L' value.	CALCulate:FSIMulator:SENDEd:PMCircuit:PORT:PARAmeters:L
Sets Resistance 'R' value.	CALCulate:FSIMulator:SENDEd:PMCircuit:PORT:PARAmeters:R
De-embed ON and OFF	CALCulate:FSIMulator:SENDEd:DEEMbed:STATe
Sets De-embedding circuit model.	CALCulate:FSIMulator:SENDEd:DEEMbed:PORT
Sets De-embedding 'S2P' file name.	CALCulate:FSIMulator:SENDEd:DEEMbed:PORT:USER:FILEname
Port Impedance ON and OFF	CALCulate:FSIMulator:SENDEd:ZCONversion:STATe
Port Z Real	CALCulate:FSIMulator:SENDEd:ZCONversion:PORT:REAL
Port Z Imag	CALCulate:FSIMulator:SENDEd:ZCONversion:PORT:IMAG
Port Z Real and Imag	CALCulate:FSIMulator:SENDEd:ZCONversion:PORT:Z0
4-Port Network Embed/De-embed commands	
Specifies the PNA / DUT topology	CALCulate:FSIMulator:EMBEd:TYPE
Specifies the 4-port touchstone file	CALCulate:FSIMulator:EMBEd:NETWork:FILEname

Embed De-embed?	CALCulate:FSIMulator:EMBed:NETWork:TYPE
Specify PNA port connections	CALCulate:FSIMulator:EMBed:TOPology:A:PORTs CALCulate:FSIMulator:EMBed:TOPology:B:PORTs CALCulate:FSIMulator:EMBed:TOPology:C:PORTs CALCulate:FSIMulator:EMBed:TOPology:D:PORTs
4-port remap	CALCulate:FSIMulator:EMBed:NETWork<n>:PMAP
Turn ON or OFF	CALCulate:FSIMulator:EMBed:STATe
Maps the physical VNA ports to a device of balanced and single-ended logical ports for multi-port systems with greater than 4 ports	CALCulate:DTOPology
Differential Port Arbitrary Impedance	
Sets the impedance value	CALCulate:FSIMulator:BALun:DZConversion:BPORT:Z0
Sets real part of impedance	CALCulate:FSIMulator:BALun:DZConversion:BPORT:REAL
Sets imaginary part of impedance	CALCulate:FSIMulator:BALun:DZConversion:BPORT:IMAG
Turn ON or OFF	CALCulate:FSIMulator:BALun:DZConversion:STATe
Common Mode Port Arbitrary Impedance	
Sets the impedance value	CALCulate:FSIMulator:BALun:CZConversion:BPORT:Z0
Sets real part of impedance	CALCulate:FSIMulator:BALun:CZConversion:BPORT:REAL
Sets imaginary part of impedance	CALCulate:FSIMulator:BALun:CZConversion:BPORT:IMAG
Turn ON or OFF	CALCulate:FSIMulator:BALun:CZConversion:STATe
Differential Port Matching	
Sets type of circuit to embed.	CALCulate:FSIMulator:BALun:DMCircuit:BPORT
Specifies the 2-port touchstone file	CALCulate:FSIMulator:BALun:DMCircuit:BPORT:USER:FILENAME

Sets Capacitance value	CALCulate:FSIMulator:BALun:DMCircuit:BPORt:PARAmeters:C
Sets Conductance value	CALCulate:FSIMulator:BALun:DMCircuit:BPORt:PARAmeters:G
Sets Inductance value	CALCulate:FSIMulator:BALun:DMCircuit:BPORt:PARAmeters:L
Sets Resistance value	CALCulate:FSIMulator:BALun:DMCircuit:BPORt:PARAmeters:R
Turns ON/OFF	CALCulate:FSIMulator:BALun:DMCircuit:STATe
Power Compensation	
Compensate source power	CALCulate:FSIMulator:SENDEd:POWER:PORT:COMPensation
Remote ONLY	
Create Cal Set with De-embedded fixture removed.	CSET:FIXTure:DEEMbed
Create Cal Set with Matching network included.	CSET:FIXTure:EMBed

Cal Plane Manager	SCPI
Characterize a fixture	CSET:FIXTure:CHARacterize
Creates a single S2P file from two existing files.	CSET:FIXTure:CASCade

Manage and Modify Cal Kits	
Set a Cal Kit Active	SENSe:CORRection:COLLect:CKIT
Clear all Cal Kits from PNA	SENSe:CORRection:CKIT:CLEar
Get a Handle to the Active Cal Kit	None
Save All Cal Kits after Modifying	None
Load collection of Kits	SENSe:CORRection:CKIT:LOAD

Load (Recall) All Cal Kits	None
Import a specified kit.	SENSe:CORRection:CKIT:IMPort
Restore Cal Kit Default	SENSe:CORRection:COLLect:CKIT:RESet
Restore ALL Cal Kits Default	SENSe:CORRection:CKIT:INITialize
Build a Hybrid Cal Kit	None
Set the Name of a Cal Kit	SENSe:CORRection:COLLect:CKIT:NAME
Set a description of a Cal Kit	SENSe:CORRection:COLLect:CKIT:DESCRiption
Get the amount of installed kits	SENSe:CORRection:CKIT:COUNt?
Set the Port Label of a Cal Kit	None
Saves a Cal Kit to a file.	SENSe:CORRection:CKIT:EXPort

Modify TRL Cal Kit	
Set reference plane	SENSe:CORRection:COLLect:CKIT:TRLOption:RPLane
Set impedance standard	SENSe:CORRection:COLLect:CKIT:TRLOption:IMPedance
Set LRL auto-characterization	SENSe:CORRection:COLLect:CKIT:TRLOption:LRLChar

Modify Cal Standards	
Select a Cal Standard	SENSe:CORRection:COLLect:CKIT:STANdard
Delete a standard	SENSe:CORRection:COLLect:CKIT:STANdard:REMOve
Change description of a standard	SENSe:CORRection:COLLect:CKIT:STANdard:SDESCRiption
Assign a Class to a Standard	SENSe:CORRection:COLLect:CKIT:ORDer1
Set Standard Type	SENSe:CORRection:COLLect:CKIT:STANdard:TYPE
Add connector family name	SENSe:CORRection:COLLect:CKIT:CONNector:ADD
Delete connector family name	SENSe:CORRection:COLLect:CKIT:CONNector:DELeTe
List connector family names used in a Cal Kit	SENSe:CORRection:COLLect:CKIT:CONNector:CATalog?

Replace connector family name.	<code>SENSe:CORRection:COLLect:CKIT:CONNector:FNAME</code>
Assign connector family name to a standard	<code>SENSe:CORRection:COLLect:CKIT:CONNector:SNAME</code>
Set Delay	<code>SENSe:CORRection:COLLect:CKIT:STANdard:DELay</code>
Set Loss	<code>SENSe:CORRection:COLLect:CKIT:STANdard:LOSS</code>
Set Impedance	<code>SENSe:CORRection:COLLect:CKIT:STANdard:IMPedance</code>
Set Max Frequency	<code>SENSe:CORRection:COLLect:CKIT:STANdard:FMAXimum</code>
Set Min Frequency	<code>SENSe:CORRection:COLLect:CKIT:STANdard:FMINimum</code>
Set Label	<code>SENSe:CORRection:COLLect:CKIT:STANdard:LABel</code>
Set Medium (coax waveguide)	<code>SENSe:CORRection:COLLect:CKIT:STANdard:CHARacter</code>
Set Capacitance (C0 to C3)	<code>SENSe:CORRection:COLLect:CKIT:STANdard:C0</code>
Set Inductance (L0 to L3)	<code>SENSe:CORRection:COLLect:CKIT:STANdard:L0</code>
Set Arbitrary Impedance (TZReal, TZImag)	<code>SENSe:CORRection:COLLect:CKIT:STANdard:TZReal</code>

Modify TRL Cal Kit	
Set reference plane	<code>SENSe:CORRection:COLLect:CKIT:TRLOption:RPLane</code>
Set impedance standard	<code>SENSe:CORRection:COLLect:CKIT:TRLOption:IMPedance</code>
Set LRL auto-characterization	<code>SENSe:CORRection:COLLect:CKIT:TRLOption:LRLChar</code>

Multiple Power Sensors
See commands to configure a Power Meter as Receiver (PMAR)

Enable multiple sensors	SENSe:CORRection:COLLect:GUIDed:PSENSor:MULTiple
Add sensors	SENSe:CORRection:COLLect:GUIDed:PSENSor:MULTiple:ADD
Assign power sensor name	SENSe:CORRection:COLLect:GUIDed:PSENSor:MULTiple:NAME
Remove sensors	SENSe:CORRection:COLLect:GUIDed:PSENSor:MULTiple:REMOve
Read the number of configured sensors	SENSe:CORRection:COLLect:GUIDed:PSENSor:MULTiple:COUNt?
Set start freq	SENSe:CORRection:COLLect:GUIDed:PSENSor:MULTiple:FREQuency:START
Set stop freq	SENSe:CORRection:COLLect:GUIDed:PSENSor:MULTiple:FREQuency:STOP
Set connector type	SENSe:CORRection:COLLect:GUIDed:PSENSor:MULTiple:CONNector
Set Cal Kit	SENSe:CORRection:COLLect:GUIDed:PSENSor:MULTiple:CKIT

Source Power Calibration	
Copy Source Power cal to another channel	SYSTem:MACRo:COPY:CHANnel:SOURce
 GPIB Power Meter Address	SYSTem:COMMunicate:GPIB:PMETer:ADDRess
Set source power cal method	SOURce:POWer:CORRection:COLLect:ACQ
Turn correction ON OFF	SOURce:POWer:CORRection
Applies correction values after completing a source power cal acquisition sweep. Optionally do reference receiver cal.	SOURce:POWer:CORRection:COLLect:SAVE
Returns the currently-selected power sensor channel (A or B) for use at a specific frequency.	None

Set power level	SOURce:POWer:CORRection:LEV
Set power offset	SOURce:POWer:CORRection:OFFSet
Set settling tolerance	SOURce:POWer:CORRection:COLLect:AVERAge:NTOLerance
Set max readings for settling	SOURce:POWer:CORRection:COLLect:AVERAge:COUNT
Set accuracy tolerance	SOURce:POWer:CORRection:COLLect:ITERation:NTOLerance
Set max readings for accuracy	SOURce:POWer:CORRection:COLLect:ITERation:COUNT
Turn ON OFF display of readings	SOURce:POWer:CORRection:COLLect:DISPlay
Acquire receiver-only readings	SOURce:POWer:CORRection:COLLect:ACQuire:REC
Initiates a source power cal acquisition.	SOURce:POWer:CORRection:COLLect:ACQuire
Aborts a source power cal acquisition sweep that is currently in progress.	SOURce:POWer:CORRection:COLLect:ABORt
Launches the Power Meter Settings dialog on the PNA.	None
Frequency checking (ON OFF)	SOURce:POWer:CORRection:COLLect:FCHeck
Check test port power	None
Calibrate the source at multiple power levels.	None
Specifies if the source power cal in the calset linked to a measurement cal should be enabled or disabled with that cal	None
Enable/disable use of error messages during a source calibration if calibration fails to achieve desired power level at the power sensor	SOURce:POWer:CORRection:COLLect:WARN

Power Meter/Sensor settings	
See commands to configure a Power Meter as Receiver (PMAR)	
See commands to configure multiple power sensors for guided Power Cal	
Specifies the type of power sensor to be used	SYSTem:COMMunicate:PSEnSor
Specifies the location of the power sensor to be used.	SYSTem:COMMunicate:PSEnSor
Returns the ID string of connected USB power meters / sensors.	SYSTem:COMMunicate:USB:PMETer:CATalog?
Pwr meter Max Readings for settling	SOURce:POWer:CORRection:COLLect:AVERage:COUNT
Pwr meter settling tolerance	SOURce:POWer:CORRection:COLLect:AVERage:NTOLerance
Minimum Frequency	SOURce:POWer:CORRection:COLLect:<>SEnSor
Maximum Frequency	SOURce:POWer:CORRection:COLLect:<>SEnSor
Power meter channel	None
Set sensor cal factor	SOURce:POWer:CORRection:COLLect:<>SEnSor:RCFactor
Set table type	SOURce:POWer:CORRection:COLLect:TABLE <>SEnSor
Read/Write cal data	SOURce:POWer:CORRection:DATA
Use Loss table?	SOURce:POWer:CORRection:COLLect:TABLE:LOSS
Cal Factor Table	SOURce:POWer:CORRection:COLLect:TABLE:SElect
Read number of segments in table	SOURce:POWer:CORRection:COLLect:TABLE:POINts?
Segment number	None
Add segment	None
Cal factor of the segment	SOURce:POWer:CORRection:COLLect:TABLE:DATA
Frequency of the segment	SOURce:POWer:CORRection:COLLect:TABLE:FREQuency
Power Loss Table	SOURce:POWer:CORRection:COLLect:TABLE:SElect

Read number of segments in table	SOURce:POWer:CORRection:COLLect:TABLE:POINts?
Segment number	None
Add segment	None
Frequency	SOURce:POWer:CORRection:COLLect:TABLE:FREQuency
Loss value	SOURce:POWer:CORRection:COLLect:TABLE:DATA
Receiver Cal	
Set offset from test port power	SENSe:CORRection:RPOWer:OFFSet[:AMPLitude]
Set cal method to receiver cal	SENSe:CORRection:COLLect:METhod RPOWer
Take measurement	SENSe:CORRection:COLLect[:ACQuire] POWer
Turn receiver cal ON OFF	SENSe:CORRection[:STATe] ON OFF
Do interpolation	SENSe:CORRection:INTerpolate[:STATe] ON OFF

CalPod	
Command used to send other commands as arguments	CONTRol:CALPod:COMMand
Start the CalPod software	Calpod:LAUNch
Assign Calpod serial number to a port.	Calpod:ENABle
Unassign Calpod serial number from a port.	Calpod:DisABle
Initialize the selected channel	Calpod:INITialize:ACTive
Initialize ALL channels	Calpod:INITialize:ALL
Recorrect the selected channel	Calpod:ReCORrect:ACTive
Recorrect ALL channels	Calpod:ReCORrect:ALL
Show refresh dialog	Calpod:SHOW
Hide refresh dialog	Calpod:HIDE

Sets impedance state	Calpod:STATE
Read Calpod temperature	Calpod:TEMP?

Custom Cal Window	
Turn ON OFF Custom Cal window.	SENSe:CORRection:COLLect:DISPlay:WINDow
Show NO Custom Cal windows.	SENSe:CORRection:COLLect:DISPlay:WINDow:AOff
Specify channel to sweep before Cal acquisition.	SENSe:CORRection:COLLect:SWEEp:CHANnel
Sweep NO channel before Cal acquisition.	SENSe:CORRection:COLLect:SWEEp:CHANnel:AOff
Preview sweep before remote Cal acquisition.	SENSe:CORRection:COLLect:GUIDed:PACQuire

Retrieve and Put Calibration Data	
Retrieve Cal Data from the PNA	SENSe:CORRection:CSET:DATA
Put Cal Data in the PNA	SENSe:CORRection:CSET:DATA

Automatic Fixture Removal (AFR)	
Selects whether the fixture is band limited or not.	AFR:FIXTure:BLIMited[:STATe]
Selects whether to use DUT correction or not when the characterization fixture is not equal to the DUT measurement fixture.	AFR:FIXTure:CDUT[:STATe]

Selects Fixture Length A not equal to B correction.	AFR:FIXTure:CLENgth[:STATe]
Selects Fixture Match A not equal to B correction.	AFR:FIXTure:CMATch[:STATe]
Describes the fixture inputs (single ended or differential).	AFR:FIXTure:INPutS
Selects the number of fixtures to be characterized.	AFR:FIXTure:MEASurement
Refreshes preview data.	AFR:FIXTure:PREView
Reads the impedance profile of the calculated fixture model.	AFR:FIXTure:PREView:DATA[:IMPedance]?
Reads the impedance profile of the calculated fixture model at a specified position.	AFR:FIXTure:PREView:DATA[:IMPedance]:MARKer:Y?
Chooses the calibration reference Z0 after fixture removal.	AFR:FIXTure:REFZ
Restores the default AFR settings.	AFR:INITialize
Specifies the file paths of saved fixture data.	AFR:SAVE:FILEname
Assigns the ports for saved fixture data in several formats.	AFR:SAVE:PORTs
Sets the file type to save fixture data.	AFR:SAVE:TYPE
Selects all OPEN standards.	AFR:STANdard:ALLOpen[:STATe]
Selects all SHORT standards.	AFR:STANdard:ALLShort[:STATe]
Reads the impedance profile of the measured standard.	AFR:STANdard:DATA[:IMPedance]?

Reads the impedance of the measured standard at a specified position.	AFR:STANdard:DATA[:IMPedance]:MARKer:Y?
Sets the fixture length for the selected fixture (for 1X AFR only).	AFR:STANdard:EDIT:FLENgth
Sets the gate position for the selected fixture.	AFR:STANdard:EDIT:GATE
Sets the impedance for the selected term.	AFR:STANdard:EDIT:IMPedance
Sets the impedance method.	AFR:STANdard:EDIT:IMPedance:METhod
Loads the calibration standards data from a file.	AFR:STANdard:LOAD
Specifies fixture thru settings.	AFR:STANdard:THRU
Chooses the calibration standards.	AFR:STANdard:USE

CF_Avg BW Commands

Main Tab Commands		
Softkey	Sub-item	SCPI
Averaging	On/Off	SENSe:AVERage[:STATe] SENSe:AVERage:COUNT
Averaging Restart		SENSe:AVERage:CLEAr
IF Bandwidth		SENSe:BANDwidth BWIDth[:RESolution]
Smoothing Tab Commands		
Softkey	Sub-item	SCPI
Smoothing	ON/OFF	CALCulate:MEASure:SMOothing[:STATe]
Smooth Percent		CALCulate:MEASure:SMOothing:APERture
Smooth Points		CALCulate:MEASure:SMOothing:POINts
Delay Aperture Tab Commands		

Softkey	Sub-item	SCPI
Aperture Percent		CALCulate:MEASure:GDElay:PERCent
Aperture Points		CALCulate:MEASure:GDElay:POINts
Aperture Freq		CALCulate:MEASure:GDElay:FREQuency

CF_Cal Commands

The Cal softkeys vary depending on which measurement class is currently active. Click on a measurement class link below to view the corresponding softkeys.

[Standard](#)

[Gain Compression](#)

[Scalar Mixer/Converter](#)

CF_Cal Commands - GCA_GCX

Click [here](#) to view links to Cal commands for all Measurement Classes.

Main	Port Extension	Cal Sets & Cal Kits	Fixtures
------	----------------	---------------------	----------

Main Tab Commands		
Softkey	Sub-item	SCPI
Smart Cal...		
Other Cals	Cal All...	
	Source Power Cal...	
Correction		
Src Power Correct	ON/OFF	SOURce:POWer:CORRection[:STATe]
Interpolation	ON/OFF	SENSe:CORRection:INTerpolate[:STATe]
Correction Methods...		CALCulate:MEASure:CORRection:TYPE
Properties...		None

Port Extension Tab Commands

Softkey	Sub-item	SCPI
Select	Port N	<code>SENSe:CORRection:EXTension:PORT</code>
Port Extension	ON/OFF	<code>SENSe:CORRection:EXTension</code>
Time		<code>SENSe:CORRection:EXTension:PORT:TIME</code>
Distance		<code>SENSe:CORRection:EXTension:PORT:DISTance</code>
Velocity Factor		<code>SENSe:CORRection:RVELocity:COAX</code>
DC Loss		<code>SENSe:CORRection:EXTension:PORT:LDC</code>
Port Extensions..		
Auto Port Extension...		

Cal Sets & Cal Kits Tab Commands

Softkey	Sub-item	SCPI
---------	----------	------

Cal Set...		
Cal Set Viewer	ON/OFF	DISPlay:TOOL:CSET[:STATe]
Cal Kit...		
ECal		
Cal Pod...		
Fixtures Tab Commands		
Softkey	Sub-item	SCPI
Apply Fixtures	ON/OFF	CALCulate:FSIMulator:STATe
Power Comp...	Port N	CALC:FSIM:SEND:POW:PORT:COMP
Fixture Setup	Change order of operations	CALCulate:FSIMulator:SENDED:OORDer

2 and 4-port Extrapolate	CALCulate:FSIMulator:SNP:EXTRapolate
2-Port Fixturing	
Port matching ON and OFF	CALCulate:FSIMulator:SENDEd:PMCircuit:STATE
Reverse ports	CALCulate:FSIMulator:SENDEd:DEEM:PORT<n>:SNP:REVerse
Sets Port Matching circuit model	CALCulate:FSIMulator:SENDEd:PMCircuit:PORT:TYPE
Sets Port Matching 'S2P' file name	CALCulate:FSIMulator:SENDEd:PMCircuit:PORT:USER:FILEname
Sets Capacitance 'C' value	CALCulate:FSIMulator:SENDEd:PMCircuit:PORT:PARAmeters:C
Sets Conductance 'G' value	CALCulate:FSIMulator:SENDEd:PMCircuit:PORT:PARAmeters:G
Sets Inductance 'L' value	CALCulate:FSIMulator:SENDEd:PMCircuit:PORT:PARAmeters:L

Sets Resistance 'R' value	CALCulate:FSIMulator:SENDEd:PMCircuit:PORT:PARAmeters:R
De-embed ON and OFF	CALCulate:FSIMulator:SENDEd:DEEMbed:STATe
Sets De-embedding circuit model	CALCulate:FSIMulator:SENDEd:DEEMbed:PORT
Sets De-embedding 'S2P' file name	CALCulate:FSIMulator:SENDEd:DEEM:PORT:USER:FILEname
Port Impedance ON and OFF	CALCulate:FSIMulator:SENDEd:ZCONversion:STATe
Port Z Real	CALCulate:FSIMulator:SENDEd:ZCONversion:PORT:REAL
Port Z Imag	CALCulate:FSIMulator:SENDEd:ZCONversion:PORT:IMAG
Port Z Real and Imag	CALCulate:FSIMulator:SENDEd:ZCONversion:PORT:Z0
Remote ONLY	
Create Cal Set with De-embedded	CSET:FIXTure:DEEMbed

	fixture removed	
	Create Cal Set with Matching network included	CSET:FIXTure:EMBed
Cal Plane Manager...		

CF_Cal Commands - SMC_VMC

lick [here](#) to view links to Cal commands for all Measurement Classes.

Main	Cal Sets & Cal Kits	Fixtures
------	---------------------	----------

Main Tab Commands		
Softkey	Sub-item	SCPI
Smart Cal...		
Other Cals	Cal All...	
	Source Power Cal...	
Correction		
Interpolation	ON/OFF	SENSe:CORRection:INTerpolate[:STATe]
Correction Methods...		CALCulate:MEASure:CORRection:TYPE
Properties...		None
Cal Sets & Cal Kits Tab Commands		
Softkey	Sub-item	SCPI

Cal Set...		
Cal Set Viewer	ON/OFF	DISPlay:TOOL:CSET[:STATe]
Cal Kit...		
ECal		
Cal Pod...		
Fixtures Tab Commands		
Softkey	Sub-item	SCPI
Apply Fixtures	ON/OFF	CALCulate:FSIMulator:STATe
Power Comp...	Port N	CALC:FSIM:SEND:POW:PORT:COMP
Fixture Setup		
Cal Plane Manager...		

CF_Cal Commands - Standard

Click [here](#) to view links to Cal commands for all Measurement Classes.

Main	Port Extension	Cal Sets & Cal Kits	Fixtures
-------------	----------------	---------------------	----------

Main Tab Commands		
Softkey	Sub-item	SCPI
Basic Cal...	Connector	SENSe:CORRection:COLLect:CKIT:CONNector:ADD
	Cal Kit	SENSe:CORRection:COLLect:CKIT[:SElect]
	Show all cal kits	SENSe:CORRection:COLLect:CKIT:CATalog?
	Cal Type	SENSe:CORRection:COLLect:METHod
Other Cals	Cal All...	
	Select the channels to be calibrated	SYSTem:CALibrate:ALL:SElect
	Set the IFBW	SYSTem:CALibrate:ALL:IFBW
	Set the power level	SYSTem:CALibrate:ALL:PORT:SOURce:POWer

Set the power offset	<code>SYSTem:CALibrate:ALL:PORT:SOURce:POWer:OFFSet</code>
Set the receiver atten	<code>SYSTem:CALibrate:ALL:PORT:SOURce:POWer:ATTen</code>
Set the User Calset Prefix	<code>SYSTem:CALibrate:ALL:CSET:PREFix</code>
Set Path Configuration	<code>SYSTem:CALibrate:ALL:PATH:CONFigure:ELEment</code>
Read unique Cal properties	<code>SYSTem:CALibrate:ALL:MCLass:PROPerty:NAME:CATalog?</code>
Read unique property values	<code>SYSTem:CALibrate:ALL:MCLass:PROPerty:VALue:CATalog?</code>
Set property name/value	<code>SYSTem:CALibrate:ALL:MCLass:PROPerty:VALue</code>
Read primary Cal channel	<code>SYSTem:CALibrate:ALL:GUIDed:CHANnel[:VALue]?</code>
Returns all cal all guided calibration channels	<code>SYSTem:CALibrate:ALL:GUIDed:CHANnel:LIST?</code>

Get Guided Cal handle	None
For each channel, sets the ports to be calibrated	<code>SYSTem:CALibrate:ALL:CHANnel:PORTs</code>
Returns a final list of ports to be calibrated	<code>SYSTem:CALibrate:ALL:GUIDed:PORTs?</code>
Read generated Cal Sets	<code>SYSTem:CALibrate:ALL:CSET:CATalog?</code>
Independent Power Calibration	
Return available ports	<code>SYSTem:CALibrate:ALL:INDependent:SOURce:CALibrate:CATalog?</code>
Add a power cal range	<code>SYSTem:CALibrate:ALL:INDependent:SOURce:CALibrate:RANGe:ADD</code>
Reset all ranges	<code>SYSTem:CALibrate:ALL:INDependent:SOURce:CALibrate:RANGe:CLEar</code>

Query how many ranges are included	<code>SYSTem:CALibrate:ALL:INdependent:SOURce:CALibrate:RANGe:COUNT?</code>
Set number of points	<code>SYSTem:CALibrate:ALL:INdependent:SOURce:CALibrate:RANGe:POINTs</code>
Set start frequency	<code>SYSTem:CALibrate:ALL:INdependent:SOURce:CALibrate:RANGe:STARt</code>
Set stop frequency	<code>SYSTem:CALibrate:ALL:INdependent:SOURce:CALibrate:RANGe:STOP</code>
Smart Cal...	
Initiate a Guided Cal	<code>SENSe:CORRection:COLLect:GUIDed:INITiate</code>
List valid Connector Types for a Port	<code>SENSe:CORRection:COLLect:GUIDed:CONNector:CATalog?</code>
List valid Cal Kits for a Connector type	<code>SENSe:CORRection:COLLect:GUIDed:CKIT:CATalog?</code>

Select a Connector Type	<code>SENSe:CORRection:COLLect:GUIDed:CONNector:PORT</code>
Select a Cal Kit	<code>SENSe:CORRection:COLLect:GUIDed:CKIT:PORT</code>
Set cal method for each port pair	<code>SENSe:CORRection:COLLect:GUIDed:PATH:CMETHOD</code>
Set Thru Method for each port pair	<code>SENSe:CORRection:COLLect:GUIDed:PATH:TMETHOD</code>
Set Thru Port Pairs	<code>SENSe:CORRection:COLLect:GUIDed:THRU:PORTs</code>
Return Number of Steps in a Cal	<code>SENSe:CORRection:COLLect:GUIDed:STEPS?</code>
Return a Description of a Cal Step	<code>SENSe:CORRection:COLLect:GUIDed:DESCRiption?</code>
Measure a Cal Standard in a Guided Cal	<code>SENSe:CORRection:COLLect:GUIDed:ACQuire</code>

Save Cal	SENSe:CORRection:COLLect:GUIDed:SAVE
E Cal...	
Specify Module and Characterization	SENSe:CORRection:COLLect:ACQuire
Do ECAL 1-Port	SENSe:CORRection:COLLect:CKIT 99
Do ECAL 2-Port	SENSe:CORRection:COLLect:CKIT 99
Get ECAL Module Info	SENSe:CORRection:COLLect:CKIT:INFormation? SENSe:CORRection:CKIT:ECAL:INFormation?
Get list of ECal Modules attached to PNA	SENSe:CORRection:CKIT:ECAL:LIST?
Get list of characterizations in ECal module	SENSe:CORRection:CKIT:ECAL:CLISt?
Perform Module	SENSe:CORRection:PREFeRence:ECAL:ORientation

Orientation during calibration	
Maps ECAL Module to PNA Ports	SENSe:CORRection:PREFErence:ECAL:PMAP
Reads ECal orientation	SENSe:CORRection:CKIT:ECAL:ORient?
Perform ECal Isolation	SENSe:CORRection:COLLect:ISOLation:ECAL
Increment Avg for ECal Isolation	SENSe:CORRection:COLLect:ISOLation:AVERage:INCRement
Response Cal...	
Launch Cal Wizard	SYSTem:CORRection:WIZard
Set Cal Type	SENSe:CORRection:COLLect:METHod
Select a Cal Kit	SENSe:CORRection:COLLect:CKIT

Get a Handle to the Active Cal Kit	None
Simultaneous 2-Port Calibration	SENSe:CORRection:TSTandards
Acquisition Direction	SENSe:CORRection:SFORward
Measure a Standard	SENSe:CORRection:COLLect
Calculate Errors	SENSe:CORRection:COLLect:SAVE
Do Isolation	SENSe:CORRection:COLLect
Perform and apply Response (Normalization) cal	SENSe:CORRection:COLLect:METHod
Source Power Cal...	
Copy Source Power cal to	SYSTem:MACRo:COPIY:CHANnel:SOURce

another channel	
GPIB Power Meter Address	SYSTem:COMMunicate:PSEnSor
Set source power cal method	SOURce:POWer:CORRection:COLLect:ACQuire
Turn correction ON OFF	SOURce:POWer:CORRection
Applies correction values after completing a source power cal acquisition sweep Optionally do reference receiver cal	SOURce:POWer:CORRection:COLLect:SAVE
Returns the currently-selected	None

power sensor channel (A or B) for use at a specific frequency	
Set power level	<code>SOURce:POWer:CORRection:LEVel</code>
Set power offset	<code>SOURce:POWer:CORRection:OFFSet</code>
Set settling tolerance	<code>SOURce:POWer:CORRection:COLLect:AVERAge:NTOLerance</code>
Set max readings for settling	<code>SOURce:POWer:CORRection:COLLect:AVERAge:COUNT</code>
Set accuracy tolerance	<code>SOURce:POWer:CORRection:COLLect:ITERation:NTOLerance</code>
Set max readings for accuracy	<code>SOURce:POWer:CORRection:COLLect:ITERation:COUNT</code>

Turn ON OFF display of readings	SOURce:POWer:CORRection:COLLect:DISPlay
Acquire receiver-only readings	SOURce:POWer:CORRection:COLLect:ACQuire
Initiates a source power cal acquisition	SOURce:POWer:CORRection:COLLect:ACQuire
Aborts a source power cal acquisition sweep that is currently in progress	SOURce:POWer:CORRection:COLLect:ABORt
Launches the Power Meter Settings dialog on the PNA	None

	Frequency checking (ON OFF)	SOURce:POWer:CORRection:COLLect:FCHeck
	Check test port power	None
	Calibrate the source at multiple power levels	None
Correction	Channel Correction On	SENSe:CORRection:STATe
	Channel Correction Off	SENSe:CORRection:STATe
	Cal Set...	
	Create a Cal Set	SENSe:CORRection:CSET:CREate
	Delete a Cal Set	CSET:DEL
	List Cal Sets	CSET:CATalog?

List Cal Sets in PNA	None
Get Cal Set Information	None
List Cal Set Error Terms	SENSe:CORRection:CSET:ETERm:CATalog?
Return if a Cal Set exists	CSET:EXISts?
Select a Cal Set by GUID	SENSe:CORRection:CSET:ACTivate
Apply a Cal Set to a channel	SENSe:CORRection:CSET:ACTivate
Copy a Cal Set	SENSe:CORRection:CSET:COpy
Save a Cal Set	SENSe:CORRection:CSET:SAVE
Save Cal Sets	None
Automatically save to User Cal Set	SENSe:CORRection:PREFEreNce:CSET:SAVE

Change the Description of a Cal Set	SENSe:CORRection:CSET:DESCription
Change the Name of a Cal Set	SENSe:CORRection:CSET:NAME
Recall a Cal File	MMEMory:LOAD
Save 'in-memory' Cal Set to disk.	SENSe:CORRection:CSET:FLATten
Create Cal Set with De-embedded fixture removed	CSET:FIXTure:DEEMbed
Create Cal Set with Matching Network included	CSET:FIXTure:EMBed
Adds stimulus data to a specific buffer	None

	Returns the stimulus values over which the specific error term was acquired	None
	Returns FOM stimulus values from a Calset	SENSe:CORRection:CSET:STIMulus?
	Returns the Cal Types from the calset	None
	Returns the properties of the calset	None
	Returns the numbers of the channels using the calset	None
	Unselect Cal Set	SENSe:CORRection:CSET:DEACTivate
Interpolation	ON/OFF	SENSe:CORRection:INTerpolate[:STATe]

Correction Methods...		SENSe:CORRection:MEtHods:MATCh
Correction Properties. ..		None
Port Extension Tab Commands		
Softkey	Sub-item	SCPI
Select	Port N	SENSe:CORRection:EXtension:PORT
Port Extension	ON/OFF	SENSe:CORRection:EXtension
Time		SENSe:CORRection:EXtension:PORT:TIME
Distance		SENSe:CORRection:EXtension:PORT:DIStance
Velocity Factor		SENSe:CORRection:RVELOCITY:COAX
DC Loss		SENSe:CORRection:EXtension:PORT:LDC
	Extensions ON OFF	SENSe:CORRection:EXtension

Port Extensions ...	Port 1 Extensions Value	SENSe:CORRection:EXTension:PORT
	Port 2 Extensions Value	SENSe:CORRection:EXTension:PORT
	Set Freq 1 2	SENSe:CORRection:EXTension:PORT:FREQuency
	Set Loss 1 2	SENSe:CORRection:EXTension:PORT:LOSS
	Use 1 2	SENSe:CORRection:EXTension:PORT:INCLude
	Set Loss at DC	SENSe:CORRection:EXTension:PORT:LDC
	Relative Velocity	SENSe:CORRection:RVELocity:COAX
	Port Ext in distance	SENSe:CORRection:EXTension:PORT:DISTance
	Set distance units	SENSe:CORRection:EXTension:PORT:UNIT
	Set Media per port	SENSe:CORRection:EXTension:PORT:MEDIum

	Set waveguide cutoff freq per port	<code>SENSe:CORRection:EXTension:PORT:WGCutoff</code>
	Set Velocity Factor per port	<code>SENSe:CORRection:EXTension:PORT:VELFactor</code>
	Couple to system Velocity Factor	<code>SENSe:CORRection:EXTension:PORT:SYSVelocity</code>
	Couple to system Media type	<code>SENSe:CORRection:EXTension:PORT:SYSMedia</code>
Auto Port Extension..	Measure OPEN or SHORT for Auto Port Ext	<code>SENSe:CORRection:EXTension:AUTO:MEASure</code>
	Sets the frequencies used for Auto Port Ext. calculation	<code>SENSe:CORRection:EXTension:AUTO:CONFig</code>
	Include loss correction in Auto Port Ext	<code>SENSe:CORRection:EXTension:AUTO:LOSS</code>

Include DC Offset in Auto Port Ext	<code>SENSe:CORRection:EXTension:AUTO:DCOffset</code>
Enable specified port for Auto Port Ext	<code>SENSe:CORRection:EXTension:AUTO:PORT<n></code>
Clears old port extension delay and loss data	<code>SENSe:CORRection:EXTension:AUTO:RESet</code>
Set user span start frequency for Auto Port Ext	<code>SENSe:CORRection:EXTension:AUTO:START</code>
Set user span stop frequency for Auto Port Ext	<code>SENSe:CORRection:EXTension:AUTO:STOP</code>

Cal Sets & Cal Kits Tab Commands

Softkey	Sub-item	SCPI
Cal Set...		

Cal Set Viewer	ON/OFF	DISPlay:TOOL:CSET[:STATe]
Cal Kit...	Set a Cal Kit Active	SENSe:CORRection:COLLect:CKIT
	Clear all Cal Kits from PNA	SENSe:CORRection:CKIT:CLEAr
	Get a Handle to the Active Cal Kit	None
	Save All Cal Kits after Modifying	None
	Load collection of Kits	SENSe:CORRection:CKIT:LOAD
	Load (Recall) All Cal Kits	None
	Import a specified kit	SENSe:CORRection:CKIT:IMPorT
	Restore Cal Kit Default	SENSe:CORRection:CKIT:INITialize

	Restore ALL Cal Kits Default	SENSe:CORRection:CKIT:INITialize
	Build a Hybrid Cal Kit	None
	Set the Name of a Cal Kit	SENSe:CORRection:COLLect:CKIT:NAME
	Set a description of a Cal Kit	SENSe:CORRection:COLLect:CKIT:DESCRiption
	Get the amount of installed kits	SENSe:CORRection:CKIT:COUNt?
	Set the Port Label of a Cal Kit	None
	Saves a Cal Kit to a file	SENSe:CORRection:CKIT:EXPort
ECal...		
Cal Pod...	Command used to send other	CONTRol:CALPod:COMMand

<p>commands as arguments</p>	
<p>Start the CalPod software</p>	<p>Calpod:LAUNCh</p>
<p>Assign Calpod serial number to a port.</p>	<p>Calpod:ENABle</p>
<p>Unassign Calpod serial number from a port.</p>	<p>Calpod:DisabLe</p>
<p>Initialize the selected channel</p>	<p>Calpod:INITIalize:ACTive</p>
<p>Initialize ALL channels</p>	<p>Calpod:INITIalize:ALL</p>

	Recorrect the selected channel	Calpod:Recorrect:ACTive
	Recorrect ALL channels	Calpod:Recorrect:ALL
	Show refresh dialog	Calpod:SHOW
	Hide refresh dialog	Calpod:HIDE
	Sets impedance state	Calpod:STATE
	Read Calpod temperature	Calpod:TEMP?

Fixtures Tab Commands

Softkey	Sub-item	SCPI
Apply Fixtures	ON/OFF	CALCulate:FSIMulator:STATE

Power Comp...	Port N	CALC:FSIM:SEND:POW:PORT:COMP
Fixture Setup	Change order of operations	CALCulate:FSIMulator:SENDEd:OORDer
	2 and 4-port Extrapolate	CALCulate:FSIMulator:SNP:EXTRapolate
	2-Port Fixturing	
	Port matching ON and OFF	CALCulate:FSIMulator:SENDEd:PMCircuit:STATe
	Reverse ports	CALCulate:FSIMulator:SENDEd:DEEM:PORT<n>:SNP:REVerse
	Sets Port Matching circuit model	CALCulate:FSIMulator:SENDEd:PMCircuit:PORT:TYPE
	Sets Port Matching 'S2P' file name	CALCulate:FSIMulator:SENDEd:PMCircuit:PORT:USER:FILE name
	Sets Capacitance 'C' value	CALCulate:FSIMulator:SENDEd:PMCircuit:PORT:PARAmeters:C

Sets Conductance 'G' value	CALCulate:FSIMulator:SENDEd:PMCircuit:PORT:PARAmeters:G
Sets Inductance 'L' value	CALCulate:FSIMulator:SENDEd:PMCircuit:PORT:PARAmeters:L
Sets Resistance 'R' value	CALCulate:FSIMulator:SENDEd:PMCircuit:PORT:PARAmeters:R
De-embed ON and OFF	CALCulate:FSIMulator:SENDEd:DEEMbed:STATe
Sets De-embedding circuit model	CALCulate:FSIMulator:SENDEd:DEEMbed:PORT
Sets De-embedding 'S2P' file name	CALCulate:FSIMulator:SENDEd:DEEM:PORT:USER:FILEname
Port Impedance ON and OFF	CALCulate:FSIMulator:SENDEd:ZCONversion:STATe
Port Z Real	CALCulate:FSIMulator:SENDEd:ZCONversion:PORT:REAL
Port Z Imag	CALCulate:FSIMulator:SENDEd:ZCONversion:PORT:IMAG
Port Z Real and Imag	CALCulate:FSIMulator:SENDEd:ZCONversion:PORT:Z0

4-Port Network Embed/De-embed commands	
Specifies the PNA / DUT topology	CALCulate:FSIMulator:EMBed:TYPE
Specifies the 4-port touchstone file	CALCulate:FSIMulator:EMBed:NETWork:FILEname
Embed De-embed?	CALCulate:FSIMulator:EMBed:NETWork:TYPE
Specify PNA port connections	CALCulate:FSIMulator:EMBed:TOPology:A:PORTs CALCulate:FSIMulator:EMBed:TOPology:B:PORTs CALCulate:FSIMulator:EMBed:TOPology:C:PORTs CALCulate:FSIMulator:EMBed:TOPology:D:PORTs
4-port remap	CALCulate:FSIMulator:EMBed:NETWork<n>:PMAP
Turn ON or OFF	CALCulate:FSIMulator:EMBed:STATe
Differential Port Arbitrary Impedance	

Sets the impedance value	CALCulate:FSIMulator:BAunL:DZConversion:BPORt:Z0
Sets real part of impedance	CALCulate:FSIMulator:BALun:DZConversion:BPORt:REAL
Sets imaginary part of impedance	CALCulate:FSIMulator:BALun:DZConversion:BPORt:IMAG
Turn ON or OFF	CALCulate:FSIMulator:BALun:DZConversion:STATe
Common Mode Port Arbitrary Impedance	
Sets the impedance value	CALCulate:FSIMulator:BALun:CZConversion:BPORt:Z0
Sets real part of impedance	CALCulate:FSIMulator:BALun:CZConversion:BPORt:REAL
Sets imaginary	CALCulate:FSIMulator:BALun:CZConversion:BPORt:IMAG

part of impedance	
Turn ON or OFF	CALCulate:FSIMulator:BALun:CZConversion:STATe
Differential Port Matching	
Sets type of circuit to embed	CALCulate:FSIMulator:BALun:DMCircuit:BPORt
Specifies the 2-port touchstone file	CALCulate:FSIMulator:BALun:DMCircuit:BPORt:USER:FILE name
Sets Capacitance value	CALCulate:FSIMulator:BALun:DMCircuit:BPORt:PARAmeters:C
Sets Conductance value	CALCulate:FSIMulator:BALun:DMCircuit:BPORt:PARAmeters:G

	Sets Inductance value	CALCulate:FSIMulator:BALun:DMCircuit:BPORt:PARAmeters:L
	Sets Resistance value	CALCulate:FSIMulator:BALun:DMCircuit:BPORt:PARAmeters:R
	Turns ON/OFF	CALCulate:FSIMulator:BALun:DMCircuit:STATe
Remote ONLY		
	Create Cal Set with De-embedded fixture removed	CSET:FIXTure:DEEMbed
	Create Cal Set with Matching network included	CSET:FIXTure:EMBed
Cal Plane Manager...	Characterize a fixture	CSET:FIXTure:CHARacterize

	Creates a single S2P file from two existing files	CSET:FIXTure:CASCade
Auto Fixture Removal...		CSET:FIXTure:DEEMbed

CF_Channel Commands

Channel 1 - 8 Tab Commands		
Softkey	Sub-item	SCPI
Channel 1	On/Off	None
Channel 2	On/Off	None
Channel 3	On/Off	None
Channel 4	On/Off	None
Channel 5	On/Off	None
Channel 6	On/Off	None
Channel 7	On/Off	None
Channel 8	On/Off	None
Channel Setup Tab Commands		
Softkey	Sub-item	SCPI
Select	ChN	SENSe:CLASs:NAME?

Meas Class...		CALCulate:MEASure:DEFine
Add Channel	New Trace + Channel	None
	New Trace + Channel + Window	None
Copy Channel	Copy to Active Window	None
	Copy to New Window	None
	Copy Channel...	SYSTem:MACRo:COpy:CHANnel[:TO]
Delete Channel	ChN	SYSTem:CHANnels:DELeTe

CF_Display Commands

Window 1-8 Tab Commands		
Softkey	Sub-item	SCPI
Window 1	On/Off	DISPlay:WINDow[:STATe]
Window 2	On/Off	DISPlay:WINDow[:STATe]
Window 3	On/Off	DISPlay:WINDow[:STATe]
Window 4	On/Off	DISPlay:WINDow[:STATe]
Window 5	On/Off	DISPlay:WINDow[:STATe]
Window 6	On/Off	DISPlay:WINDow[:STATe]
Window 7	On/Off	DISPlay:WINDow[:STATe]
Window 8	On/Off	DISPlay:WINDow[:STATe]
Window Setup Tab Commands		
Softkey	Sub-item	SCPI
Select	WinN	DISPlay:WINDow:TRACe:SElect

Window Title...	Enable	DISPlay:WINDow:TITLe[:STATe]
	Title	DISPlay:WINDow:TITLe[:DATA]
Add Window	New Window	DISPlay:WINDow[:STATe]
	New Trace + Window	DISPlay:WINDow:TRACe[:STATe]
	New Trace + Channel + Window	None
Delete Window	WinN	DISPlay:WINDow[:STATe]
Move Window...		DISPlay:WINDow:TRACe:MOVE
Window Layout	1 Window	DISPlay:ARRange
	2 Windows	DISPlay:ARRange
	3 Windows	DISPlay:ARRange
	4 Windows	DISPlay:ARRange
	1 Trace per Window	DISPlay:ARRange

	1 Channel per Window	DISPlay:ARRange
	Tile Windows	DISPlay:ARRange
Sheet Setup Tab Commands		
Softkey	Sub-item	SCPI
Select	Sheet N	DISPlay:SHEet:STATe
Sheet Title...		DISPlay:SHEet:TITLe:DATA
Add Sheet	New Sheet	DISPlay:SHEet:STATe
	New Trace + Sheet	DISPlay:WINDow:FEED
	New Trace + Channel + Sheet	None
Delete Sheet	Sheet N	DISPlay:SHEet:STATe
Sheet Layout	1 Sheet	DISPlay:SHEet:ARRange
	1 Trace per Sheet	DISPlay:SHEet:ARRange

	1 Channel per Sheet	DISPlay:SHEet:ARRange
	1 Window per Sheet	DISPlay:SHEet:ARRange

Display Setup Tab Commands

Softkey	Sub-item	SCPI
Trace Maximize	ON/OFF	DISPlay:TMAX
Window Max	ON/OFF	DISPlay:WINDow:SIZE
Show Table	None	DISPlay:WINDow:TABLE
	Marker	DISPlay:WINDow:TABLE
	Limit	DISPlay:WINDow:TABLE
	Ripple	DISPlay:WINDow:TABLE
	Segment	DISPlay:WINDow:TABLE

	Distortion	DISPlay:WINDow:TABLE
Customize Display...	Labels	
	Trace Status	DISPlay:WINDow:ANNotation[:TRACe][:STATe]
	Y-axis Labels	DISPlay:WINDow:ANNotation:Y[:STATe]
	X-axis Labels	None
	Markers	
	Show Marker Readout	DISPlay:WINDow:ANNotation:MARKer[:STATe]
	Large Readout	DISPlay:WINDow:ANNotation:MARKer:SIZE
	Active Trace Only	None
	Readouts Per Trace	DISPlay:WINDow:ANNotation:MARKer:NUMBER
	Symbol - Triangle, Flag, and Line	DISPlay:WINDow:ANNotation:MARKer:SYMBOL
	Symbols Above Trace	None

Decimal Places - Stimulus and Response	DISPlay:WINDow:ANNotation:MARKer:RESolution:STIMulus DISPlay:WINDow:ANNotation:MARKer:RESolution:RESPonse
Readout Position - X and Y	DISPlay:WINDow:ANNotation:MARKer:XPOSition DISPlay:WINDow:ANNotation:MARKer:YPOSition
Independent Position Per Trace	None
Active TrN	None
Marker Colors...	DISPlay:COLor:TRACe:MARKer
N Trace: Markers	DISPlay:COLor:TRACe:MARKer
N Trace: Memory Markers	DISPlay:COLor:TRACe:MMARKer
Change Color...	None
Reset Color	DISPlay:COLor:RESet
Save Theme...	DISPlay:COLor:STORe
Recall Theme...	DISPlay:COLor:LOAD

Reset Theme...	DISPlay:COLor:RESet
Grid	
Grid Lines - Solid Dotted	DISPlay:WINDow:TRACe:GRATicule:GRID:LTYPe
Y-axis Divisions - 2 to 30	DISPlay:WINDow:TRACe:Y[:SCALe]:PDIVision
Show Table - None, Marker, Limit, Ripple, and Segment	DISPlay:WINDow:TABLE
Toolbars	
Softkey	DISPlay:TOOLbar:ENTRy[:STATe]
Hardkey	DISPlay:TOOLbar:KEYS[:STATe]
Port Extensions	DISPlay:TOOLbar:EXTensions[:STATe]
Transform	DISPlay:TOOLbar:TRANsform[:STATe]
Marker	DISPlay:TOOLbar:MARKer[:STATe]
Cal Set Viewer	DISPlay:TOOLbar:CSET[:STATe]

Main Title Bar	None
Menu Bar	None
Active Entry Toolbar	DISPlay:TOOLbar:ENTry[:STATe]
Status Bar	DISPlay:ANNotation[:STATus]
- 2 Bars	None
- Clock	SYSTem:CLOCK[:STATe]
Display Sheet Tabs	
Top	None
Bottom	None
Tools	
Tool	None
Active Entry	None
Softkey	None

Colors	
Default	DISPlay:COLor:RESet
Light Gray	None
Dark Gray	None
Blue	None
Display Colors... Print Colors...	
Background	DISPlay:COLor:BACKground
Active Background	DISPlay:COLor:ABACKground
Grid	DISPlay:COLor:GRAT2
Active Labels, Grid Frame	DISPlay:COLor:GRAT1
Inactive Window Labels	DISPlay:COLor:ILABel
Failed Trace	DISPlay:COLor:LIM1

	N Trace: Data and Limits	DISPlay:COLor:TRACe:DATA
	N Trace: Memory	DISPlay:COLor:TRACe:MEMory
	N Trace: Markers	DISPlay:COLor:TRACe:MARKer
	N Trace: Memory Markers	DISPlay:COLor:TRACe:MMARKer
	Change Color...	None
	Reset Color	None
	Save Theme...	DISPlay:COLor:STORe
	Recall Theme...	DISPlay:COLor:LOAD
	Reset Theme...	DISPlay:COLor:RESet
Display Update	ON/OFF	DISPlay:UPDate[:STATe] DISPlay:UPDate:IMMEDIATE

CF_Format Commands

Format 1 Tab Commands		
Softkey	Sub-item	SCPI
Log Mag	On/Off	CALCulate:MEASure:FORMat
Lin Mag	On/Off	CALCulate:MEASure:FORMat
Phase	On/Off	CALCulate:MEASure:FORMat
Delay	On/Off	CALCulate:MEASure:FORMat
Smith	On/Off	CALCulate:MEASure:FORMat
Polar	On/Off	CALCulate:MEASure:FORMat
SWR	On/Off	CALCulate:MEASure:FORMat
Group Delay Aperture...	Points	CALCulate:MEASure:GDElay:POINTs
	Percent of Span	CALCulate:MEASure:GDElay:PERCent
	Frequency	CALCulate:MEASure:GDElay:FREQuency
Format 2 Tab Commands		

Softkey	Sub-item	SCPI
Real	On/Off	CALCulate:MEASure:FORMat
Imaginary	On/Off	CALCulate:MEASure:FORMat
Unwrapped Phase	On/Off	CALCulate:MEASure:FORMat
Positive Phase	On/Off	CALCulate:MEASure:FORMat
Inverted Smith	On/Off	CALCulate:MEASure:FORMat

CF_Freq Commands

The Freq softkeys vary depending on which measurement class is currently active. Click on a measurement class link below to view the corresponding softkeys.

[Standard](#)

[Gain Compression](#)

[Noise Figure Cold Source](#)

[Scalar Mixer/Converter](#)

CF_Freq Commands - GCA

Click [here](#) to view links to Freq commands for all Measurement Classes.

Main Tab Commands		
Softkey	Sub-item	SCPI
Start		SENSe:FREQuency:START
Stop		SENSe:FREQuency:STOP
Center		SENSe:FREQuency:CENTer
Span		SENSe:FREQuency:SPAN
Step		SENSe:FREQuency:STEP
Frequency Offset...	Frequency Offset (ON/OFF)	SENSe:FOM[:STATe]
	Mode - Coupled and Un-coupled	SENSe:FOM:RANGe:COUPled
	Sweep Type	SENSe:FOM:RANGe:SWEep:TYPE
	Settings	
	Start	SENSe:FOM:RANGe:FREQuency:START

	Stop	SENSe:FOM:RANGe:FREQuency:STOP
	Annotation - Primary, Source, and Receivers	SENSe:FOM:RANGe:NAME?
	X-Axis Point Spacing	SENSe:FOM:RANGe:SEGMENT:SWEEP:POINTS
GCA Setup...		

CF_Freq Commands - NF

Click [here](#) to view links to Freq commands for all Measurement Classes.

Main Tab Commands		
Softkey	Sub-item	SCPI
Start		SENSe:FREQuency:START
Stop		SENSe:FREQuency:STOP
Center		SENSe:FREQuency:CENTer
Span		SENSe:FREQuency:SPAN
Step		SENSe:FREQuency:STEP
Frequency Offset...	Frequency Offset (ON/OFF)	SENSe:FOM[:STATe]
	Mode - Coupled and Un-coupled	SENSe:FOM:RANGe:COUPled
	Sweep Type	SENSe:FOM:RANGe:SWEep:TYPE
	Settings	
	Start	SENSe:FOM:RANGe:FREQuency:START

	Stop	SENSe:FOM:RANGe:FREQuency:STOP
	Annotation - Primary, Source, and Receivers	SENSe:FOM:RANGe:NAME?
	X-Axis Point Spacing	SENSe:FOM:RANGe:SEGMENT:SWEEP:POINTs
NF Setup...		

CF_Freq Commands - SMC_VMC

lick [here](#) to view links to Freq commands for all Measurement Classes.

Main Tab Commands		
Softkey	Sub-item	SCPI
Start...	<u>Input</u>	
	Calculate Input and Output frequencies	SENSe:MIXer:CALCulate
	Input to swept or fixed	SENSe:MIXer:INPut:FREQuency:MODE
	Input start frequency	SENSe:MIXer:INPut:FREQuency:START
	Input stop frequency	SENSe:MIXer:INPut:FREQuency:STOP
	Input power level	SENSe:MIXer:INPut:POWer
	Input fixed frequency	SENSe:MIXer:INPut:FREQuency:FIXed

LO1	
LO freq fixed or swept	SENSe:MIXer:LO:FREQuency:MODE
LO fixed frequency	SENSe:MIXer:LO:FREQuency:FIXed
LO start frequency	SENSe:MIXer:LO:FREQuency:STARt
LO stop frequency	SENSe:MIXer:LO:FREQuency:STOP
Input Greater / Less that LO	SENSe:MIXer:LO:FREQuency:ILTI
Output	
Sideband (high or low)	SENSe:MIXer:OUTPut:FREQuency:SIDeband
Output start frequency	SENSe:MIXer:OUTPut:FREQuency:STARt

	Output stop frequency	SENSe:MIXer:OUTPut:FREQuency:STOP
	Output to swept or fixed	SENSe:MIXer:OUTPut:FREQuency:MODE
	Output fixed frequency	SENSe:MIXer:OUTPut:FREQuency:FIXed
Stop...	Input	
	LO1	
	Output	
Center...	Input	
	LO1	
	Output	
Span...	Input	
	LO1	
	Output	

CW...	Sweep	
SMC Setup... (Scalar Mixer/Converter + Phase Measurement Class only)		

CF_Freq Commands - Standard

Click [here](#) to view links to Freq commands for all Measurement Classes.

Main Tab Commands		
Softkey	Sub-item	SCPI
Start		SENSe:FREQuency:STARt
Stop		SENSe:FREQuency:STOP
Center		SENSe:FREQuency:CENTer
Span		SENSe:FREQuency:SPAN
Step		SENSe:SWEep:STEP
CW		SENSe:FREQuency:CW
Frequency Offset...	Frequency Offset (ON/OFF)	SENSe:FOM[:STATe]
	Mode - Coupled and Un-coupled	SENSe:FOM:RANGe:COUPled
	Sweep Type	SENSe:FOM:RANGe:SWEep:TYPE
	Settings	

Start	SENSe:FOM:RANGe:FREQuency:START
Stop	SENSe:FOM:RANGe:FREQuency:STOP
Annotation - Primary, Source, and Receivers	SENSe:FOM:RANGe:NAME?
X-Axis Point Spacing	SENSe:FOM:RANGe:SEGMENT:SWEep:POINTs

CF_Hardkeys

CF_Macro Commands

Key Setup Tab Commands		
Softkey	Sub-item	SCPI
Macro Setup...	Execute Macro	SYSTem:SHORtcut:EXECute
	Delete Macro	SYSTem:SHORtcut:DELeTe
	Write macro path, argument, and title	SYSTem:SHORtcut:PATH
	Read macro path, argument, and title	SYSTem:SHORtcut:ARGuments SYSTem:SHORtcut:TITLe
Clear Favorites		None

CF_Markers Commands

Marker 1-7 Tab Commands		
Softkey	Sub-item	SCPI
Marker 1	On/Off	CALCulate:MEASure:MARKer[:STATe]
Marker 2	On/Off	CALCulate:MEASure:MARKer[:STATe]
Marker 3	On/Off	CALCulate:MEASure:MARKer[:STATe]
Marker 5	On/Off	CALCulate:MEASure:MARKer[:STATe]
Marker 6	On/Off	CALCulate:MEASure:MARKer[:STATe]
Marker 7	On/Off	CALCulate:MEASure:MARKer[:STATe]
Marker 8	On/Off	CALCulate:MEASure:MARKer[:STATe]
Reference	On/Off	CALCulate:MEASure:MARKer:REFerence[:STATe]
Marker 8-15 Tab Commands		
Softkey	Sub-item	SCPI

Marker 8	On/Off	CALCulate:MEASure:MARKer[:STATe]
Marker 9	On/Off	CALCulate:MEASure:MARKer[:STATe]
Marker 10	On/Off	CALCulate:MEASure:MARKer[:STATe]
Marker 11	On/Off	CALCulate:MEASure:MARKer[:STATe]
Marker 12	On/Off	CALCulate:MEASure:MARKer[:STATe]
Marker 13	On/Off	CALCulate:MEASure:MARKer[:STATe]
Marker 14	On/Off	CALCulate:MEASure:MARKer[:STATe]
Marker 15	On/Off	CALCulate:MEASure:MARKer[:STATe]
Marker Setup Tab Commands		
Softkey	Sub-item	SCPI
Delta	ON/OFF	CALCulate:MEASure:MARKer:DELTA
Discrete	ON/OFF	CALCulate:MEASure:MARKer:DIScrete
Type	NORMAL	CALCulate:MEASure:MARKer:TYPE

	FIXED	CALCulate:MEASure:MARKer:TYPE	
Format	Trace Default	CALCulate:MEASure:MARKer:FORMat	
	Log / Phase	CALCulate:MEASure:MARKer:FORMat	
	Lin / Phase	CALCulate:MEASure:MARKer:FORMat	
	Re / Im	CALCulate:MEASure:MARKer:FORMat	
	R+jX	CALCulate:MEASure:MARKer:FORMat	
	G+jB	CALCulate:MEASure:MARKer:FORMat	
	Log Magnitude	CALCulate:MEASure:MARKer:FORMat	
	Linear Magnitude	CALCulate:MEASure:MARKer:FORMat	
	Phase	CALCulate:MEASure:MARKer:FORMat	
	SWR	CALCulate:MEASure:MARKer:FORMat	
	Delay	CALCulate:MEASure:MARKer:FORMat	

	Real	CALCulate:MEASure:MARKer:FORMat	
	Imaginary	CALCulate:MEASure:MARKer:FORMat	
	Kelvin	CALCulate:MEASure:MARKer:FORMat	
	Fahrenheit	CALCulate:MEASure:MARKer:FORMat	
	Celsius	CALCulate:MEASure:MARKer:FORMat	
Coupled	Off	CALCulate:MEASure:MARKer:COUPling[:STATe]	
	Channel	CALCulate:MEASure:MARKer:COUPling:METhod	
	All	CALCulate:MEASure:MARKer:COUPling:METhod	
Marker Display...	Marker Readout	DISPlay:WINDow:ANNotation:MARKer[:STATe]	
	Large Readout	DISPlay:WINDow:ANNotation:MARKer:SIZE	
	Readouts Per Trace	DISPlay:WINDow:ANNotation:MARKer:NUMBER	
	Symbol - Triangle, Flag, and Line	DISPlay:WINDow:ANNotation:MARKer:SYMBOL	

	Decimal Places - Stimulus and Response	DISPlay:WINDow:ANNotation:MARKer:RESolution:STIMulus DISPlay:WINDow:ANNotation:MARKer:RESolution:RESPonse
	Readout Position - X and Y	DISPlay:WINDow:ANNotation:MARKer:XPOSition DISPlay:WINDow:ANNotation:MARKer:YPOSition
	Marker Colors...	DISPlay:COLor:TRACe:MARKer
Marker Table	ON/OFF	DISPlay:WINDow:TABLE
All Off		CALCulate:MEASure:MARKer:AOFF
Marker -> Functions Tab Commands		
Softkey	Sub-item	SCPI
Marker -> Start		CALCulate:MEASure:MARKer:SET
Marker -> Stop		CALCulate:MEASure:MARKer:SET
Marker -> Center		CALCulate:MEASure:MARKer:SET

Marker -> Span		CALCulate:MEASure:MARKer:SET	
Marker -> Ref Level		CALCulate:MEASure:MARKer:SET	
Marker -> Delay		CALCulate:MEASure:MARKer:SET	
Marker -> CW Freq		CALCulate:MEASure:MARKer:SET	

CF_Math Commands

Memory Tab Commands		
Softkey	Sub-item	SCPI
Data -> Memory		CALCulate:MEASure:MATH:MEMorize
Normalize		None
Data Math	Off	CALCulate:MEASure:MATH:FUNCTION
	Data / Memory	CALCulate:MEASure:MATH:FUNCTION
	Data * Memory	CALCulate:MEASure:MATH:FUNCTION
	Data - Memory	CALCulate:MEASure:MATH:FUNCTION
	Data + Memory	CALCulate:MEASure:MATH:FUNCTION
Display	Data Trace	DISPlay:WINDow:TRACe[:STATe]
	Memory Trace	DISPlay:WINDow:TRACe:MEMory
	Data and Memory	DISPlay:WINDow:TRACe[:STATe] DISPlay:WINDow:TRACe:MEMory

8510 Mode	ON/OFF	None
Interpolate	ON/OFF	CALCulate:MEASure:MATH:INTerpolate[:STATe]
Analysis Tab Commands		
Softkey	Sub-item	SCPI
Conversions	Off	CALCulate:MEASure:CONVersion:FUNcTion
	Z-Reflect	CALCulate:MEASure:CONVersion:FUNcTion
	Z-Transmit	CALCulate:MEASure:CONVersion:FUNcTion
	Z-Trans-Shunt	CALCulate:MEASure:CONVersion:FUNcTion
	Y-Reflect	CALCulate:MEASure:CONVersion:FUNcTion
	Y-Transmit	CALCulate:MEASure:CONVersion:FUNcTion
	Y-Trans-Shunt	CALCulate:MEASure:CONVersion:FUNcTion
	1 / S	CALCulate:MEASure:CONVersion:FUNcTion
	Conjugation	CALCulate:MEASure:CONVersion:FUNcTion

Equation Editor...	On/Off	CALCulate:MEASure:EQUation[:STATe]
	Equation	CALCulate:MEASure:EQUation:TEXT
	Enable Equation	CALCulate:MEASure:EQUation[:STATe]
	Functions	CALCulate:EQUation:LIBRary:FUNCTions
	Trace Data	None
	Parameter	None
	Store Equation	None
	Delete Equation	None
	Use Short Names	None
	Fast Processing	CALCulate:MEASure:EQUation:FAST
	Enable Matlab	None
	Import...	
	Import Library	CALCulate:EQUation:LIBRary:IMPorT
	Remove Library	CALCulate:EQUation:LIBRary:REMOve

Statistics...	On/Off	CALCulate:MEASure:FUNcTion:STATistics[:STATe]
	Statistics - Mean, Standard Deviation, Peak to Peak	CALCulate:MEASure:FUNcTion:TYPE
	User Range - Full Span, User 1 to 16	CALCulate:MEASure:FUNcTion:DOMain:USER[:RANGe]
	Start	CALCulate:MEASure:FUNcTion:DOMain:USER:START
	Stop	CALCulate:MEASure:FUNcTion:DOMain:USER:STOP
Limits...	Limit	
	Limit Test	
	Limit Test ON	CALCulate:MEASure:LIMit[:STATe]
	Limit Line ON	CALCulate:MEASure:LIMit:DISPlay[:STATe]
	Sound ON Fail	CALCulate:MEASure:LIMit:SOUNd[:STATe]
	Pass/Fail Position	
	X Pass/Fail Position	DISPlay:WINDow:ANNotation:LIMit:XPOsition

Y Pass/Fail Position	DISPlay:WINDow:ANNOtation:LIMit:YPOSition
Limit Table	
Show Table	DISPlay:WINDow:TABLE
Load Table	MMEMory:LOAD:LIMit
Save Table	MMEMory:STORe:LIMit
Global Pass/Fail	
Global Pass/Fail ON	DISPlay:FSIGN
Ripple	
Ripple Test	
Ripple Test ON	CALCulate:MEASure:RLIMit:STATe
Ripple Line ON	CALCulate:MEASure:RLIMit:DISPlay:LINE:STATe
Sound ON Fail	CALCulate:MEASure:LIMit:SOUND[:STATe]
Ripple Result	

Type - Off, Absolute or Margin	CALCulate:MEASure:RLIMit:DISPlay:TYPE
Segment	CALCulate:MEASure:RLIMit:DATA
Ripple Table	
Show Table	DISPlay:WINDow:TABLE
Load Table	MMEMory:LOAD:RLIMit
Save Table	MMEMory:STORe:RLIMit
Bandwidth	
Bandwidth Test	
Bandwidth Test ON	CALCulate:MEASure:BLIMit:STATe
Bandwidth Marker ON	CALCulate:MEASure:BLIMit:DISPlay:MARKer:STATe
Sound ON Fail	CALCulate:MEASure:LIMit:SOUND[:STATe]
N dB Points	CALCulate:MEASure:BLIMit:BWIDth:THReshold

	Min Bandwidth	CALCulate:MEASure:BLIMit:MINimum
	Max Bandwidth	CALCulate:MEASure:BLIMit:MAXimum
Limit Table	Off	DISPlay:WINDow:TABLE
	Limit	DISPlay:WINDow:TABLE
	Ripple	DISPlay:WINDow:TABLE
Compression Analysis... (Gain Compression and Gain Compression Converters Measurement Classes only)	Compression Analysis	CALCulate:MEASure:GCMeas:ANALysis:ENABle
	Analysis Frequency	CALCulate:MEASure:GCMeas:ANALysis:CWFRequency
	Use Discrete Frequencies	CALCulate:MEASure:GCMeas:ANALysis:DISCrete[:STATe]
	Use Measured Pin	CALCulate:MEASure:GCMeas:ANALysis:XAXis
	Use Source Pwr Settings	CALCulate:MEASure:GCMeas:ANALysis:XAXis
Time Domain Tab Commands		
Softkey	Sub-item	SCPI

Transform	ON/OFF	CALCulate:MEASure:TRANSform:TIME:STATe
Start Time		CALCulate:MEASure:TRANSform:TIME:START
Stop Time		CALCulate:MEASure:TRANSform:TIME:STOP
Center Time		CALCulate:MEASure:TRANSform:TIME:CENTer
Span Time		CALCulate:MEASure:TRANSform:TIME:SPAN
TD Mode	Low Pass Impulse	CALCulate:MEASure:TRANSform:TIME[:TYPE]
	Low Pass Step	CALCulate:MEASure:TRANSform:TIME[:TYPE]
	Band Pass	CALCulate:MEASure:TRANSform:TIME[:TYPE]
TD Toolbar	ON/OFF	DISPlay:TOOLbar:TRANSform[:STATe]
Time Domain Setup...	Transform	
	Transform On	CALCulate:MEASure:TRANSform:TIME:STATe
	Start	CALCulate:MEASure:TRANSform:TIME:START
	Stop	CALCulate:MEASure:TRANSform:TIME:STOP
	Center	CALCulate:MEASure:TRANSform:TIME:CENTer

Span	CALCulate:MEASure:TRANSform:TIME:SPAN
Low Pass Impulse	CALCulate:MEASure:TRANSform:TIME[:TYPE]
Low Pass Step	CALCulate:MEASure:TRANSform:TIME[:TYPE]
Band Pass	CALCulate:MEASure:TRANSform:TIME[:TYPE]
Set Low Pass Frequencies	CALCulate:MEASure:TRANSform:TIME:LPFREquency
Gating	
Gating On	CALCulate:MEASure:FILTer[:GATE]:TIME:STATe
Start	CALCulate:MEASure:FILTer[:GATE]:TIME:START
Stop	CALCulate:MEASure:FILTer[:GATE]:TIME:STOP
Center	CALCulate:MEASure:FILTer[:GATE]:TIME:CENTer
Span	CALCulate:MEASure:FILTer[:GATE]:TIME:SPAN
Gate Type	CALCulate:MEASure:FILTer[:GATE]:TIME[:TYPE]
Gate Shape	CALCulate:MEASure:FILTer[:GATE]:TIME:SHAPE

Window	
Minimum/Maximum	None
Kaiser Beta	CALCulate:MEASure:TRANSform:TIME:KBESsel
Impulse Width	CALCulate:MEASure:TRANSform:TIME:IMPulse:WIDTh
Coupling	
Coupling On	SENSe:COUPlE:PARAmeter[:STATe]
Transform Parameters	
Stimulus	CALCulate:MEASure:TRANSform:COUPlE:PARAmeters
State (On/Off)	CALCulate:MEASure:TRANSform:COUPlE:PARAmeters
Window	CALCulate:MEASure:TRANSform:COUPlE:PARAmeters
Mode	CALCulate:MEASure:TRANSform:COUPlE:PARAmeters
Distance Marker Unit	CALCulate:MEASure:TRANSform:COUPlE:PARAmeters
Gating Parameters	

Stimulus	CALCulate:MEASure:FILTer[:GATE]:COUple:PARameters
State (On/Off)	CALCulate:MEASure:FILTer[:GATE]:COUple:PARameters
Shape	CALCulate:MEASure:FILTer[:GATE]:COUple:PARameters
Type	CALCulate:MEASure:FILTer[:GATE]:COUple:PARameters
Marker	
Auto	CALCulate:MEASure:TRANSform:TIME:MARKer:MODE
Reflection (divide by 2)	CALCulate:MEASure:TRANSform:TIME:MARKer:MODE
Transmission	CALCulate:MEASure:TRANSform:TIME:MARKer:MODE
Meters (m)	CALCulate:MEASure:TRANSform:TIME:MARKer:UNIT
Feet (ft)	CALCulate:MEASure:TRANSform:TIME:MARKer:UNIT
Inches (in)	CALCulate:MEASure:TRANSform:TIME:MARKer:UNIT
Velocity Factor	SENSe:CORRection:EXTension:PORT:VELFactor
Time Gating Tab Commands	

Softkey	Sub-item	SCPI
Gating	ON/OFF	CALCulate:MEASure:FILTer[:GATE]:TIME:STATe
Gate Start		CALCulate:MEASure:FILTer[:GATE]:TIME:START
Gate Stop		CALCulate:MEASure:FILTer[:GATE]:TIME:STOP
Gate Center		CALCulate:MEASure:FILTer[:GATE]:TIME:CENTer
Gate Span		CALCulate:MEASure:FILTer[:GATE]:TIME:SPAN
Gate Type	Band Pass	CCALCulate:MEASure:FILTer[:GATE]:TIME[:TYPE]
	Notch	CALCulate:MEASure:FILTer[:GATE]:TIME[:TYPE]
Gate Shape	Maximum	CALCulate:MEASure:FILTer[:GATE]:TIME:SHAPE
	Wide	CALCulate:MEASure:FILTer[:GATE]:TIME:SHAPE
	Normal	CALCulate:MEASure:FILTer[:GATE]:TIME:SHAPE
	Minimum	CALCulate:MEASure:FILTer[:GATE]:TIME:SHAPE
Gating Setup...	Gating	
	Gating On	CALCulate:MEASure:FILTer[:GATE]:TIME:STATe

Start	CALCulate:MEASure:FILTer[:GATE]:TIME:STARt
Stop	CALCulate:MEASure:FILTer[:GATE]:TIME:STOP
Center	CALCulate:MEASure:FILTer[:GATE]:TIME:CENTer
Span	CALCulate:MEASure:FILTer[:GATE]:TIME:SPAN
Gate Type	CALCulate:MEASure:FILTer[:GATE]:TIME[:TYPE]
Gate Shape	CALCulate:MEASure:FILTer[:GATE]:TIME:SHAPE

CF_Meas Commands

The Meas softkeys vary depending on which measurement class is currently active. Click on a measurement class link below to view the corresponding softkeys.

[Standard](#)

[Gain Compression](#)

[Noise Figure Cold Source](#)

[Scalar Mixer/Converter](#)

CF_Meas Commands - GCA

Click [here](#) to view links to Meas commands for all Measurement Classes.

Compression	S-Param	Auxiliary	Meas Setup
--------------------	---------	-----------	------------

Compression Tab Commands

Softkey	Sub-item	SCPI
CompIn21	On/Off	CALCulate:MEASure:PARAmeter
CompOut21	On/Off	CALCulate:MEASure:PARAmeter
DeltaGain21	On/Off	CALCulate:MEASure:PARAmeter
CompGain21	On/Off	CALCulate:MEASure:PARAmeter
CompS11	On/Off	CALCulate:MEASure:PARAmeter
Ref21	On/Off	CALCulate:MEASure:PARAmeter
Other...	S21, S11, S12, S22, A11, A12, CompIn21, CompOut21, DeltaGain21, CompGain21, CompS11, Ref21, CompA11, CompA12	CALCulate:MEASure:PARAmeter

Meas Class...

[CALCulate:MEASure:DEFine](#)

S-Param Tab Commands		
Softkey	Sub-item	SCPI
S11	On/Off	CALCulate:MEASure:PARAmeter
S21	On/Off	CALCulate:MEASure:PARAmeter
S12	On/Off	CALCulate:MEASure:PARAmeter
S22	On/Off	CALCulate:MEASure:PARAmeter
Other...	S21, S11, S12, S22, AI1, AI2, CompIn21, CompOut21, DeltaGain21, CompGain21, CompS11, Ref21, CompAI1, CompAI2	CALCulate:MEASure:PARAmeter
Auxiliary Tab Commands		
Softkey	Sub-item	SCPI
AuxIn1 Source Port 1	On/Off	CALCulate:MEASure:PARAmeter
AuxIn2 Source Port 1	On/Off	CALCulate:MEASure:PARAmeter
CompAI1	On/Off	CALCulate:MEASure:PARAmeter

CompAI2	On/Off	CALCulate:MEASure:PARAmeter
Other...	S21, S11, S12, S22, AI1, AI2, CompIn21, CompOut21, DeltaGain21, CompGain21, CompS11, Ref21, CompAI1, CompAI2	CALCulate:MEASure:PARAmeter
Meas Setup Tab Commands		
Softkey	Sub-item	SCPI
Conversions		
Correction	Channel Correction On	SENSe:CORRection[:STATe]
	Channel Correction Off	SENSe:CORRection[:STATe]
	Cal Set...	
	Smart Cal...	
Trace Hold		
Equation Editor...		
Memory...		

Time Domain...		
Pulse Setup...		

CF_Meas Commands - NF

Click [here](#) to view links to Meas commands for all Measurement Classes.

Noise	Incident Noise Power	Available Noise Power	Noise Correlation	S-Param	Receivers	Meas Setup
--------------	-----------------------------	------------------------------	--------------------------	----------------	------------------	-------------------

Noise Tab Commands		
Softkey	Sub-item	SCPI
NF	On/Off	CALCulate:MEASure:PARAmeter
T-Eff	On/Off	CALCulate:MEASure:PARAmeter
ENR	On/Off	CALCulate:MEASure:PARAmeter
NFmin	On/Off	CALCulate:MEASure:PARAmeter
GammaOpt	On/Off	CALCulate:MEASure:PARAmeter
Rn	On/Off	CALCulate:MEASure:PARAmeter
Other...	NF Noise Figure	CALCulate:MEASure:PARAmeter
	T-Eff Noise Temperature	CALCulate:MEASure:PARAmeter
	ENR Excess Noise Ratio	CALCulate:MEASure:PARAmeter

DUTRNP Available DUT Relative Noise Power	CALCulate:MEASure:PARAmeter
SYSRNP Available System Relative Noise Power	CALCulate:MEASure:PARAmeter
DUTNPD Available DUT Noise Power Density	CALCulate:MEASure:PARAmeter
SYSNPD Available System Noise Power Density	CALCulate:MEASure:PARAmeter
DUTRNPI Incident DUT Relative Noise Power	CALCulate:MEASure:PARAmeter
SYSRNPI Incident System Relative Noise Power	CALCulate:MEASure:PARAmeter
DUTNPDI Incident DUT Noise Power Density	CALCulate:MEASure:PARAmeter
SYSNPDI Incident System Noise Power Density	CALCulate:MEASure:PARAmeter
S11, S21, S12, S22	CALCulate:MEASure:PARAmeter
R1_1 Input pwr at DUT-IN @ IN freq	CALCulate:MEASure:PARAmeter

R2_2 Input pwr at DUT-OUT @ OUT freq	CALCulate:MEASure:PARAmeter
A_1 Out pwr at DUT-IN @ IN freq	CALCulate:MEASure:PARAmeter
A_2 Out pwr at DUT-IN @ IN freq	CALCulate:MEASure:PARAmeter
B_1 Out Pwr at DUT-OUT @ OUT freq	CALCulate:MEASure:PARAmeter
B_2 Out Pwr at DUT-OUT @ OUT freq	CALCulate:MEASure:PARAmeter
NFmin Minimum Noise Figure	CALCulate:MEASure:PARAmeter
GammOpt Optimum Complex Reflection Coefficient	CALCulate:MEASure:PARAmeter
Rn Noise Resistance	CALCulate:MEASure:PARAmeter
NCorr_11 Correlation(1,1)	CALCulate:MEASure:PARAmeter
NCorr_12 Correlation(1,2)	CALCulate:MEASure:PARAmeter
NCorr_21 Correlation(2,1)	CALCulate:MEASure:PARAmeter
NCorr_22 Correlation(2,2)	CALCulate:MEASure:PARAmeter

Meas Class...		CALCulate:MEASure:DEFine
Incident Noise Power Tab Commands		
Softkey	Sub-item	SCPI
Incident DUT Relative NPwr	On/Off	CALCulate:MEASure:PARAmeter
Incident DUT NPwr Density	On/Off	CALCulate:MEASure:PARAmeter
Incident Syst Relative NPwr	On/Off	CALCulate:MEASure:PARAmeter
Incident Syst NPwr Density	On/Off	CALCulate:MEASure:PARAmeter
Other...		
Available Noise Power Tab Commands		
Softkey	Sub-item	SCPI
Available DUT Relative NPwr	On/Off	CALCulate:MEASure:PARAmeter

Available DUT NPwr Density	On/Off	CALCulate:MEASure:PARAmeter
Available Syst Relative NPwr	On/Off	CALCulate:MEASure:PARAmeter
Available Syst NPwr Density	On/Off	CALCulate:MEASure:PARAmeter
Other...		
Noise Correlation Tab Commands		
Softkey	Sub-item	SCPI
NCorr_11	On/Off	CALCulate:MEASure:PARAmeter
NCorr_12	On/Off	CALCulate:MEASure:PARAmeter
NCorr_21	On/Off	CALCulate:MEASure:PARAmeter
NCorr_22	On/Off	CALCulate:MEASure:PARAmeter
Other...		
S-Param Tab Commands		

Softkey	Sub-item	SCPI
S11	On/Off	CALCulate:MEASure:PARAmeter
S21	On/Off	CALCulate:MEASure:PARAmeter
S12	On/Off	CALCulate:MEASure:PARAmeter
S22	On/Off	CALCulate:MEASure:PARAmeter
Other...		

Receivers Tab Commands

Softkey	Sub-item	SCPI
A Source Port 1	On/Off	CALCulate:MEASure:PARAmeter
A Source Port 2	On/Off	CALCulate:MEASure:PARAmeter
B Source Port 1	On/Off	CALCulate:MEASure:PARAmeter
B Source Port 2	On/Off	CALCulate:MEASure:PARAmeter
R1 Source Port 1	On/Off	CALCulate:MEASure:PARAmeter

R2 Source Port 2	On/Off	CALCulate:MEASure:PARAmeter
Other...		
Meas Setup Tab Commands		
Softkey	Sub-item	SCPI
Conversions		
Correction	Channel Correction On	SENSe:CORRection[:STATe]
	Channel Correction Off	SENSe:CORRection[:STATe]
	Cal Set...	
	Smart Cal...	
Trace Hold		
Equation Editor...		
Memory...		
Time Domain...		

Pulse Setup...		
----------------	--	--

CF_Meas Commands - SMC

Click [here](#) to view links to Meas commands for all Measurement Classes.

S-Param	Power	Meas Setup
---------	-------	------------

S-Param Tab Commands		
Softkey	Sub-item	SCPI
S11	On/Off	CALCulate:MEASure:PARAmeter
SC21	On/Off	CALCulate:MEASure:PARAmeter
SC12	On/Off	CALCulate:MEASure:PARAmeter
S22	On/Off	CALCulate:MEASure:PARAmeter
Other...	SC21 Forward Conversion	CALCulate:MEASure:PARAmeter
	SC12 Reverse Conversion	CALCulate:MEASure:PARAmeter
	S11 Input Match	CALCulate:MEASure:PARAmeter
	S22 Output Match	CALCulate:MEASure:PARAmeter
	IPwr Input Power	CALCulate:MEASure:PARAmeter

	OPwr Output Power	CALCulate:MEASure:PARAmeter
	RevIPwr Reverse Input Power	CALCulate:MEASure:PARAmeter
	RevOPwr Reverse Output Power	CALCulate:MEASure:PARAmeter
	AI1,1 AI1	CALCulate:MEASure:PARAmeter
	AI2,1 AI2	CALCulate:MEASure:PARAmeter
	AI1,2 AI1	CALCulate:MEASure:PARAmeter
	AI2,2 AI2	CALCulate:MEASure:PARAmeter
Meas Class...		CALCulate:MEASure:DEFine
Power Tab Commands		
IPwr	On/Off	CALCulate:MEASure:PARAmeter
OPwr	On/Off	CALCulate:MEASure:PARAmeter
RevIPwr	On/Off	CALCulate:MEASure:PARAmeter
RevOPwr	On/Off	CALCulate:MEASure:PARAmeter
Other...		

Meas Setup Tab Commands

Softkey	Sub-item	SCPI
Conversions		
Correction	Channel Correction On	SENSe:CORRection[:STATe]
	Channel Correction Off	SENSe:CORRection[:STATe]
	Cal Set...	
	Smart Cal...	
Trace Hold		
Equation Editor...		
Memory...		
Time Domain...		

CF_Meas Commands - Standard

Click [here](#) to view links to Meas commands for all Measurement Classes.

S-Param	Balanced	Receivers	Waves	Meas Setup
---------	----------	-----------	-------	------------

S-Param Tab Commands		
Softkey	Sub-item	SCPI
S11	On/Off	CALCulate:MEASure:PARAmeter
S21	On/Off	CALCulate:MEASure:PARAmeter
S12	On/Off	CALCulate:MEASure:PARAmeter
S22	On/Off	CALCulate:MEASure:PARAmeter
Other...	S11, S12, S13, S14, S21, S22, S23, S24, S31, S32, S33, S34, S41, S42, S43, S44	CALCulate:MEASure:PARAmeter
	S-Parameter	CALCulate:MEASure:PARAmeter
	Balanced	CALCulate:MEASure:PARAmeter

	Receivers	CALCulate:MEASure:PARAmeter
Meas Class...		CALCulate:MEASure:DEFine
Balanced Tab Commands		
Softkey	Sub-item	SCPI
Sss11	On/Off	CALCulate:MEASure:PARAmeter
Sds21	On/Off	CALCulate:MEASure:PARAmeter
Ssd12	On/Off	CALCulate:MEASure:PARAmeter
Sdd22	On/Off	CALCulate:MEASure:PARAmeter
Other...	Sdd11, Scd11, Sdc11, Scc11, Ssd21, Ssc21, Sds12, Scs12, Sss22	CALCulate:MEASure:PARAmeter
	Sdd11, Sdd12, Sdd22, Scd11, Scd12, Scd21, Scd22, Sdc11, Sdc12,	CALCulate:MEASure:PARAmeter

	Sdc21, Sdc22, Scc11, Scc12, Scc21, Scc22	
	Sss11, Ssd12, Ssc12, Sds21, Scs21, Sdd22, Sdc22, Scd22, Scc22	CALCulate:MEASure:PARAmeter
	Sss11, Sss12, Sss21, Sss22, Ssd13, Ssc13, Ssd23, Ssc23, Sds31, Sds32, Scs31, Scs32, Sdd33, Sdc33, Scd33, Scc33	CALCulate:MEASure:PARAmeter
	S-Parameter	CALCulate:MEASure:PARAmeter
	Balanced	CALCulate:MEASure:PARAmeter
	Receivers	CALCulate:MEASure:PARAmeter
Topology...	Topology	

BAL	CALCulate:FSIMulator:BALun:DEVice
BAL-BAL	CALCulate:FSIMulator:BALun:DEVice
BAL-SE	CALCulate:FSIMulator:BALun:DEVice
SE-BAL	CALCulate:FSIMulator:BALun:DEVice
SE-SE-BAL	CALCulate:FSIMulator:BALun:DEVice
Custom	CALCulate:FSIMulator:BALun:DEVice
Stimulus	
Single Ended	CALCulate:FSIMulator:BALun:STIMulus:MODE
True Mode	CALCulate:FSIMulator:BALun:STIMulus:MODE
Forward True Mode	CALCulate:FSIMulator:BALun:STIMulus:MODE
Reverse True Mode	CALCulate:FSIMulator:BALun:STIMulus:MODE
Source Only Mode	CALCulate:FSIMulator:BALun:STIMulus:MODE
Balanced Port Offset	
Select Port	CALCulate:FSIMulator:BALun:BPORt:OFFSet:PHASe

	Phase Offset	CALCulate:FSIMulator:BALun:BPORt:OFFSet:PHASe
	Offset as fixture	CALCulate:FSIMulator:BALun:FIXTure:OFFSet:PHASe
	Power Offset	CALCulate:FSIMulator:BALun:BPORt:OFFSet:POWER
	Offset as fixture	CALCulate:FSIMulator:BALun:FIXTure:OFFSet:POWER
Phase Sweep (CW Time Only)		
	Enable Phase Sweep	CALCulate:FSIMulator:BALun:PHASe:SWEep:STATe
	Sweep Phase On	
	Start Phase	CALCulate:FSIMulator:BALun:BPORt:SWEep:PHASe:START
	Stop Phase	CALCulate:FSIMulator:BALun:BPORt:SWEep:PHASe:STOP
	Offset as fixture	CALCulate:FSIMulator:BALun:FIXTure:PHASe
Receivers Tab Commands		
Softkey	Sub-item	SCPI
A Source Port 1	On/Off	CALCulate:MEASure:PARAmeter

A Source Port 2	On/Off	CALCulate:MEASure:PARAmeter
B Source Port 1	On/Off	CALCulate:MEASure:PARAmeter
B Source Port 2	On/Off	CALCulate:MEASure:PARAmeter
R1 Source Port 1	On/Off	CALCulate:MEASure:PARAmeter
R2 Source Port 2	On/Off	CALCulate:MEASure:PARAmeter
Other...	(A,1), (A,2), (A,3), (A,4), (B,1), (B,2), (B,3), (B,4), (C,1), (C,2), (C,3), (C,4), (D,1), (D,2), (D,3), (D,4), (R1,1), (R2,2), (R3,3), (R4,4)	CALCulate:MEASure:PARAmeter
	S-Parameter	CALCulate:MEASure:PARAmeter
	Balanced	CALCulate:MEASure:PARAmeter

	Receivers	CALCulate:MEASure:PARAmeter
Waves Tab Commands		
Softkey	Sub-item	SCPI
a1 Source Port 1	On/Off	CALCulate:MEASure:PARAmeter
a2 Source Port 2	On/Off	CALCulate:MEASure:PARAmeter
b1 Source Port 1	On/Off	CALCulate:MEASure:PARAmeter
b1 Source Port 2	On/Off	CALCulate:MEASure:PARAmeter
b2 Source Port 1	On/Off	CALCulate:MEASure:PARAmeter
b2 Source Port 2	On/Off	CALCulate:MEASure:PARAmeter
Other...	(a1,1), (a2,2), (a3,3), (a4,4), (b1,1), (b1,2), (b1,3), (b1,4), (b2,1), (b2,2), (b2,3), (b2,4),	CALCulate:MEASure:PARAmeter

	(b3,1), (b3,2), (b3,3), (b3,4), (b4,1), (b4,2), (b4,3), (b4,4)	
	S-Parameter	CALCulate:MEASure:PARAmeter
	Balanced	CALCulate:MEASure:PARAmeter
	Receivers	CALCulate:MEASure:PARAmeter

Meas Setup Tab Commands

Softkey	Sub-item	SCPI
Conversions	Off	CALCulate:MEASure:CONVersion:FUNction
	Z-Reflect	CALCulate:MEASure:CONVersion:FUNction
	Z-Transmit	CALCulate:MEASure:CONVersion:FUNction
	Z-Trans-Shunt	CALCulate:MEASure:CONVersion:FUNction
	Y-Reflect	CALCulate:MEASure:CONVersion:FUNction
	Y-Transmit	CALCulate:MEASure:CONVersion:FUNction

	Y-Trans-Shunt	CALCulate:MEASure:CONVersion:FUNction
	1 / S	CALCulate:MEASure:CONVersion:FUNction
	Conjugation	CALCulate:MEASure:CONVersion:FUNction
Correction	Channel Correction On	SENSe:CORRection[:STATe]
	Channel Correction Off	SENSe:CORRection[:STATe]
	Cal Set...	
	Basic Cal...	
	Smart Cal...	
Trace Hold	Off	CALCulate:MEASure:HOLD:TYPE
	Max	CALCulate:MEASure:HOLD:TYPE
	Min	CALCulate:MEASure:HOLD:TYPE
	Restart	CALCulate:MEASure:HOLD:CLEAr
	On/Off	CALCulate:MEASure:EQUation[:STATe]

Equation Editor...	Equation	CALCulate:MEASure:EQUation:TEXT
	Enable Equation	CALCulate:MEASure:EQUation[:STATe]
	Functions	CALCulate:EQUation:LIBRary:FUNCTions
	Trace Data	None
	Parameter	None
	Store Equation	None
	Delete Equation	None
	Use Short Names	None
	Enable Matlab	None
	Import...	None
	Import Library	CALCulate:EQUation:LIBRary:IMPorT
	Remove Library	CALCulate:EQUation:LIBRary:REMOve
Memory...	Data->Memory	CALCulate:MEASure:MATH:MEMorize
	Data Math	

	Off	CALCulate:MEASure:MATH:FUNCTion
	Data / Memory	CALCulate:MEASure:MATH:FUNCTion
	Data * Memory	CALCulate:MEASure:MATH:FUNCTion
	Data - Memory	CALCulate:MEASure:MATH:FUNCTion
	Data + Memory	CALCulate:MEASure:MATH:FUNCTion
	8510 Mode	None
Trace View Options		
	Data Trace	DISPlay:WINDow:TRACe[:STATe]
	Memory Trace	DISPlay:WINDow:TRACe:MEMory
	Data and Memory Trace	DISPlay:WINDow:TRACe[:STATe] DISPlay:WINDow:TRACe:MEMory
Time Domain...	Transform	
	Transform On	CALCulate:MEASure:TRANSform:TIME:STATe
	Start	CALCulate:MEASure:TRANSform:TIME:STARt

Stop	CALCulate:MEASure:TRANSform:TIME:STOP
Center	CALCulate:MEASure:TRANSform:TIME:CENTer
Span	CALCulate:MEASure:TRANSform:TIME:SPAN
Low Pass Impulse	CALCulate:MEASure:TRANSform:TIME[:TYPE]
Low Pass Step	CALCulate:MEASure:TRANSform:TIME[:TYPE]
Band Pass	CALCulate:MEASure:TRANSform:TIME[:TYPE]
Set Low Pass Frequencies	CALCulate:MEASure:TRANSform:TIME:LPFREQuency
Gating	
Gating On	CALCulate:MEASure:FILTer[:GATE]:TIME:STATe
Start	CALCulate:MEASure:FILTer[:GATE]:TIME:STARt
Stop	CALCulate:MEASure:FILTer[:GATE]:TIME:STOP
Center	CALCulate:MEASure:FILTer[:GATE]:TIME:CENTer
Span	CALCulate:MEASure:FILTer[:GATE]:TIME:SPAN

Gate Type	CALCulate:MEASure:FILTer[:GATE]:TIME[:TYPE]
Gate Shape	CALCulate:MEASure:FILTer[:GATE]:TIME:SHAPE
Window	
Minimum/Maximum	DISPlay:WINDow:SIZE
Kaiser Beta	CALCulate:MEASure:TRANSform:TIME:KBESsel
Impulse Width	CALCulate:MEASure:TRANSform:TIME:IMPulse:WIDTh
Coupling	
Coupling On	SENSe:COUPlE:PARAmeter[:STATE]
Transform Parameters	
Stimulus	CALCulate:MEASure:TRANSform:COUPlE:PARAmeters
State (On/Off)	CALCulate:MEASure:TRANSform:COUPlE:PARAmeters
Window	CALCulate:MEASure:TRANSform:COUPlE:PARAmeters
Mode	CALCulate:MEASure:TRANSform:COUPlE:PARAmeters

Distance Marker Unit	CALCulate:MEASure:TRANSform:COUPlE:PARAmeters
Gating Parameters	
Stimulus	CALCulate:MEASure:FILTer[:GATE]:COUPlE:PARAmeters
State (On/Off)	CALCulate:MEASure:FILTer[:GATE]:COUPlE:PARAmeters
Shape	CALCulate:MEASure:FILTer[:GATE]:COUPlE:PARAmeters
Type	CALCulate:MEASure:FILTer[:GATE]:COUPlE:PARAmeters
Marker	
Auto	CALCulate:MEASure:TRANSform:TIME:MARKer:MODE
Reflection (divide by 2)	CALCulate:MEASure:TRANSform:TIME:MARKer:MODE
Transmission	CALCulate:MEASure:TRANSform:TIME:MARKer:MODE
Meters (m)	CALCulate:MEASure:TRANSform:TIME:MARKer:UNIT
Feet (ft)	CALCulate:MEASure:TRANSform:TIME:MARKer:UNIT
Inches (in)	CALCulate:MEASure:TRANSform:TIME:MARKer:UNIT

	Velocity Factor	SENSe:CORRection:EXTension:PORT:VELFactor
--	-----------------	---

CF_Power Commands

The Power softkeys vary depending on which measurement class is currently active. Click on a measurement class link below to view the corresponding softkeys.

[Standard](#)

[Gain Compression](#)

[Scalar Mixer/Converter](#)

CF_Power Commands - GCA_GCX

Only the **Main**, **Compression Levels**, and **Leveling & Offsets** Power commands corresponding to the Gain Compressions and Gain Compression Converters measurement classes are documented here. The **Attenuators** commands are identical to the Attenuator commands for the Standard measurement class and can be accessed by clicking [here](#) or by clicking on the softtab on the graphic below.

Click [here](#) to view links to Power commands for all Measurement Classes.

Main	Compress Levels	Leveling & Offsets	Attenuators
Main Tab Commands			
Softkey	Sub-item	SCPI	
Linear Input Pwr		SENSe:GCSetup:POWer:LINear:INPut:LEVel	
RF Power	ON/OFF	OUTPut[:STATe]	
Start Power		SOURce:POWer:PORT:START	
Stop Power		SOURce:POWer:PORT:STOP	
Power and Attenuators...			
GCA Setup... (Gain Compression Measurement Class only)			

<p>GCX Setup... (Gain Compression Converters Measurement Class only)</p>		
<p>Compress Levels Tab Commands</p>		
Softkey	Sub-item	SCPI
<p>Comp Method</p>	<p>Linear Gain</p>	<p>SENSe:GCSetup:POWer:LINear:INPut:LEVel</p>
	<p>Max Gain</p>	<p>SENSe:GCSetup:COMPression:LEVel</p>
	<p>Backoff</p>	<p>SENSe:GCSetup:COMPression:BACKoff:LEVel</p>
	<p>XY</p>	<p>SENSe:GCSetup:COMPression:DELTA:X SENSe:GCSetup:COMPression:DELTA:Y</p>
	<p>Saturation</p>	<p>SENSe:GCSetup:COMPression:SATuration:LEVel</p>
<p>Linear Input Pwr</p>		<p>SENSe:GCSetup:POWer:LINear:INPut:LEVel</p>
<p>Reverse Pwr</p>		<p>SENSe:GCSetup:POWer:REVerse:LEVel</p>
<p>Compression Level</p>		<p>SENSe:GCSetup:COMPression:LEVel</p>
<p>Back Off Level</p>		<p>SENSe:GCSetup:COMPression:BACKoff:LEVel</p>

Delta X		SENSe:GCSetup:COMPression:DELTA:X
Delta Y		SENSe:GCSetup:COMPression:DELTA:Y
Saturation		SENSe:GCSetup:COMPression:SATuration:LEVel
Leveling & Offsets Tab Commands		
Softkey	Sub-item	SCPI
Select	Port 1	None
	Port 2	None
	Port 3	None
	Port 4	None
Offset		SOURce:POWer:ALC[:MODE]:RECeiver:OFFSet
Limit	ON/OFF	SYSTem:POWer:LIMit:STATe
	Power Limit	SYSTem:POWer:LIMit
Offsets and Limits...		

ALC Hardware	Internal	SOURce:POWer:ALC[:MODE]
	Open Loop	SOURce:POWer:ALC[:MODE]
Receiver Leveling...		

CF_Power Commands - SA

Only the **Main**, **Port Power**, and **Leveling & Offsets** Power commands corresponding to the Spectrum Analyzer measurement class are documented here. The **Attenuators** commands are identical to the Attenuator commands for the Standard measurement class and can be accessed by clicking [here](#) or by clicking on the softtab on the graphic below.

Click [here](#) to view links to Power commands for all Measurement Classes.



Main Tab Commands			
Softkey	Sub-item	SCPI	COM
RF Power	ON/OFF	OUTPut[:STATe]	SourcePortMode
Power and Attenuators..			
SA Setup...			
Port Power Tab Commands			
Softkey	Sub-item	SCPI	COM
Select	Port 1	None	SourcePortMode

	Port 2	None	SourcePortMode
	Port 3	None	SourcePortMode
	Port 4	None	SourcePortMode
Power Level		SOURce:POWer[:LEVel][:IMMediate][:AMPLitude]	TestPortPower
Source State	AUTO	SOURce:POWer:MODE	SourcePortMode
	ON	SOURce:POWer:MODE	SourcePortMode
	OFF	SOURce:POWer:MODE	SourcePortMode
Coupling	ON	SOURce:POWer:COUPle	CouplePorts
	OFF	SOURce:POWer:COUPle	CouplePorts
Leveling & Offsets Tab Commands			
Softkey	Sub-item	SCPI	COM
Select	Port 1	SOURce:POWer:MODE	SourcePortMode

	Port 2	SOURce:POWer:MODE	SourcePortMode
	Port 3	SOURce:POWer:MODE	SourcePortMode
	Port 4	SOURce:POWer:MODE	SourcePortMode
Slope	ON/OFF	SOURce:POWer[:LEVel]:SLOPe:STATe	PowerSlopeState
	Power Slope	SOURce:POWer[:LEVel]:SLOPe	PowerSlope
Offset		SOURce:POWer:CORRection:OFFSet:MAGNitude	PowerOffset
Limit	ON/OFF	SYSTem:POWer:LIMit:STATe	State
	Power Limit	SYSTem:POWer:LIMit	Limit
Offsets and Limits...			
ALC Hardware	Internal	SOURce:POWer:ALC[:MODE]	ALCLevelingMode

	Open Loop	SOURce:POWer:ALC[:MODE]	ALCLevelingMod e
--	--------------	-------------------------	---------------------

CF_Power Commands - SMC_VMC

Only the **Main**, **Port Power**, and **Leveling & Offsets** Power commands corresponding to the Scalar Mixer/Converter measurement class are documented here. The **Attenuators** commands are identical to the Attenuator commands for the Standard measurement class and can be accessed by clicking [here](#) or by clicking on the softtab on the graphic below.

Click [here](#) to view links to Power commands for all Measurement Classes.



Main Tab Commands		
Softkey	Sub-item	SCPI
Power Level		<code>SOURce:POWer[:LEVel][:IMMediate][:AMPLitude]</code> <code>DISPlay:GUI:POWer:SPIN:RESolution</code>
RF Power	ON/OFF	<code>OUTPut[:STATe]</code>
Power and Attenuators...		
SMC Setup... (Scalar Mixer/Converter Measurement Class only)		
Port Power Tab Commands		
Softkey	Sub-item	SCPI
Select	Port 1	None

	Port 2	None
	Port 3	None
	Port 4	None
Power Level		<code>SOURce:POWer[:LEVel][:IMMediate][:AMPLitude]</code>
Source State	AUTO	<code>SOURce:POWer:MODE</code>
	ON	<code>SOURce:POWer:MODE</code>
	OFF	<code>SOURce:POWer:MODE</code>
Coupling	ON	<code>SOURce:POWer:COUPle</code>
	OFF	<code>SOURce:POWer:COUPle</code>
Leveling & Offsets Tab Commands		
Softkey	Sub-item	SCPI
Select	Port 1	None
	Port 2	None

	Port 3	None
	Port 4	None
Slope	ON/OFF	SOURce:POWer[:LEVel]:SLOPe:STATe
	Power Slope	SOURce:POWer[:LEVel]:SLOPe
Offset		SOURce:POWer:ALC[:MODE]:RECEiver:OFFSet
Limit	ON/OFF	SYSTem:POWer:LIMit:STATe
	Power Limit	SYSTem:POWer:LIMit
Offsets and Limits...		
ALC Hardware	Internal	SOURce:POWer:ALC[:MODE]
	Open Loop	SOURce:POWer:ALC[:MODE]
Receiver Leveling...		

CF_Power Commands - Standard

Click [here](#) to view links to Power commands for all Measurement Classes.

Main	Port Power	Leveling & Offsets
------	------------	--------------------

Main Tab Commands		
Softkey	Sub-item	SCPI
Power Level		<code>SOURce:POWer[:LEVel][:IMMediate][:AMPLitude]</code> <code>DISPlay:GUI:POWer:SPIN:RESolution</code>
RF Power	ON/OFF	<code>OUTPut[:STATe]</code>
Start Power		<code>SOURce:POWer:PORT:START</code>
Stop Power		<code>SOURce:POWer:PORT:STOP</code>
Power and Attenuators...	Power ON (All Channels)	None
	Port Powers Coupled	<code>SOURce:POWer:COUPlE</code>
	Name	<code>SOURce:POWer:MODE</code>
	State	<code>SOURce:POWer:MODE</code>
	Port Power	<code>SOURce:POWer[:LEVel][:IMMediate][:AMPLitude]</code>

Start Power	SOURce:POWer:PORT:START
Stop Power	SOURce:POWer:PORT:STOP
Leveling Mode	SOURce:POWer:ALC[:MODE]
Channel Power Slope	SOURce:POWer[:LEVel]:SLOPe:STATe SOURce:POWer[:LEVel]:SLOPe
Offsets and Limits...	
Power Limit - State	SYSTem:POWer:LIMit:STATe
Power Limit - Limit	SYSTem:POWer:LIMit
Source Power	SOURce:POWer[:LEVel][:IMMediate][:AMPLitude]
Power Offset	SOURce:POWer:ALC[:MODE]:RECEiver:OFFSet
Port Power	SOURce:POWer:PORT:START SOURce:POWer:PORT:STOP
Receiver Leveling...	
Enable Receiver Leveling	SOURce:POWer:ALC[:MODE]:RECEiver

Define Controlled Source	SOURce:POWer:ALC[:MODE]:RECEiver:REFerence
Leveling Receiver setup	
Receiver name	SOURce:POWer:ALC[:MODE]:RECEiver:REFerence
Level when this RF source is turned on	SOURce:POWer:ALC[:MODE]:RECEiver:REFerence
Receiver frequency is determined by	SOURce:POWer:ALC[:MODE]:RECEiver:FTYPE
Leveling loop tolerance	SOURce:POWer:ALC[:MODE]:RECEiver:TOLerance
Leveling loop max iterations	SOURce:POWer:ALC[:MODE]:RECEiver:ITERation
Leveling uses IFBW	SOURce:POWer:ALC[:MODE]:RECEiver:IFBW

	Controlled Source setup	
	Update source power calibration with leveling data	SOURce:POWer:ALC[:MODE]:RECeiver:LSPC
	Enable source ALC hardware circuit	SOURce:POWer:ALC[:MODE]
	Max port output	
	Enable Safe Mode while leveling	SOURce:POWer:ALC[:MODE]:RECeiver:SAFE
	Min port output	SOURce:POWer:ALC[:MODE]:RECeiver:SAFE:MIN
	Max source step size	SOURce:POWer:ALC[:MODE]:RECeiver:SAFE:STEP

Port Power Tab Commands

Softkey	Sub-item	SCPI
Select	Port 1	None

	Port 2	None
	Port 3	None
	Port 4	None
Power Level		SOURce:POWer[:LEVel][:IMMediate][:AMPLitude]
Start Power		SOURce:POWer:PORT:START
Stop Power		SOURce:POWer:PORT:STOP
Source State	AUTO	SOURce:POWer:MODE
	ON	SOURce:POWer:MODE
	OFF	SOURce:POWer:MODE
Coupling	ON	SOURce:POWer:COUPlE
	OFF	SOURce:POWer:COUPlE
Leveling & Offsets Tab Commands		
Softkey	Sub-item	SCPI

Select	Port 1	None
	Port 2	None
	Port 3	None
	Port 4	None
Slope	ON/OFF	SOURce:POWer[:LEVel]:SLOPe:STATe
	Power Slope	SOURce:POWer[:LEVel]:SLOPe
Offset		SOURce:POWer:CORRection:OFFSet:MAGNitude
Limit	ON/OFF	SYSTem:POWer:LIMit:STATe
	Power Limit	SYSTem:POWer:LIMit
Offsets and Limits...	Power Limit - State	SYSTem:POWer:LIMit:STATe
	Power Limit - Limit	SYSTem:POWer:LIMit
	Source Power	SOURce:POWer[:LEVel][:IMMediate][:AMPLitude]
	Power Offset	SOURce:POWer:ALC[:MODE]:RECEiver:OFFSet

	Port Power	SOURce:POWer:PORT:START SOURce:POWer:PORT:STOP
ALC Hardware	Internal	SOURce:POWer:ALC[:MODE]
	Open Loop	SOURce:POWer:ALC[:MODE]
Receiver Leveling...		

CF_Preset Commands

Main Tab Commands		
Softkey	Sub-item	SCPI
Preset		SYSTem:PRESet
User Preset...	ON/OFF	SYSTem:PREFerences:ITEM:POWer[STATE]
Confirm Preset		SYSTem:PREFerences:ITEM:PRESet:CONFirm

CF_Save-Recall Commands

Recall Tab Commands		
Softkey	Sub-item	SCPI
Recall State		MMEMory:LOAD
Recall State		MMEMory:LOAD
Recall State...		MMEMory:LOAD
Recall Register		MMEMory:LOAD
Recall Calset...		MMEMory:LOAD
Recall Data...		MMEMory:LOAD
Recall Order	NAME	MMEMory:LOAD
	RECENT	MMEMory:LOAD
Save State Tab Commands		
Softkey	Sub-item	SCPI
Save State		MMEMory:STORe

Auto Save		MMEMory:STORe
Save State As...		MMEMory:STORe
Save Register		MMEMory:STORe
Save Type	State	MMEMory:STORe
	State + Cal Data	MMEMory:STORe
	State + Cal Link	MMEMory:STORe
Delete State		MMEMory:STORe
Save Other Tab Commands		
Softkey	Sub-item	SCPI
Save Calset...		SENSe:CORRection:CSET:SAVE
Save Data...		MMEMory:STORe
Save Screen...		MMEMory:STORe
Save User Preset...		MMEMory:STORe

Manage Files...		None
-----------------	--	------

CF_Scale Commands

Main Tab Commands		
Softkey	Sub-item	SCPI
Autoscale		DISPlay:MEASure:Y[:SCALe]:AUTO
Autoscale All		DISPlay:WINDow:Y:AUTO
Scale		DISPlay:MEASure:Y[:SCALe]:PDIVision
Reference Level		DISPlay:MEASure:Y[:SCALe]:RLEVel
Reference Position		DISPlay:MEASure:Y[:SCALe]:RPOSition
Scale Coupling...	Off	DISPlay:WINDow:TRACe:Y[:SCALe]:COUPlE:METhod
	Window	DISPlay:WINDow:TRACe:Y[:SCALe]:COUPlE:METhod
	All: couple between all selected windows	DISPlay:WINDow:TRACe:Y[:SCALe]:COUPlE:METhod
	Selected Windows	DISPlay:WINDow:TRACe:Y[:SCALe]:COUPlE[:STATe]
Electrical Delay Tab Commands		

Softkey	Sub-item	SCPI
Delay Time		CALCulate:MEASure:CORRection:EDELay[:TIME]
Delay Distance		CALCulate:MEASure:CORRection:EDELay:DISTance
Distance Units	Meters	CALCulate:MEASure:CORRection:EDELay:UNIT
	Feet	CALCulate:MEASure:CORRection:EDELay:UNIT
	Inches	CALCulate:MEASure:CORRection:EDELay:UNIT
Velocity Factor		SENSe:CORRection:RVELocity:COAX
Media		CALCulate:MEASure:CORRection:EDELay:MEDIum
Wavegd Cutoff		CALCulate:MEASure:CORRection:EDELay:WGCutoff
Constants Tab Commands		
Softkey	Sub-item	SCPI
System Z0		SENSe:CORRection:IMPedance:INPut:MAGNitude

Phase Offset		CALCulate:MEASure:OFFSet:PHASe
Mag Offset		CALCulate:MEASure:OFFSet:MAGNitude
Mag Slope		CALCulate:MEASure:OFFSet:MAGNitude:SOPe

CF_Search Commands

Main	Peak	Target	Multi Peak & Target	Bandwidth & Notch	Comp & Sat	Normal Op Pt
------	------	--------	---------------------	-------------------	------------	--------------

Main Tab Commands

Softkey	Sub-item	SCPI
Max Search		CALCulate:MEASure:MARKer:FUNCTion:EXECute
Min Search		CALCulate:MEASure:MARKer:FUNCTion:EXECute
Domain	Full Span	CALCulate:MEASure:MARKer:FUNCTion:DOMain:USER[:RANGe]
	User N	CALCulate:MEASure:MARKer:FUNCTion:DOMain:USER[:RANGe]
Domain Start		CALCulate:MEASure:MARKer:FUNCTion:DOMain:USER:START
Domain Stop		CALCulate:MEASure:MARKer:FUNCTion:DOMain:USER:STOP
Tracking	Off	CALCulate:MEASure:MARKer:FUNCTion:TRACKing
	Max	CALCulate:MEASure:MARKer:FUNCTion:TRACKing
	Min	CALCulate:MEASure:MARKer:FUNCTion:TRACKing

	Peak	CALCulate:MEASure:MARKer:FUNCTion:TRACKing
	Target	CALCulate:MEASure:MARKer:FUNCTion:TRACKing
	Multi Peak	CALCulate:MEASure:MARKer:FUNCTion:TRACKing
	Multi Target	CALCulate:MEASure:MARKer:FUNCTion:TRACKing
	Compression	CALCulate:MEASure:MARKer:FUNCTion:TRACKing
Peak Tab Commands		
Softkey	Sub-item	SCPI
Peak Search		CALCulate:MEASure:MARKer:FUNCTion:EXECute
Peak Right >> Search		CALCulate:MEASure:MARKer:FUNCTion:EXECute
<< Peak Left Search		CALCulate:MEASure:MARKer:FUNCTion:EXECute
Next Peak Search		CALCulate:MEASure:MARKer:FUNCTion:EXECute
Threshold		CALCulate:MEASure:MARKer:FUNCTion:PEAK:THReshold

Excursion		CALCulate:MEASure:MARKer:FUNction:PEAK:EXCursion
Peak Polarity	Positive	CALCulate:MEASure:MARKer:FUNction:PEAK:POLarity
	Negative	CALCulate:MEASure:MARKer:FUNction:PEAK:POLarity
	Both	CALCulate:MEASure:MARKer:FUNction:PEAK:POLarity
Tracking		
Target Tab Commands		
Softkey	Sub-item	SCPI
Target Search		CALCulate:MEASure:MARKer:FUNction:EXECute
Target Right >> Search		CALCulate:MEASure:MARKer:FUNction:EXECute
<< Target Left Search		CALCulate:MEASure:MARKer:FUNction:EXECute
Target Value		CALCulate:MEASure:MARKer:FUNction:TARGet:VALue
Transition	Positive	CALCulate:MEASure:MARKer:FUNction:TARGet:TRANSition

	Negative	CALCulate:MEASure:MARKer:FUNCTion:TARGet:TRANsition
	Both	CALCulate:MEASure:MARKer:FUNCTion:TARGet:TRANsition
Tracking		
Multi Peak & Target Tab Commands		
Softkey	Sub-item	SCPI
Multi Peak Search		CALCulate:MEASure:MARKer:FUNCTion:MULTi:EXECute
Peak Threshold		CALCulate:MEASure:MARKer:FUNCTion:MULTi:PEAK:THReshold
Peak Excursion		CALCulate:MEASure:MARKer:FUNCTion:MULTi:PEAK:EXCursion
Peak Polarity	Positive	CALCulate:MEASure:MARKer:FUNCTion:MULTi:PEAK:POLarity
	Negative	CALCulate:MEASure:MARKer:FUNCTion:MULTi:PEAK:POLarity
	Both	CALCulate:MEASure:MARKer:FUNCTion:MULTi:PEAK:POLarity
Multi Target Search		CALCulate:MEASure:MARKer:FUNCTion:MULTi:EXECute

Target Value		CALCulate:MEASure:MARKer:FUNCTion:MULTi:TARGet[:VALue]
Transition	Positive	CALCulate:MEASure:MARKer:FUNCTion:MULTi:TARGet:TRANSiti on
	Negative	CALCulate:MEASure:MARKer:FUNCTion:MULTi:TARGet:TRANSiti on
	Both	CALCulate:MEASure:MARKer:FUNCTion:MULTi:TARGet:TRANSiti on
Tracking		

Bandwidth & Notch Tab Commands

Softkey	Sub-item	SCPI
Bandwidth Search	On/Off	CALCulate:MEASure:MARKer:BWIDth[:STATe]
BW Ref To	Marker	CALCulate:MEASure:MARKer:BWIDth:REF
	Peak	CALCulate:MEASure:MARKer:BWIDth:REF
BW Level		CALCulate:MEASure:MARKer:BWIDth:THReshold
Notch Search	On/Off	CALCulate:MEASure:MARKer:NOTCh[:STATe]

Notch Ref To	Marker	CALCulate:MEASure:MARKer:NOTCh:REF
	Peak	CALCulate:MEASure:MARKer:NOTCh:REF
Notch Level		CALCulate:MEASure:MARKer:NOTCh:THReshold
Tracking		
Comp & Sat Tab Commands		
Softkey	Sub-item	SCPI
Compression Search	On/Off	CALCulate:MEASure:MARKer:FUNCTion:COMPression[:STATe]
Comp Level		CALCulate:MEASure:MARKer:FUNCTion:COMPression:LEVel
Saturation Search	On/Off	CALCulate:MEASure:MARKer:PSATuration[:STATe]
Pmax Backoff		CALCulate:MEASure:MARKer:PSATuration:BACKoff
Tracking		
Normal Op Pt Tab Commands		

Softkey	Sub-item	SCPI
Normal OP Search	On/Off	CALCulate:MEASure:MARKer:PNOP[:STATe]
Backoff		CALCulate:MEASure:MARKer:PNOP:BACKoff
Pin Offset		CALCulate:MEASure:MARKer:PNOP:POFFset
Tracking		

CF_Setup Commands

The Setup softkeys vary depending on which measurement class is currently active. Click on a measurement class link below to view the corresponding softkeys.

[Standard](#)

[Gain Compression](#)

[Noise Figure Cold Source](#)

[Scalar Mixer/Converter + Phase](#)

[Spectrum Analyzer](#)

CF_Setup Commands - GCA

Only the **Main** and **Layout** Setup commands corresponding to the Gain Compression measurement class are documented here. All other commands are identical to the Setup commands for the Standard measurement class and can be accessed by clicking [here](#) or by clicking on the softtabs on the graphic below.

Click [here](#) to view links to Setup commands for all Measurement Classes.

Main	Layout	System Setup	Internal Hardware	External Hardware
-------------	---------------	---------------------	--------------------------	--------------------------

Main Tab Commands		
Softkey	Sub-item	SCPI
GCA Setup...	Frequency	
	Sweep Type	
	Linear Sweep	SENSe:SWEEp:TYPE
	Log Sweep	SENSe:SWEEp:TYPE
	Segment Sweep	SENSe:SWEEp:TYPE
	Data Acquisition Mode	
	SMART Sweep	SENSe:GCSetup:AMODE
	Sweep Power Per Frequency (2D)	SENSe:GCSetup:AMODE

Sweep Frequency Per Power (2D)	SENSe:GCSetup:AMODE
Sweep Settings	
Number of Points	SENSe:SWEEp:POINTs
IF Bandwidth	SENSe:BWIDTh[:RESolution]
Start	SENSe:FREQuency:STARt
Stop	SENSe:FREQuency:STOP
Center	SENSe:FREQuency:CENTer
Span	SENSe:FREQuency:SPAN
Power	
Power On (All Channels)	OUTPut[:STATe]
DUT Input Port	
Input Port	SENSe:GCSetup:PMAP
Linear Input Power	SENSe:GCSetup:POWEr:LINear:INPut:LEVel

Source Leveling Mode	SOURce:POWer:ALC[:MODE]
DUT Output Port	
Output Port	SENSe:GCSetup:PMAP
Reverse Power	SENSe:GCSetup:POWer:REVerse:LEVel
Source Leveling Mode	SOURce:POWer:ALC[:MODE]
Power Sweep	
Start (Min) Power	SENSe:GCSetup:POWer:START:LEVel
Stop (Max) Power	SENSe:GCSetup:POWer:STOP:LEVel
Power Points	SENSe:GCSetup:SWEep:FREQUency:POINts
Power Step	None
Path Configuration...	SENSe:PATH:CONFig:ELEMent[:STATe]
Compression	
Compression Method	

Compression from Linear Gain	SENSe:GCSetup:COMPression:ALGORITHM
Compression from Max Gain	SENSe:GCSetup:COMPression:ALGORITHM
Compression from Back Off	SENSe:GCSetup:COMPression:ALGORITHM
X/Y Compression	SENSe:GCSetup:COMPression:ALGORITHM
Compression from Saturation	SENSe:GCSetup:COMPression:ALGORITHM
Level	SENSe:GCSetup:COMPression:LEVEL
Back Off	SENSe:GCSetup:COMPression:BACKOFF:LEVEL
Delta X	SENSe:GCSetup:COMPression:DELTA:X
Delta Y	SENSe:GCSetup:COMPression:DELTA:Y
From Max Pout	SENSe:GCSetup:COMPression:SATURATION:LEVEL
SMART Sweep	
Tolerance	SENSe:GCSetup:SMART:TOLERANCE

Maximum Iterations	SENSe:GCSetup:SMART:MITerations
Show Iterations	SENSe:GCSetup:SMART:SITerations
Read DC at Compression Point	SENSe:GCSetup:SMART:CDC
Safe Mode...	
Safe Mode	SENSe:GCSetup:SAFE:ENABLE
Coarse Increment	SENSe:GCSetup:SAFE:CPADjustment
Fine Increment	SENSe:GCSetup:SAFE:FPADjustment
Fine Threshold	SENSe:GCSetup:SAFE:FTHReshold
Max Output Power	SENSe:GCSetup:SAFE:MLimit
2D Sweep	
Compression Point Interpolation	SENSe:GCSetup:COMPression:INTerpolation
End of Sweep Condition	SENSe:GCSetup:EOSoperation
Settling Time	SENSe:GCSetup:SMART:STIME

Quick Start...	S-Param	CALCulate:MEASure:PARAmeter
	Balanced	CALCulate:MEASure:PARAmeter
	Other	CALCulate:MEASure:PARAmeter

Layout Tab Commands

Softkey	Sub-item	SCPI
New Trace		DISPlay:WINDow:TRACe[:STATe]
New Channel		None
New Window		DISPlay:WINDow[:STATe]
New Sheet		DISPlay:SHEet:STATe
Delete	TrN	DISPlay:WINDow:TRACe:DELeTe
	ChN	SYSTem:CHANnels:DELeTe
	WinN	DISPlay:WINDow[:STATe]
Select	TrN	DISPlay:WINDow:TRACe:SELeCt

	ChN	None
	WinN	DISPlay:WINDow:TRACe:SElect
Measure...	S21, S11, S12, S22, AI1, AI2, Compln21, CompOut21, DeltaGain21, CompGain21, CompS11, Ref21, CompAI1, CompAI2	CALCulate:MEASure:PARAmeter
Meas Class...		CALCulate:MEASure:DEFine

CF_Setup Commands - NF

Only the **Main** and **Layout** Setup commands corresponding to the Noise Figure measurement class are documented here. All other commands are identical to the Setup commands for the Standard measurement class and can be accessed by clicking [here](#) or by clicking on the softtabs on the graphic below.

Click [here](#) to view links to Setup commands for all Measurement Classes.



Main Tab Commands		
Softkey	Sub-item	SCPI
NF Setup...	Frequency	
	Sweep Type	
	Linear Sweep	SENSe:SWEEp:TYPE
	Log Sweep	SENSe:SWEEp:TYPE
	CW Frequency	SENSe:SWEEp:TYPE
	Segment Sweep	SENSe:SWEEp:TYPE
	Sweep Settings	
	Number of Points	SENSe:SWEEp:POINts

IF Bandwidth	SENSe:BWIDth[:RESolution]
Start	SENSe:FREQuency:START
Stop	SENSe:FREQuency:STOP
Center	SENSe:FREQuency:CENTer
Span	SENSe:FREQuency:SPAN
Power	
Power On (All Channels)	OUTPut[:STATe]
DUT Input Port	
Input Port	SENSe:NOISe:PMAP
Power Level	SOURce:POWer[:LEVel][:IMMediate][:AMPLitude]
Source Leveling Mode	SOURce:POWer:ALC[:MODE]
DUT Output Port	
Output Port	SENSe:NOISe:PMAP
Power Level	SOURce:POWer[:LEVel][:IMMediate][:AMPLitude]

Source Leveling Mode	SOURce:POWer:ALC[:MODE]
Path Configuration...	SENSe:PATH:CONFIg:ELEMent[:STATe]
Noise Figure	
Bandwidth/Average	
Noise Bandwidth	SENSe:NOISe:BWIDth[:RESolution]
Average Number	SENSe:NOISe:AVERAge[:COUNT]
Average ON	SENSe:NOISe:AVERAge:STATe
Use Narrowband Compensation	SENSe:NOISe:NARRowband[:STATe]
Noise Receiver	
NA Receiver (Port 2)	SENSe:NOISe:RECeiver
Noise Receiver	SENSe:NOISe:RECeiver
Receiver Gain	SENSe:NOISe:GAIN
Ambient Temperature	SENSe:NOISe:TEMPerature:AMBient

	Impedance States	
	Max Acquired Impedance States	SENSe:NOISe:IMPedance:COUNT
Meas Class...		CALCulate:MEASure:DEFine
Quick Start...	S-Param	CALCulate:MEASure:PARAmeter
	Balanced	CALCulate:MEASure:PARAmeter
	Other	CALCulate:MEASure:PARAmeter
Layout Tab Commands		
Softkey	Sub-item	SCPI
New Trace		DISPlay:WINDow:TRACe[:STATe]
New Channel		None
New Window		DISPlay:WINDow[:STATe]
New Sheet		DISPlay:SHEEt:STATe

Delete	TrN	DISPlay:WINDow:TRACe:DELeTe
	ChN	SYSTem:CHANnels:DELeTe
	WinN	DISPlay:WINDow[:STATe]
Select	TrN	DISPlay:WINDow:TRACe:SELeCt
	ChN	None
	WinN	DISPlay:WINDow:TRACe:SELeCt
Measure...		CALCulate:MEASure:PARAmeter
Meas Class...		CALCulate:MEASure:DEFine

CF_Setup Commands - SA

Only the **Main** and **Layout** Setup commands corresponding to the Spectrum Analyzer measurement class are documented here. All other commands are identical to the Setup commands for the Standard measurement class and can be accessed by clicking [here](#) or by clicking on the softtabs on the graphic below.

Click [here](#) to view links to Setup commands for all Measurement Classes.

Main	Layout	System Setup	Internal Hardware	External Hardware
-------------	---------------	---------------------	--------------------------	--------------------------

Main Tab Commands			
Softkey	Sub-item	SCPI	COM
SA Setup...	SA Tab		
	Sweep Type	SENSe:SA:SOURce:SWEep:TYPE	SourceSweepType SourceSweepType2
	Start	SENSe:FREQuency:START	chan.StartFrequency
	Stop	SENSe:FREQuency:STOP	chan.StopFrequency
	Center	SENSe:FREQuency:CENTer	chan.CenterFrequency
	Span	SENSe:FREQuency:SPAN SENSe:FREQuency:SPAN:FULL	chan.FrequencySpan FrequencySpanFull

Number of Points	SENSe:SWEep:POINTs	chan.NumberOfPoints
Resolution Bandwidth	SENSe:SA:BANDwidth:RESolution:CATalog? SENSe:SA:BANDwidth:[RESolution] SENSe:SA:BANDwidth:[RESolution]:AUTO SENSe:SA:BANDwidth:RESolution MIN SENSe:SA:BANDwidth:RESolution MAX	ResBWList ResolutionBW ResolutionBWMode ResolutionBWMin ResolutionBWMax
Video Bandwidth	SENSe:SA:BANDwidth:VIDeo SENSe:SA:BANDwidth:VIDeo:AUTO SENSe:SA:BANDwidth:VIDeo MIN SENSe:SA:BANDwidth:VIDeo MAX	VideoBW VideoBWMode VideoBWMin VideoBWMax
Detector Type	SENSe:SA:DETEctor:FUNCTion	DetectorFunction
Detector Bypass	SENSe:SA:DETEctor:BYPass:[STATe]	EnableDetectorBypass
Averaging Type	SENSe:SA:BANDwidth:VIDeo:AVER:TYPE	VideoAveragingType
	SENSe:SA:BANDwidth:VIDeo:AVERage:COUNt?	VideoAveragingCount

Receiver Attenuators	SENSe:POWer:ATTenuator	Receiver Attenuator
Source Tab		
Power On (All Channels)	SOURce:POWer:MODE	SourcePortMode
Port Powers Coupled	SOURce:POWer:COUPlE	CouplePorts
State	SOURce:PULSe[:STATe] SOURce:PULSe:EXISts?	None None
Type	SENSe:SA:SOURce:SWEep:TYPE	SourceSweepType SourceSweepType2
Frequency	SENSe:SA:SOURce:FREQuency:START SENSe:SA:SOURce:FREQuency:STOP	SourceStartFrequency SourceStopFrequency
Power	SENSe:SA:SOURce:POWer:START SENSe:SA:SOURce:POWer:STOP	SourceStartPower SourceStopPower

	SENSe:SA:SOURce:POWer[:VALue]	SourcePower
Phase	SOURce:PHASe:FIXed	FixedPhase
IQMod	SOURce:MODulation:FILE SOURce:MODulation:LOAD SOURce:MODulation:SAVE SOURce:MODulation:CORRection[:STATe] (See all SOURce:MODulation commands)	None None None None
RF Sweep Order	SENSe:SA:SOURce:SWEEp:FIRst[:DIMensio n]	SourceSweepFirstDim ension
Path Configurati on...	SENSe:PATH:CONFIg:ELEMent[:STATe]	Element
Power and Attenuator...		
Pulse Setup...		
External Devices...		
Coherence Tab		

Enable multitone	SENSe:SA:COHerence:MULTitone[:STATe]	MultiToneEnable
Tone Spacing	SENSe:SA:COHerence:MULTitone:SPACing	MultiToneSpacing
Waveform Period	SENSe:SA:COHerence:MULTitone:PERiod	MultiTonePeriod
Reference Tone	SENSe:SA:COHerence:MULTitone:REFerence	MultiToneReference
Reject up to harmonic	SENSe:SA:COHerence:MULTitone:HREJect	MultiToneHarmonicRejection
Nyquist protect order	SENSe:SA:COHerence:MULTitone:NYQRject	MultiToneNyquistProtection
Vector averaging	SENSe:SA:COHerence:VECTor:AVERage[:STATe] SENSe:SA:COHerence:VECTor:AVERage:VAlue	VectorAverageEnable VectorAverageValue VectorAverageValueMax

Data Display	SENSe:SA:COHerence:MULTitone:DATA	MultiToneDataDisplay
Multitone settings are valid	SENSe:SA:COHerence:MULTitone:VALid	MultiToneSettingsValid
Compute Phases	SENSe:SA:COHerence:PHASe[:STATe]	PhaseProcessState
Min dBm level for phase display	SENSe:SA:COHerence:PHASe:DISPlay:LEVel	PhaseDisplayMinLevel
Advanced Tab		
RBW Shape	SENSe:SA:BANDwidth:SHAPE	BandwidthShape
Image Reject Type	SENSe:SA:IMAGe:REJect	ImageRejectMethod
Image Reject Strength	SENSe:SA:IMAGe:STRENgth	ImageRejectStrength

RBW/VBW	SENSe:SA:BANDwidth:VIDeo:RATio	ResolutionBWVideoBWRatio
Span/RBW	SENSe:SA:FREQuency:SPAN:BANDwidth[:RESolution]:RATio	SpanResolutionBWRatio
CF Step Size	SENSe:FREQuency:CENTer:STEP:SIZE SENSe:FREQuency:CENTer:STEP:AUTO	CenterFrequencyStepSize CenterFrequencyStepSizeMode
Occupied BW search min	SENSe:SA:BANDwidth:SEARch:OCCupied:MIN	SearchOccupiedBWMinFreq
Enable DC Outputs	SOURce:DC:ENABle	EnableAllOutput
Enable DC Sweep	SENSe:SA:SOURce:DC:SWEep[:STATe]	DCSourceSweepState
Number of DC levels	SENSe:SA:SOURce:DC:SWEep:POINT	DCSourcePointCount
Sweep Order	SENSe:SA:SOURce:DC:SWEep:FIRSt[:DIMe nsion]	DCSourceSweepFirstDimension
	SENSe:SA:FREQuency:TUNE:IMMEdiate	FrequencyAutoTune

DC Sources...		
IF Tab		
ADC Filter	SENSe:SA:ADC:FILTer	ADCFilter
ADC Filter Auto	SENSe:SA:ADC:FILTer:AUTO	EnableADCFilterAuto
DFT Bandwidth Auto	SENSe:SA:DFT:BANDwidth:AUTO	AutoBandwidth
Narrow - DFT Min	SENSe:SA:DFT:BANDwidth:NARRow:MIN	BandwidthNarrowMin
Narrow - DFT Max	SENSe:SA:DFT:BANDwidth:NARRow:MAX	BandwidthNarrowMax
Wide - DFT Min	SENSe:SA:DFT:BANDwidth:WIDE:MIN	BandwidthWideMin
Wide - DFT Max	SENSe:SA:DFT:BANDwidth:WIDE:MAX	BandwidthWideMax
IF Gain	SENSe:PATH:CONFig:ELEMenT[:STATe]	Element

IF Config...	SENSe:PATH:CONFIg:ELEMent[:STATe]	Element
Trigger Tab		
Advanced Trigger Mode	SENSe:SA:TRIGer:LEVel[:STATe]	TriggerADCLevelState
ADC Level	SENSe:SA:TRIGer:LEVel[:STATe] SENSe:SA:TRIGer:LEVel:VALue	TriggerADCLevelState TriggerADCLevelValue
Periodic Counter	SENSe:SA:TRIGer:PERCounter[:STATe] SENSe:SA:TRIGer:PERCounter:VALue	TriggerPeriodicCounterState TriggerPeriodicCounterValue
Trigger...		
Pulse Gen Config...		
Processing Tab		
DFT Type	SENSe:SA:DFT:TYPE	Type

Display image reject traces	SENSe:SA:TRACe:IMAGe[:STATe]	EnableImageRejectTraces
Acq. Time for 1 LO	SENSe:SA:ADC:ACQTime?	AcquisitionTime
Span LOs count	SENSe:SA:LO:COUNt?	LOCount
Span bins count	SENSe:SA:SPAN:BINS:COUNt?	SpanBinsCount
DFT resolution	SENSe:SA:DFT:RESolution?	Resolution
DFT record size	SENSe:SA:DFT:RECOrd:SIZE?	RecordSize
ADC record size	SENSe:SA:ADC:RECOrd:SIZE:VALue?	ForceADCRecordSize
ADC & LO Tab		
Sample Frequency	SENSe:SA:ADC:SAMPle:RATE SENSe:SA:ADC:SAMPle:RATE:AUTO	ADCSampleRate EnableADCSampleRateAuto

Enable FIR for 25 MHz	SENSe:SA:ADC:SAMPlE:DECimation:FIR	ADCEnableFIRFor25Mhz
Dithering	SENSe:SA:ADC:DITHer:[STATe]	EnableADCDither
Force ADC record size	SENSe:SA:ADC:RECOrd:SIZE:VALue? SENSe:SA:ADC:RECOrd:SIZE:FORCe:VALue SENSe:SA:ADC:RECOrd:SIZE:FORCe:[STATe] SENSe:SA:ADC:RECOrd:SIZE:MAX? SENSe:SA:ADC:RECOrd:SIZE:MIN?	ADCRecordSize ForceADCRecordSize EnableForceADCRecordSize ADCRecordSizeMax ADCRecordSizeMin
Stacking	SENSe:SA:ADC:STACking:VALue SENSe:SA:ADC:STACking:STATe	ADCStacking ADCStackingState ADCStackingMax
Multiple Recording	SENSe:SA:ADC:MRECOrd:[STATe]	ADCMultRecState
Chunk size	SENSe:SA:ADC:MRECOrd:SIZE	ADCMultRecSize
Chunk period	SENSe:SA:ADC:MRECOrd:PERiod	ADCMultRecPeriod
Randomize LO	SENSe:SA:LO:RANDom:[STATe]	EnableRandomizedLO

Force LO to frequency	SENSe:SA:LO:FREQ:FORCe SENSe:SA:LO:FREQ:VALue	EnableForce LOToFrequency ForceLOToFrequency
Data Tab		
Data Format	SENSe:SA:DATA:TYPE	DataFormat
Export receivers	SENSe:SA:DATA:RECEivers:LIST SENSe:SA:DATA:RECEivers?	ExportReceiverSetList ExportReceiverList
Don't save data below threshold	SENSe:SA:DATA:THReshold[:STATe] SENSe:SA:DATA:THReshold:VALue	DataLevelThresholdEnabled DataLevelThreshold
DFT bins count	SENSe:SA:DATA:BINs:COUNT?	DataBinCount
Receivers count	SENSe:SA:DATA:RECEivers:COUNT?	ExportReceiverCount
Export to binary file	SENSe:SA:DATA:FILE:BINArY[:STATe]	BinaryFileEnabled
Export to text file	SENSe:SA:DATA:FILE:TEXT[:STATe]	TextFileEnabled

Verbose mode	SENSe:SA:DATA:FILE:TEXT:VERBoSe[:STATe]	FileVerboseEnabled
Erase files each new sweep	SENSe:SA:DATA:FILE:ERASe[:STATe]	FileEraseEachSweep
File name prefix	SENSe:SA:DATA:FILE:PREFfix	FilePrefix
Record size (bytes)	SENSe:SA:DATA:SIZE? SENSe:SA:DATA:SIZE:BIN? SENSe:SA:DATA:SIZE:LOW? SENSe:SA:DATA:SIZE:HIGH?	DataByteSize DataBytesPerBin DataByteSizeLOW DataByteSizeHIGH
Export markers	SENSe:SA:DATA:FILE:TEXT:MARKers[:STATe]	DataExportMarkersEnabled
Export to FIFO buffer	SENSe:SA:DATA:FIFO[:STATe]	FIFOEnabled
Export to shared memory	SENSe:SA:DATA:SHARed[:STATe]	MemShareEnabled
Share name	SENSe:SA:DATA:SHARed:NAME	MemShareName

		SENSe:SA:DATA:START?	DataFirstRFBin
Meas Class...		CALCulate:MEASure:DEFine	CreateCustomMeasure mentEx
Quick Start...	S-Param	CALCulate:MEASure:PARAmeter	CreateSPparameterEx
	Balanced	CALCulate:MEASure:PARAmeter	BalSMeasurement BBalMeasurement SBalMeasurement SSBMeasurement
	Other	CALCulate:MEASure:PARAmeter	CreateSPparameterEx
Layout Tab Commands			
Softkey	Sub-item	SCPI	COM
New Trace		DISPlay:WINDow:TRACe[:STATe]	View
New Channel		None	chans.Add

New Window		DISPlay:WINDow[:STATe]	Add
New Sheet		DISPlay:SHEet:STATe	None
Delete	TrN	DISPlay:WINDow:TRACe:DELeTe	None
	ChN	SYSTem:CHANnels:DELeTe	RemoveChannelNumber
	WinN	DISPlay:WINDow[:STATe]	Add
Select	TrN	DISPlay:WINDow:TRACe:SELeCt	None
	ChN	None	None
	WinN	DISPlay:WINDow:TRACe:SELeCt	None
Measure...		CALCulate:MEASure:PARAmeter	CreateSPparameterEx
Measure Class...		CALCulate:MEASure:DEFine	CreateCustomMeasurementEx

CF_Setup Commands - SMC

Only the **Main** and **Layout** Setup commands corresponding to the Scalar Mixer/Converter + Phase measurement class are documented here. All other commands are identical to the Setup commands for the Standard measurement class and can be accessed by clicking [here](#) or by clicking on the softtabs on the graphic below.

Click [here](#) to view links to Setup commands for all Measurement Classes.



Main Tab Commands		
Softkey	Sub-item	SCPI
SMC Setup...	Sweep	
	Sweep Type	
	Linear Frequency	SENSe:SWEep:TYPE
	CW Time	SENSe:SWEep:TYPE
	Segment Sweep	SENSe:SWEep:TYPE
	Power	SENSe:SWEep:TYPE
	X-Axis Point Spacing	SENSe:SEGMENT:X:SPACing
	Reversed Port 2 Coupler	SENSe:MIXer:REVerse

Number of Points	SENSe:SWEep:POINts
IF Bandwidth	SENSe:BWIDth[:RESolution]
Phase Reference Point	
Enable Phase	SENSe:MIXer:PHASe
First Point	SENSe:MIXer:NORMalize
Middle Point	SENSe:MIXer:NORMalize
Last Point	SENSe:MIXer:NORMalize
Specify	SENSe:MIXer:NORMalize
Power	
Power On (All Channels)	OUTPut[:STATe]
Port Powers Coupled	SOURce:POWER:COUPlE
DUT Input Port	
Input Port	SENSe:MIXer:PMAP
Power Level	SOURce:POWER[:LEVel][:IMMediate][:AMPLitude]

Source Leveling Mode	SOURce:POWer:ALC[:MODE]
DUT Output Port	
Output Port	SENSe:MIXer:PMAP
Power Level	SOURce:POWer[:LEVel][:IMMediate][:AMPLitude]
Source Leveling Mode	SOURce:POWer:ALC[:MODE]
DUT Input Port Power Sweep	
Start Power	SOURce:POWer:PORT:STARt
Stop Power	SOURce:POWer:PORT:STOP
Points	None
Power Step	None
DUT Output Port Power Sweep	
Start Power	SOURce:POWer:PORT:STARt
Stop Power	SOURce:POWer:PORT:STOP
Mixer Frequency	

Input	SENSe:MIXer:CALCulate
LO1	SENSe:MIXer:LO:FREQuency:FIXed
Input > LO	SENSe:MIXer:LO:FREQuency:ILTl
Output	SENSe:MIXer:CALCulate
Mixer Power	
Power On (All Channels)	OUTPut[:STATe]
LO1 Power	SENSe:MIXer:LO:POWer
LO2 Power	SENSe:MIXer:LO:POWer
LO1 Swept Power	
Start	SENSe:MIXer:LO:FREQuency:STARt
Stop	SENSe:MIXer:LO:FREQuency:STOP
Step	None
LO2 Swept Power	
Start	SENSe:MIXer:LO:FREQuency:STARt

	Stop	SENSe:MIXer:LO:FREQuency:STOP
	Step	None
Mixer Setup		
	Converter Stages	SENSe:MIXer:STAGe
	Add Source...	SENSe:ROLE:DEVice
	Save...	SENSe:MIXer:SAVE
	Load...	SENSe:MIXer:LOAD
Meas Class...		CALCulate:MEASure:DEFine
Quick Start...	S-Param	CALCulate:MEASure:PARAmeter
	Balanced	CALCulate:MEASure:PARAmeter
	Other	CALCulate:MEASure:PARAmeter
Layout Tab Commands		
Softkey	Sub-item	SCPI

New Trace		DISPlay:WINDow:TRACe[:STATe]
New Channel		None
New Window		DISPlay:WINDow[:STATe]
New Sheet		DISPlay:SHEet:STATe
Delete	TrN	DISPlay:WINDow:TRACe:DELeTe
	ChN	SYSTem:CHANnels:DELeTe
	WinN	DISPlay:WINDow[:STATe]
Select	TrN	DISPlay:WINDow:TRACe:SELeCt
	ChN	None
	WinN	DISPlay:WINDow:TRACe:SELeCt
Measure...		CALCulate:MEASure:PARAmeter
Meas Class...		CALCulate:MEASure:DEFine

CF_Setup Commands - Standard

Main Tab Commands			
Softkey	Sub-item	SCPI	
Sweep Setup...	Sweep Type		
	Linear Frequency	SENSe:SWEep:TYPE	
	Log Frequency	SENSe:SWEep:TYPE	
	Power Sweep	SENSe:SWEep:TYPE	
	CW Time	SENSe:SWEep:TYPE	
	Segment Sweep	SENSe:SWEep:TYPE	
	Phase Sweep	SENSe:SWEep:TYPE	
	Sweep Properties		
	Start	SENSe:FREQUency:START	

Stop	SENSe:FREQuency:STOP	
Power	SOURce:POWer[:LEVel][:IMMediate][:AMPLitude]	
Points	SENSe:SWEep:POINts	
IF Bandwidth	SENSe:BWIDth[:RESolution]	
Start Power	SOURce:POWer:START	
Stop Power	SOURce:POWer:STOP	
CW Freq	SENSe:FREQuency[:CW]	
Segment Table		
X-axis Point Spacing	SENSe:SEGMENT:X:SPACing	
Allow arbitrary Segments	SENSe:SEGMENT:ARBitrary	
Display Center/Span Freq	SENSe:SEGMENT:FREQuency:CENTer SENSe:SEGMENT:FREQuency:SPAN	

Timing			
	Sweep Time	SENSe:SWEep:TIME	
	Dwell Time	SENSe:SWEep:DWELI	
	Sweep Delay	SENSe:SWEep:DWELI:SDELay	
	Auto Sweep Time	SENSe:SWEep:TIME:AUTO	
	Fast Sweep - Reduce settling time	SENSe:SWEep:SPEed	
	Sweep Mode	SENSe:SWEep:GENeration	
	Sweep Sequence	SENSe:SWEep:GENeration:POINtsweep	
Meas Class...		CALCulate:MEASure:DEFine	
Quick Start...	S-Param	CALCulate:MEASure:PARAmeter	
	Balanced	CALCulate:MEASure:PARAmeter	

	Other	CALCulate:MEASure:PARAmeter	
Layout Tab Commands			
Softkey	Sub-item	SCPI	
New Trace		DISPlay:WINDow:TRACe[:STATe]	
New Channel		None	
New Window		DISPlay:WINDow[:STATe]	
New Sheet		DISPlay:SHEet:STATe	
Delete	TrN	DISPlay:WINDow:TRACe:DELeTe	
	ChN	SYSTem:CHANnels:DELeTe	
	WinN	DISPlay:WINDow[:STATe]	
Select	TrN	DISPlay:WINDow:TRACe:SELeCt	

	ChN	None	
	WinN	DISPlay:WINDow:TRACe:SElect	
Measure ...	S-Parameter	CALCulate:MEASure:PARAmeter	
	Balanced	CALCulate:MEASure:PARAmeter	
	Receivers	CALCulate:MEASure:PARAmeter	
Meas Class...		CALCulate:MEASure:DEFine	
Internal Hardware Tab Commands			
Softkey	Sub-item	SCPI	
PXI Devices	M9379AAmp Setup...	SENS:AMPL:M9379:	None
	M9341 I/O Control Setup...	(Handler Tab) CONT:HAND (DUT Control Tab) SENS:e:DUTControl:M9341 (Analog In Tab) SENS:DC:DC:VOLT:RANG SENS:DC:SAMP:TIME, SENS:DC:SAMP:POIN (Analog Out Tab) SENS:DC:DC:CURR:RANG SOUR:DC:PROT:RES	None

		SOUR:DC:VOLT:CAL:EXEC SOUR:DC:VOLT:CAL:DATE, TIME	
	M9111 SMU Setup...	SOUR:DC	None
External Hardware Tab Commands			
Softkey	Sub-item	SCPI	
External Device..	New	SYSTem:CONFigure:EDEVice:ADD	
	Remove	SYSTem:CONFigure:EDEVice:REMOve	
	Name	SYSTem:CONFigure:EDEVice:ADD	
	Device Type	SYSTem:CONFigure:EDEVice:DTYPE	
	Driver	SYSTem:CONFigure:EDEVice:DRIVER	
	Active - Show in UI	SYSTem:CONFigure:EDEVice:STATe	
	<u>Device Properties...</u>		

DC Meter		
Timeout	None	
Dwell Before Sweep	SYSTem:CONFigure:EDEVice:DC:DSWeep	
Dwell After Point Set	SYSTem:CONFigure:EDEVice:DC:DPOint	
Type	SYSTem:CONFigure:EDEVice:DC:TYPE	
Receiver Correction On	SYSTem:CONFigure:EDEVice:DC:CORRection	
Offset	SYSTem:CONFigure:EDEVice:DC:OFFSet	
Scaling	SYSTem:CONFigure:EDEVice:DC:SCALE	
Edit Commands...		
ID Query	SYSTem:CONFigure:EDEVice:DC:QUERy:ID	

Error Query	SYSTem:CONFigure:EDEVice:DC:QUERy:ERRor	
Enable I/O	SYSTem:CONFigure:EDEVice:DC:COMMand:INIT	
Disable I/O	SYSTem:CONFigure:EDEVice:DC:COMMand:EXIT	
Before Sweep	SYSTem:CONFigure:EDEVice:DC:COMMand:SWEep:BEFore	
After Sweep	SYSTem:CONFigure:EDEVice:DC:COMMand:SWEep:AFTer	
Abort Sweep	SYSTem:CONFigure:EDEVice:DC:COMMand:SWEep:ABORt	
Point Set Commands	SYSTem:CONFigure:EDEVice:DC:COMMand:POINt:SEt	
DC Source		
Timeout	None	
Dwell Before Sweep	SYSTem:CONFigure:EDEVice:DC:DSWeep	

Dwell After Point Set	SYSTem:CONFigure:EDEVice:DC:DPOint	
Type	SYSTem:CONFigure:EDEVice:DC:TYPE	
	SYSTem:CONFigure:EDEVice:DC:LIMit:CURRent	
	SYSTem:CONFigure:EDEVice:DC:LIMit:VOLTage	
Edit Commands...		
ID Query	SYSTem:CONFigure:EDEVice:DC:QUERy:ID	
Error Query	SYSTem:CONFigure:EDEVice:DC:QUERy:ERRor	
Enable I/O	SYSTem:CONFigure:EDEVice:DC:COMMand:INIT	
Disable I/O	SYSTem:CONFigure:EDEVice:DC:COMMand:EXIT	
Read Max Using	SYSTem:CONFigure:EDEVice:DC:MAX:VALue	

Define Max As	SYSTem:CONFIgure:EDEVice:DC:MAX[:STATe] SYSTem:CONFIgure:EDEVice:DC:MAX:VALue	
Read Min Using	SYSTem:CONFIgure:EDEVice:DC:MIN:VALue	
Define Min As	SYSTem:CONFIgure:EDEVice:DC:MIN[:STATe] SYSTem:CONFIgure:EDEVice:DC:MIN:VALue	
Before Sweep	SYSTem:CONFIgure:EDEVice:DC:COMMand:SWEep:BEFore	
After Sweep	SYSTem:CONFIgure:EDEVice:DC:COMMand:SWEep:AFTer	
Abort Sweep	SYSTem:CONFIgure:EDEVice:DC:COMMand:SWEep:ABORt	
Point Set Commands	SYSTem:CONFIgure:EDEVice:DC:COMMand:POINt:SE T	
Power Meter		
Sensor A/B	None	

Tolerance	SOURce:POWer:CORRection:COLLect:AVERAge:NTOLerance	
Max Number of Readings	SOURce:POWer:CORRection:COLLect:AVERAge:COUNT	
Use Loss Table	SOURce:POWer:CORRection:COLLect:TABLE:LOSS SOURce:POWer:CORRection:COLLect:TABLE:SElect	
Edit Table	SOURce:POWer:CORRection:COLLect:TABLE:POINts? SOURce:POWer:CORRection:COLLect:TABLE:FREQuency SOURce:POWer:CORRection:COLLect:TABLE:DATA	
Uncertainty..	SYSTem:CONFIgure:EDEVice:PMAR:UNCertainty:CATalog? SYSTem:CONFIgure:EDEVice:PMAR:UNCertainty:FILE SYSTem:CONFIgure:EDEVice:PMAR:UNCertainty:MODEL SYSTem:CONFIgure:EDEVice:PMAR:UNCertainty:PLEVel? SYSTem:CONFIgure:EDEVice:PMAR:UNCertainty:READ?	
Pulse Generator		
Time out	SYSTem:CONFIgure:EDEVice:TOUT	
Master Mode	SYSTem:CONFIgure:EDEVice:PULSe:MMODE	

Output	SYSTem:CONFigure:EDEVice:PULSe:CHAN	
High	SYSTem:CONFigure:EDEVice:PULSe:HAMP	
Low	SYSTem:CONFigure:EDEVice:PULSe:LAMP	
Source Imp	SYSTem:CONFigure:EDEVice:PULSe:SIMP	
Load Imp	SYSTem:CONFigure:EDEVice:PULSe:LIMP	
SMU		
Setup		
Chan N	SYSTem:CONFigure:EDEVice:ADD	
Trigger Mode	SYSTem:CONFigure:EDEVice:SOURce:TMODe	
SMU Trigger In		
SMU Trigger Out		

Source/Voltage Meter/Current Meter		
SMU Chan	SYSTem:CONFigure:EDEVice:IOENable	
Source type	SYSTem:CONFigure:EDEVice:DC:TYPE	
Timeout	SYSTem:CONFigure:EDEVice:TOUT	
Dwell Before Sweep	SYSTem:CONFigure:EDEVice:DC:DSweep	
Dwell After Point Set	SYSTem:CONFigure:EDEVice:DC:DPOint	
Current Limit	SYSTem:CONFigure:EDEVice:DC:LIMit:CURREnt	
Voltage Limit	SYSTem:CONFigure:EDEVice:DC:LIMit:VOLTage	
Source Correction On	SYSTem:CONFigure:EDEVice:DC:CORRection	

Offset	SYSTem:CONFigure:EDEVice:DC:OFFSet	
Scaling	SYSTem:CONFigure:EDEVice:DC:SCALe	
Receiver Correction On	SYSTem:CONFigure:EDEVice:DC:CORRection	
Offset	SYSTem:CONFigure:EDEVice:DC:OFFSet	
Scaling	SYSTem:CONFigure:EDEVice:DC:SCALe	
Edit Commands - DC Source		
Edit Commands - DC Meter		
Source		
Timeout	SYSTem:CONFigure:EDEVice:TOUT	
Dwell Per Point	SYSTem:CONFigure:EDEVice:SOURce:DPP	

Enable Modulation Control	SYSTem:CONFIgure:EDEVice:SOURce:MODulation:CONTRo I[:STATe]	
Trigger Mode	SYSTem:CONFIgure:EDEVice:SOURce:TMODe	
Trigger Port	SYSTem:CONFIgure:EDEVice:SOURce:TPOrt	
Edit Commands		
Operation complete (*OPC)	None	
Preset	None	
Set CW Frequency	None	
Set CW Sweep Mode	None	
Set Power	None	

	Set Power State	None	
Power Meter Setup...	Interface	None	
	Sensors	SYSTem:CONFIgure:EDEVice:PMAR:SENSor	
	Tolerance	SYSTem:CONFIgure:EDEVice:PMAR:READIng:NTOLerance	
	Max Number of Readings	SYSTem:CONFIgure:EDEVice:PMAR:READIng:COUNT	
	Use Loss Table	SYSTem:CONFIgure:EDEVice:PMAR:TABLE:LOSS:DATA	
	Edit Table	SYSTem:CONFIgure:EDEVice:PMAR:TABLE:LOSS:DATA	

CF_Sweep Commands

The Sweep softkeys vary depending on which measurement class is currently active. Click on a measurement class link below to view the corresponding softkeys.

[Standard](#)

[Gain Compression](#)

[Noise Figure Cold Source](#)

[Scalar Mixer/Converter](#)

CF_Sweep Commands - GCA

Only the **Main**, **Sweep Timing**, and **Source Control** commands corresponding to the Gain Compression measurement classes are documented here. The **Segment Table** commands are identical to the Sweep commands for the Standard measurement class and can be accessed by clicking [here](#) or by clicking on the softtab on the graphic below.

Click [here](#) to view links to Sweep commands for all Measurement Classes.

Main	Sweep Timing	Source Control	Segment Table
Main Tab Commands			
Softkey	Sub-item	SCPI	
Number of Points		SENSe:GCSetup:SWEEp:FREQuency:POINts	
Sweep Type	Linear Frequency	SENSe:SWEEp:TYPE	
	Log Frequency	SENSe:SWEEp:TYPE	
	Power Sweep	SENSe:SWEEp:TYPE	
	CW Time	SENSe:SWEEp:TYPE	
	Segment Sweep	SENSe:SWEEp:TYPE	
	Phase Sweep	SENSe:SWEEp:TYPE	
Start		SENSe:FREQuency:STARt	

Stop		SENSe:FREQuency:STOP
GCA Setup...		
Sweep Timing Tab Commands		
Softkey	Sub-item	SCPI
Sweep Time	Auto	SENSe:SWEEp:TIME:AUTO
	Manual	SENSe:SWEEp:TIME:AUTO
Dwell Time		SENSe:SWEEp:DWELI
Sweep Delay		SENSe:SWEEp:DWELI:SDELay
Fast Sweep	ON	SENSe:SWEEp:SPEEd
	OFF	SENSe:SWEEp:SPEEd
Source Control Tab Commands		
Softkey	Sub-item	SCPI
	Frequency Offset (ON/OFF)	SENSe:FOM[:STATe]

Frequency Offset...	Mode - Coupled and Uncoupled	SENSe:FOM:RANGe:COUPlEd
	Sweep Type	SENSe:FOM:RANGe:SWEEp:TYPE
	Settings	
	Start	SENSe:FOM:RANGe:FREQuency:START
	Stop	SENSe:FOM:RANGe:FREQuency:STOP
	Annotation - Primary, Source, and Receivers	SENSe:FOM:RANGe:NAME?
	X-Axis Point Spacing	SENSe:FOM:RANGe:SEGMENT:SWEEp:POINts
Pulse Setup...	Pulse Measurement	
	Off	SENSe:SWEEp:PULSe:MODE
	Standard Pulse	SENSe:SWEEp:PULSe:MODE
	Pulse Profile	SENSe:SWEEp:PULSe:MODE
	Pulse Timing	
	Pulse Width	SENSe:SWEEp:PULSe:MASTer:WIDth

	Pulse Period	SENSe:SWEep:PULSe:MASTer:PERiod
	Pulse Frequency	SENSe:SWEep:PULSe:MASTer:FREQuency

CF_Sweep Commands - NF

Only the **Main**, **Sweep Timing**, and **Source Control** Sweep commands corresponding to the Noise Figure Cold Source measurement class are documented here. The **Segment Table** commands are identical to the Sweep commands for the Standard measurement class and can be accessed by clicking [here](#) or by clicking on the softtab on the graphic below.

Click [here](#) to view links to Sweep commands for all Measurement Classes.

Main	Sweep Timing	Source Control	Segment Table
Main Tab Commands			
Softkey	Sub-item	SCPI	
Number of Points		SENSe:SWEEp:POINts	
Sweep Type	Linear Frequency	SENSe:SWEEp:TYPE	
	Log Frequency	SENSe:SWEEp:TYPE	
	CW Time	SENSe:SWEEp:TYPE	
	Segment Sweep	SENSe:SWEEp:TYPE	
Start		SENSe:FREQuency:STARt	
Stop		SENSe:FREQuency:STOP	
NF Setup...			

Sweep Timing Tab Commands

Softkey	Sub-item	SCPI
Sweep Time	Auto	SENSe:SWEEp:TIME:AUTO
	Manual	SENSe:SWEEp:TIME:AUTO
Dwell Time		SENSe:SWEEp:DWELI
Sweep Delay		SENSe:SWEEp:DWELI:SDELay
Fast Sweep	ON	SENSe:SWEEp:SPEEd
	OFF	SENSe:SWEEp:SPEEd

Source Control Tab Commands

Softkey	Sub-item	SCPI
Frequency Offset...	Frequency Offset (ON/OFF)	SENSe:FOM[:STATe]
	Mode - Coupled and Un-coupled	SENSe:FOM:RANGe:COUPlEd
	Sweep Type	SENSe:FOM:RANGe:SWEEp:TYPE

	Settings	
	Start	SENSe:FOM:RANGe:FREQuency:START
	Stop	SENSe:FOM:RANGe:FREQuency:STOP
	Annotation - Primary, Source, and Receivers	SENSe:FOM:RANGe:NAME?
	X-Axis Point Spacing	SENSe:FOM:RANGe:SEGMENT:SWEEp:POINTs
Pulse Setup...	Pulse Measurement	
	Off	SENSe:SWEEp:PULSe:MODE
	Standard Pulse	SENSe:SWEEp:PULSe:MODE
	Pulse Profile	SENSe:SWEEp:PULSe:MODE
	Pulse Timing	
	Pulse Width	SENSe:SWEEp:PULSe:MASTer:WIDth
	Pulse Period	SENSe:SWEEp:PULSe:MASTer:PERiod
	Pulse Frequency	SENSe:SWEEp:PULSe:MASTer:FREQuency

CF_Sweep Commands - SA

Click [here](#) to view links to Sweep commands for all Measurement Classes.

Main	Sweep Timing	Source Control	Segment Table	SA Coherence
-------------	--------------	----------------	---------------	--------------

Main Tab Commands

Softkey	Sub-item	SCPI	COM
Number of Points		SENSe:SA:SOURce:SWEep:POINt:COU Nt	SourcePointCount
Start		SENSe:SA:SOURce:FREQuency:STARt	SourceStartFrequenc y
Stop		SENSe:SA:SOURce:FREQuency:STOP	SourceStopFrequenc y
SA Setup...			

Sweep Timing Tab Commands

Softkey	Sub-item	SCPI	COM
Sweep Time	Auto	SENSe:SWEep:TIME:AUTO	chan.SweepTime
	Manual	SENSe:SWEep:TIME:AUTO	chan.SweepTime

Dwell Time		SENSe:SWEEp:DWELI	DwellTime
Sweep Delay		SENSe:SWEEp:DWELI:SDELay	SweepDelay
Fast Sweep	ON	SENSe:SWEEp:SPEEd	SweepSpeedMode
	OFF	SENSe:SWEEp:SPEEd	SweepSpeedMode
Source Control Tab Commands			
Softkey	Sub-item	SCPI	COM
Pulse Setup...	Pulse Measurement		
	Off	SENSe:SWEEp:PULSe:MODE	PulseMeasMode
	Standard Pulse	SENSe:SWEEp:PULSe:MODE	PulseMeasMode
	Pulse Profile	SENSe:SWEEp:PULSe:MODE	PulseMeasMode
	Pulse Timing		
	Pulse Width	SENSe:SWEEp:PULSe:MASTer:WIDth	MasterWidth

Pulse Period	SENSe:SWEEp:PULSe:MASTer:PERiod	MasterPeriod
Pulse Frequency	SENSe:SWEEp:PULSe:MASTer:FREQue ncy	MasterFrequency
Properties		
Autoselect Pulse Detection Method	SENSe:SWEEp:PULSe:DETEctmode[:AU TO]	AutoDetection
Autoselect IF Path Gain and Loss	SENSe:SWEEp:PULSe:IFGain[:AUTO]	None
IF Path...	SENSe:PATH:CONFIg:ELEMent[:STATe]	Element
Optimize Pulse Frequency	SENSe:SWEEp:PULSe:PRF[:AUTO]	AutoOptimizePRF
Autoselect Profile Sweep Time	SENSe:SWEEp:PULSe:MODE	PulseMeasMode
IFBW	SENSe:SWEEp:PULSe:CWTime[:AUTO]	AutoCWSweepTime
Measurement Timing		

Width	SENSe:SWEEp:PULSe:TIMing	AutoPulseTiming
Delay	SENSe:SWEEp:PULSe:TIMing	AutoPulseTiming
Pulse Gen	SENSe:SWEEp:PULSe:MODE	PulseMeasMode
Master Pulse Trigger	SENSe:PATH:CONFIg:ELEMent[:STATe]	Element
Autoselect Width & Delay	SENSe:SWEEp:PULSe:TIMing	AutoPulseTiming
Autoselect Pulse Generators	SENSe:SWEEp:PULSe:DRIVe[:AUTO]	AutoSelectPulseGen
Pulse Generators...		
Width	SENSe:PULSe:WIDTh	Width
Delay	SENSe:PULSe:DELay	Delay
Invert	SENSe:PULSe:INVert	Invert
Enable	SENSe:PULSe[:STATe]	State
Trigger	SENSe:PATH:CONFIg:ELEMent[:STATe]	Element

Frequency	SENSe:SWEEp:PULSe:MASTer:FREQue ncy	MasterFrequency
Period	SENSe:SWEEp:PULSe:MASTer:PERiod	MasterPeriod
Enable Source x Modulator	SENSe:PATH:CONFIg:ELEMent[:STATe]	Element
Modulator Drive	SENSe:PATH:CONFIg:ELEMent[:STATe]	Element
Offset Pulse using Modulator and ADC Delays	SENSe:PULSe:HWDelay[:STATe]	EnableOffsetDelays
Modulator Delay	SENSe:PULSe:HWDelay:MODulator	ModulatorDelay
Fixed ADC Delay	SENSe:PULSe:HWDelay:ADC?	FixedADCDelay
Synchronize ADCs using pulse trigger	SENSe:PATH:CONFIg:ELEMent[:STATe]	Element
Pulse4 Output Indicates ADC Activity	SENSe:PULSe4:OPTion	Pulse4OutAsADCActivi ty

	Pulse Trigger...		
	Trigger Source	SENSe:PATH:CONFig:ELEMent[:STATe]	Element
	Trigger Level/Edge	SENSe:PULSe:TTPe	TriggerInType
	Synchronize ADCs using pulse trigger	SENSe:PULSe[:STATe]	State
	Trigger...		
DC Source...	On/Off	SOURce:DC:STATe	State
Segment Table Tab Commands			
Softkey	Sub-item	SCPI	
Add Segment		SENSe:SEGMENT:ADD	
Insert Segment		None	

Delete Segment		SENSe:SEGMENT:DELeTe	
Delete All Segments		SENSe:SEGMENT:DELeTe:ALL	
Segment Table...	X-Axis Point Spacing	SENSe:SEGMENT:X:SPACing	
	Allow Arbitrary Segments	SENSe:SEGMENT:ARBitrary	
	Display Center/Span Freq	SENSe:SEGMENT:FREQUency:CENTer SENSe:SEGMENT:FREQUency:SPAN	
	Save Table	None	
	Load Table	None	
	Independent Settings Per Segment		
	Vector Averaging	SENSe:SEGMENT:SA:VAVerage SENSe:SEGMENT:SA:VAVerage:CONTRol	

	Video Bandwidth	SENSe:SEGMENT:SA:VIDEObw SENSe:SEGMENT:SA:VIDEObw:CONTROL	
	Reference Tone	SENSe:SEGMENT:SA:MTReference SENSe:SEGMENT:SA:MTReference:CONTROL SENSe:SEGMENT:SA:MTReference:MAX? SENSe:SEGMENT:SA:MTReference:MIN?	
	SA Data Threshold	SENSe:SEGMENT:SA:DTHReshold SENSe:SEGMENT:SA:DTHReshold:CONTROL	
Show Table	Auto	None	
	On	DISPlay:WINDow:TABLE	
SA Coherence Tab Commands			
Softkey	Sub-item	SCPI	
SA Multitone	On/Off	SENSe:SA:IMAGe:COHerence[:STATe]	
Tone Spacing		SENSe:SA:IMAGe:COHerence:SPACing	
Reference Tone		SENSe:SA:IMAGe:COHerence:REFerence	

Data Display	Show All	SENSe:SA:IMAGe:COHerence:DATa	
	Zero the Non-Tones	SENSe:SA:IMAGe:COHerence:DATa	
Detector Bypass	On/Off	SENSe:SA:DETEctor:BYPass:[STATe]	
	Reject up to harmonic	SENSe:SA:IMAGe:COHerence:HREJect	

CF_Sweep Commands - SMC

Click [here](#) to view links to Sweep commands for all Measurement Classes.

Main	Sweep Timing	Source Control
------	--------------	----------------

Main Tab Commands

Softkey	Sub-item	SCPI
Number of Points		SENSe:SWEEp:POINts
Sweep Type		
X-Axis Type		CALCulate:MEASure:MIXer:XAXis
SMC Setup...		

Sweep Timing Tab Commands

Softkey	Sub-item	SCPI
Sweep Time	Auto	SENSe:SWEEp:TIME:AUTO
	Manual	SENSe:SWEEp:TIME:AUTO
Dwell Time		SENSe:SWEEp:DWELI
Sweep Delay		SENSe:SWEEp:DWELI:SDELay

Fast Sweep	ON	SENSe:SWEEp:SPEEd
	OFF	SENSe:SWEEp:SPEEd
Source Control Tab Commands		
Softkey	Sub-item	SCPI
Pulse Setup...	Pulse Measurement	
	Off	SENSe:SWEEp:PULSe:MODE
	Standard Pulse	SENSe:SWEEp:PULSe:MODE
	Pulse Profile	SENSe:SWEEp:PULSe:MODE
	Pulse Timing	
	Pulse Width	SENSe:SWEEp:PULSe:MASTer:WIDth
	Pulse Period	SENSe:SWEEp:PULSe:MASTer:PERiod
	Pulse Frequency	SENSe:SWEEp:PULSe:MASTer:FREQuency
	Embedded LO...	Embedded LO Mode On

Tuning Point	SENSe:MIXer:ELO:NORMAlize:POINT
LO Frequency Delta	SENSe:MIXer:ELO:LO:DELTA
Tuning Settings	
Broadband and precise	SENSe:MIXer:ELO:TUNing:MODE
Precise only	None
Disable tuning	None
Sweep Span	SENSe:MIXer:ELO:TUNing:SPAN
Max Iterations	SENSe:MIXer:ELO:TUNing:ITERations
Tolerance	SENSe:MIXer:ELO:TUNing:TOLerance
Tuning IFBW	SENSe:MIXer:ELO:TUNing:IFBW
Tune every	SENSe:MIXer:ELO:TUNing:INTerval

CF_Sweep Commands - Standard

Click [here](#) to view links to Sweep commands for all Measurement Classes.

Main	Sweep Timing	Source Control	Segment Table
-------------	--------------	----------------	---------------

Main Tab Commands			
Softkey	Sub-item	SCPI	
Number of Points		SENSe:SWEEp:POINts	
Sweep Type	Linear Frequency	SENSe:SWEEp:TYPE	
	Log Frequency	SENSe:SWEEp:TYPE	
	Power Sweep	SENSe:SWEEp:TYPE	
	CW Time	SENSe:SWEEp:TYPE	
	Segment Sweep	SENSe:SWEEp:TYPE	
Start		SENSe:FREQuency:STARt	

Stop		SENSe:FREQuency:STOP	
Sweep Setup.. .			
Sweep Timing Tab Commands			
Softkey	Sub-item	SCPI	
Sweep Time	Auto	SENSe:SWEEp:TIME:AUTO	
	Manual	SENSe:SWEEp:TIME	
Dwell Time		SENSe:SWEEp:DWELI	
Sweep Delay		SENSe:SWEEp:DWELI:SDELay	
Sweep Seque nce	STD	SENSe:SWEEp:GENeration:POINtsweep	
	POINT	SENSe:SWEEp:GENeration:POINtsweep	
	ON	SENSe:SWEEp:SPEEd	

Fast Sweep	OFF	SENSe:SWEEp:SPEEd	
Source Control Tab Commands			
Softkey	Sub-item	SCPI	
Frequency Offset..	Frequency Offset (ON/OFF)	SENSe:FOM[:STATe]	
	Mode - Coupled and Un-coupled	SENSe:FOM:RANGe:COUPlEd	
	Sweep Type	SENSe:FOM:RANGe:SWEEp:TYPE	
	Settings		
	Start	SENSe:FOM:RANGe:FREQuency:START	
	Stop	SENSe:FOM:RANGe:FREQuency:STOP	
	Annotation - Primary, Source, and Receivers	SENSe:FOM:RANGe:NAME?	

	X-Axis Point Spacing	SENSe:FOM:RANGe:SEGMENT:SWEEp:POINTs	
Pulse Setup..	Pulse Measurement		
	Off	SENSe:SWEEp:PULSe:MODE	
	Standard Pulse	SENSe:SWEEp:PULSe:MODE	
	Pulse Profile	SENSe:SWEEp:PULSe:MODE	
	Pulse Timing		
	Pulse Width	SENSe:SWEEp:PULSe:MASTer:WIDth	
	Pulse Period	SENSe:SWEEp:PULSe:MASTer:PERiod	
	Pulse Frequency	SENSe:SWEEp:PULSe:MASTer:FREQuency	
	Properties		
	Autoselect Pulse	SENSe:SWEEp:PULSe:DETEctmode[:AUTO]	

Detection Method		
Narrowband	SENSe:SWEEp:PULSe:WIDeband[:STATe]	
Wideband	SENSe:SWEEp:PULSe:WIDeband[:STATe]	
SW Gating	SENSe:SWEEp:PULSe:SWGate	
Autoselect IF Path Gain and Loss	SENSe:SWEEp:PULSe:IFGain[:AUTO]	
IF Path...	SENSe:PATH:CONFig:ELEMent[:STATe]	
Optimize Pulse Frequency	SENSe:SWEEp:PULSe:PRF[:AUTO]	
Autoselect Profile Sweep Time	SENSe:SWEEp:PULSe:MODE	

IFBW	SENSe:SWEEp:PULSe:CWTime[:AUTO]	
Sweep Time	SENSe:SWEEp:TIME	
Number of Points	SENSe:SWEEp:POINts	
Measurement Timing		
Width	SENSe:SWEEp:PULSe:TIMing	
Delay	SENSe:SWEEp:PULSe:TIMing	
Pulse Gen	SENSe:SWEEp:PULSe:MODE	
Master Pulse Trigger	SENSe:PATH:CONFig:ELEMeNt[:STATe]	
Autoselect Width & Delay	SENSe:SWEEp:PULSe:TIMing	

Autoselect Pulse Generators	SENSe:SWEEp:PULSe:DRIVE[:AUTO]	
Pulse Generators...		
Width	SENSe:PULSe:WIDTh	
Delay	SENSe:PULSe:DELay	
Invert	SENSe:PULSe:INVert	
Enable	SENSe:PULSe[:STATe]	
Trigger	SENSe:PATH:CONFIg:ELEMent[:STATe]	
Frequenc y	SENSe:SWEEp:PULSe:MASTer:FREQuency	
Period	SENSe:SWEEp:PULSe:MASTer:PERiod	
Enable Source x Modulator	SENSe:PATH:CONFIg:ELEMent[:STATe]	

Modulator Drive	SENSe:PATH:CONFig:ELEMe[n]t[:STATe]	
Offset Pulse using Modulator and ADC Delays	SENSe:PULSe:HWDelay[:STATe]	
Modulator Delay	SENSe:PULSe:HWDelay:MODulator	
Fixed ADC Delay	SENSe:PULSe:HWDelay:ADC?	
Synchronize ADCs using pulse trigger	SENSe:PATH:CONFig:ELEMe[n]t[:STATe]	
Pulse4 Output Indicates ADC activity	SENSe:PULSe4:OPTion	

	Pulse Trigger...		
	Trigger Source	SENSe:PATH:CONFig:ELEMent[:STATe]	
	Trigger Level/Edge	SENSe:PULSe:TTYPE	
	Synchronize ADCs using pulse trigger	SENSe:PULSe[:STATe]	
	Trigger...		
Balanced Source ...	Topology		
	BAL	CALCulate:FSIMulator:BALun:TOPology:BALanced	
	BAL-BAL	CALCulate:FSIMulator:BALun:TOPology:BBALanced	
	BAL-SE	CALCulate:FSIMulator:BALun:TOPology:BALSend	

SE-BAL	CALCulate:FSIMulator:BALun:TOPology:SBALanced	
SE-SE-BAL	CALCulate:FSIMulator:BALun:TOPology:SSBalanced	
Stimulus		
Single Ended	CALCulate:FSIMulator:BALun:STIMulus:MODE	
True Mode	CALCulate:FSIMulator:BALun:STIMulus:MODE	
Forward True Mode	CALCulate:FSIMulator:BALun:STIMulus:MODE	
Reverse True Mode	CALCulate:FSIMulator:BALun:STIMulus:MODE	
Source Only Mode	CALCulate:FSIMulator:BALun:STIMulus:MODE	
Balanced Port Offset		
Phase Offset	CALCulate:FSIMulator:BALun:BPORt:OFFSet:PHASe	
Offset as fixture	CALCulate:FSIMulator:BALun:FIXTure:OFFSet:PHASe	

	Power Offset	CALCulate:FSIMulator:BALun:BPORt:OFFSet:POWer	
	Offset as fixture	CALCulate:FSIMulator:BALun:FIXTure:OFFSet:POWer	
Phase Sweep (CW Time Only)			
	Enable Phase Sweep	CALCulate:FSIMulator:BALun:PHASe:SWEep:STATe	
	Sweep Phase On	None	
	Start Phase	CALCulate:FSIMulator:BALun:BPORt:SWEep:PHASe:START	
	Stop Phase	CALCulate:FSIMulator:BALun:BPORt:SWEep:PHASe:STOP	
	Offset as fixture	CALCulate:FSIMulator:BALun:FIXTure:PHASe	
DC Source ...	On/Off	SOURce:DC:STATe	

Shift LO		SENSe:SWEEp:SLOCAl:STATe SENSe:SWEEp:SLOCAl:MAXimum	
LF Extens ion	On/Off	SENSe:SWEEp:LFEXtension:STATe SYSTem:CAPability:HARDware:LFEXtension:EXISts?	LowFrequencyExtension HasLowFrequencyExtension

Segment Table Tab Commands

Softkey	Sub-item	SCPI	
Add Segme nt		SENSe:SEGMENT:ADD	
Insert Segme nt		None	
Delete Segme nt		SENSe:SEGMENT:DELEte	
Delete All Segme nts		SENSe:SEGMENT:DELEte:ALL	

Segment Table...	X-Axis Point Spacing	SENSe:SEGMent:X:SPACing	
	Allow Arbitrary Segments	SENSe:SEGMent:ARBitrary	
	Display Center/Span Freq	SENSe:SEGMent:FREQUency:CENTer SENSe:SEGMent:FREQUency:SPAN	
	Save Table	None	
	Load Table	None	
	Independent Settings Per Segment		
	Power Level	SENSe:SEGMent:POWer[:LEVel]	
	IF Bandwidth	SENSe:SEGMent:BWIDth[:RESolution]	
	IF Bandwidth Per Port	SENSe:SEGMent:BWIDth BANDwidth:PORT[:RESolution]:CONTrol	

	Sweep Time	SENSe:SEGMent:SWEEp:TIME	
	Dwell Time	SENSe:SWEEp:DWELI	
	Delay	SENSe:SEGMent:SWEEp:DELay	
	Sweep Mode	SENSe:SEGMent:SWEEp:GENeration:CONTRol	
	Shift LO	SENSe:SEGMent:SHLO SENSe:SEGMent:SHLO:CONTRol	
	Receiver Atten Per Port	SENSe:SEGMent:POWEr:ATTenuation:RECEiv er:REFerence SENSe:SEGMent:POWEr:ATTenuation:RECEiv er:CONTRol	
Show Table	Auto	None	
	On	DISPlay:WINDow:TABLE	

CF_System Commands

Main Tab Commands		
Softkey	Sub-item	SCPI
Show Taskbar		None
Move App to Back		None
Minimize Application		None
Exit		None
Security...		SYSTem:SECurity[:LEVel]
Control Panel...		None
Manage Files...	List Files	MMEMory:CATalog
	Copy Files	MMEMory:COPI
	Move Files	MMEMory:MOVE

	Delete Files	MMEMory:DELeTe
System Setup Tab Commands		
Softkey	Sub-item	SCPI
Next/Prev Keys	Trace	None
	Channel	None
	Window	None
	Sheet	None
Preferences...	Avg: On Preset set two-point Group Delay Aperture	SYSTem:PREFErences:ITEM:GDELay:TWOPoint
	Cal: Always use Internal trigger during cal	None
	Cal: ECal Extrapolation for IMD	None
	Cal: For Frequency	SENSe:CORRection:PREFErences:CALibration[:FOM]:RANGe

Offset, use Primary frequencies	
Cal: (SCPI only) Auto-generate a User Cal Set	<code>SENSe:CORRection:CSET:CREate</code>
Cal: (SCPI only) Auto-save to current Cal Set	<code>SENSe:CORRection:PREFerece:CSET:SAVE</code>
Display: Selected trace changes width briefly	None
Display: Selected trace is wider	None
Display: Touchscreen On	<code>SYSTem:TOUCHscreen[:STATe]</code>
Ext Device: De-activate on Preset and Recall	<code>SYSTem:PREFereces:ITEM:EDEV:DPOLicy</code>

Limit: Draw failed trace segments in red	SYSTem:PREFerences:ITEM:RTOF
Limit: Draw limit lines in red	SYSTem:PREFerences:ITEM:REDLimits
Limit: Test the nearest measurement point	None
Marker: Coupling controls on/off state of markers	SYSTem:PREFerences:ITEM:MCControl
Marker: On Preset, Coupled Markers is On	SYSTem:PREFerences:ITEM:MCPreSet
Marker: On Preset, Coupling Method is Channel	SYSTem:PREFerences:ITEM:MCMethod
Marker: On Preset, set BW/Notch search	SYSTem:PREFerences:ITEM:MARKer:Bandwidth:SEARCh

reference to Peak	
Marker: Programming treats Mkr 10 as Reference	SYSTem:PREFereNCes:ITEM:REFMarker
Marker: Use single marker for marker search	SYSTem:PREFereNCes:ITEM:MARKer:SINGLE
Meas: Mathematical offset for receiver attenuation	SYSTem:PREFereNCes:ITEM:OFFSet:RCV
Meas: Mathematical offset for source attenuation	SYSTem:PREFereNCes:ITEM:OFFSet:SRC
Memory: Data Math 8510 Mode	None
Memory: Interpolate ON	SYSTem:PREFereNCes:ITEM:MINTerpolate

is default condition	
Power: On Preset turn power on	SYSTem:PREFereNCes:ITEM:PRESet:POWer
Power: Report source unlevelled events as errors	SYSTem:ERRor:REPort:SUNLeveled
Power: Report when receiver is overloaded	SYSTem:PREFereNCes:ITEM:RECEivers:CERRor
Power: Force RF power Off at the end of sweep	SYSTem:PREFereNCes:ITEM:RETRace:POWer
Power: Turn Source Power Off when receiver is overloaded	SYSTem:PREFereNCes:ITEM:RECEivers:OVERload:POWer
Power: Use Start Power during Power Sweep retrace	SYSTem:PREFereNCes:ITEM:PSRTrace

Power-on: On Power-on show Keys toolbar	SYSTem:PREFereNCes:ITEM:Keys
Preset: Confirm preset	SYSTem:PREFereNCes:ITEM:PRESet:CONFirm
Preset: On Preset show Quick Start dialog	SYSTem:PREFereNCes:ITEM:QStart
Recall: Softkey order is most recently used	None
Scale: On Preset Couple Scale to Window	None
Sweep: On Preset set Sweep Mode to Stepped	None
Sweep: Use only ramp sweeps for Auto Sweep Mode	SYSTem:PREFereNCes:ITEM:ASMRamp

System: Enable sound	SYSTem:BEEP:STATe
System: On Power-on show dialog if detect mm testset	None
System: On Power-on show Keys toolbar	SYSTem:PREFerences:ITEM:Keys
System: Use keyboard to navigate softkeys	SYSTem:PREFerences:ITEM:SOFTkeys:NAVigation
Trigger: External Trigger Out is Global	TRIGger:PREFerences:AIGLobal
Data Saves...	MMEMory:STORe:DATA
Power Limit...	SYSTem:POWer:LIMit
Transparency...	None
User Preset...	SYSTem:UPReset

	Page Setup...	Hardcopy
	Disp Colors...	See Display
	Print Colors...	See Display
Sound		SYSTem:BEEPer:VOLume
Remote Interface...	GPIB Address	None
	SICL Enabled	None
	SICL Address	None
	Automatically Enable on Startup	None
	Sockets Enabled	None
	Telnet Enabled	None
	HiSLIP Enabled	None
	HiSLIP Address	None

	Show SCPI Parser Console	None
	Monitor GPIB Bus	None
Print Tab Commands		
Softkey	Sub-item	SCPI
Print...		HCOPY:DPRinter
Print to File...		HCOPY:FILE
Page Setup...		Hardcopy
Print Colors...	Pen	
	Background	DISPlay:COLor:BACKground
	Active Background	DISPlay:COLor:ABACKground
	Grid	DISPlay:COLor:GRAT2
	Active Labels, Grid frame	DISPlay:COLor:GRAT1

Inactive Window Labels	DISPlay:COLor:ILABel
Failed Trace	DISPlay:COLor:LIM1
N Trace: Data and Limits	DISPlay:COLor:TRACe:DATA
N Trace: Memory	DISPlay:COLor:TRACe:MEMory
N Trace: Markers	DISPlay:COLor:TRACe:MARKer
N Trace: Memory Markers	DISPlay:COLor:TRACe:MMARKer
Change Color...	None
Reset Color	DISPlay:COLor:RESet
Color Theme	
Save Theme...	DISPlay:COLor:STORe

	Recall Theme...	DISPlay:COLor:LOAD
	Reset Theme	DISPlay:COLor:RESet
Help Tab Commands		
Softkey	Sub-item	SCPI
NA Help...		None
On The Web...		None
Error Display...	Enable Messages	DISPlay:ANNOtation:MESSAge:STATe
	Status bar Display	DISPlay:ANNOtation[:STATus]
	Confirmation Dialog boxes	None
View Error Log...		None
About NA...		None

Service Tab Commands

Softkey	Sub-item	SCPI
Update Firmware		None
Verification		None
Adjustment Routines...		None
Diagnostics		None
Option Enable		None

CF_Trace Commands

Trace 1 - 7 Tab Commands		
Softkey	Sub-item	SCPI
Trace 1	On/Off	DISPlay:WINDow:TRACe[:STATe]
Trace 2	On/Off	DISPlay:WINDow:TRACe[:STATe]
Trace 3	On/Off	DISPlay:WINDow:TRACe[:STATe]
Trace 4	On/Off	DISPlay:WINDow:TRACe[:STATe]
Trace 5	On/Off	DISPlay:WINDow:TRACe[:STATe]
Trace 6	On/Off	DISPlay:WINDow:TRACe[:STATe]
Trace 7	On/Off	DISPlay:WINDow:TRACe[:STATe]
New Traces...		CALCulate:MEASure:PARAmeter
Trace 8 - 15 Tab Commands		
Softkey	Sub-item	SCPI
Trace 8	On/Off	DISPlay:WINDow:TRACe[:STATe]

Trace 9	On/Off	DISPlay:WINDow:TRACe[:STATe]
Trace 10	On/Off	DISPlay:WINDow:TRACe[:STATe]
Trace 11	On/Off	DISPlay:WINDow:TRACe[:STATe]
Trace 12	On/Off	DISPlay:WINDow:TRACe[:STATe]
Trace 13	On/Off	DISPlay:WINDow:TRACe[:STATe]
Trace 14	On/Off	DISPlay:WINDow:TRACe[:STATe]
Trace 15	On/Off	DISPlay:WINDow:TRACe[:STATe]
Trace Setup Tab Commands		
Softkey	Sub-item	SCPI
Select	TrN	DISPlay:WINDow:TRACe:SElect
Measure...		CALCulate:MEASure:PARAmeter
Trace Title...	Title	DISPlay:WINDow:TRACe:TITLe:DATA
	Enable	DISPlay:WINDow:TRACe:TITLe[:STATe]

Add Trace	New Trace	None
	New Trace + Channel	None
	New Trace + Window	DISPlay:WINDow:TRACe[:STATe]
	New Trace + Channel + Window	None
	New Traces... S-Parameter Balanced Receivers	CALCulate:MEASure:PARAmeter
Delete Trace	TrN	DISPlay:WINDow:TRACe:DELeTe DISPlay:MEASure:DELeTe
Move Trace...		DISPlay:WINDow:TRACe:MOVE
Trace Hold	Off	CALCulate:MEASure:HOLD:TYPE
	Max	CALCulate:MEASure:HOLD:TYPE
	Min	CALCulate:MEASure:HOLD:TYPE
	Restart	CALCulate:MEASure:HOLD:CLEAr

CF_Trigger Commands

Main Tab Commands		
Softkey	Sub-item	SCPI
Hold		SENSe:SWEEp:MODE
Single		SENSe:SWEEp:MODE
Groups		SENSe:SWEEp:MODE
Continuous		SENSe:SWEEp:MODE
Manual Trigger		INITiate[:IMMediate]
Restart		INITiate[:IMMediate]
Trigger Source	Internal	TRIGger[:SEQuence]:SOURce
	Manual	TRIGger[:SEQuence]:SOURce
	External	TRIGger[:SEQuence]:SOURce
Trigger...	Setup	

Trigger Source	TRIGger[:SEQuence]:SOURce
Trigger Scope	TRIIGger[:SEQuence]:SCOPE
Channel Trigger State	
Trigger Mode CHANel SWEep POINT TRACe	SENSe:SWEEp:TRIGger:MODE
Continuous	SENSe:SWEEp:MODE
Groups	SENSe:SWEEp:GROups:COUNT SENSe:SWEEp:MODE
Single	SENSe:SWEEp:MODE
Hold	SENSe:SWEEp:MODE
Meas Trigger	
Global Trigger Delay	TRIGger:DELay
Meas Trig In BNC	TRIGger[:SEQuence]:ROUTE:INPut
Handler I/O Pin 18	TRIGger[:SEQuence]:ROUTE:INPut

Pulse3	TRIGger[:SEQuence]:ROUTE:INPut
Level/Edge	TRIGger[:SEQuence]:TYPE
Accept trigger before armed	CONTRol:SIGNal:TRIGger:ATBA
Meas Trig Ready	TRIGger:STATus:READy?
Handler I/O Pin 21	TRIGger[:SEQuence]:ROUTE:READy
Ready High	TRIGger:READy:POLarity
Ready Low	TRIGger:READy:POLarity
Aux Trig 1	
Enable	TRIGger:CHANnel:AUXiliary:ENABLE
Positive Pulse	TRIGger:CHANnel:AUXiliary:OPOLarity
Negative Pulse	TRIGger:CHANnel:AUXiliary:OPOLarity
Before Acquisition	TRIGger:CHANnel:AUXiliary:POSition
After Acquisition	TRIGger:CHANnel:AUXiliary:POSition
Per Point	TRIGger:CHANnel:AUXiliary:INTerval

Pulse Duration	TRIGger:CHANnel:AUXiliary:DURation
Enable Wait-for-Device Handshake	TRIGger:CHANnel:AUXiliary:HANDshake
Positive Edge	TRIGger:CHANnel:AUXiliary:IPOLarity
Negative Edge	TRIGger:CHANnel:AUXiliary:IPOLarity
Delay	TRIGger:CHANnel:AUXiliary:DELay
Aux Trig 2	
Enable	TRIGger:CHANnel:AUXiliary:ENABLe
Positive Pulse	TRIGger:CHANnel:AUXiliary:OPOLarity
Negative Pulse	TRIGger:CHANnel:AUXiliary:OPOLarity
Before Acquisition	TRIGger:CHANnel:AUXiliary:POSition
After Acquisition	TRIGger:CHANnel:AUXiliary:POSition
Per Point	TRIGger:CHANnel:AUXiliary:INTerval
Pulse Duration	TRIGger:CHANnel:AUXiliary:DURation
Enable Wait-for-Device Handshake	TRIGger:CHANnel:AUXiliary:HANDshake

Positive Edge	TRIGger:CHANnel:AUXiliary:IPOLarity
Negative Edge	TRIGger:CHANnel:AUXiliary:IPOLarity
Delay	TRIGger:CHANnel:AUXiliary:DELay
Pulse Trigger	
Trigger Source	SENSe:PATH:CONFig:ELEMent[:STATe]
High Level	SENSe:PULSe:TTPe
Low Level	SENSe:PULSe:TTPe
Positive Edge	SENSe:PULSe:TPOLarity
Negative Edge	SENSe:PULSe:TPOLarity
Synchronize ADCs using pulse trigger	SENSe:PULSe[:STATe]
ADC trigger delay	SENSe:PULSe:DELay

Command Finder

Data Access Map

dataMapLarge

CFData Topic

Get and Put Data: [Measurement](#) | [Cal](#) | [Power Cal](#) | [Custom](#) | [Power Range](#)
 Other: [GPIB Pass-through](#) | [VISA Pass-through](#) | [Capabilities](#) | [Status/Events](#) | [Rear-panel](#) | [FIFO and FastCW](#) | [Speed up Measurements!](#) | [Ground Loop](#)

Description	SCPI	
Get X-Axis values (variant)	CALCulate:MEASure:X:VALues?	
Get X-Axis values (typed)	None	
Set/get X-axis for trace	CALCulate:MEASure:X:AXIS	
Set/get the X-Axis domain	CALCulate:MEASure:X:AXIS:DOMain	
Get X-Axis values (Meas object)	None	
Get Measurement Data FROM the Analyzer		
Get typed complex data from the specified location. Returned in two arrays.	None	
Get typed NAComplex data from the specified location. Returned in one array.	None	
Get typed data pairs from the	None	

specified location. Returned in two arrays.		
Get typed scalar data from the specified location. Returned in one array.	None	
Get variant data from the specified location in a SPECIFIED FORMAT. Returned in one array.	None	
Get receiver data	CALCulate:MEASure:RDATA?	
Specifies ASCII or REAL type for data transfers	Format:Data	
Get complex or formatted data from the measurement or memory result buffer	CALCulate:MEASure:DATA	
Get the formatted data array of multiple traces	CALCulate:DATA:MFDATA	

of the selected channel.		
Get the corrected data array of multiple traces of the selected channel.	CALCulate:DATA:MSData	
Gets SnP data for the specified ports.	CALCulate:DATA:SNP:PORTs?	
Get ALL SnP data	CALCulate:DATA:SNP:PORTs?	
Put Measurement Data INTO the Analyzer		
Put complex data into the specified location.	None	
Put typed NAComplex data into the specified location.	None	
Put scalar data into the measurement result location.	None	
Put complex Variant data into the specified location.	None	
Put complex or formatted data	CALCulate:MEASure:DATA	

into the measurement or memory result buffer		
Get Calibration Data FROM the Analyzer		
Get complex Error Term data	None	
Get variant Error Term data	SENSe:CORRection:CSET:DATA CSET:ETERm[:DATA]?	
Get variant Error Term data by text filter	CSET:ETERm:CATalog?	
Get complex Standard data	None	
Get variant Standard data	None	
Get variant Standard data by text filter	None	
Put Calibration Data INTO the Analyzer		
Put complex Error Term data	None	
Put variant Error Term data	SENSe:CORRection:CSET:DATA CSET:ETERm[:DATA]	
Put complex Standard data	None	

Put variant Standard data	None	
Power Calibration Data		
Get variant cal data	SOURce:POWer:CORRection:DATA	
Get typed cal data	SOURce:POWer:CORRection:DATA	
Put variant cal data	SOURce:POWer:CORRection:DATA	
Put typed cal data	SOURce:POWer:CORRection:DATA	
Get and Put Custom Measurement Data		
Get and Put Custom data	CALCulate:MEASure:DATA	

Capabilities		
Many queries regarding the capability of a specific PNA		SYSTem:CAPabilities
PXIe module queries		SYSTem:CAPability:HARDware:MODule
Read installed options		*Opt?

Power Range		
Set/get list of discrete frequencies corresponding to powers		SYSTem:CAPability:HARDware:POWer:DISCrete:FREQuency:LIST

Get a single max leveled power value	SYSTem:CAPability:HARDware:POWer:DISCcrete:MAXimum?
Get an array of max leveled power values	SYSTem:CAPability:HARDware:POWer:DISCcrete:MAXimum:LIST?
Get a single minimum leveled power value	SYSTem:CAPability:HARDware:POWer:DISCcrete:MINimum?
Get an array of minimum leveled power values	SYSTem:CAPability:HARDware:POWer:DISCcrete:MINimum:LIST?
Set/get name of the value for the given path element name	SYSTem:CAPability:HARDware:POWer:PATH:CONFig:ELEMent[:STATe]
Get all RF path element names	SYSTem:CAPability:HARDware:POWer:PATH:CONFig:ELEMent:CATalog?
Set/get port number for power data	SYSTem:CAPability:HARDware:POWer:PORT
Set/get type of power range data to be returned	SYSTem:CAPability:HARDware:POWer:TYPE
Get minimum of all max leveled power values	SYSTem:CAPability:HARDware:POWer:RANGe:MAXimum?
Get maximum of all minimum power values	SYSTem:CAPability:HARDware:POWer:RANGe:MINimum?
Set/get lower bound of the frequency range	SYSTem:CAPability:HARDware:POWer:RANGe:FREQUency:START

Set/get upper bound of the frequency range	SYSTem:CAPability:HARDware:POWer:RANGe:FREQuency:STOP
Reset all Power Range properties to default values	SYSTem:CAPability:HARDware:POWer:RESet

Status Commands	
Status Registers	GP-IB/Status
*OPC;*WAI	GP-IB/Common_Commands

Events	
AllowAllEvents Method	None
AllowEventCategory Method	None
AllowEventMessage Method	None
AllowEventSeverity Method	None
DisallowAllEvents Method	None
MessageText Method	None
OnCalEvent	None
OnChannelEvent	None
OnDisplayEvent	None
OnHardwareEvent	None
OnMeasurementEvent	None
OnSCPIEvent	None
OnSystemEvent	None

OnUserEvent	None
SetFailOnOverRange	None

Rear Panel Connector Controls	
Material Handler I/O Connector	GP-IB/Control
Auxiliary IO Connector	GP-IB/Control
External Test Set Connector	GP-IB/Control



FIFO Data Buffer (N5264A Only)	
FIFO ON OFF	SYSTem:FIFO[:STATe]
Read number of data points	SYSTem:FIFO:DATA:COUNt?
Read data	SYSTem:FIFO:DATA?
Read data compact form	None
Clear data	SYSTem:FIFO:DATA:CLEAr
Returns a specific number of bytes to read	SYST:FIFO:DATA:BYTe?
Reads the FIFO buffer data as a Variant of a specified array size (SafeArray) of bytes.	SYST:FIFO:DATA:BYTe:COUNt?
Reads the FIFO buffer data as a Variant of a specified array size (SafeArray) of 32-bit floating point (Float32) numbers.	
Reads the FIFO buffer data as a Variant of a specified array	

size (SafeArray) of 16-bit integers.	
Reads the FIFO buffer data as a Variant of a specified array size (SafeArray) of 32-bit integers.	

Other N5264A Commands	
FastCW	SENSe:SWEEp:TYPE:FACW
Enable Point Averaging	SENSe:AVERAge:MODE
Enable Point Sweep	SENSe:SWEEp:GENeration:POINTsweep
Set Trace Sweep	SENSe:SWEEp:TRIGger:MODE

Ground Loop De-embedding/Embedding commands	
De-embedding	
Sets and returns the Capacitance value	CALCulate:FSIMulator:GLOop:DEEMbed:PARAmeters:C
Sets and returns the Inductance value	CALCulate:FSIMulator:GLOop:DEEMbed:PARAmeters:L
Sets and returns the Resistance value	CALCulate:FSIMulator:GLOop:DEEMbed:PARAmeters:R
Turns ON or OFF De-embedding	CALCulate:FSIMulator:GLOop:DEEMbed:STATe
Specifies the circuit model type	CALCulate:FSIMulator:GLOop:DEEMbed:TYPE
Specifies the filename of the s1p file to load	CALCulate:FSIMulator:GLOop:DEEMbed:USER:FILEname
Embedding	
Sets and returns the Capacitance value	CALCulate:FSIMulator:GLOop:EMBEd:PARAmeters:C

Sets and returns the Inductance value	CALCulate:FSIMulator:GLOop:EMBed:PARAmeters:L
Sets and returns the Resistance value	CALCulate:FSIMulator:GLOop:EMBed:PARAmeters:R
Turns ON or OFF Embedding	CALCulate:FSIMulator:GLOop:EMBed:STATe
Specifies the circuit model type	CALCulate:FSIMulator:GLOop:EMBed:TYPE
Specifies the filename of the s1p file to load	CALCulate:FSIMulator:GLOop:EMBed:USER:FILEname

CFFile Topic

[Save /Recall](#) | [Manage Files](#) | [Manage Folders](#) | [Print](#) | [Read Clock](#)

Description	SCPI
Save / Recall	
Save Instrument States (*.csa, *.cst, *.sta, *.cal) and type of file	MMEMory:STORE
Save Data (except snp)	MMEMory:STORE:DATA
Recall Files	MMEMory:LOAD
Recall softkey list sort preference	SYSTem:PREFErences:ITEM:MRU
Reads SNP data for the specified ports	CALCulate:MEASure:DATA:SNP:PORTs?
Saves SNP data for the specified ports	CALCulate:MEASure:DATA:SNP:PORTs:SAVE
Reads SnP data from the selected measurement	CALCulate:MEASure:DATA:SNP?
Sets format for .SNP files	MMEMory:STORE:TRACe:FORMat:SNP
Set/get formatted measurement data	CALCulate:MEASure:DATA:FDATa
Set/get complex measurement data	CALCulate:MEASure:DATA:SDATa
Set/get formatted memory data	CALCulate:MEASure:DATA:FMEMory
Set/get complex memory data	CALCulate:MEASure:DATA:SMEMory
Manage Files	
List Files	MMEMory:CATalog
Copy Files	MMEMory:COPI
Move Files	MMEMory:MOVE
Delete Files	MMEMory:DELeTe
Manage Folders	
Change	MMEMory:CDIRectory

Delete	MMEMory:RDIRectory
Make	MMEMory:MDIRectory
Read directory location for the specified file type	SYSTem:CONFIgure:DIRectory?
Print	
Print	HCOPy
Saves image of VNA screen to file. (Print to File)	HCOPy:FILE
Return the display image in arbitrary binary block	HCOPy:SDUMp:DATA?
Set format of display image	HCOPy:SDUMp:DATA:FORM

Read Date and Time	SCPI
Read the last modified date of a Cal Set	CSET DATE?
Read the last modified time of a Cal Set	CSET:TIME?
Read the last modified date of a file	MMEM:DATE?
Read the last modified time of a file	MMEM:TIME?

F Simulator Balun

```
CALCulate:FSIMulator:BALun:  
    BPORT  
    | OFFSet  
    | PHASe  
    | POWER  
    | SWEep  
    | PHASe  
    | START  
    | STOP  
    CZConversion  
    | BPort  
    | IMAG  
    | REAL  
    | Z0  
    | R  
    | STATe  
    | LPort  
    | IMAG  
    | REAL  
    | Z0  
    | R  
    DEVice  
    DMCircuit  
    | BPort  
    | PARAmeters  
    | C  
    | G  
    | L  
    | R  
    | TYPE  
    | USER  
    | FILEname  
    | LPort  
    | PARAmeters  
    | C  
    | G  
    | L  
    | R  
    | TYPE  
    | USER
```

```

    | FILEname
    | STATe
DZConversion
    | BPOrt
    | IMAG
    | REAL
    | Z0
    | R
    | STATe
    | LPOrt
    | IMAG
    | REAL
    | Z0
    | R
FIXTure
    | OFFSet
    | PHASe
    | POWer
    | SWEep
    | PHASe
PARAmeter
    | BALanced
    | [:DEFine]
    | BALSended
    | [:DEFine]
    | BBALanced
    | [:DEFine]
| CATalog?
| CUSTom
    | [:DEFine]
    | SBALanced
    | [:DEFine]
    | SSBalanced
    | [:DEFine]
    | [:STATe]
    PHASe
    | SWEep
    | STATe
STIMulus
    | MODE
TOPology
    | BALanced
    | [:PPORTs]
    | BALSended

```

[:PPORts]
BBALanced
[:PPORts]
SBALanced
[:PPORts]
SSBalanced
[:PPORts]

Click on a keyword to view the command details.

see Also

[Example Programs](#)

[Learn about Balanced Measurements](#)

[Learn about iTMSA](#)

[Synchronizing the Analyzer and Controller](#)

[SCPI Command Tree](#)

Notes:

Critical Note: CALCulate commands act on the selected measurement. You can select one measurement for each channel using [Calc:Par:MNUM](#) or [Calc:Par>Select](#). [Learn more.](#)

[CALC:PAR:CAT?](#) alone can NOT be used to return a balanced measurement parameter.

If a balanced measurement transform is being performed, then additional querying of the CALC:FSIM system is required to determine the balanced parameter type.

[See an example.](#)

BPORT versus LPORt commands - For each command in this subsystem that includes a BPORT keyword, there is an LPORt equivalent. The commands are identical except for the way in which the balanced / logical port numbers are specified:

The BPORT commands refer to the Balanced port number. There can only be up to two balanced ports. This method is compatible with the ENA network analyzer.

The LPORt commands refer to the Logical port number. A balanced port can appear as either logical port 1, 2, or 3. These are the references as they appear in the front-panel user interface.

Topology	Logical Port	Balanced Port
Single-Bal	1	N/A
	2	1
Single-Single-Bal	1	N/A
	2	N/A

	3	1
Bal-Bal	1	1
	2	2

[Learn more about logical ports.](#)

CALCulate<cnum>:FSIMulator:BALun:BPORt<pnum>:OFFSet:PHASe <value>

Applicable Models: All

(Read-Write) Sets the phase offset between the two balanced stimulus ports. This command only applies when **CALC:FSIM:BAL:STIM:MOD** is set to a True Mode - Not Single-Ended. Requires Opt S93460A/B. Learn more about iTMSA Power and Phase offset.

[See Critical Note](#)

Parameters

<cnum>	Channel number of the measurement. There must be a selected measurement on that channel. If unspecified, <cnum> is set to 1.
<pnum>	Balanced port number. Choose from ports 1 or 2.
<value>	Phase offset value in degrees.

Examples

```
CALC:FSIM:BAL:BPOR:OFFS:PHAS 10
calculate2:fsimulator:balun:bport:offset:phase 300
See example iTMSA program
```

Query Syntax `CALCulate<cnum>:FSIMulator:BALun:BPORt<pnum>:OFFSet:PHASe?`

Return Type Numeric

Default 0

CALCulate<cnum>:FSIMulator:BALun:BPORt<pnum>:OFFSet:POWER <value>

Applicable Models: All

(Read-Write) Sets the phase offset between the two balanced stimulus ports. This command only applies when **CALC:FSIM:BAL:STIM:MOD** is set to a True Mode - Not Single-Ended. Requires Opt S93460A/B. Learn more about iTMSA Power and Phase offset.

[See Critical Note](#)

Parameters

<num> Channel number of the measurement. There must be a selected measurement on that channel. If unspecified, <num> is set to 1.

<pnum> Balanced port number. Choose from ports 1 or 2.

<value> Power offset value in dB.

Examples

```
CALC:FSIM:BAL:BPOR:OFFS:POW 2
calculate2:fsimulator:balun:bport:offset:power .2
See example iTMSA program
```

Query Syntax `CALCulate<num>:FSIMulator:BALun:BPORt<pnum>:OFFSet:POWER?`

Return Type Numeric

Default 0

CALCulate<num>:FSIMulator:BALun:BPORt<pnum>:SWEep:PHASe:STARt <value>

Applicable Models: All

(Read-Write) Sets the start value for a phase sweep.

Learn more about Phase Sweep.

[See Critical Note](#)

Parameters

<num> Channel number of the measurement. There must be a selected measurement on that channel. If unspecified, <num> is set to 1.

<pnum> Balanced port number. Choose any VNA port. Only one port can have phase sweep.

<value> Phase sweep start value in degrees. Choose a value between 0 and 360.

Examples

```
CALC:FSIM:BAL:BPOR:SWE:PHAS:STAR 10
calculate2:fsimulator:balun:bport:sweep:phase:start 5
```

Query Syntax `CALCulate<num>:FSIMulator:BALun:BPORt<pnum>:SWEep:PHASe:STARt?`

Return Type Numeric

Default 0

CALCulate<cnum>:FSIMulator:BALun:BPORt<pnum>:SWEep:PHASe:STOP <value>

Applicable Models: All

(Read-Write) Sets the stop value for a phase sweep.

Learn more about Phase Sweep.

[See Critical Note](#)

Parameters

<cnum>	Channel number of the measurement. There must be a selected measurement on that channel. If unspecified, <cnum> is set to 1.
<pnum>	Balanced port number. Choose any VNA port. Only one port can have phase sweep.
<value>	Phase sweep stop value in degrees. Choose a value between 0 and 360.

Examples

```
CALC:FSIM:BAL:BPOR:SWE:PHAS:STOP 10  
calculate2:fsimulator:balun:bport:sweep:phase:stop 5
```

Query Syntax

```
CALCulate<cnum>:FSIMulator:BALun:BPORt<pnum>:SWEep:PHASe:STOP?
```

Return Type

Numeric

Default

0

CALCulate<cnum>:FSIMulator:BALun:CZConversion:BPORt<pnum>:IMAG <value>

Applicable Models: All

(Read-Write) Sets the imaginary part of the impedance value for the common port impedance conversion function.

[See Critical Note](#)

Parameters

<cnum>	Channel number of the measurement. There must be a selected measurement on that channel. If unspecified, <cnum> is set to 1.
<pnum>	Balanced port number. Choose from ports 1 or 2.

Note: The numbering of logical ports is different from balanced ports. This command works the same as the ENA network analyzer. If there is only one balanced port, it is Balanced Port 1, regardless of the port mapping assignment. [Learn more.](#)

<value> Imaginary part of the Impedance value in Units. Choose a number between 0 and 1E18.

Examples

```
CALC:FSIM:BAL:CZC:BPOR:IMAG 0  
calculate2:fsimulator:balun:czconversion:bport:imag 300
```

Query Syntax

```
CALCulate<cnum>:FSIMulator:BALun:CZConversion:BPORt<pnum>:IMAG?
```

Return Type

Numeric

Default

0

CALCulate<cnum>:FSIMulator:BALun:CZConversion:BPORt<pnum>:REAL <value>

Applicable Models: All

([Read-Write](#)) Sets the real part of the impedance value for the common port impedance conversion function.

[See Critical Note](#)

Parameters

<cnum>

Channel number of the measurement. There must be a selected measurement on that channel. If unspecified, <cnum> is set to 1.

<pnum>

Balanced port number. Choose from ports 1 or 2.

Note: The numbering of logical ports is different from balanced ports. This command works the same as the ENA network analyzer. If there is only one balanced port, it is Balanced Port 1, regardless of the port mapping assignment. [Learn more.](#)

<value>

Real part of the Impedance value in Units. Choose a number between 0 and 1E18.

Examples

```
CALC:FSIM:BAL:CZC:BPOR:REAL 25  
calculate2:fsimulator:balun:czconversion:bport:real 50
```

Query Syntax

```
CALCulate<cnum>:FSIMulator:BALun:CZConversion:BPORt<pnum>:REAL?
```

Return Type

Numeric

Default

See [Common Mode Port Z Conversion Default](#)

CALCulate<cnum>:FSIMulator:BALun:CZConversion:BPORt<pnum>:Z0[:R] <value>

Applicable Models: All

(Read-Write) Sets the real part of the impedance value for the common port impedance conversion function. Set either this single value or set the **real** and **imaginary** parts separately. The imaginary part is set to 0.0 using this command.

[See Critical Note](#)

Parameters

<cnum> Channel number of the measurement. There must be a selected measurement on that channel. If unspecified, <cnum> is set to 1.

<pnum> Balanced port number. Choose from ports 1 or 2.

Note: The numbering of logical ports is different from balanced ports. This command works the same as the ENA network analyzer. If there is only one balanced port, it is Balanced Port 1, regardless of the port mapping assignment. [Learn more.](#)

<value> Impedance value in ohms. Choose a number between 0 to 1E7.

Examples

```
CALC:FSIM:BAL:CZC:BPOR:Z0 50
calculate2:fsimulator:balun:czconversion:bport:z0:r 75
```

Query Syntax `CALCulate<cnum>:FSIMulator:BALun:CZConversion:BPORt<pnum>:Z0[:R]?`

Return Type Numeric

Default See [Common Mode Port Z Conversion Default](#)

CALCulate<cnum>:FSIMulator:BALun:CZConversion:STATe <bool>

Applicable Models: All

(Read-Write) Sets the common port impedance conversion function ON/OFF. Must also set the fixture simulator function to ON using **CALC:FSIM:STAT.**

[See Critical Note](#)

Parameters

<cnum> Channel number of the measurement. There must be a selected measurement on that channel. If unspecified, <cnum> is set to 1.

<bool> State of common port impedance conversion function. Choose from

OFF (or 0) Conversion OFF

ON (or 1) Conversion ON

Examples	<pre>CALC:FSIM:BAL:CZC:STAT 1 calculate2:fsimulator:balun:czconversion:state off</pre>
Query Syntax	<code>CALCulate<cnum>:FSIMulator:BALun:CZConversion:STATe?</code>
Return Type	Boolean
Default	Off

CALCulate<cnum>:FSIMulator:BALun:CZConversion:LPORT<pnum>:IMAG <value>

Applicable Models: All

(Read-Write) Sets the imaginary part of the impedance value for the common port impedance conversion function.

See [Critical Note](#)

Parameters

<cnum> Channel number of the measurement. There must be a selected measurement on that channel. If unspecified, <cnum> is set to 1.

<pnum> Logical port number. Choose from logical ports 1, 2, or 3.

Note: See [Balanced port versus Logical port](#).

<value> Imaginary part of the Impedance value in Units. Choose a number between 0 and 1E18.

Examples	<pre>CALC:FSIM:BAL:CZC:LPOR:IMAG 0 calculate2:fsimulator:balun:czconversion:lport:imag 300</pre>
Query Syntax	<code>CALCulate<cnum>:FSIMulator:BALun:CZConversion:LPORT<pnum>:IMAG?</code>
Return Type	Numeric
Default	0

CALCulate<cnum>:FSIMulator:BALun:CZConversion:LPORT<pnum>:REAL <value>

Applicable Models: All

(Read-Write) Sets the real part of the impedance value for the common port impedance conversion function.

See Critical Note

Parameters

<num> Channel number of the measurement. There must be a selected measurement on that channel. If unspecified, <num> is set to 1.

<pnum> Logical port number. Choose from logical ports 1, 2, or 3.

Note: See [Balanced port versus Logical port](#).

<value> Real part of the Impedance value in Units. Choose a number between 0 and 1E18.

Examples

```
CALC:FSIM:BAL:CZC:LPOR:REAL 25
calculate2:fsimulator:balun:czconversion:lport:real 50
```

Query Syntax

```
CALCulate<num>:FSIMulator:BALun:CZConversion:LPORt<pnum>:REAL?
```

Return Type

Numeric

Default

See [Common Mode Port Z Conversion Default](#)

CALCulate<num>:FSIMulator:BALun:CZConversion:LPORt<pnum>:Z0[:R] <value>

Applicable Models: All

(Read-Write) Sets the real part of the impedance value for the common port impedance conversion function. Set either this single value or set the **real** and **imaginary** parts separately. The imaginary part is set to 0.0 using this command.

See Critical Note

Parameters

<num> Channel number of the measurement. There must be a selected measurement on that channel. If unspecified, <num> is set to 1.

<pnum> Logical port number. Choose from logical ports 1, 2, or 3.

Note: See [Balanced port versus Logical port](#).

<value> Impedance value in ohms. Choose a number between 0 to 1E7.

Examples

```
CALC:FSIM:BAL:CZC:LPOR:Z0 50
calculate2:fsimulator:balun:czconversion:lport:z0:r 75
```

Query Syntax **CALCulate<cnm>:FSIMulator:BALun:CZConversion:LPORT<pnum>:Z0[:R]?**

Return Type Numeric

Default See [Common Mode Port Z Conversion Default](#)

CALCulate<cnm>:FSIMulator:BALun:DEvice <char>

Applicable Models: All

(Read-Write) Selects the device type for the balanced measurement. To map the device type logical ports to the VNA physical ports, use the **CALCulate:DTOPology** , **CALC:FSIM:BAL:TOP:XXXXX** command.

[See Critical Note](#)

Parameters

<cnm> Channel number of the measurement. There must be a selected measurement on that channel. If unspecified, <cnm> is set to 1.

<char> **BAL - 1 port balanced device (2 ports)**
BBALanced - Balanced - Balanced device (4 ports).
BALSended - Balanced - Single-ended device (3 ports).
SBALanced - Single-ended - Balanced device (3 ports).
SSBALanced - Single-ended - Single-ended - Balanced device (4 ports).
CUST - Define custom device type for systems with greater than 4 ports.

Examples

```
CALC:FSIM:BAL:DEV SSB  
calculate2:fsimulator:balun:device bbal
```

Query Syntax **CALCulate<cnm>:FSIMulator:BALun:DEvice?**

Return Type Character

Default SBALanced

CALCulate<cnm>:FSIMulator:BALun:DMCircuit:BPORt<pnum>:PARAmeters:C<value>

Applicable Models: All

(Read-Write) Sets the Capacitance value of the differential matching circuit.

[See Critical Note](#)

Parameters

<num>	Channel number of the measurement. There must be a selected measurement on that channel. If unspecified, <num> is set to 1.
<pnum>	Balanced port number. Choose from ports 1 or 2. <div style="background-color: #e0f2f7; padding: 5px;"> <p>Note: The numbering of logical ports is different from balanced ports. This command works the same as the ENA network analyzer. If there is only one balanced port, it is Balanced Port 1, regardless of the port mapping assignment. Learn more.</p> </div>
<value>	Capacitance value in farads. Choose a number between -1E18 to 1E18
Examples	<pre>CALC:FSIM:BAL:DMC:BPOR:PARAMeters:C 10E-6 calculate2:fsimulator:balun:dmcircuit:bport:parameters:c 1E-9</pre>
Query Syntax	<code>CALCulate<num>:FSIMulator:BALun:DMCircuit:BPORt<pnum>:PARAMeters:C?</code>
Return Type	Numeric
Default	0

**CALCulate<num>:FSIMulator:BALun:DMCircuit:BPORt<pnum>:PARAMeters:G
<value>**

Applicable Models: All

(Read-Write) Sets the Conductance value of the differential matching circuit.

[See Critical Note](#)

Parameters

<num>	Channel number of the measurement. There must be a selected measurement on that channel. If unspecified, <num> is set to 1.
<pnum>	Balanced port number. Choose from ports 1 or 2. <div style="background-color: #e0f2f7; padding: 5px;"> <p>Note: The numbering of logical ports is different from balanced ports. This command works the same as the ENA network analyzer. If there is only one balanced port, it is Balanced Port 1, regardless of the port mapping assignment. Learn more.</p> </div>
<value>	Conductance value in siemens. Choose a number between -1E18 to 1E18.

Examples	<pre>CALC:FSIM:BAL:DMC:BPOR:PARAMeters:G 1E3 calculate2:fsimulator:balun:dmcircuit:bport:parameters:g 1E-3</pre>
-----------------	--

Query Syntax **CALCulate<num>:FSIMulator:BALun:DMCircuit:BPORt<pnum>:PARAmeters:G?**

Return Type Numeric

Default 0

CALCulate<num>:FSIMulator:BALun:DMCircuit:BPORt<pnum>:PARAmeters:L <value>

Applicable Models: All

(Read-Write) Sets the Inductance value of the differential matching circuit.

[See Critical Note](#)

Parameters

<num> Channel number of the measurement. There must be a selected measurement on that channel. If unspecified, <num> is set to 1.

<pnum> Balanced port number. Choose from ports 1 or 2.

Note: The numbering of logical ports is different from balanced ports. This command works the same as the ENA network analyzer. If there is only one balanced port, it is Balanced Port 1, regardless of the port mapping assignment. [Learn more.](#)

<value> Inductance value in henries. Choose a number between -1E18 to 1E18.

Examples

```
CALC:FSIM:BAL:DMC:BPOR:PARAmeters:L 3E-3  
calculate2:fsimulator:balun:dmcircuit:bport:parameters:1E-  
10
```

Query Syntax **CALCulate<num>:FSIMulator:BALun:DMCircuit:BPORt<pnum>:PARAmeters:L?**

Return Type Numeric

Default 0

CALCulate<num>:FSIMulator:BALun:DMCircuit:BPORt<pnum>:PARAmeters:R <value>

Applicable Models: All

(Read-Write) Sets the Resistance value of the differential matching circuit.

[See Critical Note](#)

Parameters

<num> Channel number of the measurement. There must be a selected measurement on that channel. If unspecified, <num> is set to 1.

<pnum> Balanced port number. Choose from ports 1 or 2.

Note: The numbering of logical ports is different from balanced ports. This command works the same as the ENA network analyzer. If there is only one balanced port, it is Balanced Port 1, regardless of the port mapping assignment. [Learn more.](#)

<value> Resistance value in ohms. Choose a number between -1E18 to 1E18.

Examples

```
CALC:FSIM:BAL:DMC:BPOR:PARAMeters:R 100
calculate2:fsimulator:balun:dmcircuit:bport:parameters:r
4E3
```

Query Syntax `CALCulate<num>:FSIMulator:BALun:DMCircuit:BPORt<pnum>:PARAMeters:R?`

Return Type Numeric

Default 0

CALCulate<num>:FSIMulator:BALun:DMCircuit:BPORt<pnum>[:TYPE] <char>

Applicable Models: All

(Read-Write) Sets the differential matching circuit type. To select a user-defined circuit, specify IN ADVANCE the 2-port touchstone filename with `CALC:FSIM:BAL:DMC:BPOR:USER:FILEname`. If you do not specify the appropriate file and you select USER, an error occurs and NONE is automatically selected.

[See Critical Note](#)

Parameters

<num> Channel number of the measurement. There must be a selected measurement on that channel. If unspecified, <num> is set to 1.

<pnum> Balanced port number. Choose from ports 1 or 2.

Note: The numbering of logical ports is different from balanced ports. This command works the same as the ENA network analyzer. If there is only one balanced port, it is Balanced Port 1, regardless of the port mapping assignment. [Learn more.](#)

<char> Circuit type. Choose from:

NONE - Specifies no-circuit.

PLPC - Specifies the circuit that consists of shunt L and shunt C.

USER - Specifies the user-defined circuit.

Examples	<pre>CALC:FSIM:BAL:DMC:BPOR2 PLPC calculate2:fsimulator:balun:dmcircuit:bport1:type none</pre>
Query Syntax	<pre>CALCulate<cnum>:FSIMulator:BALun:DMCircuit:BPORt<pnum>:TYPE?</pre>
Return Type	Character
Default	PLPC

CALCulate<cnum>:FSIMulator:BALun:DMCircuit:BPORt<pnum>:USER:FILEname <string>

Applicable Models: All

(Read-Write) Specifies the 2-port touchstone file in which the information on the user-defined differential matching circuit is saved. Following this command, send **CALC:FSIM:BAL:DMC:BPOR2 USER**. If the specified file does not exist, an error occurs when you set the type of differential matching circuit to USER.

[See Critical Note](#)

Parameters

<cnum> Channel number of the measurement. There must be a selected measurement on that channel. If unspecified, <cnum> is set to 1.

<pnum> Balanced port number. Choose from ports 1 or 2.

Note: The numbering of logical ports is different from balanced ports. This command works the same as the ENA network analyzer. If there is only one balanced port, it is Balanced Port 1, regardless of the port mapping assignment. [Learn more.](#)

<string> File name and extension (.s2P) of the differential matching circuit. Files are stored in the default folder "C:/Program Files/Keysight/Network Analyzer/Documents ". To recall from a different folder, specify the full path name.

Examples	<pre>CALC:FSIM:BAL:DMC:BPOR:USER:FIL 'myfile.s2p' calculate2:fsimulator:balun:dmcircuit:bport:user:filename "C:/Program Files/Keysight/Network Analyzer/Documents/ myFile.s2P"</pre>
Query Syntax	<pre>CALCulate<cnum>:FSIMulator:BALun:DMCircuit:BPORt<pnum>:USER:FILEname?</pre>

Return Type String
Default Not Applicable

CALCulate<cnum>:FSIMulator:BALun:DMCircuit:STATe <bool>

Applicable Models: All

(Read-Write) Sets the differential matching circuit embedding function ON/OFF. Must also set the fixture simulator function to ON using **CALC:FSIM:STAT**.

See Critical Note

Parameters

<cnum> Channel number of the measurement. There must be a selected measurement on that channel. If unspecified, <cnum> is set to 1.

<bool> State of differential matching circuit embedding function. Choose from
OFF (or 0) Matching circuit OFF
ON (or 1) Matching circuit ON

Examples

```
CALC:FSIM:BAL:DMC:STAT 1  
calculate2:fsimulator:balun:dmcircuit:state off
```

Query Syntax **CALCulate<cnum>:FSIMulator:BALun:DMCircuit:STATe?**

Return Type Boolean

Default Off

CALCulate<cnum>:FSIMulator:BALun:DMCircuit:LPORT<pnum>:PARAMeters:C<value>

Applicable Models: All

(Read-Write) Sets the Capacitance value of the differential matching circuit.

See Critical Note

Parameters

<cnum> Channel number of the measurement. There must be a selected measurement on that channel. If unspecified, <cnum> is set to 1.

<pnum> Logical port number. Choose from logical ports 1, 2, or 3.

Note: See **Balanced port versus Logical port**.

<value> Capacitance value in farads. Choose a number between -1E18 to 1E18

Examples

```
CALC:FSIM:BAL:DMC:LPOR:PARAMeters:C 10E-6  
calculate2:fsimulator:balun:dmcircuit:lport:parameters:c  
1E-9
```

Query Syntax

```
CALCulate<cnum>:FSIMulator:BALun:DMCircuit:LPORt<pnum>:PARAmeters:C?
```

Return Type

Numeric

Default

0

CALCulate<cnum>:FSIMulator:BALun:DMCircuit:LPORt<pnum>:PARAmeters:G <value>

Applicable Models: All

(**Read-Write**) Sets the Conductance value of the differential matching circuit.

[See Critical Note](#)

Parameters

<cnum>

Channel number of the measurement. There must be a selected measurement on that channel. If unspecified, <cnum> is set to 1.

<pnum>

Logical port number. Choose from logical ports 1, 2, or 3.

Note: See [Balanced port versus Logical port](#).

<value>

Conductance value in siemens. Choose a number between -1E18 to 1E18.

Examples

```
CALC:FSIM:BAL:DMC:LPOR:PARAMeters:G 1E3  
calculate2:fsimulator:balun:dmcircuit:lport:parameters:g  
1E-3
```

Query Syntax

```
CALCulate<cnum>:FSIMulator:BALun:DMCircuit:LPORt<pnum>:PARAmeters:G?
```

Return Type

Numeric

Default

0

CALCulate<cnum>:FSIMulator:BALun:DMCircuit:LPORt<pnum>:PARAmeters:L <value>

Applicable Models: All

(Read-Write) Sets the Inductance value of the differential matching circuit.

See Critical Note

Parameters

<num> Channel number of the measurement. There must be a selected measurement on that channel. If unspecified, <num> is set to 1.

<pnum> Logical port number. Choose from logical ports 1, 2, or 3.

Note: See [Balanced port versus Logical port](#).

<value> Inductance value in henries. Choose a number between -1E18 to 1E18.

Examples

```
CALC:FSIM:BAL:DMC:LPOR:PARAMeters:L 3E-3  
calculate2:fsimulator:balun:dmcircuit:lport:parameters:1E-10
```

Query Syntax `CALCulate<num>:FSIMulator:BALun:DMCircuit:LPORt<pnum>:PARAMeters:L?`

Return Type Numeric

Default 0

CALCulate<num>:FSIMulator:BALun:DMCircuit:LPORt<pnum>:PARAMeters:R <value>

Applicable Models: All

(Read-Write) Sets the Resistance value of the differential matching circuit.

See Critical Note

Parameters

<num> Channel number of the measurement. There must be a selected measurement on that channel. If unspecified, <num> is set to 1.

<pnum> Logical port number. Choose from logical ports 1, 2, or 3.

Note: See [Balanced port versus Logical port](#).

<value> Resistance value in ohms. Choose a number between -1E18 to 1E18.

Examples

```
CALC:FSIM:BAL:DMC:LPOR:PARAMeters:R 100  
calculate2:fsimulator:balun:dmcircuit:lport:parameters:r  
4E3
```

Query Syntax **CALCulate<num>:FSIMulator:BALun:DMCircuit:LPORT<pnum>:PARAMeters:R?**

Return Type Numeric

Default 0

CALCulate<num>:FSIMulator:BALun:DMCircuit:LPORT<pnum>[:TYPE] <char>

Applicable Models: All

(Read-Write) Sets the differential matching circuit type. To select a user-defined circuit, specify IN ADVANCE the 2-port touchstone filename with **CALC:FSIM:BAL:DMC:LPOR:USER:FILENAME**. If you do not specify the appropriate file and you select USER, an error occurs and NONE is automatically selected.

[See Critical Note](#)

Parameters

<num> Channel number of the measurement. There must be a selected measurement on that channel. If unspecified, <num> is set to 1.

<pnum> Logical port number. Choose from logical ports 1, 2, or 3.

Note: See [Balanced port versus Logical port](#).

<char> Circuit type. Choose from:
NONE - Specifies no-circuit.
PLPC - Specifies the circuit that consists of shunt L and shunt C.
USER - Specifies the user-defined circuit.

Examples

```
CALC:FSIM:BAL:DMC:LPOR2 PLPC  
calculate2:fsimulator:balun:dmcircuit:lport1:type none
```

Query Syntax **CALCulate<num>:FSIMulator:BALun:DMCircuit:LPORT<pnum>:TYPE?**

Return Type Character

Default PLPC

CALCulate<num>:FSIMulator:BALun:DMCircuit:LPORT<pnum>:USER:FILENAME <string>

Applicable Models: All

(Read-Write) Specifies the 2-port touchstone file in which the information on the user-defined differential matching circuit is saved. Following this command, send **CALC:FSIM:BAL:DMC:BPOR2 USER**. If the specified file does not exist, an error occurs when you set the type of differential matching circuit to USER.

[See Critical Note](#)

Parameters

<num> Channel number of the measurement. There must be a selected measurement on that channel. If unspecified, <num> is set to 1.

<pnum> Logical port number. Choose from logical ports 1, 2, or 3.

Note: See [Balanced port versus Logical port](#).

<string> File name and extension (.s2P) of the differential matching circuit. Files are stored in the default folder "C:/Program Files/Keysight/Network Analyzer/Documents ". To recall from a different folder, specify the full path name.

Examples

```
CALC:FSIM:BAL:DMC:LPOR:USER:FILE 'myfile.s2p'  
calculate2:fsmulator:balun:dmcircuit:lport:user:filename  
"C:/Program Files/Keysight/Network Analyzer/Documents/  
myFile.s2P"
```

Query Syntax **CALCulate<num>:FSIMulator:BALun:DMCircuit:LPORt<pnum>:USER:FILEname?**

Return Type String

Default Not Applicable

CALCulate<num>:FSIMulator:BALun:DZConversion:BPORt<pnum>:IMAG <value>

Applicable Models: All

(Read-Write) Sets the imaginary part of the impedance value for the differential port impedance conversion function.

[See Critical Note](#)

Parameters

<num> Channel number of the measurement. There must be a selected measurement on that channel. If unspecified, <num> is set to 1.

<pnum> Balanced port number. Choose from ports 1 or 2.

Note: The numbering of logical ports is different from balanced ports. This command works the same as the ENA network analyzer. If there is only one balanced port, it is Balanced Port 1, regardless of the port mapping assignment. [Learn more.](#)

<value> Imaginary part of the Impedance value in Units. Choose a number between 0 and 1E18.

Examples

```
CALC:FSIM:BAL:DZC:BPOR:IMAG 0  
calculate2:fsimulator:balun:dczconversion:bport:imag 300
```

Query Syntax

```
CALCulate<cnum>:FSIMulator:BALun:DZConversion:BPORt<pnum>:IMAG?
```

Return Type

Numeric

Default

0

CALCulate<cnum>:FSIMulator:BALun:DZConversion:BPORt<pnum>:REAL <value>

Applicable Models: All

(Read-Write) Sets the real part of the impedance value for the differential port impedance conversion function.

[See Critical Note](#)

Parameters

<cnum>

Channel number of the measurement. There must be a selected measurement on that channel. If unspecified, <cnum> is set to 1.

<pnum>

Balanced port number. Choose from ports 1 or 2.

Note: The numbering of logical ports is different from balanced ports. This command works the same as the ENA network analyzer. If there is only one balanced port, it is Balanced Port 1, regardless of the port mapping assignment. [Learn more.](#)

<value>

Real part of the Impedance value in Units. Choose a number between 0 and 1E18

Examples

```
CALC:FSIM:BAL:DZC:BPOR:REAL 50  
calculate2:fsimulator:balun:dczconversion:bport:real 75
```

Query Syntax

```
CALCulate<cnum>:FSIMulator:BALun:DZConversion:BPORt<pnum>:REAL?
```

Return Type

Numeric

Default

See [Differential Port Z Conversion Default](#)

CALCulate<cnum>:FSIMulator:BALun:DZConversion:BPORt<pnum>:Z0[:R] <value>

Applicable Models: All

(Read-Write) Sets the impedance value for the differential port impedance conversion function. Set either this single value or set the **real** and **imaginary** parts separately. The imaginary part is set to 0.0 using this command.

[See Critical Note](#)

Parameters

<cnum> Channel number of the measurement. There must be a selected measurement on that channel. If unspecified, <cnum> is set to 1.

<pnum> Balanced port number. Choose from ports 1 or 2.

Note: The numbering of logical ports is different from balanced ports. This command works the same as the ENA network analyzer. If there is only one balanced port, it is Balanced Port 1, regardless of the port mapping assignment. [Learn more.](#)

<value> Impedance value in ohms. Choose a number between 0 to 1E7

Examples

```
CALC:FSIM:BAL:DZC:BPOR:Z0 50
calculate2:fsimulator:balun:dzconversion:bport:z0:r 75
```

Query Syntax `CALCulate<cnum>:FSIMulator:BALun:DZConversion:BPORt<pnum>:Z0[:R]?`

Return Type Numeric

Default See [Differential Port Z Conversion Default](#)

CALCulate<cnum>:FSIMulator:BALun:DZConversion:STATe <bool>

Applicable Models: All

(Read-Write) Sets the differential port impedance conversion function ON/OFF. Must also set the fixture simulator function to ON using **CALC:FSIM:STAT.**

[See Critical Note](#)

Parameters

<cnum> Channel number of the measurement. There must be a selected measurement on that channel. If unspecified, <cnum> is set to 1.

<bool> **State of the differential port impedance conversion function. Choose from**

OFF (or 0) Differential port impedance conversion OFF
ON (or 1) Differential port impedance conversion ON

Examples

```
CALC:FSIM:BAL:DZC:STAT 1  
calculate2:fsimulator:balun:dzconversion:state off
```

Query Syntax

CALCulate<cnum>:FSIMulator:BALun:DZConversion:STATe?

Return Type

Boolean

Default

Off

CALCulate<cnum>:FSIMulator:BALun:DZConversion:LPORT<pnum>:IMAG <value>

Applicable Models: All

(Read-Write) Sets the imaginary part of the impedance value for the differential port impedance conversion function.

See [Critical Note](#)

Parameters

<cnum>

Channel number of the measurement. There must be a selected measurement on that channel. If unspecified, <cnum> is set to 1.

<pnum>

Logical port number. Choose from logical ports 1, 2, or 3.

Note: See [Balanced port versus Logical port](#).

<value>

Imaginary part of the Impedance value in Units. Choose a number between 0 and 1E18.

Examples

```
CALC:FSIM:BAL:DZC:LPOR:IMAG 0  
calculate2:fsimulator:balun:dczconversion:lport:imag 300
```

Query Syntax

CALCulate<cnum>:FSIMulator:BALun:DZConversion:LPORT<pnum>:IMAG?

Return Type

Numeric

Default

0

CALCulate<cnum>:FSIMulator:BALun:DZConversion:LPORT<pnum>:REAL <value>

Applicable Models: All

(Read-Write) Sets the real part of the impedance value for the differential port impedance conversion function.

See Critical Note

Parameters

<num> Channel number of the measurement. There must be a selected measurement on that channel. If unspecified, <num> is set to 1.

<pnum> Logical port number. Choose from logical ports 1, 2, or 3.

Note: See [Balanced port versus Logical port](#).

<value> Real part of the Impedance value in Units. Choose a number between 0 and 1E18

Examples

```
CALC:FSIM:BAL:DZC:LPOR:REAL 50
calculate2:fsimulator:balun:dzconversion:lport:real 75
```

Query Syntax

```
CALCulate<num>:FSIMulator:BALun:DZConversion:LPORt<pnum>:REAL?
```

Return Type

Numeric

Default

See [Differential Port Z Conversion Default](#)

CALCulate<num>:FSIMulator:BALun:DZConversion:LPORt<pnum>:Z0[:R] <value>

Applicable Models: All

(Read-Write) Sets the impedance value for the differential port impedance conversion function. Set either this single value or set the **real** and **imaginary** parts separately. The imaginary part is set to 0.0 using this command.

See Critical Note

Parameters

<num> Channel number of the measurement. There must be a selected measurement on that channel. If unspecified, <num> is set to 1.

<pnum> Logical port number. Choose from logical ports 1, 2, or 3.

Note: See [Balanced port versus Logical port](#).

<value> Impedance value in ohms. Choose a number between 0 to 1E7

Examples

```
CALC:FSIM:BAL:DZC:LPOR:Z0 50
calculate2:fsimulator:balun:dzconversion:lport:z0:r 75
```

Query Syntax `CALCulate<cnum>:FSIMulator:BALun:DZConversion:LPORT<pnum>:Z0[:R]?`

Return Type Numeric

Default See [Differential Port Z Conversion Default](#)

CALCulate<cnum>:FSIMulator:BALun:FIXTure:OFFSet:PHASe <bool>

Applicable Models: N522xB, N523xB, N524xB, M937xA, P937xA

(Read-Write) Sets and reads the state of "Phase Offset - Offset as Fixture" with True Mode balanced measurements.

Learn more about iTMSA phase and power offset.

[See Critical Note](#)

Parameters

<cnum> Channel number of the measurement. There must be a selected true mode balanced measurement on that channel. If unspecified, <cnum> is set to 1.

<bool> **State of phase Offset as Fixture.**
OFF (or 0) Offset is applied but is NOT included as a fixture in the output calculations.
ON (or 1) Offset is applied and included as a fixture in the output calculations.

Examples

```
CALC:FSIM:BAL:FIXT:OFFS:PHAS 0
calculate2:fsimulator:balun:fixture:offset:phase on
See example iTMSA program
```

Query Syntax `CALCulate<cnum>:FSIMulator:BALun:FIXTureOFFSet:PHASe?`

Return Type Boolean

Default Off

CALCulate<cnum>:FSIMulator:BALun:FIXTure:OFFSet:POWER <bool>

Applicable Models: N522xB, N523xB, N524xB, M937xA, P937xA

(Read-Write) Sets and reads the state of "Power Offset - Offset as Fixture" with True Mode balanced measurements.

Learn more about iTMSA phase and power offset.

[See Critical Note](#)

Parameters

<num>	Channel number of the measurement. There must be a selected true mode balanced measurement on that channel. If unspecified, <num> is set to 1.
<bool>	<p style="text-align: center;">State of power Offset as Fixture.</p> <p>OFF (or 0) Offset is applied but is NOT included as a fixture in the output calculations.</p> <p>ON (or 1) Offset is applied and included as a fixture in the output calculations.</p>
Examples	<pre>CALC:FSIM:BAL:FIXT:OFFS:POW 0 calculate2:fsimulator:balun:fixture:offset:power on See example iTMSA program</pre>
Query Syntax	CALCulate<num>:FSIMulator:BALun:FIXTureOFFSet:POWer?
Return Type	Boolean
Default	Off

CALCulate<num>:FSIMulator:BALun:FIXTure:PHASe <bool>

Applicable Models: N522xB, N523xB, N524xB, M937xA, P937xA

(Read-Write) Sets and reads the state of "Phase Sweep - Offset as Fixture" (labeling on GUI).

Learn more about iTMSA Phase Sweep.

[See Critical Note](#)

Parameters

<num>	Channel number of the measurement. There must be a selected true mode balanced measurement on that channel. If unspecified, <num> is set to 1.
<bool>	<p style="text-align: center;">State of phase sweep offset as a fixture:</p> <p>OFF (or 0) Phase Sweep offset disabled.</p> <p>ON (or 1) Phase Sweep offset enabled.</p>
Examples	<pre>CALC:FSIM:BAL:FIXT:PHAS 0 calculate2:fsimulator:balun:fixture:phase on</pre>
Query Syntax	CALCulate<num>:FSIMulator:BALun:FIXTure:PHASe?
Return Type	Boolean
Default	Off

CALCulate<num>:FSIMulator:BALun:PARAmeter<n>:BALSended[:DEFine] <char>

Applicable Models: All

(Read-Write) For a Balanced-Single-ended device type, selects the measurement parameter for the specified trace. Set device type using **CALC:FSIM:BAL:DEV**

See Critical Note

Parameters

<cnm> Channel number of the measurement. There must be a selected measurement on that channel. If unspecified, <cnm> is set to 1.

<n> Trace number on the specified channel <cnm>

<char> Balanced - Single-ended Measurement parameter. Choose from:

Sdd11	Sdc11	Sds12
Scd11	Scs11	Scs12
Ssd21	Ssc21	Sss22
lmb	CMRR1 (Ssd21/Ssc21)	CMRR2 (Sds12/Scs12)

Examples

```
CALC:FSIM:BAL:PAR:BALS SDC11  
calculate1:fsimulator:balun:parameter2:balsended:define  
lmb
```

Query Syntax **CALCulate<cnm>:FSIMulator:BALun:PARAmeter<n>:BALSended[:DEFine]?**

Return Type Character

Default Sdd11

CALCulate<cnm>:FSIMulator:BALun:PARAmeter<n>:BALanced[:DEFine] <char>

Applicable Models: All

(Read-Write) For a Balanced device type, selects the measurement parameter for the specified trace. Set device type using **CALC:FSIM:BAL:DEV**

See Critical Note

Parameters

<num> Channel number of the measurement. There must be a selected measurement on that channel. If unspecified, <num> is set to 1.

<n> Trace number on the specified channel <num>

<char> **Balanced Measurement parameter. Choose from:**
SDD11 - Specifies Sdd11.
SCD11 - Specifies Scd11.
SDC11 - Specifies Sdc11.
SCC11 - Specifies Scc11.

Examples

```
CALC:FSIM:BAL:PAR:BAL SDD11  
calculate1:fsimulator:balun: parameter2:balanced:define  
scc11
```

Query Syntax **CALCulate<num>:FSIMulator:BALun:PARAmeter<n>:BALanced[:DEFine]?**

Return Type String

Default Sdd11

CALCulate<num>:FSIMulator:BALun:PARAmeter<n>:BBALanced[:DEFine] <char>

Applicable Models: All

(Read-Write) For a Balanced - Balanced device type, selects the measurement parameter for the specified trace. Set device type using **CALC:FSIM:BAL:DEV**

[See Critical Note](#)

Parameters

<num> Channel number of the measurement. There must be a selected measurement on that channel. If unspecified, <num> is set to 1.

<n> Trace number on the specified channel <num>

<char> **Balanced- Balanced Measurement parameter. Choose from:**

Sdd11	Sdd12	Sdc11	Sdc12
Sdd21	Sdd22	Sdc21	Sdc22
Scd11	Scd12	Scd11	Scd12
Scd21	Scd22	Scd21	Scd22

	lmb1 lmb2 CMRR -(Sdd21/Sc21)
Examples	<code>CALC:FSIM:BAL:PAR:BBAL SDD12</code> <code>calculate1:fsimulator:balun: parameter2:bbalanced:define cmrr</code>
Query Syntax	<code>CALCulate<cnun>:FSIMulator:BALun:PARAmeter<n>:BBALanced[:DEFine]?</code>
Return Type	Character
Default	Sdd11

CALCulate<cnun>:FSIMulator:BALun:PARAmeter:CATalog?

Applicable Models: All

(Read-only) This query returns the list of measurement parameters available for the currently selected device type and topology.

Balanced parameters are defined by specifying a topology: selecting which ports are balanced ports and which ports are single ended. Once a topology has been specified, that topology will yield a set of available measurement parameters. Set the topology using `CALC:FSIM:BAL:DEVice`.

Parameter
s

<cnun >
>
Channel number.

Example

```
CALC:FSIM:BAL:TOP:SBAL:PPORTs 2,3,4
CALC:FSIM:BAL:DEV SBAL
CALC:FSIM:BAL:PAR:CAT?
"SSS11,SDS21,SSD12,SCS21,SSC12,SDD22,SCD22,SDC22,SCC22,IMB,CMRR1,CMRR2"
```

Return
Type Comma separated string

Default Not Applicable

CALCulate<cnun>:FSIMulator:BALun:PARAmeter:CUSTom[:DEFine] <string>

Applicable Models: Multi-port systems with > 4 ports

(Read-Write) Defines a balanced measurement parameter corresponding to a custom topology for systems where the port count is expandable beyond 4 ports. The device type parameter must be set to CUST using the **CALC:FSIM:BAL:DEV** command to use this command.

See Also:

CALC:FSIM:BAL:PAR:CAT? - returns the list of parameters available for the currently selected device type and topology.

CALC:DTOPOlogy - maps device type logical ports to VNA physical ports.

See Critical Note

Parameters

<cnun> Channel number.

<string> Balanced measurement parameter name. The parameter selections depend on the currently selected topology.

Examples

```
CALC:PAR:COUN 1
CALC:FSIM:BAL:DEV CUST
CALC:FSIM:BAL:PAR:STATE ON
CALC:DTOPOlogy "SSBSS",1,2,4,5,3,6
CALC:FSIM:BAL:PAR:CUST:DEF "SDD22"
```

Query Syntax **CALCulate<cnun>:FSIMulator:BALun:PARAmeter:CUSTom[:DEFine]?**

Return Type String

Default Not Applicable

CALCulate<cnun>:FSIMulator:BALun:PARAmeter<n>:SBALanced[:DEFine] <char>

Applicable Models: All

(Read-Write) For a Single-ended - Balanced device type, selects the measurement parameter for the specified trace. Set device type using **CALC:FSIM:BAL:DEV**

See Critical Note

Parameters

<cnun> Channel number of the measurement. There must be a selected measurement on that channel. If unspecified, <cnun> is set to 1.

<n> Trace number on the specified channel <cnun>

<char> Single-ended - Balanced Measurement parameter. Choose from:

Sss11	Ssd12	Scs12
-------	-------	-------

Sds21	Sdd22	Sdc22
Scs21	Scd22	Sc22
Imb	CMRR1 (Sds21/Scs21)	CMRR2 (Ssd12/Scs12)

Examples

```
CALC:FSIM:BAL:PAR:SBAL SSD12
calculate1:fsimulator:balun: parameter2:sbalanced:define
imb
```

Query Syntax

CALCulate<num>:FSIMulator:BALun:PARAmeter<n>:SBALanced[:DEFine]?

Return Type

Character

Default

Sss11

CALCulate<num>:FSIMulator:BALun:PARAmeter<n>:SSBalanced[:DEFine] <char>

Applicable Models: All

(Read-Write) For a Single-ended - Single-ended - Balanced device type, selects the measurement parameter for the specified trace. Set device type using **CALC:FSIM:BAL:DEV**

See Critical Note

Parameters

<num>

Channel number of the measurement. There must be a selected measurement on that channel. If unspecified, <num> is set to 1.

<n>

Trace number on the specified channel <num>

<char>

Single-ended - Single-ended - Balanced Measurement parameter. Choose from:

Sss11	Sss12	Ssd13	Ssc13
Sss21	Sss22	Ssd23	Ssc23
Sds31	Sds32	Sdd33	Sdc33
Scs31	Scs32	Scd33	Sc23
Imb1	Imb2	CMRR1 (Sds31/Scs31)	CMRR2 (Sds32/Scs32)

Examples	<pre>CALC:FSIM:BAL:PAR:SSB SSD23 calculate1:fsimulator:balun: parameter2:ssbalanced:define imb1</pre>
Query Syntax	<code>CALCulate<num>:FSIMulator:BALun:PARameter<n>:SSBalanced[:DEFine]?</code>
Return Type	Character
Default	Sss11

CALCulate<num>:FSIMulator:BALun:PARameter:STATe <bool>

Applicable Models: All

(Read-Write) Turns balanced transform ON and OFF.

[See Critical Note](#)

Parameters

<num> Channel number of the measurement. There must be a selected measurement on that channel. If unspecified, <num> is set to 1.

<bool> State of balanced transform. Choose from
OFF (or 0) Balanced Transform OFF
ON (or 1) Balanced Transform ON

Examples	<pre>CALC:FSIM:BAL:PAR:STAT 1 calculate1:fsimulator:balun:parameter:state off</pre>
Query Syntax	<code>CALCulate<num>:FSIMulator:BALun:PARameter:STATe?</code>
Return Type	Boolean
Default	OFF

CALCulate<num>:FSIMulator:BALun:PHASe:SWEep:STATe <bool>

Applicable Models: N522xB, N523xB, N524xB

(Read-Write) Sets and reads the state of phase sweep.

Learn more about iTMSA Phase Sweep.

[See Critical Note](#)

Parameters

<num> Channel number of the measurement. There must be a selected true mode balanced measurement on that channel. If unspecified, <num> is set to 1.

<bool> State of phase sweep:
OFF (or 0) Phase Sweep disabled.
ON (or 1) Phase Sweep enabled.

Examples

```
CALC:FSIM:BAL:PHAS:SWE:STAT 0  
calculate2:fsimulator:balun:phase:sweep:state on
```

Query Syntax

```
CALCulate<num>:FSIMulator:BALun:PHASe:SWEep:STATE?
```

Return Type Boolean

Default Off

CALCulate<num>:FSIMulator:BALun:STIMulus:MODE <value>

Applicable Models: N522xB, N523xB, N524xB, M937xA, P937xA

(Read-Write) Sets the stimulus mode of the VNA source. True Mode settings requires [Opt S93460A/B](#).

Learn more about iTMSA.

[See Critical Note](#)

Parameters

<num> Channel number of the measurement. There must be a selected measurement on that channel. If unspecified, <num> is set to 1.

<value> Stimulus mode. When a True-Mode is selected, the Balanced port powers are automatically uncoupled. Choose from:

SE - Single-Ended stimulus

TM - True-Mode stimulus

FTM - Forward only True-Mode stimulus

RTM - Reverse only True-Mode stimulus

Examples

```
CALC:FSIM:BAL:STIM:MODE SE  
calculate2:fsimulator:balun:stimulus:mode rtm  
See example program
```

Query Syntax

```
CALCulate<num>:FSIMulator:BALun:STIMulus:MODE?
```

Return Type Character

Default SE

**CALCulate<cnum>:FSIMulator:BALun:TOPology:BALSended[:PPORTs]
<bPos>,<bNeg>,<se>**

Applicable Models: All

(Read-Write) For a Balanced - Single-ended device type, maps the VNA ports to the DUT ports.

Set the Balanced - Single-ended device type using **CALC:FSIM:BAL:DEV**

[See Critical Note](#)

Parameters

<cnum> Channel number of the measurement. There must be a selected measurement on that channel. If unspecified, <cnum> is set to 1.

<bPos> VNA port number that connects to each of the following DUT ports:

<bNeg>

<se>

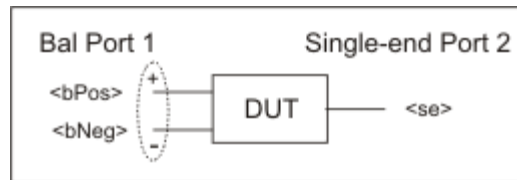

Examples

```
CALC:FSIM:BAL:TOP:BALS 1,2,3  
calculatel1:fsimulator:balun:topology:balsended:pports  
4,3,2
```

Query Syntax **CALCulate<cnum>:FSIMulator:BALun:TOPology:BALSended[:PPORTs]?**

Return Type Numeric - Returns three numbers separated by commas.

Default Not Applicable

**CALCulate<cnum>:FSIMulator:BALun:TOPology:BALanced[:PPORTs]
<p1Pos>,<p1Neg>**

Applicable Models: All

(Read-Write) For a Balanced device type, maps the VNA ports to the DUT ports.

Set the Balanced - Balanced device type using **CALC:FSIM:BAL:DEV**

[See Critical Note](#)

Parameters

<cnum> Channel number of the measurement. There must be a selected measurement on that channel. If unspecified, <cnum> is set to 1.

<p1Pos> VNA port number that connects to each of the following DUT ports:

<p1Neg>

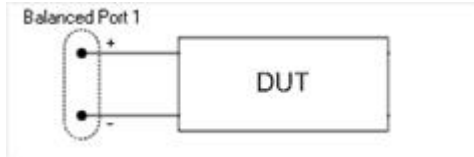

Examples

```
CALC:FSIM:BAL:TOP:BAL 1,2  
calculate1:fsimulator:balun: topology:balanced:pports  
1,2
```

Query Syntax

```
CALCulate<cnum>:FSIMulator:BALun:TOPology:BALanced[:PPORTs]?
```

Return Type

Numeric - Returns two numbers separated by commas.

Default

Not Applicable

**CALCulate<cnum>:FSIMulator:BALun:TOPology:BBALanced[:PPORTs]
<p1Pos>,<p1Neg>,<p2Pos>,<p2Neg>**

Applicable Models: All

(Read-Write) For a Balanced - Balanced device type, maps the VNA ports to the DUT ports.

Set the Balanced - Balanced device type using **CALC:FSIM:BAL:DEV**

See Critical Note

Parameters

<cnum> Channel number of the measurement. There must be a selected measurement on that channel. If unspecified, <cnum> is set to 1.

<p1Pos> VNA port number that connects to each of the following DUT ports:

<p1Neg>

<p2Pos>

<p2Neg>

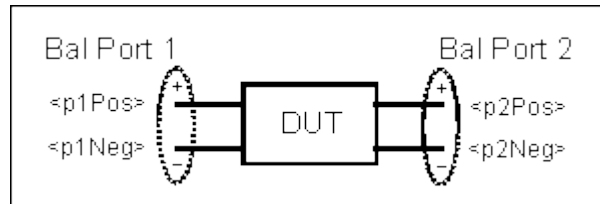

Examples

```
CALC:FSIM:BAL:TOP:BBAL 1,2,3,4
```

```
calculate1:fsimulator:balun: topology:bbalanced:pports
4,3,2,1
```

Query Syntax	<code>CALCulate<cnum>:FSIMulator:BALun:TOPology:BBALanced[:PPORTs]?</code>
Return Type	Numeric - Returns four numbers separated by commas.
Default	Not Applicable

`CALCulate<cnum>:FSIMulator:BALun:TOPology:SBALanced[:PPORTs]` `<se>,<bPos>,<bNeg>`

Applicable Models: All

(Read-Write) For a Single-ended - Balanced device type, maps the VNA ports to the DUT ports. Set the Single-ended - Balanced device type using `CALC:FSIM:BAL:DEV`

[See Critical Note](#)

Parameters

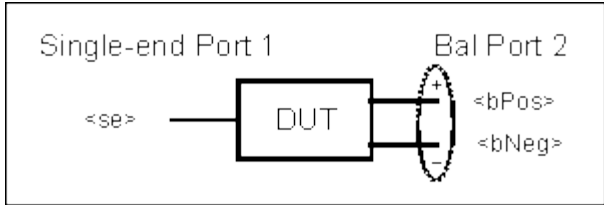
<code><cnum></code>	Channel number of the measurement. There must be a selected measurement on that channel. If unspecified, <code><cnum></code> is set to 1.
<code><se></code>	VNA port number that connects to each of the following DUT ports:
<code><bPos></code>	
<code><bNeg></code>	

Examples

```
CALC:FSIM:BAL:TOP:SBAL 1,2,3
calculate1:fsimulator:balun: topology:sbalanced:pports
4,3,2
```

Query Syntax	<code>CALCulate<cnum>:FSIMulator:BALun:TOPology:SBALanced[:PPORTs]?</code>
Return Type	Numeric - Returns three numbers separated by commas.
Default	Not Applicable

`CALCulate<cnum>:FSIMulator:BALun:TOPology:SSBalanced[:PPORTs]` `<se1>,<se2>,<bPos>,<bNeg>`

Applicable Models: All

(Read-Write) For a Single-ended - Single-ended - Balanced device type, maps the VNA ports to the DUT ports.

Set the Single-ended - Single-ended - Balanced device type using **CALC:FSIM:BAL:DEV**

See Critical

Parameters

<cnum> Channel number of the measurement. There must be a selected measurement on that channel. If unspecified, <cnum> is set to 1.

<se1> VNA port number that connects to each of the following DUT ports:

<se2>

<bPos>

<bNeg>

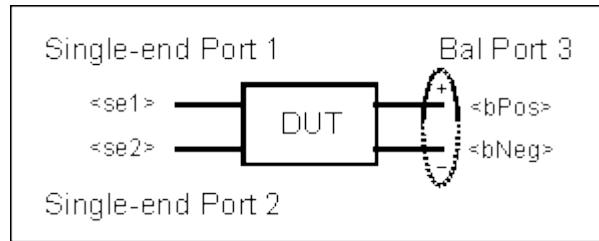

Examples

```
CALC:FSIM:BAL:TOP:SSB 1,2,3,4  
calculate1:fsimulator:balun:topology:ssbalanced:pports  
4,3,2,1
```

Query Syntax

```
CALCulate<cnum>:FSIMulator:BALun:TOPology:SSBalanced[:PPORTs]?
```

Return Type

Numeric - Returns four numbers separated by commas.

Default

Not Applicable

F Simulator Embed

Specifies settings for embedding and de-embedding balanced (4-port) fixturing circuits.

CALCulate:FSIMulator:EMBed:

NETWork:

| **FILEname**

| **PMAP**

| **TYPE**

STATe

TOPology:

| **A:PORTs**

| **B:PORTs**

| **C:PORTs**

| **D:PORTs**

TYPE

Click a [blue](#) keyword to view the command details.

See Also

[Example Programs](#)

[Synchronizing the Analyzer and Controller](#)

[SCPI Command Tree](#)

Critical Note: CALCulate commands act on the selected measurement. You can select one measurement for each channel using [Calc:Par:MNUM](#) or [Calc:Par:Select](#). [Learn more](#).

CALCulate<cnum>:FSIMulator:EMBed:NETWork<n>:FILEname <string>

Applicable Models: All

(Read-Write) Specifies the 4-port touchstone file (*.s4p) in which the network to embed or de-embed resides. Following this command, send CALC:FSIM:EMB:NETW:TYPE. If the specified file does not exist, an error occurs when type command is sent.

[Learn about 4-port network embedding.](#)

Parameters

<cnum>	Channel number of the measurement. There must be a selected measurement on that channel. If unspecified, <cnum> is set to 1.
<n>	Network position. Choose from 1 or 2.
<string>	File name and extension (.s4P) of the circuit. Files are stored in the "C:/Program Files/Keysight/Network Analyzer/Documents " drive. To recall from a different folder, specify the full path name.

Examples

```
10 calculate2:fsimulator:embed:network2:filename
"D:\myFile.s4P"
20 calculate2:fsimulator:embed:network2:type embed
```

Query Syntax	CALCulate<cnum>:FSIMulator:EMBed:NETWork<n>:FILename?
Return Type	String
Default	Not Applicable

CALCulate<cnum>:FSIMulator:EMBed:NETWork<n>:PMAP <inA>,<inB>,<outA>,<outB>

Applicable Models: All

(Read-Write) Set and return the port mapping for a 4-port SNP file to be embedded.
[Learn about 4-port network embedding.](#)

Parameters

<cnum>	Channel number of the measurement. There must be a selected measurement on that channel. If unspecified, <cnum> is set to 1.
<n>	Network position. Choose from 1 or 2.
<inA> <inB> <outA> <outB>	Port Mapping. Use four port numbers in any order.

Example

```
CALC : FSIM : EMB : NETW1 : PMAP 1 , 3 , 2 , 4
```

Query Syntax	CALCulate<cnum>:FSIMulator:EMBed:NETWork<n>:PMAP?
Return Type	Comma-separated numeric
Default	1,2,3,4

CALCulate<cnum>:FSIMulator:EMBed:NETWork<n>:TYPE <char>

Applicable Models: All

(Read-Write) Specify the type of processing to take place on the specified 4-port network. First specify the network filename with **CALC:FSIM:EMB:NETW:FIL**.
[Learn about 4-port network embedding.](#)

Parameters

<cnum>	Channel number of the measurement. There must be a selected measurement on that channel. If unspecified, <cnum> is set to 1.
<n>	Network position. Choose from 1 or 2.
<char>	Processing type. Choose from : NONE - The same as disabling. EMBed - Add Network circuit. DEEMbed - Remove Network circuit.

Example

```
10 CALC : FSIM : EMB : NETW2 : FIL 'myFile.s4p'
20 CALC : FSIM : EMB : NETW2 : TYPE EMBed
```

Query Syntax	CALCulate<cnum>:FSIMulator:EMBed:NETWork<n>:TYPE?
--------------	---

Return Type	Character
Default	NONE

CALCulate<cnum>:FSIMulator:EMBed:STATe <bool>

Applicable Models: All

(Read-Write) Turns ON or OFF 4-port Network Embedding/De-embedding for all ports on the specified channel.

Parameters

<cnum> Channel number of the measurement. There must be a selected measurement on that channel. If unspecified, <cnum> is set to 1.

<bool> Choose from:

ON or 1 - Turns 4-port Network Embedding/De-embedding ON
OFF or 0 - Turns 4-port Network Embedding/De-embedding OFF

Examples

```
CALC:FSIM:EMB:STAT 1
calculate2:fsimulator:embed:state 0
```

Query Syntax CALCulate<cnum>:FSIMulator:EMBed:STATe?

Return Type Boolean

Default OFF

CALCulate<cnum>:FSIMulator:EMBed:TOPology:A:PORTs <p1>,<p2>

Applicable Models: All

(Read-Write) Specifies the VNA port connections when topology A is selected. Specify topology using **CALC:FSIM:EMBed:TYPE**.

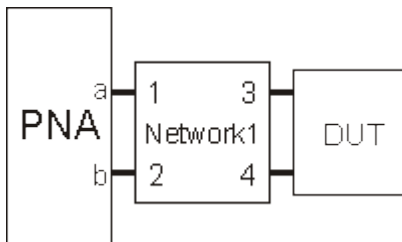

Topology A

Parameters

<cnum> Channel number of the measurement. There must be a selected measurement on that channel. If unspecified, <cnum> is set to 1.

<p1> VNA Port number assigned to a in above graphic.
 <p2> VNA Port number assigned to b in above graphic.

Examples	<code>CALC:FSIM:EMB:TOP:A:PORT 2,1</code> <code>calculate2:fsimulator:embed:topology:a:ports 1,2</code>
Query Syntax	<code>CALCulate<cnum>:FSIMulator:EMBed:TOPology:A:PORTs?</code>
Return Type	Numeric
Default	1,2

CALCulate<cnum>:FSIMulator:EMBed:TOPology:B:PORTs <p1>,<p2>,<p3>

Applicable Models: All
 (Read-Write) Specifies the VNA port connections when topology B is selected. Specify topology using `CALC:FSIM:EMBed:TYPE`.

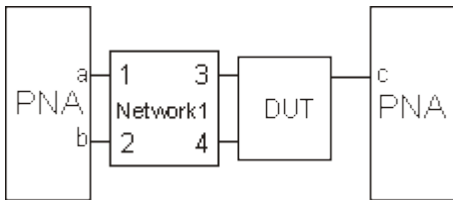

Topology B

Parameters

<cnum> Channel number of the measurement. There must be a selected measurement on that channel. If unspecified, <cnum> is set to 1.
 <p1> VNA Port number assigned to a in above graphic.
 <p2> VNA Port number assigned to b in above graphic.
 <p3> VNA Port number assigned to c in above graphic.

Examples	<code>CALC:FSIM:EMB:TOP:B:PORT 2,1,4</code> <code>calculate2:fsimulator:embed:topology:b:ports 1,2,3</code>
Query Syntax	<code>CALCulate<cnum>:FSIMulator:EMBed:TOPology:B:PORTs?</code>
Return Type	Numeric
Default	1,2,3

CALCulate<cnum>:FSIMulator:EMBed:TOPology:C:PORTs <p1>,<p2>,<p3>,<p4>

Applicable Models: All

(Read-Write) Specifies the VNA port connections when topology C is selected. Specify topology using **CALC:FSIM:EMBed:TYPE**.

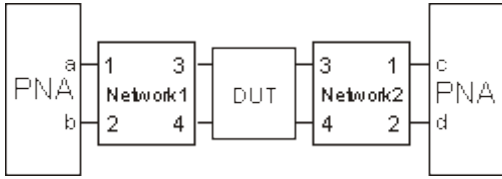

Topology C

Parameters

- <cnm>** Channel number of the measurement. There must be a selected measurement on that channel. If unspecified, <cnm> is set to 1.
- <p1>** VNA Port number assigned to a in above graphic.
- <p2>** VNA Port number assigned to b in above graphic.
- <p3>** VNA Port number assigned to c in above graphic.
- <p4>** VNA Port number assigned to d in above graphic.

Examples

```
CALC:FSIM:EMB:TOP:C:PORT 2,1,4,3
calculate2:fsimulator:embed:topology:c:ports 1,2,3,4
```

Query Syntax

CALCulate<cnm>:FSIMulator:EMBed:TOPology:C:PORTs?

Return Type

Numeric

Default

1,2,3,4

CALCulate<cnm>:FSIMulator:EMBed:TOPology:D:PORTs <p1>,<p2>,<p3>,<p4>...<pN>

Applicable Models: All

(Read-Write) Specifies the VNA port connections for VNAs having greater than 4 ports. Specify topology using **CALC:FSIM:EMBed:TYPE**. [Learn more.](#)

Parameters

- <cnm>** Channel number of the measurement.
- <p1>,<p2>,<p3>,<p4>...<pN>** VNA port number assignment.

Examples

```
CALC:FSIM:EMB:TOP:D:PORT 2,1,4,3,6,5,8,7
calculate2:fsimulator:embed:topology:d:ports 1,2,3,4,5,6,7,8
```

Query Syntax

CALCulate<cnm>:FSIMulator:EMBed:TOPology:D:PORTs?

Return Type	Numeric
Default	Not Applicable

CALCulate<cnum>:FSIMulator:EMBed:TYPE <char>

Applicable Models: All

(Read-Write) Specifies the VNA / DUT topology. [Learn more about these and other VNA/DUT configurations.](#)

Parameters

<cnum>	Channel number of the measurement. There must be a selected measurement on that channel. If unspecified, <cnum> is set to 1.
<char>	VNA / DUT topology. Choose from: A - 2 PNA/DUT Ports B - 3 PNA/DUT Ports C - 4 PNA/DUT Ports D - >4 VNA/DUT Ports Click links to see topologies and port assignment commands.

Examples

```
CALC:FSIM:EMB:TYPE A
calculate2:fsimulator:embed:type c
```

Query Syntax	CALCulate<cnum>:FSIMulator:EMBed:TYPE?
Return Type	Character
Default	A

F Simulator G Loop

Specifies settings and fixturing for ground loop de-embedding / embedding.

CALCulate:FSIMulator:GLOop:

DEEMBed:

| PARameters:

| C

| L

| R

| STATe

| TYPE

| USER:FILeName

EMBed:

| PARameters:

| C

| L

| R

| STATe

| TYPE

| USER:FILeName

See Also

[SCPI Command Tree](#)

Critical Note: CALCulate commands act on the selected measurement. You can select one measurement for each channel using [Calc:Par:MNUM](#) or [Calc:Par:Select](#). [Learn more](#).

CALCulate<num>:FSIMulator:GLOop:DEEMbed:PARameters:C <value>

Applicable Models: All

(Read-Write) Sets and returns the Capacitance, 'C' value for the ground loop de-embedding of the specified channel.

Note: This command affects ALL measurements on the specified channel.

Parameters

<num> Channel number of the measurement. There must be a selected measurement on that channel. If unspecified, <num> is set to 1.

<value> **Capacitance value in farads. Choose a value between -1E18 to 1E18**

Examples

```
CALC:FSIM:GLO:DEEM:PAR:C 0.00002  
calculate2:fsimulator:gloop:deembed:parameters:c 0.00003
```

Query Syntax CALCulate<num>:FSIMulator:GLOop:DEEMbed:PARameters:C?

Return Type Numeric

Default 0

CALCulate<num>:FSIMulator:GLOop:DEEMbed:PARameters:L <value>

Applicable Models: All

(Read-Write) Sets and returns the Inductance, 'L' value for the ground loop de-embedding of the specified channel.

Note: This command affects ALL measurements on the specified channel.

Parameters

<num> Channel number of the measurement. There must be a selected measurement on that channel. If unspecified, <num> is set to 1.

<value> **Inductance value in henries. Choose a value between -1E18 to 1E18**

Examples

```
CALC:FSIM:GLO:DEEM:PAR:L 0.00002  
calculate2:fsimulator:gloop:deembed:parameters:l 0.00003
```

Query Syntax CALCulate<num>:FSIMulator:GLOop:DEEMbed:PARameters:L?

Return Type Numeric

Default 0

CALCulate<cnum>:FSIMulator:GLOop:DEEMbed:PARAmeters:R <value>

Applicable Models: All

(Read-Write) Sets and returns the Resistance, 'R' value for the ground loop de-embedding of the specified channel.

Note: This command affects ALL measurements on the specified channel.

Parameters

<cnum>	Channel number of the measurement. There must be a selected measurement on that channel. If unspecified, <cnum> is set to 1.
<value>	Resistance value in ohms. Choose a value between -1E18 to 1E18

Examples

```
CALC:FSIM:GLO:DEEM:PAR:R 0.00002  
calculate2:fsimulator:gloop:deembed:parameters:r 0.00003
```

Query Syntax **CALCulate<cnum>:FSIMulator:GLOop:DEEMbed:PARAmeters:R?**

Return Type Numeric

Default 0

CALCulate<cnum>:FSIMulator:GLOop:DEEMbed:STATe <bool>

Applicable Models: All

(Read-Write) Turns ON or OFF De-embedding for the specified channel.

Note: This command affects ALL measurements on the specified channel.

Parameters

<cnum>	Channel number of the measurement. There must be a selected measurement on that channel. If unspecified, <cnum> is set to 1.
<bool>	Choose from: ON or 1 - Turns De-embedding ON OFF or 0 - Turns De-embedding OFF

Examples

```
CALC:FSIM:GLO:DEEM:STAT 1  
calculate2:fsimulator:gloop:deembed:state 0
```

Query Syntax **CALCulate<cnum>:FSIMulator:GLOop:DEEMbed:STATe?**

Return Type Boolean

Default OFF

CALCulate<cnum>:FSIMulator:GLOop:DEEMbed:TYPE <char>

Applicable Models: All

(Read-Write) Specifies the circuit model type for ground loop de-embedding.

Parameters

<cnum> Channel number of the measurement. There must be a selected measurement on that channel. If unspecified, <cnum> is set to 1.

<char> **Choose from:**
USER - Loads s1p file specified using the **CALC:FSIM:GLO:DEEM:USER** command.
RL - Selects Shunt L circuit model.
RC - Selects Shunt C circuit mode.

Examples

```
CALC:FSIM:GLO:DEEM:TYPE RL  
calculate2:fsimulator:gloop:deembed:type RC
```

Query Syntax CALCulate<cnum>:FSIMulator:GLOop:DEEMbed:TYPE?

Return Type Character

Default RL

CALCulate<cnum>:FSIMulator:GLOop:DEEMbed:USER:FILEname <filename>

Applicable Models: All

(Read-Write) Specifies the filename of the s1p file to load for ground loop de-embedding.

Note: This command affects ALL measurements on the specified channel.

Parameters

<cnum> Channel number of the measurement. There must be a selected measurement on that channel. If unspecified, <cnum> is set to 1.

<filename> **File name and extension (.s1P) of the de-embedding circuit.**

Files are stored in the default folder "C:/Program Files/Keysight/Network Analyzer/Documents

To recall from a different folder, specify the full path name.

Examples

```
CALC:FSIM:GLO:DEEM:USER:FIL 'myFile.s1P'  
calculate2:fsimulator:gloop:deembed:user:filename  
"C:/Program Files/Keysight/Network  
Analyzer/Documents/myFile.s1P"
```

Query Syntax **CALCulate<cnum>:FSIMulator:GLOop:DEEMbed:USER:FILEname?**

Return Type String

Default Not Applicable

CALCulate<cnum>:FSIMulator:GLOop:EMBed:PARameters:C <value>

Applicable Models: All

(Read-Write) Sets and returns the Capacitance, 'C' value for the ground loop embedding of the specified channel.

Note: This command affects ALL measurements on the specified channel.

Parameters

<cnum> Channel number of the measurement. There must be a selected measurement on that channel. If unspecified, <cnum> is set to 1.

<value> **Capacitance value in farads. Choose a value between -1E18 to 1E18**

Examples

```
CALC:FSIM:GLO:EMB:PAR:C 0.00002  
calculate2:fsimulator:gloop:embed:parameters:c 0.00003
```

Query Syntax **CALCulate<cnum>:FSIMulator:GLOop:EMBed:PARameters:C?**

Return Type Numeric

Default 0

CALCulate<cnum>:FSIMulator:GLOop:EMBed:PARameters:L <value>

Applicable Models: All

(Read-Write) Sets and returns the Inductance, 'L' value for the ground loop embedding of the specified channel.

Note: This command affects ALL measurements on the specified channel.

Parameters

<num> Channel number of the measurement. There must be a selected measurement on that channel. If unspecified, <num> is set to 1.
<value> **Inductance value in henries. Choose a value between -1E18 to 1E18**

Examples

```
CALC:FSIM:GLO:EMB:PAR:L 0.00002  
calculate2:fsimulator:gloop:embed:parameters:l 0.00003
```

Query Syntax CALCulate<num>:FSIMulator:GLOop:EMBed:PARameters:L?

Return Type Numeric

Default 0

CALCulate<num>:FSIMulator:GLOop:EMBed:PARameters:R <value>

Applicable Models: All

(Read-Write) Sets and returns the Resistance, 'R' value for the ground loop embedding of the specified channel.

Note: This command affects ALL measurements on the specified channel.

Parameters

<num> Channel number of the measurement. There must be a selected measurement on that channel. If unspecified, <num> is set to 1.
<value> **Resistance value in ohms. Choose a value between -1E18 to 1E18**

Examples

```
CALC:FSIM:GLO:EMB:PAR:R 0.00002  
calculate2:fsimulator:gloop:embed:parameters:r 0.00003
```

Query Syntax CALCulate<num>:FSIMulator:GLOop:EMBed:PARameters:R?

Return Type Numeric

Default 0

CALCulate<cnum>:FSIMulator:GLOop:EMBed:STATe <bool>

Applicable Models: All

(Read-Write) Turns ON or OFF Embedding for the specified channel.

Note: This command affects ALL measurements on the specified channel.

Parameters

<cnum>	Channel number of the measurement. There must be a selected measurement on that channel. If unspecified, <cnum> is set to 1.
<bool>	Choose from: ON or 1 - Turns Embedding ON OFF or 0 - Turns Embedding OFF

Examples

```
CALC:FSIM:GLO:EMB:STAT 1  
calculate2:fsimulator:gloop:embed:state 0
```

Query Syntax **CALCulate<cnum>:FSIMulator:GLOop:EMBed:STATe?**

Return Type Boolean

Default OFF

CALCulate<cnum>:FSIMulator:GLOop:EMBed:TYPE <char>

Applicable Models: All

(Read-Write) Specifies the circuit model type for ground loop embedding. Learn more.

Parameters

<cnum>	Channel number of the measurement. There must be a selected measurement on that channel. If unspecified, <cnum> is set to 1.
<char>	Choose from: USER - Loads s1p file specified using the CALC:FSIM:GLO:EMB:USER command. RL - Selects Shunt L circuit model. RC - Selects Shunt C circuit mode.

Examples

```
CALC:FSIM:GLO:EMB:TYPE RL  
calculate2:fsimulator:gloop:embed:type RC
```

Query Syntax **CALCulate<cnum>:FSIMulator:GLOop:EMBed:TYPE?**

Return Type Character

Default RL

CALCulate<cnum>:FSIMulator:GLOop:EMBed:USER:FILEname <filename>

Applicable Models: All

(Read-Write) Specifies the filename of the s1p file to load for ground loop embedding.

Note: This command affects ALL measurements on the specified channel.

Parameters

<cnum> Channel number of the measurement. There must be a selected measurement on that channel. If unspecified, <cnum> is set to 1.

<filename> **File name and extension (.s1P) of the embedding circuit.**
Files are stored in the default folder "C:/Program Files/Keysight/Network Analyzer/Documents"
To recall from a different folder, specify the full path name.

Examples

```
CALC:FSIM:GLO:EMB:USER:FIL 'myFile.s1P'  
calculate2:fsimulator:gloop:embed:user:filename  
"C:/Program Files/Keysight/Network  
Analyzer/Documents/myFile.s1P"
```

Query Syntax CALCulate<cnum>:FSIMulator:GLOop:EMBed:USER:FILEname?

Return Type String

Default Not Applicable

FSimulatorSend

Specifies settings for embedding and de-embedding **Single-Ended** (2-port) fixturing circuits.

CALCulate:FSIMulator:SENDEd:

DEEMbed

PORT

SNP:REVerse

[TYPE]

USER:FILEname

STATe

OORDer

PMCircuit

PORT

PARameters

C

G

L

R

[TYPE]

USER:FILEname

STATe

POWER:PORT:COMPensation

ZCONversion

PORT

IMAG

REAL

ZO[:R]

STATe

Click on a keyword to view the command details.

see Also

[Example Programs](#)

[Learn about Fixturing](#)

[Set Port Extensions with SCPI](#)

[Synchronizing the Analyzer and Controller](#)

[SCPI Command Tree](#)

Note: CALC:FSIM commands affect ALL measurements on the specified channel.

CALCulate<num>:FSIMulator:SENDEd:DEEMbed:PORT<n>:SNP:REVerse <bool>

Applicable Models: All

(Read-Write) Set and read whether or not to reverse ports on a 2-port fixture or adapter to be de-embedded. [Learn more.](#)

Parameters

<num> **Channel number of the measurement. There must be a selected measurement on that channel. If unspecified, <num> is set to 1.**

<port> VNA port number to which SNP file is to be de-embedded.

<bool> Choose from:

ON or 1 - Reverse ports
OFF or 0 - Do NOT Reverse ports

Examples

```
CALC:FSIM:SEND:DEEM:PORT1:SNP:REV 1  
calculate2:fsimulator:sended:deembed:port2:snp:reverse 0
```

Query Syntax **CALCulate<num>:FSIMulator:SENDEd:DEEMbed:PORT<n>:SNP:REVerse?**

Return Type Boolean

Default OFF

CALCulate<num>:FSIMulator:SENDEd:DEEMbed:PORT<n>[:TYPE] <char>

Applicable Models: All

(Read-Write) Select whether or not to load a 2-port De-embedding circuit model for the specified port number. Circuit model USER is valid when an associated .s2p file is specified with **CALC:FSIM:SEND:DEEM:PORT1:USER:FILENAME.**

Note: This command affects ALL measurements on the specified channel.

Parameters

<cnum> Channel number of the measurement. There must be a selected measurement on that channel. If unspecified, <cnum> is set to 1.

<port> Port number to receive circuit model.

<char> Choose from:

NONE - Port does not have a circuit model.
USER - Circuit model for the port will be loaded from VNA drive.

Examples

```
CALC:FSIM:SEND:DEEM:PORT1 USER  
calculate2:fsimulator:sended:deembed:port2:type none
```

Query Syntax **CALCulate<cnum>:FSIMulator:SENDEd:DEEMbed:PORT<n>[:TYPE]?**

Return Type Character

Default None

**CALCulate<cnum>:FSIMulator:SENDEd:DEEMbed:PORT<n>:USER:FILENAME
<string>**

Applicable Models: All
(Read-Write) Specifies the filename of the circuit model to be used for de-embedding. Circuit model is applied when both **CALC:FSIM:SEND:DEEM:PORT1 USER** is selected and the filename is specified with this command.

Note: This command affects ALL measurements on the specified channel.

Parameters

<cnum> Channel number of the measurement. There must be a selected measurement on that channel. If unspecified, <cnum> is set to 1.

<port> Port number to receive circuit model.

<string> File name and extension (.s2P) of the de-embedding circuit. Files are stored in the default folder "C:/Program Files/Keysight/Network Analyzer/Documents". To recall from a different folder, specify the full path name.

Examples

```
CALC:FSIM:SEND:DEEM:PORT1:USER:FILE 'myFile.s2P'  
calculate2:fsimulator:deembed:port2:user:file "C:/Program  
Files/Keysight/Network Analyzer/Documents/ myFile.s2P"
```

Query Syntax **CALCulate<cnum>:FSIMulator:SENDEd:DEEMbed:PORT<n>:USER:FILENAME?**

Return Type String

Default Not Applicable

CALCulate<cnum>:FSIMulator:SENDEd:DEEMbed:STATe <bool>

Applicable Models: All

(Read-Write) Turns de-embedding ON or OFF for all ports on the specified channel.

Note: This command affects ALL measurements on the specified channel.

Parameters

<cnum> Channel number of the measurement. There must be a selected measurement on that channel. If unspecified, <cnum> is set to 1.

<bool> Choose from:

ON or 1 - Turns de-embedding ON
OFF or 0 - Turns de-embedding OFF

Examples

```
CALC:FSIM:SEND:DEEM:STAT 1  
calculate2:fsimulator:sended:deembed:state 0
```

Query Syntax CALCulate<cnum>:FSIMulator:SENDEd:DEEMbed:STATe?

Return Type Boolean

Default OFF

CALCulate<cnum>:FSIMulator:SENDEd:OORDer <a,b,c,d>

Applicable Models: All

(Read-Write) Sets and returns the order in which Single-ended Fixture Operations occur. [Learn more about these operations.](#)

Note: The operation for ground loop embedding and ground loop de-embedding will always occur as the 3rd step. It cannot be moved. By default, this is after the 2-Port DeEmbedding operation.

Note: This command affects ALL measurements on the specified channel.

Parameters

<cnum> Channel number of the measurement. There must be a selected measurement on that channel. If unspecified, <cnum> is set to 1.

<a,b,c,d> Order of operations, where:
0 - Port Extension operation
1 - 2-Port DeEmbedding operation
2 - Port Matching operation
3 - Arbitrary Impedance operation

Examples

```
CALC:FSIM:SEND:OORD 1,2,3,0  
calculate2:fsimulator:sended:oorder 1,2,3,0
```

Query Syntax CALCulate<cnum>:FSIMulator:SENDEd:OORDer?

Return Type Comma-separated values

Default 0,1,2,3

CALCulate<num>:FSIMulator:SENDEd:PMCircuit:PORT<n>:PARAmeters:C <value>**Applicable Models:** All

(Read-Write) Sets and returns the value for the 'C' (Capacitance) circuit element for a port matching circuit model to simulate on port 'n'. The port matching circuit model is selected using **CALCulate<num>:FSIMulator:SENDEd:PMCircuit:PORT<n>[:TYPE]<char>**. You can specify C, C1, or C2 based on the selected port matching circuit model. Setting a value not used by the selected circuit will have no affect. [Learn more](#).

There are three steps to set up a port matching circuit model simulation on a specified port:

Select the port matching circuit model to simulate using

CALCulate<num>:FSIMulator:SENDEd:PMCircuit:PORT<n>[:TYPE]<char>.

Set the values for R (Resistance), G (Conductance), C (Capacitance), and L (Inductance) corresponding to the selected port matching circuit model.

Turn the feature on using **CALCulate<num>:FSIMulator:SENDEd:PMCircuit:STATe** to simulate the circuit and compute the measurement as if the circuit were attached to the port.

Note: This command affects ALL measurements on the specified channel.

Parameters

<num> **Channel number of the measurement. If unspecified, <num> is set to 1.**

<n> Port number to receive value.

<value> **Capacitance value in farads. Choose a value between -1E18 to 1E18**

Examples

```
CALC:FSIM:SEND:PMC:PORT1:PAR:C 0.00002
calculate2:fsimulator:sended:pmcircuit:port2:parameters:c
0.00003
```

Query Syntax **CALCulate<num>:FSIMulator:SENDEd:PMCircuit:PORT<n>:PARAmeters:C?**

Return Type Numeric

Default 0

CALCulate<num>:FSIMulator:SENDEd:PMCircuit:PORT<n>:PARAmeters:G <value>**Applicable Models:** All

(Read-Write) Sets and returns the value for the 'G' (Conductance) circuit element for a port matching circuit model to simulate on port 'n'. The port matching circuit model is selected using **CALCulate<num>:FSIMulator:SENDEd:PMCircuit:PORT<n>[:TYPE]<char>**. You can specify G, G1, or G2 based on the selected port matching circuit model. Setting a value not used by the selected circuit will have no affect. [Learn more](#).

There are three steps to set up a port matching circuit model simulation on a specified port:

Select the port matching circuit model to simulate using

CALCulate<num>:FSIMulator:SENDEd:PMCircuit:PORT<n>[:TYPE]<char>.

Set the values for R (Resistance), G (Conductance), C (Capacitance), and L (Inductance) corresponding to the selected port matching circuit model.

Turn the feature on using `CALCulate<num>:FSIMulator:SENDEd:PMCircuit:STATe` to simulate the circuit and compute the measurement as if the circuit were attached to the port.

Note: This command affects ALL measurements on the specified channel.

Parameters

<num> Channel number of the measurement. If unspecified, <num> is set to 1.

<n> Port number to receive value.

<value> Conductance value in siemens. Choose a value between -1E18 to 1E18

Examples

```
CALC:FSIM:SEND:PMC:PORT1:PAR:G 0.00002
calculate2:fsimulator:sended:pmcircuit:port2:parameters:g
0.00003
```

Query Syntax `CALCulate<num>:FSIMulator:SENDEd:PMCircuit:PORT<n>:PARAMeters:G?`

Return Type Numeric

Default 0

CALCulate<num>:FSIMulator:SENDEd:PMCircuit:PORT<n>:PARAMeters:L <value>

Applicable Models: All

(Read-Write) Sets and returns the value for the 'L' (Inductance) circuit element for a port matching circuit model to simulate on port 'n'. The port matching circuit model is selected using `CALCulate<num>:FSIMulator:SENDEd:PMCircuit:PORT<n>[:TYPE]<char>`. You can specify L, L1, or L2 based on the selected port matching circuit model. Setting a value not used by the selected circuit will have no affect. [Learn more](#).

There are three steps to set up a port matching circuit model simulation on a specified port:

Select the port matching circuit model to simulate using

`CALCulate<num>:FSIMulator:SENDEd:PMCircuit:PORT<n>[:TYPE]<char>`.

Set the values for R (Resistance), G (Conductance), C (Capacitance), and L (Inductance) corresponding to the selected port matching circuit model.

Turn the feature on using `CALCulate<num>:FSIMulator:SENDEd:PMCircuit:STATe` to simulate the circuit and compute the measurement as if the circuit were attached to the port.

Note: This command affects ALL measurements on the specified channel.

Parameters

<num> Channel number of the measurement. If unspecified, <num> is set to 1.

<n> Port number to receive value.

<value> Inductance value in henries. Choose a value between -1E18 to 1E18

Examples

```
CALC:FSIM:SEND:PMC:PORT1:PAR:L 0.00002
calculate2:fsimulator:sended:pmcircuit:port2:parameters:l
0.00003
```

Query Syntax **CALCulate<cnum>:FSIMulator:SENDEd:PMCircuit:PORT<n>:PARameters:L?**

Return Type Numeric

Default 0

CALCulate<cnum>:FSIMulator:SENDEd:PMCircuit:PORT<n>:PARameters:R <value>

Applicable Models: All

(Read-Write) Sets and returns the value for the 'R' (Resistance) circuit element for a port matching circuit model to simulate on port 'n'. The port matching circuit model is selected using **CALCulate<cnum>:FSIMulator:SENDEd:PMCircuit:PORT<n>[:TYPE]<char>**. You can specify R, R1, or R2 based on the selected port matching circuit model. Setting a value not used by the selected circuit will have no affect. [Learn more](#).

There are three steps to set up a port matching circuit model simulation on a specified port:

Select the port matching circuit model to simulate using

CALCulate<cnum>:FSIMulator:SENDEd:PMCircuit:PORT<n>[:TYPE]<char>.

Set the values for R (Resistance), G (Conductance), C (Capacitance), and L (Inductance) corresponding to the selected port matching circuit model.

Turn the feature on using **CALCulate<cnum>:FSIMulator:SENDEd:PMCircuit:STATe** to simulate the circuit and compute the measurement as if the circuit were attached to the port.

Note: This command affects ALL measurements on the specified channel.

Parameters

<cnum> Channel number of the measurement. If unspecified, <cnum> is set to 1.

<n> Port number to receive value.

<value> Resistance value in ohms. Choose a value between -1E18 to 1E18

Examples

```
CALC:FSIM:SEND:PMC:PORT1:PAR:R 0.00002
calculate2:fsimulator:sended:pmcircuit:port2:parameters:r
0.00003
```

Query Syntax **CALCulate<cnum>:FSIMulator:SENDEd:PMCircuit:PORT<n>:PARameters:R?**

Return Type Numeric

Default 0

CALCulate<num>:FSIMulator:SENDEd:PMCircuit:PORT<n>[:TYPE] <char>

Applicable Models: All

(Read-Write) Select whether or not to load a 2 port matching circuit model for the specified port number. Circuit model USER is valid when an associated .s2p file is specified with **CALC:FSIM:SEND:PMC:PORT1:USER:FILE**.

Note: This command affects ALL measurements on the specified channel.

Parameters

<num>	Channel number of the measurement. If unspecified, <num> is set to 1.
<n>	Port number to receive circuit model.
<char>	Circuit model. Choose from NONE No circuit model SLPC Series L - Parallel C PCSL Parallel C - Series L PLSC Parallel L - Series C SCPL Series C - Parallel L PLPC Parallel L - Parallel C SCPC Series C - Parallel C PCSC Parallel C - Series C SLPL Series L - Parallel L PLSL Parallel L - Series L USER Load S2P file

Examples

```
CALC:FSIM:SEND:PMC:PORT1:USER  
calculate2:fsimulator:sended:pmcircuit:port2:type slpc
```

Query Syntax	CALCulate<num>:FSIMulator:SENDEd:PMCircuit:PORT<n>[:TYPE]?
Return Type	Character
Default	None - No circuit model

CALCulate<num>:FSIMulator:SENDEd:PMCircuit:PORT<n>:USER:FILENAME <string>

Applicable Models: All

(Read-Write) Specifies the filename of the circuit model to be used for port matching. Circuit model is applied when both **CALC:FSIM:SEND:PMC:PORT1 USER** is selected and the filename is specified with this command.

Note: This command affects ALL measurements on the specified channel.

Parameters

<num>	Channel number of the measurement. There must be a selected measurement on that channel. If unspecified, <num> is set to 1.
<port>	Port number to receive circuit model.
<string>	File name and extension (.s2P) of the de-embedding circuit.

Files are stored in the default folder "C:/Program Files/Keysight/Network Analyzer/Documents".
 To recall from a different folder, specify the full path name.

Examples

```
CALC:FSIM:SEND:PMC:PORT1:USER:FILE 'myFile.s2P'
calculate2:fsimulator:pmcircuit:port2:user:file
"C:/Program Files/Keysight/Network Analyzer/Documents/
myFile.s2P"
```

Query Syntax	CALCulate<cnum>:FSIMulator:SENDEd:PMCircuit:PORT<n>:USER:FILEname?
Return Type	String
Default	Not Applicable

CALCulate<cnum>:FSIMulator:SENDEd:PMCircuit:STATE <bool>

Applicable Models: All

(Read-Write) Turns Port Matching ON or OFF for all ports on the specified channel.

Note: This command affects ALL measurements on the specified channel.

Parameters

<cnum>	Channel number of the measurement. There must be a selected measurement on that channel. If unspecified, <cnum> is set to 1.
<bool>	Choose from: ON or 1 - Turns Port Matching ON OFF or 0 - Turns Port Matching OFF

Examples

```
CALC:FSIM:SEND:PMC:STAT 1
calculate2:fsimulator:sended:pmcircuit:state 0
```

Query Syntax	CALCulate<cnum>:FSIMulator:SENDEd:PMCircuit:STATE?
Return Type	Boolean
Default	OFF

CALCulate<cnum>:FSIMulator:SENDEd:POWER:PORT<n>:COMPensation <bool>

Applicable Models: All

(Read-Write) Adjusts the source power at the specified port by the combined amount of loss through ALL enabled fixturing operations. Use this function to set the power level at the DUT input. [Learn more.](#)

Note: This command affects ALL measurements on the specified channel.

Parameters

<cnun> **Channel number of the measurement. There must be a selected measurement on that channel. If unspecified, <cnun> is set to 1.**

<port> Port number to receive power compensation.

<bool> Choose from:

ON or 1 - **Compensate source power**
OFF or 0 - **Do NOT compensate source power**

Examples

```
CALC:FSIM:SEND:POW:PORT1:COMP 1  
calculate2:fsimulator:power:port2:compensation off
```

Query Syntax **CALCulate<cnun>:FSIMulator:SENDEd:POWer:PORT<n>:COMPensation?**

Return Type Boolean

Default OFF

CALCulate<cnun>:FSIMulator:SENDEd:ZCONversion:PORT<n>:IMAG <value>

Applicable Models: All
(Read-Write) Sets and returns the Imaginary portion of the impedance value for the specified single-ended port. Use **CALC:FSIM:SEND:ZCON:PORT:REAL** to set the real value. Or use **CALC:FSIM:SEND:ZCON:PORT:Z0** to set both values together.

Note: This command affects ALL measurements on the specified channel.

Parameters

<cnun> **Channel number of the measurement. There must be a selected measurement on that channel. If unspecified, <cnun> is set to 1.**

<n> Port number to receive value.

<value> Imaginary impedance value. Choose a value between -1E18 and 1E18

Examples

```
CALC:FSIM:SEND:ZCON:PORT1:IMAG 75  
calculate2:fsimulator:sended:zconversion:port2:imag 150
```

Query Syntax **CALCulate<cnun>:FSIMulator:SENDEd:ZCONversion:PORT<n>:IMAG?**

Return Type Numeric

Default 0

CALCulate<cnun>:FSIMulator:SENDEd:ZCONversion:PORT<n>:REAL <value>

Applicable Models: All

(Read-Write) Sets and returns the Real portion of the impedance value for the specified single-ended port. Use **CALC:FSIM:SEND:ZCON:PORT:IMAG** to set the imaginary value. Or use **CALC:FSIM:SEND:ZCON:PORT:Z0** to set both values together.

Note: This command affects ALL measurements on the specified channel.

Parameters

<cnnum> Channel number of the measurement. There must be a selected measurement on that channel. If unspecified, <cnnum> is set to 1.

<n> Port number to receive value.

<value> Real Impedance value in ohms. Choose a value between 0 to 1E7

Examples

```
CALC:FSIM:SEND:ZCON:PORT1:REAL 51
calculate2:fsimulator:sended:zconversion:port2:real 75
```

Query Syntax **CALCulate<cnnum>:FSIMulator:SENDEd:ZCONversion:PORT<n>:REAL?**

Return Type Numeric

Default 50

CALCulate<cnnum>:FSIMulator:SENDEd:ZCONversion:PORT<n>:Z0[:R] <value>

Applicable Models: All

(Read-Write) Sets and returns the Real portion of the impedance value for the specified single-ended port. The imaginary portion is automatically set to 0.0.

To set both values separately, use **CALC:FSIM:SEND:ZCON:PORT:REAL** and **CALC:FSIM:SEND:ZCON:PORT:IMAG**.

Note: This command affects ALL measurements on the specified channel.

Parameters

<cnnum> Channel number of the measurement. There must be a selected measurement on that channel. If unspecified, <cnnum> is set to 1.

<n> Port number to receive value.

<value> Port Impedance value in ohms. Choose a value between 0 to 1E7

Examples

```
CALC:FSIM:SEND:ZCON:PORT1:Z0 51
calculate2:fsimulator:sended:zconversion:port2:z0:r 75
```

Query Syntax **CALCulate<cnnum>:FSIMulator:SENDEd:ZCONversion:PORT<n>:Z0[:R]?**

Return Type Numeric

Default 50

CALCulate<num>:FSIMulator:SENDEd:ZCONversion:STATe <bool>

Applicable Models: All

(Read-Write) Turns Port Impedance ON or OFF for all ports on the specified channel.

Note: This command affects ALL measurements on the specified channel.

Parameters

<num> Channel number of the measurement. There must be a selected measurement on that channel. If unspecified, <num> is set to 1.

<bool> Choose from:

ON or 1 - Turns Port Impedance ON
OFF or 0 - Turns Port Impedance OFF

Examples

```
CALC:FSIM:SEND:ZCON:STAT 1  
calculate2:fsimulator:sended:zconversion:state 0
```

Query Syntax **CALCulate<num>:FSIMulator:SENDEd:ZCONversion:STATe?**

Return Type Boolean

Default OFF

MarkerPNOP

Initiates a Power Normal Operating Point marker search and reads the results.

These commands are **Superseded** by the **CALCulate:MEASure:MARKer:PNOP** commands.

CALCulate:MARKer:PNOP

BACKoff

| GAIN?

| PIN?

| POUT?

COMPression?

| MAXimum?

GAIN?

| MAXimum?

PIN?

| MAXimum?

POFFset

POUT?

| MAXimum?

Click on a keyword to view the command details.

See Also

[PNOP Example](#)

[Learn about PNOP Markers](#)

[Other SCPI Marker commands](#)

[Synchronizing the Analyzer and Controller](#)

[SCPI Command Tree](#)

Critical Note: CALCulate commands act on the selected measurement. You can select one measurement for each channel using [Calc:Par:MNUM](#) or [Calc:Par>Select](#). [Learn more.](#)

CALCulate<cnum>:MARKer:PNOP:BACKoff <num>

Applicable Models: N522xB, N523xB, N524xB, M937xA, P937xA

(Read-Write) Turns on and sets markers 1, 2, 3, and 4 to calculate various PNOP parameters.

Either this command, or the **POFFset** command, will initiate the PNOP search markers.

To turn off the PNOP markers, either turn them off individually or turn them **All Off**.

To search a User Range with the PNOP search, first activate marker 1 and set the desired **User Range**. Then send CALC:MARK:PNOP:BACK. The user range used with the PNOP search only

applies to marker 1 searching for the linear gain value. The other markers may fall outside the user range.

[See Critical Note](#)

Parameters

<num> Channel number of the measurement. There must be a selected measurement on that channel. If unspecified, <num> is set to 1.

<num> Backoff value. Choose any number between :-500 and 500

Examples

```
CALC:MARK:PNOP:BACK?  
calculate2:marker:pnop:backoff 10
```

Query Syntax

CALCulate<num>:MARKer:PNOP:BACKoff?

Return Type

Numeric

[Default](#)

CALCulate<num>:MARKer:PNOP:BACKoff:GAIN?

Applicable Models: N522xB, N523xB, N524xB, M937xA, P937xA

(Read-only) Reads the power backoff gain value from a PNOP marker search.

PBO Gain = PBO Out - PBO In

Use **CALC:MARK:PNOP:BACK** or **CALC:MARK:PNOP:POFF** to initiate a PNOP search.

[See Critical Note](#)

Parameters

<num> Channel number of the measurement. There must be a selected measurement on that channel. If unspecified, <num> is set to 1.

Examples

```
CALC:MARK:PNOP:BACK:GAIN?
```

[Default](#)

Not applicable

CALCulate<num>:MARKer:PNOP:BACKoff:PIN?

Applicable Models: N522xB, N523xB, N524xB, M937xA, P937xA

(Read-only) Reads the power backoff input value from a PNOP marker search.

PBO In = Marker 2 X-axis

Use **CALC:MARK:PNOP:BACK** or **CALC:MARK:PNOP:POFF** to initiate a PNOP search.

[See Critical Note](#)

Parameters

<num> Channel number of the measurement. There must be a selected measurement on that channel. If unspecified, <num> is set to 1.

Examples

```
CALC : MARK : PNOP : BACK : PIN?
```

Default

Not applicable

CALCulate<num>:MARKer:PNOP:BACKoff:POUT?

Applicable Models: N522xB, N523xB, N524xB, M937xA, P937xA

(Read-only) Reads the power backoff output value from a PNOP marker search.

PBO Out = Marker 2 Y-axis

Use **CALC:MARK:PNOP:BACK** or **CALC:MARK:PNOP:POFF** to initiate a PNOP search.

See Critical Note

Parameters

<num> Channel number of the measurement. There must be a selected measurement on that channel. If unspecified, <num> is set to 1.

Examples

```
CALC : MARK : PNOP : BACK : POUT?
```

Default

Not applicable

CALCulate<num>:MARKer:PNOP:COMPression?

Applicable Models: N522xB, N523xB, N524xB, M937xA, P937xA

(Read-only) Reads the PNOP compression value from a PNOP marker search.

Pnop Comp = Pnop Gain - Linear Gain (not shown on marker readout).

Use **CALC:MARK:PNOP:BACK** or **CALC:MARK:PNOP:POFF** to initiate a PNOP search.

See Critical Note

Parameters

<num> Channel number of the measurement. There must be a selected measurement on that channel. If unspecified, <num> is set to 1.

Examples

```
CALC : MARK : PNOP : COMP?
```

Default

Not applicable

CALCulate<num>:MARKer:PNOP:COMPression:MAXimum?

Applicable Models: N522xB, N523xB, N524xB, M937xA, P937xA

(Read-only) Reads the max compression value from a PNOP marker search.

Comp Max = Gain Max - Linear Gain (not shown on marker readout).

Use **CALC:MARK:PNOP:BACK** or **CALC:MARK:PNOP:POFF** to initiate a PNOP search.

See Critical Note

Parameters

<cnm> Channel number of the measurement. There must be a selected measurement on that channel. If unspecified, <cnm> is set to 1.

Examples

```
CALC : MARK : PNOP : COMP : MAX?
```

Default

Not applicable

CALCulate<cnm>:MARKer:PNOP:GAIN?

Applicable Models: N522xB, N523xB, N524xB, M937xA, P937xA

(Read-only) Reads the PNOP gain value from a PNOP marker search.

PNop Gain = Pnop Out - Pnop In.

Use **CALC:MARK:PNOP:BACK** or **CALC:MARK:PNOP:POFF** to initiate a PNOP search.

See Critical Note

Parameters

<cnm> Channel number of the measurement. There must be a selected measurement on that channel. If unspecified, <cnm> is set to 1.

Examples

```
CALC : MARK : PNOP : GAIN?
```

Default

Not applicable

CALCulate<cnm>:MARKer:PNOP:GAIN:MAXimum?

Applicable Models: N522xB, N523xB, N524xB, M937xA, P937xA

(Read-only) Reads the max gain from a PNOP marker search.

Gain Max = PMax Out - PMax In

Use **CALC:MARK:PNOP:BACK** or **CALC:MARK:PNOP:POFF** to initiate a PNOP search.

See Critical Note

Parameters

<cnm> Channel number of the measurement. There must be a selected measurement on that channel. If unspecified, <cnm> is set to 1.

Examples

```
CALC : MARK : PNOP : GAIN : MAX?
```

Default

Not applicable

CALCulate<cnm>:MARKer:PNOP:PIN?

Applicable Models: N522xB, N523xB, N524xB, M937xA, P937xA

(Read-only) Reads the PNOP input value from a PNOP marker search.

Pnop In = Marker 4 X-axis value

Use **CALC:MARK:PNOP:BACK** or **CALC:MARK:PNOP:POFF** to initiate a PNOP search.

See Critical Note

Parameters

<cnm> Channel number of the measurement. There must be a selected measurement on that channel. If unspecified, <cnm> is set to 1.

Examples

```
CALC : MARK : PNOP : PIN ?
```

Default

Not applicable

CALCulate<cnm>:MARKer:PNOP:PIN:MAXimum?

Applicable Models: N522xB, N523xB, N524xB, M937xA, P937xA

(Read-only) Reads the max input power from a PNOP marker search.

PMax In = Marker 3 X-axis value

Use **CALC:MARK:PNOP:BACK** or **CALC:MARK:PNOP:POFF** to initiate a PNOP search.

See Critical Note

Parameters

<cnm> Channel number of the measurement. There must be a selected measurement on that channel. If unspecified, <cnm> is set to 1.

Examples

```
CALC : MARK : PNOP : PIN : MAX ?
```

Default

Not applicable

CALCulate<cnm>:MARKer:PNOP:POFFset <num>

Applicable Models: N522xB, N523xB, N524xB, M937xA, P937xA

(Read-Write) Turns on and sets markers 1, 2, 3, and 4 to calculate various PNOP parameters.

Either this command, or the **Backoff** command, will initiate the PNOP search markers.

To turn off the PNOP markers, either turn them off individually or turn them **All Off**.

To search a User Range with the PNOP search, first activate marker 1 and set the desired **User Range**. Then send the **CALC:MARK:PNOP:POFF** command. The user range used with the PNOP search only applies to marker 1 searching for the linear gain value. The other markers may fall outside the user range.

See Critical Note

Parameters

<cnm> Channel number of the measurement. There must be a selected measurement on that channel. If unspecified, <cnm> is set to 1.

<num> Power Offset value in dB. Choose any number between :-500 and 500

Examples

```
CALC:MARK:PNOP:POFF 3  
calculate2:marker:pnop:poffset 10
```

Query Syntax

CALCulate<cnum>:MARKer:PNOP:POFFset?

Return Type

Numeric

Default

??

CALCulate<cnum>:MARKer:PNOP:POUT?

Applicable Models: N522xB, N523xB, N524xB, M937xA, P937xA

(Read-only) Reads the output power value of the offset marker from a PNOP marker search.
Pnop Out = Marker 4 Y-axis value

Use **CALC:MARK:PNOP:BACK** or **CALC:MARK:PNOP:POFF** to initiate a PNOP search.
See Critical Note

Parameters

<cnum>

Channel number of the measurement. There must be a selected measurement on that channel. If unspecified, <cnum> is set to 1.

Examples

```
CALC:MARK:PNOP:POUT?
```

Default

Not applicable

CALCulate<cnum>:MARKer:PNOP:POUT:MAXimum?

Applicable Models: N522xB, N523xB, N524xB, M937xA, P937xA

(Read-only) Reads the max output power from a PNOP marker search.
PMax Out = Marker 3 Y-axis value

Use **CALC:MARK:PNOP:BACK** or **CALC:MARK:PNOP:POFF** to initiate a PNOP search.
See Critical Note

Parameters

<cnum>

Channel number of the measurement. There must be a selected measurement on that channel. If unspecified, <cnum> is set to 1.

Examples

```
CALC:MARK:PNOP:POUT:MAX?
```

Default

Not applicable

MarkerPSAT

Initiates a Power Saturation marker search and reads the results.

These commands are **Superseded** by the `CALCulate:MEASure:MARKer:PSAT` commands.

CALCulate:MARKer:PSATuration	
BACKoff	
COMPression	
MAXimum?	
SATuration?	
GAIN?	
LINear?	
MAXimum?	
PIN?	
MAXimum?	
POUT?	
MAXimum?	

Click on a keyword to view the command details.

See Also

- [PSAT Example](#)
- [Learn about PSAT Markers](#)
- [Other SCPI Marker commands](#)
- [Synchronizing the Analyzer and Controller](#)
- [SCPI Command Tree](#)

Critical Note: CALCulate commands act on the selected measurement. You can select one measurement for each channel using `Calc:Par:MNUM` or `Calc:Par>Select`. [Learn more](#).

CALCulate<num>:MARKer:PSATuration:BACKoff <num>

Applicable Models: N522xB, N523xB, N524xB, M937xA, P937xA
(Read-Write) Turns on and sets markers 1, 2, and 3 to calculate various Power Saturation parameters.

The <num> parameter sets and reads the back-off value for a Power Saturation marker search.

To turn off the Power Saturation markers, either turn them off individually or turn them All Off.

To search a User Range with the PSAT search, first activate marker 1 and set the desired **User Range**. Then send the CALC:MARK:PSAT:BACK command. The user range used with the PSAT search only applies to marker 1 searching for the linear gain value. The other markers may fall outside the user range.

See Critical Note

Parameters

<num> Channel number of the measurement. There must be a selected measurement on that channel. If unspecified, <num> is set to 1.

<num> Backoff value. Choose any number between :-500 and 500

Examples

```
CALC:MARK:PSAT:BACK 3
calculate2:marker:psaturation:backoff 10
```

Query Syntax CALCulate<num>:MARKer:PSATuration:BACKoff?

Return Type Numeric

Default 0

CALCulate<num>:MARKer:PSATuration:COMPression:MAXimum?

Applicable Models: N522xB, N523xB, N524xB, M937xA, P937xA

(Read-only) Reads the compression maximum value from a PSAT marker search.

Comp Max = Gain Max - Gain Linear

Use **CALC:MARK:PSAT:BACK** to initiate a PSAT search.

See Critical Note

Parameters

<num> Channel number of the measurement. There must be a selected measurement on that channel. If unspecified, <num> is set to 1.

Examples

```
CALC:MARK:PSAT:COMP:MAX?
```

Default Not applicable

CALCulate<num>:MARKer:PSATuration:COMPression:SATuration?

Applicable Models: N522xB, N523xB, N524xB, M937xA, P937xA

(Read-only) Reads the compression saturation value from a PSAT marker search.

Comp Sat = Gain Sat - Gain Linear

Use **CALC:MARK:PSAT:BACK** to initiate a PSAT search.

See Critical Note

Parameters

<num> Channel number of the measurement. There must be a selected measurement on that channel. If unspecified, <num> is set to 1.

Examples `CALC : MARK : PSAT : COMP : SAT ?`

Default Not applicable

CALCulate<num>:MARKer:PSATuration:GAIN?

Applicable Models: N522xB, N523xB, N524xB, M937xA, P937xA
(Read-only) Reads the saturation gain value from a PSAT marker search.
Gain Sat = Psat Out - Psat In
Use **CALC:MARK:PSAT:BACK** to initiate a PSAT search.
See Critical Note

Parameters

<num> Channel number of the measurement. There must be a selected measurement on that channel. If unspecified, <num> is set to 1.

Examples `CALC : MARK : PSAT : GAIN ?`

Default Not applicable

CALCulate<num>:MARKer:PSATuration:GAIN:LINear?

Applicable Models: N522xB, N523xB, N524xB, M937xA, P937xA
(Read-only) Reads the linear gain value from a PSAT marker search.
Gain Linear = Marker 1 - Y-axis value MINUS X-axis value.
Use **CALC:MARK:PSAT:BACK** to initiate a PSAT search.
See Critical Note

Parameters

<num> Channel number of the measurement. There must be a selected measurement on that channel. If unspecified, <num> is set to 1.

Examples `CALC : MARK : PSAT : GAIN : LIN ?`

Default Not applicable

CALCulate<num>:MARKer:PSATuration:GAIN:MAXimum?

Applicable Models: N522xB, N523xB, N524xB, M937xA, P937xA
(Read-only) Reads the maximum gain value from a PSAT marker search.
Gain Max = PMax Out - PMax In
Use **CALC:MARK:PSAT:BACK** to initiate a PSAT search.
See Critical Note

Parameters

<cnm> Channel number of the measurement. There must be a selected measurement on that channel. If unspecified, <cnm> is set to 1.

Examples `CALC:MARK:PSAT:GAIN:MAX?`

Default Not applicable

CALCulate<cnm>:MARKer:PSATuration:PIN?

Applicable Models: N522xB, N523xB, N524xB, M937xA, P937xA
(Read-only) Reads the power saturation input value from a PSAT marker search.
Psat In = Marker 2 X-axis value
Use **CALC:MARK:PSAT:BACK** to initiate a PSAT search.
See Critical Note

Parameters

<cnm> Channel number of the measurement. There must be a selected measurement on that channel. If unspecified, <cnm> is set to 1.

Examples `CALC:MARK:PSAT:PIN?`

Default Not applicable

CALCulate<cnm>:MARKer:PSATuration:PIN:MAXimum?

Applicable Models: N522xB, N523xB, N524xB, M937xA, P937xA
(Read-only) Reads the maximum input power from a PSAT marker search.
PMax In = Marker 3 X-axis value
Use **CALC:MARK:PSAT:BACK** to initiate a PSAT search.
See Critical Note

Parameters

<cnm> Channel number of the measurement. There must be a selected measurement on that channel. If unspecified, <cnm> is set to 1.

Examples `CALC:MARK:PSAT:PIN:MAX?`

Default Not applicable

CALCulate<cnUm>:MARKer:PSATuration:POUT?

Applicable Models: N522xB, N523xB, N524xB, M937xA, P937xA

(Read-only) Reads the back-off output power from a PSAT marker search.

PSat Out = Marker 2 Y-axis value

Use **CALC:MARK:PSAT:BACK** to initiate a PSAT search.

See Critical Note

Parameters

<cnUm> Channel number of the measurement. There must be a selected measurement on that channel. If unspecified, <cnUm> is set to 1.

Examples `CALC:MARK:PSAT:POUT?`

Default Not applicable

CALCulate<cnUm>:MARKer:PSATuration:POUT:MAXimum?

Applicable Models: N522xB, N523xB, N524xB, M937xA, P937xA

(Read-only) Reads the back-off output power from a PSAT marker search.

PMaxOut = Marker 3 Y-axis value

Use **CALC:MARK:PSAT:BACK** to initiate a PSAT search.

See Critical Note

Parameters

<cnUm> Channel number of the measurement. There must be a selected measurement on that channel. If unspecified, <cnUm> is set to 1.

Examples `CALC:MARK:PSAT:POUT:MAX?`

Default Not applicable

Control SCPI

Specifies the settings to remotely control the Auxilliary IO connector.

Note: The PNA-X, N522xA and N523xA models do NOT have this connector. However, the following commands are used to control ADC voltages on the Power I/O connector: `CONT:AUX:OUTP:VOLT` and `CONT:AUX:INPut:VOLT?`. Sending other Control:AUX commands may result in unusual behavior.

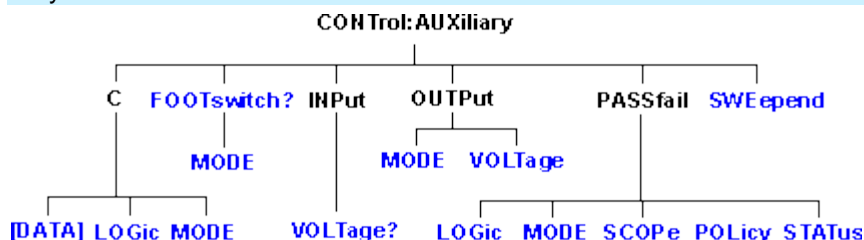

Click on a [blue](#) keyword to view the command details.

see **Also**

[Example Programs](#)

[Synchronizing the Analyzer and Controller](#)

[SCPI Command Tree](#)

See a pinout and detailed description of the Power I/O Connector

CONTrol:AUXiliary:C[:DATA] <num>

Applicable Models: N522xB, N523xB, N524xB

(Read-Write) Reads and writes a 4-bit value to Port C on the Aux I/O connector. This port is connected internally to the Handler IO connector. Therefore this command will also affect the state of Port C on the Handler IO

Parameters

<num> Data value. Choose any number 0 to 15.

Examples

```
CONTrol:AUXiliary:C:DATA 15
```

For Positive Logic Port C lines C0, C1, C2, C3 go High or if in Negative Logic they go Low.

```
CONTrol:AUXiliary:C:DATA?
```

A returned value of 15 when in Positive Logic indicates Port C lines C0, C1, C2, C3 are High, or if in Negative Logic they are Low.

Query Syntax

```
CONTrol:AUXiliary:C:DATA?
```

Return Type Numeric

Default 0

CONTrol:AUXiliary:C:LOGic <char>

Applicable Models: N522xB, N523xB, N524xB

(Read-Write) Reads and writes the logic mode of Port C on the AUX IO. This port is connected to Port C of the Handler IO connector. Therefore, it will have the same logic setting.

Parameters

<char> Logic of Port C. Choose from:

POSitive - when a value of one is written the associate line goes High.

NEGative - when a value of one is written the associate line goes Low.

When Port C is in Output/Write mode, a change in logic causes the output lines to change state immediately. For example, Low levels change to High levels.

When Port C is in Input/Read mode, a change in logic does NOT cause the lines to change, but data read from Port C will reflect the change in logic.

Examples `CONT:AUX:C:LOG POS 'Positive logic is applied to Port C data.`

Query Syntax `CONTrol:AUXiliary:C:LOGic?`

Return Type Character

Default NEGative

CONTrol:AUXiliary:C:MODE <char>

Applicable Models: N522xB, N523xB, N524xB

(Read-Write) Sets Port C to read or write mode. This port is connected to Port C of the Handler IO connector. Therefore, it will have the same mode setting.

NOTE: When Port C is set to INPut mode, data writes are NOT applied to the lines. MODE must be set to OUTPut mode before writing.

Parameters

<char> **INPut** - set the port for reading
OUTPut - set the port for writing

Examples

```
CONT:AUX:C:MOD INP 'set Port C to Input Mode for reading.  
CONTrol:AUXiliary:C:MODE? 'queries the input/output mode that the port set to.
```

Query Syntax

CONTrol:AUXiliary:C:MODE?

Return Type Character

Default INPut

CONTrol:AUXiliary:FOOTswitch[:STATe]?

Applicable Models: N522xB, N523xB, N524xB

(Read only) Reads the Auxiliary connector Footswitch Input.

Examples

```
CONT:AUX:FOOT?  
control:auxiliary:footswitch:state?
```

Return Type

Boolean
ON (or 1) = pressed
OFF (or 0) = released

Default OFF (0) - Released

CONTrol:AUXiliary:FOOTswitch:MODE <char>

Applicable Models: N522xB, N523xB, N524xB

(Read-Write) This command sets the mode of the "FootSwitch In" line on the Auxiliary IO. These mode settings determine what occurs when the footswitch is pressed. Examine your results carefully when using these command modes.

Parameters

<char> **IGNore** - While in this mode any Footswitch presses are ignored.

SWEep - While in this mode a Footswitch press will trigger the sweep.

NOTE: The instrument must be in Manual Trigger Mode.

RECall - While in this mode a Footswitch press will recall an instrument state. When more than one state is available each footswitch press recalls the next state, then starts over from the beginning.

MACRo - While in this mode a Footswitch press will load and run a macro. When more than one macro are available each successive footswitch press loads and runs the next macro, then starts over from the beginning.

Examples

`CONT:AUX:FOOT:MODE MACRo` This sets the footswitch mode to `MACRo` causing a macro to be loaded and run with a footswitch press.

`CONTrol:AUXiliary:FOOTswitch:MODE?` This query returns the footswitch mode setting.

Query Syntax

`CONTrol:AUXiliary:FOOTswitch:MODE?`

Return Type Character

Default IGNore

`CONTrol:AUXiliary:INPut<n>:VOLTage?`

Applicable Models: N522xB, N523xB, N524xB

(Read-Only)

Reads voltage on the Power I/O connector.

From the Control:Aux commands, ONLY this and `CONT:AUX:OUTP:VOLT` can be used on the PNA-X.

Parameters

<n> Port number. If unspecified, value is set to 1.

Choose from

- 1 Reads voltage on the AUX I/O connector (pin 14) or on the Power I/O connector Analog In 1 port (pin 7).
- 2 Reads voltage on the Power I/O connector Analog In 2 port (pin 8).
- 3 Reads voltage on Power I/O connector GndSens (pin 6) PNA-X only.

Examples

```
CONT:AUX:INPut2:VOLT?
control:auxiliary:input:voltage?
```

Return Type

Numeric

Default

Not Applicable

CONTrol:AUXiliary:OUTPut<n>:MODE <char>

Applicable Models: N522xB, N523xB, N524xB

(Read-Write) This command sets the mode of the selected "Analog Out" line on the Power I/O connector. The modes give the user the option to have the requested voltage applied immediately or not until the sweep is done.

Parameters

<n> Port number. If unspecified, value is set to 1.

<char> **WAIT** - While in this mode any voltage changes sent to the selected analog out will only get applied to the output between sweeps.

NOWait - While in this mode any voltage changes sent to the selected analog out will occur right away without waiting until the end of a sweep.

Examples

```
CONT:AUX:OUTP1:MOD WAIT This sets the mode so that
voltages sent to "Analog Out 1" are only applied at the
end of a sweep.
```

```
CONT:AUX:OUTP2:MOD? This query returns the current mode
for "Analog Out 2".
```

Query Syntax

CONTrol:AUXiliary:OUTPut2:MODE?

'Reads the output mode

Return Type

Character

Default

WAIT

CONTROL:AUXiliary:OUTPut<out>:VOLTage <num>

Applicable Models: N522xB, N523xB, N524xB

(Read-Write)

Sets and reads voltage on the Power I/O connector AnalogOut1|2.

From the Control:Aux commands, ONLY this and **CONT:AUX:INPut:VOLT?** can be used.

Parameters

<out> DAC output number. Choose from:
1 - Output 1 (Aux I/O pin 3) and (Power I/O pin 3)
2 - Output 2 (Aux I/O pin 2) and (Power I/O pin 4)

<num> Output Voltage. Choose a voltage value between **-10** and **+10** volts

Examples

```
CONT:AUX:OUTP1:VOLT 5  
control:auxiliary:output2:voltage 5
```

Query Syntax

CONTROL:AUXiliary:OUTPut<out>:VOLTage?
'Reads the output DAC voltage

Return Type Numeric

Default 0

CONTROL:AUXiliary:PASSfail:LOGic <char>

Applicable Models: N522xB, N523xB, N524xB

(Read-Write) Sets the logic of the PassFail line (pin 12) on the Material Handler IO (pin 33).

Parameters

<char> Choose from:
POSitive - Causes the PassFail line to have positive logic (high = pass, low = fail).
NEGative - Causes the PassFail line to have negative logic (high = fail, low = pass).

Examples	<code>CONT:AUX:PASS:LOG POS</code> <code>control:auxiliary:passfail:logic negative</code>
Query Syntax	<code>CONTrol:AUXiliary:PASSfail:LOGic?</code>
Return Type	Character
Default	POSitive

CONTrol:AUXiliary:PASSfail:MODE <char>

Applicable Models: N522xB, N523xB, N524xB

(Read-Write) Sets and reads the default logical pass/fail state. This is the state the pass/fail line stays in until a failure occurs (if the mode is NOWait), or until an end-of-sweep condition occurs (if the modes is PASS or FAIL).

The end-of-sweep condition is determined by the `CONTrol:AUXiliary:PASSfail:SCOPE` command.

Parameters

<char>	Choose from: PASS - the line stays in PASS state until the end-of-sweep condition occurs, at which time the pass/fail line is set, and the pass/fail strobe (line 36) is activated. FAIL - the line stays in FAIL state until the end-of-sweep condition occurs, at which time the pass/fail line is set, and the pass/fail strobe (line 36) is activated. NOWait - the pass/fail line is set, and the pass/fail strobe (line 36) is activated as soon as a failure condition occurs.
--------	---

Examples	<code>CONT:AUX:PASS:MODE NOW</code> <code>control:auxiliary:passfail:mode fail</code>
Query Syntax	<code>CONTrol:AUXiliary:PASSfail:MODE?</code>
Return Type	Character
Default	NOWait

CONTrol:AUXiliary:PASSfail:SCOPE <char>

Applicable Models: N522xB, N523xB, N524xB

(Read-Write) Sets and reads the scope of pass/fail testing. The pass/fail line can report the status of all measurements on each channel, or all measurements on all channels. This command selects which option to use.

Parameters

<char>

Choose from:

CHANnel - A pass/fail result is computed and written to the output pins at the end of all sweeps on a channel.

GLOBal - A pass/fail result is computed and written to the output pins at the end of all sweeps on a channel.

If the pass/fail mode is NOWait (as set by **CONTRol:AUXiliary:PASSfail:MODE**), the status and strobe pins are written immediately. Otherwise the pins are written as indicated above. Regardless of the mode value, the pass/fail line is returned to its default state (as set by the MODE command) at the end of channel or group of channels.

Examples

```
CONT:AUX:PASS:SCOP CHAN
control:auxiliary:passfail:scope sweep
```

Query Syntax

```
CONTRol:AUXiliary:PASSfail:SCOPE?
```

Return Type

Character

Default

GLOBal

CONTRol:AUXiliary:PASSfail:POLicy <char>

Applicable Models: N522xB, N523xB, N524xB

(Read-Write) Sets the policy used to determine how global pass/fail is computed.

Parameters

<char>

Name of the policy to use. Choose from:

ALLTests - **Pass/Fail Status** returns PASS if all tests on all measurements pass.

ALLMeas - **Pass/Fail Status** returns PASS if all measurements have associated tests, and all tests pass. FAIL is returned if even one measurement has no associated limit test.

Only those measurements which are not in HOLD mode contribute to the pass/fail result.

Examples	<code>CONT:AUX:PASS:POL ALLM control:auxiliary:passfail:policy alltests</code>
Query Syntax	<code>CONTrol:AUXiliary:PASSfail:POLicy?</code>
Return Type	Character
Default	ALLTests

CONTrol:AUXiliary:PASSfail:STATus?

Applicable Models: N522xB, N523xB, N524xB

(Read-Only) Returns the most recent pass/fail status value. Use this command as follows:

Set the VNA **trigger scope** to ALL

Set the VNA **trigger source** to MANUAL or EXTERNAL.

Trigger the VNA.

Use the ***OPC?** command to determine when the sweep is complete.

Use the `CONT:AUX:PASS:STAT?` query to obtain the global pass/fail result.

Return Type	<p>Character - One of the following is returned:</p> <p>PASS - all measurements not in HOLD mode have been swept, and all associated limit tests have passed.</p> <p>FAIL - all measurements not in HOLD mode have been swept, and one or more limit tests failed according to the specified Pass/Fail policy.</p> <p>NONE - status cannot be determined because measurements are in progress.</p>
--------------------	--

Default Not Applicable

CONTrol:AUXiliary:SWEepend <char>

Applicable Models: N522xB, N523xB, N524xB

(Read-Write) Specifies the event that will cause the Sweep End line (pin 11) to go to a low (false) state of the Material Handler IO. The line will return to a high state after the appropriate calculations are complete.

Parameters

<char>

Choose from:

SWEep - the line goes low when each sweep is complete.

CHANnel - The line goes low when all of the sweeps for each channel is complete.

GLOBal - The line goes low when all the sweeps for all channels are complete.

Examples

```
CONT:AUX:SWE SWE  
control:auxiliary:sweepend channel
```

Query Syntax

```
CONTROL:AUXiliary:SWEEPend?
```

Return Type

Character

Default

SWEep

Control SCPI

Specifies the settings to remotely control the External Test Set IO connector.

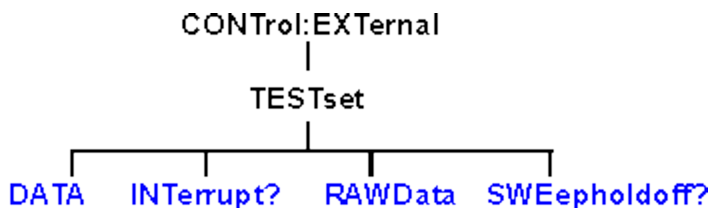

Click on a [blue](#) keyword to view the command details.

see Also

[Example Programs](#)

[Synchronizing the Analyzer and Controller](#)

[SCPI Command Tree](#)

[See a pinout and detailed description of the External Test Set IO connector](#)

CONTROL:EXTernal:TESTset:DATA <addr>,<data>

Applicable Models: N522xB, N523xB, N524xB

(Read-Write) Reads and writes 13 bits of data to the specified address using the AD0 through AD12 lines of the external test set connector. The instrument generates the appropriate timing signals (strokes the address, then the data) to control an external test set.

Parameters

<addr> Decimal equivalent of the 13 bit binary address.

<data> Decimal equivalent of the 13 bit binary data

Examples

```
CONT:EXT:TEST:DATA 12,3
CONTROL:external:testset:data 12,3
```

Query Syntax

CONTROL:EXTernal:TESTset:DATA? <addr>
'Reads the decimal equivalent of the binary data from the specified address

Return Type

Numeric

Default Not Applicable

CONTROL:EXTernal:TESTset:INTerrupt?

Applicable Models: N522xB, N523xB, N524xB

(Read-Only) Reads the boolean state of the Interrupt In line (pin 13) on the external test set connector.

Examples

```
CONT:EXT:TEST:INT?
control:external:testset:interrupt?
```

Return Type

Boolean

False (0) - the line is being held at a TTL High.

True (1) - the line is being held at a TTL Low.

Default

Not Applicable

CONTrol:EXTernal:TESTset:RAWData <data>

Applicable Models: N522xB, N523xB, N524xB

(Read-Write) Reads and writes 16 bits of data through the AD0 through AD12 and three timing lines of the external test set connector. Does NOT generate appropriate timing signals.

Use of this command requires detailed knowledge of all 16 bits. Refer to the Data format table.

Note: During a WRITE, Bit 13 must always be low. Otherwise Bit 0-12 will tristate

Parameters

<data>	Decimal equivalent of the binary data.		
	Format of data WRITTEN with RAWData:		
	Pin	Bit	Signal name
	22	0	AD0*
	23	1	AD1*
	11	2	AD2*
	10	3	AD3*
	9	4	AD4*
	21	5	AD5*
	20	6	AD6*
	19	7	AD7*
	6	8	AD8*
	5	9	AD9*
	4	10	AD10*

17	11	AD11*
3	12	AD12*
25	13	RLW
24	14	LDS
8	15	LAS

* This Output will float if RLW (bit-13) is set high

Examples

```
CONT:EXT:TEST:RAWD 8001
CONTrol:external:testset:rawdata 1234
```

Query Syntax

CONTrol:EXTernal:TESTset:RAWDData?

Return Format

Format of data **READ** with RAWData?

Pin	Bit	Signal name
22	0	AD0*
23	1	AD1*
11	2	AD2*
10	3	AD3*
9	4	AD4*
21	5	AD5*
20	6	AD6*
19	7	AD7*
6	8	AD8*
5	9	AD9*
4	10	AD10*
17	11	AD11*
3	12	AD12*
2	13	Sweep Holdoff In
13	14	Interrupt In (inverted internally)
na	15	Always Zero, grounded internally

*These lines are dependent on the state of RLW (pin25).
Writing a 0(low) to RLW will set lines AD0-AD12 to write mode.
Writing a 1(high) to RLW will set lines AD0-AD12 to read mode.

Default Not Applicable

CONTROL:EXTERNAL:TESTset:SWEepholdoff?

Applicable Models: N522xB, N523xB, N524xB

(Read-Only) Reads the Sweep Holdoff line (pin 2) on the external test set connector.

Examples

```
CONT:EXT:TEST:SWE?  
control:external:testset:sweepholdoff?
```

Return Type Boolean

TRUE (1) - the pin is set to a TTL High

FALSE (0) - the pin is set to TTL Low

Default Not Applicable

Control SCPI

Specifies the settings to remotely control the Material Handler IO connector.

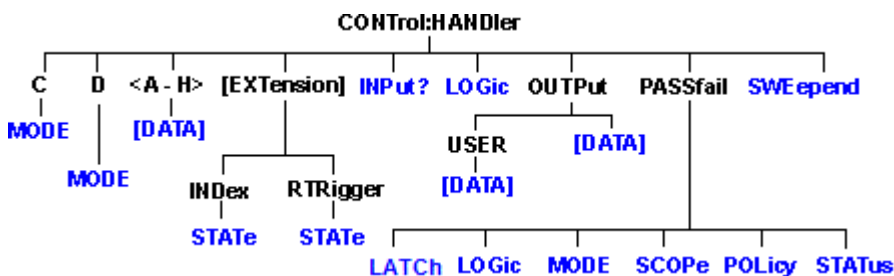

Click on a [blue](#) keyword to view the command details.

see Also

[Example Programs](#)

[Synchronizing the Analyzer and Controller](#)

[SCPI Command Tree](#)

Learn about the [Material Handler IO port](#).

CONTROL:HANDler:C:MODE <char>

Applicable Models: N522xB, N523xB, N524xB, E5080, All PXIe VNAs with M9341A/B

(Read-Write) Sets and reads the direction of data flow for Port C.

Parameters

<char>

Direction of flow. Choose from:

INPut - Port C is used to input data

OUTPut - Port C is used to output data

Examples

```

CONT:HAND:C:MODE INP
control:handler:c:mode output
  
```

Query

CONTROL:HANDler:C:MODE?

Syntax

Return Type Character

Default

INPut

CONTROL:HANDler:D:MODE <char>

Applicable Models: N522xB, N523xB, N524xB, E5080, All PXIe VNAs with M9341A/B

(Read-Write) Sets and reads the direction of data flow for Port D.

Parameters

<char> **Direction of flow. Choose from:**
INPut - Port D is used to input data
OUTPut - Port D is used to output data

Examples

```
CONT:HAND:D:MODE INP
control:handler:d:mode output
```

Query Syntax

CONTROL:HANDler:D:MODE?

Return Type Character

Default Input

CONTROL:HANDler:<port>[:DATAa] <num>

Applicable Models: N522xB, N523xB, N524xB, E5080, All PXIe VNAs with M9341A/B

(Read-Write) Writes and reads data on the specified port.

Parameters

<port> Port identifier to set bits for. Choose from:
A,B,C,D,E,F,G,H

<num> **The number of the data bits to set. Refer to the following table for the maximum number for each port. The minimum number for each port is 0.**

Port	Max allowable <num>	MSB.....LSB 23.....0	
A	255	A7...A0	Write-only
B	255	B7...B0	Write-only

C	15	C3...C0	Read-Write
D	15	D3...D0	Read-Write
E	255	D3...D0 + C3...C0	Read-Write
F	65535	B7...B0 + A7...A0	Write-only
G	1048575	C3...C0 + B7...B0 + A7...A0	Write-only
H	16777215	D3...D0 + C3...C0 + B7...B0 + A7...A0	Write-only

Note: When writing to port G, port C must be set to output mode
When writing to port H, both port C and port D must be set to output mode.
Use **CONT:HAND:C:MODE OUTP** and **CONT:HAND:D:MODE OUTP**

Examples

```
CONT:HAND:A 254
control:handler:c:data 12
```

Query Syntax

CONTROL:HANDler:<port>:DATA?

Return Type Numeric

Default Not Applicable

CONTROL:HANDler[:EXTension]:INDex[:STATe] <bool>

Applicable Models: N522xB, N523xB, N524xB, E5080, All PXIe VNAs with M9341A/B

(Read-Write) Determines the control of **Material Handler connector** Pin 20. A "Mnemonic not implemented" error is returned if the VNA does NOT have this capability.

Parameters

<bool>

Choose from:
ON (1) - Pin 20 is controlled by the Index signal
OFF (0) - Pin 20 is controlled by Output Port B6

Examples

```
CONT:HAND:IND 1
control:handler:extension:index:state off
```

Query Syntax **CONTROL:HANDler[:EXTension]:INDEX[:STATe]?**

Return Type Boolean

Default OFF

CONTROL:HANDler[:EXTension]:RTRigger[:STATe] <bool>

Applicable Models: N522xB, N523xB, N524xB, E5080, All PXIe VNAs with M9341A/B

(Read-Write) Determines the control of **Material Handler connector** Pin 21. A "Mnemonic not implemented" error is returned if the VNA does NOT have this capability.

Parameters

<bool> Choose from:
ON (1) - Pin 21 is controlled by the Ready for Trigger signal
OFF (0) - Pin 21 is controlled by Output Port B7

Examples `CONT:HAND:RTR 1`
`control:handler:extension:rtrigger:state off`

Query Syntax **CONTROL:HANDler[:EXTension]:RTRigger[:STATe]?**

Return Type Boolean

Default OFF

CONTROL:HANDler:INPut?

Applicable Models: N522xB, N523xB, N524xB, E5080, M9485A, All PXIe VNAs with M9341A/B

(Read-Only) Reads a hardware latch that captures high to low transitions on Input1 of the Material Handler IO. Reading the latch causes it to reset and is ready for the next transition. The hardware latch is only capable of capturing one transition per query. Additional transitions are ignored until after the next query.

Momentarily driving Input1 high, then low, will cause a transition to be detected and latched.

Examples `CONT:HAND:INP?`
`control:handler:input?`

Return Type Integer - Returns a value of zero or one.
0 - No transition detected since last query.
1 - Transition detected.

Default Not Applicable

CONTROL:HANDLER:LOGIC <char>

Applicable Models: N522xB, N523xB, N524xB, E5080

(Read-Write) Sets the logic of the Data ports A-H on the Handler connector. Some of these lines are connected internally to the AuxIO. The M9341/B does not support this function.

Parameters

<char> Choose from:
POSitive- Causes the Port lines to have positive logic (high = 1, low = 0).
NEGative- Causes the Port lines to have negative logic (high = 0, low = 1).

For ports that are in output (write) mode, a change in logic causes the output lines to change state immediately. For example, Low levels change immediately to High levels.

For ports that are in input (read) mode (C,D,E only), a change in logic will be reflected when data is read from that port. For example, if a line read 0, the next read after a logic change will read 1.

Examples

```
CONT:HAND:LOG POS
control:handler:logic negative
```

Query Syntax

CONTROL:HANDLER:LOGIC?

Return Type Character

Default NEGative

CONTROL:HANDLER:OUTPUT<port>[:DATA] <num>

Applicable Models: N522xB, N523xB, N524xB, E5080, All PXIe VNAs with M9341A/B

(Read-Write) Sets or reads the specified output line.

Query Syntax **CONTROL:HANDler:OUTPut<num>:USER:DATA?**

Return Type Boolean

Default 0 - Low

CONTROL:HANDler:PASSfail:LATCh <bool>

Applicable Models: E5080,

(Read-Write) Enable the compatible mode with the E5071C for pass/fail status. If this is enabled, the pass/fail result of the Material Handler IO (pin33) is kept until next measurement . The default pass/fail state set is defined by CONTROL:HANDler:PASSfail:MODE <char>, and this function woks independently from the command “CONTROL:HANDler:PASSfail:MODE <char>”. This mode does not provide full compatibility with the E5071C in the timing chart perspective.

Parameters

<char> Choose from:
OFF (0)- Off.
ON (1)- Enable Pass/Fail line latch mode. E5071C compatible.

Examples

```
CONT:HAND:PASS:LATC 1
control:handler:passfail:latch on
```

Query Syntax **CONTROL:HANDler:PASSfail:LATCh?**

Return Type Boolean

Default OFF (0)

CONTROL:HANDler:PASSfail:LOGic <char>

Applicable Models: N522xB, N523xB, N524xB, E5080, All PXIe VNAs with M9341A/B

(Read-Write) Sets the logic of the PassFail line of the Material Handler IO (pin 33).

Parameters

<char> Choose from:
POSitive- Causes the PassFail line to have positive logic (high = pass, low = fail).

NEGative- Causes the PassFail line to have negative logic (high = fail, low = pass).

Examples

```
CONT:HAND:PASS:LOG POS
control:handler:passfail:logic negative
```

Query Syntax

```
CONTrol:HANDler:PASSfail:LOGic?
```

Return Type Character

Default

POSitive

CONTrol:HANDler:PASSfail:MODE <char>

Applicable Models: N522xB, N523xB, N524xB, E5080, All PXIe VNAs with M9341A/B

(Read-Write) Sets and reads the default logical pass/fail state. This is the state the pass/fail line stays in until a failure occurs (if the mode is NOWait), or until an end-of-sweep condition occurs (if the mode is PASS or FAIL).

The end-of-sweep condition is determined by the **CONTrol:HANDler:PASSfail:SCOPE** command.

Parameters

<char>

Choose from:

PASS- the line stays in PASS state until the end-of-sweep condition occurs, at which time the pass/fail line is set, and the pass/fail strobe (line 36) is activated.

FAIL- the line stays in FAIL state until the end-of-sweep condition occurs, at which time the pass/fail line is set, and the pass/fail strobe (line 36) is activated.

NOWait- the pass/fail line is set, and the pass/fail strobe (line 36) is activated as soon as a failure condition occurs.

Examples

```
CONT:HAND:PASS:MODE NOW
control:handler:passfail:mode fail
```

Query Syntax

```
CONTrol:HANDler:PASSfail:MODE?
```

Return Type Character

Default

NOWait

CONTRol:HANDler:PASSfail:SCOPE <char>

Applicable Models: N522xB, N523xB, N524xB, E5080, All PXIe VNAs with M9341A/B

(Read-Write) Sets and reads the scope of pass/fail testing. The pass/fail line on the material handler port can report the status of all measurements on each channel, or all measurements on all channels. This command selects which option to use.

Parameters

<char> Choose from:

CHANnel - A pass/fail result is computed and written to the output pins at the end of all sweeps on a channel.

GLOBal - A pass/fail result is computed and written to the output pins at the end of all sweeps on a channel.

If the pass/fail mode is NOWait (as set by **CONTRol:HANDler:PASSfail:MODE**), the status and strobe pins are written immediately. Otherwise the pins are written as indicated above. Regardless of the mode value, the pass/fail line is returned to its default state (as set by the MODE command) at the end of channel or group of channels.

Examples

```
CONT:HAND:PASS:SCOP CHAN
control:handler:passfail:scope sweep
```

Query Syntax

```
CONTRol:HANDler:PASSfail:SCOPE?
```

Return Type Character

Default GLOBal

CONTRol:HANDler:PASSfail:POLIcy <char>

Applicable Models: N522xB, N523xB, N524xB, E5080, All PXIe VNAs with M9341A/B

(Read-Write) Sets the policy used to determine how global pass/fail is computed.

Parameters

<char> Name of the policy to use. Choose from:

ALLTests - **Pass/Fail Status** returns PASS if all tests on all measurements pass.

ALLMeas - **Pass/Fail Status** returns PASS if all measurements have associated tests, and all tests pass. FAIL is returned if even one measurement has no associated limit test.

Only those measurements which are not in HOLD mode contribute to the pass/fail result.

Examples

```
CONT:HAND:PASS:POL
control:handler:passfail:policy
```

Query Syntax

CONTROL:HANDler:PASSfail:POLicy?

Return Type Character

Default ALLTests

CONTROL:HANDler:PASSfail:STATus?

Applicable Models: N522xB, N523xB, N524xB, E5080, M9485A, All PXIe VNAs with M9341A/B

(Read-Only) Returns the most recent pass/fail status value. Use this command as follows:

Set the VNA trigger scope to GLOBAL

Set the VNA trigger source to MANUAL or EXTERNAL.

Configure and enable **Limit Testing**.

Trigger the VNA.

Use the *OPC? command to determine when the sweep is complete.

Use the CONT:HAND:PASS:STAT? query to obtain the global pass/fail result.

Return Type Character - One of the following is returned:

PASS - all measurements not in HOLD mode have been swept, and all associated limit tests have passed.

FAIL - all measurements not in HOLD mode have been swept, and one or more limit tests failed according to the specified Pass/Fail policy.

NONE - status cannot be determined because measurements are in progress.

Default Not Applicable

CONTrol:HANDler:SWEpend <char>

Applicable Models: N522xB, N523xB, N524xB, E5080, All PXIe VNAs with M9341A/B

(Read-Write) Specifies the event that will cause the Handler Sweep End line to strobe. The strobe is at least 10µs in duration, and is activated when all calculations for the associated measurement are complete. This line is connected internally to the Sweep End line of the AUX IO connector.

Parameters

<char>

Choose from:

SWEep - the line goes low when **each sweep** is complete
CHANnel - the line goes low when **all the sweeps for each channel** is complete.
GLOBal - the line goes low when **all sweeps for all channels** are complete.
The default state of the passFail line (before a measurement occurs) and after a failure occurs is set by **CONTrol:HANDler:PASSfail:MODE**

Examples

```
CONT:HAND:SWE SWE  
control:handler:sweepend channel
```

Query Syntax

CONTrol:HANDler:SWEpend?

Return Type Character

Default GLOBal

Display Colors

Controls the color settings of the VNA display.

DISPlay:COLor
ABACkground
BACKground
GRAT1
GRAT2
ILABel
LIM1
LOAD
RESet
STORe
TRACe
DATA
MARKer
MEMory
MMARker

Click on a keyword to view the command details.

see Also

[Synchronizing the Analyzer and Controller](#)

[Learn about Display and Print Colors](#)

[SCPI Command Tree](#)

DISPlay:COLor<n>:ABACkground <num, num, num>

Applicable Models: All

(Read-Write) Set and return the background color for the active window on the VNA display or hardcopy print.

Parameters

<n> Colors to modify. Choose from:
 1 - Display colors
 2 - Print colors
 If unspecified, <n> is set to 1 (Display colors).

<num, num, num> Numeric. Red, Green, and Blue (RGB values) that specify a color.
 To find RGB values: from the **Display Colors dialog**, click Change Color, then Define Custom Color.

Examples `DISP:COL:ABAC 10,10,10`
`display:color1:abackground 80,80,80`

Query Syntax `DISPlay:COLor<n>:ABACKground?`

Return Type Numeric (n,n,n)

Default Display = 0,0,24 (Black)
 Print = 255,255,255 (White)

DISPlay:COLor<n>:BACKground <num, num, num>

Applicable Models: All

(Read-Write) Set and return the background color for the inactive windows on the VNA display or hardcopy print.

Parameters

<n> Colors to modify. Choose from:
 1 - Display colors
 2 - Print colors
 If unspecified, <n> is set to 1 (Display colors).

<num, num, num> Numeric. Red, Green, and Blue (RGB values) that specify a color.
 To find RGB values: from the **Display Colors dialog**, click Change Color, then Define Custom Color.

Examples `DISP:COL:BACK 10,10,10`
`display:color1:background 80,80,80`

Query Syntax `DISPlay:COLor<n>:BACKground?`

Return Type Numeric (n,n,n)

Default Display = 0,0,0 (Black)
 Print = 255,255,255 (White)

DISPlay:COLor<n>:GRAT1 <num, num, num>

Applicable Models: All

(Read-Write) Set and return the labels and grid frame colors in the active window for the VNA display or hardcopy print. (Active labels, Grid frame)

Parameters

<n> Colors to modify. Choose from:
1 - Display colors
2 - Print colors
If unspecified, <n> is set to 1 (Display colors).

<num, num, num> Numeric. Red, Green, and Blue (RGB values) that specify a color.
To find RGB values: from the **Display Colors dialog**, click Change Color, then Define Custom Color.

Examples

```
DISP:COL:GRAT1 10,10,10  
display:color1:grat1 80,80,80
```

Query Syntax

DISPlay:COLor<n>:GRAT1?

Return Type

Numeric (n,n,n)

Default

Display = 175,175,175
Print = 0,0,0 (Black)

DISPlay:COLor<n>:GRAT2 <num, num, num>

Applicable Models: All

(Read-Write) Set and return the inner lines of all grid in all windows, and the grid frame in inactive windows for the VNA display or hardcopy print. (GRID)

Parameters

<n> Colors to modify. Choose from:
1 - Display colors
2 - Print colors
If unspecified, <n> is set to 1 (Display colors).

<num, num, num> Numeric. Red, Green, and Blue (RGB values) that specify a color.
To find RGB values: from the **Display Colors dialog**, click Change Color, then Define Custom Color.

Examples

```
DISP:COL:GRAT2 10,10,10  
display:color1:grat2 80,80,80
```

Query Syntax

DISPlay:COLor<n>:GRAT2?

Return Type

Numeric (n,n,n)

Default

Display = 100,100,100
Print = 50,50,50

DISPlay:COLor<n>:ILABel <num, num, num>

Applicable Models: All

(Read-Write) Set and return the Inactive (not selected) Window Labels for the VNA display or hardcopy print.

Parameters

<n> Colors to modify. Choose from:
1 - Display colors
2 - Print colors
If unspecified, <n> is set to 1 (Display colors).

<num, num, num> Numeric. Red, Green, and Blue (RGB values) that specify a color.
To find RGB values: from the **Display Colors dialog**, click Change Color, then Define Custom Color.

Examples

```
DISP:COL:ILAB 10,10,10  
display:color1:ilabel 80,80,80
```

Query Syntax

DISPlay:COLor<n>:ILABel?

Return Type

Numeric (n,n,n)

Default

Display = 160,160,160
Print = 0,0,0 (Black)

DISPlay:COLor<n>:LIM1 <num, num, num>

Applicable Models: All

(Read-Write) Set and return the limit line color of failed traces or failure indicators (dots) and the word Fail.

Parameters

<n> Colors to modify. Choose from:
1 - Display colors
2 - Print colors
If unspecified, <n> is set to 1 (Display colors).

<num, num, num> Numeric. Red, Green, and Blue (RGB values) that specify a color.
To find RGB values: from the **Display Colors dialog**, click Change Color, then Define Custom Color.

Examples

```
DISP:COL:LIM1 10,10,10  
display:color1:lim1 80,80,80
```

Query Syntax

DISPlay:COLor<n>:LIM1?

Return Type

Numeric (n,n,n)

Default

Display = 255,20,20
Print = 255,20,20

DISPlay:COLor<n>:LOAD <value>

Applicable Models: All

(Write-only) Load a color theme from a disc file.

Parameters

<n> Colors to load. Choose from:
1 - Display colors
2 - Print colors
If unspecified, <n> is set to 1 (Display colors).

<value> String. Filename of the stored theme. The .colors suffix is automatically appended. By default, files are stored in C:/Program Files/Keysight/Network Analyzer/Colors/. To store and load files from a different folder, specify the full path and filename.

Examples

```
DISP:COL:LOAD "myDisplayTheme"  
display:color2:load "myPrintTheme"
```

Query Syntax

Not Applicable

Default

Not Applicable

DISPlay:COLor<n>:RESet

Applicable Models: All

(Write-only) Resets the current theme to the default VNA colors.

Parameters

<n> Colors to reset. Choose from:
1 - Display colors
2 - Print colors
If unspecified, <n> is set to 1 (Display colors).

Examples

```
DISP:COL:RES  
display:color2:reset
```

Query Syntax

Not Applicable

Default

Not Applicable

DISPlay:COLor<n>:STORe <value>

Applicable Models: All

(Write-only) Saves the current color theme to a disc file.

Parameters

<n>	Colors to store. Choose from: 1 - Display colors 2 - Print colors If unspecified, <n> is set to 1 (Display colors).
<value>	String. Filename. The .colors suffix is automatically appended. By default, files are stored in C:/Program Files/Keysight/Network Analyzer/Colors/. To store and load files from a different folder, specify the full path and filename.

Examples

```
DISP:COL:STOR "myDisplayTheme"  
display:color2:store "myPrintTheme"
```

Query Syntax

Not Applicable

Default

Not Applicable

DISPlay:COLor<n>:TRACe<nth>:DATA <num, num, num>

Applicable Models: All

(Read-Write) Set and return the color of Data and Limit Lines for nth trace in a window.

Parameters

<n>	Colors to modify. Choose from: 1 - Display colors 2 - Print colors If unspecified, <n> is set to 1 (Display colors).
<nth>	Numeric. Relative trace number in the window for which colors are set. This is not necessarily the trace number. Learn more . Choose from 1 to 8. If unspecified, <nth> is set to 1 (first trace).
<num, num, num>	Numeric. Red, Green, and Blue (RGB values) that specify a color. To find RGB values: from the Display Colors dialog , click Change Color, then Define Custom Color.

Examples

```
DISP:COL:TRAC2:DATA 10,10,10  
display:color1:trace5:data 80,80,80
```

Query Syntax

DISPlay:COLor<n>:TRACe<nth>:DATA?

Return Type

Numeric (n,n,n)

Default

Varies for each trace.

DISPlay:COLor<n>:TRACe<nth>:MARKer <num, num, num>

Applicable Models: All

(Read-Write) Set and return the color of data trace markers for nth trace in a window.

Parameters

<n>	Colors to modify. Choose from: 1 - Display colors 2 - Print colors If unspecified, <n> is set to 1 (Display colors).
<nth>	Numeric. Relative trace number in the window for which colors are set. This is not necessarily the trace number. Learn more . Choose from 1 to 8. If unspecified, <nth> is set to 1 (first trace).
<num, num, num>	Numeric. Red, Green, and Blue (RGB values) that specify a color. To find RGB values: from the Display Colors dialog , click Change Color, then Define Custom Color.

Examples

```
DISP:COL:TRAC2:MARK 10,10,10  
display:color1:trace5:marker 80,80,80
```

Query Syntax

DISPlay:COLor<n>:TRACe<nth>:MARKer?

Return Type

Numeric (n,n,n)

Default

Varies for each trace.

DISPlay:COLor<n>:TRACe<nth>:MEMory <num, num, num>

Applicable Models: All

(Read-Write) Set and return the memory trace color for nth trace in a window.

Parameters

<n>	Colors to modify. Choose from: 1 - Display colors 2 - Print colors If unspecified, <n> is set to 1 (Display colors).
<nth>	Numeric. Relative trace number in the window for which colors are set. This is not necessarily the trace number. Learn more . Choose from 1 to 8. If unspecified, <nth> is set to 1 (first trace).
<num, num, num>	Numeric. Red, Green, and Blue (RGB values) that specify a color. To find RGB values: from the Display Colors dialog , click Change Color, then Define Custom Color.

Examples

```
DISP:COL:TRAC2:MEM 10,10,10  
display:color1:trace5:memory 80,80,80
```

Query Syntax

DISPlay:COLor<n>:TRACe<nth>:MEMory?

Return Type

Numeric (n,n,n)

DefaultVaries for each trace.

DISPlay:COLor<n>:TRACe<nth>:MMARker <num, num, num>

Applicable Models: All

(Read-Write) Set and return the color of memory trace markers for nth trace in a window.**Parameters**

- <n>** Colors to modify. Choose from:
1 - Display colors
2 - Print colors
If unspecified, <n> is set to 1 (Display colors).
- <nth>** Numeric. Relative trace number in the window for which colors are set. This is not necessarily the trace number. [Learn more](#).
Choose from 1 to 8.
If unspecified, <nth> is set to 1 (first trace).
- <num, num, num>** Numeric. Red, Green, and Blue (RGB values) that specify a color.
To find RGB values: from the [Display Colors dialog](#), click Change Color, then Define Custom Color.

Examples

```
DISP:COL:TRAC2:MMAR 10,10,10  
display:color1:trace5:mmarker 80,80,80
```

Query Syntax

DISPlay:COLor<n>:TRACe<nth>:MMARker?

Return Type

Numeric (n,n,n)

DefaultVaries for each trace.

Local Lockout

Normally, a GPIB instrument is put in remote mode by asserting the Remote Enable (REN) GPIB line. At that time, all front panel keys (except the Local key) are locked to prevent user interaction.

Sending the LLO message over the GPIB further locks out the keyboard, mouse, and Local key during execution of your GPIB program. The syntax of the LLO message depends on the GPIB driver you are using. Consult your GPIB driver software users manual.

The VNA requires these two actions to occur in order:

- Controller sends the LLO (Local Lockout) message

- Controller asserts the REN (Remote Enable) GPIB line

The VNA will then go into remote mode with full lockout capability.

This feature is also supported using SICL over LAN.

Use the LocalLockoutState COM command when using TCPIP/LAN.

CorrCollGuidPSens

Configures the power sensors to be used during a SmartCal (Guided) Power Calibration.

Three of these commands can be used with Applications Channels. [Learn more](#).

SENSe:CORRection:COLLect:GUIDed:PSEnSor

[CKIT](#)
[CONNector](#)
MULTiple
 | [ADD](#)
 | [CKIT](#)
| [CONNector](#)
 | [COUNT?](#)
| FREQuency
 | [START](#)
 | [STOP](#)
 | [NAME](#)
 | [REMove](#)
 | [\[STATe\]](#)
POWer
 | [LEVel](#)
POWTable
[\[STATe\]](#)

Click on a keyword to view the command details.

Notes

EXCEPT for the following THREE commands, the commands listed on this page are supported ONLY on standard channels.

These can be used with [Application](#) channels. See NFX example.

[SENSe:CORR:COLL:GUID:PSEN<n>:CKIT](#)

[SENSe:CORR:COLL:GUID:PSEN<n>:CONN](#)

[SENSe:CORR:COLL:GUID:PSEN<n>:POW:LEV](#)

When using two sensors with a Dual Power Meter, use

[SOUR:POW:CORR:COLL:<pmChan>SEN:SEL](#) to select a power sensor.

See Also

SENSe:CORRection:COLLect:GUIDed commands **Calibrating the VNA Using SCPI**

[Learn about Measurement Calibration](#)

[Synchronizing the Analyzer and Controller](#)

SENSe<ch>:CORRection:COLLect:GUIDed:PSEnSor<pnum>:CKIT <kit>, [src]

Applicable Models: All

(Read-Write) Specifies the calibration kit to be used when an adapter is necessary to connect the power sensor to the port <pnum> during a guided calibration.

This command can also be used with **Application channels**. See NFX example.

When used with **Guided Power Cal**, first enable a power cal using

SENS:CORR:COLL:GUID:PSEN ON

Specify the connector type for the adapter with **SENS:CORR:COLL:GUID:PSEN:CONN**

Query the valid available kits for the connector with

SENS:CORR:COLL:GUID:CKIT:CAT? <conn>

Specify the kit using this command.

Perform a query of this command. If the <kit> parameter was incorrectly entered, an error will be returned.

Parameters

<ch> Channel being calibrated, depending on the **CHAN:MODE** setting. If unspecified, value is set to 1.

<pnum> Source port being calibrated. If unspecified, value is set to 1. For NFX calcs, port number must be 1.

<kit> Calibration kit to be used for the specified port.

When using an ECal module, include the characterization name in the <kit> string. Use **SENSe:CORR:COLL:GUID:CKIT:CAT?** to read the list of characterizations available in the module and in VNA disk memory.

If two or more identical ECal modules are connected to the VNA, the serial number must be included to distinguish the ECal modules.

[src] String - (NOT case sensitive). Source port. Optional. Use **SOUR:CAT?** to return a list of valid port names.

While this argument can be used to make settings for ALL ports, it is designed to access ports such as an **external source**, true mode balanced port, or one of the Source 2 outputs on the 2-port 2-source VNA-x model such as "Port 1 Src2".

Otherwise, the <port> argument performs the same function. If both arguments are specified, [src] takes priority.

See **Remotely Specifying a Source Port**

Examples

```
SENS:CORR:COLL:GUID:PSEN1:CKIT '85055A'  
'The following includes a serial number when two or more  
ECal mods are connected  
sense:correction:collect:guided:psensor2:ckit '85092-  
60010 ECal 10685'  
See example program
```

Query Syntax SENSE<ch>:CORRection:COLLect:GUIDed:PSEnSor<pnum>:CKIT?

Return Type String

Default

Not Applicable

SENSE<ch>:CORRection:COLLect:GUIDed:PSEnSor<pnum>:CONNector <conn>, [src]

Applicable Models: All

(Read-Write) **Specifies the connector type for a power sensor when a power calibration is part of the Guided Calibration process. Valid connector names are stored within calibration kits. Some cal kits may include both male and female connectors. Therefore, specifying connector gender may be required.**

This command can also be used with [Application channels](#). See NFX example.

Follow these steps to ensure port connectors are specified correctly:

When used with [Guided Power Cal](#), first enable a power cal using
SENS:CORR:COLL:GUID:PSEN ON

Use **SENS:CORR:COLL:GUID:CONN:CAT?** to query available connectors before specifying the port connector.

Set a connector type for each port using this command.

Perform a query of this command. If the connector type was incorrectly entered, an error will be returned.

Specify the cal kit to use for each port with **SENS:CORR:COLL:GUID:PSEnSor:CKIT**

Parameters

<ch> Channel being calibrated, depending on the **CHAN:MODE** setting. If unspecified, value is set to 1.

<pnum> Source port being calibrated. If unspecified, value is set to 1.

<conn> String - Power sensor connector type to connect to the specified VNA port <pnum>.

Because the default for this argument is 'Ignored', by specifying a connector type, you imply that you want to calibrate and correct for the effects of the adapter.

[src] String - (NOT case sensitive). Source port. Optional. Use **SOUR:CAT?** to return a list of valid port names.

While this argument can be used to make settings for ALL ports, it is designed to access ports such as an **external source**, true mode balanced port, or one of the Source 2 outputs on the 2-port 2-source VNA-x model such as "Port 1 Src2".

Otherwise, the <port> argument performs the same function. If both arguments are specified, [src] takes priority.

See [Remotely Specifying a Source Port](#)

Examples

```
SENS:CORR:COLL:GUID:PSEN1:CONN "3.5 mm (50) male"  
sense:correction:collect:guided:psensor1:connector "3.5  
mm (50) female"
```

[See example program](#)

Query Syntax

SENSe<ch>:CORRection:COLLect:GUIDed:PSEnSor<pnum>:CONNector?

Return Type

String

Default

"Ignored"

SENSe<ch>:CORRection:COLLect:GUIDed:PSEnSor<pnum>:MULTiple:ADD <string>

Applicable Models: All

(Write-only) Adds a power sensor to be used during a Guided Power Calibration. Use when multiple power sensors are to be used to calibrate the entire frequency span. The Name argument is used to recognize the sensor in the User Interface.

An item number is automatically assigned to the sensor. Use that number to refer to the sensor. The item number of the newly-added sensor is always equal to the number returned by

SENS:CORR:COLL:GUID:PSEN:MULT:COUN? after the ADD.

Note: The "multiple sensors" commands are supported ONLY on standard channels.

[Learn about using multiple power sensors](#)

Parameters

<ch>

Channel being calibrated, depending on the **CHAN:MODE** setting. If unspecified, value is set to 1.

<pnum>

Source port being calibrated. If unspecified, value is set to 1.

<string>

Power sensor name to add. The power sensor must be already configured as a PMAR device using this name. [Learn how to remotely configure a PMAR device.](#)

Examples

```
SENS:CORR:COLL:GUID:PSEN1:MULT:ADD  
"26GHzPwrSensor"  
See example program
```

Query Syntax

Not Applicable

Default

Not Applicable

SENSe<ch>:CORRection:COLLect:GUIDed:PSEnSor<pnum>:MULTiple<id>:CKIT <string>

Applicable Models: All

(Read-Write) Set and read the Cal Kit to be used when an adapter is necessary to connect the power sensor to the cal plane and you choose to remove its effects from the measurement. Use this command when multiple power sensors are to be used to calibrate the entire frequency span. [Learn about using multiple power sensors.](#)

Parameters

<ch>	Channel being calibrated, depending on the CHAN:MODE setting. If unspecified, value is set to 1.
<pnum>	Source port being calibrated. If unspecified, value is set to 1.
<id>	Power sensor item number. This 1-based number is assigned automatically when a power sensor is added using SENS:CORR:COLL:GUID:PSEN:MULT:ADD . Use SENS:CORR:COLL:GUID:PSEN:MULT:COUN? to return the number of power sensor items that are configured for use on the channel.
<string>	Calibration kit to be used for the specified source port. When using an ECal module, include the characterization name in the <kit> string. Use SENSe:CORR:COLL:GUID:CKIT:CAT? to read the list of characterizations available in the module and in VNA disk memory. If two or more identical ECal modules are connected to the VNA, the serial number must be included to distinguish the ECal modules.

Examples

```
SENS:CORR:COLL:GUID:PSEN1:MULT2:CKIT '85055A'  
  
'The following includes a serial number when two or more ECal  
mods are connected.'  
  
sense:correction:collect:guided:psensor2:multiple1:ckit  
'85092-60010 ECal 10685'  
  
See example program
```

Query Syntax [SENSe<ch>:CORRection:COLLect:GUIDed:PSEnSor<pnum>:MULTiple<id>:CKIT?](#)

Return Type String

Default Not Applicable

SENSe<ch>:CORRection:COLLect:GUIDed:PSEnSor<pnum>:MULTiple<id>:CONNe ctor <conn>

Applicable Models: All

(Read-Write) Set and read the connector type of a power sensor to be used when an adapter is necessary to connect the power sensor to the cal plane and you choose to remove its effects from the measurement. Use this command when multiple power sensors are to be used to calibrate the entire frequency span. [Learn about using multiple power sensors](#)

Parameter
s

<ch>	Channel being calibrated, depending on the CHAN:MODE setting. If unspecified, value is set to 1.
<pnum>	Source port being calibrated. If unspecified, value is set to 1.
<id>	Power sensor item number. This 1-based number is assigned automatically when a power sensor is added using SENS:CORR:COLL:GUID:PSEN:MULT:ADD . Use SENS:CORR:COLL:GUID:PSEN:MULT:COUN? to return the number of power sensor items that are configured for use on the channel.
<conn>	String - Power sensor connector type to connect to the specified source port <pnum>. Because the default for this argument is 'Ignored', by specifying a connector type, you imply that you want to calibrate and correct for the effects of the adapter.
Examples	<pre>SENS:CORR:COLL:GUID:PSEN1:MULT1:CONN "3.5 mm (50) male" See example program</pre>
Query Syntax	SENSe<ch>:CORRection:COLLect:GUIDed:PSEnsor<pnum>:MULTiple<id>:CONNe ctor?
Return Type	String
Default	"Ignored"

SENSe<ch>:CORRection:COLLect:GUIDed:PSEnsor<pnum>:MULTiple:COUNT?

Applicable Models: All

(Read-only) Returns the number of configured power sensors to be used during a Guided Power Calibration. [Learn about using multiple power sensors](#)

Parameters

<ch>	Channel being calibrated, depending on the CHAN:MODE setting. If unspecified, value is set to 1.
<pnum>	Source port being calibrated. If unspecified, value is set to 1.
Examples	<pre>SENS:CORR:COLL:GUID:PSEN1:MULT1:COUN? See example program</pre>
Return Type	Numeric
Default	Not Applicable

SENSe<ch>:CORRection:COLLect:GUIDed:PSEnsor<pnum>:MULTiple<id>:FREQuency:STARt <num>

Applicable Models: All

(Read-Write) **Set and read the start frequency for the specified power sensor (port number). Use this command when multiple power sensors are to be used to calibrate the entire frequency span. [Learn about using multiple power sensors](#)**

Parameters

<ch> Channel being calibrated, depending on the **CHAN:MODE** setting. If unspecified, value is set to 1.

<pnum> Source port being calibrated. If unspecified, value is set to 1.

<id> Power sensor item number. This 1-based number is assigned automatically when a power sensor is added using **SENS:CORR:COLL:GUID:PSEN:MULT:ADD**. Use **SENS:CORR:COLL:GUID:PSEN:MULT:COUN?** to return the number of power sensor items that are configured for use on the channel.

<num> Start frequency in Hz. Choose a value between the start frequency and stop frequency of the VNA.

Examples `SENS:CORR:COLL:GUID:PSEN1:MULT1:FREQ:STAR 1e9`
See example program

Query Syntax `SENSe<ch>:CORRection:COLLect:GUIDed:PSEnSor<pnum>:MULTiple<id>:FREQuency:STARt?`

Return Type Numeric

Default Start frequency of the VNA

SENSe<ch>:CORRection:COLLect:GUIDed:PSEnSor<pnum>:MULTiple<id>:FREQuency:STOP <num>

Applicable Models: All

(Read-Write) **Set and read the stop frequency for the specified power sensor (port number). Use this command when multiple power sensors are to be used to calibrate the entire frequency span. [Learn about using multiple power sensors](#)**

Parameters

<ch> Channel being calibrated, depending on the **CHAN:MODE** setting. If unspecified, value is set to 1.

<pnum> Source port being calibrated. If unspecified, value is set to 1.

<id> Power sensor item number. This 1-based number is assigned automatically when a power sensor is added using **SENS:CORR:COLL:GUID:PSEN:MULT:ADD**. Use **SENS:CORR:COLL:GUID:PSEN:MULT:COUN?** to return the number of power sensor items that are configured for use on the channel.

<num> Stop frequency in Hz. Choose a value between the start frequency and stop frequency of the VNA.

Examples	<code>SENS:CORR:COLL:GUID:PSEN1:MULT1:FREQ:STOP 2e9</code> See example program
Query Syntax	<code>SENSe<ch>:CORRection:COLLect:GUIDed:PSEnSor<pnum>:MULTiple<id>:FREQuency:STOP?</code>
Return Type	Numeric
Default	Stop frequency of the VNA

`SENSe<ch>:CORRection:COLLect:GUIDed:PSEnSor<pnum>:MULTiple<id>:NAME<string>`

(Read-Write) Set and read the name of the power sensor. **Applicable Models: All**
[Learn about using multiple power sensors.](#)

Parameters

<ch>	Channel being calibrated, depending on the <code>CHAN:MODE</code> setting. If unspecified, value is set to 1.
<pnum>	Source port being calibrated. If unspecified, value is set to 1.
<id>	Power sensor item number. This 1-based number is assigned automatically when a power sensor is added using <code>SENS:CORR:COLL:GUID:PSEN:MULT:ADD</code> . Use <code>SENS:CORR:COLL:GUID:PSEN:MULT:COUN?</code> to return the number of power sensor items that are configured for use on the channel.
<string>	Sensor name. The power sensor must be already configured as a PMAR device using this name. Learn how to remotely configure a PMAR device.

Examples	<code>SENS:CORR:COLL:GUID:PSEN1:MULT1:NAME "26GHzPwrSensor"</code> See example program
Query Syntax	<code>SENSe<ch>:CORRection:COLLect:GUIDed:PSEnSor<pnum>:MULTiple<id>:NAME?</code>
Return Type	String
Default	

`SENSe<ch>:CORRection:COLLect:GUIDed:PSEnSor<pnum>:MULTiple<id>:REMOve`

(Write-only) Deletes a power sensor from the sensors to be used during a Guided Power Calibration. **Applicable Models: All**

Parameters

<ch>	Channel being calibrated, depending on the CHAN:MODE setting. If unspecified, value is set to 1.
<pnum>	Source port being calibrated. If unspecified, value is set to 1.
<id>	Power sensor item number to remove. Use SENS:CORR:COLL:GUID:PSEN:MULT:COUN? to return the number of power sensor items that are configured for use on the channel.
Examples	<pre>SENS:CORR:COLL:GUID:PSEN1:MULT1:REM See example program</pre>
Query Syntax	Not Applicable
Default	Not Applicable

**SENSe<ch>:CORRection:COLLect:GUIDed:PSEnSor<pnum>:MULTiple[:STATe]
<value>**

(Read-Write) **Enables the use of multiple power sensors to calibrate the entire frequency span of the channel. [Learn about using multiple power sensors.](#)**

Applicable Models: All

Parameters

<ch>	Channel being calibrated, depending on the CHAN:MODE setting. If unspecified, value is set to 1.
<pnum>	Source port being calibrated. If unspecified, value is set to 1. ONLY one port may be calibrated with a Guided Power Cal.
<value>	Boolean ON (or 1) Use multiple power sensors. OFF (or 0) Do NOT use multiple power sensors.

Examples

```
SENS:CORR:COLL:GUID:PSEN1:MULT 0  
sense:correction:collect:guided:psensor2:multiple:state ON  
See example program
```

Query Syntax **SENSe<ch>:CORRection:COLLect:GUIDed:PSEnSor<pnum>:MULTiple[:STATe]?**

Return Type **Boolean**

Default

OFF (0)

SENSe<ch>:CORRection:COLLect:GUIDed:PSEnSor<pnum>:POWer:LEVel <value>, [src]

(Read-Write) **Specifies the power level at which to perform a power calibration during a guided calibration.**
Applicable Models: All
This command can also be used with Application channels. See NFX example.
When used with Guided Power Cal, first enable a power cal using SENS:CORR:COLL:GUID:PSEN ON.

Parameter
s

<ch> Channel being calibrated, depending on the **CHAN:MODE** setting. If unspecified, value is set to 1.

<pnum> Source port being calibrated. If unspecified, value is set to 1. For NFX cals, port number must be 1.

<value> **Power level in dBm at which to perform the power calibration. [Learn more.](#)**

[src] String - (NOT case sensitive). Source port. Optional. Use **SOUR:CAT?** to return a list of valid port names.

While this argument can be used to make settings for ALL ports, it is designed to access ports such as an **external source**, true mode balanced port, or one of the Source 2 outputs on the 2-port 2-source PNA-X model such as "Port 1 Src2".

Otherwise, the <port> argument performs the same function. If both arguments are specified, [src] takes priority.

See [Remotely Specifying a Source Port](#)

Examples

```
SENS:CORR:COLL:GUID:PSEN1:POW:LEV 0
sense:correction:collect:guided:psensor2:power:level -5
```

See example program

Query Syntax **SENSe<ch>:CORRection:COLLect:GUIDed:PSEnSor<pnum>:POWer:LEVel?**

Return Type Numeric

Default

0

SENSe<ch>:CORRection:COLLect:GUIDed:PSEnSor<pnum>:POWTable <file>, [src]

Applicable Models: N522xB, N523xB, N524xB

(Read-Write) Loads a file that defines a power table to be used during a SMC Guided Power Cal or Cal All Channels on a mmWave system. This feature is available because power sensors are NOT typically available at mmWave frequencies. Learn more.

Parameters

- <ch> Channel being calibrated, depending on the **CHAN:MODE** setting. If unspecified, value is set to 1.
- <pnum> Source port being calibrated. If unspecified, value is set to 1. For NFX calcs, port number must be 1.
- <file> **(String) Full path and filename of a *.prn file that defines the power table. An error is returned if the file is not found.**
- [src] String - (NOT case sensitive). Source port. Optional. Use **SOUR:CAT?** to return a list of valid port names.

While this argument can be used to make settings for ALL ports, it is designed to access ports such as an **external source**, true mode balanced port, or one of the Source 2 outputs on the 2-port 2-source PNA-X model such as "Port 1 Src2".

Otherwise, the <port> argument performs the same function. If both arguments are specified, [src] takes priority.

See [Remotely Specifying a Source Port](#)

Examples

```
SENS:CORR:COLL:GUID:PSEN1:POWT "C:/powertable1.prn"  
sense:correction:collect:guided:psensor2:powtable  
"C:/powertable2.prn"
```

Query Syntax SENSE<ch>:CORRection:COLLect:GUIDed:PSEnSor<pnum>:POWTable?

Return Type String

Default

Not Applicable

SENSe<ch>:CORRection:COLLect:GUIDed:PSEnSor<pnum>[:STATe] <value>, [src]

Applicable Models: All

(Read-Write) Enables **Guided Power Cal** and sets the source port to be calibrated.

Parameters

<ch> Channel being calibrated, depending on the **CHAN:MODE** setting. If unspecified, value is set to 1.

<pnum> Source port being calibrated. If unspecified, value is set to 1. ONLY one port may be calibrated with a Guided Power Cal.

<value> **Boolean**
ON (or 1) Perform Power Cal.
OFF (or 0) Do NOT perform Power Cal.

[src] String - (NOT case sensitive). Source port. Optional. Use **SOUR:CAT?** to return a list of valid port names.

While this argument can be used to make settings for ALL ports, it is designed to access ports such as an **external source**, true mode balanced port, or one of the Source 2 outputs on the 2-port 2-source PNA-X model such as "Port 1 Src2".

Otherwise, the <port> argument performs the same function. If both arguments are specified, [src] takes priority.

See [Remotely Specifying a Source Port](#)

Examples

```
SENS:CORR:COLL:GUID:PSEN1 0
sense:correction:collect:guided:psensor2:state ON
See example program
```

Query Syntax SENSE<ch>:CORRection:COLLect:GUIDed:PSENSor<pnum>[:STATe]?

Return Type Boolean

Default OFF (0)

CorrCollGuidSMC

These commands, along with the standard [Guided commands](#), performs a SMC calibration on a frequency converting device.

Note: These commands replace the **SENSe:CORRectionCOLLect:Session:SMC** commands. **These commands allow the entire SMC cal to be performed from the Guided cal interface.**

These commands are also used to perform a GCx Calibration. See an example.

SENSe:CORRectionCOLLect:GUIDed:SMC

FSIMulator

| NETWork

| **FILEname**

| **MODE**

IMPort

LO:PCAL[:STATe]

PHASe

| **DELay**

| **METHod**

| **MIXer**

PWRCal

| **CANCel**

| **RECeiver**

| **SEParate**

Click on a **red** keyword to view the **command details**.

Red keywords are obsolete.

See Also

[All GUIDed commands](#)

[Example Programs](#)

[Learn about SMC Calibrations](#)

[Synchronizing the Analyzer and Controller](#)

[SCPI Command Tree](#)

NOTE: To configure a power meter and sensor see [SOURce:POWer:](#) commands.

SENSe<ch>:CORRection:COLLect:GUIDed
:SMC:FSIMulator:NETWork<p>:FILEname <string>

Applicable Models: All with SMC Options (S9x082A/B, S9x083A/B)
(Read-Write) Specifies the S2P filename to embed or de-embed on the input or output of your mixer measurement. [Learn more.](#)

Parameters

- <ch>** Any existing channel number. If unspecified, value is set to 1
- <p>** Apply network to input or output of mixer. Choose from:
- 1 - Input of mixer
 - 2 - Output of mixer
- <string>** Filename of the S2P used for embedding or de-embedding. Use the full path name, file name, and .S2P suffix, enclosed in quotes.

Examples

```
SENS:CORR:COLL:GUID:SMC:FSIM:NETW1:FIL
"D:\WaveguideAdapt.S2P"
```

Query Syntax SENS<ch>:CORRection:COLLect:GUIDed:SMC:FSIMulator:NETWork<x>:FILename?

Return Type String

Default Not Applicable

SENSe<ch>:CORRection:COLLect:GUIDed:SMC:FSIMulator:NETWork<p>:MODE<char>

Applicable Models: All with SMC Options (S9x082A/B, S9x083A/B)
 (Read-Write) Allows you to embed (add) or de-embed (remove) circuit network effects on the input and output of your mixer measurement. [Learn more.](#)

Parameters

- <ch>** Any existing channel number. If unspecified, value is set to 1
- <p>** Apply network to input or output of mixer. Choose from:
- 1 - Input of mixer
 - 2 - Output of mixer
- <char>** Choose from:
- NONE** - Do nothing with effects of S2P file.
 - EMBed** - Add effects of S2P file from the measurement results.
 - DEEMbed** - Remove effects of S2P file from the measurement results.

Examples

```
SENS:CORR:COLL:GUID:SMC:FSIM:NETW1:MODE EMB
```

Query Syntax SENS<ch>:CORRection:COLLect:GUIDed:SMC:FSIMulator:NETWork<x>:MODE?

Return Type

Character

Default

NONE

SENSe<ch>:CORRection:COLLect:GUIDed:SMC:IMPort <calName>, <dataset>

Applicable Models: All with SMC Options (S9x082A/B, S9x083A/B)
(Write-only) Imports Guided Power Cal or Phase Reference Cal into the current SMC calibrations.

For the Guided Power Cal:

The port of the mixer input must have the same source attenuator setting between the SMC channel and the Guided Power Cal Set. The frequencies of the Guided Power Cal must include all the mixer frequencies. Interpolation will be applied to the Guided Power Cal frequencies if they do not exactly match.

For the Phase Reference Cal:

The port of the mixer input must have the same source attenuator setting as used in the phase reference cal. The phase reference cal must include all the mixer frequencies. Interpolation will be applied to the phase reference cal frequencies if they do not exactly match. [Learn more about Phase Reference Cal.](#)

The following error message may appear (it is not written to the VNA Error Log):

Interpolation target is out of range. Cannot interpolate when incompatible frequency ranges occur.

Parameters

<ch> Any existing channel number. If unspecified, value is set to 1

<calName> (String) Name of existing Cal Set from which to import power data.

<dataset> (String) Name of the data set. Choose from:

- POWER_STEP -import the Guided Power Cal data.
- "POWER_AND_PHASE" - Import the Phase Reference + power cal data. When this command is sent, the SMC Cal Method is automatically set to Use Phase Reference Cal. [Learn more.](#) There is no other command to set this.

Examples

```
SENS2:CORR:COLL:GUID:SMC:IMP "MyPowerCal", "POWER_STEP"
```

[See example program](#)

```
SENS:CORR:COLL:GUID:SMC:IMP  
"MyPhaseRefCal", "POWER_AND_PHASE"
```

[See example program](#)

Query Syntax

Not Applicable

Default

Not Applicable

SENSe<ch>:CORRection:COLLect:GUIDed:SMC:LO<n>:PCAL[:STATe] <bool>

Applicable Models: All with SMC Options (S9x082A/B, S9x083A/B)

(Read-Write) Sets and returns whether or not the LO power cal step is included in the cal steps when an SMC or GCx cal is performed. [Learn more.](#)

Set LO Power level for the calibration using [SENS:CORR:COLL:GUID:PSEN1:POW:LEV](#).

Parameters

<cnm> Any existing channel number; if unspecified, value is set to 1.

<n> LO Stage. Choose 1.

<bool> LO Power Cal state. Choose from:

0 or **OFF** - Skips over the LO Power Cal when calibrating.

1 or **ON** - Includes a step for LO Power Cal when calibrating

Examples

```
SENS:CORR:COLL:GUID:SMC:LO1:PCAL 0
```

Query Syntax SENSe<ch>:CORRection:COLLect:GUIDed:SMC:LO<n>:PCAL[:STATe]

Return Type Boolean

Default **OFF** or **0**

SENSe<ch>:CORRection:COLLect:GUIDed:SMC:PHASe:DELay <num>

Applicable Models: All with SMC Options (S9x082A/B, S9x083A/B) (Excepts M9485A)

(Read-Write) Set and return the known delay through the calibration mixer. [Learn more.](#)

Parameters

<ch> Any existing channel number. If unspecified, value is set to 1

<char> Known delay through the calibration mixer in seconds.

Examples

```
SENS:CORR:COLL:GUID:SMC:PHAS:DEL 12e-9
```

```
sense2:correction:collect:guided:smc:phase:delay 12e-10
```

Query Syntax SENSe<ch>:CORRection:COLLect:GUIDed:SMC:PHASe:DELay?

Return Type Numeric

Default 0 seconds

SENSe<ch>:CORRection:COLLect:GUIDed:SMC:PHASe:METHod <char>

Applicable Models: All with SMC Options (S9x082A/B, S9x083A/B) (Excepts M9485A)
 (Read-Write) Set and return the method of setting the delay through the calibration mixer. [Learn more.](#)
 To select Phase Reference Cal method for correcting an SMC+Phase measurement, use **SENS:CORR:COLL:GUID:SMC:IMPorT**

Parameters

<ch> Any existing channel number. If unspecified, value is set to 1

<char>

Choose from:

FIXed - use a known delay value set with
SENS:CORR:COLL:GUID:SMC:PHAS:DEL

MIXer - use the S2P file set with
SENS:CORR:COLL:GUID:SMC:PHAS:MIX

Examples

```
SENS:CORR:COLL:GUID:SMC:PHAS:METH FIX
sense2:correction:collect:guided:smc:phase:method mixer
```

Query Syntax

SENSe<ch>:CORRection:COLLect:GUIDed:SMC:PHASe:METhod?

Return Type

Character

Default

FIXed

SENSe<ch>:CORRection:COLLect:GUIDed:SMC:PHASe:MIXer <string>

Applicable Models: All with SMC Options (S9x082A/B, S9x083A/B) (Excepts M9485A)
 (Write-only) Set the filename of the S2P file used to characterize the calibration mixer. [Learn more.](#)

Parameters

<ch> Any existing channel number. If unspecified, value is set to 1

<string>

Calibration mixer filename. Use the following rules to specify path names:

The default folder is "D:\"

You can change the active directory using **MMEMory:CDIRectory**.

Specify only the file name if using the active directory.

You can also use an absolute path name to specify the folder and file.

Examples

```
SENS:CORR:COLL:GUID:SMC:PHAS:MIX "MyCalMixer.s2p"
sense2:correction:collect:guided:smc:phase:mixer
"MyCalMixer.s2p"
```

Query Syntax

Not Applicable

Default

Not Applicable

SENSe<ch>:CORRection:COLLect:GUIDed:SMC:PWRCal:CANCeI

Applicable Models: All with SMC Options (S9x082A/B, S9x083A/B)
(Write-only) Aborts a power cal. This command should be sent when a power cal is running.

Parameters

<ch> Channel number of the SMC cal being performed. If unspecified, value is set to 1

Examples

```
SENS : CORR : COLL : GUID : SMC : PWRC : CANC
```

Query Syntax

Not Applicable

Default

Not Applicable

SENSe<ch>:CORRection:COLLect:GUIDed:SMC:PWRCal:RECEiver <bool>

Applicable Models: All with SMC Options (S9x082A/B, S9x083A/B)
(Read-Write) Set whether to use the reference receiver for faster iteration during power cal or use a power meter.
This command should be set during calibration setup. [Learn more](#).

Parameters

<ch> Any existing channel number. If unspecified, value is set to 1

<bool>

OFF or 0 - Use a power meter only.

ON or 1 - Use a power meter for the first reading and the reference receiver for all subsequent readings.

Examples

```
SENS : CORR : COLL : GUID : SMC : PWRC : REC 1
```

Query Syntax

```
SENSe<ch>:CORRection:COLLect:GUIDed:SMC:PWRCal:RECEiver?
```

Return Type

Boolean

Default

ON or 1

SENSe<ch>:CORRection:COLLect:GUIDed:SMC:PWRCal:SEParate <bool>

Applicable Models: All with SMC Options (S9x082A/B, S9x083A/B)
(Read-Write) Specifies whether to use a Thru standard or to use two power sensor connections during the power cal of an SMC calibration.

Note: This command must be sent BEFORE ALL other calibration commands.

Parameters

<ch> Any existing channel number. If unspecified, value is set to 1.

<bool>

OFF or 0 - Perform Cal with Thru standard.

ON or 1 - Do NOT use a Thru, but instead perform separate power calcs on Input and Output reference planes.

Examples

```
'The following is an example sequence of commands:  
SENS:CORR:COLL:GUID:SMC:PWRC:SEP 1  
SENS:CORR:COLL:GUID:CONN:PORT1 "APC 3.5 female"  
SENS:CORR:COLL:GUID:CONN:PORT2 "APC 3.5 female"  
SENS:CORR:COLL:GUID:CONN:PORT3 "Not used"  
SENS:CORR:COLL:GUID:CONN:PORT4 "Not used"  
SENS:CORR:COLL:GUID:CKIT:PORT1 "N4691-60006 ECal 02638"  
SENS:CORR:COLL:GUID:CKIT:PORT2 "N4691-60006 ECal 02638"  
SENS:CORR:COLL:GUID:INIT
```

Query Syntax

SENSe<ch>:CORRection:COLLect:GUIDed:SMC:PWRCal:SEParate?

Return Type

Boolean

Default

OFF or 0

ECalCharacterize

Controls the settings used to perform an ECal User Characterization. These commands do NOT perform the calibration that is required before measuring the ECal module. An S-Parameter channel must already be calibrated. [Learn more.](#)

SENSe:CORR:CKIT:ECAL:CHARacterize:

ACQUIRE

CNUMBER

CONNector

| **CATALOG?**

| **PORT<n>[:SElect]**

DESCription

| **PORT<n>[:SElect]**

| **[STEP]?**

| **USER**

| **VNA**

DMEMory

| **SAVE**

ID

INITiate

INSitu

| **ENABLE**

| **[STATe]**

SAVE

STEPS?

Click on a keyword to view the command details.

Notes:

These commands provide for the following:

Measure the ECal module with adapters, cables, or fixtures to be included in the User Characterization.

Allow descriptive text to be entered.

Save the User Characterization to the ECal module or VNA disk memory. Up to 12 User Characterizations can be stored in an ECal module. [Learn more.](#)

You can NOT perform a remote User Characterization of a 4-port ECal module using a 2-port VNA. This can only be done from the front panel user interface.

See Also

- Example - [Perform an ECal User Characterization](#)
- [Learn about ECal User Characterization](#)
- [Synchronizing the Analyzer and Controller](#)
- [SCPI Command Tree](#)

SENSe<ch>:CORRection:CKIT:ECAL:CHARacterize:ACQuire STAN<step>

Applicable Models: All

(Write-only) Initiates the measurement of the ECal module. The user characterization process must have been initiated first using **SENS:CORR:CKIT:ECAL:CHAR:INIT**. Currently, only ONE step is required to measure the ECal module.

Note: This command is an overlapped command. When *OPC is issued with it, the OPC bit in the VNAs Standard Event Status Register is not set until this command has completed its operation. [Learn more.](#)

Parameters

- <ch> Channel number being calibrated. If unspecified, value is set to 1. Channel number being calibrated.
- <step> Integer User characterization step number to be measured.

Examples

```
SENS:CORR:CKIT:ECAL:CHAR:ACQ STAN1, *OPC
```

Query Syntax

Not Applicable

Default

Not Applicable

SENSe<ch>:CORRection:CKIT:ECAL:CHARacterize:CNUMber <n>

Applicable Models: All

(Read-Write) Sets and reads the number to which the User Characterization will be stored in the ECal module. The number must be set before sending **SENS:CORR:CKIT:ECAL:CHAR:INIT** or the default value (1) will be used.

This command is NOT necessary when saving the User Characterization to the VNA disk memory.

Parameters

- <ch> Channel number being calibrated. If unspecified, value is set to 1
- <n> User Characterization number. Choose a value between 1 and 12.

Examples	<code>SENSe:CORR:CKIT:ECAL:CHAR:CNUM 2</code>
Query Syntax	<code>SENSe<ch>:CORRection:CKIT:ECAL:CHARacterize:CNUMBER?</code>
Return Type	Numeric
Default	1

SENSe:CORRection:CKIT:ECAL:CHARacterize:CONNector:CATalog?

Applicable Models: All

(Read-only) Returns a list of connector names that are valid for use with user-characterized ECal modules. Use an item from the returned list to specify a connector for

SENS:CORR:CKIT:ECAL:CHAR:CONN:PORT.

Use only factory-defined connector types when you store a user characterization to VNA disk memory.

Parameters None

Examples

```
SENS:CORR:CKIT:ECAL:CHAR:CONN:CAT?
```

```
'Example returned string: "APC 3.5 male, APC 3.5 female,
Type N (50) female, Type N (50) male, APC 7, Type A
(50), Type B"
```

Return Type Comma-separated string

Default Not Applicable

SENSe<ch>:CORRection:CKIT:ECAL:CHARacterize:CONNector:PORT<n>[:SElect] <string>

Applicable Models: All

(Read-Write) Specifies a connector type name for every ECal module port used during the user characterization. Valid connector names are returned using

SENS:CORR:CKIT:ECAL:CHAR:CONN:CAT?

This command refers to the ECal ports by number instead of letter (1 = Port A, 2 = Port B, and so forth). The connector names should be set for the ports before sending

SENS:CORR:CKIT:ECAL:CHAR:INIT.

The following steps could be followed to ensure port connectors are specified correctly:

Use **SENS:CORR:CKIT:ECAL:CHAR:CONN:CAT?** to query available connectors before specifying the port connector.

Specify a connector type using this command. If the <string> parameter was incorrectly entered, an error will be returned.

Note: Use only factory-defined connector types when you store a user characterization to VNA disk memory.

Parameters

<ch> Channel number being calibrated. If unspecified, value is set to 1

<n> ECal test port number for which a connector type will be specified. Choose 1 to 2 for a 2-port ECal module, 1 through 4 for a 4-port module.

<string> ECal connector type and gender (if applicable).

When the User Characterization is to be stored in the ECal module, then the connector type is limited to a Factory-defined connector type. [See the list.](#)

When the User Characterization is to be stored in VNA disk memory, then the connector type can also be a User-defined connector type.

Examples	<code>SENS:CORR:CKIT:ECAL:CHAR:CONN:PORT2 "APC 3.5 female"</code>
Query Syntax	<code>SENSe<ch>:CORRection:CKIT:ECAL:CHARacterize:CONNector:PORT<n>[:SElect]?</code>
Return Type	String
Default	"No adapter"

`SENSe<ch>:CORRection:CKIT:ECAL:CHARacterize:DESCription[:STEP]? <stepN>`

Applicable Models: All

(Read-only) Returns the connection description for the specified step of the ECal user characterization process. The user characterization process must have been initiated first using `SENS:CORR:CKIT:ECAL:CHAR:INIT`.

Parameters

<ch> Channel number being calibrated. If unspecified, value is set to 1

<stepN> Integer - User characterization step number for which a description will be returned. Use `SENS:CORR:CKIT:ECAL:CHAR:STEP?` to query the number of steps.

Examples	<code>SENSe:CORR:CKIT:ECAL:CHAR:DESC? 2</code> <code>'Example return string:</code> <code>Connect ECal Module Ports A and B to PNA Ports 1 and 2</code>
----------	---

Return Type	String
Default	Not Applicable

`SENSe<ch>:CORRection:CKIT:ECAL:CHARacterize:DESCription:USER <string>`

Applicable Models: All

(Read-Write) Sets and reads the description of the person and/or company who is producing the ECal user characterization. This description is stored with the characterization. Set this description before sending `SENS:CORR:CKIT:ECAL:CHAR:INIT` or the default (empty string) will be used.

Parameters

<ch> Channel number being calibrated. If unspecified, value is set to 1

<string> Descriptive text, limited to 19 characters maximum.

Examples

```
SENSe:CORR:CKIT:ECAL:CHAR:DESC:USER "John Doe, Acme Inc."
```

Query Syntax

```
SENSe<ch>:CORRection:CKIT:ECAL:CHARacterize:DESCription:USER?
```

Return Type

String

Default

" " (Empty String)

SENSe<ch>:CORRection:CKIT:ECAL:CHARacterize:DESCription:VNA <string>

Applicable Models: All

(Read-Write) Sets and reads a description of the Vector Network Analyzer used to perform the User Characterization. This description is stored with the user characterization.

Set this description before sending **SENS:CORR:CKIT:ECAL:CHAR:INIT** or the default (empty string) will be used.

Parameters

<ch>

Channel number being calibrated. If unspecified, value is set to 1

<string>

Descriptive text, limited to 14 characters maximum.

Examples

```
SENSe:CORR:CKIT:ECAL:CHAR:DESC:VNA "My PNA"
```

Query Syntax

```
SENSe<ch>:CORRection:CKIT:ECAL:CHARacterize:DESCription:VNA?
```

Return Type

String

Default

" " (Empty String)

SENSe<ch>:CORRection:CKIT:ECAL:CHARacterize:DESCription:PORT<n>[:SElect] <string>

Applicable Models: All

(Read-Write) For each port of the ECal module that is going to be characterized, sets and reads the description of the adapters, cable, or fixture to be included in the user characterization. This command refers to the ECal ports by number instead of letter (1 = Port A, 2 = Port B, and so forth). This description is stored with the user characterization.

Set this description before sending **SENS:CORR:CKIT:ECAL:CHAR:INIT** or the default (empty string) will be used.

Parameters

<ch>

Channel number being calibrated. If unspecified, value is set to 1

<n>

ECal port number. Choose 1 to 2 for a 2-port ECal module, 1 to 4 for a 4-port module.

<string> Descriptive text, limited to 24 characters maximum.

Examples `SENSe:CORR:CKIT:ECAL:CHAR:DESC:PORT1 "3.5 mm adapter, SN 00001"`

Query Syntax `SENSe<ch>:CORRection:CKIT:ECAL:CHARacterize:DESCription:PORT<n>[:SElect]?`

Return Type String

Default " " (Empty String)

`SENSe<ch>:CORRection:CKIT:ECAL:CHARacterize:DMEMory:SAVE <charName>`

Applicable Models: All

(Write-only) Completes an ECal user characterization by writing the characterization data to the VNA disk. To write the characterization data to the ECal module, use

SENS:CORR:CKIT:ECAL:CHAR:SAVE. A User Characterization can be saved to both VNA disk memory and ECal module memory.

Use this <charName> for performing future calibrations with this User Characterization. See

SENS:CORR:CKIT:ECAL:KNAM:INF?

Note: An ECal confidence check can NOT be performed remotely from User Characterizations that are stored on the VNA disk.

Parameters

<ch> Channel number being calibrated. If unspecified, value is set to 1.

<charName> String. User characterization name. Although there is no limit to the number of characters, only about 10 characters appear in the Cal Wizard dialog when selecting a user characterization for use.

Examples `SENS:CORR:CKIT:ECAL:CHAR:DMEM:SAVE "DUT1 User Char"`

Query Syntax Not Applicable

Default Not Applicable

`SENSe<ch>:CORRection:CKIT:ECAL:CHARacterize:ID <model, sn>`

Applicable Models: All

(Read-Write) Selects the model and serial number of the ECal module to be characterized. This command does not Set the model and serial number of the ECal module.

Parameters

<ch> Channel number being calibrated. If unspecified, value is set to 1

<model, sn> Model and serial number of the ECal module to be characterized.

Examples `SENSe:CORR:CKIT:ECAL:CHAR:ID "N4433A, 00001"`

Query Syntax `SENSe<ch>:CORRection:CKIT:ECAL:CHARacterize:ID?`

Return Type	String
Default	" " (Empty String)

SENSe<ch>:CORRection:CKIT:ECAL:CHARacterize:INITiate [bool]

Applicable Models: All

(Write-only) Initiates an ECal User Characterization. The specified channel number must be an S-parameter measurement channel. The channel must already be calibrated using the same, or greater number of VNA ports as the ECal module. Also, the calibrated VNA ports must begin with Port 1 and use sequential port numbers.

After this command is executed, subsequent commands can be used to query the number of measurement steps, issue the acquisition commands, query the connection description strings, and subsequently complete an Ecal User characterization.

Parameters

<ch> Channel number of a calibrated S-parameter channel. If unspecified, value is set to 1

[bool] Optional argument. If unspecified, value is set to 1.
 ON (or 1) Check ECal memory to ensure that a new characterization with the channels current number of points will fit in the module memory. Select for User Characterizations to be stored in internal ECal memory.
 OFF (or 0) Skip the check. Select for User Characterizations to be stored to VNA disk memory.

Examples

```
SENS:CORR:CKIT:ECAL:CHAR:INIT
sense2:correction:ckit:ecal:characterize:initiate off
```

Query Syntax

Not Applicable

Default

Not Applicable

SENSe<ch>:CORRection:CKIT:ECAL:CHARacterize:INSitu:ENABLE?

Applicable Models: N522xB, N523xB, N524xB, M937xA, P937xA

(Read-only) Returns whether the device that was specified by **SENS:CORR:CKIT:ECAL:CHAR:ID** is a CalPod module, which is capable of being characterized as an in-situ device. [Learn more.](#)

Parameters

<ch> Channel number being calibrated. If unspecified, value is set to 1.

Examples

```
SENS:CORR:CKIT:ECAL:CHAR:INSITU:ENABLE?
```

Return Type

Boolean
 1 Device is a CalPod module
 0 Device is NOT a CalPod module

Default

Not Applicable

SENSe<ch>:CORRection:CKIT:ECAL:CHARacterize:INSitu[:STATe] <bool>

Applicable Models: N522xB, N523xB, N524xB, M937xA, P937xA
(Read-Write) Sets or returns whether the device (CalPod module) that was specified by **SENS:CORR:CKIT:ECAL:CHAR:ID** will be characterized as an in situ device. [Learn more.](#)

Parameters

<ch>	Channel number being calibrated. If unspecified, value is set to 1.
<bool>	In situ state. Choose from: ON (or 1) - Characterize the CalPod module as an in situ device. OFF (or 0) Do NOT characterize the CalPod module as an in situ device.

Examples

```
SENS:CORR:CKIT:ECAL:CHAR:INSitu 1
```

Query Syntax

```
SENSe<ch>:CORRection:CKIT:ECAL:CHARacterize:INSitu[:STATe]?
```

Return Type

Boolean

Default

ON or 1

SENSe<ch>:CORRection:CKIT:ECAL:CHARacterize:SAVE

Applicable Models: All
(Write-only) Completes an ECal user characterization by writing the characterization data to the ECal module memory. To write the characterization data to VNA disk memory, use **SENS:CORR:CKIT:ECAL:CHAR:DMEM:SAVE**. A User Characterization can be saved to both VNA disk memory and ECal module memory.

Note: This command is an overlapped command. When ***OPC** is issued with it, the OPC bit in the VNAs Standard Event Status Register is not set until this command has completed its operation. [Learn more.](#)

Parameters

<ch>	Channel number being calibrated. If unspecified, value is set to 1.
------	---

Examples

```
SENS:CORR:CKIT:ECAL:CHAR:SAVE, *OPC
```

Query Syntax

Not Applicable

Default

Not Applicable

SENSe<ch>:CORRection:CKIT:ECAL:CHARacterize:STEPS?

Applicable Models: All
(Read-only) Returns the number of steps required to measure the ECal module. Currently, only ONE is required.

Parameters

<ch> Channel number being calibrated. If unspecified, value is set to 1

Examples

SENS : CORR : CKIT : ECAL : CHAR : STEP?

Return Type Numeric

Default

Not Applicable

MixerSegment

Configures Mixer Segments.

SENSe:MIXer:SEGMENT

ADD

BWIDth

CALCulate

COUNt?

DELeTe

| ALL

IF:FREQ:SIDeband

INPut:FREQ:

| FIXed

| MODE

| STARt

| STOP

INPut:POWer

LO:FREQ:

| FIXed

| ILTI

| MODE

| STARt

| STOP

LO:POWer

OUTPut:FREQ:

| [FIXed](#)

| [MODE](#)

| [SIDeband](#)

| [STARt](#)

| [STOP](#)

[OUTPut:POWer](#)

[POINts](#)

[STATe](#)

Click on a [red](#) keyword to view the **command details**.

See Also

[Example Programs](#)

[Learn about the Frequency Converter Application](#)

[Synchronizing the Analyzer and Controller](#)

[SCPI Command Tree](#)

Scratch vs Applied Mixer Properties

Each mixer configuration has two sets of properties:

Scratch mixer contains the properties that have been set, but NOT YET applied.

Send the [SENSe<ch>:MIXer:APPLy](#) command to copy these properties to the Applied mixer.

Applied mixer contains the properties that makeup the current mixer configuration.

Power settings are immediately applied to both the Scratch and Applied mixer.

A successful [Calculate](#) also perform an Apply.

Note: Queries always return the Applied mixer properties. Therefore, first send [SENSe<ch>:MIXer:APPLy](#) before querying new settings.

SENSe<ch>:MIXer:SEGMENT<n>:ADD <value>

Applicable Models: All

(Write only) Adds the specified number of segments to the **scratch mixer** beginning at the last segment position. All segments are added with default settings.

Parameters

<ch>	Channel number of the mixer measurement. If unspecified, value is set to 1.
<n>	Position at which to add segments. Valid range is between 1 and the current segment count +1. Using count +1 adds segments to the end of the segment table. Use SENS:MIX:SEGM:COUN? to read the current count in the Applied Mixer .
<value>	Optional argument. Number of segments to add. If unspecified, 1 segment is added.
Examples	<pre>SENS:MIX:SEGM1:ADD 3</pre> 'Adds 3 segments beginning at position 1. For a preset state, this results in a total of 4 segments.
Query Syntax	Not Applicable
Return Type	Numeric
Default	Not Applicable

SENSe<ch>:MIXer:SEGMENT<n>:BWIDth <value>

Applicable Models: All

(Read/Write) Sets and returns the IF Bandwidth for the sweep segment.

Parameters

<ch>	Channel number of the mixer measurement. If unspecified, value is set to 1.
<n>	Existing segment for which IF Bandwidth is to be set. Use SENS:MIX:SEGM:COUN? to read the current count in the Applied Mixer .
<value>	IF Bandwidth in Hz. The list of valid IF Bandwidths is different depending on the VNA model. (Click to see the lists.) If an invalid number is specified, the analyzer will round up to the closest valid number. This parameter supports MIN and MAX as arguments. Learn more.

Examples

```
SENS:MIX:SEGM1:BWID 1e3
```

Query Syntax

SENSe<ch>:MIXer:SEGMENT<n>:BWIDth?

Send [Apply](#) before sending this query. [Learn more.](#)

Return Type Numeric

Default 10 kHz

SENSe<ch>:MIXer:SEGMENT<n>:CALCulate <char>

Applicable Models: All

(Write only) Calculates the Input, IF, or Output frequencies of the mixer setup and updates the channel settings.

Parameters

<ch> **Any existing channel number. If unspecified, value is set to 1**

<n> Existing segment to calculate. Use [SENS:MIX:SEGM:COUN?](#) to read the current count in the [Applied Mixer](#).

<char> Mixer port to be calculated. Choose from:

<char>	1st or only stage requires:	In addition, 2nd stage requires:
INPut	Output Start and Stop frequencies LO frequency Output sideband (High or Low)	IF Start and Stop frequencies 2nd LO frequency IF sideband (High or Low)
BOTH	NA	IF Start and Stop frequencies Both LO frequencies
OUTPut	Input Start and Stop frequencies LO frequency Output sideband (High or Low)	IF Start and Stop frequencies 2nd LO frequency IF sideband (High or Low)
LO_1	Input Start and Stop frequencies Output frequency	IF Start and Stop frequencies 2nd LO frequency

	Output sideband (High or Low)	IF sideband (High or Low)
LO_2	NA	Input Start and stop frequencies 1st LO start and stop frequencies Output frequency IF sideband(High or Low) Output sideband(High or Low)

Examples **SENS:MIX:SEGM2:CALC Output**

Query Syntax Not Applicable

Default Not Applicable

SENSe<ch>:MIXer:SEGment:COUNT?

Applicable Models: All

(Read-only) Returns the number of segments on the **Applied mixer**.

Parameters

<ch> **Channel number of the mixer measurement. If unspecified, value is set to 1.**

Examples **SENS:MIX:SEGM:COUN?**

Return Type **Numeric**

Default **Not Applicable**



SENSe<ch>:MIXer:SEGment<n>:DELeTe <value>

Applicable Models: All

(Write only) Removes the specified number of segments from the scratch mixer starting at the index position.

Parameters

<ch> Channel number of the mixer measurement. If unspecified, value is set to 1.

<n> Position at which to start removing segments. Valid index range is between 1 and the current segment count. Use **SENS:MIX:SEGM:COUN?** to read the current count in the **Applied Mixer**.

<value> Optional argument. Number of segments to remove. If unspecified, 1 segment is removed.

Examples

```
SENS:MIX:SEGM1:DEL 5 'Removes 5 segments beginning at the first position.
```

Query Syntax Not Applicable

Default Not Applicable

SENSe<ch>:MIXer:SEGment:DELete:ALL

Applicable Models: All

(Write only) Removes all segments from the scratch mixer.

Parameters

<ch> Channel number of the mixer measurement. If unspecified, value is set to 1.

Examples

```
SENS:MIX:SEGM:DEL:ALL
```

Query Syntax Not Applicable

Default Not Applicable

SENSe<ch>:MIXer:SEGment<n>:DWELI

Applicable Models: All

(Read-Write) Sets or returns the Input sweep mode of the segment.

Parameters

<ch> Channel number of the mixer measurement. If unspecified, value is set to 1.

<n> Existing segment for which Input frequency mode is to be set.
Use **SENS:MIX:SEGM:COUN?** to read the current count in the **Applied Mixer**.

Examples

```
SENS : MIX : SEGM2 : DWELI
```

Query Syntax

SENSe<ch>:MIXer:SEGMENT<n>:DWELI?
Send **Apply** before sending this query. [Learn more.](#)

Return Type Character

Default Swept

SENSe<ch>:MIXer:SEGMENT<n>:IF:FREQUENCY:SIDeband <char>

Applicable Models: All

(Read-Write) When **two LO stages are used**, sets or returns whether to select the sum or difference for the IF1 product. (Input + or - LO1 = IF1)



This setting corresponds to the  buttons on LO1 on the **Mixer Setup** dialog.

This setting is ignored when **ONE LO stage** is selected.

Also set **SENS:MIX:OUTP:FREQ:SID** to LOW or HIGH to set the output frequency of the mixer.

Parameters

<ch> Channel number of the mixer measurement. If unspecified, value is set to 1.

<n> Existing segment for which IF Sideband is to be set.
Use **SENS:MIX:SEGM:COUN?** to read the current count in the **Applied Mixer**.

<char> Sideband value. Choose from

LOW - Difference (-)
HIGH - Sum (+)

Examples

```
SENS : MIX : SEGM2 : IF : FREQ : SID LOW
```

Query Syntax

SENSe<ch>:MIXer:SEGMENT<n>:IF:FREQUENCY:SIDeband?
Send **Apply** before sending this query. [Learn more.](#)

Return Type Character

Default

LOW

SENSe<ch>:MIXer:SEGment<n>:INPut:FREQuency:FIXed <value>

Applicable Models: All

(Read-Write) Sets or returns the Input fixed frequency of the segment. Also, set **SENS:MIX:SEGM:INP:FREQ:MODE FIXED.**

Parameters

<ch> Channel number of the mixer measurement. If unspecified, value is set to 1.

<n> Existing segment for which input fixed frequency is to be set. Use **SENS:MIX:SEGM:COUN?** to read the current count in the **Applied Mixer**.

<value> Input fixed frequency. Choose a value between the start and stop frequency of the VNA.

Examples

```
SENSe2:MIXer:SEGment2:INPut:FREQ:FIX 1e9
```

Query Syntax

SENSe<ch>:MIXer:SEGment<n>:INPut:FREQuency:FIXed?
Send **Apply** before sending this query. [Learn more](#).

Return Type Numeric

Default

Start frequency of the VNA.

SENSe<ch>:MIXer:SEGment<n>:INPut:FREQuency:MODE <char>

Applicable Models: All

(Read-Write) Sets or returns the Input sweep mode of the segment.

Parameters

<ch> Channel number of the mixer measurement. If unspecified, value is set to 1.

<n> Existing segment for which Input frequency mode is to be set. Use **SENS:MIX:SEGM:COUN?** to read the current count in the **Applied Mixer**.

<char> Input sweep mode. Choose either FIXED or SWEPT

Examples

```
SENS : MIX : SEGM2 : INP : FREQ : MODE FIXED
```

Query Syntax

SENSe<ch>:MIXer:SEGMENT<n>:INPut:FREQuency:MODE?

Send **Apply** before sending this query. [Learn more.](#)

Return Type

Character

Default

Swept

SENSe<ch>:MIXer:SEGMENT<n>:INPut:FREQuency:STARt <value>

Applicable Models: All

(Read-Write) Sets or returns the Input start frequency value of the segment. Also, set **SENS:MIX:SEGM:FREQ:MODE SWEPT.**

Parameters

<ch>

Channel number of the mixer measurement. If unspecified, value is set to 1.

<n>

Existing segment for which Input start frequency is to be set. Use **SENS:MIX:SEGM:COUN?** to read the current count in the **Applied Mixer.**

<value>

Input Start frequency. Choose a value between the start and stop frequency of the VNA.

Examples

```
SENSe2 : MIXer : SEGMENT2 : INPut : FREQ : STARt 1000000000
```

Query Syntax

SENSe<ch>:MIXer:SEGMENT<n>:INPut:FREQuency:STARt?

Send **Apply** before sending this query. [Learn more.](#)

Return Type

Numeric

Default

Start frequency of the VNA.

SENSe<ch>:MIXer:SEGMENT<n>:INPut:FREQuency:STOP <value>

Applicable Models: All

(Read-Write) Sets or returns the Input stop frequency value of the segment.

Parameters

<ch> Channel number of the mixer measurement. If unspecified, value is set to 1.

<n> Existing segment for which Input stop frequency is to be set.
Use **SENS:MIX:SEGM:COUN?** to read the current count in the **Applied Mixer**.

<value> Input Stop frequency. Choose a value between the start and stop frequency of the VNA.

Examples

```
SENSe2:MIXer:SEGMent2:INPut:FREQ:STOP 1000000000
```

Query Syntax

SENSe<ch>:MIXer:SEGMent<n>:INPut:FREQuency:STOP?

Send **Apply** before sending this query. [Learn more](#).

Return Type Numeric

Default Stop frequency of the VNA.

SENSe<ch>:MIXer:SEGMent<n>:INPut:POWer <value>

Applicable Models: All

(Read-Write) Sets or returns the Input power value of the segment.

Parameters

<ch> Channel number of the mixer measurement. If unspecified, value is set to 1.

<n> Existing segment for which Input power is to be set.
Use **SENS:MIX:SEGM:COUN?** to read the current count in the **Applied Mixer**.

<value> Input power level in dBm. Choose a value within the power range of the VNA.

Examples

```
SENSe2:MIXer:SEGMent2:INPut:POWer 0
```

Query Syntax

SENSe<ch>:MIXer:SEGMent<n>:INPut:POWer?

Send **Apply** before sending this query. [Learn more](#).

Return Type Numeric

Default -15 dBm

SENSe<ch>:MIXer:SEGMENT<n>:LO<x>:FREQUency:FIXed <value>

Applicable Models: All

(Read-Write) Sets or returns the LO1 and LO2 fixed frequency value of the segment.

Parameters

<ch> Channel number of the mixer measurement. If unspecified, value is set to 1.

<n> Existing segment for which the LO1 and LO2 fixed frequency value is to be set.
Use **SENS:MIX:SEGM:COUN?** to read the current count in the **Applied Mixer**.

<x> LO stage number for which the fixed frequency is to be set. Choose 1 or 2.
Set number of stages for the mixer using **SENSe<ch>:MIXer:STAGe**.

<value> The LO1 and LO2 fixed frequency value in Hz. Choose a value within the frequency range of the source.

Examples

```
SENSe2:MIXer:SEGMENT2:LO1:FREQ:FIX 1e9
```

Query Syntax

SENSe<ch>:MIXer:SEGMENT<n>:LO<x>:FREQUency:FIXed?
Send **Apply** before sending this query. [Learn more](#).

Return Type Numeric

Default 0 Hz

SENSe<ch>:MIXer:SEGMENT<n>:LO<x>:FREQUency:ILTI <bool>

Applicable Models: All

(Read-Write) Specifies whether to use the Input frequency that is greater than the LO or less than the LO. To learn more, see the [mixer setup](#) dialog box help.

Parameters

<ch> Channel number of the mixer measurement. If unspecified, value is set to 1.

<n> Existing segment for which the LO1 and LO2 fixed frequency value is to be set.
Use **SENS:MIX:SEGM:COUN?** to read the current count in the **Applied Mixer**.

<x> LO stage number for which ILT is to be set. Choose 1 or 2.
Set number of stages for the mixer using **SENSe<ch>:MIXer:STAGe**.

<bool> ON (1) - Use the Input that is Greater than the specified LO.
OFF (0) - Use the Input that is Less than the specified LO.

Examples

```
SENSe2:MIXer:SEGMENT2:LO1:FREQ:ILTI 1
```

Query Syntax

SENSe<ch>:MIXer:SEGMENT<n>:LO<x>:FREQUENCY:ILTI?
Send **Apply** before sending this query. [Learn more](#).

Return Type Boolean

Default OFF

SENSe<ch>:MIXer:SEGMENT<n>:LO<x>:FREQUENCY:MODE <char>

Applicable Models: All

(Read-Write) Sets or returns the LO1 or LO2 sweep mode of the segment.

Parameters

<ch> Channel number of the mixer measurement. If unspecified, value is set to 1.

<n> Existing segment for which LO frequency mode is to be set.
Use **SENS:MIX:SEGM:COUN?** to read the current count in the **Applied Mixer**.

<x> LO stage number for which ILT is to be set. Choose 1 or 2.
Set number of stages for the mixer using **SENSe<ch>:MIXer:STAGe**.

<char> LO sweep mode. Choose either FIXED or SWEPT

Examples

```
SENS:MIX:SEGM2:LO1:FREQ:MODE FIXED
```

Query Syntax

SENSe<ch>:MIXer:SEGMENT<n>:LO<n>:FREQUENCY:MODE?
Send **Apply** before sending this query. [Learn more](#).

Return Type Character

Default Fixed

SENSe<ch>:MIXer:SEGMENT<n>:LO<x>:FREQUENCY:START <value>

Applicable Models: All

(Read-Write) Sets or returns the LO start frequency value of the segment.

Parameters

<ch> Channel number of the mixer measurement. If unspecified, value is set to 1.

<n> Existing segment for which LO start frequency is to be set.
Use **SENS:MIX:SEGM:COUN?** to read the current count in the **Applied Mixer**.

<x> LO stage number. Choose 1 or 2.
Set number of stages for the mixer using **SENSe<ch>:MIXer:STAGe**.

<value> LO Start frequency. Choose a value between the start and stop frequency of the VNA.

Examples

```
SENSe2:MIXer:SEGment2:LO1:FREQ:START 1000000000
```

Query Syntax **SENSe<ch>:MIXer:SEGment<n>:LO<x>:FREQuency:START?**
Send **Apply** before sending this query. **Learn more**.

Return Type Numeric

Default Start frequency of the VNA.

SENSe<ch>:MIXer:SEGment<n>:LO<x>:FREQuency:STOP <value>

Applicable Models: All

(Read-Write) Sets or returns the LO stop frequency value of the segment.

Parameters

<ch> Channel number of the mixer measurement. If unspecified, value is set to 1.

<n> Existing segment for which LO stop frequency is to be set.
Use **SENS:MIX:SEGM:COUN?** to read the current count in the **Applied Mixer**.

<x> LO stage number. Choose 1 or 2.
Set number of stages for the mixer using **SENSe<ch>:MIXer:STAGe**.

<value> LO Stop frequency. Choose a value between the start and stop frequency of the VNA.

Examples

```
SENSe2:MIXer:SEGMENT2:LO<x>:FREQ:STOP 1000000000
```

Query Syntax

SENSe<ch>:MIXer:SEGMENT<n>:LO<x>:FREQUency:STOP?

Send **Apply** before sending this query. [Learn more.](#)

Return Type

Numeric

Default

Stop frequency of the VNA.

SENSe<ch>:MIXer:SEGMENT<n>:LO<x>:POWER <value>

Applicable Models: All

(Read-Write) Sets or returns the LO power of the segment.

Parameters

<ch>

Channel number of the mixer measurement. If unspecified, value is set to 1.

<n>

Existing segment for which LO power is to be set.

Use **SENS:MIX:SEGM:COUN?** to read the current count in the **Applied Mixer**.

<x>

LO stage number. Choose 1 or 2.

Set number of stages for the mixer using **SENSe<ch>:MIXer:STAGe**.

<value>

LO power level in dBm. Choose a value within the power range of the VNA.

Examples

```
SENSe2:MIXer:SEGMENT2:INPut:POWER 0
```

Query Syntax

SENSe<ch>:MIXer:SEGMENT<n>:INPut:POWER?

Send **Apply** before sending this query. [Learn more.](#)

Return Type

Numeric

Default

-10 dBm

SENSe<ch>:MIXer:SEGMENT<n>:OUTPut:FREQUency:FIXed <value>

Applicable Models: All

(Read-Write) Sets or returns the Output fixed frequency of the segment. Also, set `SENS:MIX:SEGM:INP:FREQ:MODE FIXED`.

Parameters

<ch> Channel number of the mixer measurement. If unspecified, value is set to 1.

<n> Existing segment for which Output fixed frequency is to be set. Use `SENS:MIX:SEGM:COUN?` to read the current count in the **Applied Mixer**.

<value> Output fixed frequency. Choose a value between the start and stop frequency of the VNA.

Examples

```
SENSe2:MIXer:SEGment2:OUTP:FREQ:FIX 1e9
```

Query Syntax **SENSe<ch>:MIXer:SEGment<n>:OUTPut:FREQuency:FIXed?**
Send **Apply** before sending this query. [Learn more](#).

Return Type Numeric

Default Start frequency of the VNA.

SENSe<ch>:MIXer:SEGment<n>:OUTPut:FREQuency:MODE <char>

Applicable Models: All

(Read-Write) Sets or returns the Output sweep mode of the segment.

Parameters

<ch> Channel number of the mixer measurement. If unspecified, value is set to 1.

<n> Existing segment for which Output frequency mode is to be set. Use `SENS:MIX:SEGM:COUN?` to read the current count in the **Applied Mixer**.

<char> Output sweep mode. Choose either FIXED or SWEPT

Examples

```
SENS:MIX:SEGM2:OUTP:FREQ:MODE FIXED
```

Query Syntax **SENSe<ch>:MIXer:SEGment<n>:OUTPut:FREQuency:MODE?**
Send **Apply** before sending this query. [Learn more](#).

Return Type Character

Default

Swept

SENSe<ch>:MIXer:SEGMENT<n>:OUTPut:FREQUency:SIDeband <char>

Applicable Models: All

(Read-Write) When **two LO stages are used**, sets or returns whether to select the sum or difference for the Output product. Use for both 1 or 2 stage mixers.



This setting corresponds to the  buttons on the Output on the **Mixer Frequency** dialog.

Also set **SENS:MIX:IF:FREQ:SID** to LOW or HIGH to determine the IF frequency for 2-stage mixers.

Parameters

<ch> Channel number of the mixer measurement. If unspecified, value is set to 1.

<n> Existing segment for which Output Sideband is to be set.
Use **SENS:MIX:SEGM:COUN?** to read the current count in the **Applied Mixer**.

<char> Sideband value. Choose from
LOW - Difference (-)
HIGH - Sum (+)

Examples

```
SENS:MIX:SEGM2:OUTP:FREQ:SID LOW
```

Query Syntax SENSe<ch>:MIXer:SEGMENT<n>:OUTPut:FREQUency:SIDeband?
Send **Apply** before sending this query. [Learn more](#).

Return Type Character

Default

LOW

SENSe<ch>:MIXer:SEGMENT<n>:OUTPut:FREQUency:STARt <value>

Applicable Models: All

(Read-Write) Sets or returns the Output start frequency value of the segment. Also, set **SENS:MIX:SEGM:FREQ:MODE SWEPT**.

Parameters

<ch> Channel number of the mixer measurement. If unspecified, value is set to 1.

<n> Existing segment for which Output start frequency is to be set. Use **SENS:MIX:SEGM:COUN?** to read the current count in the **Applied Mixer**.

<value> Output Start frequency. Choose a value between the start and stop frequency of the VNA.

Examples

```
SENSe2:MIXer:SEGMent2:OUTPut:FREQ:START 1000000000
```

Query Syntax

SENSe<ch>:MIXer:SEGMent<n>:OUTPut:FREQUency:START?
Send **Apply** before sending this query. [Learn more](#).

Return Type Numeric

Default Start frequency of the VNA.

SENSe<ch>:MIXer:SEGMent<n>:OUTPut:FREQUency:STOP <value>

Applicable Models: All

(Read-Write) Sets or returns the Output stop frequency value of the segment.

Parameters

<ch> Channel number of the mixer measurement. If unspecified, value is set to 1.

<n> Existing segment for which Output stop frequency is to be set. Use **SENS:MIX:SEGM:COUN?** to read the current count in the **Applied Mixer**.

<value> Output Stop frequency. Choose a value between the start and stop frequency of the VNA.

Examples

```
SENSe2:MIXer:SEGMent2:OUTPut:FREQ:STOP 1000000000
```

Query Syntax

SENSe<ch>:MIXer:SEGMent<n>:OUTPut:FREQUency:STOP?
Send **Apply** before sending this query. [Learn more](#).

Return Type Numeric

Default Stop frequency of the VNA.

SENSe<ch>:MIXer:SEGMENT<n>:OUTPut:POWer <value>

Applicable Models: All

(Read-Write) Sets or returns the Output power value of the segment.

Parameters

<ch>	Channel number of the mixer measurement. If unspecified, value is set to 1.
<n>	Existing segment for which Output power is to be set. Use SENS:MIX:SEGM:COUN? to read the current count in the Applied Mixer .
<value>	Output power level in dBm. Choose a value within the power range of the VNA.

Examples

```
SENSe2:MIXer:SEGMENT2:OUTPut:POWer 0
```

Query Syntax

SENSe<ch>:MIXer:SEGMENT<n>:OUTPut:POWer?
Send **Apply** before sending this query. [Learn more](#).

Return Type Numeric

Default -10 dBm

SENSe<ch>:MIXer:SEGMENT<n>:POINts <value>

Applicable Models: All

(Read/Write) Sets and returns the number of data points for the sweep segment.

Parameters

<ch>	Channel number of the mixer measurement. If unspecified, value is set to 1.
<n>	Existing segment for which number of points is to be set. Use SENS:MIX:SEGM:COUN? to read the current count in the Applied Mixer .
<value>	Number of data points. Choose any number between 1 and the VNA maximum number of points . This parameter supports MIN and MAX as arguments. Learn more .

Examples

```
SENS:MIX:SEGM1:POIN 3
```

Query Syntax	SENSe<ch>:MIXer:SEGMENT<n>:POINTs? Send Apply before sending this query. Learn more.
Return Type	Numeric
Default	21

SENSe<ch>:MIXer:SEGMENT<n>:STATe <bool>

Applicable Models: All

(Read/Write) Sets and returns the ON/OFF state for the segment.

Parameters

<ch>	Channel number of the mixer measurement. If unspecified, value is set to 1.
<n>	Existing segment to be set ON or OFF. Use SENS:MIX:SEGM:COUN? to read the current count in the Applied Mixer .
<bool>	Segment state. Choose from: ON (or 1) - Turns the segment ON. OFF (or 0) - Turns the segment OFF

Examples

```
SENS:MIX:SEGM1:STATe 1
```

Query Syntax	SENSe<ch>:MIXer:SEGMENT<n>:STATe? Send Apply before sending this query. Learn more.
Return Type	Boolean
Default	ON

SweepPulse

Configures the channel to make pulse measurements using **the Integrated Pulse Application**.

SENSe:SWEep:PULSe

```
CWTime
DETECTmode[:AUTO]
DRIVE[:AUTO]
IFBW[:AUTO]
IFGain[:AUTO]
MASTer:
  | FREQuency
  | PERiod
  | WIDTh
MODE
  PRF[:AUTO]
PROFile
  | STARt
  | STOP
  SHAPe
  | CAalog?
SWGate
TIMing[:AUTO]
WIDeband[:STATe]
```

Click on a keyword to view the command details.

See Also

[Example Program](#) using these commands.

[SENSe:PULSe](#) commands used to configure the pulse generators.

[Synchronizing the Analyzer and Controller](#)

[SCPI Command Tree](#)

SENSe<ch>:SWEep:PULSe:CWTime[:AUTO] <bool>

Applicable Models: VNAs with Pulsed RF Measurement Option

(Read-Write) This command replaces **SENSe:SWEep:PULSe:IFBW[:AUTO]**. Sets and returns the state of automatic CW sweep time (used in Pulse Profile mode). This setting is labeled Autoselect Profile Sweep Time on the UI.

Parameters

- <ch> Channel number of the pulse measurement. If unspecified, value is set to 1.
- <bool> Choose from:
- OFF (or O) - The Sweep Time is not changed automatically.
- ON (or 1) - In Pulse Profile mode, adjusts the default X-axis start time to zero and the stop time to double the Pulse Width. This allows you to see one complete pulse.

Examples

```
SENS:SWE:PULS:CWT 1
sense2:sweep:pulse:cwtime:auto off
```

Query Syntax

SENSe<ch>:SWEep:PULSe:CWTime[:AUTO]?

Return Type

Boolean

Default

ON

SENSe<ch>:SWEep:PULSe:DETECTmode[:AUTO] <bool>

(Read-Write) Set pulse mode automatically or manually (Narrowband or Wideband) for the channel. This setting is labeled Autoselect Pulse Detection Method on the UI.

Parameters

- <ch> Channel number of the pulse measurement. If unspecified, value is set to 1.
- <bool> Choose from:
- OFF (or O) - Manually set the pulse mode. Use **SENSe:SWEep:PULSe:WIDE** to set the pulse mode.
- ON (or 1) - Automatically set the pulse mode.

Examples

```
SENS:SWE:PULS:DET 1
sense2:sweep:pulse:detectmode:auto off
```

Query Syntax

SENSe<ch>:SWEep:PULSe:DETECTmode[:AUTO]?

Return Type Boolean

Default ON

SENSe<ch>:SWEep:PULSe:DRIVe[:AUTO] <bool>

Applicable Models: VNAs with Pulsed RF Measurement Option
(Read-Write) In Narrowband pulse mode, set the drive for the source modulation automatically or manually.

Parameters

<ch> Channel number of the pulse measurement. If unspecified, value is set to 1.

<bool> Choose from:

OFF (or O) - Manually set source modulation.

ON (or 1) - Automatically set pulse gen 1 as the modulation source and pulse gen 2 as the gate source for all gates.

Examples

```
SENS:SWE:PULS:DRIV 1
sense2:sweep:pulse:drive:auto off
```

Query Syntax

SENSe<ch>:SWEep:PULSe:DRIVe[:AUTO]?

Return Type Boolean

Default ON

SENSe<ch>:SWEep:PULSe:IFBW[:AUTO] <bool> - Superseded

Applicable Models: VNAs with Pulsed RF Measurement Option (Except M9485A)
(Read-Write) This command is replaced with **SENS:SWEep:PULSe:CWTime[:AUTO]**.
In Wideband pulse mode, set the IF bandwidth automatically or manually.

Parameters

<ch> Channel number of the pulse measurement. If unspecified, value is set to 1.

<bool> Choose from:

OFF (or O) - Manually set the IFBW for the measurement.

ON (or 1) - Automatically set the IFBW for the measurement.

Examples

```
SENS:SWE:PULS:IFBW 1
sense2:sweep:pulse:ifbw:auto off
```

Query Syntax

SENSe<ch>:SWEep:PULSe:IFBW[:AUTO]?

Return Type

Boolean

Default

ON

SENSe<ch>:SWEep:PULSe:IFGain[:AUTO] <bool>

Applicable Models: VNAs with Pulsed RF Measurement Option (Except M9485A, M980xA, P50xxA)

(Read-Write) In Narrowband pulse mode, set the IF Gain automatically or manually. This setting is labeled Autoselect IF Path Gain and Loss on the UI.

Parameters

<ch>

Channel number of the pulse measurement. If unspecified, value is set to 1.

<bool>

Choose from:

OFF (or O) - Manually set the IF Gain for the measurement.

ON (or 1) - Automatically set the IF Gain for the measurement.

Examples

```
SENS:SWE:PULS:IFG 1
sense2:sweep:pulse:ifgain:auto off
```

Query Syntax

SENSe<ch>:SWEep:PULSe:IFGain[:AUTO]?

Return Type

Boolean

Default

ON

SENSe<ch>:SWEep:PULSe:MASTer:FREQuency <value>

Applicable Models: VNAs with Pulsed RF Measurement Option

(Read-Write) Sets and returns the master pulse measurement frequency.

The frequency is 1/period, so this value can also be set using **SENS:SWE:PULS:MAST:PERiod**.

Note: On the **Pulse Setup dialog**, this command is a 'Basic setting, which is intended to be used with the 'Auto' selections set to ON.

Parameters

<ch> Channel number of the pulse measurement. If unspecified, value is set to 1.

<value> Master frequency. Choose a value between

Examples

```
SENS:SWE:PULS:MAST:FREQ 1e9
sense2:sweep:pulse:master:frequency 1e6
```

Query Syntax

SENSe<ch>:SWEep:PULSe:MASTer:FREQuency

Return Type Value

Default 1 kHz

SENSe<ch>:SWEep:PULSe:MASTer:PERiod <value>

Applicable Models: VNAs with Pulsed RF Measurement Option
(Read-Write) Sets and returns the master pulse period.

The period is 1/frequency, so this value can also be set using **SENS:SWE:PULS:MAST:FREQ.**

Note: On the **Pulse Setup dialog**, this command is a 'Basic' setting, which is intended to be used with the 'Auto' selections set to ON.

Parameters

<ch> Channel number of the pulse measurement. If unspecified, value is set to 1.

<value> Master period in seconds.

Examples

```
SENS:SWE:PULS:MAST:PER 1e-6
sense2:sweep:pulse:master:period 1e-3
```

Query Syntax

SENSe<ch>:SWEep:PULSe:MASTer:PERiod?

Return Type Value

Default 1 msec

SENSe<ch>:SWEep:PULSe:MASTer:WIDth <value>

Applicable Models: VNAs with Pulsed RF Measurement Option
(Read-Write) Sets and returns the master pulse width.

Note: On the **Pulse Setup dialog**, this command is a 'Basic' setting, which is intended to be used with the 'Auto' selections set to ON.

Parameters

<ch> Channel number of the pulse measurement. If unspecified, value is set to 1.

<value> Master pulse width in seconds..

Examples

```
SENS:SWE:PULS:MAST:WIDTH
sense2:sweep:pulse:master:width
```

Query Syntax

SENSe<ch>:SWEep:PULSe:MASTer:WIDTH?

Return Type Value

Default 100 microseconds

SENSe<ch>:SWEep:PULSe:MODE <char>

Applicable Models: VNAs with Pulsed RF Measurement Option (Read-Write) Sets and returns the pulse measurement state for the channel.

Parameters

<ch> Channel number of the pulse measurement. If unspecified, value is set to 1.

<char> Choose from:

OFF - Turn OFF pulse measurements.

STD - Turn ON standard pulse measurements.

PROFILE - Turn ON pulse profile measurements.

Examples

```
SENS:SWE:PULS:MODE PROFILE
sense2:sweep:pulse:mode off
```

Query Syntax

SENSe<ch>:SWEep:PULSe:MODE?

Return Type Character

Default OFF

SENSe<ch>:SWEep:PULSe:PRF[:AUTO] <bool>

Applicable Models: VNAs with Pulsed RF Measurement Option (Except M9485A, M980xA, P50xxA)

(Read-Write) In Narrowband pulse mode, choose to set the Pulse Repetition Frequency automatically or manually. This is labeled "Optimize Pulse Frequency" on the user-interface. To make changes manually, use **SENS:SWE:PULS:MAST:FREQ** or **SENS:SWE:PULS:MAST:PER**.

Parameters

<ch> Channel number of the pulse measurement. If unspecified, value is set to 1.

<bool> Choose from:
OFF (or O) - Manually set the PRF for the measurement.
ON (or 1) - Automatically set the PRF for the measurement.

Examples

```
SENS:SWE:PULS:PRF 1  
sense2:sweep:pulse:prf:auto off
```

Query Syntax

SENSe<ch>:SWEep:PULSe:PRF[:AUTO]?

Return Type Boolean

Default ON

SENSe<ch>:SWEep:PULSe:PROFile:STARt <value>

Applicable Models: VNAs with Pulsed RF Measurement Option
(Read-Write) Sets and returns the start time of the pulse. Pulse profile measurements provide a time domain (CW frequency) view of the pulse envelope. Profiling is performed using a measurement technique that "walks" a narrow receiver "snapshot" across the width of the pulse. This is analogous to using a camera to take many small snapshots of a wide image, then piecing them together to form a single, panoramic view.

Parameters

<ch> Channel number of the pulse measurement. If unspecified, value is set to 1.

<value> Start time in seconds.

Note: The start value cannot be negative.

Examples

```
SENS:SWE:PULS:PROF:STAR 1e-6  
sense2:sweep:pulse:profile:start 1e-3
```

Query Syntax **SENSE<ch>:SWEep:PULSe:PROFile:START?**

Return Type Value

Default 0

SENSE<ch>:SWEep:PULSe:PROFile:STOP <value>

Applicable Models: VNAs with Pulsed RF Measurement Option
(Read-Write) Sets and returns the stop time of the pulse. Pulse profile measurements provide a time domain (CW frequency) view of the pulse envelope. Profiling is performed using a measurement technique that "walks" a narrow receiver "snapshot" across the width of the pulse. This is analogous to using a camera to take many small snapshots of a wide image, then piecing them together to form a single, panoramic view.

Parameters

<ch> Channel number of the pulse measurement. If unspecified, value is set to 1.

<value> Stop time in seconds.

Note: The stop value cannot be negative.

Examples

```
SENS:SWE:PULS:PROF:STOP 1e-6  
sense2:sweep:pulse:profile:stop 1e-3
```

Query Syntax **SENSE<ch>:SWEep:PULSe:PROFile:STOP?**

Return Type Value

Default N/A

SENSE<ch>:SWEep:PULSe:SHAPE <char>

Applicable Models: VNAs with Pulsed RF Measurement Option

(Read-Write) Sets and returns the pulse shape type.

Parameters

<ch> Channel number of the pulse measurement. If unspecified, value is set to 1.

<char> Choose from:

NORMal - Normal pulse shape

FAST - Fast rise time with low on/off ratio. This is available only for M9800A, M9301A, M9302A, M9303A, M9304A, P5000A, P5001A, P5002A, P5003A, P5004A, P5020A, P5021A, P5022A, P5023A, P5024A

Examples

```
SENS:SWE:PULS:SHAP "FAST"  
sense2:sweep:pulse:shape "FAST"
```

Query Syntax

SENSe<ch>:SWEep:PULSe:SHAPE?

Return Type

Character

Default

NORMal

SENSe<ch>:SWEep:PULSe:SHAPE:CATalog?

Applicable Models: VNAs with Pulsed RF Measurement Option

(Read-Write) Returns the list of available pulse shape type.

Parameters

<ch>

Channel number of the pulse measurement. If unspecified, value is set to 1.

Examples

```
SENS:SWE:PULS:SHAP:CAT?  
sense2:sweep:pulse:shape:catalog?
```

Query Syntax

SENSe<ch>:SWEep:PULSe:SHAPE:CATalog?

Return Type

Character

Default

Not applicable

SENSe<ch>:SWEep:PULSe:SWGate[:STATe] <bool>

Applicable Models: VNAs with Pulsed RF Measurement Option (Except M9485A, M980xA, P50xxA)

(Read-Write) When set to OFF, the improved software gating sensitivity is turned OFF and all data outside the measurement band is zeroed. This setting is used for troubleshooting purposes.

Parameters

<ch> Channel number of the pulse measurement. If unspecified, value is set to 1.

<bool> Choose from:
OFF (or O) - Turn OFF software gating.
ON (or 1) - Turn ON software gating.

Examples

```
SENS:SWE:PULS:SWG 0  
sense2:sweep:pulse:swgate:state on
```

Query Syntax **SENSe<ch>:SWEep:PULSe:SWGate[:STATe]?**

Return Type Boolean

Default ON

SENSe<ch>:SWEep:PULSe:TIMing[:AUTO] <bool>

Applicable Models: VNAs with Pulsed RF Measurement Option
(Read-Write) In Narrowband pulse mode, choose to set the delay and width automatically or manually. This setting is labeled Autoselect Width and Delay on the UI.

Parameters

<ch> Channel number of the pulse measurement. If unspecified, value is set to 1.

<bool> Choose from:
OFF (or O) - Manually set the delay and width for the measurement.
ON (or 1) - Automatically set the delay and width for the measurement.

Examples

```
SENS:SWE:PULS:TIM 1  
sense2:sweep:pulse:timing:auto off
```

Query Syntax **SENSe<ch>:SWEep:PULSe:TIMing[:AUTO]?**

Return Type Boolean

Default ON

SENSe<ch>:SWEep:PULSe:WIDeband[:STATe] <bool>

Applicable Models: VNAs with Pulsed RF Measurement Option (Except M9485A, M980xA, P50xxA)

(Read-Write) Set and read the pulse mode detection method.

Parameters

<ch> Channel number of the pulse measurement. If unspecified, value is set to 1.

<bool> Choose from:
OFF (or 0) - Narrowband mode.
ON (or 1) - Wideband mode

Examples

```
SENS:SWE:PULS:WID 1  
sense2:sweep:pulse:wideband:state off
```

Query Syntax **SENSe<ch>:SWEep:PULSe:WIDeband[:STATe]?**

Return Type Boolean

Default Based on pulse width

Temperature

Applicable Models: M937xA

(Read-only) Returns the temperature on the Receiver microcircuit.

To read temperature from the SFP, press System, then Service, then Utilities, then Receiver Temperature.

The temperature reading is updated with every sweep.

Parameters

<char>	Choose from CELSius or FAHRenheit
<mod>	Module number. If unspecified, value is set to 1. Learn how to determine module number.

Examples

```
SENS:TEMP? CELS  
sense:temperature? fahrenheit,2
```

Return Type Numeric

Default Not Applicable

SourceDC

Controls the internal and external DC sources.

- SOURce:DC:**
- | [CATalog?](#)
- | **CURRent**
- | **CLAMp**
- | [NEGative](#)
- | [POSitive](#)
- | **RANGe**
- | **DATA**
- | **ENABle**
- | **LIMit**
- | **MAXimum**
- | **MINimum**
- | **LOCK:OUTPut:RELAy:CLOSeD**
- | **PROTection**
- | [CATalog?](#)
- | **ENABle**
- | **LEVeL**
- | **RESet**
- | **SEQuencing[:STATe]**
- | **STIMe**
- | **STARt**
- | **STATe**
- | **STOP**
- | **TYPE**
- | **VOLTage**
- | **CALibrate**
- | **DATE**
- | **EXECute**
- | **TIME**
- | **BANDwidth**
- | **CLAMp**
- | **RANGe**

Click on a keyword to view the command details.

Note: The VNA internal DC sources are named "AO1" and "AO2" using CAPITAL O (NOT zero - 0)

See Also

[Learn about DC Source control](#)

[Configure an Ext DC Device \(SCPI commands\)](#)

[Example Programs](#)

[Synchronizing the Analyzer and Controller](#)

[SCPI Command Tree](#)

[Remotely Specifying a Source Port](#)

SOURce<ch>:DC:CATalog?

Applicable Models: N524xB, E5080B, All PXIe/USB VNAs

(Read-only) Returns the names of the configured and active DC sources for the specified channel. Use **SYST:CONF:EDEV:CAT?** to read a list of all configured external devices, including inactive devices.

Parameters

<ch> Any existing channel number. If unspecified, value is set to 1

Examples

```
SOUR:DC:CAT?  
'Returns the following...  
"AO1,AO2,MyDCSupply"  
'AO1 and AO2 are PNA-X internal DC Sources
```

Return Type String, Names are separated by commas.

Default Not Applicable

SOURce<ch>:DC:CURRENT:CLAMP:NEGative <name>,<num>

Applicable Models: All PXIe VNAs

(Read-Write) Sets and returns the negative current limit (in Amps) when output regulation is in voltage priority mode. This command is available for PXI SMU only. This is the same function with "IKtM911xOutputChannelCurrent Interface" section, "NegativeLimit" property of the M911x driver.

Parameters

<ch> Any existing channel number. If unspecified, value is set to 1

<name> String. DC Source Name. The name and port must EXACTLY match those in the [DC Source Control dialog](#).

<num> Negative current limit value in Amps

Examples `SOUR2:DC:CURR:CLAM:NEG "SMU1",-2`

Query Syntax `SOURce<ch>:DC:VOLTage:CLAMp:NEGative? <name>`

Return Type Numeric

Default -3.06

SOURce<ch>:DC:CURRent:CLAMp:POSitive <name>,<num>

Applicable Models: All PXIe VNAs

(Read-Write) Sets and returns the positive current limit (in Amps) when output regulation is in voltage priority mode. This command is available for PXI SMU only. This is the same function with "IKtM911xOutputChannelCurrent Interface" section, "PositiveLimit" property of the M911x driver.

Parameters

<ch> Any existing channel number. If unspecified, value is set to 1

<name> String. DC Source Name. The name and port must EXACTLY match those in the [DC Source Control dialog](#).

"SMU*" represents the SMU DC Meter name. "*" is the SMU module number.

<num> Positive current limit value in Amps

Examples `SOUR2:DC:CURR:CLAM:POS "SMU1",2`

Query Syntax `SOURce<ch>:DC:VOLTage:CLAMp:POSitive? <name>`

Return Type Numeric

Default 3.06

SOURce<ch>:DC:CURRent:RANGe <name>,<num>

Applicable Models: All PXIe VNAs

(Read-Write) Sets and returns a current output range in Amps. This command is available for both PXI SMU and Digital/Analog I/O M9341B. For PXI SMU, this is the same function with “IKtM911xOutputChannelCurrent.Range Property” section of the M911x driver.

Parameters

<ch> Any existing channel number. If unspecified, value is set to 1
[M9341B] If different setting is set between channels, the channel which is not same as active channel will be blocked to avoid wearing out an internal mechanical relay. SENSE:SWEep:BLOCKed? can detect the blocked status.

<name> String. DC Source Name. The name and port must EXACTLY match those in the **DC Source Control dialog**.
[SMU] "SMU*" represents the SMU DC Meter name. "*" is the SMU module number.

[M9341B] "AO1" or "AO2"

<num> [SMU] Current range in Amps (0.01 or 3)
[M9341B] **Current range in Amps. The range is 0.5 to 0.05, but Analog Out2 can't be set to 0.5. If an invalid number is specified, the analyzer will round up to the closest valid number.**
AO1 (Mode1: 0.5, Mode2: 0.05)
AO2 (Mode1: 0.1, Mode2: 0.05)

Examples `SOUR2:DC:CURR:RANG "SMU1",1m`

Query Syntax `SOURce<ch>:DC:CURREnt:RANGe? <name>`

Return Type Numeric

Default (SMU) 3, (M9341B) 0.05

SOURce<ch>:DC:DATA <name[,port]>,<data>

Applicable Models: N524xB, E5080B, All PXIe/USB VNAs

(Read-Write) Sets and returns the DC stimulus values per point to be sent from the specified DC source.

This setting overrides the Start and Stop DC settings for the channel. Only the values that are set with this command can be read by this command. The read command does NOT read the values that are set using the Start and Stop settings.

Parameters

- <ch>** Any existing channel number. If unspecified, value is set to 1
- <name[,port]>** String. The name and port must EXACTLY match those in the **DC Source Control dialog**.
- name - DC Source Name. See **note for specifying internal DC Sources**.
- [port] - Optional. VNA port for DC Source data. This is equivalent to the <per port> setting in the **DC Source Control dialog**.
- If unspecified, data is applied to ALL ports.

Important: When you specify a port for this command, it must also be included for ALL DC Source commands that have this optional [port] specifier.

- <data>** The stimulus value array to be set. The size of the array should be equal to the sweep point number.

Examples

```
'Set 3 data points on the channel
scpi.Execute "SENS:SWE:POIN 3"
'Enable DC Source output
scpi.Execute "SOUR:DC:ENAB ON"
'Set AO1 state to be always ON (no port value)
scpi.Execute "SOUR:DC:STATE 'AO1',ON"
'Set DC value for each data point
scpi.Execute "SOUR:DC:DATA 'AO1',1,5,1"
'Read data back
data = scpi.Execute ("SOUR:DC:DATA? 'AO1'")
msgbox data
```

Query Syntax **SOURCE<ch>:DC:DATA? <name[,port]>**

Return Type Comma-separated values

Default Not Applicable

SOURCE<ch>:DC:ENABLE <bool>

Applicable Models: N524xB, E5080B, All PXIe/USB VNAs

(Read-Write) Sets and returns the ON / Off state of all configured DC sources for the specified channel. This setting is the same as the checkbox at the top of the **DC Source Control dialog**.

Individual DC sources must ALSO be enabled using **SOUR:DC:STATe**.

Use **SYST:CONF:EDEV:CAT?** to read a list of all configured external devices.

Use **SOUR:DC:CAT?** to read a list of ACTIVE configured DC source names

Parameters

- <ch>** Any existing channel number. If unspecified, value is set to 1.
- <bool>** ON / Off state. Choose from:
 - ON or 1 - All DC sources enabled.
 - OFF or 0 - All DC sources disabled.

Examples

```
SOUR:DC:ENAB 0
```

Query Syntax

SOURce<ch>:DC:ENABLE?

Return Type

Boolean

Default

1

SOURce<ch>:DC:LIMit:MAXimum <name>,<num>

Applicable Models: All

(Read-Write) Sets and returns the Max DC limit value for a DC source.

Parameters

- <ch>** Any existing channel number. If unspecified, value is set to 1.
- <name>** String. DC Source Name. See **note for specifying internal DC Sources**. The name must EXACTLY match those in the **DC Source Control dialog**.

<num> Max DC limit value. Choose a value within the range of the DC source.

Examples

```
SOUR2:DC:LIM:MAX "myDCSource",10
source:dc:limit:maximum "myDCSource",10
```

Query Syntax

SOURce<ch>:DC:LIMit:MAXimum? <name>

Return Type Numeric

Default 10

SOURce<ch>:DC:LIMit:MINimum <name>,<num>

Applicable Models: All

(Read-Write) Sets and returns the Min DC limit value for a DC source.

Parameters

<ch> Any existing channel number. If unspecified, value is set to 1.

<name> String. DC Source Name. See [note for specifying internal DC Sources](#). The name must EXACTLY match those in the [DC Source Control dialog](#).

<num> Min DC limit value. Choose a value within the range of the DC source.

Examples

```
SOUR2:DC:LIM:MIN "myDCSource",-10
source:dc:limit:minimum "myDCSource",-10
```

Query Syntax

SOURce<ch>:DC:LIMit:MINimum? <name>

Return Type Numeric

Default -10

SOURce<ch>:DC:LOCK:OUTPut:RELay:CLOSeD <name>, <bool>

Applicable Models: All PXIe VNAs

(Read-Write) Sets and reads the locked-down state of the output relays on SMU units with output relays. When enabled/locked, the output relays remain closed. When disabled, the output relays open and close as the output toggles on and off. This command is available for PXI SMU only. This is the same function with “IKtM911xOutputChannelRelay Interface” section, “LockEnabled” property of the M911x driver.

Parameters

- <ch>** Any existing channel number. If unspecified, value is set to 1. This command is common for all channels and the setting is ignored.
- <name>** String. DC Source Name. The name must EXACTLY match those in the **DC Source Control dialog**.
- <bool>** ON / Off state. Choose from:
 ON or 1 - The output relays remain closed
 OFF or 0 - The output relays open and close as the output toggles on and off.

Examples

```
SOUR:DC:LOCK:OUTP:REL:CLOS 0
```

Query Syntax

```
SOURce<ch>:DC:LOCK:OUTPut:RELAy:CLOSeD? <name>
```

Return Type

Boolean

Default

0

SOURce<ch>:DC:PROTection:CATalog?

Applicable Models: All PXIe VNAs, E5080B

(Read-only) Returns the module list or name of DC source in which protection function is activated due to over current or voltage. This command is available for both PXI SMU and Digital/Analog I/O M9341B and E5080B.

Parameters

- <ch>** Any existing channel number. If unspecified, value is set to 1. This command is common for all channels and the setting is ignored.

Examples

```
SOUR:DC:PROT:CAT?
```

Query Syntax	SOURce<ch>:DC:PROTection:CATalog?
Return Type	String, Names are separated by commas. "NONE" is returned if no modules are detected.
Default	Not Applicable

SOURce<ch>:DC:PROTection:ENABLE <name>, <bool>

Applicable Models: All PXIe VNAs

(Read-Write) Sets and reads the DC output protection state. This command is available for PXI SMU only.

Parameters

<ch>	Any existing channel number. If unspecified, value is set to 1. This command is common for all channels and the setting is ignored.
<name>	String. DC Source Name. The name must EXACTLY match those in the DC Source Control dialog .
<bool>	ON / Off state. Choose from: ON or 1 - Enable the protection OFF or 0 - Disable the protection.

Examples

```
SOUR:DC:PROT:ENAB "SMU1", 0
```

Query Syntax	SOURce<ch>:DC:PROTection:ENABLE? <name>
Return Type	Boolean
Default	1

SOURce<ch>:DC:PROTection:LEVEl <name>, <num>

Applicable Models: All PXIe VNAs

(Read-Write) Sets and reads the protection voltage level for the DC output. This command is available for PXI SMU only.

Parameters

<ch>	Any existing channel number. If unspecified, value is set to 1. This command is common for all channels and the setting is ignored.
<name>	String. DC Source Name. The name must EXACTLY match those in the DC Source Control dialog .
<bool>	Protection voltage level in Volts
Examples	<code>SOUR:DC:PROT:LEV "SMU1", 10</code>
Query Syntax	<code>SOURce<ch>:DC:PROTection:LEVel? <name></code>
Return Type	Numeric
Default	14.4

SOURce<ch>:DC:PROTection:RESet <name>

Applicable Models: All PXIe VNAs, E5080B

(Write Only) Resets the instrument's output protection circuit after a protection condition occurs. If successful, the output will return to the output enabled state. Remove the fault condition that caused the protection trip before resetting the protection circuit in order to prevent the protection from tripping again. This command is available for both PXI SMU and Digital/Analog I/O M9341B and E5080B.

Parameters

<ch>	Any existing channel number. If unspecified, value is set to 1. This command is common for all channels and the setting is ignored.
<name>	String. DC Source Name. The name must EXACTLY match those in the DC Source Control dialog . [SMU] "SMU*" represents the SMU DC Meter name. "*" is the SMU module number. [M9341B] "AO1" or "AO2" [E5080B] "AO1" or "AO2" or both

Examples	<code>SOUR:DC:PROT:RES "SMU1"</code>
Query Syntax	Not Applicable
Return Type	Not Applicable

Default Not Applicable

SOURce<ch>:DC:NAMes?

Applicable Models: N524xB, E5080B, All PXIe/USB VNAs

(Read-only) Reads the DC source names

Parameters

<ch> Any existing channel number. If unspecified, value is set to 1

Examples

```
SOUR:DC:NAM?
```

Query Syntax

SOURce<ch>:DC:NAMes?

Return Type

Default Not Applicable

SOURce<ch>:DC:SEQuencing[:STATe] <bool>

Applicable Models: All PXIe VNAs

(Read-Write) Sets and reads the DC output sequencing state. This command is valid for SMU sources only. Other DC sources, such as “AO1”, “AO2”, do not have the sequencing control. This command is available for PXI SMU only.

Parameters

<ch> Any existing channel number. If unspecified, value is set to 1.

<name> String. DC Source Name. The name must EXACTLY match those in the [DC Source Control dialog](#).

<bool> ON / Off state. Choose from:

ON or 1

OFF or 0

Examples

```
SOUR:DC:SEQ 1
```

Query Syntax

SOURce<ch>:DC:SEQuencing[:STATe]?

Return Type	Boolean
Default	0

SOURce<ch>:DC:SEQuencing:STIMe <num>

Applicable Models: All PXIe VNAs

(Read-Write) Sets and reads the DC output sequencing settling time. This command is available for PXI SMU only. Other DC sources, such as “AO1”, “AO2”, do not have the sequencing control.

Parameters

<ch>	Any existing channel number. If unspecified, value is set to 1.
<name>	String. DC Source Name. The name must EXACTLY match those in the DC Source Control dialog .
<bool>	Source settling time in second.

Examples

```
SOUR:DC:SEQ:STIM 1
```

Query Syntax

```
SOURce<ch>:DC:SEQuencing:STIMe?
```

Return Type Numeric

Default 0

SOURce<ch>:DC:STARt <name[,port]>,<num>

Applicable Models: N524xB, E5080B, All PXIe/USB VNAs

(Read-Write) Sets and returns start DC value for the specified DC source.

Parameters

<ch>	Any existing channel number. If unspecified, value is set to 1
<name[,port]>	String. The name and port must EXACTLY match those in the DC Source Control dialog . name - DC Source Name. See note for specifying internal DC Sources .

[port] - Optional. VNA port for DC Source start value. This is equivalent to the <per port> setting in the [DC Source Control dialog](#).

If unspecified, DC Start value is applied for ALL ports.

Important: When you specify a port for this command, it must also be included for ALL DC Source commands that have this optional [port] specifier.

<num> Start value. Choose a value within the range of the DC source.

Examples

```
SOUR2:DC:START "myDCSource", 3
source:dc:start "AO1,Port 1", 1
```

Query Syntax

SOURCE<ch>:DC:START? <name[,port]>

Return Type Numeric

Default .5

SOURCE<ch>:DC:STATE <name[,port]>,<bool>

Applicable Models: N524xB, E5080B, All PXIe/USB VNAs

(Read-Write) Sets and returns the ON / Off state of the specified DC source and port.

Use [SYST:CONF:EDEV:CAT?](#) to read a list of all configured external devices.

Use [SOUR:DC:CAT?](#) to read a list of ACTIVE configured DC source names

Parameters

<ch> Any existing channel number. If unspecified, value is set to 1

<name[,port]> String. The name and port must EXACTLY match those in the [DC Source Control dialog](#).

name - DC Source Name. See [note for specifying internal DC Sources](#).

[port] - Optional. VNA port for DC Source state. This is equivalent to the <per port> setting in the [DC Source Control dialog](#).

If unspecified, DC is ALWAYS ON or OFF for ALL ports.

Important: When you specify a port for this command, it must also be included for ALL DC Source commands that have this optional [port] specifier.

<bool> ON / Off state. Choose from:

ON or 1 - DC source/port enabled.

OFF or 0 - DC source/port disabled.

Examples

```
'Set AO1 to always ON
source:dc:state "AO1",1
'Set MyDCSource to ON when RF source Port 1 is ON
SOUR:DC:STAT "MyDCSource,Port 1",ON
'Read state for MyDCSource,Port 1
SOUR:DC:STAT? "MyDCSource,Port 1"
```

Query Syntax

SOURce<ch>:DC:STATE? <name[,port]>

Return Type

Boolean

Default

0 - OFF

SOURce<ch>:DC:STOP <name[,port]>,<num>

Applicable Models: N524xB, E5080B, All PXIe/USB VNAs

(Read-Write) Sets and returns stop DC value for the specified DC source.

Parameters

<ch>

Any existing channel number. If unspecified, value is set to 1

<name[,port]>

String. The name and port must EXACTLY match those in the **DC Source Control dialog**.

name - DC Source Name. See **note for specifying internal DC Sources**.

[port] - Optional. VNA port for DC Stop value. This is equivalent to the <per port> setting in the **DC Source Control dialog**.

If unspecified, DC Stop is applied for ALL ports.

Important: When you specify a port for this command, it must also be included for ALL DC Source commands that have this optional [port] specifier.

<num>

Stop value. Choose a value within the range of the DC source.

Examples

```
SOUR2:DC:STOP "myDCSource", 3
```

Query Syntax

SOURce<ch>:DC:STOP?<name[,port]>

Return Type	Numeric
Default	0

SOURce<ch>:DC:TYPE <name>,<char>

Applicable Models: All PXIe VNAs

(Read-Write) Sets and returns the output regulation mode. This command is available for PXI SMU only. This is the same function with “IKtM911xOutputChannel Interface” section, “PriorityMode” property of the M911x driver.

Parameters

<ch>	Any existing channel number. If unspecified, value is set to 1
<name>	String. DC Source Name. The name and port must EXACTLY match those in the DC Source Control dialog .
<char>	Source control type. VOLTage - voltage priority CURRent - current priority

Examples

```
SOUR2:DC:TYPE "SMU1",VOLT
```

Query Syntax

```
SOURce<ch>:DC:TYPE? <name>
```

Return Type Character

Default VOLTage

SOURce<ch>:DC:VOLTage:CALIBrate:DATE <name>

Applicable Models: All PXIe VNAs

(Read only) Returns the date of execution output voltage calibration. This command is available for M9341B only.

Parameters

<ch>	Any existing channel number. If unspecified, value is set to 1. This command is common for all channels and the setting is ignored.
-------------------	---

<name>	String. DC Source Name. The name and port must EXACTLY match those in the DC Source Control dialog "AO1" or "AO2" or both.
Examples	<code>SOUR2:DC:VOLT:CALB:DATE? "AO1,AO2"</code>
Query Syntax	<code>SOURce<ch>:DC:VOLTage:CALIbrate:DATE? <name></code>
Return Type	String. Comma separated numbers representing year, month and day.
Default	Not Applicable

SOURce<ch>:DC:VOLTage:CALIBrate:EXECute <name>

Applicable Models: All PXIe VNAs

(Write only) Execute the output voltage calibration for both AO1 and AO2. The calibration is finished within 1 second, so this is not an overlapped command. This command is available for M9341B only.

Parameters

<ch>	Any existing channel number. If unspecified, value is set to 1. This command is common for all channels and the setting is ignored.
<name>	String. DC Source Name. The name and port must EXACTLY match those in the DC Source Control dialog "AO1" or "AO2" or both. Even either "AO1" or "AO2" is selected, both ports are calibrated at the same time.

Examples	<code>SOUR2:DC:VOLT:CALB:EXEC "AO1,AO2"</code>
Query Syntax	Not Applicable
Return Type	Not Applicable
Default	Not Applicable

SOURce<ch>:DC:VOLTage:CALIBrate:TIME <name>

Applicable Models: All PXIe VNAs

(Read only) Returns the time of execution output voltage calibration. If the calibration is not executed, “[SCPI: 1111]: Calibration data is missing.” is returned. This command is available for M9341B only.

Parameters

- <ch>** Any existing channel number. If unspecified, value is set to 1. This command is common for all channels and the setting is ignored.
- <name>** String. DC Source Name. The name and port must EXACTLY match those in the **DC Source Control dialog**
“AO1” or “AO2” or both.

Examples

```
SOUR2:DC:VOLT:CALB:TIME? "AO1, AO2"
```

Query Syntax

SOURce<ch>:DC:VOLTage:CALibrate:TIME? <name>

Return Type

String. Comma separated numbers representing hours, minutes and seconds.

Default

Not Applicable

SOURce<ch>:DC:VOLTage:BANDwidth <name>,<string>

Applicable Models: All PXIe VNAs

(Read-Write) Sets and returns a voltage bandwidth to optimize the output response time with capacitive loads. This command is available for PXI SMU only. This is the same function with “IKtM911xOutputChannelVoltage.Bandwidth Property” section of the M911x driver.

Parameters

- <ch>** Any existing channel number. If unspecified, value is set to 1
- <name>** String. DC Source Name. The name and port must EXACTLY match those in the **DC Source Control dialog**.
"SMU*" represents the SMU DC Meter name. "*" is the SMU module number.
- <string>** Source control type.
"LOW", " HIGH1 ", "HIGH2", or " HIGH3"

Examples	<code>SOUR2:DC:VOLT:BAND "SMU1", "LOW"</code>
Query Syntax	<code>SOURce<ch>:DC:VOLTage:BANDwidth? <name></code>
Return Type	String
Default	"LOW"

`SOURce<ch>:DC:VOLTage:CLAMp <name>,<num>`

Applicable Models: All PXIe VNAs

(Read-Write) Sets and returns the positive voltage limit in Volts when output regulation is in current priority mode. This command is available for PXI SMU only. This is the same function with “IKtM911xOutputChannelVoltage Interface” section, “Limit” property of the M911x driver.

Parameters

<ch>	Any existing channel number. If unspecified, value is set to 1
<name>	String. DC Source Name. The name and port must EXACTLY match those in the DC Source Control dialog . "SMU*" represents the SMU DC Meter name. "*" is the SMU module number.
<num>	Limit value in Volts

Examples	<code>SOUR2:DC:VOLT:CLAM "SMU1", 5</code>
Query Syntax	<code>SOURce<ch>:DC:VOLTage:CLAMp? <name></code>
Return Type	Numeric
Default	6.12

`SOURce<ch>:DC:VOLTage:RANGe <name>,<num>`

Applicable Models: All PXIe VNAs

(Read-Write) Sets and returns a voltage output range in Volts. This command is available for both PXI SMU only. This is the same function with “IKtM911xOutputChannelVoltage.Range Property” section of the M911x driver.

Parameters

<ch> Any existing channel number. If unspecified, value is set to 1

<name> String. DC Source Name. The name and port must EXACTLY match those in the [DC Source Control dialog](#).
"SMU*" represents the SMU DC Meter name. "*" is the SMU module number.

<num> Voltage range (6 or 13)

Examples

```
SOUR2:DC:VOLT:RANG "SMU1",13
```

Query Syntax

```
SOURce<ch>:DC:VOLTage:RANGe? <name>
```

Return Type Numeric

Default 6

SourcePhase

Makes phase control settings (Option S93088A)

SOURce:PHASe:
CONTrol
COUPle[:STATe]
ITERation
TOLerance
CORRection
DATA
[STATe]
[FIXed]
PARameter
MODE
CATalog?
PORT
POFFset
CORRection
DATA
[STATe]
FIXed
STARt
STOP
STARt
STOP

Click on a keyword to view the command details.

see Also

[Learn about Phase Control](#)

[Example Program](#)

[Synchronizing the Analyzer and Controller](#)

SOURce<ch>:PHASe<port>:CONTRol:COUPlE[:STATe] <bool>[,src]

Applicable Models: N522xB, N524xB

(Read-Write) Write and read whether to couple phase control settings (IFBW, Tolerance, Max Iterations).

Parameters

<ch> Channel number of phase control measurement. If unspecified, value is set to 1.

<port> Phase controlled port number. If unspecified, value is set to 1. To make settings for ports that are not simple numbers, use the [src] argument.

<bool> Coupling state. Choose from:
 ON or 1 - Couple phase control settings. The phase control settings from <port> are copied to the other phase-controlled ports.
 OFF or 0 - Do NOT couple phase control settings. The phase control settings for each phase-controlled port are made independently.

[src] String. (NOT case sensitive). Source port. Optional argument.
 While this argument can be used to make settings for ALL ports, it is designed to access ports such as an **external source**, true mode balanced port, or one of the Source 2 outputs on the 2-port 2-source PNA-X model such as "Port 1 Src2". Otherwise, the <port> argument performs the same function. If both arguments are specified, [src] takes priority.

Use **SOUR:CAT?** to return a list of valid port names.

Examples

```
SOUR:PHAS2:CONT:COUP 1
source2:phase:control:couple:state ON,"Port 1 Src2"
```

Query Syntax

```
SOURce<ch>:PHASe<port>:CONTRol:COUPlE[:STATe]? [src]
```

Return Type

Boolean

Default

OFF

SOURce<ch>:PHASe<port>:CONTRol:ITERation <num>[,src]

Applicable Models: N522xB, N524xB

(Read-Write) Write and read the maximum number of background phase sweeps to perform.

Parameters

- <ch>** Channel number of phase control measurement. If unspecified, value is set to 1.
- <port>** Phase controlled port number. If unspecified, value is set to 1. To make settings for ports that are not simple numbers, use the [src] argument.
- <num>** Number of background sweep iterations. Choose a value between 1 and 25.
- [src]** String. (NOT case sensitive). Source port. Optional argument.

While this argument can be used to make settings for ALL ports, it is designed to access ports such as an **external source**, true mode balanced port, or one of the Source 2 outputs on the 2-port 2-source PNA-X model such as "Port 1 Src2". Otherwise, the <port> argument performs the same function. If both arguments are specified, [src] takes priority.

Use **SOUR:CAT?** to return a list of valid port names.

Examples

```
SOUR:PHAS2:CONT:ITER 3  
source2:phase:control:iteration 4,"Port 1 Src2"
```

Query Syntax

```
SOURce<ch>:PHASe<port>:CONTrol:ITERation? [src]
```

Return Type

Numeric

Default

10

SOURce<ch>:PHASe<port>:CONTrol:TOLerance <num>[,src]

Applicable Models: N522xB, N524xB

(Read-Write) Write and read the tolerance value to be used for background phase sweeps.

Parameters

- <ch>** Channel number of phase control measurement. If unspecified, value is set to 1.

<port>	Phase controlled port number. If unspecified, value is set to 1. To make settings for ports that are not simple numbers, use the [src] argument.
<num>	Tolerance for background sweeps in degrees. Choose a value between 1 and 5.
[src]	String. (NOT case sensitive). Source port. Optional argument. While this argument can be used to make settings for ALL ports, it is designed to access ports such as an external source , true mode balanced port, or one of the Source 2 outputs on the 2-port 2-source PNA-X model such as "Port 1 Src2". Otherwise, the <port> argument performs the same function. If both arguments are specified, [src] takes priority. Use SOUR:CAT? to return a list of valid port names.

Examples

```
SOUR:PHAS2:CONT:TOL 3
source2:phase:control:tolerance 6,"Port 1 Src2"
```

Query Syntax

```
SOURce<ch>:PHASe<port>:CONTRol:TOLerance? [src]
```

Return Type

Numeric

Default

1 degree

SOURce<ch>:PHASe<port>:CORRection:DATA <data>[,src]

Applicable Models: N522xB, N524xB
(Read-Write) Write and read an array of phase offsets.

Parameters

<ch>	Channel number of phase control measurement. If unspecified, value is set to 1.
<port>	Phase controlled port number. If unspecified, value is set to 1. To make settings for ports that are not simple numbers, use the [src] argument.
<data>	Phase offset data array.
[src]	String. (NOT case sensitive). Source port. Optional argument.

While this argument can be used to make settings for ALL ports, it is designed to access ports such as an **external source**, true mode balanced port, or one of the Source 2 outputs on the 2-port 2-source PNA-X model such as "Port 1 Src2". Otherwise, the <port> argument performs the same function. If both arguments are specified, [src] takes priority.

Use **SOUR:CAT?** to return a list of valid port names.

Examples	<code>SOUR:PHAS2:CORR:DATA source2:phase:correction:data 10,15,20,"Port 1 Src2"</code>
Query Syntax	<code>SOURce<ch>:PHASe<port>:CORRection:DATA? [src]</code>
Return Type	Depends on FORMat:DATA
Default	Not Applicable

SOURce<ch>:PHASe<port>:CORRection[:STATe] <bool>[,src]

Applicable Models: N522xB, N524xB
(Read-Write) Write and read whether to use the phase correction offset array.

Parameters

- <ch>** Channel number of phase control measurement. If unspecified, value is set to 1.
- <port>** Phase controlled port number. If unspecified, value is set to 1. To make settings for ports that are not simple numbers, use the [src] argument.
- <bool>** Phase correction array state.
 ON (1) Apply phase correction offset array.
 OFF(0) Do NOT apply phase correction offset array.
- [src]** String. (NOT case sensitive). Source port. Optional argument.
 While this argument can be used to make settings for ALL ports, it is designed to access ports such as an **external source**, true mode balanced port, or one of the Source 2 outputs on the 2-port 2-source PNA-X model such as "Port 1 Src2". Otherwise, the <port> argument performs the same function. If both arguments are specified, [src] takes priority.

Use **SOUR:CAT?** to return a list of valid port names.

Examples	<pre>SOUR:PHAS2:CORR 1 source2:phase:correction:state OFF,"Port 1 Src2"</pre>
Query Syntax	<pre>SOURce<ch>:PHASe<port>:CORRection[:STATe]? [src]</pre>
Return Type	Boolean
Default	OFF

SOURce<ch>:PHASe<port>[:FIXed] <num>[,src]

Applicable Models: N522xB, N524xB

(Read-Write) Write and read the fixed phase value. Must not be in logarithmic sweep.

Parameters

<ch>	Channel number of phase control measurement. If unspecified, value is set to 1.
<port>	Phase controlled port number. If unspecified, value is set to 1. To make settings for ports that are not simple numbers, use the [src] argument.
<num>	Phase value in degrees. Choose a value between -360 and 360.
[src]	String. (NOT case sensitive). Source port. Optional argument. While this argument can be used to make settings for ALL ports, it is designed to access ports such as an external source , true mode balanced port, or one of the Source 2 outputs on the 2-port 2-source PNA-X model such as "Port 1 Src2". Otherwise, the <port> argument performs the same function. If both arguments are specified, [src] takes priority.

Use **SOUR:CAT?** to return a list of valid port names.

Examples	<pre>SOUR:PHAS2 60 source2:phase:fixed 120,"Port 1 Src2"</pre>
Query Syntax	<pre>SOURce<ch>:PHASe<port>[:FIXed]? [src]</pre>
Return Type	Numeric
Default	0 degrees

SOURce<ch>:PHASe<port>:PARAmeter <string>[,src]

Applicable Models: N522xB, N524xB

(Read-Write) Write and read the ratioed receivers (parameter) to use for phase control.

Parameters

<ch> Channel number of phase control measurement. If unspecified, value is set to 1.

<port> Phase controlled port number. If unspecified, value is set to 1. To make settings for ports that are not simple numbers, use the [src] argument.

<string> Ratioed parameter. Choose any two VNA physical receivers. Use either standard receiver notation ("R/R3") or **logical receiver notation** ("a1/a3").

Separate the two receiver names by a forward slash '/'. For example: "a3/a1".

[src] String. (NOT case sensitive). Source port. Optional argument.

While this argument can be used to make settings for ALL ports, it is designed to access ports such as an **external source**, true mode balanced port, or one of the Source 2 outputs on the 2-port 2-source PNA-X model such as "Port 1 Src2". Otherwise, the <port> argument performs the same function. If both arguments are specified, [src] takes priority.

Use **SOUR:CAT?** to return a list of valid port names.

Examples

```
SOUR:PHAS2:PAR: "a3/a1","Port 3"  
source2:phase:parameter "a3/a1","Port 3"
```

Query Syntax

```
SOURce<ch>:PHASe<port>:CONTRol:PARAmeter?  
Returns the ratioed parameter name.
```

Return Type

String

Default

"a1/b1"

SOURce<ch>:PHASe<port>:PARAmeter:MODE <char>[,src]

Applicable Models: N522xB, N524xB

(Read-Write) Sets and returns the Phase Control mode.

Parameters

<ch>	Channel number of phase control measurement. If unspecified, value is set to 1.
<port>	Phase controlled port number. If unspecified, value is set to 1. To make settings for ports that are not simple numbers, use the [src] argument.
<char>	<p>Choose from:</p> <p>OFF - Turn phase control OFF</p> <p>OPENloop - Sets a raw phase value for either swept phase or fixed phase, but no receivers are used to control the phase.</p> <p>PARAmeter - Sets and controls the phase of the signal at <port>.</p> <p>REFerence (Read-only) - Use SOUR:PHAS:PARAmeter to set.</p>
[src]	String. (NOT case sensitive). Source port. Optional argument.

While this argument can be used to make settings for ALL ports, it is designed to access ports such as an **external source**, true mode balanced port, or one of the Source 2 outputs on the 2-port 2-source PNA-X model such as "Port 1 Src2". Otherwise, the <port> argument performs the same function. If both arguments are specified, [src] takes priority.

Use **SOUR:CAT?** to return a list of valid port names.

Examples	<pre>SOUR:PHAS2:PAR:MODE PAR source2:phase:parameter:mode off</pre>
Query Syntax	SOURce<ch>:PHASe<port>:PARAmeter:MODE? [src]
Return Type	Character
Default	OFF

SOURce<ch>:PHASe<port>:PARAmeter:MODE:CATalog?

Applicable Models: N522xB, N524xB

(Read-only) Returns the available phase control modes for the specified port.

Parameters

<ch>	Channel number of phase control measurement. If unspecified, value is set to 1.
<port>	Phase controlled port number. If unspecified, value is set to 1. To make settings for ports that are not simple numbers, use the [src] argument.

[src] String. (NOT case sensitive). Source port. Optional argument.

While this argument can be used to make settings for ALL ports, it is designed to access ports such as an **external source**, true mode balanced port, or one of the Source 2 outputs on the 2-port 2-source PNA-X model such as "Port 1 Src2". Otherwise, the <port> argument performs the same function. If both arguments are specified, [src] takes priority.

Use **SOUR:CAT?** to return a list of valid port names.

Examples

```
SOUR:PHAS2:PAR:MODE:CAT?
source2:phase:parameter:mode:catalog?
```

Return Type

String of comma-separated phase control modes.

For example, OFF, OPENloop, PARAmeter, REFerence.

Default

Not Applicable

SOURce<ch>:PHASe<port>:PARAmeter:PORT <num>[,src]

Applicable Models: N522xB, N524xB

(Read-Write) Sets and returns the reference port for the Phase Control measurement.

Parameters

- <ch>** Channel number of phase control measurement. If unspecified, value is set to 1.
 - <port>** Phase controlled port number. If unspecified, value is set to 1. To make settings for ports that are not simple numbers, use the [src] argument.
 - <num>** **Reference port number. ONLY specific ports are available to be a reference for each source port. Learn more.**
 - [src]** String. (NOT case sensitive). Source port. Optional argument.
- While this argument can be used to make settings for ALL ports, it is designed to access ports such as an **external source**, true mode balanced port, or one of the Source 2 outputs on the 2-port 2-source PNA-X model such as "Port 1 Src2". Otherwise, the <port> argument performs the same function. If both arguments are specified, [src] takes priority.
- Use **SOUR:CAT?** to return a list of valid port names.

Examples

```
The following sets source port "Port 1 Src2" on channel
2 to use "Port 1" as the phase reference
```

```
SOUR2:PHAS:PAR:PORT 1,"PORT 1 Src2"
```

```
The following sets source port 2 on channel 1 to use
Port 1 as the phase reference
```

```
source:phas2:PAR:PORT 1
```

Query Syntax

```
SOURce<ch>:PHASe<port>:PARAmeter:PORT? [src]
```

Return Type

Character

Default

3

SOURce<ch>:PHASe<port>:POFFset:CORRection:DATA <data>[,src]

Applicable Models: N522xB, N524xB

(Read-Write) Write and read a ratio amplitude offset array. This allows the setting of arbitrary impedance, which is used for active load applications.

Parameters

<ch> Channel number of phase control measurement. If unspecified, value is set to 1.

<port> Phase controlled port number. If unspecified, value is set to 1. To make settings for ports that are not simple numbers, use the [src] argument.

<num> Ratio amplitude offset data array.

[src] String. (NOT case sensitive). Source port. Optional argument.

While this argument can be used to make settings for ALL ports, it is designed to access ports such as an **external source**, true mode balanced port, or one of the Source 2 outputs on the 2-port 2-source PNA-X model such as "Port 1 Src2". Otherwise, the <port> argument performs the same function. If both arguments are specified, [src] takes priority.

Use **SOUR:CAT?** to return a list of valid port names.

Examples

```
SOUR:PHAS2:POFF:CORR:DATA
```

```
source2:phase:poffset:correction:data , "Port 1 Src2"
```

Query Syntax

```
SOURce<ch>:PHASe<port>:POFFset:CORRection:DATA? [src]
```

Return Type Depends on **FORMat:DATA**

Default **Not Applicable**

SOURce<ch>:PHASe<port>:POFFset:CORRection[:STATe] <bool>[,src]

Applicable Models: N522xB, N524xB

(Read-Write) Write and read whether to use the ratio amplitude offset array.

Parameters

<ch> Channel number of phase control measurement. If unspecified, value is set to 1.

<port> Phase controlled port number. If unspecified, value is set to 1. To make settings for ports that are not simple numbers, use the [src] argument.

<bool> Phase correction array state.
ON (1) Apply ratio amplitude offset array.
OFF(0) Do NOT apply ratio amplitude offset array.

[src] String. (NOT case sensitive). Source port. Optional argument.
While this argument can be used to make settings for ALL ports, it is designed to access ports such as an **external source**, true mode balanced port, or one of the Source 2 outputs on the 2-port 2-source PNA-X model such as "Port 1 Src2". Otherwise, the <port> argument performs the same function. If both arguments are specified, [src] takes priority.

Use **SOUR:CAT?** to return a list of valid port names.

Examples

```
SOUR:PHAS2:POFF:CORR 1  
source2:phase:poffset:correction:state OFF,"Port 1 Src2"
```

Query Syntax **SOURce<ch>:PHASe<port>:POFFset:CONTRol[:STATe]? [src]**

Return Type Boolean

Default **OFF**

SOURce<ch>:PHASe<port>:POFFset:FIXed <num>[,src]

Applicable Models: N522xB, N524xB

(Read-Write) Write and read the fixed power ratioed value. Must NOT be in power sweep to use this value during phase control.

Parameters

<ch> Channel number of phase control measurement. If unspecified, value is set to 1.

<port> Phase controlled port number. If unspecified, value is set to 1. To make settings for ports that are not simple numbers, use the [src] argument.

<num> Fixed power ratio value within the allowable range of the VNA.

[src] String. (NOT case sensitive). Source port. Optional argument.
While this argument can be used to make settings for ALL ports, it is designed to access ports such as an external source, true mode balanced port, or one of the Source 2 outputs on the 2-port 2-source PNA-X model such as "Port 1 Src2". Otherwise, the <port> argument performs the same function. If both arguments are specified, [src] takes priority.

Use SOUR:CAT? to return a list of valid port names.

Examples

```
SOUR:PHAS2:POFF:FIX 1  
source2:phase:poffset:fixed -5,"Port 1 Src2"
```

Query Syntax

```
SOURce<ch>:PHASe<port>::POFFset:FIXed? [src]
```

Return Type

Numeric

Default

0 dBc

SOURce<ch>:PHASe<port>:POFFset:STARt <num>[,src]

Applicable Models: N522xB, N524xB

(Read-Write) Write and read the start power ratioed value. Must also send SENS:SWE:TYPE POWER to put the analyzer into power sweep mode.

Parameters

<ch> Channel number of phase control measurement. If unspecified, value is set to 1.

<port> Phase controlled port number. If unspecified, value is set to 1. To make settings for ports that are not simple numbers, use the [src] argument.

<num> Start power ratio value in dBc. Must be within the allowable range of the VNA

[src] String. (NOT case sensitive). Source port. Optional argument.

While this argument can be used to make settings for ALL ports, it is designed to access ports such as an **external source**, true mode balanced port, or one of the Source 2 outputs on the 2-port 2-source PNA-X model such as "Port 1 Src2". Otherwise, the <port> argument performs the same function. If both arguments are specified, [src] takes priority.

Use **SOUR:CAT?** to return a list of valid port names.

Examples

```
SOUR:PHAS2:POFF:STAR 0
source2:phase:poffset:start -5,"Port 1 Src2"
```

Query Syntax

```
SOURce<ch>:PHASe<port>:POFFset:STARt? [src]
```

Return Type

Numeric

Default

0 dBc

SOURce<ch>:PHASe<port>:POFFset:STOP <num>[,src]

Applicable Models: N522xB, N524xB

(Read-Write) Write and read the start power ratioed value. Must also send **SENS:SWE:TYPE POWer** to put the analyzer into power sweep mode.

Parameters

<ch> Channel number of phase control measurement. If unspecified, value is set to 1.

<port> Phase controlled port number. If unspecified, value is set to 1. To make settings for ports that are not simple numbers, use the [src] argument.

<num> Stop power ratio value in dBc. Must be within the allowable range of the VNA

[src] String. (NOT case sensitive). Source port. Optional argument.

While this argument can be used to make settings for ALL ports, it is designed to access ports such as an **external source**, true mode balanced port, or one of the Source 2 outputs on the 2-port 2-source PNA-X model such as "Port 1 Src2". Otherwise, the <port> argument performs the same function. If both arguments are specified, [src] takes priority.

Use **SOUR:CAT?** to return a list of valid port names.

Examples	<pre>SOUR:PHAS2:POFF:STOP 0 source2:phase:poffset:stop -5,"Port 1 Src2"</pre>
Query Syntax	<pre>SOURce<ch>:PHASe<port>:POFFset:STOP? [src]</pre>
Return Type	Numeric
Default	0 dBc

SOURce<ch>:PHASe<port>:STARt <num>[,src]

Applicable Models: N522xB, N524xB

(Read-Write) Write and read the start value of phase sweep. Must also send **SENS:SWE:TYPE PHASe** to put the analyzer into phase sweep mode.

Parameters

<ch> Channel number of phase control measurement. If unspecified, value is set to 1.

<port> Phase controlled port number. If unspecified, value is set to 1. To make settings for ports that are not simple numbers, use the [src] argument.

<num> Start phase value in degrees. Choose a value between -360 and 360.

[src] String. (NOT case sensitive). Source port. Optional argument.

While this argument can be used to make settings for ALL ports, it is designed to access ports such as an **external source**, true mode balanced port, or one of the Source 2 outputs on the 2-port 2-source PNA-X model such as "Port 1 Src2". Otherwise, the <port> argument performs the same function. If both arguments are specified, [src] takes priority.

Use **SOUR:CAT?** to return a list of valid port names.

Examples	<pre>SOUR:PHAS2:STAR 60 source2:phase:start 120,"Port 1 Src2"</pre>
Query Syntax	<pre>SOURce<ch>:PHASe<port>:STARt? [src]</pre>
Return Type	Numeric
Default	0 degrees

SOURce<ch>:PHASe<port>:STOP <num>[,src]

Applicable Models: N522xB, N524xB

(Read-Write) Write and read the stop value of phase sweep. Must also send **SENS:SWE:TYPE PHASe** to put the analyzer into phase sweep mode.

Parameters

- <ch>** Channel number of phase control measurement. If unspecified, value is set to 1.
- <port>** Phase controlled port number. If unspecified, value is set to 1. To make settings for ports that are not simple numbers, use the [src] argument.
- <num>** Stop phase value in degrees. Choose a value between -360 and 360.
- [src]** String. (NOT case sensitive). Source port. Optional argument.
While this argument can be used to make settings for ALL ports, it is designed to access ports such as an **external source**, true mode balanced port, or one of the Source 2 outputs on the 2-port 2-source PNA-X model such as "Port 1 Src2". Otherwise, the <port> argument performs the same function. If both arguments are specified, [src] takes priority.

Use **SOUR:CAT?** to return a list of valid port names.

Examples	<pre>SOUR:PHAS2:STOP 60 source2:phase:stop 120,"Port 1 Src2"</pre>
Query Syntax	<pre>SOURce<ch>:PHASe<port>:STOP? [src]</pre>
Return Type	Numeric
Default	0 degrees



SourceRxLeveling

Controls Receiver Leveling.

SOUR:POW:ALC[:MODE]:

RECeiver[:STATe]:

FAST

FTYPe

IFBW

ITERation

LSPC

OFFSet

RATio?

REFerence

SAFE[:STATe]

| MAX

| MIN

| STEP

TOLerance

Click on a keyword to view the command details.

See Also

Example Programs

[Learn about Receiver Leveling](#)

[Synchronizing the Analyzer and Controller](#)

[SCPI Command Tree](#)

[Remotely Specifying a Source Port](#)

SOURce<ch>:POWER<port>:ALC[:MODE]:RECeiver[:STATe] <bool>, [src]

Applicable Models: N522xB, N523xB, N524xB

(Read-Write) Sets and returns the state of Receiver Leveling for the specified source port.

[Learn more about Receiver Leveling](#)

Parameters

<ch>	Channel number to be receiver leveled. If unspecified, value is set to 1
<port>	Source port being used for Receiver Leveling. If unspecified, value is set to 1. To make settings for ports that are not simple numbers, use the [src] argument.
<bool>	Receiver Leveling state. ON or 1 - Receiver Leveling ON OFF or 0 - Receiver Leveling OFF
[src]	String. (NOT case sensitive). Source port. Optional. Use SOUR:CAT? to return a list of valid port names. While this argument can be used to make settings for ALL ports, it is designed to access ports such as an external source, true mode balanced port, or one of the Source 2 outputs on the 2-port 2-source PNA-X model such as "Port 1 Src2". Otherwise, the <port> argument performs the same function. If both arguments are specified, [src] takes priority.
Examples	<pre>SOUR:POW:ALC:REC 1 source2:power2:alc:mode:receiver on source:power:alc:mode:receiver:state off,"Port 1 Src2"</pre> <p>See ReceiverLeveling example</p>
Query Syntax	SOURce<ch>:POWER<port>:ALC[:MODE]:RECEiver[:STATE]? [src]
Return Type	Boolean
Default	OFF

SOURce<ch>:POWER<port>:ALC[:MODE]:RECEiver:FAST <bool>, [src]

Applicable Models: **N522xB, N523xB, N524xB**

(Read-Write) Sets and returns the state of a separate IFBW setting for leveling sweeps. ON allows a higher (faster) IFBW than the measurement sweep. It also causes leveling sweeps to be noisier.

[Learn more about Receiver Leveling](#)

Parameters

<ch>	Channel number to be receiver leveled. If unspecified, value is set to 1
<port>	Source port being used for Receiver Leveling. If unspecified, value is set to 1. To make settings for ports that are not simple numbers, use the [src] argument.

<bool>	Separate IFBW setting state. ON or 1 - Separate IFBW setting. Specify IFBW using SOUR:POW:ALC:MODE:REC:IFBW OFF or 0 - Same IFBW as the measurement sweep. Specify IFBW using Sens:BWID
[src]	String. (NOT case sensitive). Source port. Optional. Use SOUR:CAT? to return a list of valid port names. While this argument can be used to make settings for ALL ports, it is designed to access ports such as an external source , true mode balanced port, or one of the Source 2 outputs on the 2-port 2-source PNA-X model such as "Port 1 Src2". Otherwise, the <port> argument performs the same function. If both arguments are specified, [src] takes priority.
Examples	<pre>SOUR:POW:ALC:REC:FAST 1 source2:power2:alc:mode:receiver:fast off source:power:alc:mode:receiver:fast off,"Port 1 Src2"</pre> See ReceiverLeveling example
Query Syntax	SOURce<ch>:POWER<port>:ALC[:MODE]:RECEiver:FAST? [src]
Return Type	Boolean
Default	ON

SOURce<ch>:POWER<port>:ALC[:MODE]:RECEiver:FTYPE <char>, [src]

Applicable Models: N522xB, N523xB, N524xB

(Read-Write) Sets and returns the frequency range to use for receiver leveling. On the user interface, this is the "Receiver frequency is determined by:" setting.

[Learn more about Receiver Leveling](#)

Parameters

<ch>	Channel number to be receiver leveled. If unspecified, value is set to 1
<port>	Source port being used for Receiver Leveling. If unspecified, value is set to 1. To make settings for ports that are not simple numbers, use the [src] argument.
<char>	Frequency range. Choose from:

AUTO - always uses the frequency range that is assigned to the measurement receiver.

INPut - Mixer/Converter input frequency range.

OUTPut - Mixer/Converter input frequency range.

RECeiver - FOM Receiver frequency range.

SOURce - FOM Source frequency range

[src] String. (NOT case sensitive). Source port. Optional. Use **SOUR:CAT?** to return a list of valid port names.

While this argument can be used to make settings for ALL ports, it is designed to access ports such as an **external source**, true mode balanced port, or one of the Source 2 outputs on the 2-port 2-source PNA-X model such as "Port 1 Src2". Otherwise, the <port> argument performs the same function. If both arguments are specified, [src] takes priority.

Examples

```
SOUR:POW:ALC:REC:FTYP AUTO
source2:power2:alc:mode:receiver:ftype input
source:power:alc:mode:receiver:ftype output,"Port 1
Src2"
```

See ReceiverLeveling example

Query Syntax SOURce<ch>:POWER<port>:ALC[:MODE]:RECeiver:FTYPe? [src]

Return Type Character

Default AUTO

SOURce<ch>:POWER<port>:ALC[:MODE]:RECeiver:IFBW <value>, [src]

Applicable Models: N522xB, N523xB, N524xB

(Read-Write) Sets and returns the IFBW to be used for leveling sweeps. Enable separate IFBW for leveling sweeps using **SOUR:POW:ALC:MODE:REC:FAST 1**

Learn more about Receiver Leveling

Parameters

<ch> Channel number to be receiver leveled. If unspecified, value is set to 1

<port> Source port being used for Receiver Leveling..If unspecified, value is set to 1. To make settings for ports that are not simple numbers, use the [src] argument.

<value>	IFBW for leveling sweeps in Hz. The list of valid IF Bandwidths is different depending on the VNA model. (Click to see the lists.) If an invalid number is specified, the analyzer will round up to the closest valid number. This parameter supports MIN and MAX as arguments. Learn more.
[src]	String. (NOT case sensitive). Source port. Optional. Use SOUR:CAT? to return a list of valid port names. While this argument can be used to make settings for ALL ports, it is designed to access ports such as an external source , true mode balanced port, or one of the Source 2 outputs on the 2-port 2-source PNA-X model such as "Port 1 Src2". Otherwise, the <port> argument performs the same function. If both arguments are specified, [src] takes priority.
Examples	<pre>SOUR:POW:ALC:REC:IFBW 100E3 source2:power2:alc:mode:receiver:ifbw 100khz source:power:alc:mode:receiver:ifbw 70e3,"Port 1 Src2"</pre> <p>See ReceiverLeveling example</p>
Query Syntax	SOURce<ch>:POWER<port>:ALC[:MODE]:RECeiver:IFBW? [src]
Return Type	Numeric
Default	100 kHz

SOURce<ch>:POWER<port>:ALC[:MODE]:RECeiver:ITERation <value>, [src]

Applicable Models: N522xB, N523xB, N524xB

(Read-Write) Sets and returns the maximum iterations to be used in order to achieve the tolerance setting.

[Learn more about Receiver Leveling](#)

Parameters

<ch>	Channel number to be receiver leveled. If unspecified, value is set to 1
<port>	Source port being used for Receiver Leveling. If unspecified, value is set to 1. To make settings for ports that are not simple numbers, use the [src] argument.
<value>	Max iterations. Choose a value between 1 and 25.

[src] String. (NOT case sensitive). Source port. Optional. Use **SOUR:CAT?** to return a list of valid port names.

While this argument can be used to make settings for ALL ports, it is designed to access ports such as an **external source**, true mode balanced port, or one of the Source 2 outputs on the 2-port 2-source PNA-X model such as "Port 1 Src2". Otherwise, the <port> argument performs the same function. If both arguments are specified, [src] takes priority.

Examples

```
SOUR:POW:ALC:REC:ITER 5
source2:power2:alc:mode:receiver:iteration 10
source:power:alc:mode:receiver:iteration 7,"Port 1 Src2"
See ReceiverLeveling example
```

Query Syntax

SOURce<ch>:POWER<port>:ALC[:MODE]:RECeiver:ITERation? [src]

Return Type

Numeric

Default

5

SOURce<ch>:POWER<port>:ALC[:MODE]:RECeiver:LSPC <bool>, [src]

Applicable Models: N522xB, N523xB, N524xB

(Read-Write) Sets and returns the state of Use Last Result for Source Power Cal. When Leveling Mode is switched back to Internal, this feature turns Source Power Cal correction ON using the latest receiver leveling correction data.

[Learn more about Receiver Leveling](#)

Parameters

<ch> Channel number to be receiver leveled. If unspecified, value is set to 1

<port> Source port being used for Receiver Leveling. If unspecified, value is set to 1. To make settings for ports that are not simple numbers, use the [src] argument.

<bool> State of Use Last Result for Source Power Cal.

ON or 1 - When Leveling Mode is switched back to Internal, Source Power Cal correction is turned ON using the latest receiver leveling correction data.

OFF or 0 - When Leveling Mode is switched back to Internal, Source Power Cal correction is NOT turned ON.

[src] String. (NOT case sensitive). Source port. Optional. Use **SOUR:CAT?** to return a list of valid port names.

While this argument can be used to make settings for ALL ports, it is designed to access ports such as an **external source**, true mode balanced port, or one of the Source 2 outputs on the 2-port 2-source PNA-X model such as "Port 1 Src2". Otherwise, the <port> argument performs the same function. If both arguments are specified, [src] takes priority.

Examples

```
SOUR:POW:ALC:REC:LSPC 1
source2:power2:alc:mode:receiver:lspc off
source:power:alc:mode:receiver:lspc off,"Port 1 Src2"
See ReceiverLeveling example
```

Query Syntax

SOURce<ch>:POWER<port>:ALC[:MODE]:RECeiver:LSPC? [src]

Return Type

Boolean

Default

OFF

SOURce<ch>:POWER<port>:ALC[:MODE]:RECeiver:OFFSet <value>, [src]

Applicable Models: N522xB, N523xB, N524xB

(Read-Write) Sets and returns the power level offset value.

[Learn more about Receiver Leveling](#)

Parameters

<ch> Channel number to be receiver leveled. If unspecified, value is set to 1

<port> Source port being used for Receiver Leveling. If unspecified, value is set to 1. To make settings for ports that are not simple numbers, use the [src] argument.

<value> Power level offset in dB. Choose a value between +200 and -200.

[src] String. (NOT case sensitive). Source port. Optional. Use **SOUR:CAT?** to return a list of valid port names.

While this argument can be used to make settings for ALL ports, it is designed to access ports such as an **external source**, true mode balanced port, or one of the Source 2 outputs on the 2-port 2-source PNA-X model such as "Port 1 Src2". Otherwise, the <port> argument

performs the same function. If both arguments are specified, [src] takes priority.

Examples

```
SOUR:POW:ALC:REC:OFFS 10
source2:power2:alc:mode:receiver:offset 5
source:power:alc:mode:receiver:offset 7,"Port 1 Src2"
See ReceiverLeveling example
```

Query Syntax

SOURce<ch>:POWER<port>:ALC[:MODE]:RECeiver:OFFSet? [src]

Return Type

Numeric

Default

0

SOURce<ch>:POWER<port>:ALC[:MODE]:RECeiver:RATio? [src]

Applicable Models: N522xB, N523xB, N524xB

(Read-only) Returns the receiver ratio to be used with receiver leveling. This receiver ratio parameter is the same as the one set in [SOUR:PHAS:PARAmeter](#).

[Learn more about Receiver Leveling](#)

Parameters

- <ch>** Channel number to be receiver leveled. If unspecified, value is set to 1
- <port>** Source port being used for Receiver Leveling. If unspecified, value is set to 1. To make settings for ports that are not simple numbers, use the [src] argument.
- [src]** String. (NOT case sensitive). Source port. Optional. Use [SOUR:CAT?](#) to return a list of valid port names.

While this argument can be used to make settings for ALL ports, it is designed to access ports such as an **external source**, true mode balanced port, or one of the Source 2 outputs on the 2-port 2-source PNA-X model such as "Port 1 Src2". Otherwise, the <port> argument performs the same function. If both arguments are specified, [src] takes priority.

Examples

```
SOUR:POW:ALC:REC:RAT 10
source2:power2:alc:mode:receiver:ratio "a1/a3,3"
source:power:alc:mode:receiver:ratio "R1/R3,3","Port 1 Src2"
See ReceiverLeveling example
```

Query Syntax	SOURce<ch>:POWER<port>:ALC[:MODE]:RECEiver:RATio? [src] Returned is two VNA physical receivers that are controlled by different sources and the port that is 'paired' with <port>. The receivers and paired port are separated by a comma.
Return Type	String
Default	"a1/a3,3"

SOURce<ch>:POWER<port>:ALC[:MODE]:RECEiver:REFerence <rec>, [src]

Applicable Models: N522xB, N523xB, N524xB

(Read-Write) Sets and returns the reference receiver to be used with Receiver Leveling.

[Learn more about Receiver Leveling](#)

Parameters

<ch>	Channel number to be receiver leveled. If unspecified, value is set to 1
<port>	Source port being used for Receiver Leveling. If unspecified, value is set to 1. To make settings for ports that are not simple numbers, use the [src] argument.
<rec>	(String) VNA receiver. Choose the VNA physical receiver that works with the source port <port>. For example:<port 1> = "R1"
[src]	String. (NOT case sensitive). Source port. Optional. Use SOUR:CAT? to return a list of valid port names. While this argument can be used to make settings for ALL ports, it is designed to access ports such as an external source, true mode balanced port, or one of the Source 2 outputs on the 2-port 2-source PNA-X model such as "Port 1 Src2". Otherwise, the <port> argument performs the same function. If both arguments are specified, [src] takes priority.

Examples

```
SOUR:POW:ALC:REC:REF 'r1'
source2:power2:alc:mode:receiver:reference 'r2'
source:power:alc:mode:receiver:reference "r1","Port 1 Src2"
'Read the last setting back
source:power:alc:mode:receiver:reference? "Port 1 Src2"
```

Returns:

"R1, 1"

[See ReceiverLeveling example](#)

Query Syntax SOURce<ch>:POWER<port>:ALC[:MODE]:RECEiver:REFerence? [src]

Return Type String - Name of the reference receiver.

Default Not Applicable

SOURce<ch>:POWER<port>:ALC[:MODE]:RECEiver:SAFE[:STATE] <bool>, [src]

Applicable Models: N522xB, N523xB, N524xB

(Read-Write) Sets and returns the state of Safe Mode.

[Learn more about Receiver Leveling](#)

Parameters

<ch> Channel number to be receiver leveled. If unspecified, value is set to 1

<port> Source port being used for Receiver Leveling. If unspecified, value is set to 1. To make settings for ports that are not simple numbers, use the [src] argument.

<bool> Safe mode state.

ON or 1 - Safe mode ON

OFF or 0 - Safe mode OFF

[src] String. (NOT case sensitive). Source port. Optional. Use **SOUR:CAT?** to return a list of valid port names.

While this argument can be used to make settings for ALL ports, it is designed to access ports such as an **external source**, true mode balanced port, or one of the Source 2 outputs on the 2-port 2-source PNA-X model such as "Port 1 Src2". Otherwise, the <port> argument performs the same function. If both arguments are specified, [src] takes priority.

Examples

```
SOUR:POW:ALC:REC:SAFE 1
source2:power2:alc:mode:receiver:safe on
source:power:alc:mode:receiver:safe:state off,"Port 1 Src2"
```

[See ReceiverLeveling example](#)

Query Syntax SOURce<ch>:POWER<port>:ALC[:MODE]:RECEiver:SAFE[:STATE]? [src]

Return Type	Boolean
Default	OFF

SOURce<ch>:POWER<port>:ALC[:MODE]:RECeiver:SAFE:MAX <value>, [src]

Applicable Models: N522xB, N523xB, N524xB

(Read-Write) Sets and returns the maximum power level for Safe Mode.

The MAX/MIN limit is always used regardless of the safe mode state. In addition, the MAX/MIN limit is for port power and related to power offset. If the power offset is not set correctly, the MAX/MIN limit is not correct and it may impact the leveling. Ensure that the power offset in the channel is the same as power offset during calibration. If the exact power offset is not known, choose a limit for source and then it will not be related to power offset.

[Learn more about Receiver Leveling](#)

Parameters

<ch>	Channel number to be receiver leveled. If unspecified, value is set to 1
<port>	Source port being used for Receiver Leveling. If unspecified, value is set to 1. To make settings for ports that are not simple numbers, use the [src] argument.
<value>	Maximum power level in dB.
[src]	String. (NOT case sensitive). Source port. Optional. Use SOUR:CAT? to return a list of valid port names.

While this argument can be used to make settings for ALL ports, it is designed to access ports such as an **external source**, true mode balanced port, or one of the Source 2 outputs on the 2-port 2-source PNA-X model such as "Port 1 Src2". Otherwise, the <port> argument performs the same function. If both arguments are specified, [src] takes priority.

Examples

```
SOUR:POW:ALC:REC:SAFE:MAX 10
source2:power2:alc:mode:receiver:safe:max 20
source:power:alc:mode:receiver:safe:max 15,"Port 1 Src2"
See ReceiverLeveling example
```

Query Syntax SOURce<ch>:POWER<port>:ALC[:MODE]:RECeiver:SAFE:MAX? [src]

Return Type Numeric

Default

30 dB

SOURce<ch>:POWER<port>:ALC[:MODE]:RECEiver:SAFE:MIN <value>, [src]

Applicable Models: N522xB, N523xB, N524xB

(Read-Write) Sets and returns the minimum power level for Safe Mode.

The MAX/MIN limit is always used regardless of the safe mode state. In addition, the MAX/MIN limit is for port power and related to power offset. If the power offset is not set correctly, the MAX/MIN limit is not correct and it may impact the leveling. Ensure that the power offset in the channel is the same as power offset during calibration. If the exact power offset is not known, choose a limit for source and then it will not be related to power offset.

[Learn more about Receiver Leveling](#)

Parameters

<ch> Channel number to be receiver leveled. If unspecified, value is set to 1

<port> Source port being used for Receiver Leveling. If unspecified, value is set to 1. To make settings for ports that are not simple numbers, use the [src] argument.

<value> Minimum power level in dB.

[src] String. (NOT case sensitive). Source port. Optional. Use **SOUR:CAT?** to return a list of valid port names.

While this argument can be used to make settings for ALL ports, it is designed to access ports such as an **external source**, true mode balanced port, or one of the Source 2 outputs on the 2-port 2-source PNA-X model such as "Port 1 Src2". Otherwise, the <port> argument performs the same function. If both arguments are specified, [src] takes priority.

Examples

```
SOUR:POW:ALC:REC:SAFE:MIN -50
source2:power2:alc:mode:receiver:safe:min -80
source:power:alc:mode:receiver:safe:min -40,"Port 1 Src2"
```

See ReceiverLeveling example

Query Syntax SOURce<ch>:POWER<port>:ALC[:MODE]:RECEiver:SAFE:MIN? [src]

Return Type Numeric

Default -95 dB

SOURce<ch>:POWER<port>:ALC[:MODE]:RECEiver:SAFE:STEP <value>, [src]

Applicable Models: N522xB, N523xB, N524xB

(Read-Write) Sets and returns the maximum step power level for Safe Mode.

[Learn more about Receiver Leveling](#)

Parameters

<ch> Channel number to be receiver leveled. If unspecified, value is set to 1

<port> Source port being used for Receiver Leveling. If unspecified, value is set to 1. To make settings for ports that are not simple numbers, use the [src] argument.

<value> Maximum Step power level in dB.

[src] String. (NOT case sensitive). Source port. Optional. Use **SOUR:CAT?** to return a list of valid port names.

While this argument can be used to make settings for ALL ports, it is designed to access ports such as an **external source**, true mode balanced port, or one of the Source 2 outputs on the 2-port 2-source PNA-X model such as "Port 1 Src2". Otherwise, the <port> argument performs the same function. If both arguments are specified, [src] takes priority.

Examples

```
SOUR:POW:ALC:REC:SAFE:STEP 2
source2:power2:alc:modes:receiver:safe:step 1.5
source:power:alc:modes:receiver:safe:min 2,"Port 1 Src2"
See ReceiverLeveling example
```

Query Syntax SOURce<ch>:POWER<port>:ALC[:MODE]:RECEiver:SAFE:STEP? [src]

Return Type Numeric

Default 1 dB

SOURce<ch>:POWER<port>:ALC[:MODE]:RECEiver:TOLerance <value>, [src]

Applicable Models: N522xB, N523xB, N524xB

(Read-Write) Sets and returns the tolerance value for leveling sweeps.

Learn more about Receiver Leveling

Parameters

<ch>	Channel number to be receiver leveled. If unspecified, value is set to 1
<port>	Source port being used for Receiver Leveling. If unspecified, value is set to 1. To make settings for ports that are not simple numbers, use the [src] argument.
<value>	Tolerance level in dB.

[src] String. (NOT case sensitive). Source port. Optional. Use **SOUR:CAT?** to return a list of valid port names.

While this argument can be used to make settings for ALL ports, it is designed to access ports such as an **external source**, true mode balanced port, or one of the Source 2 outputs on the 2-port 2-source PNA-X model such as "Port 1 Src2". Otherwise, the <port> argument performs the same function. If both arguments are specified, [src] takes priority.

Examples

```
SOUR:POW:ALC:REC:TOL .01
source2:power2:alc:mode:receiver:tolerance .5
source:power:alc:mode:receiver:tolerance .2,"Port 1
Src2"
```

See ReceiverLeveling example

Query Syntax SOURce<ch>:POWer<port>:ALC[:MODE]:RECeiver:TOLerance? [src]

Return Type Numeric

Default .1 dB

Status Keywords SCPI

The following keywords can be appended to the node or nodes that represent the Status register you want to control.

:CONDition?

:ENABle

:ENABle?

:EVENT?

:MAP

:NTRansition

:PTRansition

[Learn about Status Registers](#)

[SCPI Command Tree](#)

:CONDition?

Monitors the conditions as they occur REAL TIME. That is, a condition may occur, and then clear before the condition is read. Reading this register returns a 16-bit decimal weighted number.

:ENABle <bit>

Enables register bits that will monitored using the **service request (SRQ)** method. (To use the direct read method, you do not have to enable the bit.)

Default value for `STATus:QUEStionable:ENABle` and `STATus:OPERation:ENABle` is 0: No bits enabled.

Default value for all other registers `:ENABle <bits>` is 32767; ALL BITS ENABLED.

Therefore it is ONLY necessary to send the ENABle keyword if you want to DISABLE some conditions. For example, to enable ONLY Trace1 (bit 2) of the LIMIT1 register (disable all other traces) , send: **STATus:QUEStionable:LIMit1:ENABle 4**

:ENABle?

Read the enable register to verify the bits that you enabled. Returns a 16 bit weighted sum of the bits that are enabled.

[[:EVENT]?

Query only - This is the Default keyword for most registers. Use it to determine if a condition has occurred. These bits remain set until they are read or otherwise cleared.

:MAP <bit>,<error>

Associates a bit in the User register with an error number. For example

```
STATUS:QUESTIONABLE:DEFINE:USER2:MAP 0,-113
```

0 is the bit that will be set

-113 is the error

When error -113 "Undefined Header" occurs, bit 0 in the USER2 register will be set to 1.

:NTRansition <bits>

Write-Read - Negative Transition register bits set the condition to be set on the Negative going (True to False) transition. Use this register if you are only interested in a condition changing from True to False.

:NTRansition?

queries the register to verify that you set a negative transition.

:PTRansition <bits>

Write-Read - Positive Transition register bits set the condition to be set on the False to True transition. Use this register if you are only interested in the change of a condition from False to True.

:PTRansition?

Queries the register to verify that you set a positive transition.

TDR Memory

These commands control the loading and storing of eye bit pattern and mask files.

MMEMory:TDR
LOAD
EYE
BPATtern
MASK
STATe
STORe
EYE
BPATtern
MASK
FDATa
SNP
STATe

Click on a **red** keyword to view the command details.

see Also

[Synchronizing the Analyzer and Controller](#)
[SCPI Command Tree](#)

MMEMory:TDR:LOAD:EYE:BPATtern <filename>

Applicable Models: All with TDR Options (S9x011A/B)

(Write-only) This command loads the specified user bit pattern file. The extension of file should be .txt. The bit pattern editing is not available through the command.

Parameters

<filename> **File name of the user bit pattern (.txt)**

Examples	<code>MMEM:TDR:LOAD:EYE:BPAT "C:\TDR\mybitpattern.txt"</code> <code>mmemory:tdr:load:eye:bpattern "c:\tdr\mybitpattern.txt"</code>
Default	Not Applicable

MMEMy:TDR:LOAD:EYE[:MASK] <filename>

Applicable Models: All with TDR Options (S9x011A/B)

(Write-only) This command loads eye-mask file. The format of the eye mask file should be the same as the format of the Infiniium DCA (86100C). The extension of the file should be .msk. The MASK pattern editing is not available through the command.

Parameters

<filename> **File name of the eye mask (.msk)**

Examples	<code>MMEM:TDR:LOAD:EYE:MASK "C:\TDR\FC0133.msk"</code> <code>mmemory:tdr:load:eye:mask "c:\tdr\FC0133.msk"</code>
Default	Not Applicable

MMEMy:TDR:LOAD:STATe <filename>

Applicable Models: All with TDR Options (S9x011A/B)
(Write-only) Loads the specified instrument state file (.sta).

Parameters

<filename> String - Name of any valid file that does not already exist.

Examples	<code>MMEM:TDR:LOAD:STAT 'myState'</code> <code>mmemory:tdr:load:state 'c:\tdr\myState.sta'</code>
-----------------	---

Query Syntax Not applicable

Default Not applicable

MMEMy:TDR:STORe:EYE:BPATtern <filename>

Applicable Models: All with TDR Options (S9x011A/B)

(Write-only) This command stores the user bit pattern file. The extension of file should be .txt. The bit pattern editing is not available through the command.

Parameters

<filename> File name of the user bit pattern (.txt)

Examples

```
MMEM:TDR:STOR:EYE:BPAT "C:\TDR\mybitpattern.txt"  
mmemory:tdr:store:eye:bpattern "c:\tdr\mybitpattern.txt"
```

Default

Not Applicable

MMEMory:TDR:STORe:EYE[:MASK] <filename>

Applicable Models: All with TDR Options (S9x011A/B)

(Write-only) This command stores the eye-mask file. The format of the eye mask file should be the same as the format of the Infiniium DCA (86100C). The extension of the file should be .msk. The MASK pattern editing is not available through the command.

Parameters

<filename> File name of the eye mask (.msk)

Examples

```
MMEM:TDR:STOR:EYE:MASK "C:\TDR\mymask.msk"  
mmemory:tdr:store:eye:mask "c:\tdr\mymask.msk"
```

Default

Not Applicable

MMEMory:TDR:STORe:FDATa <filename>

Applicable Models: All with TDR Options (S9x011A/B)
(Write-only) Stores the specified measurement data file.

Parameters

<filename> String - Name of any valid file that does not already exist.

Examples

```
MMEM:TDR:STOR:FDAT 'myFdata'  
mmemory:tdr:store:fdata 'c:\tdr\myFdata'
```

Query Syntax

Not applicable

Default

Not applicable

MMEMory:TDR:STORe:SNP <n>

Applicable Models: All with TDR Options (S9x011A/B)
(Write-only) Stores the SnP measurement data. [Learn more about SnP data.](#)

Parameters

<n> SnP measurement data to store. If unspecified, <n> is set to 2. The number you specify must be less than or equal to the number of available ports on the VNA.

Choose from:

1 (S1P) stores 1-Port data for the active measurement if the active measurement is a reflection parameter such as S11 or S22. The behavior is UNDEFINED if the active measurement is a transmission parameter such as an S21.

2 (S2P) stores data for the four 2 port parameters associated with the current measurement. Default. Data that is not available is zero-filled.

3 (S3P) stores data for the nine 3 port parameters associated with the current measurement. Data that is not available is zero-filled.

4 (S4P) stores data for the sixteen 4 port parameters associated with the current measurement. Data that is not available is zero-filled.

Examples

```
MMEM:TDR:STOR:SNP 1  
mmemory:tdr:store:snp 1
```

Query Syntax

Not applicable

Default

Not applicable

MMEMory:TDR:STORE:STATE <filename>

Applicable Models: All with TDR Options (S9x011A/B)
(Write-only) Stores the specified instrument state file (.sta).

Parameters

<filename> String - Name of any valid file that does not already exist.

Examples

```
MMEM:TDR:STOR:STAT 'myState'  
mmemory:tdr:store:state 'c:\tdr\myState.sta'
```

Query Syntax

Not applicable

Default

Not applicable

TDR Source

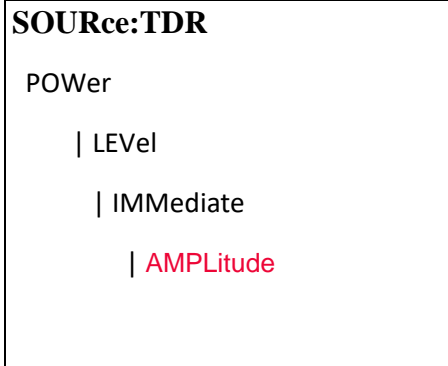

Click on a **red** keyword to view the command details.

see Also

[Synchronizing the Analyzer and Controller](#)

[SCPI Command Tree](#)

SOURCE<num>:TDR:POWer[:LEVel][:IMMediate][:AMPLitude] <value>

Applicable Models: All with TDR Options (S9x011A/B)

(Read-Write) This command sets the source power level.

Parameters

<num> Channel number of the measurement. If unspecified, <num> is set to 1.

<value> Source power level in dBm.

Examples

```
SOUR:TDR:POW 20
source:tdr:power:level:immediate:amplitude 20
```

Query Syntax

```
SOURCE:TDR:POWer[:LEVel][:IMMediate][:AMPLitude]?
```

Return Type

Double

Default

-8 dBm

Cal All for Mixer Channel

```
*CLS
SYST:FPReset
'-----
' create a standard channel
'-----
DISPlay:WINDow1:STATE ON
CALC1:PARAmeter:DEFine:EXT "MyMeas", S21
DISPlay:WINDow1:TRACe1:FEED "MyMeas"
SENSe1:BANDwidth 700
SENSe1:FREQuency:CENTer 1ghz
SENSe1:FREQuency:SPAN 1ghz
SENSe1:SWEep:POINts 11
'-----
' create a Mixer channel
'-----
DISPlay:WINDow2:STATE ON
CALC2:CUST:DEF 'My SC21', 'Scalar Mixer/Converter', 'SC21'
DISP:WIND2:TRAC:FEED 'My SC21'
SENS2:SWEep:POINts 11
SENS2:BANDwidth 1e3
SENS2:MIX:INPut:FREQ:MODE SWEpt
SENS2:MIX:INPut:FREQ:STAR 3.6e9
SENS2:MIX:INPut:FREQ:STOP 3.9e9
SENS2:MIX:LO:FREQ:MODE FIXED
SENS2:MIX:LO:FREQ:FIX 1.0e9
SENS2:MIX:LO:POW 10
SENS2:MIX:OUTP:FREQ:SID LOW
SENS2:MIX:CALC Output
SENS2:MIX:LO:NAME 'Port 3'
SENS2:MIX:APPLY
'-----
' configure cal all
' select channels 1 and 2.
' for channel 2 select all the ports of the mixer
' explicitly because we want to add the LO (port 3)
'-----
SYST:CAL:ALL:RESet
SYST:CAL:ALL:SEL 1,2
SYST:CAL:ALL:CHAN2:PORT:SEL 1,2,3
```

```

SYST:ERR?
SYST:CAL:ALL:CHAN2:PORT:SEL?
SYST:CAL:ALL:IFBW 1e3
SYST:CAL:ALL:PORT1:SOUR:POWER -10
SYST:CAL:ALL:CSET:PREFIX 'MyCalAllExample'
'-----
' query for the available mixer cal properties to set
' this is an info only query
'-----

SYST:CAL:ALL:MCL:PROP:NAME:CAT? 'Scalar Mixer/Converter'
SYST:CAL:ALL:MCL:PROP:VAL:CAT? 'Phase Correction Method'
SYST:CAL:ALL:MCL:PROP:VAL:CAT? 'Mixer Delay'

'-----
' Enable phase correction using a cal mixer with known delay
'-----

SYST:CAL:ALL:MCL:PROP:VAL 'Enable Phase Correction','true'
SYST:CAL:ALL:MCL:PROP:VAL 'Phase Correction Method','Use Mixer Delay'
SYST:CAL:ALL:MCL:PROP:VAL 'Mixer Delay', '10e-9'

'-----
' configure power sensor
'-----

SYST:COMM:PSEN USB, "Agilent Technologies,U8485A,my53470003"

'-----
' Perform calibration
' Note: the channel number used in the following SENS
'       commands MUST BE the channel number returned
'       from the preceding query SYST:CAL:ALL:GUIDed:CHAN?
'-----

SYST:CAL:ALL:GUIDed:CHAN?
SENS200:corr:coll:guid:conn:port1 "APC 3.5 male"
SENS200:corr:coll:guid:conn:port2 "APC 3.5 female"
SENS200:corr:coll:guid:conn:port3 "Not used"
SENS200:corr:coll:guid:conn:port4 "Not used"
SENS200:corr:coll:guid:ckit:port1 "N4691-60004 ECal"
SENS200:corr:coll:guid:ckit:port2 "N4691-60004 ECal"
SENS200:corr:coll:guid:init; *OPC?

```

```
SENS200:corr:coll:guid:steps?  
SENS200:CORR:COLL:GUID:desc? 1  
SENS200:corr:coll:guid:acq stan1;*OPC?  
SENS200:CORR:COLL:GUID:desc? 2  
SENS200:corr:coll:guid:acq stan2;*OPC?  
SENS200:CORR:COLL:GUID:desc? 3  
SENS200:corr:coll:guid:acq stan3;*OPC?  
SENS200:CORR:COLL:GUID:desc? 4  
SENS200:corr:coll:guid:acq stan4;*OPC?  
SENS200:CORR:COLL:GUID:SAVE;*OPC?
```

```
'-----  
-----
```

The channel number used for the SENSE header is determined by the SYST:CAL:ALL:GUID:CHAN? command. You must query this channel number – do not assume that it will always be a particular value.

CalAll_1-Port_1-Chan_ECal

```
'  
' calibrate 1 port, no power, ECal  
'  
  
system:preset;  
SYST:CAL:ALL:RESet  
SYST:CAL:ALL:SEL 1  
SYST:CAL:ALL:CHAN1:PORT:SEL 1  
SYST:CAL:ALL:MCL:PROP:VAL "Include Power Calibration","false"  
SYST:CAL:ALL:GUID:CHAN?  
SENS200:corr:coll:guid:conn:port1 "APC 3.5 female"  
SENS200:corr:coll:guid:ckit:port1 "N4691-60004 ECal"  
SENS200:CORR:COLL:GUID:INIT  
SENS200:CORR:COLL:GUID:STEPS?  
SENS200:corr:coll:guid:acq stan1  
SENS200:corr:coll:guid:save
```

The channel number used for the SENSE header is determined by the SYST:CAL:ALL:GUID:CHAN? command. You must query this channel number – do not assume that it will always be a particular value.

CalAll_2-Port_1-Chan_ECal

```
'  
' calibrate 2 ports, no power, ECal  
'  
  
system:preset;  
SYST:CAL:ALL:RESet  
SYST:CAL:ALL:SEL 1  
SYST:CAL:ALL:CHAN1:PORT:SEL 1,2  
SYST:CAL:ALL:MCL:PROP:VAL "Include Power Calibration","false"  
SYST:CAL:ALL:GUID:CHAN?  
SENS200:corr:coll:guid:conn:port1 "APC 3.5 female"  
SENS200:corr:coll:guid:conn:port2 "APC 3.5 male"  
SENS200:corr:coll:guid:ckit:port1 "N4691-60004 ECal"  
SENS200:corr:coll:guid:ckit:port2 "N4691-60004 ECal"  
SENS200:CORR:COLL:GUID:INIT  
SENS200:CORR:COLL:GUID:STEPS?  
SENS200:corr:coll:guid:acq stan1  
SENS200:corr:coll:guid:save
```

The channel number used for the SENSE header is determined by the **SYST:CAL:ALL:GUID:CHAN?** command. You must query this channel number – do not assume that it will always be a particular value.

CalAll_2-Port_1-Chan_PwrCal_ECal

```
'  
' calibrate 2 ports, power cal, ECal  
'  
  
system:preset;  
SYST:COMM:PSEN USB, "Agilent Technologies,U2002A,my51240006"  
CALC:PAR:DEF "S11", S11  
CALC2:PAR:DEF "S22", S22  
SYST:CAL:ALL:RESet  
SYST:CAL:ALL:SEL 1,2  
SYST:CAL:ALL:CHAN1:PORT:SEL 1,2  
SYST:CAL:ALL:MCL:PROP:VAL "Include Power Calibration","true"  
SYST:CAL:ALL:GUID:CHAN?  
SENS200:CORR:COLL:GUID:PSEN1:CONN 'Ignored'  
SENS200:CORR:COLL:GUID:PSEN1:CKIT 'Not used'  
SENS200:corr:coll:guid:conn:port1 "APC 3.5 male"  
SENS200:corr:coll:guid:conn:port2 "APC 3.5 female"  
SENS200:corr:coll:guid:ckit:port1 "N4691-60004 ECal"  
SENS200:corr:coll:guid:ckit:port2 "N4691-60004 ECal"  
SENS200:CORR:COLL:GUID:INIT  
SENS200:CORR:COLL:GUID:STEPS?  
SENS200:corr:coll:guid:acq stan1  
SENS200:corr:coll:guid:acq stan2  
SENS200:corr:coll:guid:save
```

The channel number used for the SENSE header is determined by the **SYST:CAL:ALL:GUID:CHAN?** command. You must query this channel number – do not assume that it will always be a particular value.

CalAll_2-Port_2-Chan_PwrCal_ECal

```
'  
' calibrate 2 ports, 2 channels, power cal, ECal  
'  
  
system:preset;  
SYST:COMM:PSEN USB, "Agilent Technologies,U8485A,my53470003"  
CALC:PAR:DEF "S11", S11  
CALC2:PAR:DEF "S22", S22  
SYST:CAL:ALL:RESet  
SYST:CAL:ALL:SEL 1,2  
SYST:CAL:ALL:CHAN1:PORT:SEL 1  
SYST:CAL:ALL:CHAN2:PORT:SEL 1,2  
SYST:CAL:ALL:MCL:PROP:VAL "Include Power Calibration","true"  
SYST:CAL:ALL:GUID:CHAN?  
SENS200:CORR:COLL:GUID:PSEN1:CONN 'Ignored'  
SENS200:CORR:COLL:GUID:PSEN1:CKIT 'Not used'  
SENS200:CORR:COLL:GUID:PSEN1:POW:LEV -5  
SENS200:corr:coll:guid:conn:port1 "APC 3.5 male"  
SENS200:corr:coll:guid:conn:port2 "APC 3.5 female"  
SENS200:corr:coll:guid:ckit:port1 "N4691-60004 ECal"  
SENS200:corr:coll:guid:ckit:port2 "N4691-60004 ECal"  
SENS200:CORR:COLL:GUID:INIT  
SENS200:CORR:COLL:GUID:STEPS?  
SENS200:corr:coll:guid:acq stan1  
SENS200:corr:coll:guid:acq stan2  
SENS200:corr:coll:guid:save
```

The channel number used for the SENSE header is determined by the SYST:CAL:ALL:GUID:CHAN? command. You must query this channel number – do not assume that it will always be a particular value.

CalAll_Noise Figure

```
'-----  
' create NF channel  
'-----  
  
SYST:FPRESET  
DISP:WIND:STATE ON  
CALC1:MEAS1:DEF "S11:Noise Figure Cold Source"  
DISP:MEAS1:FEED 1  
CALC1:MEAS2:DEF "NF:Noise Figure Cold Source"  
DISP:MEAS2:FEED 1  
  
'-----  
' configure power sensor  
'-----  
  
system:communicate:psensor usb, "Agilent  
Technologies,U8485A,MY53470003"  
  
'-----  
' configure calibrate all  
'-----  
  
SYST:CAL:ALL:RESET  
SYST:CAL:ALL:CSET:PREFIX "Example"  
SYST:CAL:ALL:SEL 1  
SYST:CAL:ALL:CHAN1:PORTS:SEL 1,2  
  
'-----  
' use this query to see what cal all properties are  
' relevant to the noise figure channel  
'-----  
  
SYST:CAL:ALL:MCLASS:PROP:NAME:CAT? "Noise Figure Cold Source"  
  
'-----  
' set scalar noise cal, using power meter  
'-----  
  
SYST:CAL:ALL:MCLASS:PROP:VAL:STATE "Noise Cal Method", "Scalar"  
SYST:CAL:ALL:MCLASS:PROP:VAL:STATE "Receiver Characterization Method",  
"Use Power Meter"  
  
'-----  
' retrieve the guided cal channel number  
'-----  
  
SYST:CAL:ALL:GUIDED:CHAN?  
  
' configure the sensor  
' set ignored unless you want to calibrate  
' an adapter used for the power sensor.  
SENS200:CORR:COLL:GUID:PSEN1:CONN 'Ignored'
```

```

SENS200:CORR:COLL:GUID:PSEN1:CKIT 'Not used'
SENS200:CORR:COLL:GUID:PSEN1:POW:LEV -15
'-----
' configure basic cal properties: connectors, kits
' NOTE: always fully specify ecals when Noise figure
' is in the channel list. IE: include the ecal serial
' number!
'-----
SENS200:CORR:COLL:GUID:CONN:PORT1:SEL "APC 3.5 male"
SENS200:CORR:COLL:GUID:CONN:PORT2:SEL "APC 3.5 female"
SENS200:CORR:COLL:GUID:ckit:port2:SEL "N4691-60004 ECal 02297"
SENS200:CORR:COLL:GUID:ckit:port1:SEL "N4691-60004 ECal 02297"
SENS200:CORR:COLL:GUID:INIT
' acquire the calibration
SENS200:CORR:COLL:GUID:STEPS?
SENS200:CORR:COLL:guid:DESC? 1
SENS200:CORR:COLL:GUID:ACQ STAN1
SENS200:CORR:COLL:GUID:desc? 2
SENS200:CORR:COLL:GUID:ACQ STAN2
SENS200:CORR:COLL:GUID:desc? 3
SENS200:CORR:COLL:GUID:ACQ STAN3
SENS200:CORR:COLL:GUID:SAVE

```

The channel number used for the SENSE header is determined by the SYST:CAL:ALL:GUID:CHAN? command. You must query this channel number – do not assume that it will always be a particular value.

CalAll_SMC

```
'-----  
' create a standard channel  
'-----  
  
DISPlay:WINDow1:STATE ON  
CALC1:PARAmeter:DEFine:EXT "MyMeas", S21  
DISPlay:WINDow1:TRACe1:FEED "MyMeas"  
SENSe1:BANDwidth 700  
SENSe1:FREQuency:CENTer 1ghz  
SENSe1:FREQuency:SPAN 1ghz  
SENSe1:SWEep:POINts 11  
'-----  
' create a Mixer channel  
'-----  
  
DISPlay:WINDow2:STATE ON  
CALC2:CUST:DEF 'My SC21', 'Scalar Mixer/Converter', 'SC21'  
DISP:WIND2:TRAC:FEED 'My SC21'  
SENS2:SWEep:POINts 11  
SENS2:BANDwidth 1e3  
SENS2:MIX:INPut:FREQ:MODE SWEPT  
SENS2:MIX:INPut:FREQ:STAR 3.6e9  
SENS2:MIX:INPut:FREQ:STOP 3.9e9  
SENS2:MIX:LO:FREQ:MODE FIXED  
SENS2:MIX:LO:FREQ:FIX 1.0e9  
SENS2:MIX:LO:POW 10  
SENS2:MIX:OUTP:FREQ:SID LOW  
SENS2:MIX:CALC Output  
SENS2:MIX:LO:NAME 'Port 3'  
SENS2:MIX:APPLY  
'-----  
' configure cal all  
'-----  
  
SYST:CAL:ALL:RESet  
SYST:CAL:ALL:SEL 1,2  
SYST:CAL:ALL:IFBW 1e3  
SYST:CAL:ALL:PORT1:SOUR:POWer -10  
SYST:CAL:ALL:CSET:PREFix 'MyCalAllExample'  
'-----  
' query for the available mixer cal properties to set  
' this is an info only query
```

```
'-----  
SYST:CAL:ALL:MCL:PROP:NAME:CAT? 'Scalar Mixer/Converter'  
SYST:CAL:ALL:MCL:PROP:VAL:CAT? 'Phase Correction Method'  
SYST:CAL:ALL:MCL:PROP:VAL:CAT? 'Mixer Delay'
```

```
'-----  
' Enable phase correction using a cal mixer with known delay  
'-----
```

```
SYST:CAL:ALL:MCL:PROP:VAL 'Enable Phase Correction','true'  
SYST:CAL:ALL:MCL:PROP:VAL 'Phase Correction Method','Use Mixer Delay'  
SYST:CAL:ALL:MCL:PROP:VAL 'Mixer Delay', '10e-9'
```

```
'-----  
' configure power sensor  
'-----
```

```
SYST:COMM:PSEN USB, "Agilent Technologies,U8485A,my53470003"
```

```
'-----  
' Perform calibration  
'-----
```

```
SYST:CAL:ALL:GUIDed:CHAN?
```

```
SENS200:corr:coll:guid:conn:port1 "APC 3.5 male"  
SENS200:corr:coll:guid:conn:port2 "APC 3.5 female"  
SENS200:corr:coll:guid:conn:port3 "Not used"  
SENS200:corr:coll:guid:conn:port4 "Not used"  
SENS200:corr:coll:guid:ckit:port1 "N4691-60004 ECal"  
SENS200:corr:coll:guid:ckit:port2 "N4691-60004 ECal"  
SENS200:corr:coll:guid:init  
SENS200:corr:coll:guid:steps?  
SENS200:corr:coll:guid:acq stan1  
SENS200:corr:coll:guid:acq stan2  
SENS200:CORR:COLL:GUID:desc? 3  
SENS200:corr:coll:guid:acq stan3  
SENS200:CORR:COLL:GUID:SAVE
```

The channel number used for the SENSE header is determined by the SYST:CAL:ALL:GUID:CHAN? command. You must query this channel number – do not assume that it will always be a particular value.

Configure an External Source

This VB Script program configures an External Source.

[Learn more about External Source Configuration](#)

These programs can be run as a macro in the VNA. To do this, copy the code into a text editor file such as Notepad and save on the VNA hard drive as ExtSource.vbs. [Learn how to setup and run the macro.](#)

[See all External Device Configuration commands](#)

[See Other SCPI Example Programs](#)

```
' Get the VNA application, and
' start the scpi parser, and preset the VNA
dim app
Set app = CreateObject("AgilentPNA835x.Application")
set scpi = app.ScpiStringParser
scpi.parse "*rst"
'Configure the external source
scpi.parse "Syst:conf:edev:add 'newSource'"
scpi.parse "Syst:conf:edev:dtype 'newSource', 'Source'"
scpi.parse "Syst:conf:edev:driver 'newSource', 'AGMXG'"
scpi.parse "Syst:conf:edev:ioconfig 'newSource', 'gpib0::16::instr'"
'Activate and enable the external source
scpi.parse "Syst:conf:edev:ioen 'newSource', 1"
'State activates and talks to the device if "Syst:conf:edev:ioen" is
enabled
scpi.parse "Syst:conf:edev:stat 'newSource', 1"
```

Getting and Putting Data

This Rocky Mountain Basic example does the following:

Takes a sweep, and reads the formatted data trace into an array. The trace is read as a definite length block.

Instructs you to remove DUT

Downloads the trace back to the analyzer as an definite length block.

[See Other SCPI Example Programs](#)

```
Sub SampleGetPutData()  
  '*** The variables of the resource manager and the instrument I/O are  
  declared.  
  Dim ioMgr As VisaComLib.ResourceManager  
  Dim GPIB As VisaComLib.FormattedIO488  
  '*** The memory area of the resource manager and the instrument I/O  
  are acquired.  
  Set ioMgr = New VisaComLib.ResourceManager  
  Set GPIB = New VisaComLib.FormattedIO488  
  '*** Open the instrument.  
  Set GPIB.IO = ioMgr.Open("GPIB0::16::INSTR")  
  GPIB.IO.timeout = 10000  
  
  Dim Numpts As Long  
  Dim Datam As Variant  
  
  'Select the measurement  
  GPIB.WriteString "CALCulatel:MEASure1:PARAmeter 'S21'", True  
  'Read the number of data points  
  GPIB.WriteString "SENSe1:SWEep:POINTs?", True  
  Numpts = GPIB.ReadNumber  
  'Turn continuous sweep off  
  GPIB.WriteString "INITiate:CONTinuous OFF", True  
  'Take a sweep  
  GPIB.WriteString "INITiate1:IMMediate;*WAI", True  
  'Ask for the Data  
  'PICK ONE OF THESE LOCATIONS TO READ  
  GPIB.WriteString "CALCulatel:MEASure1:DATA:FDATA?",  
  True  
  ' Formatted Meas  
  GPIB.WriteString "CALCulatel:MEASure1:DATA:FMEM?",  
  True  
  ' Formatted Memory  
  GPIB.WriteString "CALCulatel:MEASure1:DATA:SDATA?",  
  True  
  ' Corrected, Complex Meas  
  GPIB.WriteString "CALCulatel:MEASure1:DATA:SMEM?",  
  True  
  ' Corrected, Complex Memory  
  GPIB.WriteString "SENSe1:CORRection:CSET:ETERm:DATA?  
'Directivity(1,1)'", True  
  ' Error-Term Directivity  
  
  'Parse the data  
  Datam = GPIB.ReadList(ASCIIType_R8, ",")
```

```

'PUT THE DATA BACK IN
  GPIB.WriteString "CALCulatel:MEASure1:DATA:FDATA ",
False              ' Formatted Meas
  'GPIB.WriteString "CALCulatel:MEASure1:DATA:FMEM ",
False              ' Formatted Memory
  'GPIB.WriteString "CALCulatel:MEASure1:DATA:SDATA ",
False              ' Corrected, Complex Meas
  'GPIB.WriteString "CALCulatel:MEASure1:DATA:SMEM ",
False              ' Corrected, Complex Memory
  'GPIB.WriteString "SENSE1:CORREction:CSET:ETERm:DATA
'Directivity(1,1)',", False ' Error-Term Directivity

  GPIB.WriteList Datam, ASCIIType_R8, ",", True

  '*** End procedure
  GPIB.IO.Close
End Sub

```

```

100 DIM A$(10),Data1(1:51)
110 INTEGER Digits,Bytes
120 !
130 COM /Sys_state/ @Hp87xx,Scode
140 ! Identify I/O Port
150 CALL Iden_port
160 !
170 !
180 OUTPUT @Hp87xx;"SYST:PRES"
190 !
200 OUTPUT @Hp87xx;"CALC:PAR:SEL 'CH1_S11_1'"
210 !
220 ! Set up the analyzer to measure 51 data points.
230 OUTPUT @Hp87xx;"SENS1:SWE:POIN 51;*OPC?"
240 ENTER @Hp87xx;Opc
250 !
260 ! Take a single sweep, leaving the analyzer
270 ! in trigger hold mode.
280 OUTPUT @Hp87xx;"ABOR;:INIT1:CONT OFF;:INIT1;*WAI"
290 !
300 ! Select binary block transfer
310 OUTPUT @Hp87xx;"FORM:DATA REAL,64"
320 !
330 ! Request the channel 1 formatted data array
340 ! from the analyzer.
350 OUTPUT @Hp87xx;"CALC:DATA? FDATA"
360 !
370 ! Turn on ASCII formatting on the I/O path.
380 ! It is needed for reading the header
390 ! information.
400 ASSIGN @Hp87xx;FORMAT ON
410 !
420 ! Get the data header. "A$" will contain the
430 ! "#" character indicating a block data transfer.
440 ! "Digits" will contain the number of characters

```

```

450 ! for the number of bytes value which follows.
460 ENTER @Hp87xx USING "%,A,D";A$,Digits
470 !
480 ! Get the rest of the header. The number of
490 ! bytes to capture in the data array will be
500 ! placed in "Bytes". Note the use of "Digits"
510 ! in the IMAGE string.
515 !
520 ENTER @Hp87xx USING "%,&VAL$(Digits)&"D";Bytes
525 PRINT "HEADER",A$,Digits,Bytes
530 !
540 ! Turn off ASCII formatting on the I/O path;
550 ! it is not needed for transferring binary
560 ! formatted data.
570 ASSIGN @Hp87xx;FORMAT OFF
580 !
590 ! Get the data.
600 ENTER @Hp87xx;Data1(*)
610 !
620 ! Turn on ASCII formatting again.
630 ASSIGN @Hp87xx;FORMAT ON
640 !
650 ! Get the "end of data" character.
660 ENTER @Hp87xx;A$
670 !
680 ! Display the first three numbers in the array.
690 DISP "Trace: ";Data1(1);Data1(2);Data1(3);"..."
700 !
710 ! Use this time to visually compare the
720 ! numbers to the visible data trace.
730 WAIT 5
740 !
750 ! Prompt the operator to disconnect the test
760 ! device and how to continue the program.
770 DISP "Disconnect the test device -- Press Continue"
780 PAUSE
790 !
800 ! Update the display line.
810 DISP "Taking a new sweep...";
820 !
830 ! Take a sweep so the display shows new data.
840 OUTPUT @Hp87xx;":INIT1;*WAI"
850 DISP " Done."
860 WAIT 5
870 !
880 ! Send the header for an indefinite block length
890 ! data transfer.
900 DISP "Downloading saved trace...";
915 ! The first byte '3' indicates the next three digits equal number of
transfer bytes
916 ! The number of transfer bytes equals 8x the number of tracepoints.
920 OUTPUT @Hp87xx;"CALC:DATA FDATA, #3408";
930 !
940 ! Turn off ASCII formatting.
950 ASSIGN @Hp87xx;FORMAT OFF
960 !
970 ! Send the data array back to the analyzer.

```

```

980 OUTPUT @Hp87xx;Data1(*),END
990 !
1000 ! Turn on ASCII formatting again.
1010 ASSIGN @Hp87xx;FORMAT ON
1020 DISP " Done!"
1030 END
1040 !
1050 !*****
1060 ! Iden_port: Identify io port to use
1070 ! Description: This routines sets up the I/O port address for
1080 !               the SCPI interface. For "HP 87xx" instruments,
1090 !               the address assigned to @Hp87xx = 800 otherwise,
1100 !               716.
1110 !*****
1120 SUB Iden_port
1130     COM /Sys_state/ @Hp87xx,Scode
1140 !
1150     IF POS(SYSTEM$("SYSTEM ID"),"HP 87")<>0 THEN
1160         ASSIGN @Hp87xx TO 800
1170         Scode=8
1180     ELSE
1190         ASSIGN @Hp87xx TO 716
1200         Scode=7
1210     END IF
1220 !
1230 SUBEND !Iden_port
1240 !

```

Independent Power Calibration

The following program creates an independent power calibration over a specified frequency span when performing a Cal All.

This VBScript (*.vbs) program can be run as a macro in the PNA. To do this, copy the following code into a text editor file such as Notepad and save it on the PNA hard drive as BalancedCOM.vbs. [Learn how to setup and run the macro.](#)

```
SYST:PRESET
sens:freq:start 1e9
sens:freq:stop 2e9
calc2:par:def "S22Ch2",S22
disp:wind:trac2:feed "S22Ch2"
sens2:freq:start 5e9
sens2:freq:stop 7e9
SYST:CAL:ALL:RESet
syst:cal:all:sel 1,2
syst:cal:all:chan1:port:sel 1,2
syst:cal:all:mcl:prop:val "Include Power Calibration","true"
syst:cal:all:mcl:prop:val "Enable Extra Power Cals","Port 2,Port 3"
SYST:CAL:ALL:GUID:CHAN?
syst:cal:all:ind:sour:cal:cat?
syst:cal:all:ind:sour3:cal:range:add
syst:cal:all:ind:sour3:cal:rangel:start 3e9
syst:cal:all:ind:sour3:cal:rangel:stop 4e9
syst:cal:all:ind:sour3:cal:rangel:points 21
syst:cal:all:ind:sour3:cal:range:add
syst:cal:all:ind:sour3:cal:range2:start 20e9
syst:cal:all:ind:sour3:cal:range2:stop 21e9
syst:cal:all:ind:sour3:cal:range2:points 7
syst:cal:all:ind:sour2:cal:range:add
syst:cal:all:ind:sour2:cal:rangel:start 3e9
syst:cal:all:ind:sour2:cal:rangel:stop 4e9
syst:cal:all:ind:sour2:cal:rangel:points 21
syst:cal:all:ind:sour2:cal:rang:count?
syst:cal:all:ind:sour3:cal:rang:count?
syst:cal:all:ind:sour2:cal:rang:clear
syst:cal:all:ind:sour2:cal:range:count?
syst:cal:all:ind:sour3:cal:rangel:start?
syst:cal:all:ind:sour3:cal:rangel:stop?
```

```
syst:cal:all:independent:source3:cal:range1:points?  
syst:cal:all:ind:sour3:cal:range2:start?  
syst:cal:all:ind:sour3:cal:range2:stop?  
syst:cal:all:ind:sour3:cal:range2:points?  
SYST:CAL:ALL:PORT1:SOUR:POW:ATT 0  
SYST:CAL:ALL:PORT1:REC:ATT 0  
SENS500:CORR:COLL:GUID:CONN:PORT1 'APC 3.5 male'  
SENS500:CORR:COLL:GUID:CONN:PORT2 'APC 3.5 female'  
SYST:CAL:ALL:GUID:PORT?  
SENS500:CORR:COLL:GUID:CKIT:PORT1 'N4691-61004 ECal 13442'  
SENS500:CORR:COLL:GUID:CKIT:PORT2 'N4691-61004 ECal 13442'  
SENS500:CORR:COLL:GUID:PSEN1:POW:LEV -5  
SENS500:CORR:COLL:GUID:INIT  
SENS500:CORR:COLL:GUID:STEP?  
SENS500:CORR:COLL:GUID:DESC? 1  
**PAUSE**  
SENS500:CORR:COLL:GUID:ACQ STAN1  
SENS500:CORR:COLL:GUID:DESC? 2  
**PAUSE**  
SENS500:CORR:COLL:GUID:ACQ STAN2  
SENS500:CORR:COLL:GUID:DESC? 3  
**PAUSE**  
SENS500:CORR:COLL:GUID:ACQ STAN3  
SENS500:CORR:COLL:GUID:SAVE
```

The channel number used for the SENSE header is determined by the SYST:CAL:ALL:GUID:CHAN? command. You must query this channel number – do not assume that it will always be a particular value.

Perform a Guided Cal with Sliding Load

This example sets the sliding load behavior, then performs a Guided Calibration that uses a sliding load.

A measurement must first be set up with desired frequency range, power, and so forth, ready to be calibrated.

The SCPI commands in this example are sent over a COM interface using the SCPIStringParser object. You do not need to control the VNA via GPIB to run this example.

This VBScript (*.vbs) program can be run as a macro in the VNA. To do this, copy the following code into a text editor file, such as Notepad, and save it on the VNA hard drive as guided.vbs.

[Learn how to setup and run the macro.](#)

See [Guided Cal commands](#).

```
Set app = CreateObject("AgilentPNA835x.Application")
Set scpi = app.ScpiStringParser
' Specify that any sliding loads should be measured using the
' remote iterative method rather than launching sliding load dialog.
scpi.Execute "sens:corr:coll:guid:pref:slid iter"
scpi.Execute "sens:corr:coll:guid:conn:port1 ""APC 3.5 female"" "
scpi.Execute "sens:corr:coll:guid:conn:port2 ""APC 3.5 male"" "
' 85052B cal kit uses sliding loads
scpi.Execute "sens:corr:coll:guid:ckit:port1 ""85052B"" "
scpi.Execute "sens:corr:coll:guid:ckit:port2 ""85052B"" "
scpi.Execute "sens:corr:coll:guid:init"
numSteps = scpi.Execute("sens:corr:coll:guid:steps?")
' Measure the standards
For i = 1 To numSteps
    step = "Step " + CStr(i) + " of " + CStr(numSteps)
    strPrompt = scpi.Execute("sens:corr:coll:guid:desc? " + CStr(i))
    MsgBox strPrompt, vbOKOnly, step
    minIterations = scpi.Execute("sens:corr:coll:guid:iter:min? " +
CStr(i))
    For j = 1 To minIterations
        If minIterations > 1 Then MsgBox "Adjust/position the standard
for measurement \" + CStr(j) + \" of \" + CStr(minIterations), vbOKOnly
        scpi.Execute "sens:corr:coll:guid:acq STAN" + CStr(i)
    Next
    iterationCount = scpi.Execute("sens:corr:coll:guid:iter:coun? " +
CStr(i))
```



```
If iterationCount <> minIterations Then
    MsgBox "Unexpected error!", vbOKOnly, step
    scpi.Execute "sens:corr:coll:guid:iter:res " + CStr(i)
End If
Next
' Conclude the calibration
scpi.Execute "sens:corr:coll:guid:save"
```

Perform a Guided QSOLT Cal

This example performs a Guided QSOLT calibration on a 4-port VNA.

Because the DUT port 1 is female and the other ports are male, a 'Zero Thru' can be used between port 1 and the other ports. If this were NOT the case, a "Defined Thru" would be needed in the listed Cal Kits for those ports. [Learn more about Thru methods.](#)

Although no standards are used for ports 2, 3, and 4, a Cal Kit must be defined for these ports.

The SCPI commands in this example are sent over a COM interface using the SCPIStringParser object. You do not need to control the VNA via GPIB to run this example.

This VBScript (*.vbs) program can be run as a macro in the VNA. To do this, copy the following code into a text editor file, such as Notepad, and save it on the VNA hard drive as qsolt.vbs.

See Also

[Learn more about QSOLT.](#)

[Learn how to setup and run the macro.](#)

See [Guided Cal commands.](#)

```
Set app = CreateObject("AgilentPNA835x.Application")
Set scpi = app.ScpiStringParser
scpi.Execute "Calcl:Par:Mnum 1"
scpi.Execute "Sens1:CORR:COLL:GUID:CONN:PORT1:SEL 'APC 3.5 female'"
scpi.Execute "Sens1:CORR:COLL:GUID:CONN:PORT2:SEL 'APC 3.5 male'"
scpi.Execute "Sens1:CORR:COLL:GUID:CONN:PORT3:SEL 'APC 3.5 male'"
scpi.Execute "Sens1:CORR:COLL:GUID:CONN:PORT4:SEL 'APC 3.5 male'"
scpi.Execute "Sens1:CORR:COLL:GUID:CKIT:PORT1:SEL '85052B'"
scpi.Execute "Sens1:CORR:COLL:GUID:CKIT:PORT2:SEL '85052B'"
scpi.Execute "Sens1:CORR:COLL:GUID:CKIT:PORT3:SEL '85052B'"
scpi.Execute "Sens1:CORR:COLL:GUID:CKIT:PORT4:SEL '85052B'"
scpi.Execute "Sens1:CORR:COLL:GUID:THRU:PORT 1,2,1,3,1,4"
scpi.Execute "Sens1:CORR:COLL:GUID:PATH:TMET 1,2,'Zero Thru'"
scpi.Execute "Sens1:CORR:COLL:GUID:PATH:TMET 1,3,'Zero Thru'"
scpi.Execute "Sens1:CORR:COLL:GUID:PATH:TMET 1,4,'Zero Thru'"
scpi.Execute "Sens1:CORR:COLL:GUID:PATH:CMET 1,2,'QSOLT1'"
scpi.Execute "SENS1:CORR:COLL:GUID:PATH:CMET 1,3,'QSOLT1'"
scpi.Execute "SENS1:CORR:COLL:GUID:PATH:CMET 1,4,'QSOLT1'"
' Initiate the calibration and query the number of steps
scpi.Execute "sens1:corr:coll:guid:init"
```

```
numSteps = scpi.Execute("sens:corr:coll:guid:steps?")
MsgBox "Number of steps is " + CStr(numSteps)
' Measure the standards
For i = 1 To numSteps
step = "Step " + CStr(i) + " of " + CStr(numSteps)
strPrompt = scpi.Execute("sens:corr:coll:guid:desc? " + CStr(i))
MsgBox strPrompt, vbOKOnly, step
scpi.Execute "sens:corr:coll:guid:acq STAN" + CStr(i)
Next
' Conclude the calibration
scpi.Execute "SENS1:CORR:COLL:GUID:SAVE"
```

Perform a VMC Mixer Characterization

This example performs a VMC Mixer Characterization ONLY.

To run this example program without error:

Replace the ECal module model and serial number with that of your own, or a mechanical cal kit model.

Store a 'default.csa' instrument state file on the VNA with the setup information for your mixer. Or add mixer setup information to this program. [See an example.](#)

The SCPI commands in this example are sent over a COM interface using the SCPIStringParser object. You do NOT need a GPIB connection to run this example.

This VBScript (*.vbs) program can be run as a macro in the VNA. To do this, copy the following code into a text editor file, such as Notepad, and save it on the VNA hard drive as *.vbs.

[Learn how to setup and run the macro.](#)

See Other SCPI Example Programs

```
Dim app
Dim scpi
' Create / Get the VNA application.
Set app = CreateObject("AgilentPNA835x.Application")
Set scpi = app.ScpiStringParser
scpi.Parse "MMEM:LOAD 'default.csa'"

' Perform Cal

' Define the connector and calkit for port 1 of the VNA
scpi.Parse "sens:corr:coll:guid:conn:port1 'APC 3.5 female'"
scpi.Parse "sens:corr:coll:guid:ckit:port1 'N4691-60004 ECal 02593'"

' Define the connector and calkit for the mixer output port
scpi.Parse "sens:corr:coll:guid:conn:port3 'APC 3.5 female'"
scpi.Parse "sens:corr:coll:guid:ckit:port3 'N4691-60004 ECal 02593'"
```

```

' Select a characterization only calibration. This produces an s2p
' file of the mixer - so the mixer can be used as a calibration
' mixer for the VMC calibration
' The outcome of the calibration is an S2P file.
scpi.Parse "SENS:CORR:COLL:GUID:VMC:OPER 'CHAR'"
scpi.Parse "SENS:CORR:COLL:GUID:VMC:MIXer:CHAR:CAL:FIL 'C:/Program
Files/Keysight/Network Analyzer/Documents/MyMixer.s2p'"
' Set ECal Auto orientation ON
scpi.Parse "SENS:CORR:PREF:ECAL:ORI ON"
' For the mixer char step ONLY,
' Auto orientation is turned OFF by the VNA.
' Otherwise it would fail because of the loss of the mixer.
' Manually set the ECal orientation for that step.
scpi.Parse "SENS:CORR:COLL:GUID:VMC:MIXer:ECAL:PORTmap 1,'B1'"
' the main calibration loop
' a description for the connection instructions is read
' and then the standard is acquired
dim steps, strPrompt
scpi.Parse "sens:corr:coll:guid:init"
steps=scpi.Parse ("sens:corr:coll:guid:steps?")
wscript.echo "Number of Steps = " + cstr(steps)
if (steps > 0) then ' otherwise an error condition occurred
for i = 1 to steps
strPrompt = scpi.Parse ("sens:corr:coll:guid:desc? " + CStr(i))
MsgBox strPrompt, vbOKOnly, step
scpi.Parse ("sens:corr:coll:guid:acq STAN" + CStr(i))
next
scpi.Parse "sens:corr:coll:guid:save"
MsgBox ("Cal is done!")

```

end if

Perform an SMC Phase Ref Cal

This example sets Phase Reference Cal properties, then performs a Phase Reference calibration.

It is NOT necessary to create an SMC measurement before performing a **remote** Phase Reference Cal. It is necessary when performed from the user interface.

The SCPI commands in this example are sent over a COM interface using the SCPIStringParser object. You do NOT need a GPIB connection to run this example.

This VBScript (*.vbs) program can be run as a macro in the VNA. To do this, copy the following code into a text editor file, such as Notepad, and save it on the VNA hard drive as *.vbs.

[Learn how to setup and run the macro.](#)

[See Phase Reference Cal SCPI commands](#)

[Learn about SMC with Phase Ref Cal](#)

[See Other SCPI Example Programs](#)

```
Set app = CreateObject("agilentpna835x.application")
SET s = app.scpistringparser
s.parse "SYST:PRES"
s.parse "SENS:SWE:MODE HOLD"
' Set cal params
s.parse "SYST:CAL:PHAS:RESet"
s.parse "SYST:CAL:PHAS:FREQ:STAR 1e9"
s.parse "SYST:CAL:PHAS:FREQ:STOP 10E9"
' Read then set the phase ref ID
' Change this to your phase ref name
s.parse "SYST:CAL:PHAS:REF 'MYPILOT44'"
s.parse "SYST:CAL:PHAS:POW:ATT 10"
s.parse "SYST:CAL:PHAS:CONN 'APC 3.5 female'"
s.Parse "SYST:CAL:PHAS:CKIT '85052D'"
' turn on port 4 as well. Port 1 and Port 2 are always on
s.parse "SYST:CAL:PHAS:PORT4 on"
' Uncomment the following line to use
' an unknown mixer to measure below 55 Mhz.
' If the unknown mixer cal is ON, then the start frequency of the
' entire calibration is always 10 Mhz
' s.parse "SYST:CAL:PHAS:UNKN:INCLude ON"
' Read chan num then begin guided cal
```

```
chan = s.parse("SYST:CAL:PHAS:GUID:CHAN?")
header = "SENS" & CInt(chan) & ":CORR:COLL:GUID:"
S.parse header & "INIT"
steps = s.parse(header & "STEPS?")
wscript.echo steps
' Acquire stds
for i = 1 to steps
    MsgBox s.parse(header & "DESC? " & i)
    s.parse header & "ACQ STAN" & i
next
s.parse header & "SAVE:CSET 'scpi_phase_reference'"
msgbox "done"
```

Perform Unguided THRU Response Cal

This example program performs Thru Response calcs in both the forward and reverse directions. It does this by selecting the appropriate measurement right before acquiring the standard. The cal infers the direction from the measurement.

This program also demonstrates the use of the `SENSe:CORR:PREF:CSET:SAVE` command. The details are in the comments.

The SCPI commands in this example are sent over a COM interface using the `SCPIStringParser` object. You do NOT need a GPIB connection to run this example.

This VBScript (*.vbs) program can be run as a macro in the VNA. To do this, copy the following code into a text editor file such as Notepad and save it on the VNA hard drive as `Unguided.vbs`. [Learn how to setup and run the macro.](#)

```
Dim App
Set App = CreateObject("AgilentPNA835x.Application")
Dim Parser
Set Parser = App.SCPIStringParser
'Preset and delete measurement
Parser.Parse "SYSTem:FPReset"
'The following commands determine how the cal set is saved.
'Pick one of the following preferences, comment the other
'Save cals to separate new USER CalSets
'Parser.Parse "SENS:CORR:PREF:CSET:SAVE USER"
'Save both cals to a single cal register
'Parser.Parse "SENS:CORR:PREF:CSET:SAVE CALR"
'Save both cals to a single currently selected CalSet or register
Parser.Parse "SENS:CORR:PREF:CSET:SAVE REUSE"
'
'Create a new S21 Measurement
Parser.Parse "CALCulate:PARAMeter:DEFine:EXT 'MyS21Meas',S21"
Parser.Parse "DISPlay:WINDow1 ON"
Parser.Parse "DISPlay:WINDow1:TRACe1:FEED 'MyS21Meas'"
'Create a new S12 Measurement
Parser.Parse "CALCulate:PARAMeter:DEFine:EXT 'MyS12Meas',S12"
Parser.Parse "DISPlay:WINDow1:TRACe2:FEED 'MyS12Meas'"
'Turn off continuous sweep
Parser.Parse "INITiate:CONTInuous OFF"
'Begin cals
'Select a cal kit
Parser.Parse "SENSe:CORRection:COLlect:CKIT:SElect 1"
```

```
'Perform a forward thru response cal
'Select the S21 Meas
Parser.Parse "CALCulate1:PARAMeter:SElect 'MyS21Meas'"
'Set the calibration method to Thru Response
Parser.Parse "SENSE1:CORRection:COLLect:METhod TRAN1"
MsgBox("Connect Thru between ports  Then press OK")
Parser.Parse "SENSE1:CORRection:COLLect:ACQuire STAN4"
Parser.Parse "SENSE1:CORRection:COLLect:SAVE"
'Then perform a reverse thru response cal
'Change measurement to S12
Parser.Parse "CALCulate1:PARAMeter:SElect 'MyS12Meas'"
'Set the calibration method to Thru Response
Parser.Parse "SENSE1:CORRection:COLLect:METhod TRAN1"
'Ensure the thru connection is still in place
'Acquire Thru std in reverse direction
Parser.Parse "SENSE1:CORRection:COLLect:ACQuire STAN4"
'All standards have been measured.
Parser.Parse "SENSE1:CORRection:COLLect:SAVE"
'Turn ON continuous sweep
Parser.Parse "INITiate:CONTinuous ON"
MsgBox("The calibration has been completed")
```

Set ECal States

This example cycles through the state settings on **the first ECal module it finds on the USB bus**.

The state settings include **all of the ECal states on Port A, Port B and the AB thru path**. The first state on a port-pair path such as AB is the thru state that is used during calibrations. The second state on that path is the "confidence state" which is the equivalent of an attenuator that is used by the ECal Confidence Check feature.

The SCPI commands in this example are sent over a COM interface using the SCPIStringParser object. You do NOT need a GPIB connection to run this example.

This VBScript (*.vbs) program can be run as a macro in the VNA. To do this, copy the following code into a text editor file, such as Notepad, and save it on the VNA hard drive as *.vbs.

[Learn how to setup and run the macro.](#)

[See ECal State commands](#)

[See Other SCPI Example Programs](#)

```
Option Explicit
Dim app
Set app = CreateObject("AgilentPNA835x.Application")
Dim scpi
Set scpi = app.ScpiStringParser
Dim moduleIndexList
' These are 1-based indices as opposed to 0-based,
' so if this query returns 0 it indicates there appear
' to be no ECal modules connected.
moduleIndexList = Split( scpi.Parse("SENS:CORR:CKIT:ECAL:LIST?"), ",")
If Cint(moduleIndexList(0)) = 0 Then
    MsgBox "No ECal module was found"
    WScript.Quit(0)
End If
SetStates("A")
SetStates("B")
SetStates("AB")
MsgBox "Done"
Sub SetStates(path)
    Dim pathNumStates
```

```
pathNumStates = CInt( scpi.Parse("CONT:ECAL:MOD1:PATH:COUN? " +  
path) )  
Dim stateNum  
For stateNum = 1 To pathNumStates  
    Dim stateNumStr  
    stateNumStr = CStr(stateNum)  
    Dim pathDescr  
    If Len(path) = 1 Then  
        pathDescr = "port " + path  
    Else  
        pathDescr = "path " + path  
    End If  
    Dim isOK  
isOK = MsgBox("Click OK to switch to state number " + stateNumStr + "  
of " + pathDescr, vbOKCancel)  
    If isOK = vbCancel Then WScript.Quit(0)  
    scpi.Parse "CONT:ECAL:MOD1:PATH:STAT " + path + "," +  
stateNumStr  
Next  
End Sub
```

Use an Existing Power Cal During an SMC Cal

This example shows how to use an existing Source Power Cal instead of the power cal that is performed during an SMC calibration. To run this program without modification, you need the following:

- A Mixer setup file saved on the VNA: C:/Program Files/Keysight/Network Analyzer/Documents/Mixer/MyMixer.mxr.

- If the mixer file uses an external LO source, it must also be attached and configured.

- An ECAL module that covers the frequency range of the measurement.

- An SMC cal set named "SMC_CAL". This is the cal set that source power correction data will be imported from. The input and output frequency ranges of the cal set must cover the corresponding ranges used during calibration, or guided cal initialization will fail.

Error Messages

If you attempt to import power cal data from an SMC calset that uses different ports than the ones currently in use, the message **“The necessary calibration standards were not found.”** will appear.

If the imported Cal Set does not cover the frequency range of the current cal, the message **“Interpolation target is out of range. Cannot interpolate.”** will appear.

See Also

[Sens:Corr:Coll:Guid:SMC](#) commands

This VBScript (*.vbs) program can be run as a macro in the VNA. To do this, copy the following code into a text editor file such as Notepad and save on the VNA hard drive as SMC.vbs. Learn how to setup and run the macro.

```
Dim app
Dim scpi
' Create / Get the VNA application.
Set app = CreateObject("AgilentPNA835x.Application")
Set scpi = app.ScpiStringParser
'---Create a Scalar Mixer Forward Measurement
'First, delete all measurements on the channel
scpi.Parse "CALC:PAR:DEL:ALL"
'Create a forward scalar mixer measurement and configure it in
'channel 1. The first parameter is a unique
'identifying string (specified by the user) to allow subsequent
```

```

'commands to be directed at this specific measurement.
scpi.Parse "CALC:CUST:DEF 'My SC21', 'Scalar Mixer/Converter', 'SC21'"
'Setup the new measurement as the 2nd trace in the active window
scpi.Parse "DISP:WIND:TRAC2:FEED 'My SC21'"
'Make the new trace the active measurement
scpi.Parse "CALC:PAR:SEL 'My SC21'"
'The parameters of the mixer measurement can now be configured.
'This can be done by either using the individual SENS:MIX commands
'for each of the parameters or by loading a mixer setup file. This
'example loads a mixer setup file. The path name
'for the mixer file may be loaded from other mapped drives
scpi.Parse "SENS:MIXer:Load ""C:/Program Files/Keysight/Network
Analyzer/Documents/Mixer/MyMixer.mxr""""

'-----Perform A Scalar Mixer Calibration-----
-
'Specify the connector types and the cal kits for each of the ports.
scpi.Parse "SENS:CORR:COLL:GUID:CONN:PORT1:SEL ""APC 3.5 male""""
scpi.Parse "SENS:CORR:COLL:GUID:CONN:PORT2:SEL ""APC 3.5 female""""
scpi.Parse "SENS:CORR:COLL:GUID:CKIT:PORT1:SEL ""N4691-60004 ECal""""
scpi.Parse "SENS:CORR:COLL:GUID:CKIT:PORT2:SEL ""N4691-60004 ECal""""
'Import power cal data from the existing SMC calset "MySMC"
scpi.Parse "SENS:CORR:COLL:GUID:SMC:IMP ""SMC_CAL"" , ""POWER_STEP""""
'Specify the thru measurement method. This applies to both ECal
'and mechanical calibrations.
'Always send the init command before the Thru method command
scpi.Parse "SENS:CORR:COLL:GUID:INIT"
scpi.Parse "SENS:CORR:COLL:GUID:PATH:TMET 1,2, ""DEFINED THRU""""
'Omit the isolation part of the 2-port cal (default behavior).
scpi.Parse "SENS:CORR:COLL:GUID:ISOL NONE"
'Turn on auto orientation for the ECal (default behavior).
scpi.Parse "SENS:CORR:PREF:ECAL:ORI ON"
'Initialize an SMC guided calibration.
scpi.Parse "SENS:CORR:COLL:GUID:INIT"
'Tell the wizard to generate and report the number of steps in this
cal.
Dim steps
Dim desc
'Determine the number of steps required to complete the calibration.
steps = scpi.Parse ("SENS:CORR:COLL:GUID:STEP?")
  For i = 1 To steps
    'Display the prompt for each step

```

```
desc = scpi.Parse ("SENS:CORR:COLL:GUID:DESC? " & CStr(i))
MsgBox (desc)
'Perform the measurement for each step
scpi.Parse "SENS:CORR:COLL:GUID:ACQ STAN" & CStr(i)
Next
Dim calset
'Finish the cal and save the calset
calset = scpi.Parse ("SENS:CORR:COLL:GUID:SAVE OFF")
Msgbox ("SMC cal saved to cal register")
```

Learning about GPIB

The following topics can help you learn more about controlling the VNA using SCPI and the GPIB.

COM versus SCPI

GPIB Fundamentals

The Rules and Syntax of SCPI Commands

Configure for SCPI / SICL over GPIB

Configure for VISA / SICL over LAN

Calibrating the VNA Using SCPI

Getting Data from the VNA using SCPI

The VNA as a USB Device

Remote Control of SCPI USB Devices Connected to a VNA

Reading the VNA Status Registers

New Referring to Traces, Measurements, Channels, and Windows Using SCPI

Synchronizing the VNA and Controller

Shut Down the VNA Remotely

See more VNA programming information and examples

at: <http://na.support.keysight.com/pna/programming/>

CFMixer Topic

FCA (Opt009, S9x082AS93083A/B): [Configure](#) | [Calibrate](#) | [Segment Sweep](#)
 Noise Figure App (Opt 028, 029, S93029A/B): [Setup](#) | [Cal](#) | [SNP](#) | [ENR files](#) | [NFX](#)
 GCA (Opt S9x086A): [Setup](#) | [Cal](#) | [Analysis](#) | [GCX](#)

Common [Mixer Setup](#) commands
[Frequency Offset \(Opt S9x080A\)](#)

Description	SCPI
FCA Configure Measurements Use Mixer commands to setup the mixer. Use FCA Segment commands to setup segment sweep. Use the following commands to setup and calibrate SMC measurements.	
Create an FCA measurement	CALCulate:MEASure:DEFine
Change an FCA measurement	CALCulate:MEASure:PARAmeter
Sweep type	SENSe:SWEep:TYPE
Map DUT ports to PNA ports	SENSe:MIXer:PMAP
Read Input port map	SENSe:MIXer:PMAP:INPut
Read Output port map	SENSe:MIXer:PMAP:OUTPut

Minimum required FCA (SMC) Cal commands

SCPI examples.

Create Cal object	None
Begin Cal	SENSe:CORRection:COLLect:GUIDed:INITiate

Set connector type for each port	SENSe:CORRection:COLLect:GUIDed:CONNector:PORT:SElect
Set Cal Kit for each port	SENSe:CORRection:COLLect:GUIDed:CKIT:PORT:SElect
Returns the number of steps required by the Calibration	SENSe:CORRection:COLLect:GUIDed:STEPs?
Returns the step description.	SENSe:CORRection:COLLect:GUIDed:DESCRiption?
Measure a standard	SENSe:CORRection:COLLect:GUIDed:ACQuire
Generate Error Terms	SENSe:CORRection:COLLect:GUIDed:SAVE

Optional FCA (SMC) commands	
See SMC specific optional commands	
Set THRU method	SENSe:CORRection:COLLect:GUIDed:PATH:TMETHOD
Sets ECAL auto-orientation ON or OFF	SENSe:CORRection:PREFerence:ECAL:ORientation
Sets ECAL port map when orientation is off.	SENSe:CORRection:PREFerence:ECAL:PMAP
Perform or Omit Isolation	SENSe:CORRection:COLLect:GUIDed:ISOLation

SMC Optional commands	
SMC network embed/deembed	SENSe:CORRection:COLLect:GUIDed:SMC:FSIMulator:NETWork:MODE
SMC filename	SENSe:CORRection:COLLect:GUIDed:SMC:FSIMulator:NETWork:FILEname
Import existing Phase Ref Cal or Source Power Cal	SENSe:CORRection:COLLect:GUIDed:SMC:IMPort

Use Thru or perform separate power calcs	SENSe:CORRection:COLLect:GUIDed:SMC:PWRCal:SEParate
Include Reverse SC12 sweep	SENSe:MIXer:REVerse
Include input/output match correction	CALCulate:MEASure:CORRection:TYPE
Use Nominal Incident Power	SENSe:MIXer:INPut:POWer:USENominal
Enable LO Power Cal	SENSe:CORRection:COLLect:GUIDed:SMC:LO:PCAL
Save to s2p and s2px file	MMEMory:STORe

FCA Segment Sweep	
SCPI examples.	
Recalculate	SENSe:MIXer:RECalculate
Segment Calculate	SENSe:MIXer:SEGMENT:CALCulate
Query Count	SENSe:MIXer:SEGMENT:COUNT?
Add Segments	SENSe:MIXer:SEGMENT:ADD
Delete Segments	SENSe:MIXer:SEGMENT:DEL
Remove All Segments	SENSe:MIXer:SEGMENT:DELEte:ALL
State	SENSe:MIXer:SEGMENT[:STATe]

Number Of Points	SENSe:MIXer:SEGMENT:POINTs
IFBW	SENSe:MIXer:SEGMENT:BWIDth
Input Fixed Freq	SENSe:MIXer:SEGMENT:INPut:FREQUency:FIXed
Input Start Freq	SENSe:MIXer:SEGMENT:INP:FREQUency:STARt
Input Stop Freq	SENSe:MIXer:SEGMENT:INP:FREQUency:STOP
Input Fixed/Swept	SENSe:MIXer:SEGMENT:INP:FREQUency:MODE
Input Power	SENSe:MIXer:SEGMENT:INPut:POWer
Output Fixed Freq	SENSe:MIXer:SEGMENT:OUTP:FREQUency:FIXed
Output Start Freq	SENSe:MIXer:SEGMENT:OUTP:FREQUency:STARt
Output Stop Freq	SENSe:MIXer:SEGMENT:OUTP:FREQUency:STOP
Output Fixed/Swept	SENSe:MIXer:SEGMENT:OUTP:FREQUency:MODE
Output (+/-)	SENSe:MIXer:SEGMENT:OUTP:FREQUency:SIDeband
Output Power	SENSe:MIXer:SEGMENT:OUTPut:POWer
LO Fixed Freq	SENSe:MIXer:SEGMENT:LO<x>:FREQUency:FIXed
LO Start Freq	SENSe:MIXer:SEGMENT:LO<x>:FREQUency:STARt
LO Stop Freq	SENSe:MIXer:SEGMENT:LO<x>:FREQUency:STOP
LO Fixed/Swept	SENSe:MIXer:SEGMENT:LO<x>:FREQUency:MODE
Input >LO	SENSe:MIXer:SEGMENT:LO<x>:FREQUency:ILTI
LO Power	SENSe:MIXer:SEGMENT:LO<x>:POWer
IF (+/-)	SENSe:MIXer:SEGMENT:IF:FREQUency:SIDeband



Coherence Setup tab

SA Setup : Channel 1

SA Source Coherence Trig. & Pulse Advanced

Multitone

- Enable multitone
- Tone Spacing: 100.000000000 kHz
- Waveform Period: 10.000000 μs
- Reference Tone: 3.100000000 GHz
- Reject up to harmonic: 0
- Nyquist protect order: 0
- Vector averaging: 10

Data Display

- Show All
- Zero the non-tones
- Discard the non-tones

Multitone settings are valid

BASIC | advanced Defaults OK Cancel Apply Help

SENSe:SA:ADC:RECOrd:SIZE:FORCe:VALue	
ADCRecordSizeMax	
SENSe:SA:ADC:RECOrd:SIZE:MIN?	ADCRecordSizeMin

Read occupied bandwidth center frequency	CALCulate:MEASure:SA:MARKer:OCCBand:CENTer?	OccupiedBandCenter
Set and read occupied bandwidth percentage of span	CALCulate:MEASure:SA:MARKer:OCCBand:PERCent	OccupiedBandPercent
Read the occupied bandwidth power.	CALCulate:MEASure:SA:MARKer:OCCBand:POWer?	OccupiedBandPowerBm
Read occupied bandwidth span	CALCulate:MEASure:SA:MARKer:OCCBand:SPAN?	OccupiedBandSpan
Set occupied bandwidth state	CALCulate:MEASure:SA:MARKer:OCCBand[:STATe]	OccupiedBandState

Mixer Setup commands

Used for FCA applications.

See the [Mixer / Converter Setup](#) topic

Create or Change a Custom (Application) Measurement

Create a custom measurement	CALCulate:CUSTom:DEFine
Change a custom measurement	CALCulate:CUSTom:MODify
Return handle to a converter object	None

Mixer Bottom Buttons and X-Axis display	
Load a mixer setup	SENSe:MIXer:LOAD
Save a mixer setup	SENSe:MIXer:SAVE
Apply mixer settings	SENSe:MIXer:APPLY
Discard Changes	SENSe:MIXer:DISCARD
X-axis display	CALCulate:MEASure:MIXer:XAXis

Mixer Frequency Tab	
Calculate Input and Output frequencies	SENSe:MIXer:CALCulate
Input to swept or fixed	SENSe:MIXer:INPut:FREQuency:MODE
Input start frequency	SENSe:MIXer:INPut:FREQuency:STAR
Input stop frequency	SENSe:MIXer:INPut:FREQuency:STOP
Input power level	SENSe:MIXer:INPut:POWer
Input fixed frequency	SENSe:MIXer:INPut:FREQuency:FIXed
Set LO	
LO freq fixed or swept	SENSe:MIXer:LO:FREQuency:MODE
LO fixed frequency	SENSe:MIXer:LO:FREQuency:FIXed
LO start frequency	SENSe:MIXer:LO:FREQuency:STARt
LO stop frequency	SENSe:MIXer:LO:FREQuency:STOP
Input Greater / Less than LO	SENSe:MIXer:LO:FREQuency:ILTI
Set IF	
Sideband (high or low)	SENSe:MIXer:IF:FREQuency:SIDE
IF start frequency	SENSe:MIXer:IF:FREQuency:STARt
IF stop frequency	SENSe:MIXer:IF:FREQuency:STOP

Set Output	
Sideband (high or low)	SENSe:MIXer:OUTPut:FREQuency:SIDE
Output start frequency	SENSe:MIXer:OUTPut:FREQuency:START
Output stop frequency	SENSe:MIXer:OUTPut:FREQuency:STOP
Output to swept or fixed	SENSe:MIXer:OUTPut:FREQuency:MODE
Output fixed frequency	SENSe:MIXer:OUTPut:FREQuency:FIXed

Mixer (LO)Power tab	
LO power	SENSe:MIXer:LO:POW
LO power start	SENSe:MIXer:LO:POW:START
LO power stop	SENSe:MIXer:LO:POW:STOP
Source Attenuator	SOURce:POWer:ATTenuation
Receiver Attenuator	SENSe:POWer:ATTenuator
Leveling Mode	

Mixer Setup tab	
Number of LOs (1 or 2)	SENSe:MIXer:STAGe
Recall a previously-configured external source.	SENSe:MIXer:LO:NAME
Assign a source to mixer input or LO.	SENSe:MIXer:ROLE:DEVice
Read all assigned roles	SENSe:MIXer:ROLE:CATalog?
Read the source assigned to a role.	SENSe:MIXer:ROLE:DEVice
Input Numerator Frac.Mult	SENSe:MIXer:INPut:FREQuency:NUMerator
Input Denominator Frac.Mult	SENSe:MIXer:INPut:FREQuency:DENominator

LO Numerator Frac. Mult.	SENSe:MIXer:LO:FREQuency:NUMerator
LO Denominator Frac.Mult	SENSe:MIXer:LO:FREQuency:DENominator

XResponseTopic

[Measurements](#) | [Balanced Meas](#) | [Auxiliary](#) | [Conversions](#) | [Format](#) | [Scale](#) | [Elect Delay](#) | [Constants](#) | [Math](#) | [Equation Editor](#) | [Statistics](#) | [Uncertainty Analysis](#) | [Limits](#) | [Bandwidth Tests](#) | [Ripple Tests](#) | [Transform](#) | [Gating](#) | [Window](#) | [Coupling](#) | [Distance Markers](#) | [Avg](#) | [IFBW](#) | [Smoothing](#) | [Group Delay](#) | [Cal](#) | [Marker Functions](#) | [Marker Search Functions](#)

Show | Hide: [Status Bar](#) | [Toolbar](#) | [Tables](#) | [Marker Disp](#)

Description	SCPI
Speed up Measurements !	
Measurement Trace On Off	DISPlay:WINDow:TRACe[:STATe]
Display Update On Off	DISPlay:ENABLE
Window Update On Off	DISPlay:WINDow:ENABLE
Analyzer Visible On Off	DISPlay:VISible
Measurement display update	CALCulate:PARAmeter:SElect<name>[,fast] CALCulate:PARAmeter:MNUMber[:SElect<num>[,fast]

Auxiliary	
AuxInN Source Port N	CALCulate:MEASure:PARAmeter

Conversions	
Off	CALCulate:MEASure:CONVersion:FUNctIon
Z-Reflect	CALCulate:MEASure:CONVersion:FUNctIon
Z-Transmit	CALCulate:MEASure:CONVersion:FUNctIon
Z-Trans-Shunt	CALCulate:MEASure:CONVersion:FUNctIon
Y-Reflect	CALCulate:MEASure:CONVersion:FUNctIon

Y-Transmit	CALCulate:MEASure:CONVersion:FUNction
Y-Trans-Shunt	CALCulate:MEASure:CONVersion:FUNction
1 / S	CALCulate:MEASure:CONVersion:FUNction
Conjugation	CALCulate:MEASure:CONVersion:FUNction

Format	
Log Mag	CALCulate:MEASure:FORMat
Lin Mag	CALCulate:MEASure:FORMat
Phase	CALCulate:MEASure:FORMat
Delay	CALCulate:MEASure:FORMat
Smith	CALCulate:MEASure:FORMat
Polar	CALCulate:MEASure:FORMat
SWR	CALCulate:MEASure:FORMat
Real	CALCulate:MEASure:FORMat
Imaginary	CALCulate:MEASure:FORMat
Unwrapped Phase	CALCulate:MEASure:FORMat
Positive Phase	CALCulate:MEASure:FORMat
Inverted Smith	CALCulate:MEASure:FORMat
Group Delay Aperture Points	CALCulate:MEASure:GDElay:POINts
Group Delay Aperture Percent of Span	CALCulate:MEASure:GDElay:PERCent
Group Delay Aperture Frequency	CALCulate:MEASure:GDElay:FREQuency
Set Preference to 2 points	SYSTem:PREFerences:ITEM:GDElay:TWOPoint

Set or return the units for the specified data format	CALCulate:MEASure:FORMat:UNIT
Temperature	CALCulate:MEASure:FORMat

Scale	
AutoScale	DISPlay:WINDow:TRACe:Y:AUTO
AutoScale All	DISPlay:WINDow:Y:AUTO
Per Division	DISPlay:WINDow:TRACe:Y:PDIVision
Reference Level	DISPlay:WINDow:TRACe:Y:RLEVel
Reference Position	DISPlay:WINDow:TRACe:Y:RPOStion

Scale Coupling	
Set method	DISPlay:WINDow:TRACe:Y:COUPlE:METhod
Enable window	DISPlay:WINDow:TRACe:Y:COUPlE

Electrical Delay	
Electrical Delay	CALCulate:MEASure:CORRection:EDELay:TIME
Delay in distance	CALCulate:MEASure:CORRection:EDELay:DIStance
Set units for distance	CALCulate:MEASure:CORRection:EDELay:UNIT
Velocity Factor	SENSe:CORRection:RVELocity:COAX
Media	CALCulate:MEASure:CORRection:EDELay:MEDIum
Wavegd Cutoff	CALCulate:MEASure:CORRection:EDELay:WGCutoff

Constants	
-----------	--

System Z0	SENSe:CORRection:IMPedance:INPut:MAGNitude
Phase Offset	CALCulate:MEASure:OFFSet:PHASe
Mag Offset	CALCulate:MEASure:OFFSet:MAGNitude
Mag Slope	CALCulate:MEASure:OFFSet:MAGNitude:SOPe

Math	
Data Trace ON OFF	DISPlay:WINDow:TRACe[:STATe]
Memory Trace ON OFF	DISPlay:WINDow:TRACe:MEMory
Data =>Memory	CALCulate:MEASure:MATH:MEMorize
Memory data interpolation ON OFF	CALCulate:MEASure:MATH:INTerpolate[:STATe]
Data Math (Add Sub Mult Div)	CALCulate:MEASure:MATH:FUNction

Equation Editor	
Delay data processing to end of sweep	CALCulate:MEASure:EQUation:FAST
Turn ON / OFF equation	CALCulate:MEASure:EQUation[:STATe]
Set equation	CALCulate:MEASure:EQUation:TEXT
Return validity of equation	CALCulate:MEASure:EQUation:VALid?
Returns the functions in DLL	CALCulate:EQUation:LIBRary:FUNCTions
Imports the functions in DLL	CALCulate:EQUation:LIBRary:IMPorT
Is DLL Imported?	CALCulate:EQUation:LIBRary:IMPorT?
Remove a DLL	CALCulate:EQUation:LIBRary:REMOve

Statistics	
Statistics ON OFF	CALCulate:MEASure:FUNcTion:STATistics[:STATe]
Statistics Range	CALCulate:MEASure:FUNcTion:DOMain:USER[:RANGe]
Domain Range Start	CALCulate:MEASure:FUNcTion:DOMain:USER:STARt
Domain Range Stop	CALCulate:MEASure:FUNcTion:DOMain:USER:STOP
Set Type (Pk-Pk StdDev Mean)	CALCulate:MEASure:FUNcTion:TYPE
Get All Statistics Data	CALCulate:MEASure:FUNcTion:DATA?
Get Standard Deviation	CALCulate:MEASure:FUNcTion:DATA?
Get Mean	CALCulate:MEASure:FUNcTion:DATA?
Get Peak to Peak	CALCulate:MEASure:FUNcTion:DATA?
Get formatted data array of multiple traces	CALCulate:DATA:MFData
Get corrected data array of multiple traces	CALCulate:DATA:MSData
Executes the statistical analysis	CALCulate:MEASure:FUNcTion:EXECute

Uncertainty Analysis	
Trace	CALCulate:MEASure:UNCertainty:DISPlay:CFAcTOr
Trace Type	CALCulate:MEASure:UNCertainty:DISPlay:TYPE
Noise	CALCulate:MEASure:UNCertainty:MODE:NOISe
Repeatability	CALCulate:MEASure:UNCertainty:MODE:CABLe:REPeat
Calibration	CALCulate:MEASure:UNCertainty:MODE:ETERm
Save uncertainty data	CALCulate:MEASure:UNCertainty:SAVE

Limits	
Display Lines ON OFF	CALCulate:MEASure:LIMit:DISPlay[:STATe]
Fail Sound ON OFF	CALCulate:MEASure:LIMit:SOUNd[:STATe]
Testing ON OFF	CALCulate:MEASure:LIMit[:STATe]
Limit Test Failed	CALCulate:MEASure:LIMit:FAIL?
Count Limit Lines	None
Read Test Results	GP-IB_Command_Finder/Status
Set / Read entire Limit Line	CALCulate:MEASure:LIMit:DATA
Limit Line Type (Max Min)	CALCulate:MEASure:LIMit:SEGMENT:TYPE
Begin Stimulus	CALCulate:MEASure:LIMit:SEGMENT:STIMulus:START
End Stimulus	CALCulate:MEASure:LIMit:SEGMENT:STIMulus:STOP
Begin Response	CALCulate:MEASure:LIMit:SEGMENT1:AMPLitude:START
End Response	CALCulate:MEASure:LIMit:SEGMENT1:AMPLitude:STOP
Read the bandwidth test results for the active trace of selected channel.	CALCulate:MEASure:LIMit:REPort:ALL CALCulate:LIMit:REPort:ALL
Read the stimulus values at all the measurement points that failed the limit test for the active trace of selected channel.	CALCulate:MEASure:LIMit:REPort:DATA CALCulate:LIMit:REPort:DATA
Reads the number of the measurement points that failed the limit test, for the active trace of selected channel.	CALCulate:MEASure:LIMit:REPort:POINts CALCulate:LIMit:REPort:POINts
Delete all limit line data	CALCulate:MEASure:LIMit:DATA:DELeTe
Show Limit table	DISPlay:WINDow:TABLE
Global Pass/Fail	
Show / hide the pass/fail dialog.	DISPlay:FSIGN

Sets the policy used to compute the global pass/fail value.	CONTrol:HANDler:PASSfail:POLicy CONTrol:AUXiliary:PASSfail:POLicy
Reads the most recent pass/fail status value.	CONTrol:HANDler:PASSfail:STATus? CONTrol:AUXiliary:PASSfail:STATus?
Sets the logic of the AuxIO PassFail line.	CONTrol:HANDler:PASSfail:LOGic CONTrol:AUXiliary:PASSfail:LOGic
Sets the default logical pass/fail state.	CONTrol:HANDler:PASSfail:MODE CONTrol:AUXiliary:PASSfail:MODE
Sets the scope (Global or channel) of AuxIO pass/fail testing.	CONTrol:HANDler:PASSfail:SCOPE CONTrol:AUXiliary:PASSfail:SCOPE

Bandwidth Tests	
Set bandwidth threshold value of bandwidth test.	CALCulate:MEASure:BLIMit:BWIDth:THReshold
Turn ON/OFF the bandwidth value display of the bandwidth test.	CALCulate:MEASure:BLIMit:BWIDth:DISPlay:MARKer:STATe
Get the bandwidth limit test results.	CALCulate:MEASure:BLIMit:FAIL
Set/get the upper limit value of the bandwidth test.	CALCulate:MEASure:BLIMit:MAXimum
Set/get the lower limit value of the bandwidth test.	CALCulate:MEASure:BLIMit:MINimum
Get the bandwidth value of the bandwidth test.	CALCulate:MEASure:BLIMit:REPort:DATA
Turn ON/OFF the bandwidth test function.	CALCulate:MEASure:BLIMit:STATe

Ripple Tests

Set or return the ripple limit table	CALCulate:MEASure:RLIMit:DATA
Turn ON/OFF the ripple limit line display	CALCulate:MEASure:RLIMit:DISPlay::LINE:STATe
Set/get the ripple limit band	CALCulate:MEASure:RLIMit:DISPlay:SElect
Set/get the display type of ripple value	CALCulate:MEASure:RLIMit:DISPlay:TYPE
Read the ripple test result	CALCulate:MEASure:RLIMit:FAIL
Read the ripple value	CALCulate:MEASure:RLIMit:REPort:DATA
Turn ON/OFF the ripple test function	CALCulate:MEASure:RLIMit:STATe

Transform	
Sets the alignment of the time domain measurement.	CALCulate:MEASure:TRANSform:TIME:ALIGNment
Transform ON OFF	CALCulate:MEASure:TRANSform:TIME:STATe
Mode (LowPass, BandPass)	CALCulate:MEASure:TRANSform:TIME[:TYPE]
Start Time	CALCulate:MEASure:TRANSform:TIME:START
Stop Time	CALCulate:MEASure:TRANSform:TIME:STOP
Center	CALCulate:MEASure:TRANSform:TIME:CENTer
Span	CALCulate:MEASure:TRANSform:TIME:SPAN
Step Rise Time	CALCulate:MEASure:TRANSform:TIME:STEP:RTIME
Set Low Pass Frequency	CALCulate:MEASure:TRANSform:TIME:LPFREQuency
Set/get the impulse width	CALCulate:MEASure:TRANSform:TIME:IMPulse:WIDTh
TD Toolbar	DISPlay:TOOLbar:TRANSform[:STATe]

Gating

ON OFF	CALCulate:MEASure:FILTer[:GATE]:TIME:STATe
Type (BandPass, Notch)	CALCulate:MEASure:FILTer[:GATE]:TIME[:TYPE]
Shape	CALCulate:MEASure:FILTer[:GATE]:TIME:SHAPE
Start	CALCulate:MEASure:FILTer[:GATE]:TIME:START
Stop	CALCulate:MEASure:FILTer[:GATE]:TIME:STOP
Center	CALCulate:MEASure:FILTer[:GATE]:TIME:CENTER
Span	CALCulate:MEASure:FILTer[:GATE]:TIME:SPAN
Set gate coupling parameters	CALCulate:MEASure:FILTer[:GATE]:COUPLE:PARAMeters

Window	
Kaiser Beta	CALCulate:MEASure:TRANSform:TIME:KBESsel
Impulse Width	CALCulate:MEASure:TRANSform:TIME:IMPulse:WIDTH

Coupling	
Enable trace coupling	SENSe:COUPLE:PARAMeter[:STATe]
Set transform coupling parameters	CALCulate:MEASure:TRANSform:COUPLE:PARAMeters

Distance Markers	
Specify measurement type for distance markers	CALCulate:MEASure:TRANSform:TIME:MARKer:MODE
Specify units for distance markers	CALCulate:MEASure:TRANSform:TIME:MARKer:UNIT
Set and return marker distance value	CALCulate:MEASure:MARKer:DISTance

Averaging	
Average ON OFF	SENSe:AVERAge[:STATe]
Average Factor	SENSe:AVERAge:COUNT
Return the Average Count	None
Average Type	SENSe:AVERAge:MODE
Average Restart	SENSe:AVERAge:CLEAR

IF Bandwidth	
IF Bandwidth	SENSe:BANDwidth BWIDth[:RESolution]
Previous IF Bandwidth	None
Next IFBandwidth	None
Reduce IF BW	SENSe:BANDwidth BWIDth:TRACK

Smoothing	
Smoothing ON OFF	CALCulate:MEASure:SMOothing[:STATe]
Smoothing Percent	CALCulate:MEASure:SMOothing:APERture
Smoothing Points	CALCulate:MEASure:SMOothing:POINts

Marker Functions	
ON OFF	CALCulate:MEASure:MARKer[:STATe]
Delete All Markers	CALCulate:MEASure:MARKer:AOFF
Delete Marker	CALCulate:MEASure:MARKer[:STATe]
Delta Marker	CALCulate:MEASure:MARKer:DELTA

Viewing Marker readouts	Display
Get a handle to Ref marker	None
Reference Marker	
Reference Marker On Off	CALCulate:MEASure:MARKer:REFerence[:STATe]
Set and read X-axis location	CALCulate:MEASure:MARKer:REFerence:X
Set and read Y-axis location	CALCulate:MEASure:MARKer:REFerence:Y
Advanced Settings	
Interpolate All Markers (Discrete)	None
Interpolate Individ. Marker (Discrete)	CALCulate:MEASure:MARKer:DISCrete
Type (Normal Fixed)	CALCulate:MEASure:MARKer:TYPE
Format Individ. Marker	CALCulate:MEASure:MARKer:FORMat
Coupled Markers	CALCulate:MEASure:MARKer:COUPling[:STATe]
Coupled Markers Method	CALCulate:MEASure:MARKer:COUPling:METHod
Read/Set Data Point number	CALCulate:MEASure:MARKer:BUCKet
Read/Set X-axis value	CALCulate:MEASure:MARKer:X
Read/Set Y-axis value	CALCulate:MEASure:MARKer:Y
Function	
Marker=> SA	CALCulate:MEASure:MARKer:SET
Marker=> Span	CALCulate:MEASure:MARKer:SET
Marker=> Center (Freq)	CALCulate:MEASure:MARKer:SET
Marker=> CW Freq and change sweep type	CALCulate:MEASure:MARKer:SET

Marker=> Start (Freq)	CALCulate:MEASure:MARKer:SET
Marker=> Stop (Freq)	CALCulate:MEASure:MARKer:SET
Marker=> Elect. Delay	CALCulate:MEASure:MARKer:SET
Marker=> Ref. Level	CALCulate:MEASure:MARKer:SET
Marker=> CW Freq - No sweep type change	CALCulate:MEASure:MARKer:SET

SA Band Marker Settings

Read Band Power	CALCulate:MEASure:SA:MARKer:BPOWer:DATA?
Read Band Power Span	CALCulate:MEASure:SA:MARKer:BPOWer:SPAN
Set Band Power State	CALCulate:MEASure:SA:MARKer:BPOWer[:STATe]
Read Band Noise	CALCulate:MEASure:SA:MARKer:BNOise:DATA?
Read Band Noise Span	CALCulate:MEASure:SA:MARKer:BNOise:SPAN
Set Band Noise State	CALCulate:MEASure:SA:MARKer:BNOise[:STATe]

Compression Marker Search

Compression Marker level found.	CALCulate:MEASure:MARKer:FUNCTion:COMPression:LEVel
Read Compression Marker Input power	CALCulate:MEASure:MARKer:FUNCTion:COMPression:PIN
Read Compression Marker Output power	CALCulate:MEASure:MARKer:FUNCTion:COMPression:POUT
Search function	CALCulate:MEASure:MARKer:FUNCTion[:SElect]
Turn ON OFF the compression state	CALCulate:MEASure:MARKer:FUNCTion:COMPression[:STATe]
Execute function	CALCulate:MEASure:MARKer:FUNCTion:EXECute

PSAT Marker Search	
Initiate a PSAT search	CALCulate:MEASure:MARKer:PSATuration:BACKoff
Set and read PSAT backoff	CALCulate:MEASure:MARKer:PSATuration:BACKoff
Read PSat Out	CALCulate:MEASure:MARKer:PSATuration:POUT?
Read PSat In	CALCulate:MEASure:MARKer:PSATuration:PIN?
Read PMax Out	CALCulate:MEASure:MARKer:PSATuration:POUT:MAXimum?
Read PMax In	CALCulate:MEASure:MARKer:PSATuration:PIN:MAXimum?
Read Gain Sat	CALCulate:MEASure:MARKer:PSATuration:GAIN?
Read Gain Max	CALCulate:MEASure:MARKer:PSATuration:GAIN:MAXimum?
Read Gain Linear	CALCulate:MEASure:MARKer:PSATuration:GAIN:LINEar?
Read Comp Sat	CALCulate:MEASure:MARKer:PSATuration:COMPression:SATuration?
Read Comp Max	CALCulate:MEASure:MARKer:PSATuration:COMPression:MAXimum?
Turn ON OFF PSAT marker search	CALCulate:MEASure:MARKer:PSATuration[:STATe]

PNOP Marker Search	
Initiate a PNOP search	CALCulate:MEASure:MARKer:PNOP:BACKoff
PNOP backoff	CALCulate:MEASure:MARKer:PNOP:BACKoff
PNOP Power Offset	CALCulate:MEASure:MARKer:PNOP:POFFset
Read Pnop Out	CALCulate:MEASure:MARKer:PNOP:POUT?
Read Pnop in	CALCulate:MEASure:MARKer:PNOP:PIN?
Read Pnop Gain	CALCulate:MEASure:MARKer:PNOP:GAIN?
Read Pnop Comp	CALCulate:MEASure:MARKer:PNOP:COMPression?

Read PMax Out	CALCulate:MEASure:MARKer:PNOP:POUT:MAXimum?
Read PMax In	CALCulate:MEASure:MARKer:PNOP:PIN:MAXimum?
Read Gain Max	CALCulate:MEASure:MARKer:PNOP:GAIN:MAXimum?
Read Comp Max	CALCulate:MEASure:MARKer:PNOP:COMPression:MAXimum?
Read PBO Out	CALCulate:MEASure:MARKer:PNOP:BACKoff:POUT?
Read PBO In	CALCulate:MEASure:MARKer:PNOP:BACKoff:PIN?
Read PBO Gain	CALCulate:MEASure:MARKer:PNOP:BACKoff:GAIN?
Turn ON OFF PNOP marker search	CALCulate:MEASure:MARKer:PNOP[:STATe]

Basic Marker Search Functions	
Execute Search	CALCulate:MEASure:MARKer:FUNCTion:EXECute
Select Search Function	CALCulate:MEASure:MARKer:FUNCTion[:SElect]
Maximum	CALCulate:MEASure:MARKer:FUNCTion[:SElect]
Minimum	CALCulate:MEASure:MARKer:FUNCTion[:SElect]
Target (Value)	CALCulate:MEASure:MARKer:FUNCTion:TARGeT[:VALue]
Select transition type	CALCulate:MEASure:MARKer:FUNCTion:TARGeT:TRANSition
Excursion Value	CALCulate:MEASure:MARKer:FUNCTion:PEAK:EXCursion
Threshold Value	CALCulate:MEASure:MARKer:FUNCTion:PEAK:THReshold
Set or return polarity of the peak search	CALCulate:MEASure:MARKer:FUNCTion:PEAK:POLarity
Assign Marker to Domain	CALCulate:MEASure:MARKer:FUNCTion:DOMain:USER[:RANGE]
Domain Range Start	CALCulate:MEASure:MARKer:FUNCTion:DOMain:USER:START
Domain Range Stop	CALCulate:MEASure:MARKer:FUNCTion:DOMain:USER:STOP
Tracking	CALCulate:MEASure:MARKer:FUNCTion:TRACKing

Bandwidth & Notch Marker Search	
Bandwidth (Target)	CALCulate:MEASure:MARKer:BWIDth:THReshold
Search Filter Bandwidth	CALCulate:MEASure:MARKer:BWIDth[:STATe]
Read Filter BandWidth	CALCulate:MEASure:MARKer:BWIDth:DATA?
Read Filter Center Freq	CALCulate:MEASure:MARKer:BWIDth:DATA?
Read Filter Loss	CALCulate:MEASure:MARKer:BWIDth:DATA?
Read Filter Q	CALCulate:MEASure:MARKer:BWIDth:DATA?
Set bandwidth marker function reference to either MARKer or PEAK	CALCulate:MEASure:MARKer:BWIDth:REF
Read notch search result	CALCulate:MEASure:MARKer:NOTCh:DATA?
Notch Search	CALCulate:MEASure:MARKer:NOTCh[:STATe]
Notch Ref To	CALCulate:MEASure:MARKer:NOTCh:REF
Notch Level	CALCulate:MEASure:MARKer:NOTCh:THReshold

Multi Peak & Target Marker Search	
Multi Peak Search	CALCulate:MEASure:MARKer:FUNcTion:MULTi:EXECute
Peak Threshold	CALCulate:MEASure:MARKer:FUNcTion:MULTi:PEAK:THReshold
Peak Excursion	CALCulate:MEASure:MARKer:FUNcTion:MULTi:PEAK:EXCursion
Peak Polarity	CALCulate:MEASure:MARKer:FUNcTion:MULTi:PEAK:POLarity
Multi Target Search	CALCulate:MEASure:MARKer:FUNcTion:MULTi:EXECute
Target Value	CALCulate:MEASure:MARKer:FUNcTion:MULTi:TARGet[:VALue]
Set or return search type of the multi search	CALCulate:MEASure:MARKer:FUNcTion:MULTi:SELEct

Turn ON OFF search tracking	CALCulate:MEASure:MARKer:FUNcTion:MULTi:TRACking
Transition	CALCulate:MEASure:MARKer:FUNcTion:MULTi:TARGet:TRANsition

Status Bar	
Status Bar On Off	DISPlay:ANNOtation[:STATus]
Toolbars/ Title Bars	
Toolbars On Off	DISPlay:TOOLbar:ENTRy DISPlay:TOOLbar:MARKer DISPlay:TOOLbar:KEYS[:STATe] DISPlay:TOOLbar:EXT[:STATe] DISPlay:TOOLbar:TRAN[:STATe]
Title Bars On Off	None
Tables	
Tables On Off	DISPlay:WINDow:TABLE
Data/Memory Trace	
Memory Trace On Off	DISPlay:WINDow:TRACe:MEMory

Marker (readout) Display	
Marker Readout On Off	DISPlay:WINDow:ANNOtation:MARKer[:STATe]
Marker Readout Size	DISPlay:WINDow:ANNOtation:MARKer:SIZE
Readouts Per Trace	DISPlay:WINDow:ANNOtation:MARKer:NUMBer
Stimulus decimal places	DISPlay:WINDow:ANNOtation:MARKer:RESolution:STIMulus
Response decimal places	DISPlay:WINDow:ANNOtation:MARKer:RESolution:RESPonse
Readout position: X-axis	DISPlay:WINDow:ANNOtation:MARKer:XPOSition

Readout position: Y-axis	DISPlay:WINDow:ANNotation:MARKer:YPOSition
Marker symbol	DISPlay:WINDow:ANNotation:MARKer:SYMBOL

XStimulusTopic

[Frequency](#) | [Offset](#) | [Power](#) | [Source Ports](#) | [# Points](#) | [Trigger :Ext](#) | [Auxiliary Trigger](#)
[Sweep settings:..Time](#) | [Setup](#) | [Segment](#) | [Power](#) | [DC Sources](#)

See [Remotely Specifying a Source Port](#) .

Description	SCPI
Frequency	
Start Freq	SENSe:FREQuency:START
Stop Freq	SENSe:FREQuency:STOP
Center Freq	SENSe:FREQuency:CENTer
Span	SENSe:FREQuency:SPAN
CW Frequency	SENSe:FREQuency:CW
Number of Points	SENSe:SWEEp:POINts
Step size	SENSe:SWEEp:STEP

Frequency Offset Commands	
Freq Offset ON/Off	SENSe:FOM[:STATe]
Read available ranges	SENSe:FOM:CATalog?
Read number of ranges	SENSe:FOM:COUNT?
X-Axis display range	SENSe:FOM:DISPlay:SElect
Read range name	SENSe:FOM:RANGe:NAME?
Read range number	SENSe:FOM:RNUM?
Set range coupling	SENSe:FOM:RANGe:COUPled
Set sweep type	SENSe:FOM:RANGe:SWEEp:TYPE
Set CW freq	SENSe:FOM:RANGe:FREQuency:CW
Set start freq	SENSe:FOM:RANGe:FREQuency:START

Set stop freq	SENSe:FOM:RANGe:FREQuency:STOP
Set offset value	SENSe:FOM:RANGe:FREQuency:OFFSet
Set divisor value	SENSe:FOM:RANGe:FREQuency:DIVisor
Set multiplier value	SENSe:FOM:RANGe:FREQuency:MULTiplier
Freq. Offset Segment Sweep	
ON OFF	SENSe:FOM:RANGe:SEGMENT
Add a segment	SENSe:FOM:RANGe:SEGMENT:ADD
Delete a segment	SENSe:FOM:RANGe:SEGMENT:DELEte
Count the segments	SENSe:FOM:RANGe:SEGMENT: COUNT?
Center Frequency	SENSe:FOM:RANGe:SEGMENT:FREQuency:CENTer
Frequency Span	SENSe:FOM:RANGe:SEGMENT:FREQuency:SPAN
Start Frequency	SENSe:FOM:RANGe:SEGMENT:FREQuency:START
Stop Frequency	SENSe:FOM:RANGe:SEGMENT:FREQuency:STOP
Number of Points	SENSe:FOM:RANGe:SEGMENT:SWEep:POINTs
IF Bandwidth value	SENSe:FOM:RANGe:SEGMENT:BWID
IF Bandwidth control	SENSe:FOM:RANGe:SEGMENT:BWID:CONTrol
Source Power value	SENSe:FOM:RANGe:SEGMENT:POWEr
Source Power control	SENSe:FOM:RANGe:SEGMENT:POWEr:CONTrol
Sweep time value	SENSe:FOM:RANGe:SEGMENT:SWEep:TIME
Sweep time control	SENSe:FOM:RANGe:SEGMENT:SWEep:TIME:CONTrol
Test Set Switch	ROUT:PATH:LOOP:R1

Power Settings See Remotely Specifying a Source Port .	
Power ON OFF	OUTP

Source Power (Auto ON OFF)	SOURce:POWer:MODE
Power Value	SOURce:POWer[:LEVel][:IMMediate][:AMPLitude]
Port Selection	SENSe:SWepE:SRCPort
Couple Ports OFF ON	SOURce:POWer:COUPLe
Attenuator Mode Auto Manual	SOURce:POWer:ATTenuation:Auto
Attenuation Value	SOURce:POWer:ATTenuation
Power Slope ON OFF	SOURce:POWer:SLOPe:STATe
Power Slope Value	SOURce:POWer:SLOPe
Receiver Reference Attenuation	SOURce:POWer:ATTenuation:RECEiver:REFerence
Receiver Test Attenuation	SOURce:POWer:ATTenuation:RECEiver:TEST
Shutdown or Restart System	SYSTem:POFF
See also Power Range remote commands	

Power Limit and Offsets	
Set power limit	SYSTem:POWer:LIMit
Power limit ON/OFF	SYSTem:POWer:LIMit:STATe
Power limit UI lock	SYSTem:POWer:LIMit:LOCK

Specifying Source Ports See Remotely Specifying a Source Port .	
Returns the number of source ports.	None
Returns the string names of source ports.	SOURce:CATalog?
Returns the source port number of the specified string port name.	None

IF Bandwidth	
IF Bandwidth	SENSe:BANDwidth BWIDth[:RESolution]
Previous IF Bandwidth	None
Next IFBandwidth	None
Reduce IF BW	SENSe:BANDwidth BWIDth:TRACk

Sweep	
Sweep Time Value	SENSe:SWEEp:TIME:AUTO
Number of Points	SENSe:SWEEp:POINts

Sweep Setup		
Sweep Type (Lin Pwr CW Seg Phase)	SENSe:SWEEp:TYPE	
Sweep Generation (Stepped Analog)	SENSe:SWEEp:GENeration	
Dwell Time Value	SENSe:SWEEp:DWEL	
Dwell Time Auto set the minimum dwell time	SENSe:SWEEp:DWEL:AUTO	
Sweep Delay	SENSe:SWEEp:DWELI:SDELay	

Alternate Sweeps	SENSe:COUPlE	
External ALC	SOURce:POWer:DETEctor	
Enable Point Sweep	SENSe:SWEEp:GENeration:POINtsweep	
Fast Sweep	SENSe:SWEEp:SPEEd	
Fast CW	SENSe:SWEEp:TYPE:FACW	
Set shift LO maximum frequency	SENSe:SWEEp:SLOCAl:MAXimum	
Turn shift LO on or off	SENSe:SWEEp:SLOCAl:STATe	
Returns whether or not the VNA has the low frequency extension (LFE) installed.	SYSTem:CAPability:HARDware:LFEXtension:EXISTS?	HasLowFrequencyExtension
Turns ON or OFF low frequency extension	SENSe:SWEEp:LFEXtension:STATe	LowFrequencyExtension
Power Sweep		
Start Power	SOURce:POWer:STARt	
Stop Power	SOURce:POWer:STOP	
Center	SOURce:POWer:CENTer	

Span	SOURce:POWer:SPAN	
Segment Sweep		
ON OFF	SENSe:SEGMent[:STATe]	
Add a segment	SENSe:SEGMent:ADD	
Delete a segment	SENSe:SEGMent:DELeTe	
Delete all segments	SENSe:SEGMent:DELeTe:ALL	
Count the segments	SENSe:SEGMent:COUNT	
Read the segment number	None	
Segment Center Frequency	SENSe:SEGMent:FREQuency:CENTer	
Segment Frequency Span	SENSe:SEGMent:FREQuency:SPAN	
Segment Start Frequency	SENSe:SEGMent:FREQuency:START	
Segment Stop Frequency	SENSe:SEGMent:FREQuency:STOP	
Number of Points	SENSe:SEGMent:SWEep:POINT	
IF Bandwidth	SENSe:SEGMent:BWIDth	

IF Bandwidth Option	SENSe:SEGMent:BWIDth:CONTRol	
IF Bandwidth Per Port	SENSe:SEGMent:BWIDth:PORT:CONTRol	
Sweep Delay Time	SENSe:SEGMent:SWEep:DELay	
Sweep Dwell	SENSe:SEGMent:SWEep:DWELl	
Sweep Mode	SENSe:SEGMent:SWEep:GENeration	
Total Sweep Points	SENSe:SEGMent:SWEep:POINts:TOTAL?	
Total Sweep Time	SENSe:SEGMent:SWEep:TIME:TOTAL?	
Source Power	SENSe:SEGMent:POWER	
Source Power Option	SENSe:SEGMent:POWER:CONTRol	
X-Axis Point Spacing	SENSe:SEGMent:X:SPACing	
Allow Arbitrary Segments	SENSe:SEGMent:ARBitrary	
Upload a segment table	SENSe:SEGMent:LIST	

Download a segment table	SENSe:SEGMent:LIST	
Sweep delay ON OFF	SENSe:SEGMent:SWEEp:DELay:CONTRol	
Sweep dwell ON OFF	SENSe:SEGMent:SWEEp:DWELI:CONTRol	
IF Bandwidth resolution	SENSe:SEGMent:BWIDth:PORT[:RESolution]	
Sets or returns the SA data threshold	SENSe:SEGMent:SA:DTHReshold	
Specifies whether SA Data Threshold can be set independently for each segment	SENSe:SEGMent:SA:DTHReshold:CONTRol	
Sets or returns the SA multitone reference	SENSe:SEGMent:SA:MTReference	
Specifies whether SA Reference Tone can be set independently for each segment	SENSe:SEGMent:SA:MTReference:CONTRol	

Queries the maximum value of the SA Reference Tone	<code>SENSe:SEGMent:SA:MTReference:MAX?</code>	
Queries the minimum value of the SA Reference Tone	<code>SENSe:SEGMent:SA:MTReference:MIN?</code>	
Sets or returns the SA vector average	<code>SENSe:SEGMent:SA:VAverage</code>	
Specifies whether SA Vector Averaging can be set independently for each segment	<code>SENSe:SEGMent:SA:VAverage:CONTRol</code>	
Sets or returns the SA video bandwidth	<code>SENSe:SEGMent:SA:VIDeobw</code>	
Specifies whether SA Video Bandwidth can be set independently for each segment	<code>SENSe:SEGMent:SA:VIDeobw:CONTRol</code>	

Trigger	
Source (where trigger comes from)	
Source (Int Ext Manual)	TRIGger[:SEQuence]:SOURce
Internal Manual	INITiate:CONTInuous
Trigger! (for Manual Source)	INITiate[:IMMediate]
Scope (what is triggered)	
Scope (Global Channel)	TRIGger[:SEQuence]:SCOPE
Channel Settings (how the channel responds to triggers)	
Continuous	SENSe:SWEEp:MODE CONTInous
Read Continuous Mode	None
Number of Groups	SENSe:SWEEp:GROup:COUNT
Read Groups	None
Hold	SENSe:SWEEp:MODE HOLD
Hold Mode (read-only)	None
All channels in Hold	SYSTem:CHANnels:HOLD
All channels Resume	SYSTem:CHANnels:RESume
Single	SENSe:SWEEp:MODE SINGLE
Trigger Mode (Channel Point Sweep)	SENSe:SWEEp:TRIGger:MODE
Restart	INITiate[:IMMediate]
Abort	ABORT

External Meas Trigger Input	
Scope (Global/Chan)	TRIGger[:SEQuence]:SCOPE

Trigger Delay (Global)	TRIGger:DELay
Trigger Delay (Channel)	SENSe:SWEep:TRIGger:DELay
MeasTrigIn/ Hand I/O	TRIGger:ROUTE:INPut
Level or Edge	TRIGger:TYPE
Neg/Low or Pos/High	TRIGger:SLOPE
Ready for Trigger Indicator (Out)	
MeasTrig Rdy/ Hand I/O	TRIGger:ROUTE:READY
Checks if the PNA is ready for a hardware trigger	TRIGger:STATus:READY?
High / Low	TRIGger:READY:POLarity

Auxiliary Triggering (PNA-X and N522x models)	
Which AuxTrig connector pair being used.	N/A
How many Aux connector pairs.	TRIGger:AUXiliary:COUNT?
AUX TRIG OUT	
Enable	TRIGger:CHANnel:AUXiliary
Global or Channel Pref.	TRIGger:PREFerence:AIGLobal
Polarity (Pos/Neg)	TRIGger:CHANnel:AUXiliary:OPOLarity
Position (Before/After acq)	TRIGger:CHANnel:AUXiliary:POSition
OUT Pulse width	TRIGger:CHANnel:AUXiliary:DURation
Point or Sweep.	TRIGger:CHANnel:AUXiliary:INTerval
AUX TRIG (Ready) IN	
Enable Handshake	TRIGger:CHANnel:AUXiliary:HANDshake
Edge or Level	TRIGger:CHANnel:AUXiliary:TYPE

Level NOT in UI.	
Polarity High/leading or Low/trailing.	TRIGger:CHANnel:AUXiliary:IPOLarity
Delay	TRIGger:CHANnel:AUXiliary:DELay

IF Path Configuration

DC Source Control See Ext DC Device commands	
Source names catalog	SOURce:DC:CATalog?
Enable source outputs	SOURce:DC:ENABle
Source state	SOURce:DC:STATe
Start DC	SOURce:DC:STARt
Stop DC	SOURce:DC:STOP
Data	SOURce:DC:DATA
Set and return the Max DC limit value for a DC source	SOURce:DC:LIMit:MAXimum
Set and return the Min DC limit value for a DC source	SOURce:DC:LIMit:MINimum



XTraceChanTopic

Trace | Channel | Display-Window Setup | Display-Sheet Setup | Display Setup | External Devices | External Sources | PMAR | External DC Source | External Pulse Generators | New Measurement | Delete Measurement | Manage Meas | Balanced Meas

Hardware: External Test Set

Description	SCPI
Trace	
New Trace	DISPlay:WINDow:TRACe[:STATe]
Select Trace	DISPlay:WINDow:TRACe:SElect
Measure	CALCulate:MEASure:PARAmeter
Trace Title	DISPlay:WINDow:TRACe:TITLe:DATA DISPlay:WINDow:TRACe:TITLe[:STATe]
Add Trace	DISPlay:WINDow:TRACe[:STATe]
Delete Trace	DISPlay:WINDow:TRACe:DELeTe
Move Trace	DISPlay:WINDow:TRACe:MOVE
Hold Trace	CALCulate:MEASure:HOLD:TYPE CALCulate:MEASure:HOLD:CLEAr
Set/get the number of traces of selected channel	CALCulate:PARAmeter:COUNt
Trace Maximize	DISPlay:TMAX

Channel	
Add	None
Make Active	None
Read Channel Number	SYSTem:ACTive:CHANnel?
Read UNUSED channel numbers	None
Read used channel numbers	None
Read number of Channels	None
Copy all Channel settings	SYSTem:MACRo:COPIY:CHANnel

Copy ONLY mechanical switches and attenuator settings.	SENSe:PATH:CONFig:COpy
Delete a channel	SYSTem:CHANnels:DELeTe
Set and return the group of channels	SYSTem:CHANnels:COUPlE:GROup
Set and return the Multi DUT parallel measurement state	SYSTem:CHANnels:COUPlE:PARAllel[:ENABle]
Get the information if the parallel measurement is executed in the last sweep	SYSTem:CHANnels:COUPlE:PARAllel:STATe?
Set up multiple channels for manual trigger	SYSTem:CHANnels:SINGle

Display - Window Setup	
Select Window	DISPlay:WINDow:TRACe:SElect
Window Title	DISPlay:WINDow:TITLe[:STATe]
Add Window	DISPlay:WINDow[:STATe]
Delete Window	DISPlay:WINDow[:STATe]
Move Window	DISPlay:WINDow:TRACe:MOVE
Window Layout	DISPlay:ARRange
Window Max	DISPlay:WINDow:SIZE
Return Window Number(s)	DISPlay:CATalog?
Read the window number of the selected trace	CALCulate:PARAmeter:WNUMber
Creates N windows	DISPlay:SPLit
Feed specified measurement to specified window	DISPlay:WINDow:TRACe:FEED:MNUMber
Returns the next unused trace number	DISPlay:WINDow:TRACe:NEXT[:NUMBer]
Set graph divisions	DISPlay:WINDow:Y[:SCALe]:DIVisions

Display - Sheet Setup	
Select Sheet	DISPlay:SHEet:STATe
Sheet Title	DISPlay:SHEet:TITle:DATA
Add Sheet	DISPlay:SHEet:STATe DISPlay:WINDow:FEED
Delete Sheet	DISPlay:SHEet:STATe
Sheet Layout	DISPlay:SHEet:ARRange
Get list of window numbers which the sheet contains	DISPlay:SHEet:CATalog?
Feed specified window to a sheet	DISPlay:WINDow:FEED
Return active sheet number	SYSTem:ACTive:SHEet
Return list of visible sheets	SYSTem:SHEets:CATalog?

Display Setup	
Trace Status	DISPlay:WINDow:ANNotation[:TRACe][:STATe]
Y-axis Labels	DISPlay:WINDow:ANNotation:Y[:STATe]
Show Marker Readout	DISPlay:WINDow:ANNotation:MARKer[:STATe]
Large Readout	DISPlay:WINDow:ANNotation:MARKer:SIZE
Readouts Per Trace	DISPlay:WINDow:ANNotation:MARKer:NUMBer
Sets the marker readouts to coupled (one combination annotation) or not coupled (one annotation per trace).	DISPlay:WINDow:ANNotation:MARKer:COUPle
Shows the marker readouts only for active trace or for all traces.	DISPlay:WINDow:ANNotation:MARKer:VISible

Symbol - Triangle, Flag, and Line	DISPlay:WINDow:ANNotation:MARKer:SYMBOL
Decimal Places - Stimulus and Response	DISPlay:WINDow:ANNotation:MARKer:RESolution:STIMulus DISPlay:WINDow:ANNotation:MARKer:RESolution:RESPonse
Readout Position - X and Y	DISPlay:WINDow:ANNotation:MARKer:XPOSITION DISPlay:WINDow:ANNotation:MARKer:YPOSITION
Marker Colors	DISPlay:COLor:TRACe:MARKer
N Trace: Markers	DISPlay:COLor:TRACe:MARKer
N Trace: Memory Markers	DISPlay:COLor:TRACe:MMARKer
Reset Color	DISPlay:COLor:RESet
Save Theme	DISPlay:COLor:STORe
Recall Theme	DISPlay:COLor:LOAD
Reset Theme	DISPlay:COLor:RESet
Grid Lines - Solid Dotted	DISPlay:WINDow:TRACe:GRATicule:GRID:LTYPE
Y-axis Divisions - 2 to 30	DISPlay:WINDow:TRACe:Y[:SCALe]:PDIVision
Show Table - None, Marker, Limit, Ripple, and Segment	DISPlay:WINDow:TABLE
Toolbar Softkey	DISPlay:TOOLbar:KEYS[:STATe]
Toolbar Hardkey	DISPlay:TOOLbar:KEYS[:STATe]
Toolbar Port Extensions	DISPlay:TOOLbar:EXTensions[:STATe]
Toolbar Transform	DISPlay:TOOLbar:TRANSform[:STATe]
Toolbar Marker	DISPlay:TOOLbar:MARKer[:STATe]
Toolbar Cal Set Viewer	DISPlay:TOOLbar:CSET[:STATe]
Active Entry Toolbar	DISPlay:TOOLbar:ENTry[:STATe]
Toolbar Status Bar	DISPlay:ANNotation[:STATus]

Status Bar	DISPlay:ANNotation[:STATus]
Status Bar Clock	SYSTem:CLOCK[:STATe]
Default Colors	DISPlay:COLor:RESet
Background Colors	DISPlay:COLor:BACKground
Active Background Color	DISPlay:COLor:ABACKground
Grid Colors	DISPlay:COLor:GRAT2
Active Labels, Grid Frame Colors	DISPlay:COLor:GRAT1
Inactive Window Labels Colors	DISPlay:COLor:ILABel
Failed Trace Colors	DISPlay:COLor:LIM1
N Trace: Data and Limits Colors	DISPlay:COLor:TRACe:DATA
N Trace: Memory	DISPlay:COLor:TRACe:MEMory
Display Update	DISPlay:UPDate[:STATe] DISPlay:UPDate:IMMEDIATE

Configure External Devices	
Adds an external device to the system.	SYSTem:CONFigure:EDEVice:ADD
Returns names of all configured devices	SYSTem:CONFigure:EDEV:iceCAT?
Set driver for the external device.	SYSTem:CONFigure:EDEVice:DRIVer
Set type of device.	SYSTem:CONFigure:EDEVice:DTYPe
Configuration path for external device.	SYSTem:CONFigure:EDEVice:IOConfig
Enable or disable communication with device.	SYSTem:CONFigure:EDEVice:IOENable
Sets and returns the name of the External Device.	None
Activation state of the device.	SYSTem:CONFigure:EDEVice:STATe

Time out value for external device.	SYSTem:CONFIgure:EDEVice:TOUT
Remove a device	SYSTem:CONFIgure:EDEVice:REMOve
Save configuration file	SYSTem:CONFIgure:EDEVice:SAVE
Load configuration file	SYSTem:CONFIgure:EDEVice:LOAD
Returns if specified device responds	SYSTem:CONFIgure:EDEVice:EXISts?

External Source Config	
Set Dwell per Point	SYSTem:CONFIgure:EDEVice:SOURce:DPP
Set Trigger Mode	SYSTem:CONFIgure:EDEVice:SOURce:TMODe
Set Trigger Port	SYSTem:CONFIgure:EDEVice:SOURce:TPOrt
Set Modulation Control	SYSTem:CONFIgure:EDEVice:SOURce:MODulation:CONTRol

Source Modulation		
Sets and reads the frequency of the arbitrary waveform generator.	SOURce:MODulation:ARB:CLOCK:SRATe	None
Sets and reads the I data for I/Q modulation.	SOURce:MODulation:ARB:DATA:I	None
Sets and reads the Q data for I/Q modulation.	SOURce:MODulation:ARB:DATA:Q	None
Set and read the modulation state.	SOURce:MODulation[:STATe]	None
Checks if pulse source exists.	SOURce:PULSe:EXISts?	None
Turns pulse modulation on	SOURce:PULSe:MODulation[:STATe]	None

and off with an external source.		
Sets and reads the maximum number of iterations for an ACP modulation calibration.	SOURce:MODulation:CORRection:COLLection:ACP:ITERations	None
Sets and reads the calibration plane for an ACP modulation calibration.	SOURce:MODulation:CORRection:COLLection:ACP:RECeiver	None
Set and read the ACP modulation calibration state.	SOURce:MODulation:CORRection:COLLection:ACP:ENABLE	None
Sets and reads the desired ACP calibration tolerance for the ACP modulation calibration.	SOURce:MODulation:CORRection:COLLection:ACP:TOLerance	None
Sets the Notch location.	SOURce:MODulation:CORRection:COLLection:ACQuire	None
Returns a message indicating if the calibration was successful or not.	SOURce:MODulation:CORRection:COLLection:ACQuire:STATus?	None
Sets and reads the maximum number of iterations for a flatness modulation calibration.	SOURce:MODulation:CORRection:COLLection:FLATness:ITERations	None
Sets and reads the calibration plane for flatness	SOURce:MODulation:CORRection:COLLection:FLATness:RECeiver	None

modulation calibration.		
Set and read the flatness modulation calibration state.	SOURce:MODulation:CORRection:COLLection:FLATness:ENABle	None
Sets and reads the desired flatness calibration tolerance for the flatness modulation calibration.	SOURce:MODulation:CORRection:COLLection:FLATness:TOLerance	None
Sets and reads the maximum number of iterations to provide the deepest notch.	SOURce:MODulation:CORRection:COLLection:NOTch:ITERations	None
Sets and reads the calibration plane for an notch modulation calibration.	SOURce:MODulation:CORRection:COLLection:NOTch:RECeiver	None
Set and read the notch modulation calibration state.	SOURce:MODulation:CORRection:COLLection:NOTch:ENABle	None
Sets and reads the desired notch calibration tolerance for the notch modulation calibration.	SOURce:MODulation:CORRection:COLLection:NOTch:TOLerance	None
Sets and reads the maximum number of iterations for a power modulation calibration.	SOURce:MODulation:CORRection:COLLection:POWer:ITERations	None
Sets and reads the calibration plane	SOURce:MODulation:CORRection:COLLection:POWer:RECeiver	None

for a power modulation calibration.		
Set and read the power modulation calibration state.	SOURce:MODulation:CORRection:COLLection:POWer:ENABle	None
Sets and reads the desired power calibration tolerance for the power modulation calibration.	SOURce:MODulation:CORRection:COLLection:POWer:TOLerance	None
Set and read the modulation correction state.	SOURce:MODulation:CORRection[:STATe]	None
Returns a list of modulation files (*.mdx).	SOURce:MODulation:FILE	None
Loads the specified modulation file.	SOURce:MODulation:LOAD	None
Saves the specified modulation file.	SOURce:MODulation:SAVE	None
Enables fast calibration.	SOURce:MODulation:CORRection:COLLection:FAST:ENABle	None

Power Meter As Receiver (PMAR) Config	
See commands to configure and specify a Non- PMAR Power Sensor	
Enable use of internal cal factors	SYSTem:CONFigure:EDEVice:PMAR:CFActors[:STATe]
Enable min and max freqs	SYSTem:CONFigure:EDEVice:PMAR:FLIMit
Set Max freq	SYSTem:CONFigure:EDEVice:PMAR:FMAximum

Set Min freq	SYSTem:CONFigure:EDEVice:PMAR:FMINimum
Set max number of PM readings	SYSTem:CONFigure:EDEVice:PMAR:READING:COUNT
Set tolerance level	SYSTem:CONFigure:EDEVice:PMAR:READING:NTOLerance
Select sensor	SYSTem:CONFigure:EDEVice:PMAR:SENSor
Set Cal Factor data	SYSTem:CONFigure:EDEVice:PMAR:TABLE:CFAC:DATA
Set Cal Factor frequencies	SYSTem:CONFigure:EDEVice:PMAR:TABLE:CFAC:FREQuency
Set Power loss data	SYSTem:CONFigure:EDEVice:PMAR:TABLE:LOSS:DATA
Set Power loss frequencies	SYSTem:CONFigure:EDEVice:PMAR:TABLE:LOSS:FREQuency
Enable Power loss data	SYSTem:CONFigure:EDEVice:PMAR:TABLE:LOSS:STATe
Set reference cal factor	SYSTem:CONFigure:EDEVice:PMAR:TABLE:RFACtor
Set Zero method	SYSTem:CONFigure:EDEVice:PMAR:ZERO
Perform Cal	SYSTem:CONFigure:EDEVice:PMAR:CALibrate
Returns a list of available power meters that have power uncertainty.	SYSTem:CONFigure:EDEVice:PMAR:UNCertainty:CATalog?
Sets and returns a custom model uncertainty file containing all of the power meter uncertainty properties.	SYSTem:CONFigure:EDEVice:PMAR:UNCertainty:FILE
Returns a list of available power meters that have power uncertainty.	SYSTem:CONFigure:EDEVice:PMAR:UNCertainty:MODEL
Returns the power level for best accuracy.	SYSTem:CONFigure:EDEVice:PMAR:UNCertainty:PLEVel?
Returns the power meter reading uncertainty.	SYSTem:CONFigure:EDEVice:PMAR:UNCertainty:READ?

External DC Source/Meter See DC Source sweep commands		
Correction ON/OFF	SYSTem:CONFigure:EDEVice:DC:CORRection	
Offset correction value.	SYSTem:CONFigure:EDEVice:DC:OFFSet	
Scale correction value.	SYSTem:CONFigure:EDEVice:DC:SCALe	
DC Type (Units).	SYSTem:CONFigure:EDEVice:DC:TYPE	
Dwell Before/After Point	SYSTem:CONFigure:EDEVice:DC:DPOint	
Dwell Before Sweep value	SYSTem:CONFigure:EDEVice:DC:DSWeep	
Set and return the maximum output current value of the external DC Source	SYSTem:CONFigure:EDEVice:DC:LIMit:CURRent	
Set and return the maximum output voltage value of the external DC Source	SYSTem:CONFigure:EDEVice:DC:LIMit:VOLTage	
Set and return the DC Meter/DC Source Abort Sweep command	SYSTem:CONFigure:EDEVice:DC:COMMand:SWEEp:ABORt	AbortSweepCmd
Set and return the DC Meter/DC Source After Sweep command	SYSTem:CONFigure:EDEVice:DC:COMMand:SWEEp:AFTer	AfterSweepCmd

Set and return the DC Meter/DC Source Before Sweep command	<code>SYSTem:CONFigure:EDEVice:DC:COMMand:SWEep:BEF ore</code>	BeforeSweepCmd
Set and return the DC Meter/DC Source Error Query command	<code>SYSTem:CONFigure:EDEVice:DC:QUERy:ERRor</code>	ErrorQuery
Set and return the DC Meter/DC Source Disable I/O command	<code>SYSTem:CONFigure:EDEVice:DC:COMMand:EXIT</code>	ExitCmd
Set and return the DC Meter/DC Source ID Query command	<code>SYSTem:CONFigure:EDEVice:DC:QUERy:ID</code>	IDQuery
Set and return the DC Meter/DC Source Enable I/O command	<code>SYSTem:CONFigure:EDEVice:DC:COMMand:INIT</code>	InitCmd
Set and return the DC Source maximum output	<code>SYSTem:CONFigure:EDEVice:DC:MAX:VALue</code>	MaxOutput
Set and return the DC Source maximum output state	<code>SYSTem:CONFigure:EDEVice:DC:MAX[:STATe]</code>	MaxOutputState
Set and return the DC Source minimum output	<code>SYSTem:CONFigure:EDEVice:DC:MIN:VALue</code>	MinOutput
Set and return the DC Source minimum output state	<code>SYSTem:CONFigure:EDEVice:DC:MIN[:STATe]</code>	MinOutputState
Set and return the Point Read	<code>SYSTem:CONFigure:EDEVice:DC:COMMand:POINt:SET</code>	PointCmd

commands and Point Set commands		
---------------------------------	--	--

External Pulse Generators	
PG Names catalog	SENSe:PULSe:CATalog?
Read the integer of the name	Not applicable
Set output channel	SYSTem:CONFigure:EDEVice:PULSe:CHAN
Set output Hi amplitude (volts)	SYSTem:CONFigure:EDEVice:PULSe:HAMP
Set output Low amplitude (volts)	SYSTem:CONFigure:EDEVice:PULSe:LAMP
Set load impedance	SYSTem:CONFigure:EDEVice:PULSe:LIMP
Set source impedance	SYSTem:CONFigure:EDEVice:PULSe:SIMP
Master Mode	SYSTem:CONFigure:EDEVice:PULSe:MMODE
Optional Name/ID argument added to some Pulse gen commands.	SENSe:PULSe

New Measurement	
Create S-Parameter Meas.	CALCulate:MEASure::DEFine
Create Measurement	CALCulate:MEASure::DEFine
Add Measurement	None
List Measurements	CALCulate:PARAmeter:CATalog:EXTended
Delete Measurement	
Delete a measurement	CALCulate:MEASure::DELeTe
Delete ALL measurements	CALCulate:MEASure::DELeTe:ALL
Manage Measurements	
Get a handle to a Trace	None

Select a Measurement Parameter	CALCulate:PARAmeter:SElect
Read Channel Number	SYSTem:ACTive:CHANnel?
Read Channel Numbers in use	SYSTem:CHANnels:CATalog?
Read Number of Measurements	None
Read Measurement Parameter	None
Set / Read Measurement Name	SYSTem:ACTive:MEASurement (read-only)
Read Active Measurement Number	SYSTem:ACTive:MEASurement:NUMBer?
Change Parameter	CALCulate:MEASure:PARAmeter
Returns the Measurement Class name	SENSe:CLASs:NAME?
Read the window number of the selected trace	CALCulate:PARAmeter:WNUMber
Read the trace number of the selected trace	CALCulate:PARAmeter:TNUMber?
Maximize (Isolate) trace	DISPlay:TMAX
Move a trace to another window	DISPlay:WINDow:TRACe:MOVE
Trace Hold	CALCulate:MEASure:HOLD:TYPE
Trace Hold Clear	CALCulate:MEASure:HOLD:CLEAr
Deletes the trace associated with the specified measurement number	DISPlay:MEASure:DELEte
Create a new trace in the specified window	DISPlay:MEASure:FEED
Turn the memory trace ON or OFF for the specified measurement	DISPlay:MEASure:MEMory[:STATe]
Move a trace associated with measurement number to the specified window	DISPlay:MEASure:MOVE

Activate the specified measurement to be selected	DISPlay:MEASure:SElect
Turn trace display associated with the specified measurement ON or OFF	DISPlay:MEASure[:STATe]
Set or return the title for the specified measurement	DISPlay:MEASure:TITLe:DATA
Turn the measurement title ON or OFF	DISPlay:MEASure:TITLe[:STATe]
Autoscale the specified trace in the specified measurement	DISPlay:MEASure:Y[:SCALe]:AUTO
Set the Y axis Scale Per Division value of the specified trace associated with the specified measurement	DISPlay:MEASure:Y[:SCALe]:PDIVision
Set the Y axis Reference Level of the specified trace associated with the specified measurement	DISPlay:MEASure:Y[:SCALe]:RLEVel
Set the Reference Position of the specified trace associated with the specified measurement	DISPlay:MEASure:Y[:SCALe]:RPOSITion
All Measurement Classes / Applications	

Balanced Measurements and Fixturing	
Configure Topology	CALCulate:FSIMulator:BALun
Configure Balanced Measurement	CALCulate:FSIMulator:BALun
Maps the physical VNA ports to a device of balanced and single-ended logical ports for multi-port systems with greater than 4 ports	CALCulate:DTOPology

External Testset Control (also for E5092A)	
Returns a list of currently supported test sets.	SENSe:MuLTiPlexer:CATalog?
Load config file and Restart VNA .	SYSTem:CONFigure
Loads a test set configuration file. (and SCPI only - sets ID value).	SENSe:MuLTiPlexer:TYPE
Returns the test set model	SENSe:MuLTiPlexer:TYPE
Returns the test set ID number.	None
Returns the number of input ports	SENSe:MuLTiPlexer:INCount?
Switches an input to one of the valid outputs (E5091A only).	None
Returns the total number of ports on the test set.	SENSe:MuLTiPlexer:COUNT?
Sets and returns the address for the external test set at the specified ID.	SENSe:MuLTiPlexer:ADDRess
Turns ON/OFF the port mapping and control line output.	SENSe:MuLTiPlexer:STATe
Sets and returns the port mappings for ALL ports.	SENSe:MuLTiPlexer:ALLPorts
Sets and returns the mapping for a single port.	SENSe:MuLTiPlexer:PORT:SELEct
Returns the label on a given channel.	SENSe:MuLTiPlexer:LABel

Turns ON/OFF status bar display of test set properties.	SENSe:MUlTIpLexer:DISPlay
Sets the control lines.	SENSe:MUlTIpLexer:OUTPut
Returns the selections available for a given logical port.	SENSe:MUlTIpLexer:PORT:CATalog?
Reads a Cal Set for the Test Set model.	SENSe:CORRection:CSET:TSET:ALLPorts?
Reads a Cal Set for the Port Mapping.	SENSe:CORRection:CSET:TSET:TYPE?
All Sense Multiplexer commands	SENSe:MUlTIpLexer
All Control Multiplexer commands (E5092A only)	CONTRol:MUlTIpLexer

XUtilityTopic

[Save /Recall](#) | [Manage Files](#) | [Manage Folders](#) | [Print](#) | [Read Clock](#)

[Preset \(User\)](#) | [Security](#) | [Configure](#)

[Hdwr & Capabilities](#) | [Macros](#) | [Status](#) | [GPIB Pass-through](#) | [VISA Pass-through](#) | [Preferences](#)

[LXI](#) | [Error Messages](#) | [mmWave](#)

Preset / User	SCPI
Preset	SYSTem:PRESet *RST
Preset plus delete window	SYSTem:FPReset

Security	
Frequency Blanking	SYSTem:SECurity[:LEVel]

Configure	
Local Lockout	Local Lockout
Set and return GPIB address	None
Set VNA to GPIB system controller or talker/listener	None
Set and return SICL address	None
Control the VNA via SICL	None
Return Full computer name	None
System Impedance	SENSe:CORRection:IMPedance:INPut:MAGNitude
Load Test Set Config file and Restart VNA.	SYSTem:CONFigure
Hardware	Instrument Menu
IO Configuration	None

Modify the manufacturer name	SYSTem:PERSonA:MANufacturer
Reset to original manufacturer identification	SYSTem:PERSonA:MANufacturer:DEFault
Modify the product model	SYSTem:PERSonA:MODEl
Reset to original product model name	SYSTem:PERSonA:MODEl:DEFault
Set and return Source Port Control	SYSTem:ISPControl[:STATe]

Hardware and Capabilities	
DSP Revision	SYSTem:CONFIgure:REVIion:DSP?
DSP FPGA	SYSTem:CONFIgure:REVIion:DSPFpga?
CPU Speed	SYSTem:CONFIgure:REVIion:CPU?
Hostname	SYSTem:COMMunicate:LAN:HOSTname?
Disk Drive Version	SYSTem:DISK:REVIion?
Set and return the coupler state	SYSTem:FCORrection:CHANnel:COUPler[:STATe]
Returns the word size (32 or 64).	SYSTem:CONFIgure:BIT?
Many queries regarding the capability of a specific VNA	SYSTem:CAPability

Macros	
Execute Macro	SYSTem:SHORtcut:EXECute
Delete Macro	SYSTem:SHORtcut:DELeTe
Write macro path, argument, and title	SYSTem:SHORtcut:PATH SYSTem:SHORtcut:ARGuments
Read macro path, argument, and title	SYSTem:SHORtcut:TITLe

Status Commands

Status Registers

GP-IB/Status Registers

*OPC;*WAI

GP-IB/Common_Commands

GP-IB Pass Through

Open a GPIB pass-through session	SYSTem:COMMunicate:GPIB:RDEvice:OPEN	None
Write string data to the GPIB pass-through device.	SYSTem:COMMunicate:GPIB:RDEvice:WRITe	None
Write data to the GPIB pass-through device - with header.	SYSTem:COMMunicate:GPIB:RDEvice:WBLOCK	None
Write data to the GPIB pass-through device - without header.	SYSTem:COMMunicate:GPIB:RDEvice:WBINary	None
Reads string data from the GPIB pass-through device.	SYSTem:COMMunicate:GPIB:RDEvice:READ?	None
Closes a GPIB pass-through session	SYSTem:COMMunicate:GPIB:RDEvice:CLOSE	None

Closes ALL GPIB pass-through sessions	<code>SYSTem:COMMunicate:GPIB:RDEvice:RESet</code>	None
---------------------------------------	--	------

VISA Pass Through	
Returns list of visa address strings or aliases.	<code>SYSTem:COMMunicate:VISA:RDEvice:FIND?</code>
Sets timeout value for VISA pass-through commands.	<code>SYSTem:COMMunicate:VISA:RDEvice:TIMEout</code>

Preferences	
Reset Preference default settings	<code>SYSTem:PREFerences:DEFine</code>
Touchscreen ON Off	<code>SYSTem:TOUCHscreen[:STATe]</code>
Selected trace is wider	None
Selected trace changes width briefly	None
Cal: Auto-save User Cal Set	<code>SENSe:CORRection:PREFerence:CSET:SAVE</code>
Cal: For Guided Cal, set external trigger	<code>SENSe:CORRection:PREFerence:TRIG:FREE</code>
Cal: For Unguided Cal, set external trigger	<code>SENSe:CORRection:PREFerence:TRIG:FREE</code>
Cal: Simulated Cal Behavior	<code>SENSe:CORRection:PREFerence:SIMCal</code>
Cal: Use Primary FOM (for mmWave)	<code>SENSe:CORRection:PREFerence:CALibration[:FOM]:RANGE</code>
Memory: Data Math 8510 Mode	None
Power: RF power On during frequency sweep retrace	<code>SYSTem:PREFerences:ITEM:RETRace:POWer</code>
Power: Power Sweep Retrace	<code>SYSTem:PREFerences:ITEM:PSRTTrace</code>
Trigger: External Trigger OUT is Global	<code>TRIGger:PREFerences:AIGLobal</code>
Meas: Port 1 Noise Tuner Switch state	<code>SYSTem:PREFerences:ITEM:SWITCh:DEF</code>
Meas: Mathematical offset for receiver attenuation	<code>SYSTem:PREFerences:ITEM:OFFSet:RCV</code>

Meas: Mathematical offset for source attenuation	SYSTem:PREFerences:ITEM:OFFSet:SRC
Limit: Draw failed trace segments in red	SYSTem:PREFerences:ITEM:RTOF
Limit: Draw limit lines in red	SYSTem:PREFerences:ITEM:REDLimits
Marker: Programming treats Mkr 10 as Reference	SYSTem:PREFerences:ITEM:REFMarker
Marker: On Preset, Coupled Markers is ON	SYSTem:PREFerences:ITEM:MCPreset
Marker: On Preset, Coupling Method is Channel	SYSTem:PREFerences:ITEM:MCMMethod
Marker: Coupling controls on off state of markers.	SYSTem:PREFerences:ITEM:MCControl
Marker: Use single marker for marker search	SYSTem:PREFerences:ITEM:MARKer:SINGLE
Marker: Sets the bandwidth search preference	SYSTem:PREFerences:ITEM:MARKer:BANDwidth:SEARch
Ext Device: de-activate on PRESET and recall.	SYSTem:PREFerences:ITEM:EDEV:DPOLicy
Avg: On PRESET set two-point group delay aperture	SYSTem:PREFerences:ITEM:GDELay:TWOPoint
Power: On PRESET always turn power ON	SYSTem:PREFerences:ITEM:PRESet:POWER
Power: Report source unlevelled events as errors	SYSTem:ERRor:REPort:SUNLeveled
Power: Turn source power OFF when receiver is overloaded	SYSTem:PREFerences:ITEM:RECEivers:OVERload:POWER
Power: Report when receiver is overloaded	SYSTem:PREFerences:ITEM:RECEivers:CERRor
Preset: Confirm preset	SYSTem:PREFerences:ITEM:PRESet:CONFirm
Preset: On PRESET show Quick Start dialog	SYSTem:PREFerences:ITEM:QStart
Controls the on/off state of the preference, "Use keyboard to navigate softkeys"	SYSTem:PREFerences:ITEM:SOFTkeys:NAVigation
System: Enable Sound	SYSTem:BEEPPer:STATe

System: Set limit test warning sound	SYSTem:BEEPer:WARNIng:IMMediate
System: Set sound after operation completion	SYSTem:BEEPer:COMPIete:IMMediate
System: On Power-on show Keys toolbar	SYSTem:PREFErences:ITEM:Keys
Sweep: Use only ramp sweeps for Auto Sweep Mode	SYSTem:PREFErences:ITEM:ASMRamp
More buttons	
Define Data Saves	See File Menu
User Preset	See Preset
Printer Page Setup	Hardcopy
Power Limit	See Power Limits
Display and Print Colors	See Display

LXI	
Returns Structured status of the VNA networking configuration.	None
Returns string status of the VNA networking configuration.	None
Resets the VNA LAN configuration.	None
Modifies settings of the VNA computer networking configuration.	None
Displays the LAN Status dialog with LAN Status Indicator showing IDENTIFY.	LXI:IDEN

Error Messages	
Enable the display of Error Messages	DISPlay:ANNotation:MESSAge:STATe
Timed vs Dialog messages	None

Millimeter-Wave Commands

Millimeter Configuration

Select Configuration

Standard PNA
VDI WR-12

New Remove

Properties

Name VDI WR-12

Max Power limit at Module RF IN

RF IN cable: Offset 0.00 dB

Enable Installation Cal - Not Avail

Frequencies

	Start	Stop
Module RF IN	10.0000000000 GHz	15.0000000000 GHz
Module LO IN	10.0000000000 GHz	15.0000000000 GHz
Module Test Port	60.000000000 GHz	90.000000000 GHz

OK

SYSTem:CONFIgure:MWAVE:CONF:ACTive

SYSTem:CONFIgure:MWAVE:CONF:ADD

SYSTem:CONFIgure:MWAVE:CONF:CATalog?

SYSTem:CONFIgure:MWAVE:CONF:REMOve

SYSTem:CONFIgure:MWAVE:FREQ uency:LO:MULTiplier

SYSTem:CONFIgure:MWAVE:FREQ uency:LO:STARt?

SYSTem:CONFIgure:MWAVE:FREQ uency:LO:STOP?

SYSTem:CONFIgure:MWAVE:FREQ uency:RF:MULTiplier

SYSTem:CONFIgure:MWAVE:FREQ uency:RF:STARt?

SYSTem:CONFIgure:MWAVE:FREQ uency:RF:STOP?

SYSTem:CONFIgure:MWAVE:FREQ uency:STARt

SYSTem:CONFIgure:MWAVE:FREQ uency:STOP

SYSTem:CONFIgure:MWAVE:TSET: POWER:LIMit

SYSTem:CONFIgure:MWAVE:TSET: POWER:OFFSet

SYSTem:CONFIgure:MWAVE:TSET: POWER:SLOPe

Your Programs on Windows

Programs that run on Workstations

If your program is running on a separate workstation and talking to the VNA using SCPI or DCOM, you may encounter problems when your program saves data to the root directory of the VNA HDD. This is because of User Account Control (UAC), a new security model with Windows 7 or Windows 10.

In the UAC default security setting, programs will not be able to save files to the root folder of the VNA. Try changing the UAC setting to the lowest security level. If it runs, but it is not acceptable to rewrite the program, then leave the UAC in this setting. The VNA software runs with UAC on either of these settings.

To access UAC settings for Windows 7:

- Minimize the VNA application
- Click the Windows Start button
- In Search Programs and Files, type UAC

Default setting



Default - Notify me only when programs try to make changes to my computer

- Don't notify me when I make changes to Windows settings

i Recommended if you use familiar programs and visit familiar websites.

Lowest security setting



Never notify me when:

- Programs try to install software or make changes to my computer
- I make changes to Windows settings

i Not recommended. Choose this only if you need to use programs that are not certified for Windows 7 because they do not support User Account Control.

To access UAC settings for Windows 10:

Minimize the VNA application

Click the Type here to search icon

In the Type here to search text field, type UAC

Default
setting



Default - Notify me only when programs try to make changes to my computer

- Don't notify me when I make changes to Windows settings

 Recommended if you use familiar programs and visit familiar websites.

Lowest
security
setting



Never notify me when:

- Programs try to install software or make changes to my computer
- I make changes to Windows settings

 Not recommended. Choose this only if you need to use programs that are not certified for Windows 7 because they do not support User Account Control.

Programs that run on the VNA

The following issues relate to problems that may occur when you install and run your programs on the VNA. Most programs that run in Windows XP will run without changes on Windows 7 or Windows 10. However, there are differences between the two operating systems that could break more complicated programs. These incompatibilities are the same issues that software developers deal with on personal computers.

32-bit Programs

If your 32-bit program is saving files, Windows will redirect memory access to correct for different file locations. If problems occur, the path locations may need to be modified. [See new path locations.](#)

16-bit Programs

On Windows XP, there was a compatibility layer for 16-bit programs. This compatibility layer has been removed. So, your very old 16-bit programs will no longer be able to run on the VNA.

Special note about .NET applications with 64-bit Windows

In Visual Studio 2008 and earlier, the default .NET platform target was AnyCPU. On Windows 7 or Windows 10 64-bit, .NET applications that are written against the "AnyCPU" platform will compile down to a native 64-bit application. This can cause odd failures in your code as you will not be able to load any 3rd party libraries that are 32-bit only. You should always be compiling .NET applications as the "x86" platform. Starting with Visual Studio 2010, the default platform was changed to x86.

Quick Start Guide

The following topics can help you become familiar with your analyzer:

Programming the M937xA/P937xA

SFP Launcher

Configuration Wizard (M9485A)

Front Panel Tour

M937xA Front Panel

P937xA Front Panel

Quick Start Measurements

Rear Panel Tour

P937xA Rear Panel

Front-panel Interface

Traces, Channels, and Windows

Basic Measurement Sequence

Preferences

Using Help

Setup Guide

Set up your measurement using the following information:

Basic Settings

- Preset the Analyzer
- Select a Measurement Parameter
- Set Frequency Range
- Set Power Level
- Set Sweep Type
- Set Number of Points
- Set Triggering
- Set Data Format
- Set Scale
- Pre-configured Measurement Setups
- Customize the Screen
- Undo/Redo Settings

Advanced Settings

- Copy Channels

Caution: Avoid expensive repairs to your analyzer. Read [Electrostatic Discharge Protection](#).

Calibration

Cal Basics

- [Calibration Wizard](#)
- [Select a Calibration](#)
- [Using Cal Sets](#)
- [Calibration Preferences](#)

To learn about calibrating Application channels, refer to the help topic for the [Application](#).

Cal Types

- [Using ECal](#)
- [Perform a 4-Port Cal with a 2-Port ECal Module](#)
- [TRL Cal](#)
- [Calibrate All Channels](#)

Cal Concepts

- [Calibration Overview](#)
- [About Calibration Standards](#)
- [Error Correction and Interpolation](#)
- [Calibration Thru Methods](#)
- [Accurate Calibrations](#)
- [Validity of a Calibration](#)

Advanced Cal Topics

- [ECal User Characterization](#)
- [Port Extensions](#)
- [Fixture Simulator](#)
- [Swap Adapters Method](#)
- [Measurement Errors](#)
- [Modify Cal Kits](#)

Caution: Avoid expensive repairs to your analyzer. Read [Electrostatic Discharge Protection](#).

Power Cal for Apps

This dialog appears when the **Source Cal Settings** button is clicked from Swept IMD and GCA calibrations.

Source Calibration Settings - dialog box help

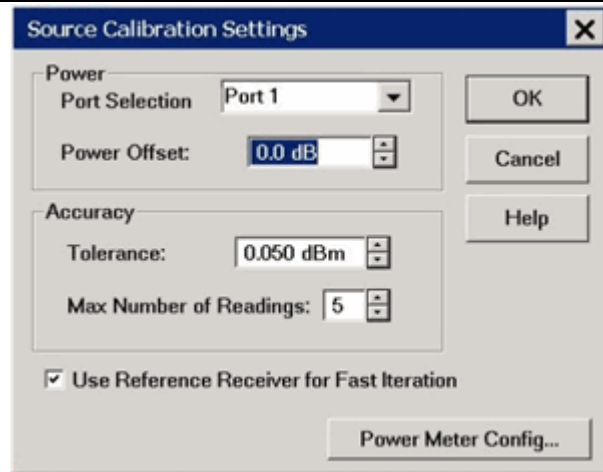

Note: Be sure that the frequency range of your power sensor covers the frequency range of your measurement. This does NOT occur automatically.

See Important First-time USB connection note.

Power

Port Selection Select the port for which the Source Cal settings will apply.

Power Offset Allows you to specify a gain or loss (in dB) to account for components you connect between the source and the reference plane of your measurement. For example, specify 10 dB to account for a 10 dB amplifier in the path to your DUT. Following the calibration, the VNA power readouts are adjusted to this value.

Power Level of the calibration is set within the Application. This can be from the Cal Wizard page, or from the power level setting of the source or port.

Accuracy

At each data point, power is measured using the specified Power Meter Settling Tolerance and adjusted, until the reading is within this Accuracy Tolerance or the Max Number of Readings has been met. The last power reading is plotted on the screen against the Tolerance limit lines.

Tolerance Sets the maximum desired deviation from the specified Cal Power level.

Max Number of Readings Sets the maximum number of readings to take at each data point for iterating the source power.

Use Reference Receiver for Fast Iteration When checked, the first reading at each data point uses a power meter to calibrate the reference receiver. Subsequent readings, if necessary to meet your accuracy requirement, are measured using the reference receiver. This technique is much faster than using the power meter with almost no degradation in accuracy.

Note: Do NOT use the **Reference Receiver for Fast Iteration** feature if there is a component before the power sensor that exhibits non-linear behavior, such as a power amplifier in compression

Power Meter Config Invokes the **Power Meter Settings** dialog box. From this dialog, you can configure two power sensors to cover the frequency range of interest.

Learn more about standard **Source Power Cal.**

Analyze Data Guide

Markers

Math / Memory Operations

Equation Editor

Import Functions

Limit Lines

Caution: Avoid expensive repairs to your analyzer. Read [Electrostatic Discharge Protection](#).

Equation Editor and MatLab

MATLAB can be used with Equation Editor in two different ways:

1. When you install a full version of MATLAB on the VNA, MATLAB functions can be called directly from Equation Editor.

Install the full 32 bit version of MATLAB.

Press **Math** > **Analysis** > **Equation Editor...**

In the Equation Editor dialog, click the **Enable MATLAB** button.

You can then start calling MATLAB from within your equation editor entry field.

Here are a few example of how you would do this:

Matlab("S11.*S22") -> produces an array of multiplying S11*S22

Matlab("phase(S11)")-> produces an array of unwrapped phase of the S11 trace.

2. Compile a MATLAB *.dll using the full version on your PC. Then import the *.dll into Equation Editor

[Learn how to Import Functions into Equation Editor](#)

The MATLAB Compile Runtime on the VNA is currently 7.14, which is shipped with R2010b (7.11).

If you compile your *.dll using that version of MATLAB, then you don't need to change the version of MCR on the VNA.

Determine the version of MATLAB you will use.

You will need this version of MATLAB installed on your development machine (Step 2). You will also need a C++ compiler (Step 3).

You will need the appropriate version of MATLAB Compiler Runtime (MCR) installed on your target machines (Step 5).

To see installed version of MCR, check the following locations:

On a 32-bit Windows system:

C:\Program Files\Matlab\Matlab Compiler Runtime\

C:\Program Files\Matlab\Matlab Component Runtime\

On a 64-bit Windows system:

C:\Program Files (x86)\Matlab\Matlab Compiler Runtime\
C:\Program Files (x86)\Matlab\Matlab Component Runtime\

Use the chart below to compare MATLAB, MCR, and Compiler versions.

Install MATLAB (32-bit) on your development machine.

If your development system is 64-bit, manually navigate to \bin\win32\ on your install disk and run setup.exe to use the 32-bit installer. This requirement will be removed in future releases.

You must install with the MATLAB Compiler toolbox.

Install a compatible C++ compiler on your development machine.

For R2011b through R2013b, Windows SDK 7.1 with .NET 4.0 is sufficient.

Due to issues with the SDK installer, it is recommended to separately install .NET first, if not already installed.

The current SDK installer will also fail if Visual Studio redistributables are installed.

For a list of compatible compilers, see
<http://www.mathworks.com/support/compilers/>

Note that LCC is only a C compiler, not C++, and is not an acceptable option.

In MATLAB, select your installed compiler by running the command: `>> mbuild -setup`

Install the correct MCR on all target machines. This requires a reboot even if not prompted to do so by the installer.

Creating a MATLAB DLL

Open the MATLAB Compiler Deployment Tool, either through the user interface or with `>> deploytool`, and choose to make a "C++ Shared Library" project.

Add any .m files to your project that you need in the DLL through the Deployment Tool window. This includes any helpers for functions need to execute.

Functions must take in 0 to 32 arguments and return 1 value to be used on traces.

The return value can be an array the size of a trace or a single value.

Functions not conforming aren't directly accessible from Equation Editor but must be included if other functions rely on them.

Optional: Add function descriptors. These are separate functions which provide prototype (default) arguments for another function, named 'myFuncdesc' for every function.

These functions must take no arguments and return a single string, of the form:
'arg1,arg2,...' or 'arg1,arg2,...;tooltip'

where arg1, arg2, \dots is a list of arguments, and `tooltip` is an optional tooltip text to be used in future releases.

Build the project. This may take a few minutes and, if there are no errors, will generate `project`, `src` and `distrib` folders. The DLL will be under the `distrib` folder.

Some of the other generated files may be useful but are not needed for Equation Editor.

Optional: Package all the distributable files.

This package can also include the appropriate MCR installer (as large as 0.5 GB).

In general this step isn't needed, only the generated DLL is required.

Notes about Writing Scripts

The MATLAB functions that will be accessed directly by the Equation Editor must follow a specific format, as noted briefly above.

Inputs: 0 to 32 vectors with dimensions `[1, Sweep Size]`.

Constants (0, e, `channel()`, etc.) are expanded and passed as `[1, Sweep Size]` vectors.

Outputs: 1 vector with dimensions `[1, Sweep Size]` or `[1, 1]`.

Outputs size `[1, 1]` are expanded to `[1, Sweep Size]` vectors automatically.

Functions with other input/output sets are not directly accessible from Equation Editor but may be included in your DLL and used by other functions, meaning helpers can be used without risk.

Existing functions that do not fit these parameters can be included along with wrapper functions which convert the parameters and outputs within the MATLAB environment.

Outputting Data Guide

[Save and Recall a File](#)

[Print a Displayed Measurement](#)

[Drive Mapping](#)

Caution: Avoid expensive repairs to your analyzer. Read [Electrostatic Discharge Protection](#).

u_curve_equations

This topic contains the measurement uncertainty equations used to generate the uncertainty curves in [Specifications](#) documents.

It also contains general information about determining system measurement uncertainties.

Note: RSS Computations are included along with worst case computations.

Learn about the following subjects in this topic:

[Measurement Uncertainty Equations](#)

[Forward Reflection Uncertainty](#)

[Forward Transmission Uncertainty](#)

[Reverse Transmission Uncertainty](#)

[Reverse Reflection Uncertainty](#)

[Sources of Systematic Errors](#)

[Sources of Random Errors](#)

[Determining Expected System Performance](#)

[Determining Cable Stability Terms \(CR1, CR2, CTM1, CTM2, CTP1, CTP2\)](#)

See Also

[Measurement Errors](#)

[What is Measurement Calibration?](#)

[Why is Calibration Necessary?](#)

Measurement Uncertainty Equations

Any measurement result is the vector sum of the actual test device response plus all error terms. The precise effect of each error term depends on its magnitude and phase relationship to the actual test device response. When the phase of an error response is not known, phase is assumed to be worst case (-180° to $+180^\circ$).

Note: The uncertainty equations are derived for two-port measurement uncertainties. However, uncertainties for a one-port device can be derived by setting $S_{21}=0$ then computing the reflection uncertainties.

View the [abbreviations for residual systematic errors](#) used in the equations.

View the [abbreviations for random errors](#) used in the error models and equations.

Forward Reflection Uncertainty

Equation 1: Forward Reflection Magnitude Uncertainty (Worst Case Computation)

$$\Delta S_{11(\text{wsg})} = \sqrt{(\text{Systematic} + \text{Stability})^2 + \text{Noise}^2}$$

where:

$$\text{Systematic} = E_{DF} + E_{RF}S_{11} + E_{SF}S_{11}^2 + S_{21}S_{12} (E_{LF} + 2E_{SF}E_{LF}S_{11} + E_{LF}^2S_{22}) + A_M S_{11}$$

$$\text{Stability} = \sqrt{C^2 + R^2}$$

$$C^2 = C_{RM}^2 (1 + S_{11}^4) + 4C_{RM}^2 S_{11}^2 + C_{RM}^2 S_{21}^2 S_{12}^2$$

$$R^2 = (R_{R1} (1 + S_{11}^2) + 2R_{T1} S_{11})^2 + (R_{R2} S_{21} S_{12})^2$$

$$\text{Noise}^2 = (N_F S_{11})^2 + N_F^2$$

Equation 2: Forward Reflection Phase Uncertainty (Worst Case Computation)

$$\Delta S_{11(\text{phase})} = \sin^{-1} \left(\frac{\sqrt{(\text{Systematic} + \text{Stability})^2 + \text{Noise}^2}}{S_{11}} \right) + 2C_{DF}$$

where:

$$\text{Systematic} = E_{DF} + E_{RF}S_{11} + E_{SF}S_{11}^2 + S_{21}S_{12} (E_{LF} + 2E_{SF}E_{LF}S_{11} + E_{LF}^2S_{22}) + \sin(A_F) S_{11}$$

$$\text{Stability} = \sqrt{C^2 + R^2}$$

$$C^2 = C_{RM}^2 (1 + S_{11}^4) + 4C_{RM}^2 S_{11}^2 + C_{RM}^2 S_{21}^2 S_{12}^2$$

$$R^2 = (R_{R1} (1 + S_{11}^2) + 2R_{T1} S_{11})^2 + (R_{R2} S_{21} S_{12})^2$$

$$\text{Noise}^2 = (N_F S_{11})^2 + N_F^2$$

Equation 3: Forward Reflection Magnitude Uncertainty (RSS Computation)

$$\Delta S_{11(\text{mag})} = \sqrt{\text{Systematic}^2 + \text{Stability}^2 + \text{Noise}^2}$$

where:

$$\text{Systematic}^2 = E_{DF}^2 + E_{RF}^2 S_{11}^2 + E_{SF}^2 S_{11}^4 + S_{21}^2 S_{12}^2 (E_{LF}^2 + 4E_{SF}^2 E_{LF}^2 S_{11}^2 + E_{LF}^4 S_{22}^2) + A_M^2 S_{11}^2$$

$$\text{Stability}^2 = C^2 + R^2$$

$$C^2 = C_{RM}^2 (1 + S_{11}^4) + 4C_{RM}^2 S_{11}^2 + C_{RM}^2 S_{21}^2 S_{12}^2$$

$$R^2 = R_{R1}^2 (1 + S_{11}^2) + 4R_{T1}^2 S_{11}^2 + R_{R2}^2 S_{21}^2 S_{12}^2$$

$$\text{Noise}^2 = (N_F S_{11})^2 + N_F^2$$

Equation 4: Forward Reflection Phase Uncertainty (RSS Computation)

$$\Delta S_{11(\text{phase})} = \sqrt{\left(\sin^{-1} \left(\frac{\sqrt{\text{Systematic}^2 + \text{Stability}^2 + \text{Noise}^2}}{S_{11}} \right) \right)^2 + 4C_{\text{FP1}}^2}$$

where:

$$\text{Systematic}^2 = E_{\text{LF}}^2 + E_{\text{RF}}^2 S_{11}^2 + E_{\text{RF}}^2 S_{11}^4 + S_{21}^2 S_{12}^2 (E_{\text{LF}}^2 + 4E_{\text{RF}}^2 E_{\text{LF}}^2 S_{11}^2 + E_{\text{RF}}^4 S_{22}^2) + \sin^2(A_p) S_{11}^2$$

$$\text{Stability}^2 = C^2 + R^2$$

$$C^2 = C_{\text{M1}}^2 (1 + S_{11}^4) + 4C_{\text{M1}}^2 S_{11}^2 + C_{\text{M2}}^2 S_{21}^2 S_{12}^2$$

$$R^2 = R_{\text{R1}}^2 (1 + S_{11}^4) + 4R_{\text{R1}}^2 S_{11}^2 + R_{\text{R2}}^2 S_{21}^2 S_{12}^2$$

$$\text{Noise}^2 = (N_r S_{11})^2 + N_f^2$$

Forward Transmission Uncertainty

Equation 5: Forward Transmission Magnitude Uncertainty (Worst Case Computation)

$$\Delta S_{21(\text{mag})} = \sqrt{(\text{Systematic} + \text{Stability})^2 + \text{Noise}^2}$$

where:

$$\text{Systematic} = E_{\text{RF}} + S_{21} (E_{\text{RF}} + E_{\text{RF}} S_{11} + E_{\text{LF}} S_{22} + E_{\text{RF}} E_{\text{LF}} (S_{21} S_{12} + S_{11} S_{22})) + A_M$$

$$\text{Stability} = \sqrt{C^2 + R^2}$$

$$C^2 = S_{21}^2 (C_{\text{M1}}^2 + C_{\text{M2}}^2 + C_{\text{M1}}^2 S_{11}^2 + C_{\text{M2}}^2 S_{22}^2)$$

$$R^2 = S_{21}^2 ((R_{\text{R1}} + R_{\text{R1}} S_{11})^2 + (R_{\text{R2}} + R_{\text{R2}} S_{22})^2)$$

$$\text{Noise}^2 = (N_r S_{21})^2 + N_f^2$$

Equation 6: Forward Transmission Phase Uncertainty (Worst Case Computation)

$$\Delta S_{21(\text{phase})} = \sin^{-1} \left(\frac{\sqrt{(\text{Systematic} + \text{Stability})^2 + \text{Noise}^2}}{S_{21}} \right) + C_{\text{FP1}} + C_{\text{FP2}}$$

where:

$$\text{Systematic} = E_{\text{RF}} + S_{21} (E_{\text{RF}} + E_{\text{RF}} S_{11} + E_{\text{LF}} S_{22} + E_{\text{RF}} E_{\text{LF}} (S_{21} S_{12} + S_{11} S_{22})) + \sin(A_p)$$

$$\text{Stability} = \sqrt{C^2 + R^2}$$

$$C^2 = S_{21}^2 (C_{\text{M1}}^2 + C_{\text{M2}}^2 + C_{\text{M1}}^2 S_{11}^2 + C_{\text{M2}}^2 S_{22}^2)$$

$$R^2 = S_{21}^2 ((R_{\text{R1}} + R_{\text{R1}} S_{11})^2 + (R_{\text{R2}} + R_{\text{R2}} S_{22})^2)$$

$$\text{Noise}^2 = (N_r S_{21})^2 + N_f^2$$

Equation 7: Forward Transmission Magnitude Uncertainty (RSS Computation)

$$\Delta S_{21(\text{mag})} = \sqrt{\text{Systematic}^2 + \text{Stability}^2 + \text{Noise}^2}$$

where:

$$\text{Systematic}^2 = E_{XF}^2 + S_{21}^2 \left(E_{TF}^2 + E_{SF}^2 S_{11}^2 + E_{LF}^2 S_{22}^2 + E_{SF}^2 E_{LF}^2 (S_{21}^2 S_{12}^2 + S_{11}^2 S_{22}^2) + A_M^2 \right)$$

$$\text{Stability}^2 = C^2 + R^2$$

$$C^2 = S_{21}^2 \left(C_{M1}^2 + C_{M2}^2 + C_{M1}^2 S_{11}^2 + C_{M2}^2 S_{22}^2 \right)$$

$$R^2 = S_{21}^2 \left(R_{T1}^2 + R_{K1}^2 S_{11}^2 + R_{T2}^2 + R_{K2}^2 S_{22}^2 \right)$$

$$\text{Noise}^2 = (N_F S_{21})^2 + N_F^2$$

Equation 8: Forward Transmission Phase Uncertainty (RSS Computation)

$$\Delta S_{21(\text{phase})} = \sqrt{\left(\sin^{-1} \left(\frac{\sqrt{\text{Systematic}^2 + \text{Stability}^2 + \text{Noise}^2}}{S_{21}} \right) \right)^2 + C_{T1}^2 + C_{T2}^2}$$

where:

$$\text{Systematic}^2 = E_{XF}^2 + S_{21}^2 \left(E_{TF}^2 + E_{SF}^2 S_{11}^2 + E_{LF}^2 S_{22}^2 + E_{SF}^2 E_{LF}^2 (S_{21}^2 S_{12}^2 + S_{11}^2 S_{22}^2) + \sin^2(A_F) \right)$$

$$\text{Stability}^2 = C^2 + R^2$$

$$C^2 = S_{21}^2 \left(C_{M1}^2 + C_{M2}^2 + C_{M1}^2 S_{11}^2 + C_{M2}^2 S_{22}^2 \right)$$

$$R^2 = S_{21}^2 \left(R_{T1}^2 + R_{K1}^2 S_{11}^2 + R_{T2}^2 + R_{K2}^2 S_{22}^2 \right)$$

$$\text{Noise}^2 = (N_F S_{21})^2 + N_F^2$$

Reverse Transmission Uncertainty

Equation 9: Reverse Transmission Magnitude Uncertainty (Worst Case Computation)

$$\Delta S_{12(\text{mag})} = \sqrt{(\text{Systematic} + \text{Stability})^2 + \text{Noise}^2}$$

where:

$$\text{Systematic} = E_{XZ} + S_{12} \left(E_{TZ} + E_{SZ} S_{22} + E_{LZ} S_{11} + E_{SZ} E_{LZ} (S_{21} S_{12} + S_{11} S_{22}) + A_M \right)$$

$$\text{Stability} = \sqrt{C^2 + R^2}$$

$$C^2 = S_{12}^2 \left(C_{M1}^2 + C_{M2}^2 + C_{M1}^2 S_{11}^2 + C_{M2}^2 S_{22}^2 \right)$$

$$R^2 = S_{12}^2 \left(R_{T1} + R_{K1} S_{11} \right)^2 + \left(R_{T2} + R_{K2} S_{22} \right)^2$$

$$\text{Noise}^2 = (N_F S_{12})^2 + N_F^2$$

Equation 10: Reverse Transmission Phase Uncertainty (Worst Case Computation)

$$\Delta S_{12(\text{phase})} = \sin^{-1} \left(\frac{\sqrt{(\text{Systematic} + \text{Stability})^2 + \text{Noise}^2}}{S_{12}} \right) + C_{T1} + C_{T2}$$

where:

$$\text{Systematic} = E_{ZR} + S_{12} (E_{TR} + E_{SR}S_{22} + E_{LR}S_{11} + E_{SR}E_{LR} (S_{21}S_{12} + S_{11}S_{22})) + \sin(A_p)$$

$$\text{Stability} = \sqrt{C^2 + R^2}$$

$$C^2 = S_{12}^2 (C_{M1}^2 + C_{M2}^2 + C_{SM1}^2 S_{11}^2 + C_{SM2}^2 S_{22}^2)$$

$$R^2 = S_{12}^2 (R_{T1} + R_{R1}S_{11})^2 + (R_{T2} + R_{R2}S_{22})^2$$

$$\text{Noise}^2 = (N_r S_{12})^2 + N_f^2$$

Equation 11: Reverse Transmission Magnitude Uncertainty (RSS Computation)

$$\Delta S_{12(\text{mag})} = \sqrt{\text{Systematic}^2 + \text{Stability}^2 + \text{Noise}^2}$$

where:

$$\text{Systematic}^2 = E_{ZR}^2 + S_{12}^2 (E_{TR}^2 + E_{SR}^2 S_{22}^2 + E_{LR}^2 S_{11}^2 + E_{SR}E_{LR} (S_{21}S_{12} + S_{11}S_{22})) + A_p^2$$

$$\text{Stability}^2 = C^2 + R^2$$

$$C^2 = S_{21}^2 (C_{M1}^2 + C_{M2}^2 + C_{SM1}^2 S_{11}^2 + C_{SM2}^2 S_{22}^2)$$

$$R^2 = S_{21}^2 (R_{T1}^2 + R_{R1}^2 S_{11}^2 + R_{T2}^2 + R_{R2}^2 S_{22}^2)$$

$$\text{Noise}^2 = (N_r S_{21})^2 + N_f^2$$

Equation 12: Reverse Transmission Phase Uncertainty (RSS Computation)

$$\Delta S_{12(\text{phase})} = \sqrt{\left(\sin^{-1} \left(\frac{\sqrt{\text{Systematic}^2 + \text{Stability}^2 + \text{Noise}^2}}{S_{12}} \right) \right)^2 + C_{T1}^2 + C_{T2}^2}$$

where:

$$\text{Systematic}^2 = E_{ZR}^2 + S_{12}^2 (E_{TR}^2 + E_{SR}^2 S_{22}^2 + E_{LR}^2 S_{11}^2 + E_{SR}E_{LR} (S_{21}S_{12} + S_{11}S_{22})) + \sin^2(A_p)$$

$$\text{Stability}^2 = C^2 + R^2$$

$$C^2 = S_{21}^2 (C_{M1}^2 + C_{M2}^2 + C_{SM1}^2 S_{11}^2 + C_{SM2}^2 S_{22}^2)$$

$$R^2 = S_{21}^2 (R_{T1}^2 + R_{R1}^2 S_{11}^2 + R_{T2}^2 + R_{R2}^2 S_{22}^2)$$

$$\text{Noise}^2 = (N_r S_{21})^2 + N_f^2$$

Reverse Reflection Uncertainty

Equation 13: Reverse Reflection Magnitude Uncertainty (Worst Case Computation)

$$\Delta S_{22(\text{worst})} = \sqrt{(\text{Systematic} + \text{Stability})^2 + \text{Noise}^2}$$

where:

$$\text{Systematic} = E_{DR} + E_{RR}S_{22} + E_{SR}S_{22}^2 + S_{21}S_{12} \left(E_{LR} + 2E_{LR}E_{LR}S_{22} + E_{LR}^2S_{11} \right) + A_{3d}S_{22}$$

$$\text{Stability} = \sqrt{C^2 + R^2}$$

$$C^2 = C_{RM2}^2 (1 + S_{22}^4) + 4C_{RM2}^2 S_{22}^2 + C_{RM1}^2 S_{21}^2 S_{12}^2$$

$$R^2 = \left(R_{R2} (1 + S_{22}^2) + 2R_{r2}S_{22} \right)^2 + \left(R_{R1}S_{21}S_{12} \right)^2$$

$$\text{Noise}^2 = \left(N_r S_{22} \right)^2 + N_f^2$$

Equation 14: Reverse Reflection Phase Uncertainty (Worst Case Computation)

$$\Delta S_{21(\text{phase})} = \sin^{-1} \left(\frac{\sqrt{(\text{Systematic} + \text{Stability})^2 + \text{Noise}^2}}{S_{22}} \right) + 2C_{\pi 2}$$

where:

$$\text{Systematic} = E_{DR} + E_{RR}S_{22} + E_{SR}S_{22}^2 + S_{21}S_{12} \left(E_{LR} + 2E_{LR}E_{LR}S_{22} + E_{LR}^2S_{11} \right) + \sin(A_3)S_{11}$$

$$\text{Stability} = \sqrt{C^2 + R^2}$$

$$C^2 = C_{RM2}^2 (1 + S_{22}^4) + 4C_{RM2}^2 S_{22}^2 + C_{RM1}^2 S_{21}^2 S_{12}^2$$

$$R^2 = \left(R_{R2} (1 + S_{22}^2) + 2R_{r2}S_{22} \right)^2 + \left(R_{R1}S_{21}S_{12} \right)^2$$

$$\text{Noise}^2 = \left(N_r S_{22} \right)^2 + N_f^2$$

Equation 15: Reverse Reflection Magnitude Uncertainty (RSS Computation)

$$\Delta S_{22(\text{mag})} = \sqrt{\text{Systematic}^2 + \text{Stability}^2 + \text{Noise}^2}$$

where:

$$\text{Systematic}^2 = E_{DR}^2 + E_{RR}^2 S_{22}^2 + E_{SR}^2 S_{22}^4 + S_{21}^2 S_{12}^2 \left(E_{LR}^2 + 4E_{LR}^2 E_{LR}^2 S_{22}^2 + E_{LR}^4 S_{11}^2 \right) + A_{3d}^2 S_{22}^2$$

$$\text{Stability}^2 = C^2 + R^2$$

$$C^2 = C_{RM2}^2 (1 + S_{22}^4) + 4C_{RM2}^2 S_{22}^2 + C_{RM1}^2 S_{21}^2 S_{12}^2$$

$$R^2 = \left(R_{R2} (1 + S_{22}^2) + 2R_{r2}S_{22} \right)^2 + \left(R_{R1}S_{21}S_{12} \right)^2$$

$$\text{Noise}^2 = \left(N_r S_{22} \right)^2 + N_f^2$$

Equation 16: Reverse Reflection Phase Uncertainty (RSS Computation)

$$\Delta S_{22(\text{phase})} = \sqrt{\left(\sin^{-1} \left(\frac{\sqrt{\text{Systematic}^2 + \text{Stability}^2 + \text{Noise}^2}}{S_{22}} \right) \right)^2 + 4C_{TP2}^2}$$

where:

$$\text{Systematic}^2 = E_{DF}^2 + E_{SF}^2 S_{22}^2 + E_{ER}^2 S_{22}^4 + S_{21}^2 S_{12}^2 (E_{LR}^2 + 4E_{ER}^2 E_{LF}^2 S_{22}^2 + E_{LR}^4 S_{11}^2) + \sin^2(A_F) S_{22}^2$$

$$\text{Stability}^2 = C^2 + R^2$$

$$C^2 = C_{DM2}^2 (1 + S_{22}^4) + 4C_{DM2}^2 S_{22}^2 + C_{DM1}^2 S_{21}^2 S_{12}^2$$

$$R^2 = (R_{R2} (1 + S_{22}^2) + 2R_{T2} S_{22})^2 + (R_{R1} S_{21} S_{12})^2$$

$$\text{Noise}^2 = (N_f S_{22})^2 + N_g^2$$

Sources of Systematic Errors

The residual (after measurement calibration) **systematic errors** result from imperfections in the calibration standards.

For **reflection measurements**, the associated residual errors are:

residual directivity	residual load match
residual source match	residual reflection tracking

For **transmission measurements**, the additional residual errors are:

residual crosstalk	residual load match
residual source match	residual transmission tracking

The listing below shows the **abbreviations** used for residual systematic errors that are in the uncertainty equations.

EDF = forward residual directivity	ESR = reverse residual source match
ESF = forward residual source match	ERR = reverse residual reflection tracking
ERF = forward residual reflection tracking	EXR = reverse crosstalk
EXF = forward crosstalk	ELR = reverse load match
ELF = forward load match	ETR = reverse transmission tracking
ETF = forward transmission tracking	AM = magnitude dynamic accuracy
EDR = reverse residual directivity	AP = phase dynamic accuracy

All measurements are affected by **dynamic accuracy**. Dynamic accuracy includes: errors during internal self-calibration routines, gain compression in the microwave frequency converter (sampler) at high signal levels, errors generated in the synchronous detectors, localized non-linearities in the IF filter system, and from LO leakage into the IF signal paths.

Sources of Random Errors

The **random error** sources are

- noise
- connector repeatability
- interconnecting cable stability

There are two types of noise in any measurement system:

- low level noise (noise floor)
- high level noise (trace noise)

Low level noise is the broadband noise floor of the receiver which can be reduced through averaging or by changing the IF bandwidth.

High level noise or trace noise is due to the noise floor of the receiver, and the phase noise of the LO source inside the test set. It is worsened by reducing the IF bandwidth. Using a high stability 10 MHz time base can reduce high level noise.

Connector repeatability is the random variation encountered when connecting a pair of RF connectors. Variations in both reflection and transmission can be observed.

Cable stability is dependent on the cable used and the amount of cable movement between calibration and measurement.

The listing below shows the **abbreviations** used for random errors in the error models and uncertainty equations.

- | | |
|---|---|
| NF = noise floor | CTM2 = port 2 cable magnitude transmission stability |
| NT = trace noise | CTP2 = port 2 cable phase transmission stability |
| CR1 = port 1 cable reflection stability | RR1 = port 1 connector reflection repeatability |
| CTM1 = port 1 cable magnitude transmission stability | RT1 = port 1 connector transmission repeatability |
| CTP1 = port 1 cable phase transmission stability | RR2 = port 2 connector reflection repeatability |
| CR2 = port 2 cable reflection stability | RT2 = port 2 connector transmission repeatability |

Determining Expected System Performance

Improper connection techniques and contact surfaces can degrade measurement accuracy.

Proper connection techniques include using a torque wrench with proper torque limits, ensuring that the connector pin depths meet specifications, ensuring that the center conductor of sliding loads is properly set, and observing proper handling procedures for beadless airlines.

Contact surface errors are caused by improper cleaning procedures, scratches, worn plating, and rough seating. View more information on [connector care](#)

If proper connection techniques and connector care is observed, the following table provides an indication of connector repeatability.

Connector Repeatability (RR1, RR2, RT1, and RT2)				
Connector Type			Connector Type	
Frequency Range	Repeatability		Frequency Range	Repeatability

2.4-mm		3.5-mm	
0 to 2 GHz	0.0002	0 to 2 GHz	0.0001
2 to 20 GHz	0.0004	2 to 8 GHz	0.0003
20 to 36 GHz	0.0006	8 to 20 GHz	0.0006
36 to 40 GHz	0.0008	20 to 26.5 GHz	0.0010
7-mm		Type-N	
0 to 2 GHz	0.0001	0 to 2 GHz	0.0006
2 to 8 GHz	0.0003	2 to 8 GHz	0.0006
8 to 18 GHz	0.0006	8 to 18 GHz	0.0010
Type-F		Waveguide	
0 to 3 GHz	0.0006	0 to 40 GHz	0.0002

**Determining Cable Stability Terms
(CR1, CR2, CTM1, CTM2, CTP1, CTP2)**

Cable stability is dependent on the cable used and the amount of cable movement between calibration and measurement. Values for **cable reflection stability** are determined by connecting a fixed load to the free end of the cable and measuring the change in reflection coefficient after flexing the cable through the normal range of cable movement for a particular setup. **Cable transmission stability** is determined by connecting a short to the free end of the cable and measuring the change in reflection coefficient due to changes in cable position.

Graphics 1-3 demonstrate concepts useful in determining cable stability. In each case, a cable (part number 8120-4779) was connected to port 1, with a fixed load connected to the free end. A reference trace is obtained by measuring S11 with the free end held close to port 2 and storing the results in memory. Two additional S11 measurements are made; one with the cable flexed out to its straight position and the other with the cable positioned back to the same location as reference trace. As shown in Graphic 1, the flexed position demonstrates the effect of moving the cable after calibration. The repeatability trace demonstrates the stability of the cable when moved to its original position.

Graphic 1

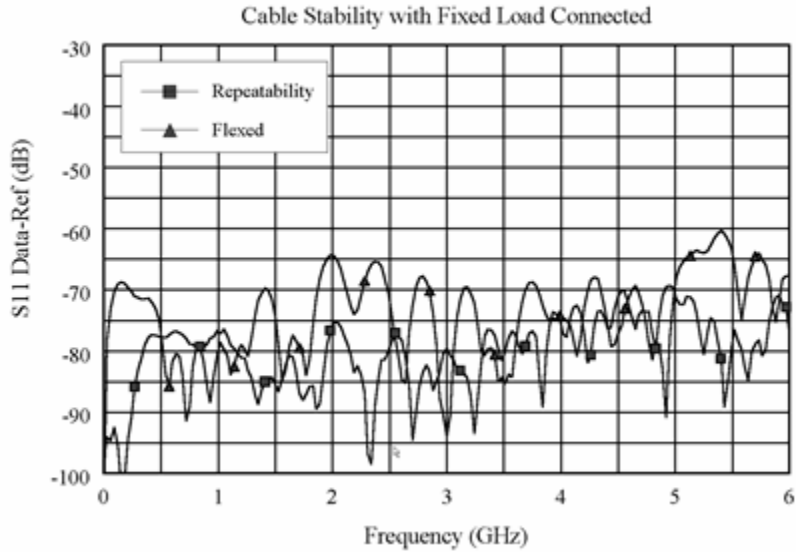

Graphic 1 demonstrates the concepts useful in determining cable reflection stability. A fixed load is connected to the free end. The DATA-MEM feature provides an indication of the cable reflection stability. A 60-dB peak on the chart yields a reflection stability estimated as $10(-60/20)$ or 0.001.

Graphic 2

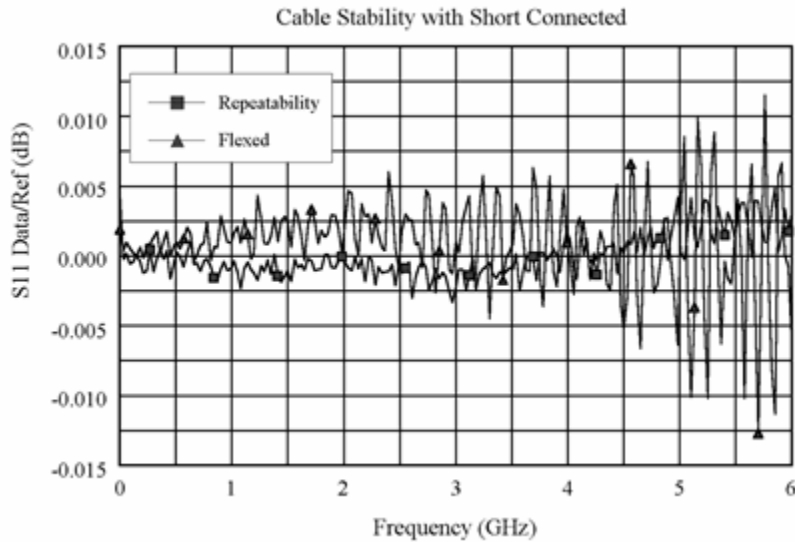

Graphic 2 and Graphic 3 demonstrate the concepts useful in determining cable transmission stability. A short is connected to the free end. The DATA/MEM feature provides an indication of the two-way cable transmission stability. The one-way transmission magnitude stability is determined by dividing the two-way magnitude measurement by two before it is converted to linear. A 0.013-dB peak on the chart yields transmission magnitude stability estimated as $10(0.013/40) - 1$ or 0.00075. The one-way transmission phase stability is determined by dividing the two-way phase measurement by two.

Graphic 3

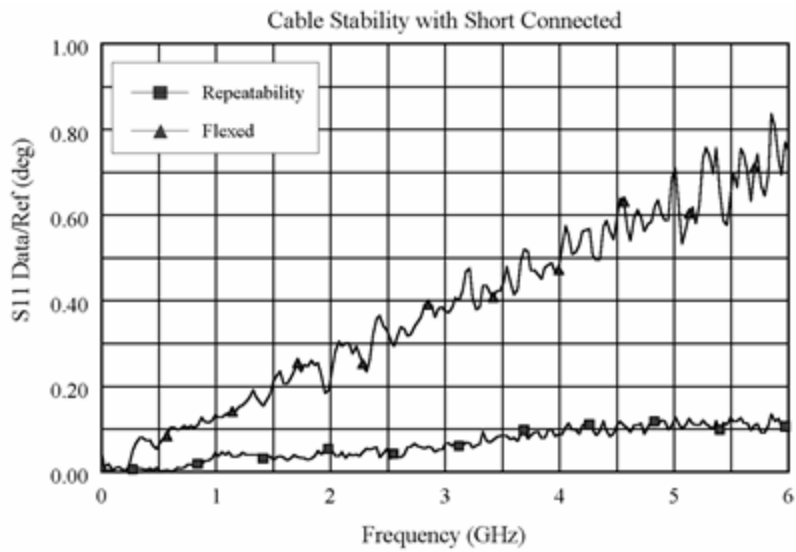

Cable movement often has a much larger effect on phase measurements than magnitude measurements.

See Also

[Measurement Errors](#)

[What is Measurement Calibration?](#)

[Why is Calibration Necessary?](#)

Instrument Calibration Verification

When the annual instrument calibration has been performed on your M937xA module, you will notice that there is no room on the front panel for the traditional calibration 'sticker'. Instead, the calibration date and (next) calibration due date are appended to the M937xA Help About page.

The Calibration date is edited when you send your M937xA module to Keysight for Instrument Calibration.

You can edit these Help About fields, as well as set the calibration interval, using the `SYST:SERV:VER` SCPI commands.

Loop Bandwidth Adjustment

Loop Bandwidth Adjustment is a **SERVICE** Routine for optimizing the RF and LO loop bandwidth for fast sweeps. This adjustment is only for PXI VNA modules with **Option 103**.

Procedure

Launch the soft front panel of the PXI VNA.

Click Utilities, **then** System, **then** Service, **then** Adjustments.

At the Adjustments selection, click Loop Bandwidth Adjustment. **The** Loop BW Adjustment dialog is displayed as shown below.

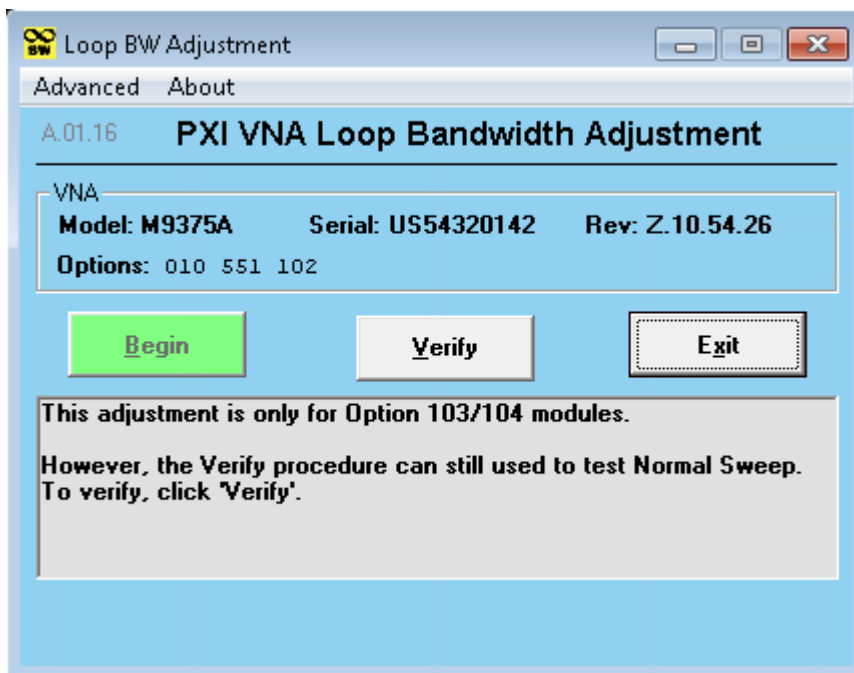

Click the Verify button. When completed, the following dialog is displayed.

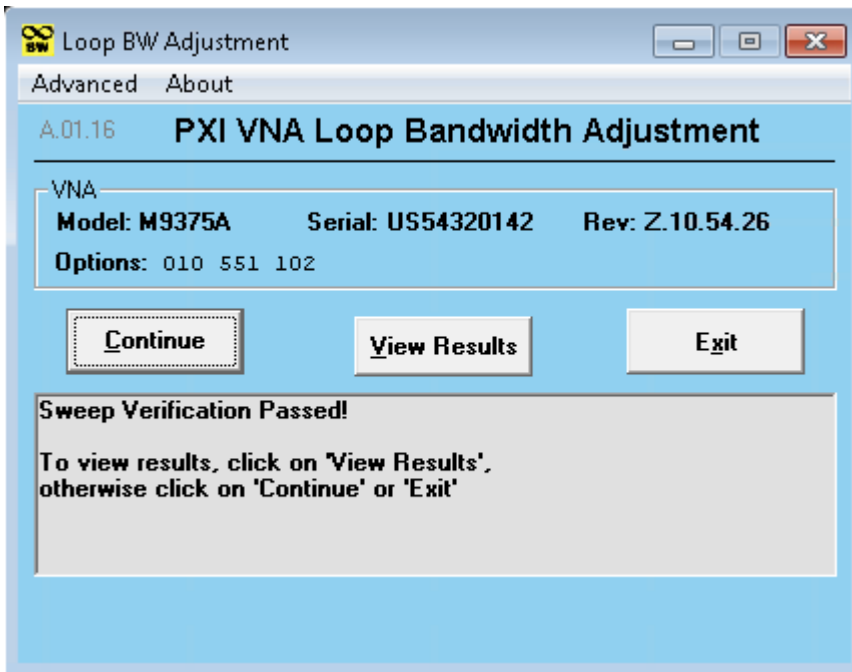

Click the View Results button to view the results.

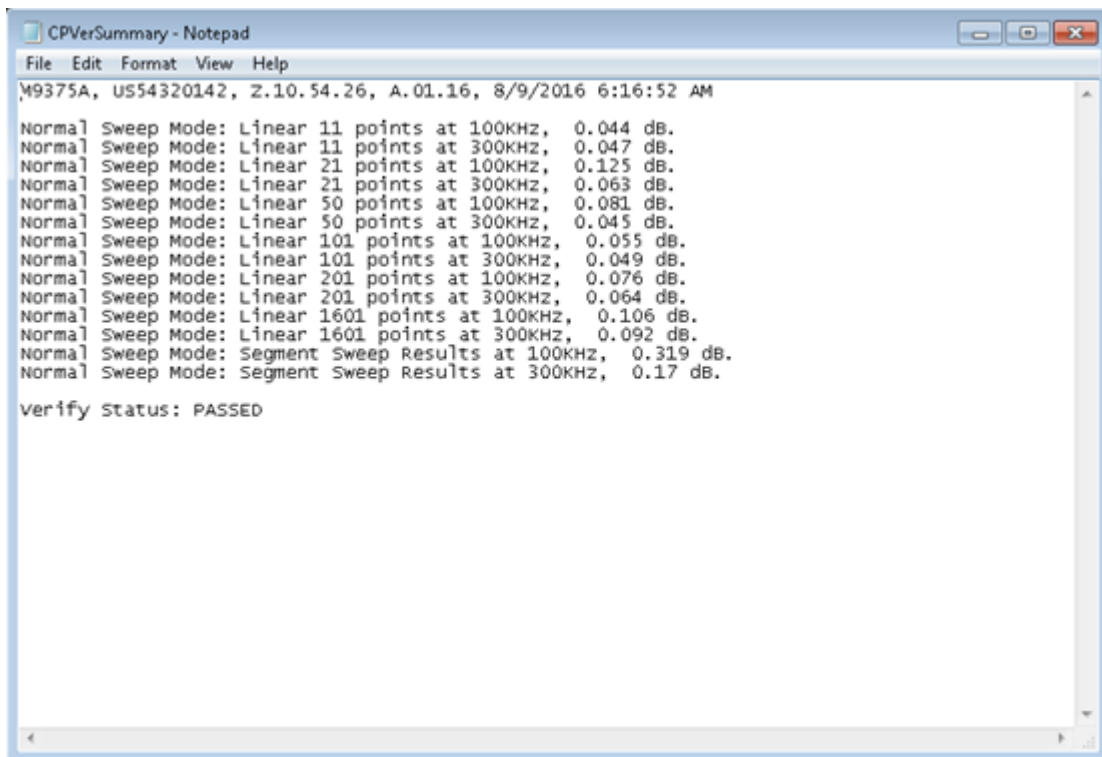

Click the Continue button to perform the adjustment again or click Exit if done.

Data Storage

The data is stored in the flash memory.

Support Overview

Learn about your Analyzer

[Specifications](#)

[M937x Configurations](#)

[Analyzer Accessories](#)

Update your Analyzer

[Firmware Update \(Agile Update\)](#)

[Option Enable](#)

[Instrument Calibration](#)

Problems with your Analyzer

[Diagnostic Tools, Utilities, and Adjustments](#)

[Troubleshoot the Analyzer](#)

[About Error Messages](#)

Resources for your Analyzer

[Technical Support](#)

[Other Resources](#)

Caution: Avoid expensive repairs to your analyzer. Read [Electrostatic Discharge Protection](#).

System Receiver Cal

System Receiver Cal is a **SERVICE** Routine for performing the enhanced mixer calibration for the VNA. This calibration should be performed when **Option 009** is installed for performing **SMC measurements**.

Required Equipment

Note: The power sensor depends on the VNA frequency range. Depending on the VNA model, two power sensors may be required to test the full frequency range. The VNA front panel connector type will determine the cable used and if an adapter is required with the power sensor(s).

External Source

ECal Module

See list of supported power meters and sensors.

See PNA Accessories

Procedure

Note: Throughout this procedure, an M937xA is shown.

Connect the controller to the power meter/power sensor and also to your external source using GPIB or USB.

Launch the soft front panel of the VNA.

Click Utility, then System, then Service, then Adjustment Routines.

At the Adjustments selection, click System Receiver Cal. The Enhanced Receiver Cal dialog is displayed as shown below.

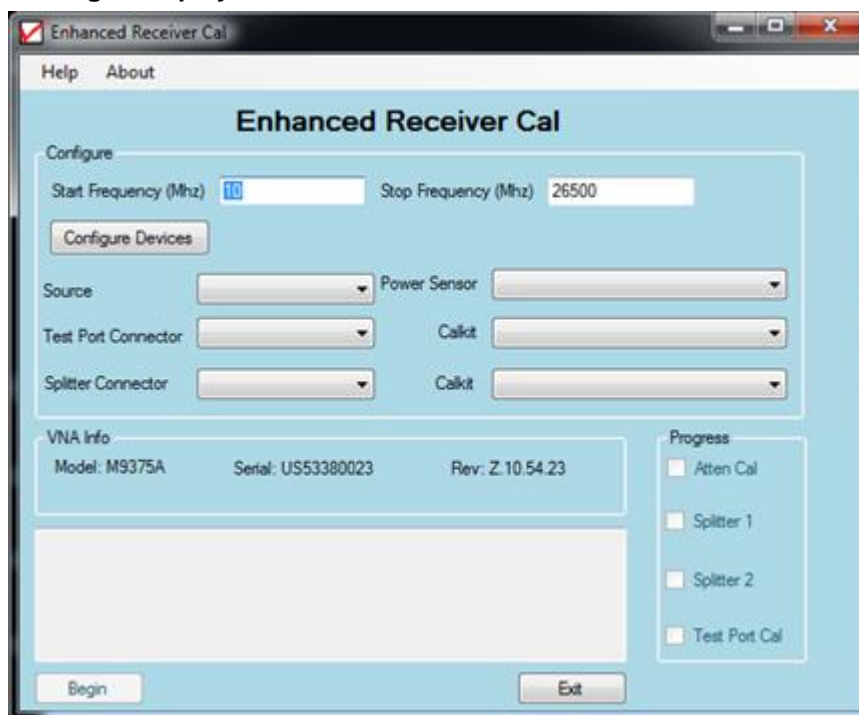

Click the Configure Devices button to configure an **external source** and **PMAR** (Power Meter as a Receiver).

In the Enhanced Receiver Cal dialog, set up the following:

Enter the Start Frequency and Stop Frequency.

Select your external source from the Source drop-down menu.

Select your power sensor from the Power Sensor drop-down menu.

Select the test port connector type of the VNA and corresponding calkit from the Test Port Connector and Calkit drop-down menus.

Select the splitter connector type and corresponding calkit from the Splitter Connector and Calkit drop-down menus.

Click the Begin button to start the calibration process.

On port 1 of the VNA, connect a male-to-male adapter and then a 10 dB attenuator as shown below.

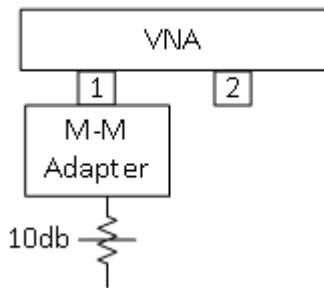

In the Enhanced Receiver Cal dialog click the Measure button to perform a 1-port S-parameter calibration at the end of the attenuator.

When prompted, connect an ECal module to the end of the 10 dB attenuator on port 1 then click OK.



When prompted, connect a splitter as follows.

Connect the external source to the input of the splitter.

Connect one splitter output to the end of the 10 dB attenuator on port 1.

Connect the power sensor to the other splitter output.

Connect the 10 MHz reference OUT from the VNA to the 10 MHz reference IN of the external source.

Click the Measure button (this measurement may take up to 2 minutes to complete).

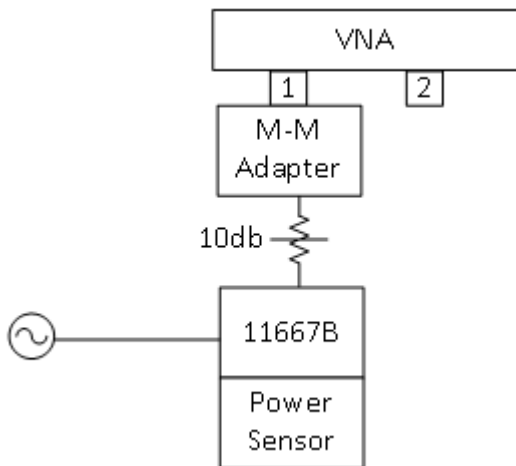

When prompted, disconnect the splitter and flip the connections as follows.

Connect the 10 dB attenuator on port 1 to the opposite output of the splitter.

Connect the power sensor to the opposite output of the splitter.

Reconnect the external source to the input of the splitter.

Click the Measure button (this measurement may take up to 2 minutes to complete).

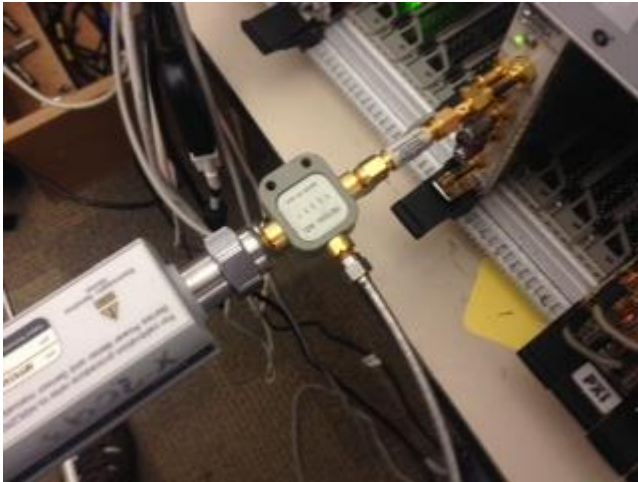

When prompted, disconnect all cables and adapters from port 1 and port 2.

Click the Measure button to perform a 2-port S-parameter calibration at the test ports.

When prompted, connect the ECal module to port 1 then click OK.

Note: If you have an insertable ECal module, then you can connect it directly to the ports. If the ECal module has female connectors, then an adapter will be needed.

When prompted, connect the ECal module to port 2 then click OK.

When prompted, remove the ECal module and connect a cable from port 1 to port 2 then click OK. Ensure that the cable has a frequency range that spans the frequency range of the VNA.

When finished, a message indicating that calibration was successful is displayed.

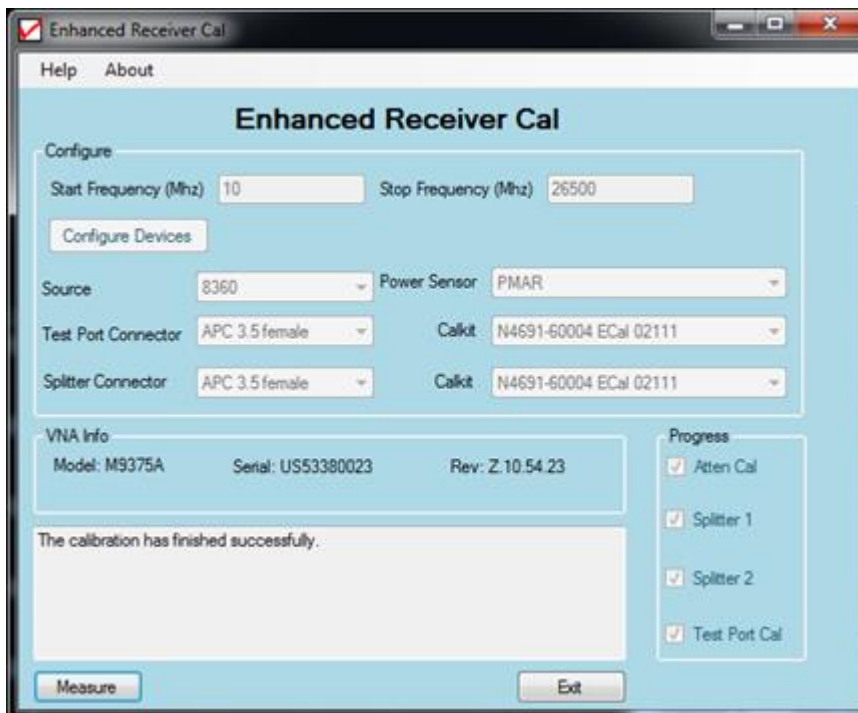

Data Storage

The correction data is stored in the flash memory.

Display Update

How to set Display Update

Using **Hardkey/SoftTab/Softkey**

Press **Display** > **Display Settings** > **Display Update** (Turns ON display update).

press **Display** > **Display Settings** > click left side small button of **Display Update** (Turns OFF display update).

◀ Programming Commands ▶

Notes:

Turn ON/OFF the Display update will result on the **Status Bar**.

Update State ON/OFF is part of the save/recall state.

Softkey(s) exist for update state ON/OFF and immediate update.

Disabling the display update will yield the most significant performance improvements.

The performance improvement (due to disabling updates) for a single channel and window state seems negligible. However, with a large number of channels, windows and traces, it should make more of a difference (but disabling the display update will provide more performance improvement). For example, Performance Oddities, the following is looking at the INDEX line (Handler I/O) for a 1.0 GHz to 1.2 GHz with 201 point sweep (otherwise Preset condition apply). When high, the analyzer is sweeping. There is 20 ms of dead time between many of sweeps.

Install VDI PM5 Driver

VDI's 'PM5' power meter MAY work with the VNA. However, because there are many factors out of our control, we can not guarantee the functionality or performance.

Note: VNA firmware between A.11.00.xx and A.13.20.xx do NOT include this capability. Ideally, the VNA should have the most recent VNA Firmware that is supported by your VNA.

To enable the use of the PM5 power meter with the VNA Source Power Cal and Power Meter-As-Receiver (PMAR) features, you must first install *on your VNA* the software that VDI supplies on a USB stick with the PM5. The procedure for installing that software on the VNA is the same as installing it on a PC, which is detailed in the manual for the PM5 which can be found here:

<http://www.vadiodes.com/images/Products/PowerMeter/PM5manual/VDI-724-PM5-Manual.pdf>

Once that software is installed on the VNA, the PM5 is accessed via Source Power Cal and PMAR by the VISA resource string "ASRL3::INSTR". The following dialogs illustrate how to specify that in the VNA's Power Meter Settings dialog for Source Power Cal and the VNA's External Devices dialog for PMAR.



For more information, refer to the [Power Meter Settings](#) dialog description.

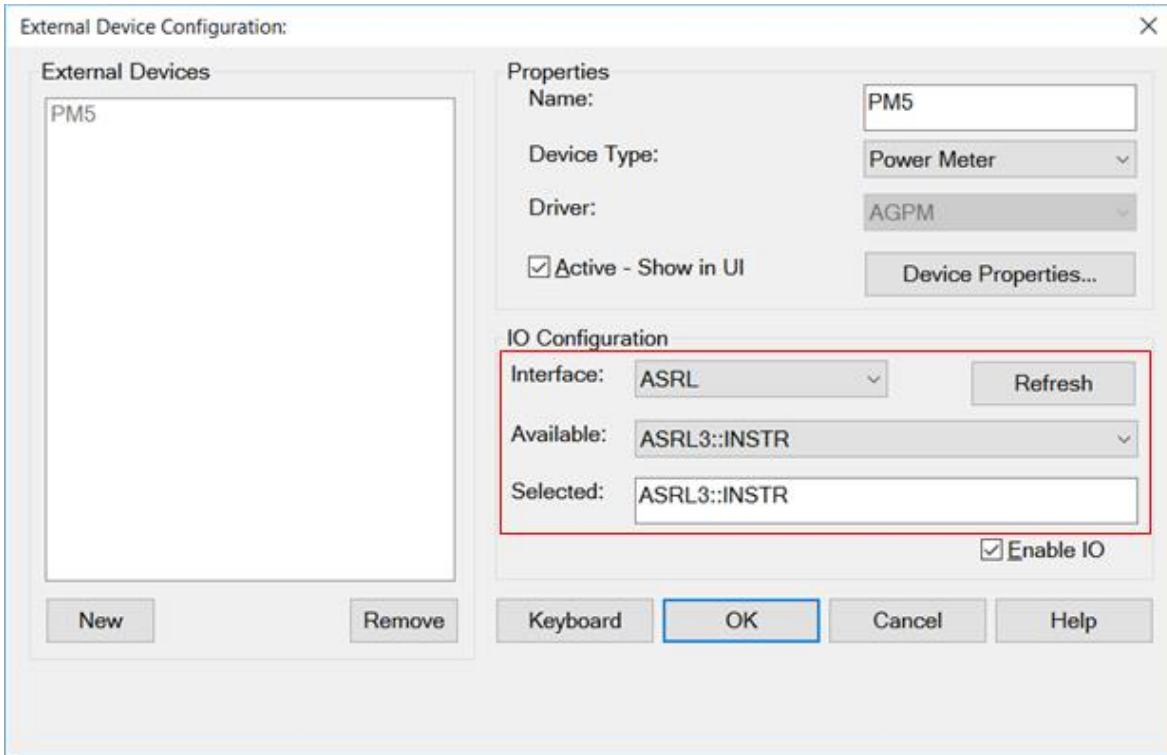

For more information, refer to the [External Device Configuration](#) dialog description.

System Topics

System Settings

[Dialog Transparency](#)

[Display Colors](#)

[Frequency Blanking](#) (For security purposes)

[Preferences](#)

[Power Limit and Power Offset](#) (Prevents overpowering DUTs)

[Preset the Analyzer](#)

[System Impedance](#)

[Receiver Temperature](#)

[About Error Messages](#)

Caution: Avoid expensive repairs to your analyzer. Read [Electrostatic Discharge Protection](#).

Tutorials Guide

Videos

- [Application Notes](#)
- [Connector Care](#)
- [Electrostatic Discharge \(ESD\) Protection](#)
- [Network Analyzer Basics \(video\)](#)

Measurement Tutorials

- [Absolute Output Power](#)
- [AM-PM Conversion](#)
- [Amplifier Parameters](#)
- [Antenna Measurements](#)
- [Balanced Measurements](#)
- [Complex Impedance](#)
- [Comparing the VNA Delay Functions](#)
- [Deviation from Linear Phase](#)
- [Gain and Flatness](#)
- [Gain Compression](#)
- [Group Delay](#)
- [High-Gain Amplifier Measurements](#)
- [Phase Measurements](#)
- [Reverse Isolation](#)
- [Reflection Measurements](#)
- [SA Amplifier Harmonics Measurement](#)
- [SA Converter Spurious Measurement](#)
- [Time Domain Measurements](#)
- [Dual Band Parallel Noise Figure Measurement \(M9485A\)](#)

Caution: Avoid expensive repairs to your PNA. Read [Electrostatic Discharge Protection](#).

Videos

<https://www.youtube.com/user/KeysightNetworkAnalyzers>

(Internet connection required)



This information is subject to change without notice.
© Keysight Technologies 2014-2019
Print Date: May 20, 2019

www.keysight.com