

Agilent IFT Automation Scripts for Verizon Wireless Compliance Test Plans (N5973A)

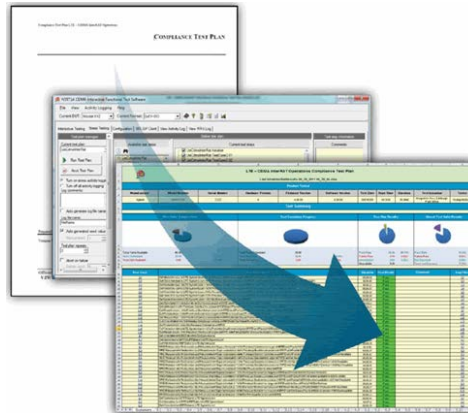

Installation and User's Guide



Agilent Technologies

This page is intentionally left blank.

Notices

© Agilent Technologies, Inc. 2012-2014

No part of this manual may be reproduced in any form or by any means (including electronic storage and retrieval or translation into a foreign language) without prior agreement and written consent from Agilent Technologies, Inc. as governed by United States and international copyright laws.

Trademark Notices

Windows®, MS Windows XP®, and MS Windows 7® are either registered trademarks of Microsoft Corporation in the United States and/or other countries.

Warranty

The material contained in this document is provided “as is,” and is subject to being changed, without notice, in future editions. Further, to the maximum extent permitted by applicable law, Agilent disclaims all warranties, either express or implied, with regard to this manual and any information contained herein, including, but not limited to the implied warranties of merchantability and fitness for a particular purpose. Agilent shall not be liable for errors or for incidental or consequential damages in connection with the furnishing, use, or performance of this document or of any information contained herein. Should Agilent and the user have a separate written agreement with warranty terms covering the material in this document that conflict with these terms, the warranty terms in the separate agreement shall control.

Statement of Compliance

This product has been designed and tested in accordance with accepted industry standards, and has been supplied in a safe condition. The documentation contains information and warnings that must be followed by the user to ensure safe operation and to maintain the product in a safe condition.

Manual Part Number

N5973-90003

Supersedes: N5973-90001 and
N5973-90002

Edition

March 30th, 2014

Documents Software Version 10.0

Technology Licenses

The hardware and/or software described in this document are furnished under a license and may be used or copied only in accordance with the terms of such license.

Restricted Rights Legend

If software is for use in the performance of a U.S. Government prime contract or subcontract, Software is delivered and licensed as “Commercial computer software” as defined in DFAR 252.227-7014 (June 1995), or as a “commercial item” as defined in FAR 2.101(a) or as “Restricted computer software” as defined in FAR 52.227-19 (June 1987) or any equivalent agency regulation or contract clause. Use, duplication or disclosure of Software is subject to Agilent Technologies’ standard commercial license terms, and non-DOD Departments and Agencies of the U.S. Government will receive no greater than Restricted Rights as defined in FAR 52.227-19(c)(1-2) (June 1987). U.S. Government users will receive no greater than Limited Rights as defined in FAR 52.227-14 (June 1987) or DFAR 252.227-7015 (b)(2) (November 1995), as applicable in any technical data.

Safety Notices

The following general safety precautions must be observed during all phases of operation of this instrument. Failure to comply with these precautions or with specific warnings elsewhere in this manual violates safety standards of design, manufacture, and intended use of the instrument. Agilent Technologies Inc. assumes no liability for the customer’s failure to comply with these requirements.

CAUTION

A CAUTION notice denotes a hazard. It calls attention to an operating procedure, practice, or the like that, if not correctly performed or adhered to, could result in damage to the product or loss of important data. Do not proceed beyond a CAUTION notice until the indicated conditions are fully understood and met.

WARNING

A WARNING notice denotes a hazard. It calls attention to an operating procedure, practice, or the like that, if not correctly performed or adhered to, could result in personal injury or death. Do not proceed beyond a WARNING notice until the indicated conditions are fully understood and met.

Where to Find the Latest Information

Documentation is updated periodically. For the latest information about the N5973A product, consult the following website: www.agilent.com/find/N5973A.

For the latest information about the Agilent E6621A PXT instrument, including product accessory information, see the following website: www.agilent.com/find/pxt.

For the latest information about the Agilent E5515E - 8960 instrument, including all Lab Applications and Test Applications, see the following website: www.agilent.com/find/8960.

Is your product software up-to-date?

Periodically, Agilent releases software updates to incorporate product enhancements, and fix known defects. All N5973A software revisions are available from the Agilent Software Manager at www.agilent.com/find/softwaremanager, and require a valid N5973AS Software and Technical Support Contract (STSC). All E6621A PXT and 8960 software revisions required for use with the N5973A are also available from the Agilent Software Manager site.

IMPORTANT	<p>To obtain the most current software for the products listed, you must have the following:</p> <ul style="list-style-type: none">• Agilent E6720A Annual Contract for the Agilent 8960• Agilent Software and Technical Support Contract (STSC) for the Agilent E6621A• Agilent Software and Technical Support Contract (STSC) for the Agilent N5973A
------------------	--

Table of Contents

1	Introduction	7
	In this book, you'll find.....	7
2	System Component Overview	8
	Server and Client PC Requirements	8
	PXT Scenario Files.....	8
	Default UE IP Settings for Scenario File	8
	System Requirements.....	9
	Hardware and Software Configuration	10
3	Software Installation and Licensing	13
	Installation of IFT Scripts and Licenses on the Client PC	13
	Valid STSC License Verification	14
	Location of User Data	15
	Installation of Server Applications on the Server PC.....	15
	Installation of all other System Components.....	17
4	Uninstalling N5973A Software	18
	When Using MS Windows XP	18
	When Using MS Windows 7.0.....	18
5	Using the N5973A IFT Wireless Compliance Scripts	19
	Connecting All System Components.....	19
	Setting Up the Test System.....	21
	Confirming the Equipment Connections.....	21
	Launch the Software.....	23
	Configuring the N5972A IFT to Use the N5973A Wireless Compliance Scripts.....	24
	Selecting the N5972A Active Software and Setting the Cell Format	24
	Setting the Test Equipment Connections.....	24
	Checking the System Connections Integrity	25
	Running the N5972A IFT Software and N5973A Wireless Compliance Scripts.....	26
	Running the Wireless Compliance Test Plans with the N5972A IFT Interface	27
	Running the Wireless Compliance Test Cases with the N5972A Scripting Tool.....	28
6	Directory Structure	30
7	Settings Files	31
8	Test Results Storage	34
	Introduction	34
	Test Report	34
	Logfile	34
	Storage/Saved File Structure.....	34
9	Software Organization	36

Introduction	36
IFT Scripts	36
Startup	36
CleanUp	36
Compiled Library (DLL/Dynamically Linked Library)	36
10 Test Cases.....	37
N5973A-1FP Test Cases.....	37
N5973A-2FP Test Cases.....	38
N5973A-4FP Test Cases.....	39
11 Settings File Configuration	41
12 UE Specific Settings File Configuration	43
13 Connection Tips	46
GPIB Interface.....	46
UUT Com Port.....	46
Ping Reply Too Fast.....	46
Force Dormant.....	47
14 Service and Support	48
Calling Agilent Technologies.....	48
Locations for Agilent Technologies.....	49
Software and Technical Support Contracts	50
Software Support.....	50
Technical Support.....	50
STSCs for the Agilent N5973A IFT.....	50
Web-based support.....	51
E-mail support	51
Phone support	51
Licensing and Software Compatibility.....	51
Renewals.....	52

1 Introduction

Welcome to the Agilent IFT Automation Scripts for Verizon Wireless Compliance Test Plans (N5973A) User's and Installation Guide. The purpose of this guide is to provide you with the information you need to do the following:

- Install and license the N5973A IFT test scripts that run within the Agilent N5972A Interactive Functional Test software.
- Perform the tests provided by the N5973A IFT.

The N5973A scripts are accessed or executed within the Agilent N5972A Interactive Functional Tester (IFT) product. The N5972A IFT is a software application that runs on a PC using Microsoft (MS) Windows XP or Windows 7 operating system.

The N5973A in conjunction with N5972A controls a combination of test instruments to provide the overall environment or system for performing the Verizon Wireless Compliance Test Plans on a mobile device; The N5973A implements the following Wireless Compliance test plans:

- N5973A-1FP IFT scripts for LTE-CDMA InterRAT operations
- N5973A-2FP IFT scripts for LTE-CDMA InterRAT operations simultaneous voice and data (SVD)
- N5973A-4FP IFT scripts for IMS VoIP

The N5973A is used in conjunction with Agilent PXT and 8960 wireless communication test sets.

Test plans performing similar functions are grouped together and licensed as a group; for example the Test Plans related to LTE-CDMA InterRAT operations are grouped together and licensed as either N5973A-1FP IFT (InterRAT operations) or N5973A-2FP IFT (InterRAT operations SVD). Those Test Plans related to VoIP operations are grouped together and licensed as N5973A-4FP IFT (IMS VoIP).

In this book, you'll find...

- [System Component Overview](#)
- [Software Installation and Licensing](#)
- [Uninstalling N5973A Software](#)
- [Using the N5973A IFT Wireless Compliance Scripts](#)
- [Directory Structure](#)
- [Settings Files](#)
- [Test Results Storage](#)
- [Software Organization](#)
- [Test Cases](#)
- [Settings File Configuration](#)
- [UE Specific Settings File Configuration](#)
- [Connection Tips](#)
- [Service and Support](#)

2 System Component Overview

This section provides an overview of the components required to setup and use the N5973A Verizon wireless compliance test plan scripts.

Server and Client PC Requirements

An IBM® (or compatible) PC with at least:

- Processor: 1.8 GHz Pentium® Dual Core Processor or better
- Operating System: Microsoft® Windows® XP Professional Service Pack 3 (English version only) or Windows 7 Professional
- Memory: 2 GB RAM
- Hard Disk Space: 2 GB of available hard disk space
- Connection: IP Network Connection (broadband, LAN, and wireless)
- LAN Port (If you are using LAN for your connection.)
- Sound Card: Full-duplex, 16-bit
- 2 USB ports: (2.0 or later)

PXT Scenario Files

The Base Station Emulator in the Agilent E6621A PXT operates on the basis of Scenario Files (for more details, see the Agilent E6621A User's Guide and the Agilent N6062A Message Editor User's Guide). Specific scenario files have been created for use with the Agilent N5973A software and have an lbf file extension.

When the Agilent N5973A is installed these files are located in the following directory:

<[OS Public Agilent](#)>\Agilent\N5972A\TestData\N5973A\Docs\ScenarioFiles

The scenario file you wish to use with the N5973A is defined by the setting: "LteScenarioFile". Refer to the chapter entitled, [UE Specific Settings File Configuration](#) where this setting and others are listed and described. When the test case starts, the scenario file is automatically downloaded from the N5973A *ScenarioFiles* directory (exact location stated above) to the PXT in this directory: D:\Program Files\Agilent\E6621A\LTE-Scenario.

NOTE	If you need to create your own scenario file, it is recommended that you modify the default scenario file included in the N5973A release to match any specific requirements of the particular UE being tested.
-------------	--

Default UE IP Settings for Scenario File

The following settings are the UE default values expected by the N5973A scripts.

Component	IP	Subnet Mask	Gateway	Comments
UE (Assigned by scenario file) (IPv6 Router Solicitation has global prefix of 2001::)	192.168.1.51	N/A	N/A	IMS IPv4 Default Bearer
	021F:29FF:FE7C:8F51	N/A	N/A	IMS IPv6 Default Bearer
	192.168.1.52	N/A	192.168.1.53	Internet IPv4 Default Bearer
	021F:29FF:FE7C:8F52	N/A	N/A	Internet IPv6 Default Bearer

System Requirements

All required components (and their version numbers) are stated in the "[Hardware and Software Configuration](#)" table below. Note that these components may not be the current shipping versions of these components and that it is important that you use the versions available at the website location shown in this table. Please refer to the N5973A release notes for any further instructions to this regard.

Hardware and Software Configuration

System Component	Software Model and License	Description	Version or later	Download Location
Client PC	N5973A ¹ (1FP, 2FP, and 4FP = software licenses)	IFT Automation Scripts for Verizon Wireless Compliance Test Plans	10.0	www.agilent.com/find/softwaremanager
	N5972A ²	IFT software	6.x	www.agilent.com/find/softwaremanager
	N6061A Protocol Logging	E6621A Protocol Logging (software)	6.4.3.0	www.agilent.com/find/softwaremanager
	E6584A (WPA)	Wireless Protocol Advisor (software)	A.11.04	www.agilent.com/find/softwaremanager
	Agilent IO Libraries	Instrument Control (software)	16.0	www.agilent.com/find/iosuite
	MS Office Excel	Spreadsheet software	2007	www.microsoft.com
	MS Internet Explorer	Web browser	6.0	www.microsoft.com
Server PC	N597X	PC Server (software)	10.0	www.agilent.com/find/softwaremanager
	E6966A-1FP ³	IMS-SIP Server Emulator	6.5	www.agilent.com/find/softwaremanager
	E6966A-2FP ³	IMS-SIP Client Emulator	4.1	
	Wireshark ⁴	Network Protocol Analyzer	1.8	http://www.wireshark.org
E5515E ^{5,6} 8960 (eHRPD)	E6785H	Fast Switching Lab Application (software)	H.01.17	www.agilent.com/find/softwaremanager

**Agilent IFT Automation Scripts
for Verizon Wireless Compliance Test Plans (N5973A)
Installation and User's Guide**

System Component	Software Model and License	Description	Version or later	Download Location
E5515 E ⁶ 8960 (1xRTT)	E6785H	Fast Switching Lab Application (software)	H.01.17	www.agilent.com/find/softwaremanager
PXT (LTE)	E6621A ⁷	PXT Wireless Communication Test Set (hardware and software)	6.4.2.0	www.agilent.com/find/softwaremanager
	N6050A-7FP	LTE FDD Base Station Emulation software (7FP = software license)	N/A	
	N6052A-2FP	LTE enhanced BSE and IP Data test (2FP = software license)	N/A	
	EPC Restart Server ⁸	Evolved Packet Core Restart Server (software)	N/A	<OS Public Agilent>\N5972A\TestData\ N5973A\Docs\EPCFiles\EPCRestartServer
UE	Verizon SIM W004v2	Subscriber Identification Module (SIM)	N/A	Contact Agilent ⁹

Table Footnotes:

1. An active N5973A software and technical support contract is required to access the software manager website (referenced above), together with the login credentials registered by you or your company for activation. See the section on licensing in the **Agilent PXT Wireless Communications Test Set Getting Started Guide** for instructions to activate your STSC.
2. Always use the latest version of the N5972A Interactive Functional Test software.
3. IMS-SIP client and server need to be installed and running before starting any N5973A scripts. (Since you don't need to purchase a license to run this software with the N5973A, these products need to be running in the system in order for the N5973A to auto-license these products for your use.)
4. Wireshark is only required when running the N5973A-4FP Test Cases.
5. When running the N5973A-1FP and N5973A-2FP, you may need to obtain a newer version of the 8960 software than is available on the N5973A website. Please contact your customer support representative by using the information located in the section, *Technical Support* on page [50](#).
6. You can also use the E5515C with 5.8 revision hardware + 8.0 Host Processor or E5515C with 8.0 hardware.
7. An active E6621A software and technical support contract (STSC) is required to access the software manager website (displayed above), together with the login credentials registered by you or your company for activation. See the section on licensing in the **Agilent PXT Wireless Communications Test Set Getting Started Guide** for instructions to activate your STSC.
8. EPC Restart Server can be installed as follow:
 - a. Create a folder entitled "EPCRestartServer" on the PXT desktop and copy the files from the IFT Client PC's EPC Restart Server directory to this new folder.

**Agilent IFT Automation Scripts
for Verizon Wireless Compliance Test Plans (N5973A)
Installation and User's Guide**

- b. On the PXT, create a shortcut to the EPC Restart Server.exe in C:\Documents and Settings\All Users\Start\Programs\Startup
 - c. Reboot the PXT or manually start the EPC Restart Server.exe program
9. You must have the *Verizon* SIM in order to run the N5973A UE tests. These can be purchased from *Gemalto*, if you have permission from *Verizon*.

3 Software Installation and Licensing

This section contains what you should know before you install this product as well as installation instructions.

NOTE	Always check the release notes for the latest information about any known issues and other important information about your product. Release notes are available as part of the software package when you download the latest version from www.agilent.com/find/N5973A_software .
-------------	---

Installation of IFT Scripts and Licenses on the Client PC

When you purchase the Agilent N5973A and N5973AS, you receive a "License Entitlement Certificate". Follow the instructions on this certificate to redeem your license keys for these products. In outline, the procedure is as follows:

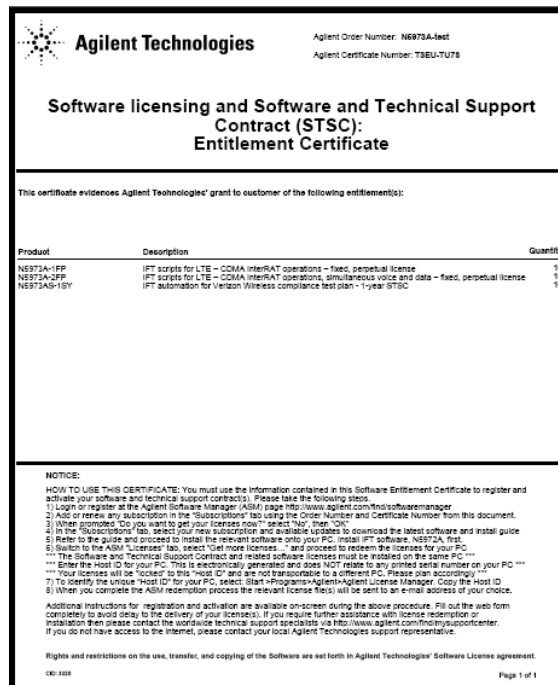

1. Close any applications currently running.
2. Register the STSC (N5973AS) first. This grants access to the latest N5973A Update where you can download the required software as listed in the [Hardware and Software Configuration](#) table, above.
3. Download and install N5972A software. Refer to the [N5972A IFT Help File](#) for detailed instructions.

NOTE	When installing the N5972A on Client PCs using a Windows 7 (64 bit) operating system, verify that Microsoft .NET Framework 3.5.1 feature is turned ON. For instructions to ensure this is set correctly, refer to the N5972A IFT Help File .
-------------	--

Agilent IFT Automation Scripts for Verizon Wireless Compliance Test Plans (N5973A) Installation and User's Guide

4. Identify the Host ID for your PC. This is electronically generated and does NOT relate to any printed serial number on your PC. Refer to the STSC Entitlement Certificate for instructions.
Your licenses are "locked" to this "Host ID" and are not transportable to a different PC.
5. Redeem and install N5973A and N5973AS licenses.
6. Download and install N5973A script software.

NOTE	<p>You must install both the N5973A and N5973AS-licenses on the same PC. Your N5973A license also enables the following software applications:</p> <ul style="list-style-type: none">• Agilent N5972A Interactive Functional Test software.• IMS-SIP Server on the IFT server PC• IMS-SIP Client(s) on the IFT server PC
-------------	--

7. Install N5973A as follows:
 - a. Locate and double-click the previously downloaded N5973A_w_x.exe self-extracting zip file.
Note that "w_x" represent the revision of the software.
 - b. Select "Unzip". If you do not choose "Browse" to change the location where the files are unzipped, they are located here: C:\Temp\N5973A_w_x.
 - c. Close the self-extractor window.
 - d. Open the newly unzipped folder and select "N5973A_Setup.exe".
 - e. A "Welcome to the Agilent N5973A ..." software installation screen now appears. Select "Next" and follow the remaining instructions to complete the installation.
 - f. Your system may be prompted to reboot.
8. If you have not already done so, install the following software products, referring to the installation instructions provided with each component. Use the table, entitled, "[Hardware and Software Configuration](#)" to determine the correct version numbers to be used.
 - a. MS Office Excel
 - b. WPA
 - c. N6061A
 - d. Agilent IO Libraries
9. Enable file sharing between IFT client and server.
 - a. Locate the *TestData* directory as defined in the chapter entitled, "[Directory Structure](#)".
 - b. Rt-click on this folder and configure all sharing settings appropriately in order to enable the IFT Server PC to access and write directly to this folder. The server will be using [\\192.168.1.11\CS](#) to write to this folder.

Valid STSC License Verification

The N5973AS STSC license resides in the Client PC and is tied to the PC Host ID. Before new firmware is downloaded to the PC, the Agilent License Manager verifies that a valid STSC license is present before allowing the firmware to be installed.

If a valid license is not detected, (for example: the original license expired before release of the new firmware) a message, similar to the one below, is displayed, informing you that you cannot install the new firmware. You must then purchase a new license to enable you to install new firmware releases and access technical support.

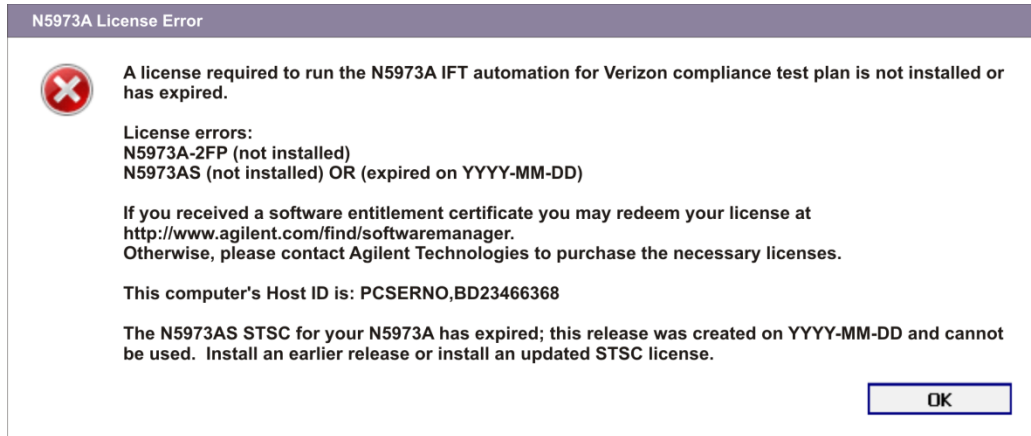

Agilent License Manager Checks for a Valid License

Location of User Data

When installed, IFT creates a storage folder called “Agilent” where user data related to IFT is stored. This folder is located in different places depending upon the operating system of the Client PC. For directory structure details, refer to [Directory Structure](#) on page [30](#).

Installation of Server Applications on the Server PC

Refer to the [Hardware and Software Configuration](#) table to obtain the correct version and location of all required server PC software. If you do not have the indicated version of the software, uninstall the existing version and install the specified version.

1. Download and install the N597X Interactive Functional Test Software Server application for the server PC (no license required). Refer to the [N5972A IFT Help File](#) for detailed instructions.
 - a. The server software must be installed on the C: drive.
 - b. Follow the step-by-step instructions during the software installation.

NOTE	Be sure to select Always connect on FileZilla after the installation is complete.
-------------	---

NOTE	<ul style="list-style-type: none">• You must ensure that no other applications are using port 80 before installing N597X as this will cause the Apache server install to fail.• netstat -ao can be run from a cmd window to check if port 80 is being used.• net stop was /y can be used to stop the Microsoft Internet Information Server, which is the most likely application that will be using port 80.
-------------	--

Agilent IFT Automation Scripts for Verizon Wireless Compliance Test Plans (N5973A) Installation and User's Guide

2. Verify that you can write directly to the *TestData* folder of the Client PC using `\\192.168.1.11\CS`, as detailed above in step, "[Enable file sharing between IFT client and server](#)".
3. Download and install Wireshark onto the Server PC.
 - a. Configure the AMR Codec mode in Wireshark as follows:
 - i. Run Wireshark on the IFT Server.
 - ii. Select **Preferences** from the Wireshark **Edit** menu.
 - iii. Select the [+] beside **Protocols** to expand the list of protocol options.
 - iv. Select **AMR** from the expanded list.
 - v. Set the **Type of AMR encoding of the payload**: to "RFC 3267 BW-efficient".
 - vi. Select **Apply**, then **OK**.
 - vii. Close Wireshark.

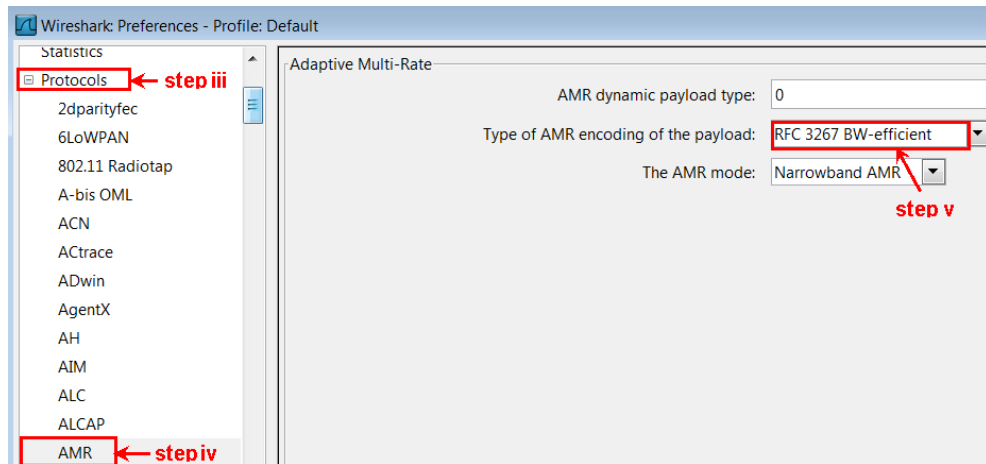

4. Download and install the E6966A IMS-SIP Server (no license required). Refer to the [E6966A Installation Guide](#) for detailed instructions.
5. Download and install the E6966A IMS-SIP Client (no license required). Refer to the [E6966A Installation Guide](#) for detailed instructions.

NOTE	<ul style="list-style-type: none">• After running E6966A Client_Setup.exe, extract the contents of the audio_samples.zip file which was included as part of the downloaded contents of the IMS-SIP Client software.• Copy the "samples" folder and all of its contents to the Public data folder of the IMS-SIP Client located here: C: <OS Public Agilent>\IMS-SIP Client.
-------------	--

**Agilent IFT Automation Scripts
for Verizon Wireless Compliance Test Plans (N5973A)
Installation and User's Guide**

IMPORTANT	<ul style="list-style-type: none">• Verify the client and server are both running before initiating any N5973A scripts. Use the embedded Help file accessed via the drop-down Help menu of the E6966A software to verify the client and server are both running before continuing with this step: Running the N5972A IFT Software and N5973A Wireless Compliance Scripts.
------------------	---

Installation of all other System Components

Use the locations shown in the [Hardware and Software Configuration](#) table, to obtain and install all other components required to run the Agilent N5973A IFT script software.

4 Uninstalling N5973A Software

When Using MS Windows XP

1. Open the **Windows Control Panel**  from the **Start** Menu and select **Add/Remove Programs**.
2. From the **Add/Remove Programs** window, select "Agilent N5973A".
3. Select "Remove" and follow the instructions.

When Using MS Windows 7.0

1. Select the **Start** icon  > **Control Panel** > **Programs and Features**.
2. From the **Uninstall or Change a Program** window, select "Agilent N5973A".
3. Select "Uninstall" and follow the instructions.

5 Using the N5973A IFT Wireless Compliance Scripts

After installing the N5972A IFT and N5973A software as described in [Software Installation and Licensing](#) on page 13, the test hardware and test software needs to be configured. IFT can be configured in many different ways; this section describes only the expected configuration for Verizon Wireless Compliance test plans.

Connecting All System Components

Connect all components as shown below when using the N5973A-1FP and N5973A-2FP test cases. For the N5973A-4FP refer to [Figure 5-2](#), below.

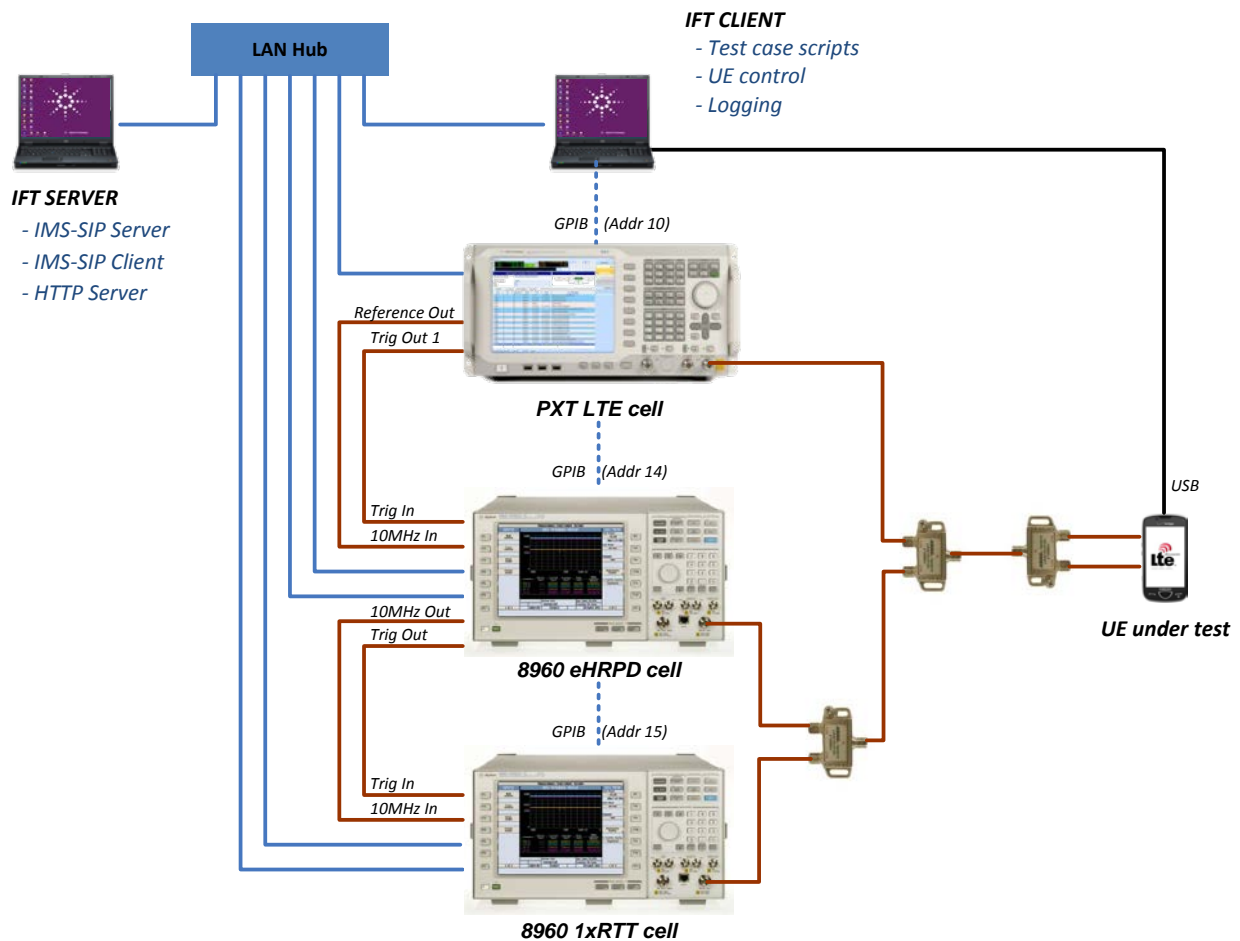

Figure 5-1: Test Configuration for N5973A-1FP and N5973A-2FP

**Agilent IFT Automation Scripts
for Verizon Wireless Compliance Test Plans (N5973A)
Installation and User's Guide**

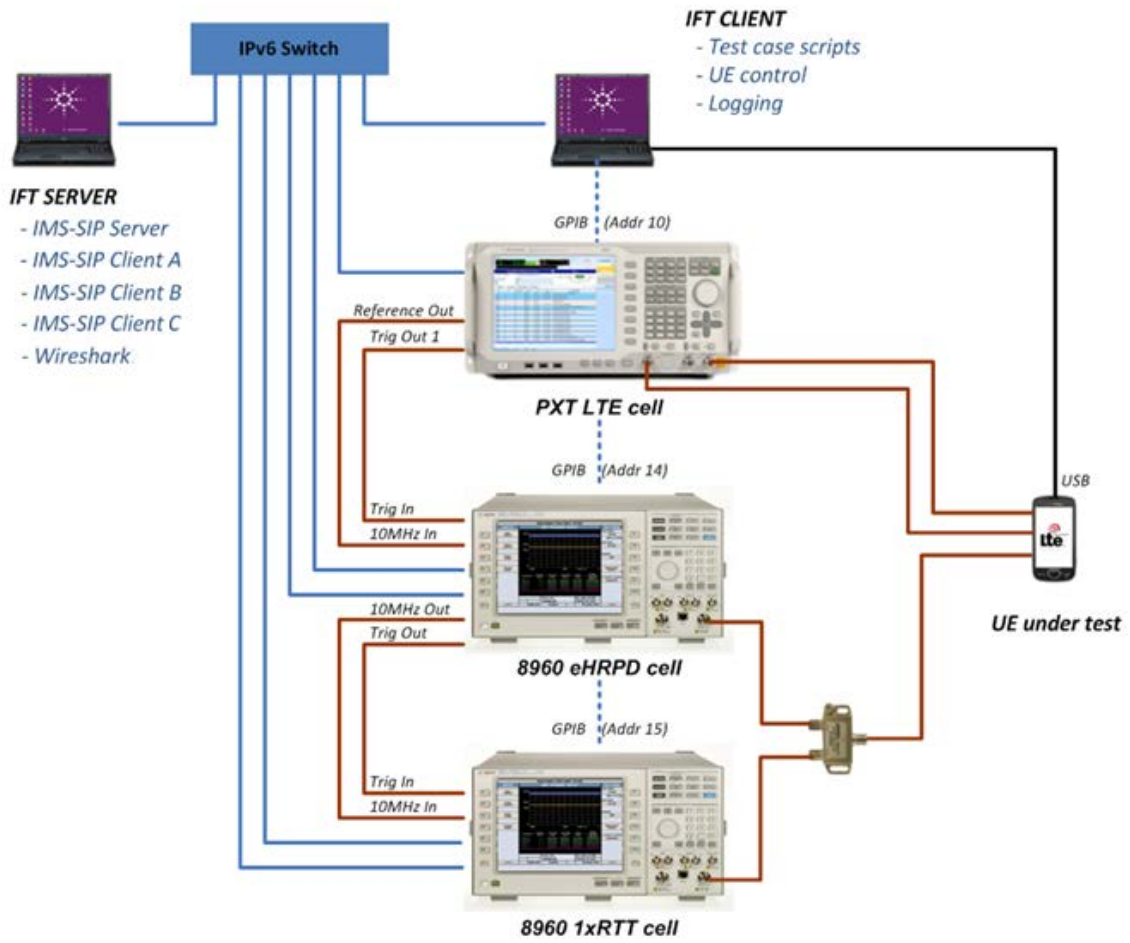

Figure 5-2: Test Configuration for N5973A-4FP

Setting Up the Test System

Prior to running N5972A, and accessing the N5973A scripts, make the following settings to the test system.

1. Set the following IP addresses:
 - Client IP Address: 192.168.1.11
 - Server PC IP Address: 192.168.1.230

2. Set the 8960 (eHRPD cell) addresses as follows:
 - GPIB address: 14
 - LAN IP Address: 192.168.1.13
 - LAN IP Address 2 (Data+): 192.168.1.14

3. Set the 8960 (1xRTT cell) addresses as follows:
 - GPIB address: 15
 - LAN IP Address: 192.168.1.16
 - LAN IP Address 2 (Data+): 192.168.1.17

4. Set the E6621A (LTE cell) addresses as follows:
 - GPIB address: 10
 - IP Address: 192.168.1.60
 - Net Mask: 255.255.255.0
 - Gateway: 192.168.1.230

5. Ensure that the scenario file you wish to use is located here:
<[OS Public Agilent](#)>\Agilent\N5972A\TestData\N5973A\Docs\ScenarioFiles and that the UE Setting:
LteScenarioFile defines the scenario file you wish to use. Refer to [PXT Scenario Files](#) and [UE Specific Settings File Configuration](#) for more clarification.

Confirming the Equipment Connections

You need to power up the test system and ensure that the client PC can communicate with the test equipment.

1. Power on all of the test equipment and PCs.
2. When performing the N5973A-4FP Test Cases, you must start the IMS-SIP Server and three IMS-SIP Clients before launching the N5972A IFT software. If you are performing the N5973A-1FP or 2FP Test Cases, you must perform steps a. and b. below, then go to step 3.
 - a. Launch the IMS-SIP Server.
 - b. Launch the IMS-SIP #1 Client. Wait until the user interface is visible. Verify the WCF port is set to 8250 (or for the N5973A-4FP, unique to all other IMS-SIP Client WCF ports).

Agilent IFT Automation Scripts for Verizon Wireless Compliance Test Plans (N5973A) Installation and User's Guide

- c. Launch the IMS-SIP #2 Client. Wait until the user interface is visible. Verify the WCF port is set to 8251 (or unique to all other IMS-SIP Client WCF ports).
 - d. Launch the IMS-SIP #3 Client. Wait until the user interface is visible. Verify the WCF port is set to 8252 (or unique to all other IMS-SIP Client WCF ports).
3. Use the Agilent IO Connection Expert to ensure that the test equipment is properly connected to the client PC.
 - a. To open the IO control menu list, click on the Agilent IO Control icon  in your PC tool tray,
 - b. In the IO Control menu list, select **Agilent IO Connection Expert**. When the Connection Expert opens, it searches for and confirms all equipment is connected properly.
 - c. If any of the items listed in the Instrument I/O on this PC panel indicate a communications failure, correct the problem before proceeding to ensure that the test scripts function properly.

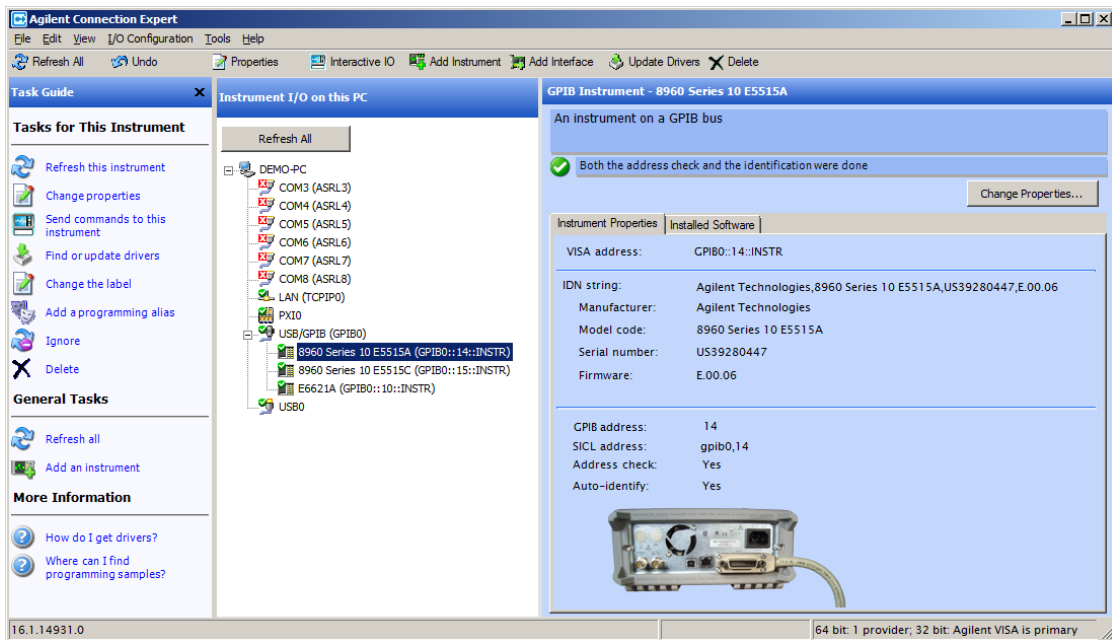

Launch the Software

Start the N5972A IFT application by either by double-clicking on the desktop icon  or from the Windows Start menu by selecting **Start > (All) Programs > Agilent Interactive Functional Tests > N5972A > Applications > N5972A**.

An example of the N5972A user interface with the N5973A scripts installed is shown below.

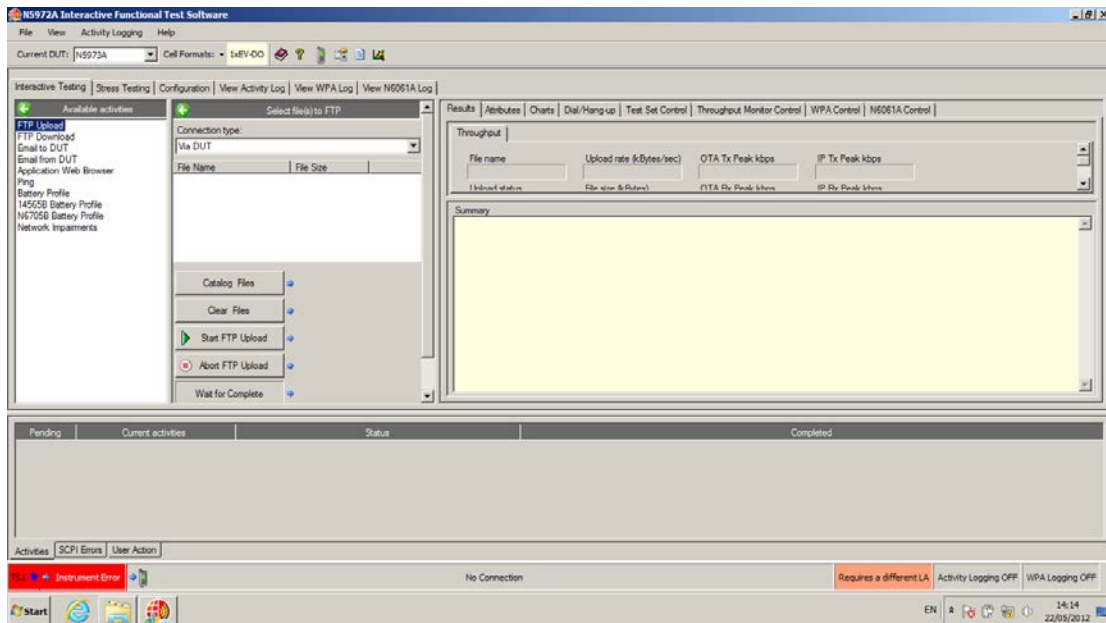

N5972A IFT User Interface

Configuring the N5972A IFT to Use the N5973A Wireless Compliance Scripts

When the N5972A IFT interface opens, you need to configure the software for your test system. The setup configuration includes setting the N5973A as the active performance software and setting the cell format, setting GPIB addresses for the test sets and the power supply, and verifying the connection integrity.

NOTE	It is important that you verify the E6966A client and server are both running before running any scripts. See step 2 of Confirming the Equipment Connections above for more information.
-------------	--

Selecting the N5972A Active Software and Setting the Cell Format

The **Current DUT** setting determines the test scripts available in the **Stress Testing** and **Scripting Tool**, based on the IFT automation script product number.

The Cell **Formats** setting ensures the correct application is loaded on the Test set, and also for filtering and presenting the available test scripts in the **Stress Testing** and **Scripting Tool**.

1. In the **Current DUT** drop-down list, select **N5973A**.

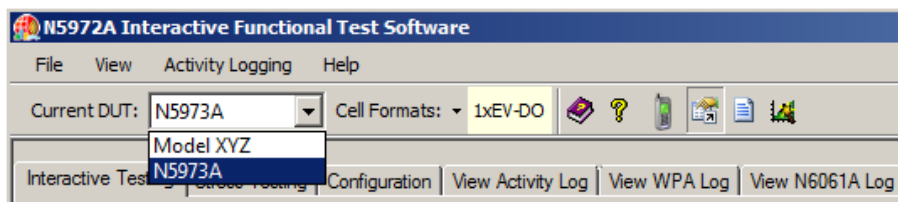

2. In the **Cell Formats** drop-down list, set the **Active Cell** and **Neighbor** formats based on test plan you intend to run.

Setting the Test Equipment Connections

1. Select the **Configuration** Tab.
2. Select **Instrument Control** in the **Available configurations** panel.
3. Set the **GPIB address** to **None** for both **Test set 1** and **Test set 2**
4. Set the **GPIB interface card** value to **0** for both **Test set 1** and **Test set 2**.

NOTE	Steps 3 and 4 above are set to None and 0 because these settings are controlled by the Settings.xml file. It is best now to run the Start-up script as described in section, blah on page blah to create a default Settings.xml file. Then re-start N5972A, verify all steps above are still configured the same and then continue with the instructions below.
-------------	---

5. Uncheck the **Use current LA** boxes for both test sets in the **Test connection** panel.
6. In the **Power Supply** panel, set the following:
 - a. Select the **Interface type** to **GPIB** from the drop-down list.
 - b. Select the **GPIB address** value to **None** from the drop-down list.

- c. Set the **GPIB interface card** value to **0** from the drop-down list.

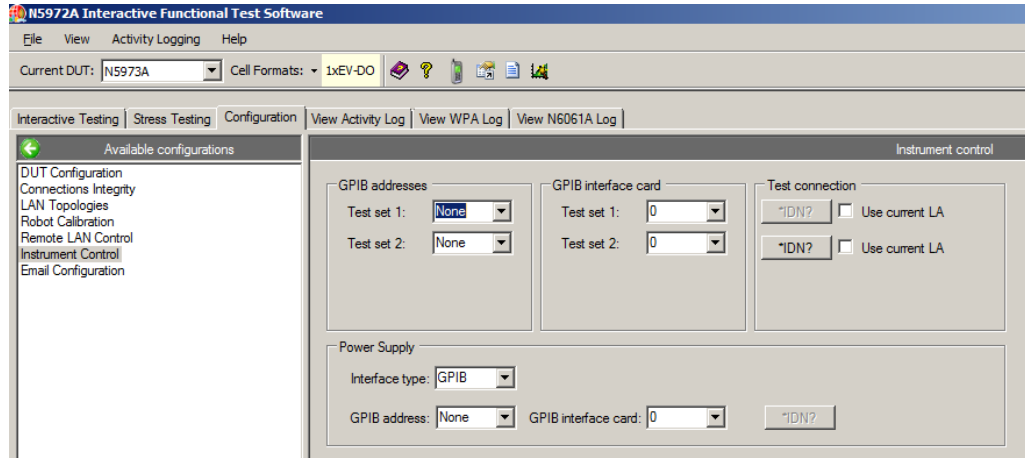

Checking the System Connections Integrity

1. Select the **Configuration** tab.
2. Select **Connections Integrity** in the **Available configurations** panel
3. Click the **Check All Functions** button. Test setup connections are tested and the status indicated in the **Available Integrity Selections** pane.
 - a. A green check “✔” indicates a good connection.
 - b. A red “✘” indicates a failed connection.
4. You can select each item in the **Available Integrity Selections** panel to view in the individual integrity check results.
 - a. Green fields next to a parameter indicate a satisfactory connection, **OK**.
 - b. Red fields next to a parameter indicate a failed connection, **Fail**.
 - c. Yellow fields next to a parameter indicate a connection that is not checked, **Not Checked**.
5. If there are errors, fix them and click **Check All Functions**, wait for all checks to finish.

If there are persistent errors, check with Agilent representative. (Refer to [Service and Support](#) on page 48.)

Agilent IFT Automation Scripts for Verizon Wireless Compliance Test Plans (N5973A) Installation and User's Guide

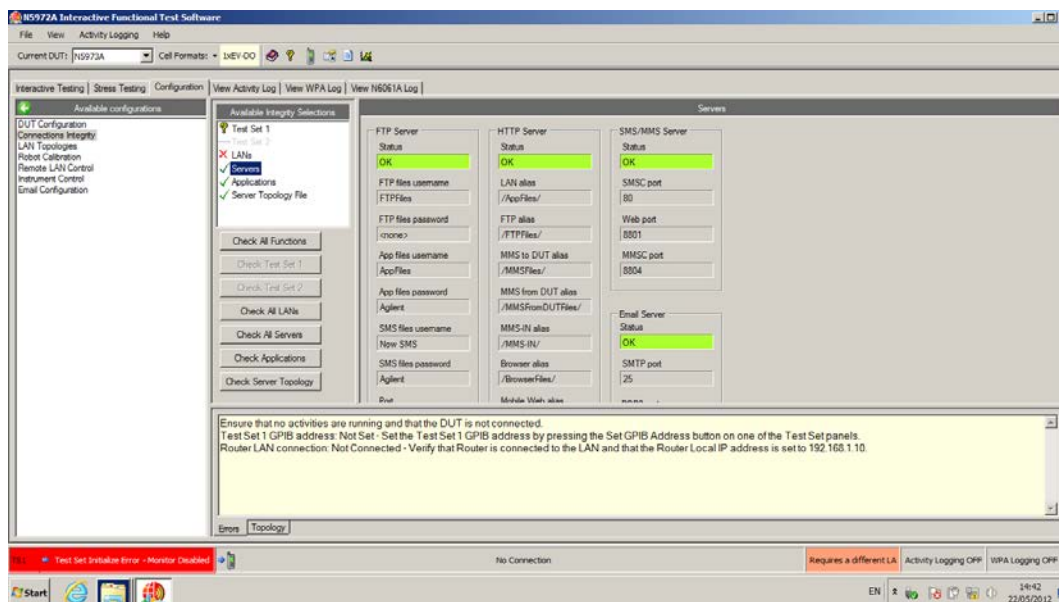

NOTE	Test Set 1 and Test Set 2 integrity checks will fail because they have not been configured. This is correct behavior since the IP addresses for these instruments are determined by the Settings.xml file. See sections about further describing the settings.xml files located on pages 31 , 41 and 43 .
-------------	---

NOTE	LAN integrity checks fail because we are not using a Router.
-------------	--

Running the N5972A IFT Software and N5973A Wireless Compliance Scripts

The N5973A Wireless Compliance test cases can be run in two ways:

1. Create and run an individualized test plan from the N5972A interface by selecting the test cases you wish to run and running them from the interface.
2. Run test cases as single installed test plans using the N5972A Scripting Tool. Using the N5972A Scripting Tool, you may edit the test case scripts to meet your individual needs.

NOTE	When creating a custom test plan, you must always run the <i>Startup</i> test case as the first step and the <i>CleanUp</i> test case as the last step of the test plan.
-------------	--

IMPORTANT	<ul style="list-style-type: none"> • Verify the client and server are both running before initiating any N5973A scripts. Use the embedded E6966A Help file accessed via the drop-down Help menu of the E6966A software (client or server) for instructions.
------------------	--

Running the Wireless Compliance Test Plans with the N5972A IFT Interface

1. To use the N5972A IFT Interface to run a test plan, select the **Stress Testing** tab.
2. Set the test plan in the **Test plan manager** panel by selecting the desired test plan from **Current test plan** drop-down list, for example *LteCdmaInterRat*.
3. To run all of the test cases in the test plan:
 - a. Click the **Run Test Plan** button.
4. To run a custom test plan:
 - a. In the **Current test steps** panel, check the test cases you want to include in your test plan.
 - b. Click the **Run Test Plan** button.

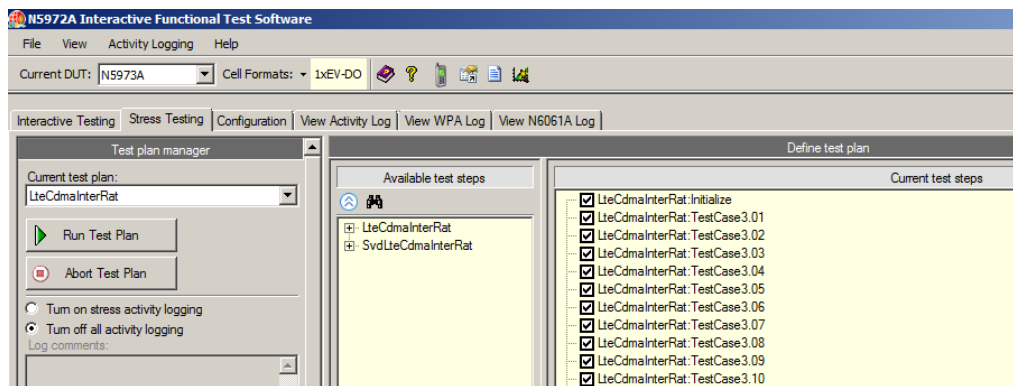

Agilent IFT Automation Scripts for Verizon Wireless Compliance Test Plans (N5973A) Installation and User's Guide

Running the Wireless Compliance Test Cases with the N5972A Scripting Tool

The N5972A Scripting Tool enables you to run individual test cases and to edit the test case code.

CAUTION	<p>Any change you make to the scripts WILL violate conformance to the Compliance Test Plan. Before making any changes to a script, it is strongly recommended that you make a copy of the original script so that it can be recovered.</p> <p><i>If you make any changes to a script, the original script MUST be recovered to restore conformance to the Compliance Test Plan.</i></p>
----------------	---

1. Launch the N5972A Scripting Tool, by clicking the **Scripting tool Show/Hide** icon.

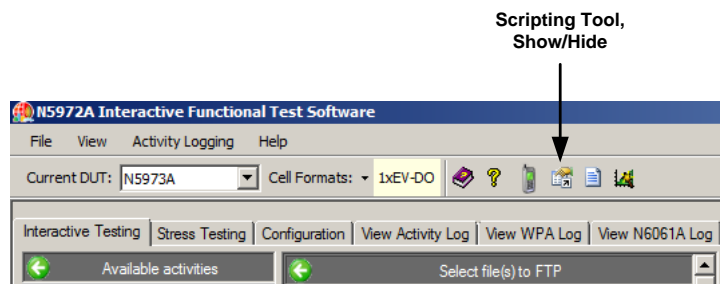

2. If you need to edit any of the script code, do so in the code edit panel.
3. If you want to save the code changes, click on the **Save Code Changes** icon.
4. In the **Control** panel, under the *appropriate* test case list, select *Startup*.
 - a. For the 1FP and 2FP, the appropriate test case list is **LteCdmaInterRat**.
 - b. For the N5973A-4FP, the appropriate test case list is **ImsVoIP**.

NOTE	<p>When creating a custom test plan, you must always run the <i>StartUp</i> test case as the first step and the <i>CleanUp</i> test case as the last step of the test plan.</p>
-------------	---

5. Click the **Run** button.
6. Select the desired test in the **Control** panel.
7. Click the **Run** button. This launches the selected test.
8. Repeat steps 6 and 7 until you have run all of the desired tests.
9. Complete the running of your test by selecting **Cleanup** and click the **Run** button.

Agilent IFT Automation Scripts for Verizon Wireless Compliance Test Plans (N5973A) Installation and User's Guide

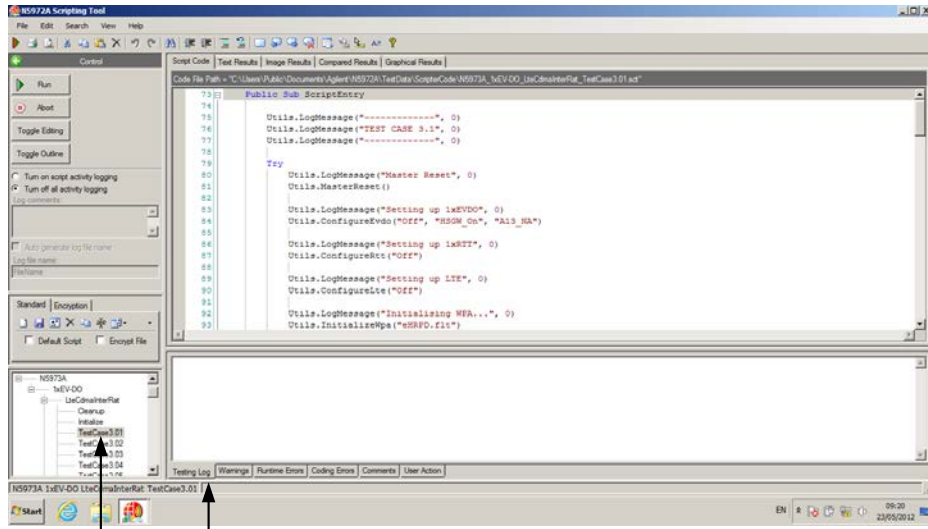

Selected
Test Case

Testing Log
button

Agilent IFT Automation Scripts for Verizon Wireless Compliance Test Plans (N5973A) Installation and User's Guide

6 Directory Structure

When installed, IFT creates a storage folder called "Agilent" where user data related to IFT is stored. This folder is located in different places depending upon the operating system of the Client PC.

Windows 7: C:\Users\Public\Public Documents\Agilent

Windows XP: C:\Documents and Settings\All Users\Shared Documents\Agilent

NOTE	Since the above directory paths are different, this document will reference these "User Data" locations like this: <OS Public Agilent>.
-------------	---

A directory called, "TestData" is created inside this Agilent directory and is located here:

<OS Public Agilent>\N5972A\TestData

Within the "TestData" directory N5973A scripts create a sub-directory called "N5973A", which in turn contains "Docs" and "Results" sub-directories. This "Results" directory contains the output from the Script test run.

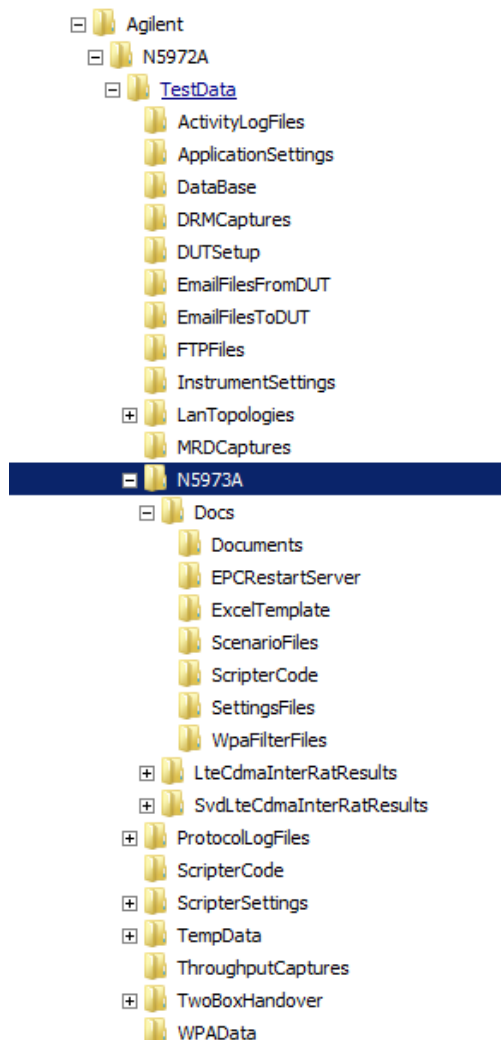

7 Settings Files

Default Settings.xml and UE Specific settings files are *not* generated until the *Startup* test script is first run. The values stated in this file always determine those used in the N5973A. These are modified (using an XML editor) to match your configuration.

The Settings file and UE Specific settings file configurations are shown in the [Settings File Configuration](#) and [UE Specific Settings File Configuration](#) chapters respectively.

1. Launch the N5972A Scripting Tool.
2. Run *Startup* test script to ensure that everything is configured correctly (on the IFT Client PC). If this is the first time to run this script, the Settings.xml files will not exist until.

IMPORTANT	<ul style="list-style-type: none">• Both of the settings.xml files are created when you run the Startup test script for the first time. They do not exist before this event.• If the N5972A is running, it needs to be stopped and restarted in order for the changes to the Settings files to take effect.
------------------	--

3. If necessary, modify the **A8960_GpibInterface** and **Pxt_LTE_GpibAddr** settings and in the Settings.xml file to match your configuration, located here:

<[OS Public Agilent](#)>\N5972A\TestData\N5973A\Docs\SettingsFiles

3. It is also important that you ensure the cable loss settings match your system configuration. Refer to more information about these settings in the [UE Specific Settings File Configuration](#) chapter.
4. When the *Startup* script is run, the following message box is displayed:

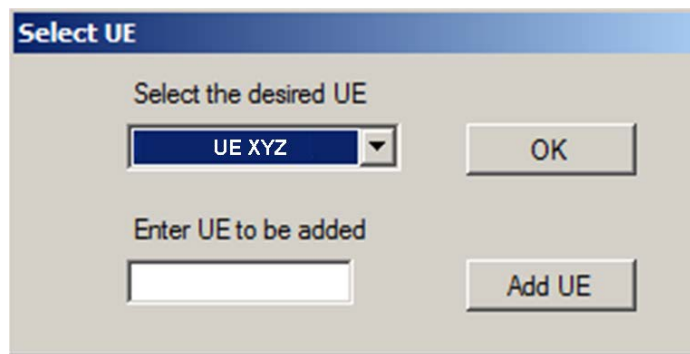

5. Select one of the UEs from the drop down list or add a new UE.

**Agilent IFT Automation Scripts
for Verizon Wireless Compliance Test Plans (N5973A)
Installation and User's Guide**

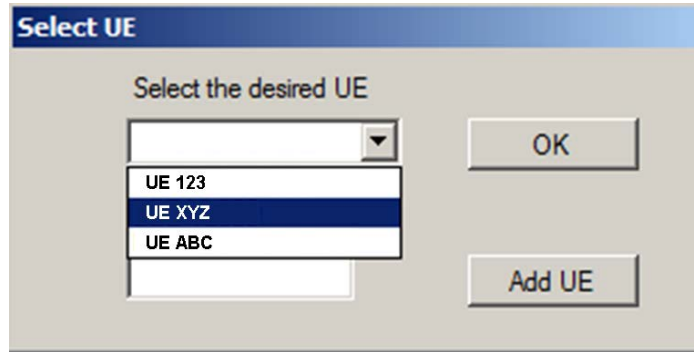

6. If you select **Add UE**, the new UE defined in the **Enter UE to be added** field is added to the drop down list. This list is defined in the **AvailableUe** setting, located in the Settings.xml file.
7. Selecting **OK** generates a default UE-specific settings file for the UE (if one does not already exist) at this location:
`<OS Public Agilent>\N5972A\TestData\N5973A\Docs\SettingsFiles\UE XYZ.xml`
8. After selecting **OK**, the following message box is displayed:

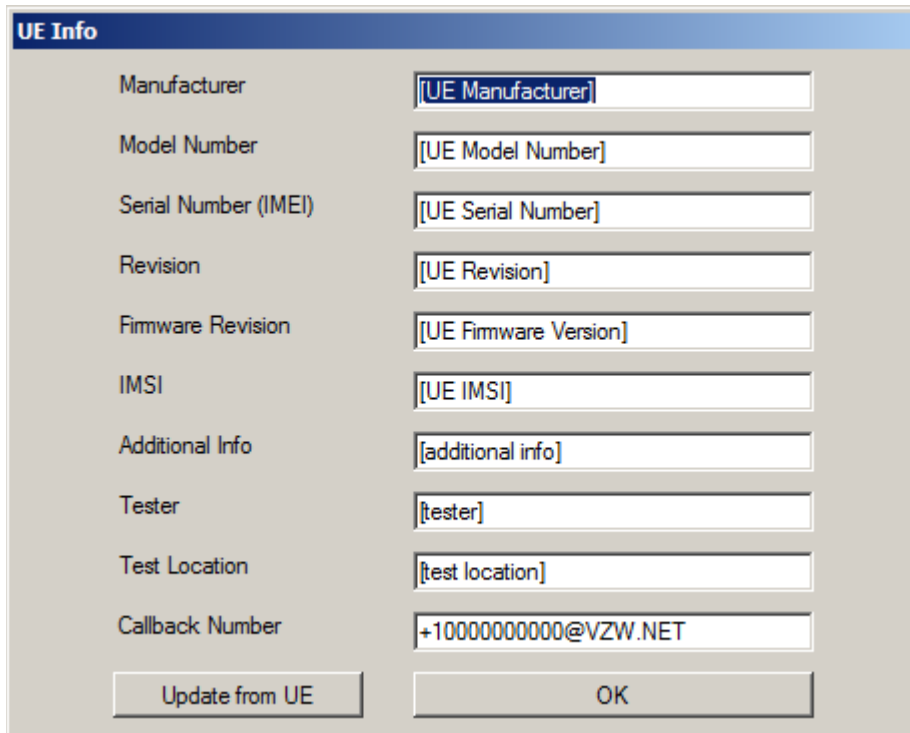

9. If you select **Update from UE**, IFT will attempt to read the Information from the UE, or the default information will be used from the UE specific settings file.
10. If IFT fails to communicate with the UE, the following error is displayed:

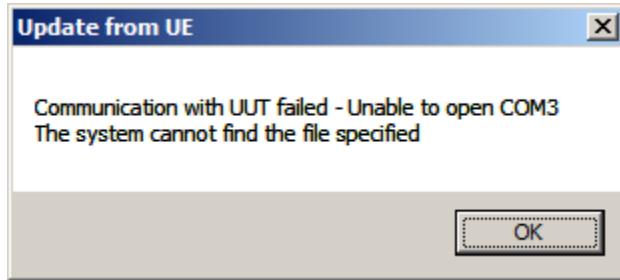

11. Connect the UE to the IFT Client PC and determine the COM port to which it is attached.

Right click on **My Computer** and select **Properties > Hardware > Device Manager > Modems**; then look for the USB connection to the UE Under Test (UUT). The number of this port needs to be added to the setting **UutComPort** in the UE specific settings file, located here:

<[OS Public Agilent](#)>\N5972A\TestData\N5973A\Docs\SettingsFiles

IMPORTANT

- If the N5972A is running, it needs to be stopped and restarted in order for the changes to the Settings files to take effect.

8 Test Results Storage

Introduction

Each test case records the measured values/results in a Test Report.

- Every test plan run stores the following records:
 - Test Report (*.xlsx)
 - Logfile (*.txt)
- Depending upon which test case is executed, the following records may be stored:
 - Agilent E6584A Wireless Protocol Advisor (WPA) log files (*.tol)
 - Agilent N6061A Protocol Logging and Analysis log files (*.ldm)
 - Agilent E6966A IMS-SIP Log files (.sip)
 - Wireshark log files (.ws)

Test Report

An Excel spreadsheet Test Report is created at the start of each test plan run when the *Startup* test is called. The new results spreadsheet file is named "<Wireless Compliance Test_Plan><DateTime>.xlsx". For example, the N5973A-4FP file is named "lmsVoipResults<DateTime>.xlsx".

The Excel spreadsheet is created from a template file located in:

- TestData/N5973A/Docs/ExcelTemplate/LteCdmaInterRatTemplate.xlsx
- TestData/N5973A/Docs/ExcelTemplate/SvdLteCdmaInterRatTemplate.xlsx
- TestData/N5973A/Docs/ExcelTemplate/lmsVoipTemplate.xlsx

The scripts expect the spreadsheet to be in the form of the installed template. Modification of the Excel template may result in corrupt result files or failure to write the results.

Logfile

A text Logfile is created at the start of each test plan run when the *Startup* test is called. The new logfile is named "Logfile_<DateTime>.txt".

This records all of the debug information that is displayed in the IFT window during test.

Storage/Saved File Structure

Refer to [Directory Structure](#) on page 30 for more information. The Results directory contains the output from the Script test run.

Each time the *Startup* test is run a new sub-directory is created within one of the following locations depending upon which test plan you are executing:

N5973A-1FP : <[OS Public Agilent](#)>\N5972A\TestData\N5973A\LteCdmaInterRatResults
N5973A-2FP: <[OS Public Agilent](#)>\N5972A\TestData\N5973A\SvdLteCdmaInterRatResults
N5973A-2FP: <[OS Public Agilent](#)>\N5972A\TestData\N5973A\lmsVoipResults

**Agilent IFT Automation Scripts
for Verizon Wireless Compliance Test Plans (N5973A)
Installation and User's Guide**

The new sub-directory is named "<Wireless Compliance Test_Plan>_<DateTime>". This contains a Test Report (*.xlsx) and a Logfile (*.txt).

Each time a test case is run variations of the different types of logs are saved depending upon the test case that is executed. If a test case is re-tested, then an "Archive" directory is created and the log files are moved to this directory.

9 Software Organization

Introduction

The software is organized into two major blocks:

1. IFT Scripts
2. Compiled Library (DLL/Dynamic Linked Library)

IFT Scripts

The scripts are compatible with the N5972A IFT Scripting Tool. You can run them individually in the IFT Scripting Tool or run them as part of an IFT "Stress Testing" Test Plan.

A separate script is available for each test case, and is named (filename) according to the test case covered. For the details of each test case and names/filenames for each test script, see [Test Cases](#) on page 37.

Two additional scripts are included in each test case; these are named "Startup" and "CleanUp".

Startup

The *Startup* script is run as the first script/step of a Test Plan. It should also be run at the start of a session of running individual test using the N5972A Scripting Tool.

The *Startup* script provides the following functionality:

- Ensures that the results directories are established.
- Creates an Excel spreadsheet Test Report and Logfile.
- Provides a pop-up GUI for selecting UE.
- Creates the Settings.xml files when you run this script for the first time.

CleanUp

The *CleanUp* script is run as the very last script/step of a Test Plan. It is run as the end of a session of running individual tests using the N5972A Scripting Tool.

The *CleanUp* script provides the following functionality:

- Cleans up IFT resources for PXT, both 8960's and UE.
- Resets test equipment.
- Unregisters IMS-SIP client(s).
- The Excel results file is NOT closed down so that the results can be viewed after the test run. The Excel results file needs to be closed manually (it is not necessary to save the file as IFT saves the file during result output).

Compiled Library (DLL/Dynamically Linked Library)

The scripts and the DLL complement each other; the provided scripts cannot be run without the DLL. The DLL is automatically installed by the N5973A installer.

The DLL provides a number of sub-routines and functions which help to keep the scripts small/simple; for example the DLL contains the pop-up GUI for enabling you to enter user variable input. It also helps ensure that those variables remain consistent through all of the scripts in a test plan.

10 Test Cases

The scripts provided in the N5973A IFT Wireless Compliance software run within the “Stress Testing” or “Scripting Tool” provided in the N5972A version of IFT. This enables you to run an individual test or a collection of tests as part of your test plan.

N5973A-1FP Test Cases

Test Case	Test Description
Cleanup	Cleans up IFT resources, resets test equipment and unregisters IMS-SIP Client
Startup	Create Test Report and configure instruments
3.01	Cell Selection due to LTE System Lost – With Previous Session on target eHRPD and Partial HSGW Context Available
3.02	Cell Selection due to LTE System Lost – With Previous Session on source eHRPD and Partial HSGW Context Available – A13 Available
3.03	Cell Selection due to LTE System Lost – With Previous Session on source eHRPD and Partial HSGW Context Available – A13 Not Available
3.04	Cell Selection due to LTE System Lost – With Previous Session on target eHRPD and no Saved Partial HSGW Context
3.05	Cell Selection due to LTE System Lost – With Previous Session on source eHRPD with No Saved Partial HSGW Context – A13 Available
3.06	Cell Selection due to LTE System Lost – With Previous Session on source eHRPD with No Saved Partial HSGW Context – A13 Not Available
3.07	Cell Selection due to LTE System Lost – With No Previous Session on eHRPD
3.08	Cell Reselection – With Previous Session on target eHRPD and Partial HSGW Context Available
3.09	Cell Selection – With Previous Session on source eHRPD and Partial HSGW Context available – A13 Available
3.10	Cell Reselection – With Previous Session on source eHRPD and Partial HSGW Context available – A13 Not Available
3.11	Cell Reselection – With Previous Session on target eHRPD and no Saved Partial HSGW Context
3.12	Cell Reselection – With Previous Session on source eHRPD with No Saved Partial HSGW Context – A13 Available
3.13	Cell Reselection – With Previous Session on source eHRPD with No Saved Partial HSGW Context – A13 Not Available
3.14	Cell Reselection – With No Previous Session on eHRPD
3.15	Cell Selection due to LTE System Lost – With Previous Session on target eHRPD and Partial HSGW Context Available, 1XRTT System Unavailable
3.16	Cell Reselection – With Previous Session on target eHRPD and Partial HSGW Context Available, 1XRTT System Unavailable
4.01	Cell Selection to 1XRTT due to LTE System Lost
4.02	Cell Selection to 1XRTT/HRPD due to LTE System Lost
4.03	Cell Selection to HRPD due to LTE System Lost
5.01	RRC Release with Redirection and Measurement Gaps scheduled – With Previous Session on target eHRPD and Partial HSGW Context Available
5.02	RRC Release with Redirection and Measurement Gaps scheduled – With Previous Session on source eHRPD and Partial HSGW Context available – A13 Available
5.03	RRC Release with Redirection and Measurement Gaps scheduled – With Previous Session on source eHRPD and Partial HSGW Context available – A13 Not Available
5.04	RRC Release with Redirection and Measurement Gaps scheduled – With Previous Session on target eHRPD and no Saved Partial HSGW Context
5.05	RRC Release with Redirection and Measurement Gaps scheduled – With Previous Session on source eHRPD with No Saved Partial HSGW Context – A13 Available
5.06	RRC Release with Redirection and Measurement Gaps scheduled – With Previous Session on source eHRPD with No Saved Partial HSGW Context – A13 Not Available

**Agilent IFT Automation Scripts
for Verizon Wireless Compliance Test Plans (N5973A)
Installation and User's Guide**

Test Case	Test Description
5.07	RRC Release with Redirection and Measurement Gaps scheduled – With No Previous Session on eHRPD
5.08	RRC Release with Redirection No Measurement Gaps scheduled – With Previous Session on target eHRPD and Partial HSGW Context Available
5.09	RRC Release with Redirection No Measurement Gaps scheduled – With Previous Session on source eHRPD and Partial HSGW Context available – A13 Available
5.10	RRC Release with Redirection No Measurement Gaps scheduled – With Previous Session on source eHRPD and Partial HSGW Context available – A13 Not Available
5.11	RRC Release with Redirection No Measurement Gaps scheduled – With Previous Session on target eHRPD and no Saved Partial HSGW Context
5.12	RRC Release with Redirection No Measurement Gaps scheduled – With Previous Session on source eHRPD with No Saved Partial HSGW Context – A13 Available
5.13	RRC Release with Redirection No Measurement Gaps scheduled – With Previous Session on source eHRPD with No Saved Partial HSGW Context – A13 Not Available
5.14	RRC Release with Redirection No Measurement Gaps scheduled – With No Previous Session on eHRPD
6.01	Cell Selection to 1XRTT due to LTE System Lost
6.02	Cell Selection to 1XRTT/HRPD due to LTE System Lost
6.03	Cell Selection to HRPD due to LTE System Lost
7.01	More Preferred System Reselection
7.02	Cell Reselection
7.03	More Preferred System Reselection, 1XRTT System Unavailable
7.04	Cell Reselection, 1XRTT System Unavailable
7.05	Cell Selection Due to eHRPD System Loss
7.06	Cell Selection Due to eHRPD System Loss, 1XRTT System Unavailable
8.01	Cell Selection to LTE due to eHRPD System Loss
8.02	Cell Selection to LTE due to eHRPD System Loss, 1XRTT System Unavailable
9.01	More Preferred System Reselection
9.02	More Preferred System Reselection, 1XRTT System Unavailable

N5973A-2FP Test Cases

Test Case	Test Description
Cleanup	Cleans up IFT resources, resets test equipment and unregisters IMS-SIP Client
Startup	Create Test Report and configure instruments
2.1	Configures SVLTE LTE-CDMA InterRAT Operations tests
2.2.1	Cell Selection to 1XRTT due to LTE System Lost
2.2.2	Cell Selection to 1XRTT/HRPD due to LTE System Lost
2.2.3	Cell Selection to 1XRTT due to LTE System Lost
2.2.4	Cell Selection to 1XRTT/HRPD due to LTE System Lost
3.1	Configures SVDO LTE-CDMA InterRAT Operations tests
3.2.1	Cell Selection to 1XRTT due to LTE System Lost
3.2.2	Cell Selection to 1XRTT/HRPD due to LTE System Lost
3.2.3	Cell Selection to 1XRTT due to LTE System Lost
3.2.4	Cell Selection to 1XRTT/HRPD due to LTE System Lost

N5973A-4FP Test Cases

Refer to the N5973A-4FP release notes (included in the software installation package) for specific information regarding the test plans below.

Test Case	Test Description
Cleanup	Cleans up IFT resources, resets test equipment and unregisters IMS-SIP Client
Startup	Create Test Report and configure instruments
2.1	Basic VoLTE Call Setup
2.3	VoLTE Call Teardown – UE Initiated
2.4	VoLTE Call Teardown – Network Initiated
3.1.2	MT - AMR-WB Enabled in Both Devices
3.1.4	MT - AMR-WB Disabled in Both Devices
3.1.6	MT - AMR-WB Enabled in Originating Device, Disabled in Terminating Device
3.1.7	MO – Complete Audio Path
3.1.8	MT – Complete Audio Path
3.2.1	Received VoIP Call while on Active VoIP Call, and Switching between VoIP Calls
3.2.2	Received VoIP Call while on Active VoIP Call, and Switching between VoIP Calls – Complete Audio Path
3.2.3	On Active VoIP Call, and Other Side Receives Another VoIP Call and Switches between VoIP Calls
3.2.4	On Active VoIP Call, and Other Side Receives Another VoIP Call and Switches between VoIP Calls – Complete Audio Path
3.3.1	Ringling Timer Expired
3.3.2	Ringling Timer Stopped due to Call Answered
3.3.3	Ringling Timer Stopped due to Call Ignored
3.3.4	Ringling Timer Stopped due to Call Cancelled
3.3.5	Ringling Timer Stopped due to Move to eHRPD
3.4.1	Ringback Timer Expired
3.4.2	Ringback Timer Restarted (due to another SIP 180 Ringing) and then Expired
3.4.3	Ringback Timer Stopped due to Call Cancelled
3.4.4	Ringback Timer Stopped due to Called Party Busy
3.4.5	Ringback Timer Stopped due to Called Party Answered
3.4.6	Ringback Timer Stopped due to Move to eHRPD
3.5.1	VoIP Call Waiting
3.5.2	1X Call Waiting
3.5.3	Received VoIP Call while Ringing for 1X Voice Call
3.5.5	Received VoIP Call while One Active VoIP Call and One On-Hold 1X Voice Call
3.5.6	Received VoIP Call while One On-Hold VoIP Call and One Active 1X Voice Call
3.5.7	Received VoIP Call while One Active 1X Call and One On-Hold 1X Voice Call
3.5.8	Received 1X Voice Call while Ringing for VoIP Call
3.5.9	Received 1X Voice Call while Ringing-back for VoIP Call
3.5.10	Received 1X Voice Call while One Active VoIP Call and One On-Hold 1X Voice Call
3.5.11	Received 1X Voice Call while One On-Hold VoIP Call and One Active 1X Voice Call
3.5.12	Received 1X Voice while One Active VoIP Call and One On-Hold VoIP Call
3.6.1	Move to eHRPD while VoIP Call Active
3.6.2	Move to eHRPD while VoIP Call On-Hold
3.6.3	Move to eHRPD while One VoIP Call Active, other VoIP Call On-Hold
3.7.1	RTP-RTCP Inactivity Timer Expires while VoIP Call Active
3.7.2	RTP-RTCP Inactivity Timer Expires while VoIP Call On-Hold
3.7.3	RTP-RTCP Inactivity Timer Expires while One VoIP Call Active, other VoIP Call On-Hold
3.7.4	RTP-RTCP Inactivity Timer Stopped – VoIP Call Ended by Self
3.7.5	RTP-RTCP Inactivity Timer Stopped – VoIP Call Ended by Other
3.8.1	MO - Originating Device Assumes SIP Session Refresher Role
3.8.3	MO – Originating Device is SIP Session Refresher, and Session Expires due to Terminating Device

**Agilent IFT Automation Scripts
for Verizon Wireless Compliance Test Plans (N5973A)
Installation and User's Guide**

Test Case	Test Description
3.8.5	MT – Terminating Device Assumes SIP Session Refresher Role
3.9	IMS Re-Registration when RAN Changes (LTE/eHRPD)
3.10.1	VoIP Call Rejected while on eHRPD
3.10.2	VoIP Cal Rejected while Ringing for a VoIP Call
3.10.3	VoIP Call Rejected while Ringing-Back for a VoIP Call
3.10.4	VoIP Call Rejected while Two VoIP Calls in Progress
3.10.5	VoIP Call Rejected due to Missing SDP
3.10.6	VoIP Call Rejected due to Offered Media Format not Supported
3.11.1	Caller ID not Blocked
3.11.2	Caller ID Blocked
3.12	Mute / Un-Mute
3.15	Received SDP Offer without ptime Attribute
3.16	Received SDP Answer without ptime Attribute

11 Settings File Configuration

The Settings.xml file is located here:

<OS Public Agilent>\N5972A\TestData\N5973A\Docs\SettingsFiles.

The fields that are likely to be changed by the User are indicated in **red**.

IMPORTANT	<ul style="list-style-type: none"> Both of the settings.xml files are created when you run the Startup test script for the first time. They do not exist before this event. If the N5972A is running, it needs to be stopped and restarted in order for the changes to the Settings files to take effect.
------------------	---

Field	Description
A8960_GpibInterface	GPIB Interface of Client PC. Use Agilent IO Libraries to determine how instrument and interface is configured.
A8960_SubnetMask	Subnet Mask setting for both 8960's
A8960_DefaultGateway	Default Gateway address for both 8960's
A8960_1xEVDO_GpibAddr	GPIB address of 8960 (eHRPD Cell)
A8960_1xEVDO_IpAddr	LAN IP address of 8960 (eHRPD Cell) – used for WPA logging
A8960_1xEVDO_IpAddr2	LAN 2 IP address of 8960 (eHRPD Cell) – used for Data connection
A8960_1xRTT_Available	Indicates if 8960 (1xRTT Cell) is connected to system. Set this field to 'False' if only one 8960 is available.
A8960_1xRTT_GpibAddr	GPIB address of 8960 (1xRTT Cell)
A8960_1xRTT_IpAddr	LAN IP address of 8960 (1xRTT Cell) – used for WPA logging
A8960_1xRTT_IpAddr2	LAN 2 IP address of 8960 (1xRTT Cell) – used for Data connection
Pxt_LTE_IpPort Pxt_LTE_IpAddr Pxt_LTE_SubnetMask Pxt_LTE_DefaultGateway	PXT TCP/IP settings
Pxt_LTE_RemoteCtrlsLan	This field is no longer acknowledged as it is obsolete.
Pxt_LTE_GpibAddr	GPIB address of PXT
UutIpAddress1	1 st UUT IPv4 address allocated by 8960 (eHRPD Cell). NOTE: eHRPD addresses are allocated by the EPC, HRPD, & 1xRTT addresses are allocated by

**Agilent IFT Automation Scripts
for Verizon Wireless Compliance Test Plans (N5973A)
Installation and User's Guide**

Field	Description
	the 8960.
UutIpAddress2	2 nd UUT IPv4 address allocated by 8960 (eHRPD Cell).
UutIpAddress3	3 rd UUT IPv4 address allocated by 8960 (eHRPD Cell).
UutIpAddressx	1 st UUT IPv4 address allocated by 8960 (1xRTT Cell).
UutIPv6Address	1 st UUT IPv6 address allocated by 8960 (eHRPD Cell).
ServerIpAddress	IPv4 address of Server PC
ServerIPv6Prefix	8960 IPv6 Router - IPv6 P-CSCF Server Prefix
ServerIPv6Pcscf	8960 IPv6 Router - IPv6 P-CSCF Server IID
ClientIpAddress	IPv4 address of Client PC
TemplateLocation	Location of Test Report template file
TemplateName	Name of Test Report template file
FileLocation	Location of Test Results file
FileName	Name of Test Results file
UseTimestamp	
AdditionalInfo Tester TestDate TestLocation	Used to populate 'UE Info' pop up message during test.
UseLogging	Enables WPA Logging. This should always be set to True
ContinueOnFail	This enables testing to continue if IMS Registration fails, Ping fails, WPA message log fails, etc. However, testing will NOT continue if UE fails to connect to network or fails handover.
DebugMode	Enables Debug Mode i.e. enables Stop On Fail to allow investigation of fail.
AvailableUe	Defines UE's which can be selected from 'Select UE' pop up message during test.

12 UE Specific Settings File Configuration

The UE Specific Settings file is located here:

<OS Public Agilent>\N5972A\TestData\N5973A\Docs\SettingsFiles.

The fields that are likely to be changed by the User are indicated in **red**.

IMPORTANT	<ul style="list-style-type: none"> Both of the settings.xml files are created when you run the Startup test script for the first time. They do not exist before this event. If the N5972A is running, it needs to be stopped and restarted in order for the changes to the Settings files to take effect.
------------------	---

Field	Description
UutDeviceName	Connect the UUT to the IFT Client PC and determine the Device Name. This MUST contain enough characters to uniquely identify the UE from the 'Interface List' using the 'route print' command.
UutComPort	Connect the UUT to the IFT Client PC and determine the COM port to which it is attached.
UutBaudRate UutDataBits UutStopBits UutParity UutFlowCtrl	Used to configure UE Hyper Terminal
UutAtCmdxxx	If the value starts with 'MAN%', this indicates that no AT commands are available and you are prompted to perform this step manually. If the value starts with 'AT', this defines the AT command and this step is performed automatically. If the value starts with 'AUTO', this indicates that the step occurs automatically and no control of the UE is necessary, so test execution continues.
UutAtCmdTest	Used to confirm that we can send AT commands to UE
UutAtCmdResetDevice	Used to Reset the UE
UutAtCmdConnectToLte UutAtCmdConnectToEvdo UutAtCmdCheckForNetwork	Used to connect UE to required Network
UutAtCmdDisconnectFromLte UutAtCmdDisconnectFromEvdo	Used to disconnect UE from required Network

**Agilent IFT Automation Scripts
for Verizon Wireless Compliance Test Plans (N5973A)
Installation and User's Guide**

Field	Description
UutAtCmdSetDestinationAddress UutAtCmdSendTestMessage	Used to send SMS to UE
PingFromServer	This enables Ping from the Server PC to the UE. This requires Interactive Function Test UDP Server version 10.0 (or later) to be installed on the Server PC. This should be set to 'True' if UE is a phone and not a modem.
LaunchWebBrowserFromUe	This enables Web Browser to be launched from UE. This should be set to 'True' if UE cannot be tethered to USB.
SmsOverIms	If this is set to 'True' the SMS will always be sent via the IMS-SIP Server. However, if this is set to 'False', the SMS will be sent to the 1xRTT cell if it is available.
SmsLocalUserName	This is the UserName of the UE as registered on the IMS-SIP Server. This should include the Domain. For example: +10000000000@VZW.NET
SmsRemoteUserName	This is the UserName of the Server PC IMS-SIP Client as registered on the IMS-SIP Server. This should include the Domain. For example: 5555555555@VZW.NET
SmsRemoteUserName3GPP	This is the UserName of the Server PC IMS-SIP Client as registered on the IMS-SIP Server. This should include the Domain. For example: 5555555555@VZW.NET
SmsTestMessage	This is the SMS message that will be sent from the UE.
LteBand	This sets the band for which all tests are run. It should be set to the band in which the UE operates. The default value is 13.
LteCableLoss¹	This sets the cable loss that you determine exists between the RF ports on the PXT and the UE. NOTE: There is only one value for both ports: RF1 and RF2. It is assumed that the cable loss is the same for these two paths.
Evd0CableLoss¹	This sets the cable loss that you determine exists between the RF ports on the 8960 and the UE.
RttCableLoss¹	This sets the cable loss that you determine exists between the RF ports on the 8960 and the UE.
LteRfAmplitude ¹	This sets the RF Amplitude on the PXT
LteRefLevel ¹	This sets the Reference Level on the PXT
ImsPdnId	This defines the value of the IMS PDN ID configured in the LteScenarioFile.
InternetPdnId	This defines the value of the Internet PDN ID configured in the LteScenarioFile.
LteScenarioFile	This defines which PXT Scenario File is loaded during test (for example: <i>N5973A-4FP.LBMF</i>).

**Agilent IFT Automation Scripts
for Verizon Wireless Compliance Test Plans (N5973A)
Installation and User's Guide**

Field	Description
SimVersion	This defines which SIM is fitted to the UE. The eHRPD Sector ID and the 1xRTT Chanel & System ID values are different with 'W004' and 'W004 V2' SIMs.
UeManufacturer UeModelNumber UeSerialNumber UeRevision UeFirmwareVersion Uelmsi	Used to record UE Information in Test Report.

Table Notes:

- All UE Settings files from previous releases of the N5973A are automatically updated to include these RF amplitude offset settings (cable loss) with the default values specified in the table below. It is recommended that you match all cable loss parameters to those in your current system configuration.

Cellular Format		Default Cable Loss
LTE		
	LteRfAmplitude	-57 dBm
	LteRefLevel	0 dBm
	LteCableLoss	The average of these two calculations: <ul style="list-style-type: none"> The difference between the previous scenario file value for LteRfAmplitude and -57dBm. The difference between the previous scenario file value for LteRefLevel and 0 dBm.
1xEVDO	EvdoCableLoss	18 dB
1xRTT	RttCableLoss	18 dB

13 Connection Tips

GPIB Interface

If the following message is displayed in the Testing Log when running the *Startup* test script:

“Unable to connect to 8960. Please check connections and re-run test case.”

Verify that the GPIB cables are connected from the IFT Client PC to the test equipment as shown in [Connecting All System Components](#) on page 19.

Verify that the test equipment GPIB addresses are correct, as shown in [Setting Up the Test System](#) on page 21.

Verify that the **A8960_GpibInterface** setting in the Settings.xml file matches your configuration shown in [Confirming the Equipment Connections](#) on page 21.

UUT Com Port

If the following error is displayed when IFT attempts to communicate with the UE:

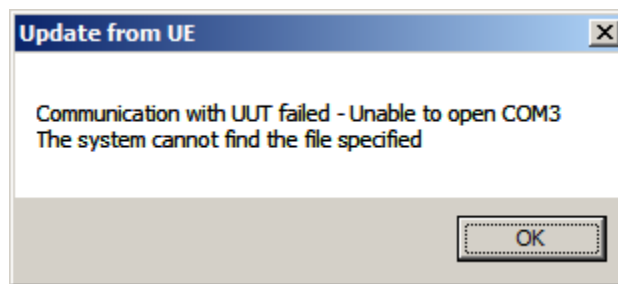

Connect the UE to the IFT Client PC and determine the COM port to which it is attached:

Right click on **My Computer** and select **Properties > Hardware > Device Manager > Modems**; then look for the USB connection to the UUT.

The number of this port needs to be added to the **UutComPort** setting in the UE specific settings file as shown in [UE Specific Settings File Configuration](#) on page 43.

Ping Reply Too Fast

If the test case reports the following diagnostic message (indicating that the Ping response was via the LAN connection and not from the UE):

“Ping reply too fast, UE not connected”

Connect the UE to the IFT Client PC and determine the DEVICE NAME of the UE:

Open a Command Prompt. Type 'route print'. Then, look for the UUT device name in the Interface List.

The first part of this name (for example: LGE) needs to be added to the **UutDeviceName** setting in the UE specific settings file as shown in [UE Specific Settings File Configuration](#) on page 43.

Force Dormant

If the test case reports the following diagnostic message:

“UUT failed to acquire LTE network – Timed out waiting for UUT to go Dormant on EVDO Network”

This is failing because the 8960 (eHRPD cell) is not going Dormant. This must go Dormant for approximately 10 seconds before the PXT (LTE cell) is turned on. If this is not going Dormant, then you need to quiet down the network activity.

Verify that Windows Firewall is turned OFF on both the IFT Client PC and the IFT Server PC.

Launch *Wireshark* and check what activity there is on the Network. Some applications may be continually pinging the network for updates.

14 Service and Support

Calling Agilent Technologies

Agilent Technologies has offices around the world to provide you with complete support for your products. For help, to obtain servicing information, or to order replacement parts, you can call the Agilent customer contact centers nearest you. The customer contact center routes your request to a technical support expert, who contacts you about your support request via phone or email. Local language support is available in many countries.

For the nearest Agilent Technologies office, refer to [Locations for Agilent Technologies](#) on page 49.

In any correspondence or telephone conversations, you need the product number, full serial number, software revision, and any other pertinent contract numbers.

Locations for Agilent Technologies

Online assistance: <http://www.agilent.com/find/assist>

If you do not have access to the Internet, one of these centers can direct you to your nearest representative:

If you have a current STSC, you can contact Agilent at the email addresses listed in [Software and Technical Support Contracts](#).

Americas

Brazil
(11) 4197 3600

Canada
(877) 894 4414

Mexico
01800 5064 800

United States
(800) 829 4444

Asia Pacific

Australia
1 800 629 485

India
1 800 112 929

Malaysia
1 800 888 848

China
800 810 0189

Japan
0120 (421) 345

Singapore
1 800 375 8100

Hong Kong
800 938 693

Korea
080 769 0800

Taiwan
0800 047 866

Other Asian Countries:

www.agilent.com/find/contactus

Europe & Middle East

Belgium
32 (0) 2 404 93 40

Ireland
1890 924 204

Spain
34 (91) 631 3300

Denmark
45 45 80 12 15

Israel
972-3-9288-504/544

Sweden
0200-88 22 55

Finland
358 (0) 10 855 2100

Italy
39 02 92 60 8484

Switzerland
0800 80 53 53

France
0825 010 700*
*0.125 €/minute

Netherlands
31 (0) 20 547 2111

United Kingdom
44 (0) 118 927 6201

Germany
49 (0) 7031 464 6333

Other Unlisted Countries:

www.agilent.com/find/contactus

Software and Technical Support Contracts

Software and Technical Support Contracts (STSC) entitle you to software updates and feature enhancements, as well as direct access to a technical expert for technical support for a fixed period, usually one year.

Software Support

The STSC entitles you to the latest firmware and software releases, which include feature enhancements and defect fixes for the period of the STSC contract.

Access to latest software releases are available from: www.agilent.com/find/N5973A_software

Technical Support

The STSC gives you direct access to technical product experts to increase your productivity and minimize the software difficulties you encounter. These technical support engineers are experts on the Agilent Interactive Functional Test solution and related software products. They have instant access to instruments and software to enable them to resolve your issues as quickly as possible. Agilent investigates all software defects and operational problems reported through the technical support channel. Upon completion of the investigation, we advise you on possible solutions and functional alternatives. Where possible, Agilent provides software releases to address problems caused by defects in the firmware or software.

STSCs for the Agilent N5973A IFT

The N5973AS STSC covers the N5973A software application.

If you have a Software and Technical Support Contract, there are three methods of accessing your technical support:

- [Web-based support](#)
- [E-mail support](#)
- [Phone support](#)

For fastest response times, we recommend using the web-based or email access methods as these provide the most direct route to your technical support expert. All support cases may be viewed and tracked through the online support center (**My Support Center**), regardless of how you initially contacted technical support.



Web-based support

You can directly enter and manage your support requests online via www.agilent.com/find/mysupportcenter.

The first time you use My Support Center you are asked to create a profile and provide proof of entitlement. Once your profile is created, you can use the online support center to enter your support request.

Each support request is given a unique case number which you can use to track the progress of your support case. A technical expert contacts you via phone or email (whichever you have stated as your preferred option) to resolve your issue.

English, Japanese, Korean, and Mandarin local language support is available.

E-mail support

You can also contact our technical support at the following e-mail addresses:

- wireless_test_support_americas@agilent.com
- wireless_test_support_japan@agilent.com
- wireless_test_support_europe@agilent.com
- wireless_test_support_asia@agilent.com
- wireless_test_support_korea@agilent.com

Your support request is routed to a technical expert who contacts you via e-mail or phone (whichever you have stated as your preferred option) to help resolve your issue.

English, Japanese, Korean, and Mandarin local language support is available.

Phone support

If you prefer to speak to someone directly, you can call the Agilent customer contact centers. For the nearest Agilent Technologies office, refer to [Locations for Agilent Technologies](#) on page 49.

The customer contact center will route your request to a technical support expert, who will contact you about your support request via phone or email. Local language support is available in many countries.

In any correspondence or telephone conversations, you need the product number, full serial number, software revision, and any other pertinent contract numbers.

Licensing and Software Compatibility

The N5973AS STSC license resides in the Client PC and is tied to the PC Host ID. Before new firmware is downloaded to the PC, the firmware installer will check that a valid STSC license is present before allowing the firmware to be installed.

If the installer does not detect a valid license, for example, the original license expired before the release of the new firmware; it will display a message, similar to the one below, informing you that you cannot install the new firmware. You must then purchase a new license to enable you to install new firmware releases and access technical support.

Agilent IFT Automation Scripts for Verizon Wireless Compliance Test Plans (N5973A) Installation and User's Guide

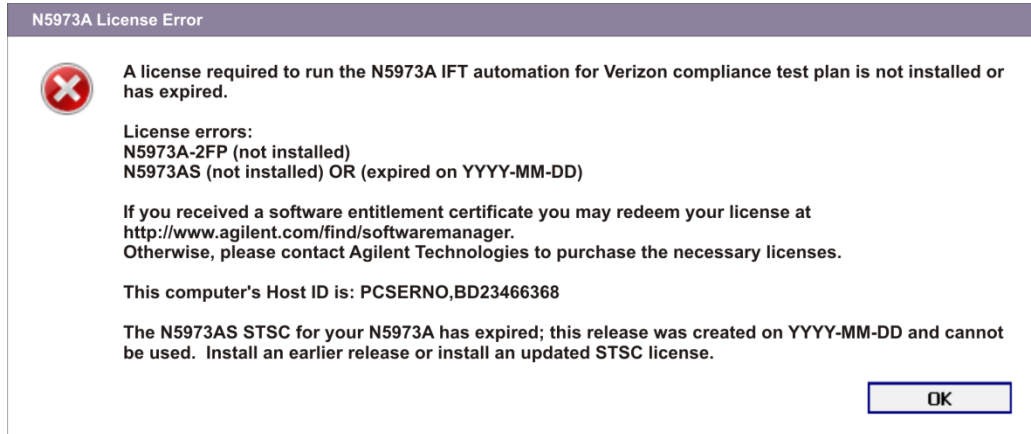

Agilent License Manager Checks for a Valid License

Renewals

You will be notified 90 days prior to the expiration date of the N5973AS-1SY STSC license, by a pop-up window in the N5973A software.

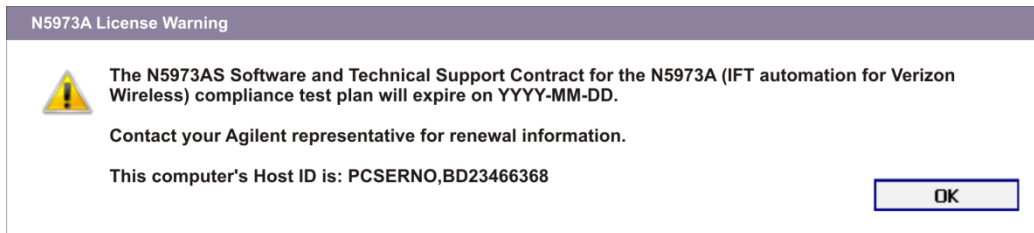

Expiration Warning of N5973A STSC

If you do not renew your N5973A STSC license before its expiration date, you will receive a message, similar to the following one, in the N5973A software.

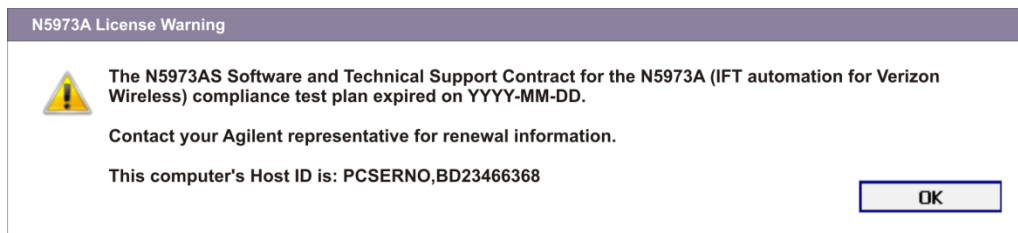

Expired N5973A STSC License

You can continue to use existing software after your STSC has expired, but you will not be able to install N5973A software releases created after this expiration date, or access technical support, until a new STSC license is installed.

