RP7900 Series Regenerative Power System

RP7931A, RP7932A, RP7933A, RP7935A, RP7936A

RP7941A, RP7942A, RP7943A, RP7945A, RP7946A

RP7951A, RP7952A, RP7953A, RP7961A, RP7962A, RP7963A

SD1000A Safety Disconnect System

Legal and Safety Information	9
Legal Notices	9
Safety Symbols	11
Safety Notices	12
1 Quick Reference	15
Introduction to the Instrument	16
Regenerative Power System at a Glance	16
Front Panel at a Glance	17
Rear Panel at a Glance	18
Front Panel Display at a Glance	19
Front Panel Keys at a Glance	20
Front Panel Menu Reference	21
Command Quick Reference	24
Model Features and Options	33
Model Features	33
Options/Accessories	34
Specifications and Characteristics - RP793xA, RP794xA	35
Specifications - RP793xA, RP794xA	35
Supplemental Characteristics - RP793xA, RP794xA	36
Common Characteristics	37
AC Input Efficiency, Power Factor, and THD	39
Output Impedance Graphs	41
Inductive Load Boundary for Constant Current (CC) Operation	43
Capacitive Load Boundary for Constant Voltage (CV) Operation	45
Small Signal Programming Response (All Models)	51
Measurement Accuracy and Resolution - with shorter measurement intervals	51
Excessive Dynamic Protection	52
Output Quadrants	52
Specifications and Characteristics - RP795xA, RP796xA	53
Specifications - RP795xA, RP796xA	53
Supplemental Characteristics - RP795xA, RP796xA	54
Common Characteristics	55
AC Input Efficiency, Power Factor, and THD	56
Output Impedance Graphs	58
Inductive Load Boundary for Constant Current (CC) Operation	59
Capacitive Load Boundary for Constant Voltage (CV) Operation	61
Voltage Programming Response (All Models)	61
Excessive Dynamic Protection	62
Output Quadrants	62
2 Installing the Instrument	63
Before Installation or Use	64
Inspect the Unit	64
Check for Items Supplied	64
Review Safety Information	65
Observe Environmental Conditions	65
Provide Adequate Air Flow	65

Stacking Instruments	65
Outline Diagram for - RP793xA and RP794xA	66
Outline Diagram for - RP795xA and RP796xA	67
Rack Mounting	68
AC Mains Connections	70
AC Mains Considerations	70
Delta and Wye Type AC Distribution Considerations	71
Surge Protector Installation	72
Power Cable Connections	74
Single Unit Output Connections	77
Output Connections	77
Single Load Connections	79
Multiple Load Connections	80
Remote Sense Connections	81
Additional Load Considerations - all Models	83
Additional Load Considerations - RP793xA, RP794xA	84
Multiple Unit Output Connections	87
Parallel Connections	87
Load and Sense Connections	87
Primary/Secondary Connections - for all models	90
Current Sharing Connections - RP795xA, RP796xA	91
Series Connections	92
Interface Connections	93
GPIB Connections	93
USB Connections	94
LAN Connections - site and private	94
Digital Port Connections	95
Interface Cover Installation	96
3 Getting Started	97
Using the Front Panel	98
Turn the Unit On	98
Set the Output Voltage	99
Set the Output Current	100
Set Over-voltage Protection	101
Enable the Output	102
Use Built-in Help System	102
Remote Interface Configuration	103
Introduction	103
USB Configuration	103
GPIB Configuration	103
LAN Configuration	104
Modifying the LAN Settings	105
Using the Web Interface	108
Using Telnet	109
Using Sockets	109
Interface Lockout	109

4 Using the Regenerative Power System	111
Programming the Output	112
Set the Output Priority Mode	112
Set the Output Voltage	113
Set the Output Current	113
Set the Slew Rate	114
Set the Output Resistance	114
Set the Output Bandwidth - RP795xA, RP796xA	115
Set the Output Bandwidth - RP793xA, RP794xA	116
Set the Output Turn-On/Turn-Off Mode - RP793xA, RP794xA	118
Enable the Output	118
Parallel Operation	119
Introduction	119
Primary/Secondary Operation	120
Independent Parallel Operation - RP795xA, RP796xA	124
Current Sinking Operation	127
Current Sinking	127
Regenerative Operation	127
Programming Output Protection	128
Introduction	128
Set the Over-Voltage Protection	130
Set the Over-Current Protection	130
Output Watchdog Timer	131
Set the Under-Voltage Protection	132
Clear Output Protection	133
Programming Output Transients	134
Output Transients	134
Common Actions for All Transients	134
Programming a Step Transient	137
Programming a List Transient	138
Programming an Arbitrary Waveform	142
Limiting Sinusoidal Outputs	144
Sequencing the Output	145
Turn-On/Turn-Off Delays	145
Coupling the Output	145
Sequencing Multiple Units	146
Output Turn-On Turn-Off Behavior	148
External Data Logging	152
External Data Logging	152
Select the Measurement Function and Range	153
Specify the Integration Period	153
Select the Elog Trigger Source	153
Initiate and Trigger the Elog	154
Periodically Retrieve the Data	154
Terminate the Elog	155
Making Measurements	156
Average Measurements	156

Measurement Sweep	156
Measurement Windowing	157
A-hour & W-hour measurement	157
Digitized Measurements	158
Measurement Triggering	160
Programming the Digital Port	166
Digital Control Port	166
Bi-Directional Digital I/O	167
Digital Input	168
External Trigger I/O	168
Fault Output	169
Inhibit Input	169
Fault/Inhibit System Protection	170
Output Couple Control	171
System-Related Operations	172
Instrument Identification	172
Instrument State Storage	172
Front Panel Display	173
Front Panel Lock-Out	173
Password Protection	174
Clock Setup	174
Priority Mode Tutorial	175
Voltage Priority	175
Current Priority	176
5 SCPI Programming Reference	179
Related Software	180
SCPI Introduction	181
Introduction	181
Keywords	182
Queries	182
Command Separators and Terminators	182
Syntax Conventions	183
Parameter Types	184
Device Clear	185
Typical Command Processing Times	185
Commands by Subsystem	187
ABORt Subsystem	188
ARB Subsystem	189
CALibrate Subsystem	191
CURRent Subsystem	195
DIGital Subsystem	199
DISPlay Subsystem	201
FETCh Subsystem	202
FORMat Subsystem	205
FUNCTion Command	206
HCOPy Subsystem	207
IEEE-488 Common Commands	208

INITiate Subsystem	213
INSTrument Subsystem	214
LIST Subsystem	216
LXI Subsystem	219
MEASure Subsystem	220
OUTPut Subsystem	222
POWer Query	228
SENSe Subsystem	229
[SOURce] Subsystem	232
STATus Subsystem	233
STEP Command	237
SYSTem Subsystem	238
TRIGger Subsystem	244
VOLTage Subsystem	247
Status Tutorial	252
Status Registers	252
Operation Status Group	252
Questionable Status Groups	253
Standard Event Status Group	254
Status Byte Register	255
Error and Output Queues	255
Status Diagram	256
Trigger Tutorial	257
Trigger Sources	257
Trigger Destinations	257
Trigger Diagram	258
Reset State (*RST)	259
SCPI Error Messages	264
Compatibility Commands	272
APS code-compatible commands with RPS models	272
APS feature set comparison with RPS models	272
6 Verification and Calibration	275
Test Equipment and Setups	276
Test Equipment	276
Measurement Setups	277
Performance Verification	278
Introduction	278
Verification Setups	280
Test Considerations	280
Verification Procedure	281
Instrument Calibration	286
Introduction	286
Calibration Interval	287
Calibration Setups	287
Test Considerations	288
Calibration Procedure	288
Test Record Forms	292

7 Service and Maintenance	301
Introduction	302
Repair Service Available	302
Before Returning the Unit	302
Repackaging for Shipment	302
Cleaning	303
Self-Test Procedure	304
Power-On Self-Test	304
User-Initiated Self-Test	304
Firmware Update	305
Software Required	305
Update Procedure	305
Restricting Access	305
Instrument Sanitize	306
Calibration Switches	307
Accessing the Calibration Switch	307
Switch Functions	307
Battery Replacement	308
Disassembly	310
Electrostatic Discharge (ESD) Precautions	310
Tools Required	310
Cover Disassembly	310
Control Board Disassembly	311
Constellation Board Disassembly	312
Appendix A Keysight SD1000A Safety Disconnect System	313
Keysight SD1000A Safety Disconnect System	314
Introduction	314
Keysight SD1000A Safety Disconnect System at a Glance	314
Supplemental Characteristics	316
Installing the Keysight SD1000A Safety Disconnect System	318
Keysight SD1000A-to-RP7900 Connections	318
External Control Connections	320
Operating the Keysight SD1000A Safety Disconnect System	323
Controlling the SDS Using the RP7900 series Power Supply	323
Controlling the SDS Using Externally Wired Controls	325
Index	329

Legal and Safety Information

Legal Notices

Safety Symbols

Safety Notices

Legal Notices

© Copyright Keysight Technologies 2017- 2023

Edition 7, April 2023

Update: October 2023

Manual part number RP7900-90901

No part of this manual may be reproduced in any form or by any means (including electronic storage and retrieval or translation into a foreign language) without prior agreement and written consent from Keysight Technologies as governed by United States and international copyright laws.

In this document the terms “master” and “slave” have been replaced with “primary” and “secondary.”

Keysight Technologies
550 Clark Drive, Suite 101
Budd Lake, NJ 07828 USA

Software

This product uses Microsoft Windows CE. Keysight highly recommends that all Windows-based computers connected to Windows CE instruments use current anti-virus software.

The hardware and/or software described in this document are furnished under a license and may be used or copied only in accordance with the terms of such license.

License Files

From gifencode C source code:

* Code drawn from ppmtogif.c, from the pbmplus package Based on GIFENCOD
* by David Rowley <mgardi@watdscu.waterloo.edu>. A Lempel-Zim
* compression based on "compress". Modified by Marcel Wijkstra
* <wijkstra@fwi.uva.nl> Copyright (C) 1989 by Jef Poskanzer. Permission
* to use, copy, modify, and distribute this software and its
* documentation for any purpose and without fee is hereby granted,
* provided that the above copyright notice appear in all copies and that
* both that copyright notice and this permission notice appear in
* supporting documentation. This software is provided "as is" without
* express or implied warranty. The Graphics Interchange Format(c) is the
* Copyright property of CompuServe Incorporated. GIF(sm) is a Service
* Mark property of CompuServe Incorporated. ;

Warranty

The material contained in this document is provided "as is," and is subject to being changed, without notice, in future editions. Further, to the maximum extent permitted by applicable law, Keysight disclaims all warranties, either express or implied, with regard to this manual and any information contained herein, including but not limited to the implied warranties of merchantability and fitness for a particular purpose. Keysight shall not be liable for errors or for incidental or consequential damages in connection with the furnishing, use, or performance of this document or of any information contained herein. Should Keysight and the user have a separate written agreement with warranty terms covering the material in this document that conflict with these terms, the warranty terms in the separate agreement shall control.

Certification

Keysight Technologies certifies that this product met its published specifications at time of shipment from the factory. Keysight Technologies further certifies that its calibration measurements are traceable to the United States National Institute of Standards and Technology, to the extent allowed by the Institute's calibration facility, and to the calibration facilities of other International Standards Organization members

US Government Rights

The Software is "commercial computer software," as defined by Federal Acquisition Regulation ("FAR") 2.101. Pursuant to FAR 12.212 and 27.405-3 and Department of Defense FAR Supplement ("DFARS") 227.7202, the U.S. government acquires commercial computer software under the same terms by which the software is customarily provided to the public. Accordingly, Keysight provides the Software to U.S. government customers under its standard commercial license, which is embodied in its End User License Agreement (EULA), a copy of which can be found at www.keysight.com/find/sweula. The license set forth in the EULA represents the exclusive authority by which the U.S. government may use, modify, distribute, or disclose the Software. The EULA and the license set forth therein, does not require or permit, among other things, that Keysight: (1) Furnish technical information related to commercial computer software or commercial computer software documentation that is not customarily provided to the public; or (2) Relinquish to, or otherwise provide, the government rights in excess of these rights customarily provided to the public to use, modify, reproduce, release, perform, display, or disclose commercial computer software or commercial computer software documentation. No additional government requirements beyond those set forth in the EULA shall apply, except to the extent that those terms, rights, or licenses are explicitly required from all providers of commercial computer software pursuant to the FAR and the DFARS and are set forth specifically in writing elsewhere in the EULA. Keysight shall be under no obligation to update, revise or otherwise modify the Software. With respect to any technical data as defined by FAR 2.101, pursuant to FAR 12.211 and 27.404.2 and DFARS 227.7102, the U.S. government acquires no greater than Limited Rights as defined in FAR 27.401 or DFAR 227.7103-5 (c), as applicable in any technical data.

Waste Electrical and Electronic Equipment (WEEE) Directive 2012/19/EU

The following crossed out wheeled bin symbol indicates that separate collection for waste electric and electronic equipment (WEEE) is required, as obligated by DIRECTIVE 2012/19/EU and other National legislation.













Do not dispose in domestic household waste. Please refer to about.keysight.com/en/companyinfo/environment/takeback.shtml to understand your trade in options with Keysight in addition to product takeback instructions.



Safety Symbols

WARNING A WARNING notice denotes a hazard. It calls attention to an operating procedure, practice, or the like that, if not correctly performed or adhered to, could result in personal injury or DEATH. Do not proceed beyond a WARNING notice until the indicated conditions are fully understood and met.

CAUTION A CAUTION notice denotes a hazard. It calls attention to an operating procedure, practice, or the like that, if not correctly performed or adhered to, could result in damage to the product or loss of important data. Do not proceed beyond a CAUTION notice until the indicated conditions are fully understood and met.

-  Direct current
-  Alternating current
-  Frame or chassis terminal
-  Standby supply. Unit is not completely disconnected from AC mains when switch is off.
-  **WARNING** risk of electric shock
-  **WARNING** refer to accompanying documents
-  Earth ground terminal
-  The CE mark is a registered trademark of the European Community.
- ISM1-A This indicates that the instrument is an Industrial Scientific and Medical Group 1 Class A product (CISPER 11, Clause 4)
- ICES/NMB-001 This indicates product compliance with the Canadian Interference- Causing Equipment Standard.
-  The ETL mark is a registered trademark of Intertek. The text indicates product compliance with the Canadian Interference- Causing Equipment Standard (ICES-001).
-  The RCM mark is a registered trademark of the Australian Communications and Media Authority.
-  Contains one or more of the 6 hazardous substances above the maximum concentration value (MCV), 40 Year EPUP.
-  South Korean Class A EMC Declaration.
This equipment has been conformity assessed for use in business environments. In a residential environment this equipment may cause radio interference. This EMC statement applies to the equipment only for use in business environments.

사용자 안내문

이 기기는 업무용 환경에서 사용할 목적으로 적합성평가를 받은 기기로서 가정용 환경에서 사용하는 경우 전파간섭의 우려가 있습니다.

※ 사용자 안내문은 “업무용 방송통신기자재”에만 적용한다.

Safety Notices

The following general safety precautions must be observed during all phases of operation of this instrument. Failure to comply with these precautions or with specific warnings or instructions elsewhere in this manual violates safety standards of design, manufacture, and intended use of the instrument. Keysight Technologies assumes no liability of the customer's failure to comply with the requirements.

The equipment is for industrial use. Equipment operators are subject to all applicable safety regulations. Along with the warning and safety notices in this manual, all relevant safety, accident prevention, and environmental regulations must also be followed. In particular, the operators of the equipment:

- Must be informed of the relevant safety requirements.
- Must have read and understood the operating manual before using the equipment.
- Must use the designated and recommended safety equipment.

WARNING

General

Do not use this product in any manner not specified by the manufacturer. The protective features of this product may be impaired if it is used in a manner not specified in the operating instructions.

WARNING

Environmental Conditions

Never use the instrument outside of the specified environmental conditions described in the Environmental Characteristics of the specifications.

WARNING

Heavy Weight

Danger to hands and feet. To avoid personal injury and damage to the instrument, always use a sturdy cart or other suitable device to move the instrument. Do not lift the instrument alone; always use two people to lift the instrument.



WARNING

SHOCK HAZARD Ground the Instrument

This product is provided with a protective earth terminal. To minimize shock hazard, the instrument must be connected to the AC mains through a grounded power cable, with the ground wire firmly connected to an electrical ground (safety ground) at the power outlet. Any interruption of the protective (grounding) conductor or disconnection of the protective earth terminal will cause a potential shock hazard that could result in injury or death.

WARNING

Before Applying Power

Verify that all safety precautions are taken. All connections must be made with the unit turned off, and must be performed by qualified personnel who are aware of the hazards involved. Improper actions can cause fatal injury as well as equipment damage. Note the instrument's external markings described under "Safety Symbols".

WARNING

SHOCK HAZARD, LETHAL VOLTAGES Many models generate voltages greater than 60 VDC, with some models rated at 950 VDC! Ensure that all instrument connections, load wiring, and load connections are either insulated or covered using the safety covers provided, so that no accidental contact with lethal voltages can occur.

WARNING

SHOCK HAZARD Never touch cables or connections immediately after turning off the unit. Depending on the model, lethal voltages can remain at the output terminals for several seconds after turn-off. Verify that there is no dangerous voltage on the output or sense terminals before touching them.

WARNING

SHOCK HAZARD from external energy sources.

Because the instrument can be used as a load to sink current, hazardous voltages from an external energy source such as a battery may be present on the output terminals even with the unit turned off. Provision must be made to disconnect the external energy source before touching the output or sense terminals.

WARNING

Do Not Operate in an Explosive Atmosphere

Do not operate the instrument in the presence of flammable gases or fumes.

WARNING

Do Not Remove the Instrument Cover

Only qualified, service-trained personnel who are aware of the hazards involved should remove instrument covers. Always disconnect the power cable and any external circuits before removing the instrument cover.

WARNING

Do Not Modify the Instrument

Do not install substitute parts or perform any unauthorized modification to the product. Return the product to a Keysight Sales and Service Office for service and repair to ensure that safety features are maintained.

WARNING

Fuses

The instrument contains an internal fuse, which is not customer accessible.

WARNING

Cleaning

To prevent electric shock, always disconnect the AC mains before cleaning. Use a dry cloth or one slightly dampened with water to clean the external case parts. Do not use detergent or chemical solvents. Do not attempt to clean internally.

WARNING

In Case of Damage

Instruments that are not functioning correctly, appear damaged or defective should be made inoperative and secured against unintended operation until they can be repaired by qualified service personnel.

1

Quick Reference

Legal and Safety Information

Introduction to the Instrument

Front Panel Menu Reference

Command Quick Reference

Model Features and Options

Specifications and Characteristics - RP793xA, RP794xA

Specifications and Characteristics - RP795xA, RP796xA

This document includes user, service, and programming information for the Keysight Regenerative Power System (RPS) Family.

Documentation, Firmware, and Technical Support

You can download the latest version of this document at www.keysight.com/find/RPS-doc. The latest version is also available for mobile devices at www.keysight.com/find/RPS-mobilehelp.

For the latest firmware revision go to [Firmware Updates](#).

If you have questions about your shipment, or if you need information about warranty, service, or technical support, contact Keysight Technologies.

Contacting Keysight Technologies

Use www.keysight.com/find/assist for information on contacting Keysight worldwide, or contact your Keysight Technologies representative.

Introduction to the Instrument

Regenerative Power System at a Glance

Front Panel at a Glance

Rear Panel at a Glance

Front Panel Display at a Glance

Front Panel Keys at a Glance

Safety Disconnect System at a Glance

Regenerative Power System at a Glance

The Keysight Regenerative Power System (RPS) Family includes 3U rack-mountable DC power supplies with performance and features that are optimized for automated test systems. The output and system features are described as follows. The **Models and Options** section describes the features that apply to specific models.

Output features

- Full programming capability for the entire range of output voltage and current
- Output autoranging for greater flexibility
- Output can operate in voltage priority or current priority mode
- High-speed up and down output programming
- Output resistance programming
- Turn-on/turn-off delays allow output on/off sequencing across multiple units
- Current sharing capability for paralleled outputs
- Protection capability includes over-voltage, over-current, and over-temperature
- Two-quadrant operation provides current sourcing and sinking capability
- 100% rated current-sink capability
- 5 kW and 10 kW rated models

Measurement features

- 5.12 microsecond sample rate
- Real-time power measurements
- A-hour & W-hour measurement
- Digitized measurement capability

System features

- Save and recall up to 10 instrument states in non-volatile memory
- GPIB (IEEE-488), LAN, and USB remote programming interfaces are built in
- Front panel menu setup for GPIB and LAN parameters
- LXI Core 2011 compliant, including a built-in Web server
- SCPI (Standard Commands for Programmable Instruments) compatibility
- Primary/secondary function function allows for composite output control and display from one unit

Regenerative Operation

Regenerative operation is automatic and requires no programming on the part of the user. Whenever the RPS is sinking current, either by rapidly downprogramming the output, or by discharging an energy source such as a battery, the unit will direct the excess power back to the AC mains. You cannot disable the regenerative operation.

During regenerative operation, the power factor of 0.99 is maintained. Sinewave current distortion is less than 2% at full load. This ensures the quality of the AC signal that is returned to the AC mains.

When an AC mains dropout is sensed, galvanic relays disconnect the AC mains and the unit shuts down. To safeguard your device under test, the RPS provides passive anti-islanding that senses that the grid is live before regenerating power back to the grid.

Refer to [AC Mains Considerations](#) for additional information about unit shutdown and restart.

Front Panel at a Glance

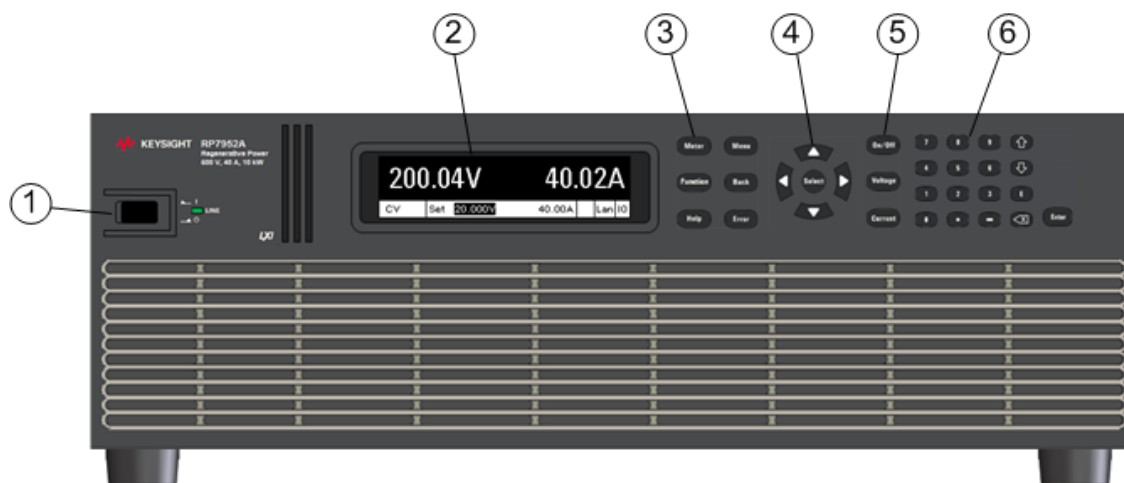

1. **On/Off switch and LED** - LED indicates power is on. Green indicates normal operation. Amber indicates display is in screen-saver mode.
2. **Display** - Turns off after 1 hour of inactivity. Press any key to restore the display.
3. **System keys** - Select metering function. Access front panel command, help, and error menus.
4. **Navigation keys** - Move the cursor to a menu item. Select the highlighted menu item.

1 Quick Reference

5. **Output keys** - Turn the outputs on or off. Enter voltage or current.
6. **Numeric Entry keys** - Enter values. Arrow keys increment or decrement numeric settings.

Rear Panel at a Glance

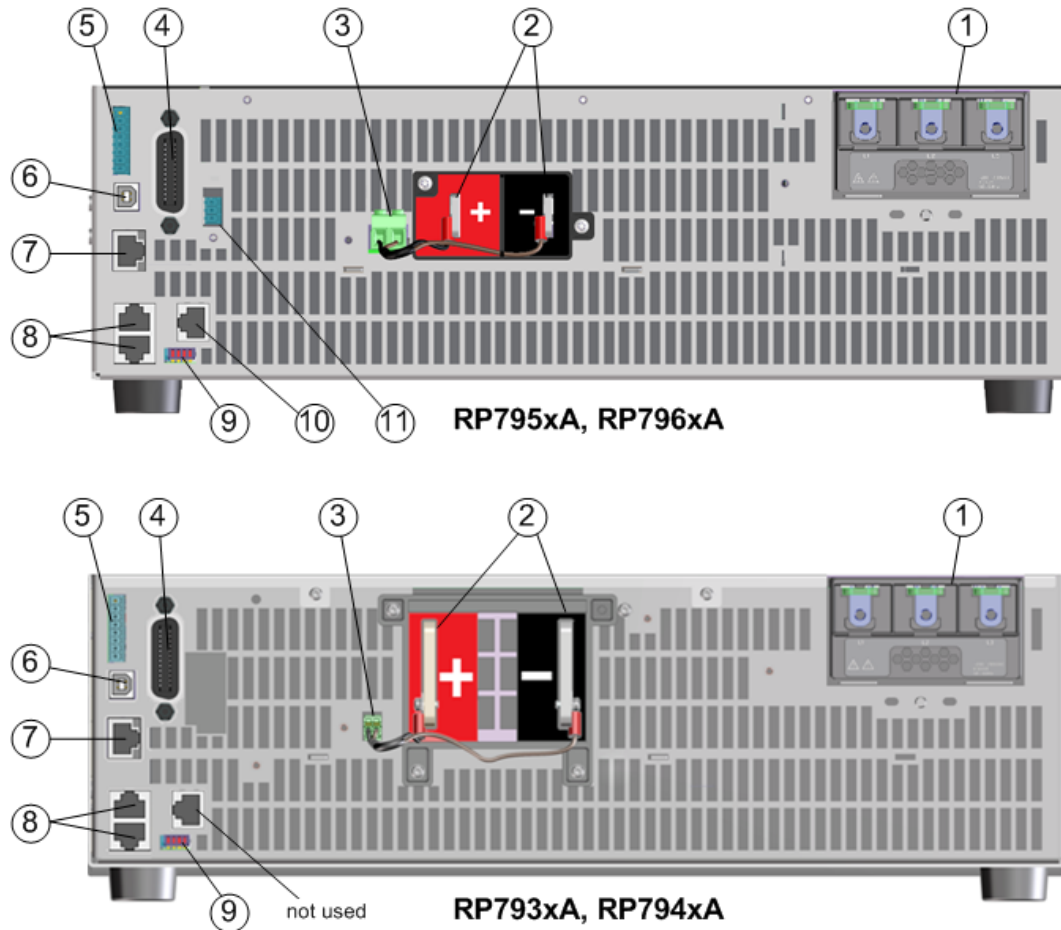

1. **AC input** - 3-phase AC input (L1, L2, L3) with chassis ground. The AC input is bi-directional.
2. **DC outputs** - Positive and negative output terminals.
3. **Sensing** - Remote sense terminals - connected for local sensing.
4. **GPIB** - GPIB interface connector.
5. **Digital IO** - Digital IO connector. Pins are user-configurable.
6. **USB** - USB interface connector.
7. **LAN** - 10/100/1000 Base-T Left LED indicates activity. Right LED indicates link integrity.
8. **Primary/secondary** - Connectors for grouping paralleled units.
9. **Termination switches** - Specifies primary/secondary termination types.
10. **SDS connector** - Keysight SD1000A system connector - for models **RP795xA, RP796xA** only.
11. **Sharing** - Current sharing connector - for models **RP795xA, RP796xA** only.

Front Panel Display at a Glance

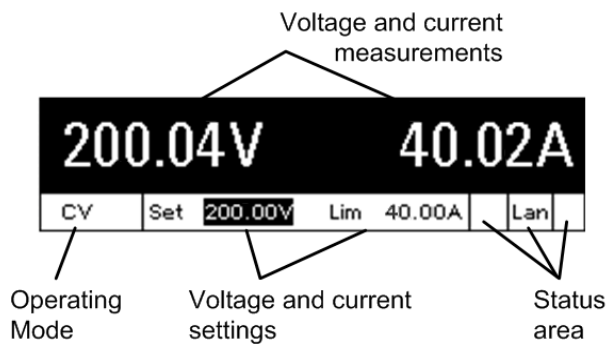

Voltage and current measurements	Displays the actual output voltage and current
Operating mode	<p>Indicates one of the following:</p> <p>OFF = the output is off</p> <p>CV = the output is in constant voltage mode</p> <p>CC = the output is in constant current mode</p> <p>CP+ = the output is disabled by the positive power limit</p> <p>CP- = the output is disabled by the negative power limit</p> <p>VL+ = the output is in positive voltage limit mode</p> <p>CL+/- = the output is in positive or negative current limit mode</p> <p>T-on = the output is turning on</p> <p>T-off = the output is turning off</p> <p>OV = the output is disabled by the over-voltage protection</p> <p>OV- = the output is disabled by the negative over-voltage protection</p> <p>OC = the output is disabled by the over-current protection</p> <p>OT = the over-temperature protection has tripped</p> <p>PF = the output is disabled by a power-fail condition</p> <p>P = the instrument has been paralleled with another instrument</p> <p>Inh = the output is disabled by an external inhibit signal</p> <p>Unr = the output is unregulated</p> <p>Prot = the output is disabled by a protection condition on another unit</p> <p>EDP = the output is disabled by excessive output dynamics protection</p> <p>IPK+/- = the output is in positive or negative peak current limit</p> <p>CSF = a current sharing fault has occurred</p> <p>PSP = a primary/secondary protection has occurred</p> <p>SDP = A safety disconnect system fault has occurred</p> <p>UV = the output is disabled by the under-voltage protection</p> <p>LOV+/- = the output voltage has exceeded a positive or negative internal limit</p> <p>DOV+/- = a DUT-applied voltage has exceeded the positive or negative voltage limit</p> <p>OCF+/- = the positive or negative internal current limits are exceeded - possibly due to a DUT-applied voltage that has exceeded the positive or negative voltage limit</p>
Voltage and current settings	<p>Displays the programmed voltage and current. These settings may not match the measured output voltage or current. For example, in constant voltage operation, the output current setting (limit) may be set to 1 A, but the actual (measured) output current must be less than 1 A for the output to remain in constant voltage mode. If the Current limit is reached, the output will no longer be operating in constant voltage mode, but will be in current limit mode. In this case, the actual output voltage will now be less than the output voltage setting.</p>

Status area	<p>Indicates the following remote interface activity:</p> <p>Err = an error has occurred (press Error key to display error message)</p> <p>Lan = the LAN is connected and has been configured</p> <p>IO = there is activity on one of the remote interfaces</p>
--------------------	---

Front Panel Keys at a Glance

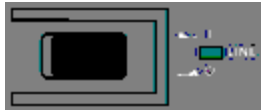

The On/Off switch turns the unit on or off. The LED indicates power is on. **Green** indicates normal operation. **Yellow** indicates that the display is in screen saver mode. The LED is also yellow during the boot-up process. Press any key to exit screen saver mode.



The System keys access the following front panel meter and command menus:

Meter returns the display to metering mode. Also toggles between current and power measurements.

Menu accesses the command menu.

Function key is reserved for future use.

Back backs out of a menu without activating any changes.

Help accesses information about the displayed menu control.

Error displays any error messages in the error queue.

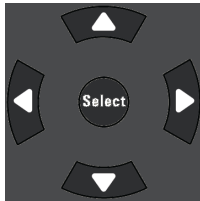

The Navigation keys do the following:

The Arrow keys move around in the command menus. They also select alpha characters in alpha-numeric entry fields.

The Select key lets you make a selection in the command menus. It also lets you enter edit mode for editing the numeric parameters.

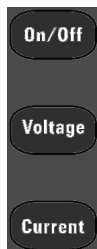

The Output keys do the following:

On/Off controls the output.

Voltage lets you change the voltage setting.

Current lets you change the current setting.



The Numeric entry keys do the following:

The 0 through 9 keys enter numbers.

The (.) key is the decimal point.

The - key is used to enter a minus sign.

The up/down arrow keys increment or decrement voltage or current settings. They also select letters in alphabetic entry fields.

The E key enters an exponent. Add the value to the right of the E.

The Backspace key deletes digits as it backspaces over them.

The Enter key enters a value. If you exit a field without pressing the Enter key, the value is ignored.

NOTE

Press the Help key to get context sensitive help.

Front Panel Menu Reference

Press the **Menu** key to access the front panel menus. For a brief tutorial, refer to **Use the front panel menu**. If a menu item is grayed-out, it is not available for the model that is being programmed.

1st Menu Level	2nd Level	3rd & 4th Levels	Description	
Output	Voltage		Programs output voltage settings	
	Current		Programs output current settings	
	Mode		Programs output priority mode	
	Sequence	Delay		Programs output on/off delay
		Couple		Configures output state coupling
	Advanced	Slew		Programs output current or voltage slew rates
		Resistance		Programs output resistance
		Bandwidth	Current	
	Voltage			Programs voltage bandwidth
		Tmode		Programs output turn-on/turn-off mode
	CurrSharing		Enables/disables output current sharing	
Measure	Sweep		Configures measurement sampling	
	Window		Select measurement window	
	Control		Initiates, triggers, and aborts acquisitions; displays trig state	
	AhWh		Measures or resets amp-hours and watt hours	
Transient	Mode		Selects voltage and current transient modes	
	Step		Configures voltage or current steps and trigger signals	
	List	Pace		Specifies Dwell or Trigger paced list
		Repeat		Specifies number of list repetitions, or continuous list
		Terminate		Specifies list termination conditions
		Config		Configures individual list step settings
		Reset		Aborts the list and resets all list settings
	Arb	Repeat		Specifies number of Arb repetitions, or continuous Arb
		Terminate		Specifies Arb termination conditions
		Config		Configures individual Arb settings

1 Quick Reference

1st Menu Level	2nd Level	3rd & 4th Levels	Description
	TrigSource		Specifies the transient and CD Arb trigger source
	Control		Initiates, triggers, and aborts transients; displays trig state
Protect	OVP		Configures over-voltage protection settings
	UVP		Configures under-voltage protection settings
	OCP		Configures over-current protection settings
	Inhibit		Configures inhibit input mode settings
	WDog		Configures output watchdog protections settings
	Clear		Clears protection conditions and displays output status
States	Reset		Resets all instrument settings to the reset (*RST) state
	SaveRecall		Saves and recalls instrument settings
	PowerOn		Selects the power-on instrument state
System	IO	LAN	Settings View the currently active network settings
			Modify Modify the network configuration (IP, Name, DNS, mDNS, Services)
			Apply Applies the configuration changes and restarts unit
			Cancel Cancels the configuration changes
			Reset Performs an LXI LCI reset of LAN settings and restarts
			Defaults Resets the network to the as-shipped defaults and restarts
		USB	Displays USB identification string
		GPIB	Display or change the GPIB address
		DigPort	Pins Configures the individual digital port pins
			Data Reads/writes data to the digital port
	Groups	Function	Specifies the primary/secondary function
		Primary	Discovers and connects the primary to the secondary units
		Secondary	Specifies the secondary address
	SDS	Status	Returns the connection status of the SD1000A Safety Disconnect System
		Config	Configures the connection to the SDS unit
		Data	Input Reads status data from the digital port of the SDS unit
			Output Sets the state of the external output signals of the SDS unit
	Preferences	Clock	Sets the real-time clock

1st Menu Level	2nd Level	3rd & 4th Levels	Description
		Display	Configures the screen saver and start-up meter view
		LineFreq	Specifies automatic or manual line frequency detection.
		Lock	Locks the front panel keys with a password
Admin	Login		Enter a password to access the Admin functions
	Cal	Vprog	Calibrates voltage programming
		Curr	Calibrates current programming and measurement
		Misc	Calibrates CurrSharing, ResBout, and CurrTC
		Count	View the calibration count
		Date	Saves the calibration date
		Save	Saves the calibration data
	IO		Enables/disables USB, GPIB, and LAN services
	Sanitize		Performs NISPOM secure erase of all user data
	Update		Password protected firmware update
	Password		Changes the admin password
About			Displays model, options, serial number, and firmware

Command Quick Reference

Some [optional] commands have been included for clarity. All settings commands have a corresponding query. See the [Syntax Conventions](#) for SCPI.

ABORt

:ACQuire	Cancels any triggered measurements.
:ELOG	Stops external data logging.
:TRANsient	Cancels any triggered actions.

CALibrate

:COUNT?	Returns the number of times the unit has been calibrated.
:CURRent	
[:LEVel] <value>	Calibrates the current programming and measurement.
:SHARing	Calibrates the Imon signal for paralleled units. (RP795xA, N676xA)
:TC	Calibrates the temperature coefficient. (RP793xA, RP794xA)
:DATA <value>	Enters the calibration value read by the external meter.
:DATE <"date">	Enters the calibration date in nonvolatile memory.
:LEVel P1 P2 P3	Advances to the next level in the calibration.
:PASSword <value>	Sets a numeric password to prevent unauthorized calibration.
:RESistance	
:BOUT	Calibrates the bottom out resistance. RP795xA, RP796xA)
:SAVE	Saves the calibration constants in non-volatile memory.
:STATe 0 OFF 1 ON	Enables or disables calibration mode.
:VOLTage	
[:LEVel] <value>	Calibrates the local voltage programming and measurement.

DISPlay

[:WINDow]	
[:STATe] 0 OFF 1 ON	Turns the front panel display on or off.
:VIEW METER_VI METER_VP METER_VIP	Selects the parameters to display on the front panel.
:SAVer	
[:STATe] 0 OFF 1 ON	Turns the front panel screen saver on or off.

FETCh

[:SCALar]	
:CURRent	
[:DC]? [<start_index>, <points>]	Returns the averaged measurement.
:ACDC?	Returns the RMS measurement (AC + DC).
:HIGH?	Returns the High level of a pulse waveform.
:LOW?	Returns the Low level of a pulse waveform.
:MAXimum?	Returns the maximum or minimum value.
:MINimum?	
:POWer	
[:DC]?	Returns the averaged measurement.

:MAXimum?	Returns the maximum or minimum value.
:MINimum?	
:VOLTage	
[:DC]? [<start_index>, <points>]	Returns the averaged measurement.
:ACDC?	Returns the RMS measurement (AC + DC).
:HIGH?	Returns the High level of a pulse waveform.
:LOW?	Returns the Low level of a pulse waveform.
:MAXimum?	Returns the maximum or minimum value.
:MINimum?	
:AHOur? [IGNORE_OVLD]	Returns the accumulated amp-hours.
:ARRAY	
:CURRent	
[:DC]? [<start_index>, <points>]	Returns the instantaneous measurement.
:POWer	
[:DC]?	Returns the instantaneous measurement.
:VOLTage	
[:DC]? [<start_index>, <points>]	Returns the instantaneous measurement.
:ELOG <maxrecords>	Returns the most recent external datalog records.
:WHOur? [IGNORE_OVLD]	Returns the accumulated watt-hours.

FORMat

[:DATA] ASCII REAL	Specifies the format of the returned data.
:BORDER NORMal SWAPped	Specifies how binary data is transferred.

HCOPY

:SDUMp	
:DATA? [BMP GIF PNG]	Returns an image of the front panel display.
:DATA	
:FORMat BMP GIF PNG	Specifies the format for front panel images returned.

IEEE-488 Common Commands

*CLS	Clear status command.
*ESE <value>	Event status enable command and query.
*ESR?	Event status event query.
*IDN?	Identification Query.
*OPC	Sets the OPC (operation complete) bit in the standard event register.
*OPC?	Returns a 1 to the output buffer when all pending operations complete.
*OPT?	Returns a string identifying any installed options.
*RCL <value>	Recalls a saved instrument state.
*RST	Resets the instrument to pre-defined values that are either typical or safe.
*SAV <value>	Saves the instrument state to one of ten non-volatile memory locations.
*SRE <value>	Service request enable command and query.
*STB?	Status byte query.
*TRG	Trigger command.

1 Quick Reference

*TST?	Self-test query.
*WAI	Pauses additional command processing until all pending operations are complete.

INITiate

[:IMMediate]	
:ACQuire	Initiates the measurement trigger system.
:ELOG	Initiates external data logging.
:TRANsient	Initiates the transient trigger system.
:CONTinuous	
:TRANsient 0 OFF 1 ON	Continuously initiates the transient trigger system.

INSTrument

:GROup	
:FUNction PRIMary/SECondary NONE	Sets the primary/secondary function
:PRIMary	
:CONNect	
[:STATe] 0 OFF 1 ON	Connects the primary to previously discovered secondary units
:DELay <delay>	Specifies an auto-connect delay after power-on
:MODE AUTO MANual	Automatic connect at power-on or by command
:DISCover	Discovers bus connected primary units
:RESet	Reset the primary configuration
:SECondary	
:ADDRes <bus address>	Sets the secondary bus address

LXI

:IDENtify	
[:STATe] 0 OFF 1 ON	Turns the front panel LXI identify indicator on or off.
:MDNS	
[:STATe] 0 OFF 1 ON	Sets the MDNS state

MEASure

[:SCALar]	
:CURRent	
[:DC]?	Takes a measurement; returns the averaged current.
:ACDC?	Takes a measurement; returns the RMS current (AC + DC).
:HIGH?	Takes a measurement; returns the High level of a current pulse.
:LOW?	Takes a measurement; returns the Low level of a current pulse.
:MAXimum?	Takes a measurement; returns the maximum current.
:MINimum?	Takes a measurement; returns the minimum current.
:POWer	
[:DC]?	Takes a measurement; returns the averaged power.
:MAXimum?	Takes a measurement; returns the maximum power.
:MINimum?	Takes a measurement; returns the minimum power.
:VOLTage	

:DC]?	Takes a measurement; returns the averaged voltage.
:ACDC?	Takes a measurement; returns the RMS voltage (AC + DC).
:HIGH?	Takes a measurement; returns the High level of a voltage pulse.
:LOW?	Takes a measurement; returns the Low level of a voltage pulse.
:MAXimum?	Takes a measurement; returns the maximum voltage.
:MINimum?	Takes a measurement; returns the minimum voltage.
:ARRAY	
:CURRent[:DC]?	Takes a measurement; returns the instantaneous current.
:POWer[:DC]?	Takes a measurement; returns the instantaneous power.
:VOLTage[:DC]?	Takes a measurement; returns the instantaneous voltage.

OUTPut

[:STATe] 0 OFF 1 ON	Enables or disables the output.
:COUPlE	
[:STATe] 0 OFF 1 ON	Enables or disables output coupling.
:DOFFset <value>	Sets a delay offset to synchronize coupled output state changes.
:MAX	
:DOFFset?	Returns the delay offset required for this instrument.
:DELay	
:FALL <value>	Sets the output turn-off sequence delay.
:RISE <value>	Sets the output turn-on sequence delay.
:TMODE	
:COUPlE 0 OFF 1 ON	Couples the turn-on and turn-off settings (RP793xA, RP794xA)
[:OFF] LOWZ HIGHZ	Selects the output turn-off mode (RP793xA, RP794xA)
:ON LOWZ HIGHZ	Selects the output turn-on mode (RP793xA, RP794xA)
:INHibit	
:MODE LATChing LIVE OFF	Sets the operating mode of the remote inhibit digital pin.
:PON	
:STATe RST RCL0	Sets the output power-on state.
:PROTection	
:CLEar	Resets the latched protection.
:TEMPerature	
:MARGin?	Returns the margin remaining before the over-temperature trips.
:WDOG	
[:STATe] 0 OFF 1 ON	Enables or disables the I/O watchdog timer.
:DELay <value>	Sets the watchdog delay time.
:RELay	
:LOCK	
[:STATe] 0 OFF 1 ON	Enables or disables the locked relay state of the SD1000A unit.

SENSe

:AHOuR	
:RESet	Resets the amp-hour or watt-hour measurement to zero.
:ELOG	

1 Quick Reference

:FUNction	
:CURRent 0 OFF 1 ON	Enables/disables external current logging.
:MINMax 0 OFF 1 ON	Enables/disables external min/max current logging.
:VOLTage 0 OFF 1 ON	Enables/disables external voltage logging.
:MINMax 0 OFF 1 ON	Enables/disables external min/max voltage logging.
:PERiod <value>	Sets the external datalog integration time.
:FUNction	
:CURRent 0 OFF 1 ON	Enables/disables current measurements.
:VOLTage 0 OFF 1 ON	Enables/disables voltage measurements.
:SWEep	
:NPLCycles <value>	Sets the measurement time in number of power line cycles.
:OFFSet	
:POINTs <value>	Defines the offset in a data sweep for triggered measurements.
:POINTs <value>	Defines the number of points in a measurement.
:TINTerval <value>	Defines the time period between measurement samples.
:WHOur	
:RESet	Resets the accumulated watt-hour measurement.
:WINDow	
[:TYPE] HANNing RECTangular	Selects the measurement window.

[SOURce:]

ARB

:COUNT <value> INfinity	Specifies the number of times the Arb repeats.
:CURRent	
:CDWell	
[:LEVel] <value>{,<value>}<Block>	Specifies the level of each point in the Arb.
:DWELL <value>	Specifies the dwell time of each point in the Arb.
:POINTs?	Returns the number of points in the Arb.
:FUNction	
:TYPE CURRent VOLTage	Specifies either a voltage or current Arb.
:TERMinate	
:LAST 0 OFF 1 ON	Selects the output setting after the Arb ends.

[SOURce:]

CURRent

[:LEVel]	
[:IMMediate]	
[:AMPLitude] <value>	Sets the output current when in current priority mode
:TRIGgered	
[:AMPLitude] <value>	Sets the triggered output current
:BWIDth	
:RANGe 0 1	Sets the current compensation. (RP793xA,RP794xA)
:LEVel 0 1, <value>	Sets the compensation frequency. (RP793xA, RP794xA)
:LIMit	

[:POSitive]		
[:IMMediate]		
[:AMPLitude] <value>		Sets the current limit when in voltage priority mode.
:NEGative		
[:IMMediate]		
[:AMPLitude] <value>		Sets the current limit when in voltage priority mode.
:MODE FIXed STEP LIST ARB		Sets the transient mode.
:PROTection		
:DELay		
[:TIME] <value>		Sets the over-current protection delay.
:STARt SCHange CCTrans		Specifies what starts the over-current protection delay timer.
:STATe 0 OFF 1 ON		Enables or disables the over-current protection.
:SHARing		
[:STATe] 0 OFF 1 ON		Enables or disables current sharing on paralleled units. (RP795xA, RP796xA)
:SLEW		
[:IMMediate] <value> INFinity		Sets the current slew rate.
:MAXimum 0 OFF 1 ON		Enables or disables the maximum slew rate override.
[SOURce:]		
DIGital		
:INPut		
:DATA?		Reads the state of the digital control port.
:OUTPut		
:DATA <value>		Sets the state of the digital control port.
:PIN<1-7>		
:FUNction <function>		Sets the pin function. DIO DINPut FAULt INHibit ONCouple OFFCouple TOUTput TINPut
:POLarity POSitive NEGative		Sets the pin polarity.
:TOUTput		
:BUS		
[:ENABle] 0 OFF 1 ON		Enables or disables BUS triggers on digital port pins.
[SOURce:]		
FUNction CURRent VOLTage		Sets the output regulation - voltage priority or current priority.
[SOURce:]		
LIST		
:COUNt <value> INFinity		Sets the list repeat count.
:CURRent		
[:LEVel] <value>{,<value>}		Specifies the setting for each list step.
:POINts?		Returns the number of list points.
:DWEll <value>{,<value>}		Specifies the dwell time for each list step.
:POINts?		Returns the number of list points.
:STEP ONCE AUTO		Specifies how the list responds to triggers.

1 Quick Reference

:TERMinate	
:LAST 0 OFF 1 ON	Determines the output value when the list terminates.
:TOUTput	
:BOSTep	
: [DATA] <Bool>{,<Bool>}	Generates a trigger out at the Beginning Of Step
:POINTs?	Returns the number of list points.
:EOSTep	
: [DATA] <Bool>{,<Bool>}	Generates a trigger out at the End Of Step
:POINTs?	Returns the number of list points.
:VOLTage	
: [LEVel] <value>{,<value>}	Specifies the setting for each list step.
:POINTs?	Returns the number of list points.

[SOURce:]

POWER

:LIMit?	Returns the output power limit of the instrument
---------	--

[SOURce:]

STEP

:TOUTput0 OFF 1 ON	Specifies whether a trigger out is generated when a transient step occurs.
--------------------	--

[SOURce:]

VOLTage

: [LEVel]	
: [IMMediate]	
: [AMPLitude] <value>	Sets the output voltage when in voltage priority mode.
:TRIGgered	
: [AMPLitude] <value>	Sets the triggered output voltage.
:BWIDTH LOW HIGH1	Sets the voltage compensation (RP795xA, RP796xA)
:RANGe 0 1 2	Sets the voltage compensation. (RP793xA, RP794xA)
:LEVel 0 1 2, <value>	Sets the compensation frequency. (RP793xA, RP794xA)
:LIMit	
: [POSitive]	
: [IMMediate]	
: [AMPLitude] <value>	Sets the voltage limit when in current priority mode.
:LOW <value>	Sets the low-voltage limit. (RP793xA, RP794xA)
:MODE FIXed STEP LIST ARB	Sets the transient mode.
:PROTection	
: [LEVel] <value>	Sets the over-voltage protection level.
:LOW	
: [LEVel] <value>	Sets the low-voltage protection level. (RP793xA, RP794xA)
:DElay <value>	Sets the low-voltage protection delay. (RP793xA, RP794xA)
:STATe 0 OFF 1 ON	Enables or disables low-voltage protection. (RP793xA, RP794xA)
:RESistance	
: [LEVel]	

[:IMMediate]	
[:AMPLitude] <value>	Sets the output resistance level.
:STATe 0 OFF 1 ON	Enables or disables output resistance programming.
:SLEW	
[:IMMediate] <value> INFinity	Sets the voltage slew rate.
:MAXimum 0 OFF 1 ON	Enables or disables the maximum slew rate override.

STATus

:OPERation	
[:EVENT]?	Queries the operation event register.
:CONDition?	Queries the operation condition register.
:ENABle <value>	Sets the operation enable register.
:NTRansiton <value>	Sets the Negative transition filter
:PTRansiton <value>	Sets the Positive transition filter
:PRESet	Presets all Enable, PTR, and NTR registers.
:QUEStionable<1 2>	
[:EVENT]?	Queries the questionable event register.
:CONDition?	Queries the questionable condition register.
:ENABle <value>	Sets the questionable enable register.
:NTRansiton <value>	Sets the Negative transition filter
:PTRansiton <value>	Sets the Positive transition filter

SYSTem

:COMMunicate	
[:LAN TCPip:CONTRol?	Returns the initial socket control connection port number.
[:RLState LOCal REMOte RWLock	Configures the remote/local state of the instrument.
:DATE <yyyy>, <mm>, <dd>	Sets the date of the system clock.
:ERRor?	Reads and clears one error from the error queue.
:LFRequency?	Returns the power-line reference frequency.
:LFRequency	
[:MODE AUTO MAN50 MAN60	Specifies automatic or manual line frequency detection.
:PASSword	
[:FPANel	
[:RESet	Resets the front panel lockout password to zero.
:REBoot	Reboots the instrument to its power-on state.
:SDS	(SDS commands apply to N795xA, N796xA only)
[:CONNect	Connect to the SDS unit.
[:MODE AUTO MANual	Selects the connection mode at power-on.
:DIGital	
[:DATA	
[:INPut?	Reads the SDS digital port signals.
[:OUTPut <value>	Sets the SDS digital output signals.
:ENABle 0 OFF 1 ON	Enables or disables the SDS unit.
:STATus?	Returns the SDS status.

1 Quick Reference

:SECurity	
:IMMEDIATE	Clears all user memory and reboots the instrument.
:SET <block data>	Get and set the instrument state
:TIME <hh>, <mm>, <ss>	Sets the time of the system clock.
:VERSion?	Returns the SCPI version that the instrument complies with.

TRIGger

:ACquire	
[:IMMEDIATE]	Generates an immediate trigger.
:CURrent	
[:LEVel] <value>	Sets the triggered level of the output.
:SLOPe POSitive NEGative	Sets the slope of the signal.
:INDices	
[:DATA]?	Returns the indices where triggers were captured.
:COUnT?	Returns the number of triggers captured during the acquisition.
:SOURce <source>	Selects the trigger source for the acquisition system: BUS CURrent1 EXtErnal PIN<1-7> TRANsient1 VOLTage1
:TOUTput	
[:ENABle] 0 OFF 1 ON	Enables measurement triggers to be sent to a digital port pin.
:VOLTage	
[:LEVel] <value>	Sets the triggered level of the output.
:SLOPe POSitive NEGative	Sets the slope of the signal.
:ARB	
:SOURce <source>	Selects the trigger source for arbitrary waveforms: BUS EXtErnal IMMEDIATE PIN<1-7>
:ELOG	
[:IMMEDIATE]	Generates an immediate trigger.
:SOURce <source>	Selects the trigger source for external data logging: BUS EXtErnal IMMEDIATE PIN<1-7>
:TRANsient	
[:IMMEDIATE]	Generates an immediate trigger.
:SOURce <source>	Selects the trigger source for the transient system: BUS EXtErnal IMMEDIATE PIN<1-7>

Model Features and Options

Model Features

	5 kW Models - 10 kW Models -	RP7931A/RP7941A RP7933A/RP7943A	RP7932A/RP7942A RP7935A/RP7945A	RP7936A/RP7946A	RP7951A/RP7961A RP7952A/RP7962A	RP7953A/RP7963A
Voltage, Current, & Power Ratings	0 to 20 V 0 to ±400 A (5 kW) 0 to ±800 A (10 kW)	0 to 80 V 0 to ±125 A (5 kW) 0 to ±250 A (10 kW)	0 to 160 V 0 to ±125 A (10 kW)	0 to 500 V 0 to ±20 A (5 kW) 0 to ±40 A (10 kW)	0 to 950 V 0 to ±20 A (10 kW)	
3-phase, 200/208 VAC nominal	RP7931A/RP7933A	RP7932A/RP7935A	RP7936A	RP7951A/RP7952A	RP7953A	
3-phase, 400/480 VAC nominal	RP7941A/RP7943A	RP7942A/RP7945A	RP7946A	RP7961A/RP7962A	RP7963A	
2-quadrant source- sink operation	Yes	Yes	Yes	Yes	Yes	Yes
Output autoranging	1.6-to-1	2-to-1	2-to-1	2-to-1	2-to-1	2-to-1
Output lists	Yes	Yes	Yes	Yes	Yes	Yes
Arbitrary waveforms	Yes	Yes	Yes	Yes	Yes	Yes
Adjustable band- width	Voltage & Current	Voltage & Current	Voltage & Current	Voltage only	Voltage only	Voltage only
Parallel operation	Yes	Yes	Yes	Yes	Yes	Yes
Primary/secondary mode	Yes	Yes	Yes	Yes	Yes	Yes
Voltage & current programming	Yes	Yes	Yes	Yes	Yes	Yes
Output resistance programming	Yes*	Yes*	Yes	Yes	Yes	Yes
Voltage & current measurement	Yes	Yes	Yes	Yes	Yes	Yes
Amp-hour, Watt- hour, & power meas- urement	Yes	Yes	Yes	Yes	Yes	Yes
Array readback	Yes	Yes	Yes	Yes	Yes	Yes
Adjustable sampling	Yes	Yes	Yes	Yes	Yes	Yes
External data log- ging	Yes	Yes	Yes	Yes	Yes	Yes

1 Quick Reference

	5 kW Models - 10 kW Models -	RP7931A/RP7941A RP7933A/RP7943A	RP7932A/RP7942A RP7935A/RP7945A	RP7936A/RP7946A	RP7951A/RP7961A RP7952A/RP7962A	RP7953A/RP7963A
Under-voltage protection		Yes	Yes	Yes	No	No
SDS unit available		No	No	No	Yes	Yes

*Requires firmware version B.03.02.1232 and up.

Options/Accessories

Option/Accessory	Description
Option UK6	Commercial calibration with test results data
Keysight SD1000A Option 500 Keysight SD1000A Option 950	Safety Disconnect System - includes redundant power and sense disconnect relays. This accessory requires Option 500 to be used on the 500 V models, and Option 950 to be used on the 950 V models. This accessory cannot be used on the RP793xA and RP794xA models.
Keysight RP7909A	Rack mount and slide kit - for mounting units in 19-inch EIA cabinets
Keysight 1CP108A	Rack mount flange kit with handles
Keysight E3663AC	Basic rail kit for system II Keysight instrument racks

Specifications and Characteristics - RP793xA, RP794xA

Specifications - RP793xA, RP794xA

Supplemental Characteristics - RP793xA, RP794xA

Common Characteristics

AC Input Efficiency, Power Factor, and THD

Output Impedance Graphs

Inductive Load Boundary for Constant Current (CC) Operation

Capacitive Load Boundary for Constant Voltage (CV) Operation

Measurement Accuracy and Resolution

Excessive Dynamic Protection

Output Quadrants

Specifications - RP793xA, RP794xA

Unless otherwise noted, specifications are warranted over the ambient temperature range of 0 to 40°C after a 30-minute warm-up period. Specifications apply at the output terminals, with the sense terminals connected to the output terminals (local sensing).

Specification	RP7931A, RP7941A	RP7932A, RP7942A	RP7933A, RP7943A	RP7935A, RP7945A	RP7936A, RP7946A
DC Ratings					
Voltage source:	0 to 20 V	0 to 80 V	0 to 20 V	0 to 80 V	0 to 160 V
Current source and sink:	0 to ±400 A	0 to ±125 A	0 to ±800 A	0 to ±250 A	0 to ±125 A
Power:	0 to ±5 kW	0 to ±5 kW	0 to ±10 kW	0 to ±10 kW	0 to ±10 kW
Output ripple & noise					
CV peak-to-peak: ¹	30 mV	80 mV	30 mV	80 mV	200 mV
CV rms: ²	3 mV	8 mV	3 mV	8 mV	20 mV
Load regulation					
Voltage:	1 mV	3 mV	1 mV	3 mV	6 mV
Current:	25 mA	13 mA	50 mA	25 mA	13 mA
Voltage programming & measurement accuracy ³					
	0.02% + 2 mV	0.02% + 8 mV	0.02% + 2 mV	0.02% + 8 mV	0.02% + 16 mV
Current programming & measurement accuracy ³					
	0.04% + 45 mA	0.03% + 13 mA	0.04% + 90 mA	0.03% + 25 mA	0.03% + 13 mA
Transient response ⁴					
Recovery Time:	300 μs	300 μs	300 μs	300 μs	300 μs
Settling band:	0.2 V	0.8 V	0.2 V	0.8 V	1.6 V

¹ From 20 Hz to 20 MHz (-3dB bandwidth) with resistive load, terminals ungrounded, or either terminal grounded

² From 20 Hz to 10 MHz (-3dB bandwidth) with resistive load, terminals ungrounded, or either terminal grounded

³ Percent of value + offset; at 25°C ±5°C after a 30 minute warm-up; measurement NPLC=1; valid for 1 year, see [Calibration Interval](#); with a load lead voltage drop of up to 1V per lead - see [Wire Size](#) for additional information about load lead voltage drop

⁴ Time to recover to within the settling band following a step change of 50% of the rated current with a 35 μs current rise time

Supplemental Characteristics - RP793xA, RP794xA

Supplemental characteristics are not warranted but are descriptions of performance determined either by design or by type testing. Supplemental characteristics are typical unless otherwise noted.

Characteristic	RP7931A, RP7941A	RP7932A, RP7942A	RP7933A, RP7943A	RP7935A, RP7945A	RP7936A, RP7946A
Minimum compliance limits					
Voltage priority:	±400 mA	±125 mA	±800 mA	±250 mA	±125 mA
Current priority ¹ :	0 and 20 mV	0 and 80 mV	0 and 20 mV	0 and 80 mV	0 and 160 mV
Voltage programming					
Range:	0.02 to 20.4 V	0.08 to 81.6 V	0.02 to 20.4 V	0.08 to 81.6 V	0.16V to 163.2V
Resolution:	191 μV	800 μV	191 μV	800 μV	1.6 mV
Current programming					
Range:	-408 A to 408 A	-127.5 A to 127.5 A	-816 A to 816 A	-255 A to 255 A	-127.5A to 127.5A
Resolution:	7.7 mA	2.5 mA	15.5 mA	5 mA	2.5 mA
Resistance programming					
Range:	0 to 0.098 Ω	0 to 1.25 Ω	0 to 0.049 Ω	0 to 0.625 Ω	0 to 2.5 Ω
Resolution:	0.8 μΩ	9.8 μΩ	0.4 μΩ	4.8 μΩ	19.6 μΩ
Accuracy:	0.05% + 4 μΩ	0.05% + 32 μΩ	0.05% + 2 μΩ	0.05% + 16 μΩ	0.05% + 50 μΩ
Additional V-programming offset/Ohm:					
	50 mV	15 mV	100 mV	30 mV	15 mV
Measurement range					
Voltage:	-25 V to 25 V	-100 V to 100 V	-25 V to 25 V	-100 V to 100 V	-200 V to 200 V
Current:	-1014 A to 1014 A	-315 A to 315 A	-2028 A to 2028 A	-630 A to 630 A	-315 A to 315 A
Measurement digitization noise ²					
Voltage:	4 mV	20 mV	4 mV	20 mV	40 mV
Current:	400 mA	200 mA	800 mA	400 mA	200 mA
Programming & measurement tempCo ³					
Voltage:	0.0015% +80 μV/°C	0.0015% +300μV/°C	0.0015% +80 μV/°C	0.0015% +300μV/°C	0.0015%+600μV/°C
Current:	0.0075% +1.2mA/°C	0.0025% +400μA/°C	0.0075% +2.3mA/°C	0.0025% +800μA/°C	0.0025%+400μA/°C
Output current ripple & noise (cc rms):					
	200 mA	70 mA	200 mA	70 mA	50 mA
Common mode current					
CC rms:	2 mA	2.5 mA	2 mA	2.5 mA	3.5 mA
CC peak-to-peak:	20 mA	24 mA	20 mA	24 mA	30 mA
Overvoltage protection ⁴					
Maximum setting:	24 V	96 V	24 V	96 V	192 V
Response time:	< 30 μs	< 30 μs	< 30 μs	< 30 μs	< 30 μs
Accuracy:	0.02% + 2 mV	0.02% + 8 mV	0.02% + 2 mV	0.02% + 8 mV	0.02% + 16 mV
Voltage programming speed, no load ⁵					
Rise/fall time 10% to 90% of step:	80 μs	75 μs	80 μs	75 μs	75 μs
Settling time to 0.1% of step:	810 μs	480 μs	810 μs	480 μs	550 μs
Voltage programming speed, full load ⁶					
Rise/fall time 10% to 90% of step:	140 μs	130 μs	140 μs	130 μs	170 μs
Settling time to 0.1% of step:	4.2 ms	1.35 ms	4.2 ms	1.35 ms	1.35 ms
Current up/down programming speed ⁷					
Rise/fall time 10% to 90% of step:	300 μs	180 μs	300 μs	180 μs	190 μs
Settling time to 0.1% of step::	960 μs	500 μs	960 μs	500 μs	550 μs

Characteristic	RP7931A, RP7941A	RP7932A, RP7942A	RP7933A, RP7943A	RP7935A, RP7945A	RP7936A, RP7946A
Output on delay time ⁸					
Voltage priority - high impedance:	8.1 ms	8.1 ms	8.1 ms	8.1 ms	8.1 ms
Voltage priority - low impedance:	8.1 ms	8.1 ms	8.1 ms	8.1 ms	8.1 ms
Current priority:	7.1 ms	7.1 ms	7.1 ms	7.1 ms	7.1 ms
Maximum load inductance: ⁹					
	20 μ H	200 μ H	10 μ H	100 μ H	400 μ H
Line regulation					
Voltage:	< 10 μ V	< 10 μ V	< 10 μ V	< 10 μ V	< 10 μ V
Current:	< 20 μ A	< 10 μ A	< 40 μ A	< 10 μ A	< 10 μ A
Typical leakage current					
Output disabled - instantaneous: ¹⁰	2 μ A	800 μ A	4 μ A	800 μ A	800 μ A
Output disabled - long term ¹¹ :	0.4 μ A	800 μ A	0.8 μ A	800 μ A	800 μ A
Unit unplugged from AC mains:	2 μ A	800 μ A	4 μ A	800 μ A	800 μ A

¹ For lower and upper voltage compliance, respectively

² For digitization at 5.12 μ s sampling rate

³ Applies for ambient temperatures above 30°C or below 20°C

⁴ From occurrence of over-voltage to start of shutdown

⁵ In the CV Comp 0 range, Frequency = 100 kHz, under no load, and a step change from 10% to 100% of output rating

⁶ In the CV Comp 0 range, Frequency = 2.3 kHz, with full constant current load, and a step change from .1% to 100% of output rating

⁷ In the CC Comp 0 range, Frequency = 100 kHz, and a step change from 10% to 100% of current rating, into low impedance DC source

⁸ Time from when the Output On command is received to the initiation of turning the output on

⁹ **CAUTION** Unit is susceptible to internal damage if maximum load inductance limits are exceeded at the rated current; refer to [inductive load graphs](#) for additional information

¹⁰ Unit powered on with the output disabled for >1 second after full load operation

¹¹ Unit powered on with the output disabled for >10 seconds after full load operation

Common Characteristics

Common Characteristic	All Models
Command Processing Time	\leq 1 ms from receipt of command to start of output change. Applies to simple settings commands over the GPIB interface (see Typical Command Processing Times)
Constant Dwell ARBs	
Number of points:	Up to 65,535
Dwell range:	One dwell setting applies for the entire ARB, from 10.24 μ s to 0.30 seconds
Dwell resolution:	Values are rounded to the nearest 10.24-microsecond increment
Computer Interfaces	
LXI:	LXI 1.5 LXI Device Specification 2016
LAN:	10 Mb, 100 Mb, 1 Gb LAN
USB:	USB 2.0 (USB-TMC488 protocol)
GPIB:	SCPI - 1993, IEEE 488.2 compliant interface
Environmental	
Operating environment:	Indoor use, installation category II (for AC input), pollution degree 2
Temperature range:	0°C to 55°C (Maximum continuous current available is derated at 1% of rating per degree C from 40°C to 55°C)
Relative humidity:	95% or less (non-condensing)
Altitude:	Up to 2000 meters
Storage temperature:	-30°C to 70°C

1 Quick Reference

Common Characteristic	All Models
Acoustic statement (European Machinery Directive)	Acoustic noise emission LpA 79 dB at Operator position LpA 73 dB at Bystander position LpA 61.4 at Idle fan speed Normal operation mode per ISO 7779
Digital Port	
Max voltage rating:	+16.5 VDC/- 5 VDC between pins
Pins 1 & 2 as FLT:	Maximum low-level output voltage = 0.5 V @ 4 mA Maximum low-level sink current = 4 mA Typical high-level leakage current = 1 mA @ 16.5 VDC
Pins 1-7 as outputs:	Maximum low-level output voltage = 0.5 V @ 4 mA; 1 V @ 50 mA; 1.75 V @ 100 mA Maximum low-level sink current = 100 mA Typical high-level leakage current = 0.8 mA @ 16.5 VDC
Pins 1-7 as inputs:	Maximum low-level input voltage = 0.8 V Minimum high-level input voltage = 2 V Typical low-level current = 2 mA @ 0 V (internal 2.2k pull-up) Typical high-level leakage current = 0.12 mA @ 16.5 VDC
Pin 8:	Pin 8 is common (internally connected to chassis ground)
Regulatory Compliance	
EMC:	Complies with European EMC Directive for test and measurement products Complies with Australian standard and carries C-Tick mark This ISM device complies with Canadian ICES-001 Cet appareil ISM est conforme à la norme NMB-001 du Canada
Safety:	Complies with European Low Voltage Directive and carries the CE mark. Conforms to US and Canadian safety regulations. Declarations of Conformity for this product may be downloaded from the Web. Go to http://www.keysight.com/go/conformity and click on “Declarations of Conformity.”
AC Input	
Phase and range:	3 phase; 200 VAC nominal $\pm 10\%$, and 208 VAC nominal $\pm 10\%$ 3 phase; 400 VAC nominal $\pm 15\%$, and 480 VAC nominal $\pm 10\%$
Frequency:	50/60 Hz
Input VA:	RP7931A, RP7932A, RP7941A, RP7942A, RP7936A: 6.5 kVA RP7933A, RP7935A, RP7936A, RP7943A, RP7945A, RP7946A: 11.5 kVA
Input current per phase	
200 VAC input:	RP7931A, RP7932A: 17.3 A; RP7933A, RP7935A, RP7936A: 35 A
400 VAC input:	RP7941A, RP7942A: 8.66 A; RP7943A, RP7945A, RP7946A: 17.3 A
Efficiency at full power:	RP7931A, RP7932A, RP7941A, RP7942A: 84% RP7933A, RP7935A, RP7936A, RP7943A, RP7945A, RP7946A: 85%
Power Factor:	0.99 @ nominal input and rated power
	During a 1-cycle line dropout the unit may reboot. The output will remain off after reboot until the operator reinstates the previous settings, either by the front panel controls or using a computer program. This behavior is consistent with safe operating procedures.
Output Terminal Isolation:	
For 20 VDC models:	No output terminal may be more than ± 60 VDC from any other terminal or chassis ground.
For 80 & 160 VDC models:	No output terminal may be more than ± 240 VDC from any other terminal or chassis ground.

NOTE

Common Characteristic	All Models
Typical Weight	RP7931A, RP7932A, RP7941A, RP7942A: 60 lbs. (27.3 kg) RP7933A, RP7935A, RP7936A, RP7943A, RP7945A, RP7946A: 70 lbs. (31.8 kg)
Dimensions	3U high; full rack width (see Outline Diagrams for details)

AC Input Efficiency, Power Factor, and THD

The following graphs provide additional details about AC input efficiency, power factor, and total harmonic distortion over the entire power range of the instrument. Note that Highline voltages are 208 VAC and 480 VAC respectively. Lowline voltages are 200 VAC and 400 VAC respectively.

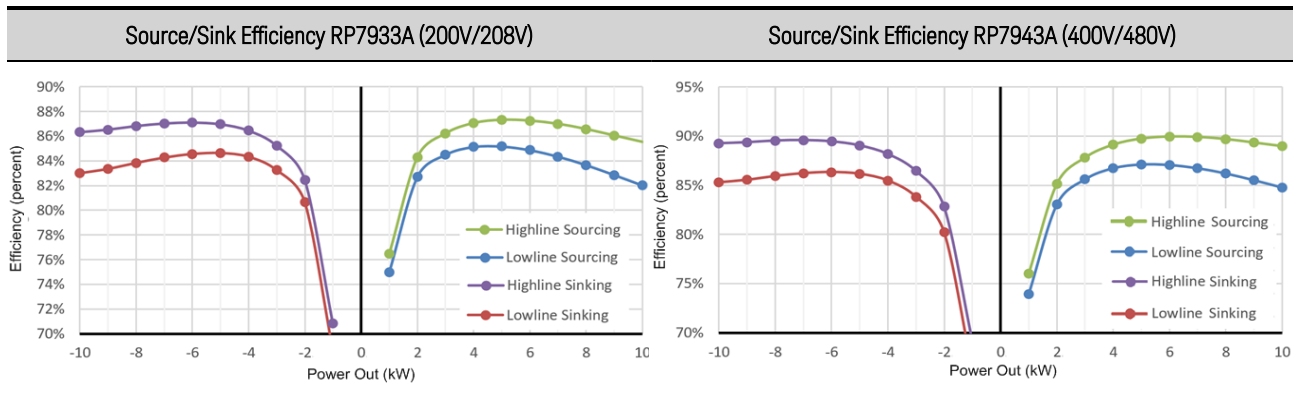
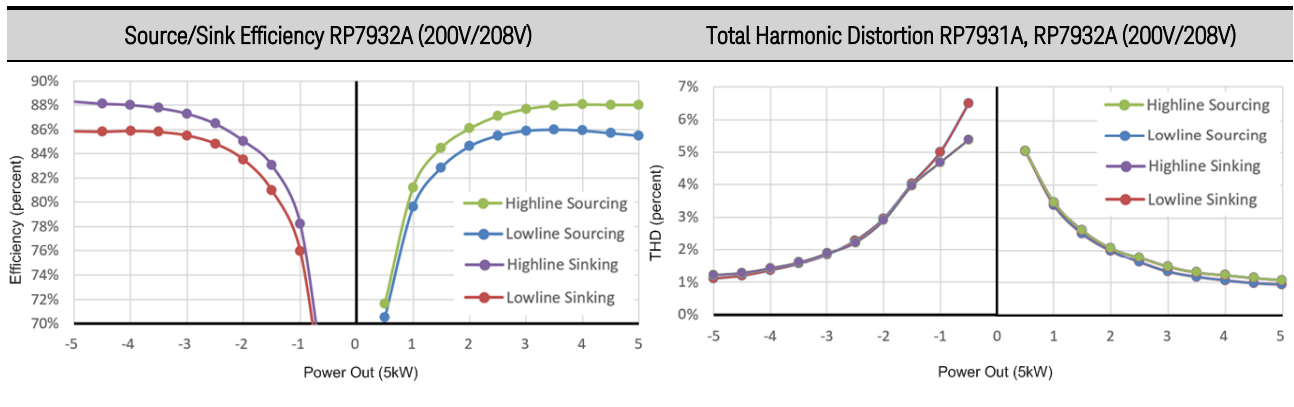
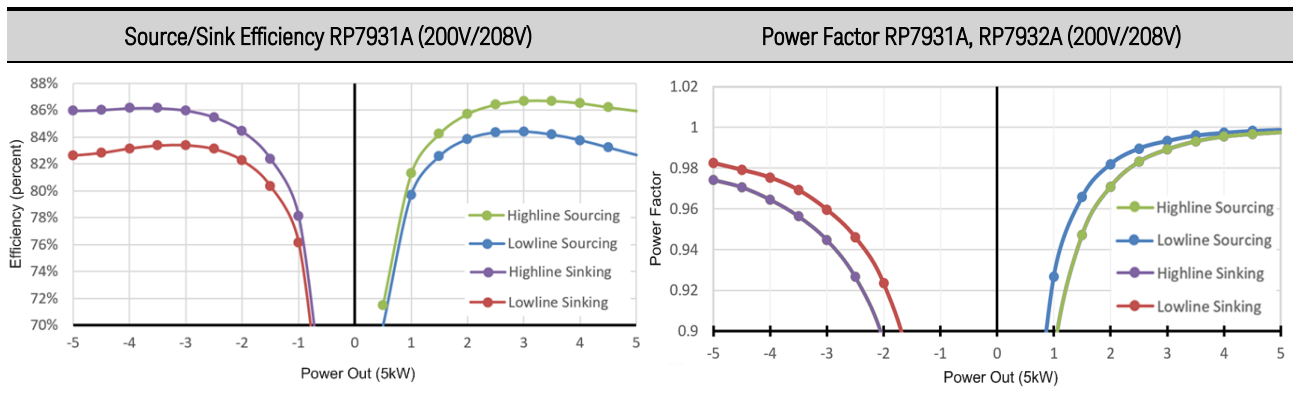

1 Quick Reference

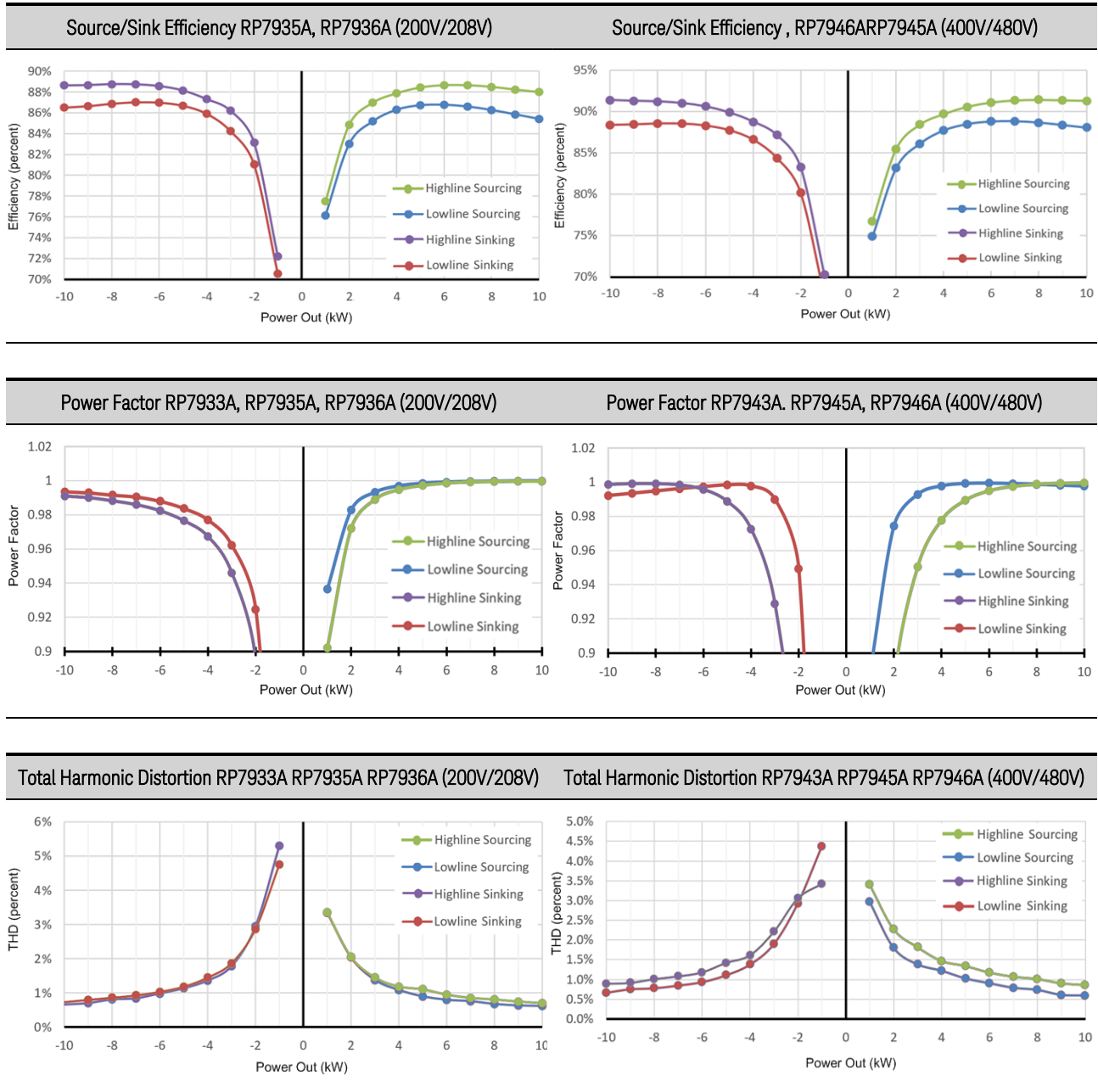

NOTE

If you are using lists or arbs to generate sinusoids near the grid frequency, there will be additional distortion currents in the line. Refer to the **Limiting Sinusoidal Outputs** section.

Output Impedance Graphs

The following graphs show the small signal output impedance of the compensation modes for constant voltage (CV) and constant current (CC) operation. Impedances are captured when measuring at the load leads 6 inches away from the bus bars.

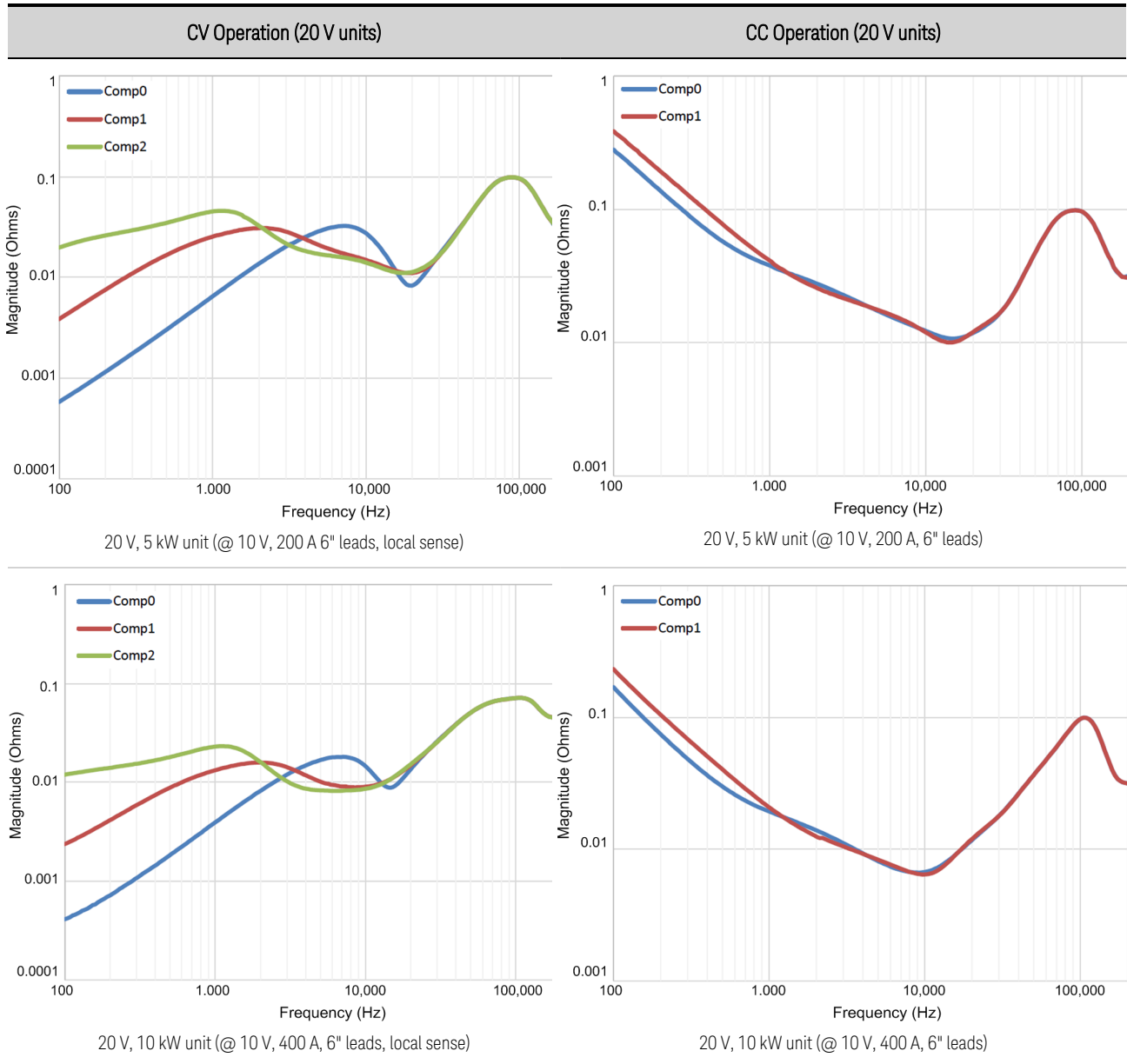

1 Quick Reference

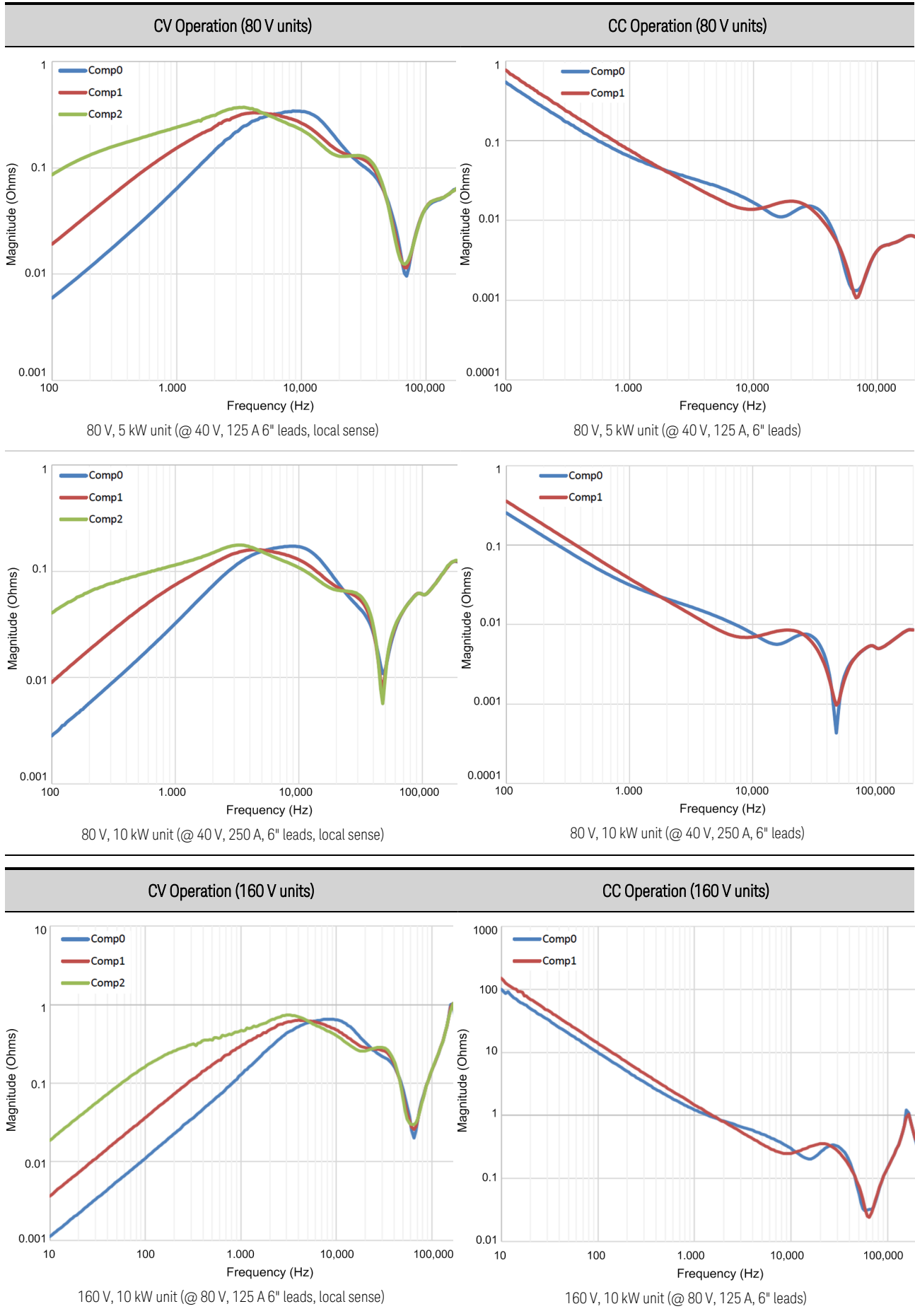

Inductive Load Boundary for Constant Current (CC) Operation

The following figures show the boundary limitations for inductive loads with series resistance for constant current operation. This also applies when operating in constant voltage at the current limit setting. Operation below the marginal stability lines with either **Comp 0** or **Comp 1** bandwidth settings may result in output instability. Note that lead and DUT resistance are indistinguishable in this context. It is also important to consider the voltage drop and power dissipation in the leads from increased lead resistance. Refer to **Inductance Considerations** for details. To prevent damage to the unit, refer to **Maximum Load Inductance**.

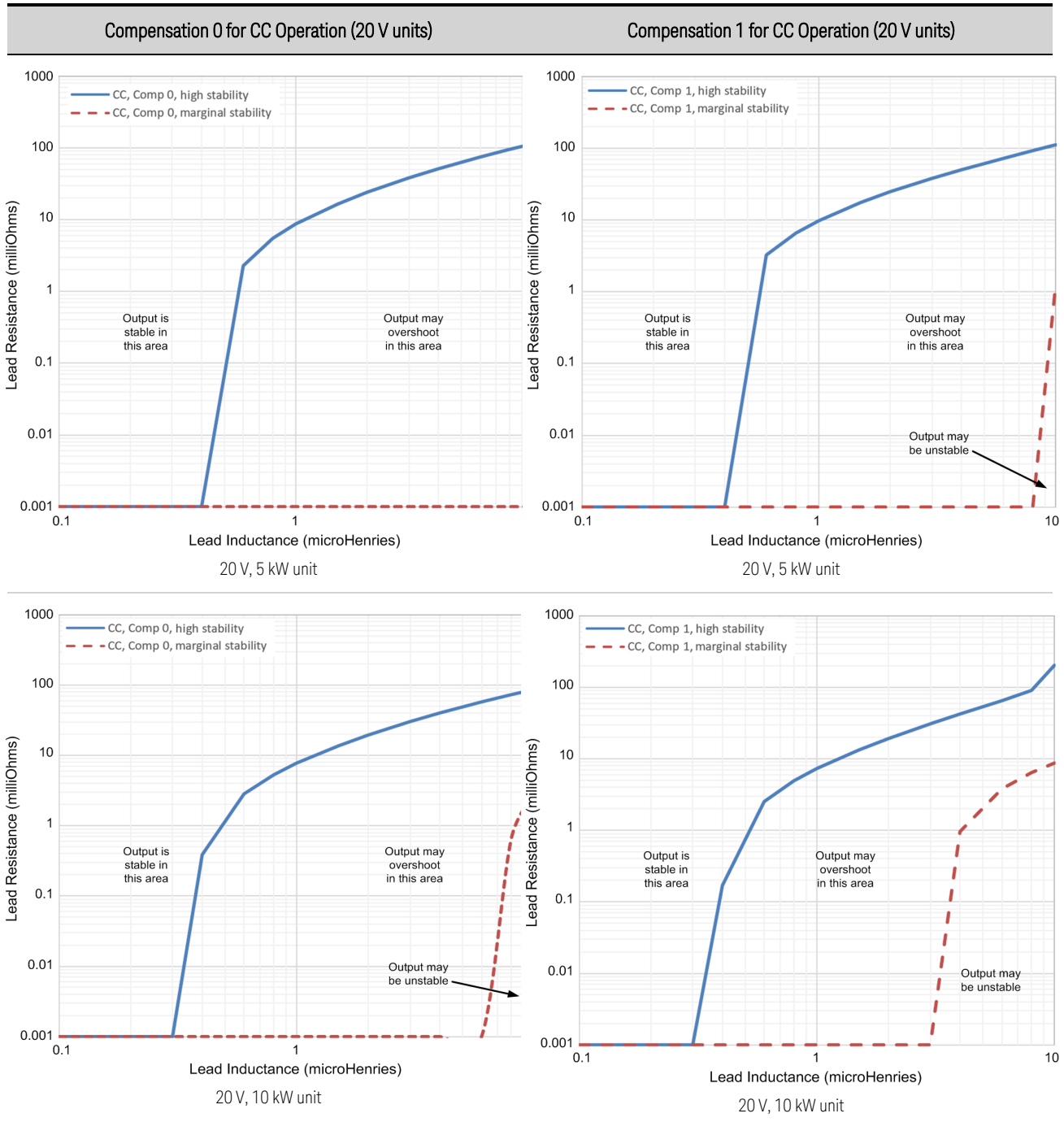

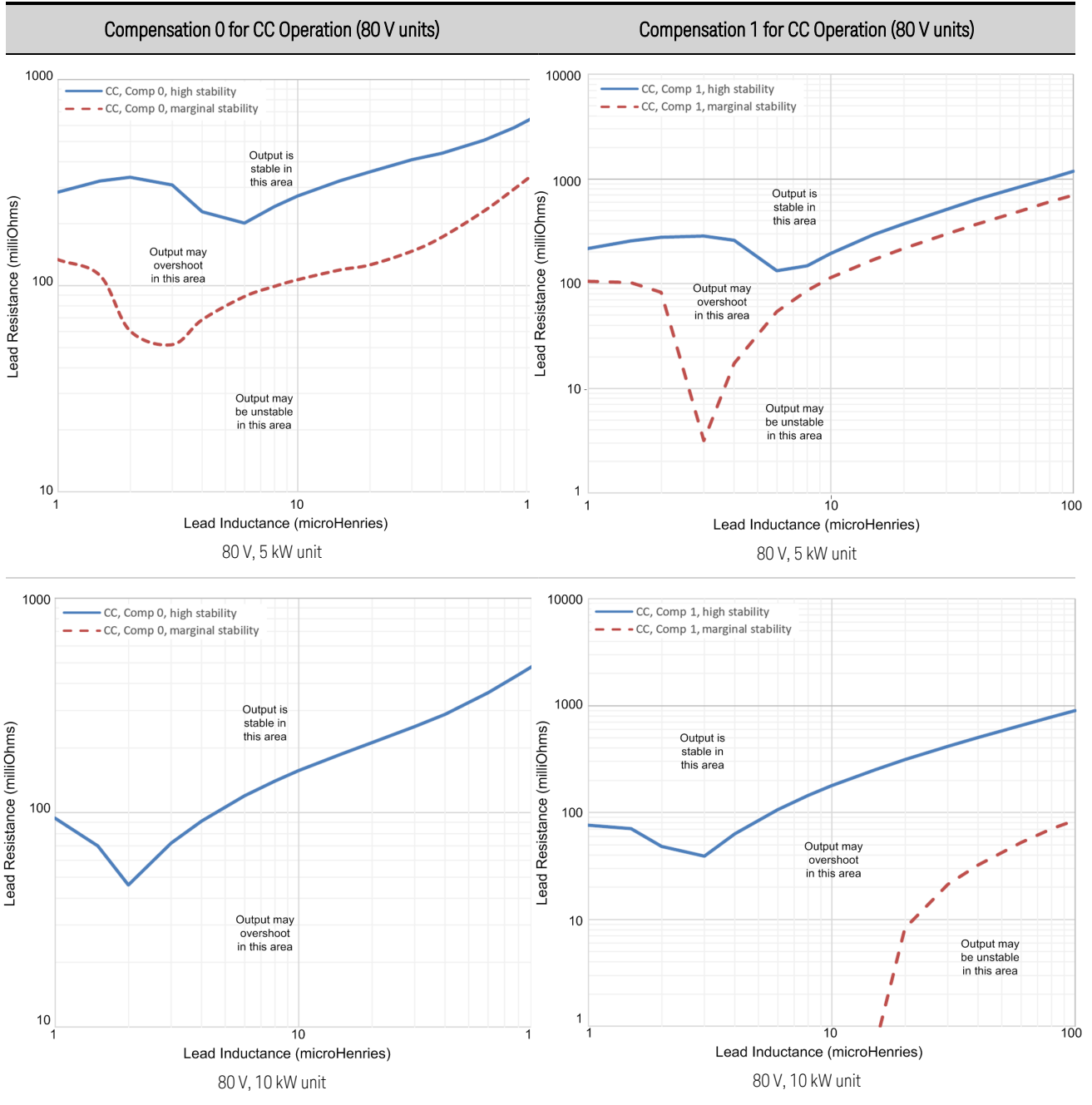

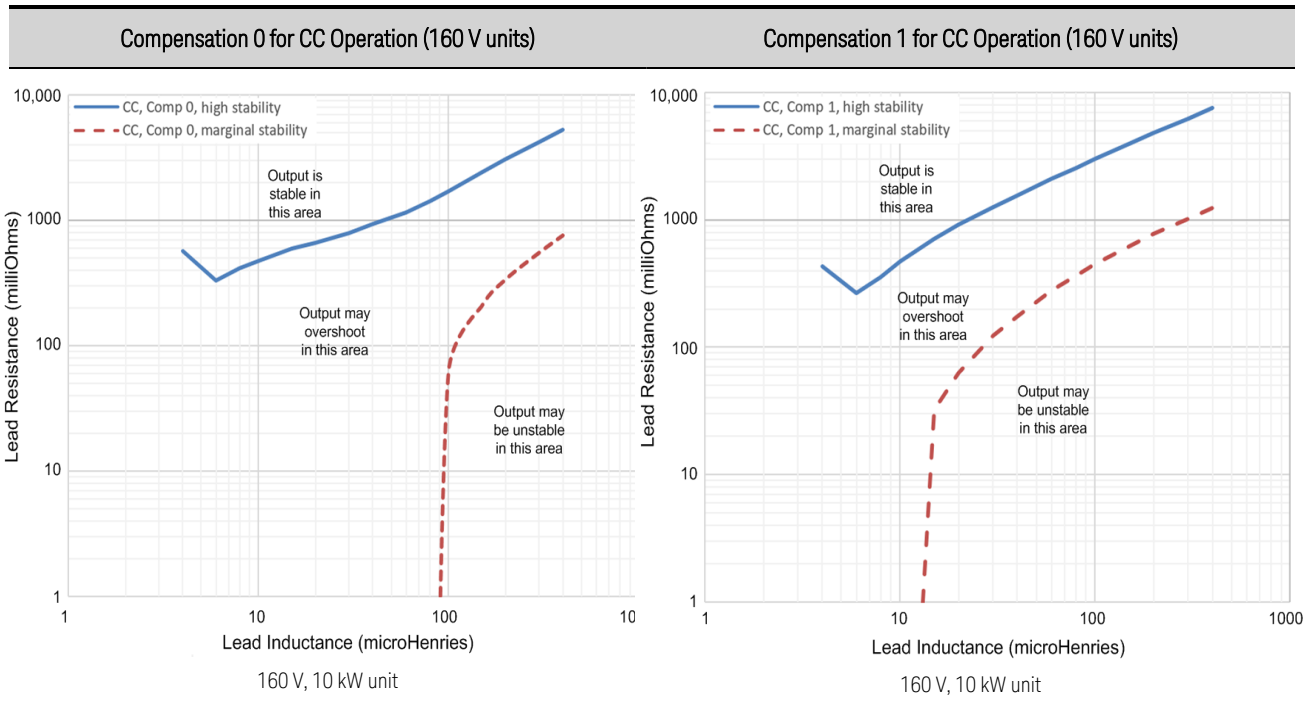

Capacitive Load Boundary for Constant Voltage (CV) Operation

The following figures show the boundary limitations for capacitive loads with equivalent series resistance for constant voltage operation. Operation below the marginal stability lines with the **Compensation** bandwidth settings may result in output instability. Conditions with and without load leads illustrate the additional effects of inductance on constant voltage stability. There are no absolute limits for DUT capacitance, as the stability is also a function of ESR. Refer to **Load Capacitance and Lead Inductance Considerations** for details.

1 Quick Reference

Minimum ESR vs. DUT Capacitance for 20 V, 5 kW units

With local sensing and
DUT directly connected to bus bars

With remote sensing and
load leads around $6 \mu\text{H}/2 \text{ m}\Omega$

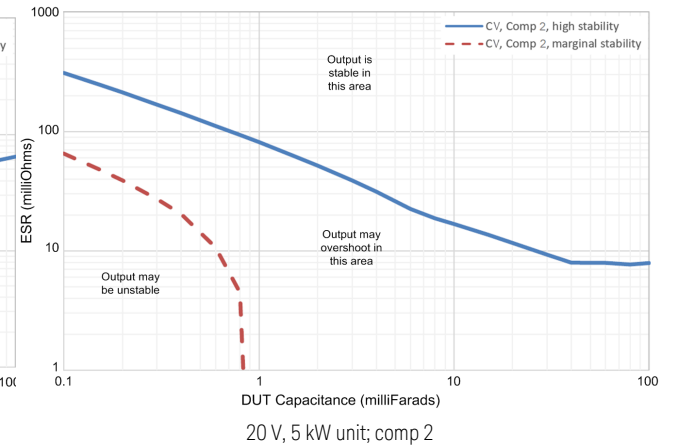
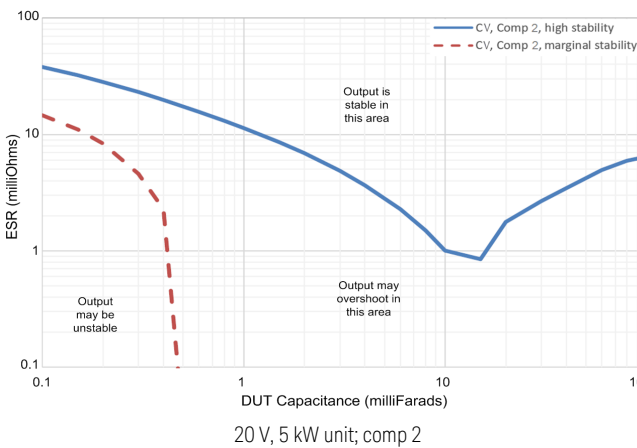
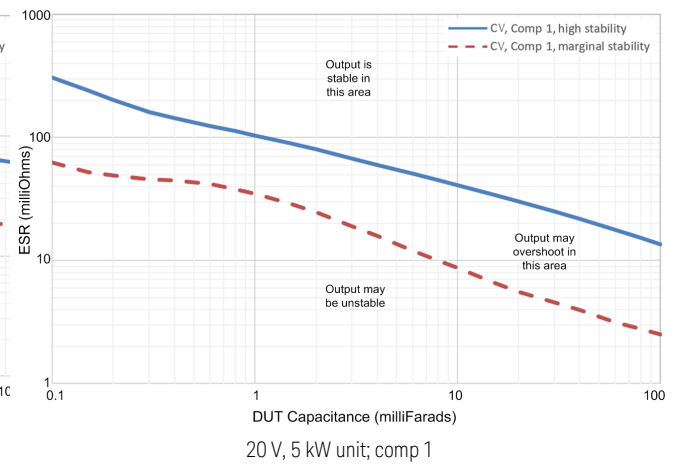
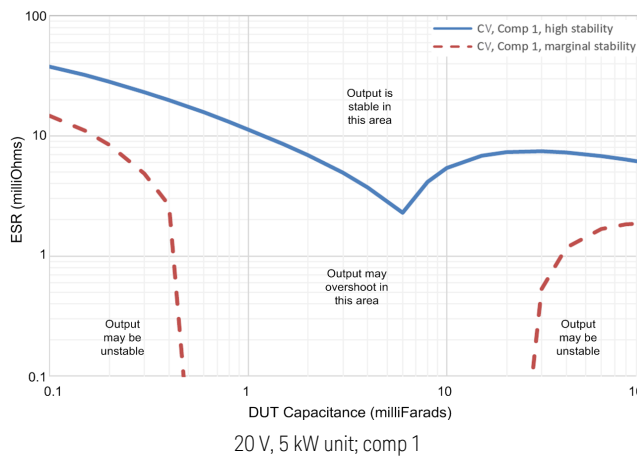
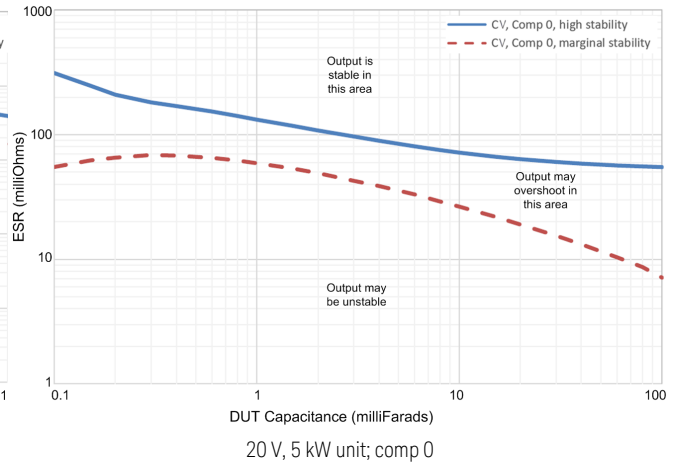
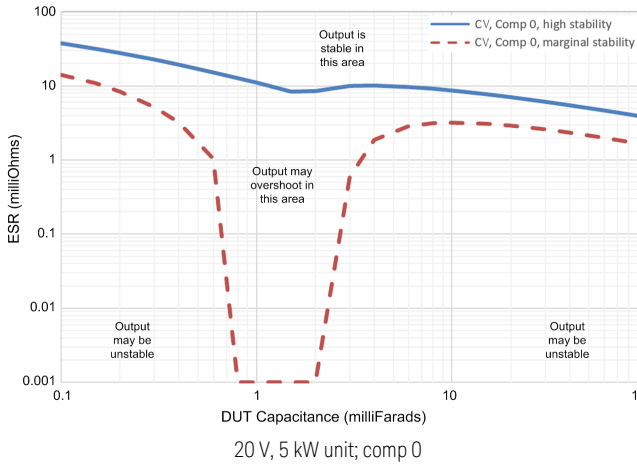

Minimum ESR vs. DUT Capacitance for 20 V, 10 kW units

With local sensing and
DUT directly connected to bus bars

With remote sensing and
load leads around 3 μ H/1 m Ω

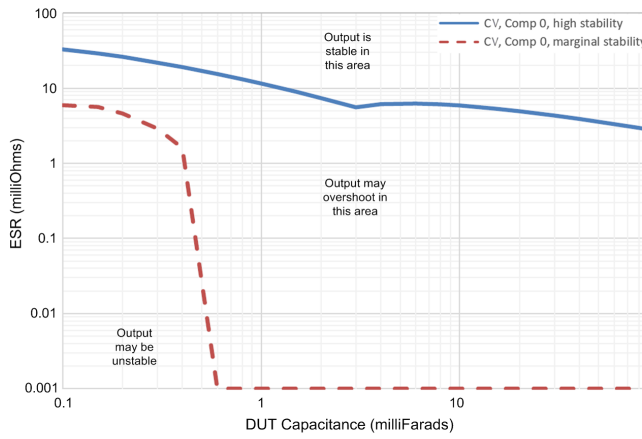

20 V, 10 kW unit; comp 0

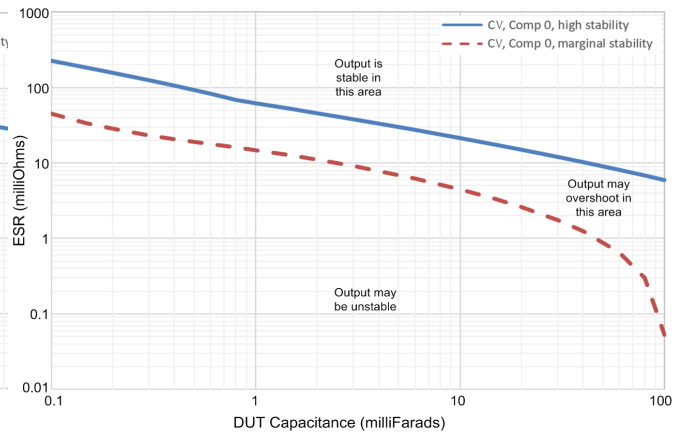

20 V, 10 kW unit; comp 0

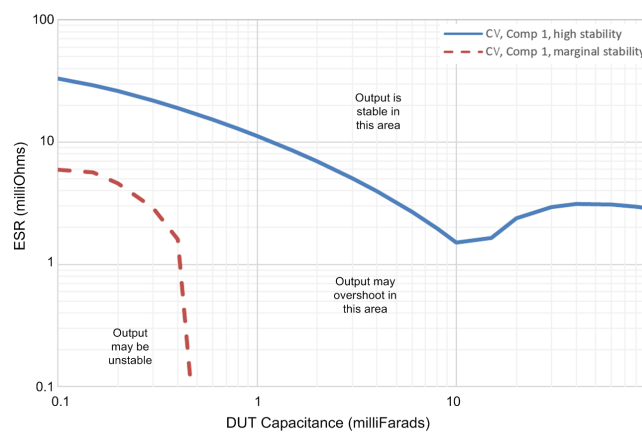

20 V, 10 kW unit; comp 1

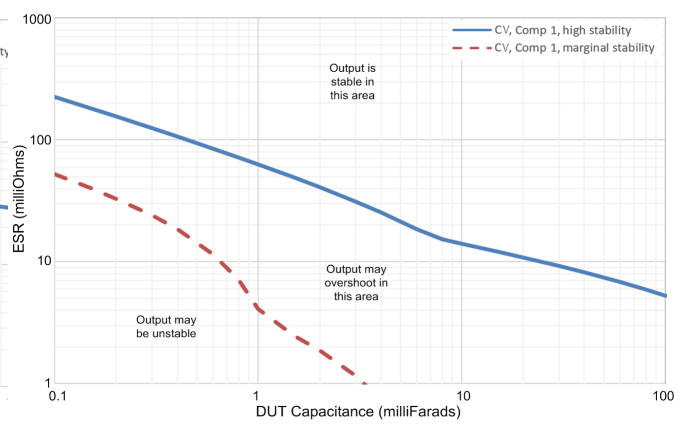

20 V, 10 kW unit; comp 1

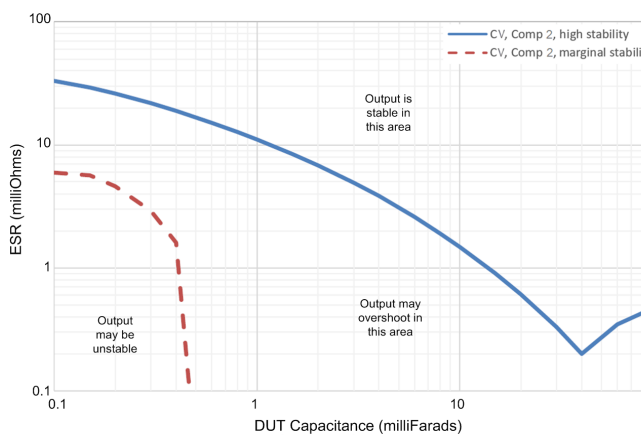

20 V, 10 kW unit; comp 2

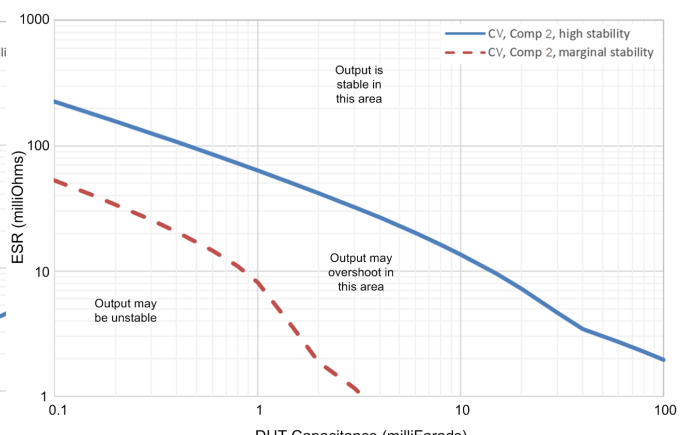

20 V, 10 kW unit; comp 2

1 Quick Reference

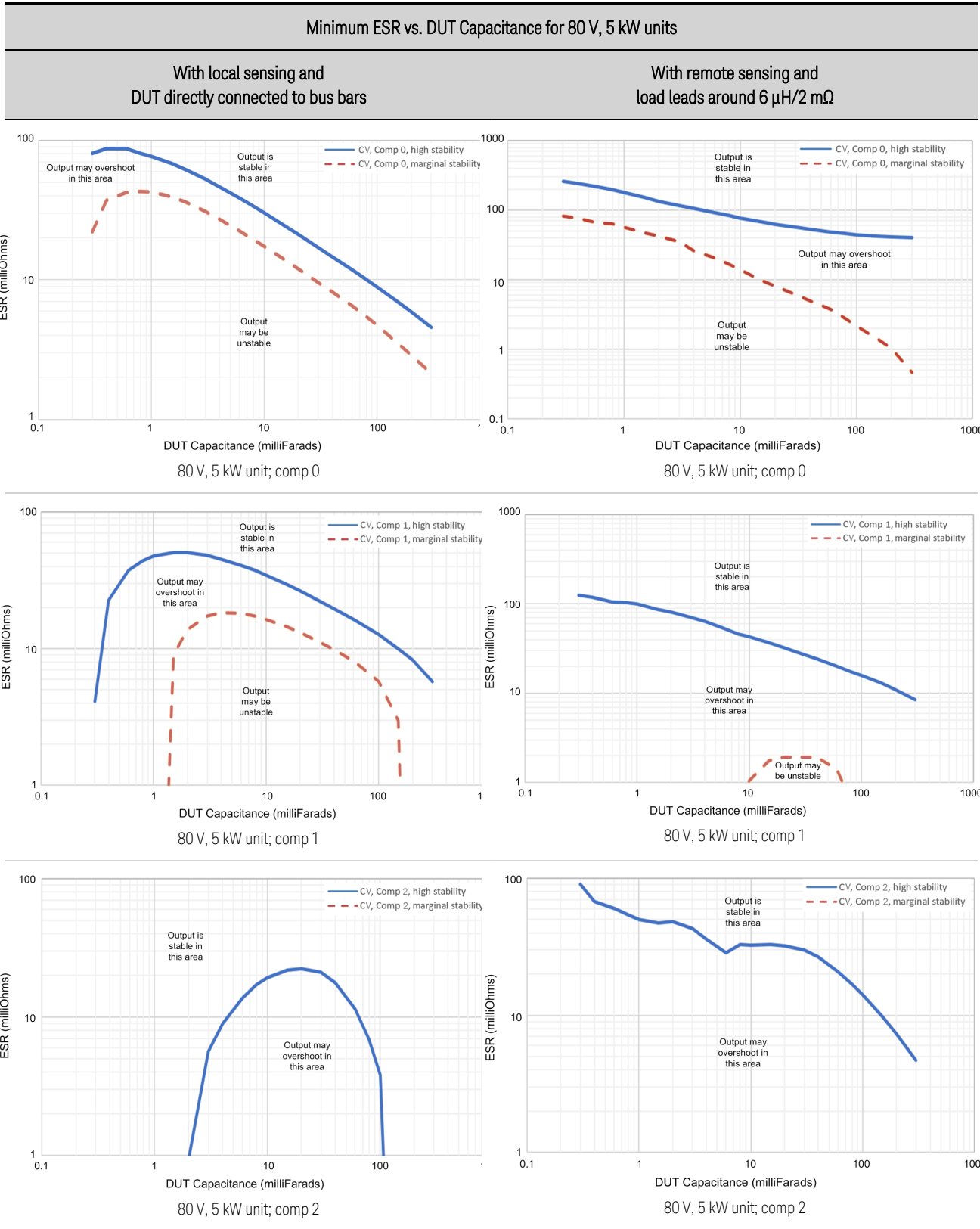

Minimum ESR vs. DUT Capacitance for 80 V, 10 kW units

With local sensing and
DUT directly connected to bus bars

With remote sensing and
load leads around 3 μ H/1 m Ω

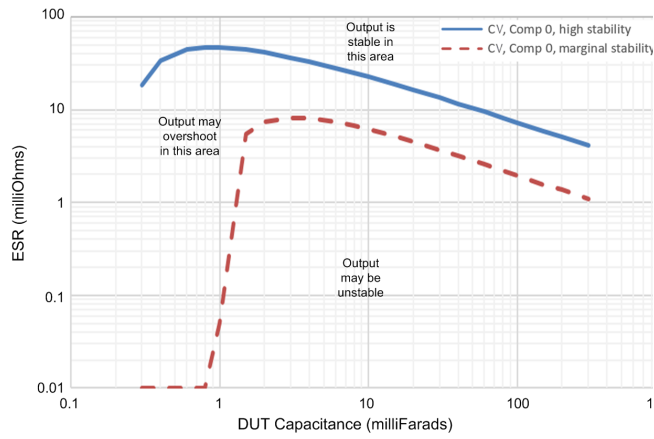

80 V, 10 kW unit; comp 0

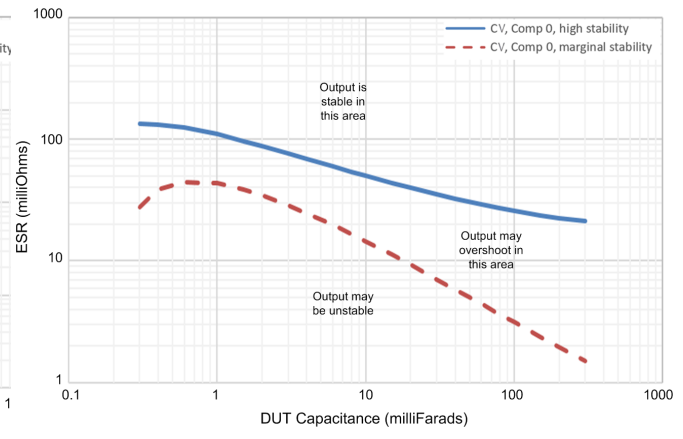

80 V, 10 kW unit; comp 0

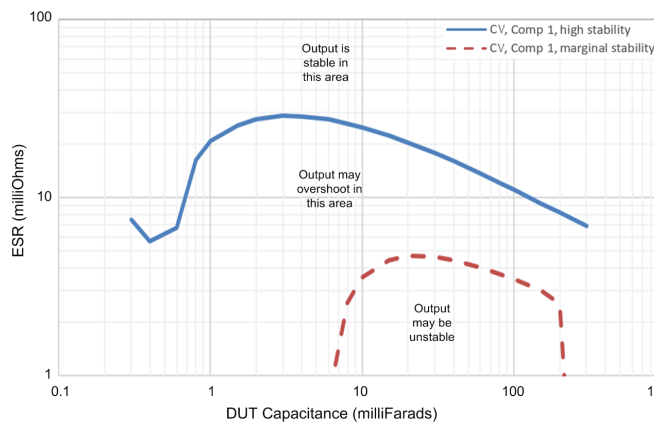

80 V, 10 kW unit; comp 1

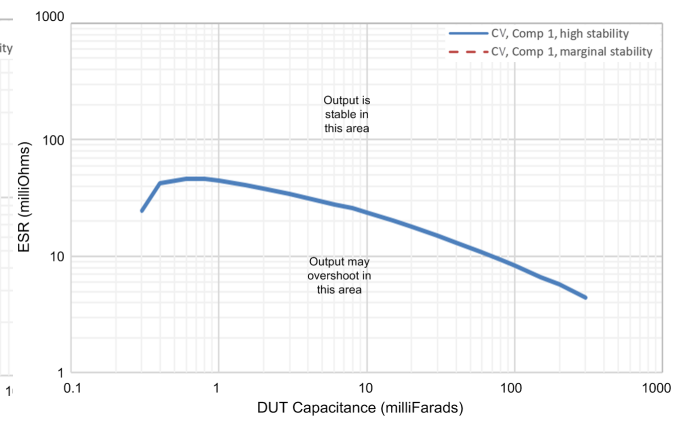

80 V, 10 kW unit; comp 1

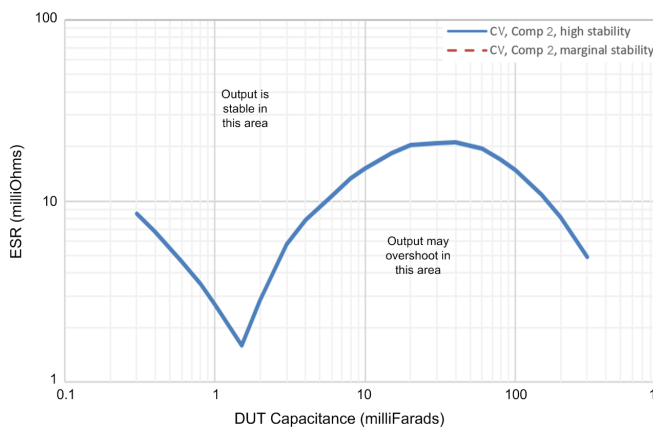

80 V, 10 kW unit; comp 2

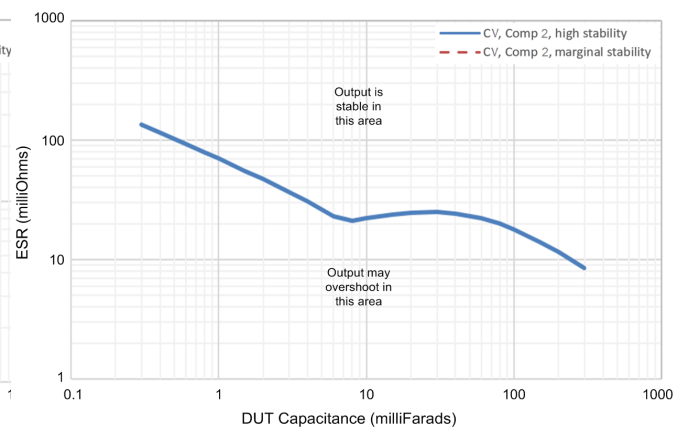

80 V, 10 kW unit; comp 2

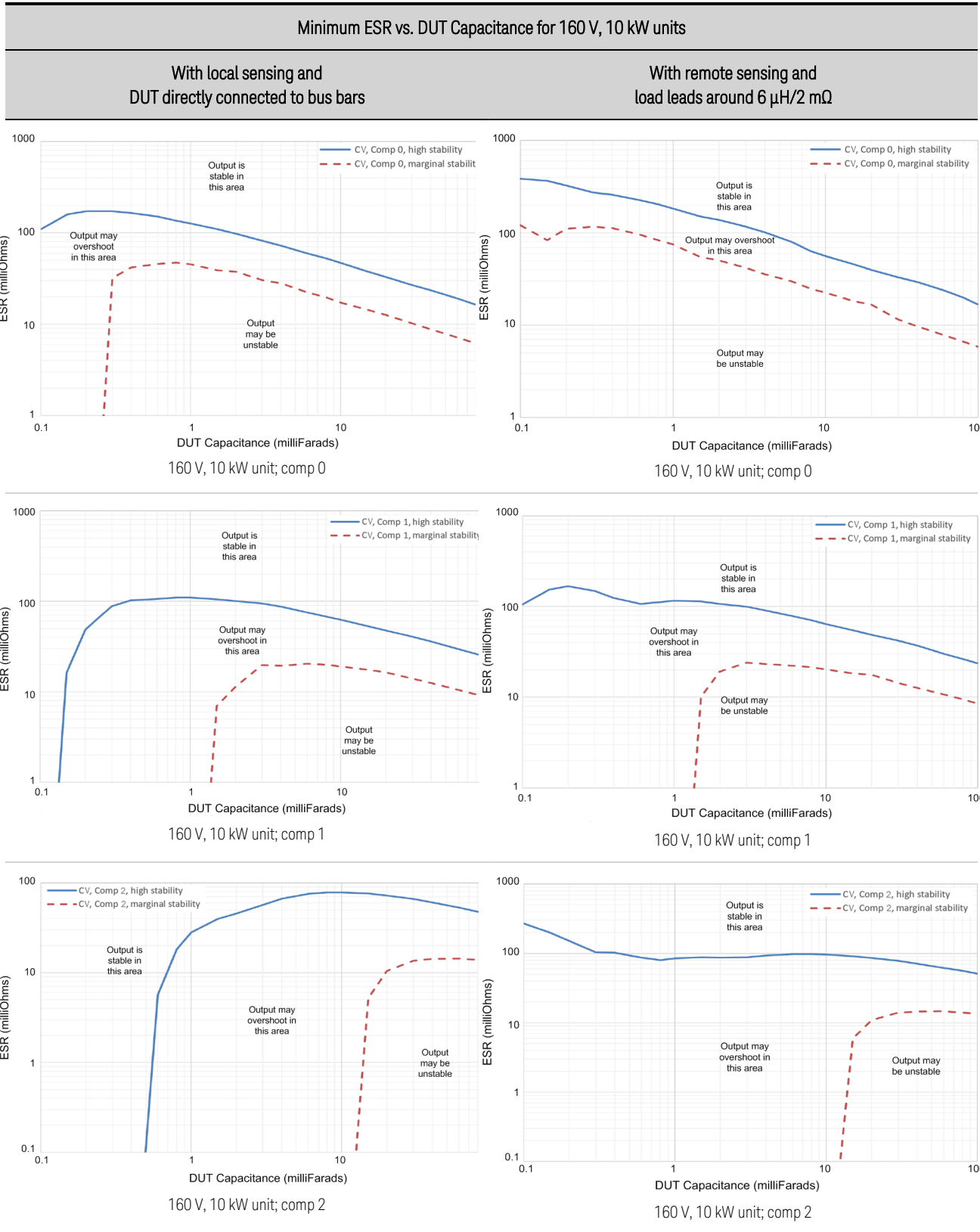

Small Signal Programming Response (All Models)

The following graphs show the output voltage and current programming response characteristic. The voltage response applies with no load conditions. The current response applies with AC short-circuit conditions where the DUT is a low impedance operating above 10% of the rated output of the RPS, with less than 1 foot of load leads. The table provides additional bandwidth details.

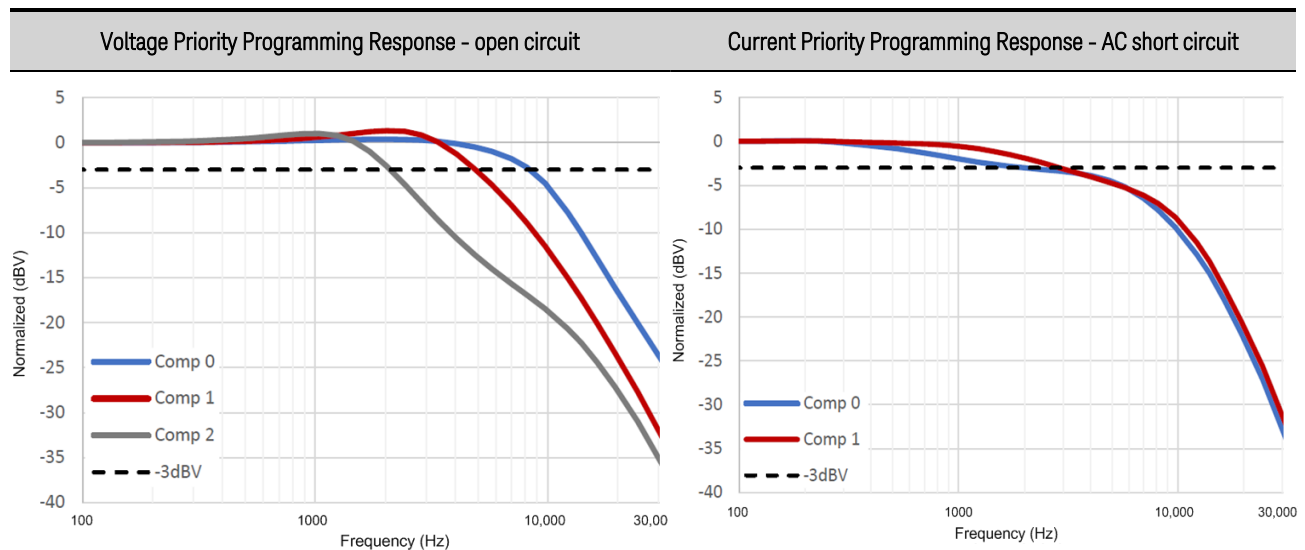

	Operation	Comp 0 (-1dB)	Comp 0 (-3dB)	Comp 1 (-1dB)	Comp 1 (-3dB)	Comp 2 (-1dB)	Comp 2 (-3dB)
20 V models	CV	5.6 kHz	8.3 kHz	3.8 kHz	4.7 kHz	1.6 kHz	2.0 kHz
	CC	550 Hz	2.0 kHz	1.3 kHz	2.7 kHz	N/A	N/A
80 V models	CV	5.7 kHz	7.5 kHz	5.3 kHz	6.6 kHz	4.9 kHz	5.9 kHz
	CC	1.9 kHz	2.7 kHz	3.1 kHz	3.5 kHz	N/A	N/A
160 V models	CV	5.5 kHz	7.0 kHz	5.1 kHz	6.2 kHz	4.8 kHz	5.6 kHz
	CC	1.9 kHz	2.5 kHz	3.0 kHz	3.5 kHz	N/A	N/A

Measurement Accuracy and Resolution - with shorter measurement intervals

The following table shows changes to the short-term measurement accuracy and resolution with various number of power line cycle (NPLC) measurement settings. Changes are due to the A-to-D converter's noise performance. The table's baseline is 1 NPLC with no added noise. To determine the measurement accuracy at shorter averaging intervals, simply calculate the percent of range to add, then add it to the fixed accuracy value in the specification table.

For example, to determine the percent of range to add to the accuracy specification of the voltage measurement when making measurements at 0.003 NPLC, simply multiply the full voltage rating by the "% of range added to spec value" as follows: $20\text{ V} \times 0.006\% = 1.2\text{ mV}$. Add this number to the offset part of the measurement accuracy specification: $2\text{ mV} + 1.2\text{ mV}$. The new voltage measurement accuracy is $0.02\% + 3.2\text{ mV}$ at 0.003 NPLC.

1 Quick Reference

NPLC @60Hz	Number of averaged points	Voltage Measurement % of range added to spec.	Current Measurement % of range added to spec.
1	3255	0	0
0.6	1953	0.00013%	0.0005%
0.1	325	0.0005%	0.004%
0.06	195	0.0009%	0.005%
0.031	100	0.0015%	0.008%
0.010	33	0.0025%	0.0015%
0.006	20	0.004%	0.020%
0.003	10	0.006%	0.03%
0.0003	1	0.02%	0.10%

Excessive Dynamic Protection

For the high current models, EDP does not limit the allowable programmable waveform amplitude or frequency. You can program a full scale square wave at a maximum frequency of 97.6 kHz indefinitely.

Output Quadrants

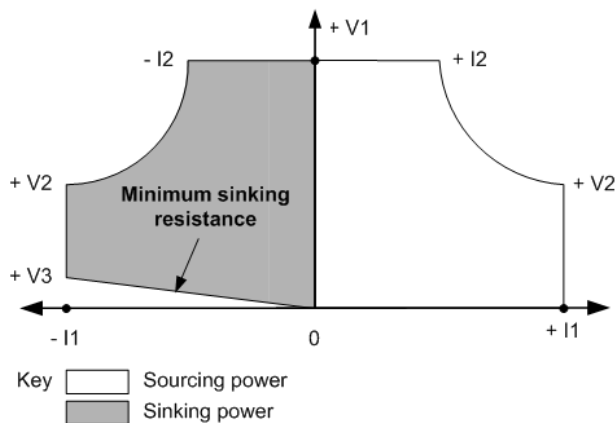

Model	+ V1	+ V2	+ V3	+/- I1	+/- I2	Minimum sink resistance
RP7931A / RP7941A	20 V	12.5 V	0.5 V	400 A	250 A	1.25 mΩ
RP7933A / RP7943A	20 V	12.5 V	0.5 V	800 A	500 A	625 μΩ
RP7932A / RP7942A	80 V	40 V	1 V	125 A	62.5 A	8 mΩ
RP7935A / RP7945A	80 V	40 V	1 V	250 A	125 A	4 mΩ
RP7936A / RP7946A	160 V	80 V	1.5 V	125 A	62.5 A	12 mΩ

Specifications and Characteristics - RP795xA, RP796xA

Specifications - RP795xA, RP796xA

Supplemental Characteristics - RP795xA, RP796xA

Common Characteristics

AC Input Efficiency, Power Factor, and THD

Output Impedance Graphs

Inductive Load Boundary for Constant Current (CC) Operation

Capacitive Load Boundary for Constant Voltage (CV) Operation

Voltage Programming Response

Excessive Dynamic Protection

Output Quadrants

Specifications - RP795xA, RP796xA

Unless otherwise noted, specifications are warranted over the ambient temperature range of 0 to 40°C after a 30-minute warm-up period. Specifications apply at the output terminals, with the sense terminals connected to the output terminals (local sensing).

Specification	RP7951A, RP7961A	RP7952A, RP7962A	RP7953A, RP7963A
DC Ratings			
Voltage source:	0 to 500 V	0 to 500 V	0 to 950 V
Current source and sink:	0 to ±20 A	0 to ±40 A	0 to ±20 A
Power:	0 to ±5 kW	0 to ±10 kW	0 to ±10 kW
Output ripple & noise			
CV peak-to-peak: ¹	500 mV	500 mV	1000 mV
CV rms: ²	100 mV	100 mV	200 mV
Load regulation			
Voltage:	30 mV	30 mV	60 mV
Current:	9 mA	17 mA	9 mA
Voltage programming accuracy: ³	0.03% + 60 mV	0.03% + 60 mV	0.03% + 120 mV
Voltage measurement accuracy: ³	0.03% + 80 mV	0.03% + 80 mV	0.03% + 160 mV
Current programming & measurement accuracy: ³	0.1% + 12 mA	0.1% + 24 mA	0.1% + 12 mA
Transient response ⁴			
Recovery Time:	500 μs	500 μs	500 μs
Settling band:	1.25 V	1.25 V	2.375 V

¹ From 20 Hz to 20 MHz (-3dB bandwidth) with resistive load, terminals ungrounded, or either terminal grounded

² From 20 Hz to 10 MHz (-3dB bandwidth) with resistive load, terminals ungrounded, or either terminal grounded

³ Percent of value + offset; at 25°C ±5°C after a 30 minute warm-up; measurement NPLC=1; valid for 1 year, see [Calibration Interval](#) with a load lead voltage drop of up to 1V per lead - see [Wire Size](#) for additional information about load lead voltage drop

⁴ Time to recover to within the settling band following a step change from 50% to 100% of full load at the maximum slew rate

Supplemental Characteristics - RP795xA, RP796xA

Supplemental characteristics are not warranted but are descriptions of performance determined either by design or by type testing. Supplemental characteristics are typical unless otherwise noted.

Characteristic	RP7951A, RP7961A	RP7952A, RP7962A	RP7953A, RP7963A
Output ripple and noise CC rms:	100 mA	200 mA	100 mA
Voltage programming Range:	0.5 to 510 V	0.5 to 510 V	1.0 to 969 V
Resolution:	10.5 mV	10.5 mV	21 mV
Current programming Range:	-20.5 A to 20.5 A	-41 A to 41 A	-20.5 A to 20.5 A
Resolution:	190 μ A	380 μ A	190 μ A
Resistance programming Range:	0 to 25 Ω	0 to 12.5 Ω	0 to 50 Ω
Resolution:	140 $\mu\Omega$	70 $\mu\Omega$	280 $\mu\Omega$
Accuracy:	0.08% + 200 $\mu\Omega$	0.08% + 110 $\mu\Omega$	0.08% + 280 $\mu\Omega$
Additional V-programming offset with resistance programming enabled:	+157mV +(0.36 Ω x A)	+157mV +(0.36 Ω x A)	+313mV +(0.72 Ω x A)
Additional V-programming offset/ Ohm:	175 mV	175 mV	350 mV
Voltage Programming Speed (Comp 0) ^{1,2} Rise/fall time 10% to 90% of step:	1 ms	1 ms	1 ms
Settling time to 0.1% of step:	6 ms	6 ms	6 ms
Voltage Programming Speed (Comp 1) ^{1,2} Rise/fall time 10% to 90% of step:	15 ms	15 ms	15 ms
Settling time to 0.1% of step:	50 ms	50 ms	50 ms
Current Programming Speed ¹ Rise time 10% to 90% of step:	2 ms	2 ms	2 ms
Maximum slew rate Voltage:	200 kV/s	200 kV/s	400 kV/s
Current:	1.6 kA/s	3.2 kA/s	1.6 kA/s
Small signal programming bandwidth Voltage @ 3dB with no load:	500 Hz	500 Hz	500 Hz
Current with output shorted:	40 Hz	40 Hz	40 Hz
Line regulation Voltage:	< 10 mV	< 10 mV	< 20 mV
Current:	< 290 μ A	< 580 μ A	< 290 μ A
Reactive loads Capacitance default/low:	80 μ F/800 μ F	160 μ F/1600 μ F	40 μ F/400 μ F
Inductance: ³	5 μ H	5 μ H	5 μ H

¹Up programming with full resistive load and a step change from 0.1% to 100% of rated output

²Down programming with no load and a step change from 100% to 0.1% of rated output

³ Equivalent to 10 feet of load leads

Common Characteristics

Common Characteristic	All Models
Command Processing Time	≤ 1 ms from receipt of command to start of output change. Applies to simple settings commands over the GPIB interface (see Typical Command Processing Times)
Constant Dwell ARBs	
Number of points:	Up to 65,535
Dwell range:	One dwell setting applies for the entire ARB, from 10.24 μ s to 0.30 seconds
Dwell resolution:	Values are rounded to the nearest 10.24-microsecond increment
Computer Interfaces	
LXI:	LXI 1.5 LXI Device Specification 2016
LAN:	10 Mb, 100 Mb, 1 Gb LAN
USB:	USB 2.0 (USB-TMC488 protocol)
GPIB:	SCPI - 1993, IEEE 488.2 compliant interface
Environmental	
Operating environment:	Indoor use, installation category II (for AC input), pollution degree 2
Temperature range:	0°C to 55°C (Maximum continuous current available is derated at 1% of rating per degree C from 40°C to 55°C)
Relative humidity:	95% or less (non-condensing)
Altitude:	Up to 2000 meters
Storage temperature:	-30°C to 70°C
Acoustic statement (European Machinery Directive)	Acoustic noise emission LpA 79 dB at Operator position LpA 73 dB at Bystander position LpA 61.4 at Idle fan speed Normal operation mode per ISO 7779
Digital Port	
Max voltage rating:	+16.5 VDC/- 5 VDC between pins
Pins 1 & 2 as FLT:	Maximum low-level output voltage = 0.5 V @ 4 mA Maximum low-level sink current = 4 mA Typical high-level leakage current = 1 mA @ 16.5 VDC
Pins 1-7 as outputs:	Maximum low-level output voltage = 0.5 V @ 4 mA; 1 V @ 50 mA; 1.75 V @ 100 mA Maximum low-level sink current = 100 mA Typical high-level leakage current = 0.8 mA @ 16.5 VDC
Pins 1-7 as inputs:	Maximum low-level input voltage = 0.8 V Minimum high-level input voltage = 2 V Typical low-level current = 2 mA @ 0 V (internal 2.2k pull-up) Typical high-level leakage current = 0.12 mA @ 16.5 VDC
Pin 8:	Pin 8 is common (internally connected to chassis ground)

1 Quick Reference

Common Characteristic	All Models
Regulatory Compliance	
EMC:	Complies with European EMC Directive for test and measurement products Complies with Australian standard and carries C-Tick mark This ISM device complies with Canadian ICES-001 Cet appareil ISM est conforme à la norme NMB-001 du Canada
Safety:	Complies with European Low Voltage Directive and carries the CE mark. Conforms to US and Canadian safety regulations. Declarations of Conformity for this product may be downloaded from the Web. Go to http://www.keysight.com/go/conformity and click on “Declarations of Conformity.”
AC Input	
Phase and range:	3 phase; 200 VAC nominal $\pm 10\%$, and 208 VAC nominal $\pm 10\%$ 3 phase; 400 VAC nominal $\pm 15\%$, and 480 VAC nominal $\pm 10\%$
Frequency:	50/60 Hz
Input VA:	RP7951A, RP7961A: 6.5 kVA RP7952A, RP7962A, RP7953A, RP7963A: 11.5 kVA
Input current per phase	
200 VAC input:	RP7951A: 17.3 A; RP7952A, RP7953A: 35 A
400 VAC input:	RP7961A: 8.66 A; RP7962A, RP7963A: 17.3 A
Efficiency at full power:	RP7951A, RP7952A, RP7953A: 86.3% RP7961A, RP7962A, RP7963A: 91.5%
Power Factor:	0.99 @ nominal input and rated power
	NOTE During a 1-cycle line dropout the unit may reboot. The output will remain off after reboot until the operator reinstates the previous settings, either by the front panel controls or using a computer program. This behavior is consistent with safe operating procedures.
Output Terminal Isolation:	No output terminal may be more than ± 950 VDC from any other terminal or chassis ground.
Typical Weight	RP7951A, RP7961A: 60 lbs. (27.3 kg) RP7952A, RP7962A, RP7953A, RP7963A: 70 lbs. (31.8 kg)
Dimensions	3U high; full rack width (see Outline Diagrams for details)

AC Input Efficiency, Power Factor, and THD

The following graphs provide additional details about AC input efficiency, power factor, and total harmonic distortion over the entire power range of the instrument. Note that Highline voltages are 208 VAC and 480 VAC respectively. Lowline voltages are 200 VAC and 400 VAC respectively.

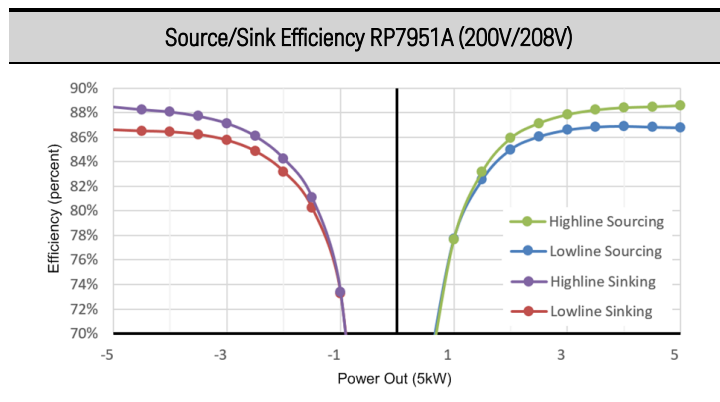

Power Factor RP7951A (200V/208V)

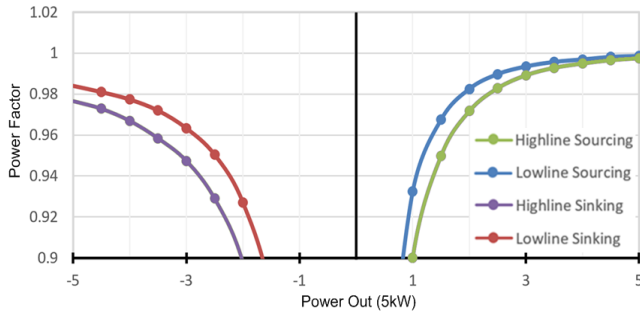

Total Harmonic Distortion RP7951A (200V/208V)

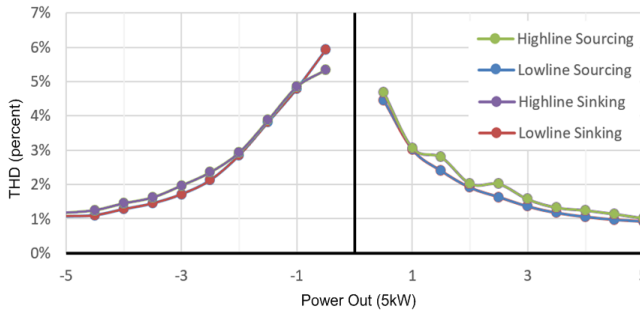

Source/Sink Efficiency RP7952A (200V/208V)

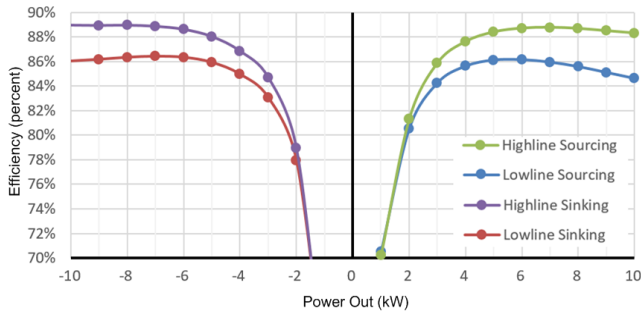

Source/Sink Efficiency RP7962A (380V/480V)

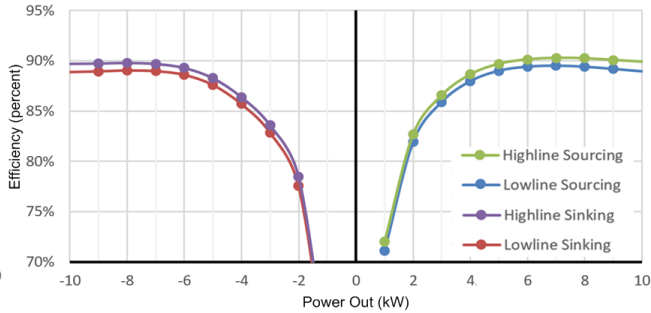

Source/Sink Efficiency RP7953A (200V/208V)

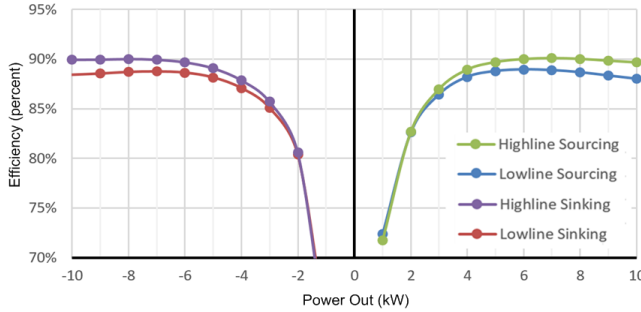

Source/Sink Efficiency RP7963A (380V/480V)

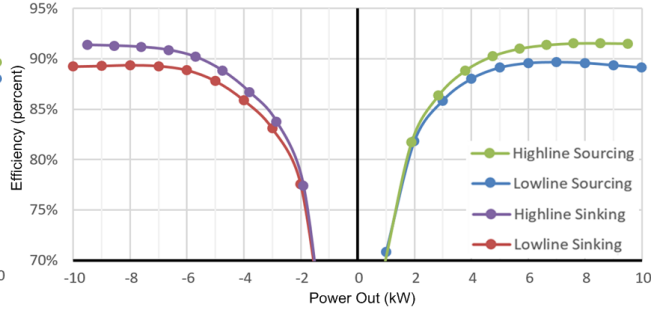

1 Quick Reference

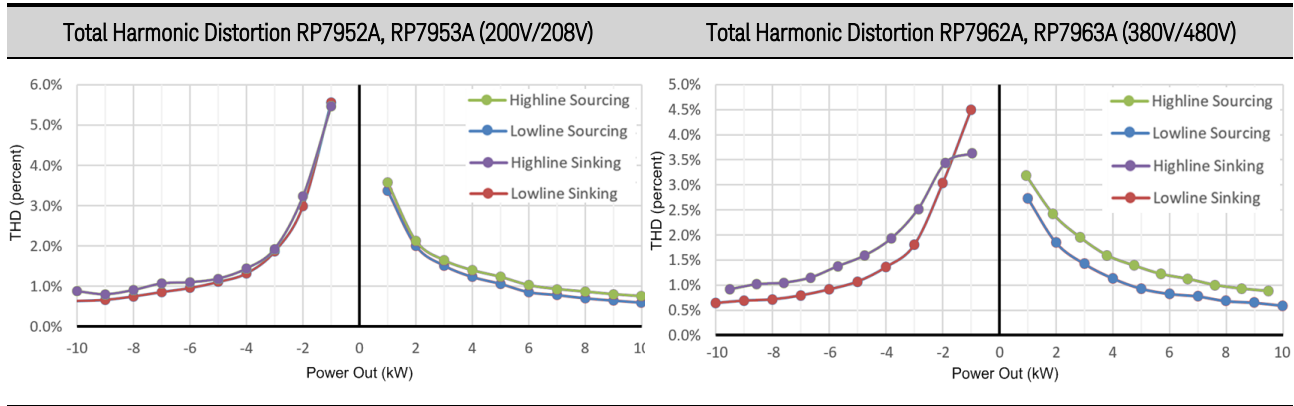
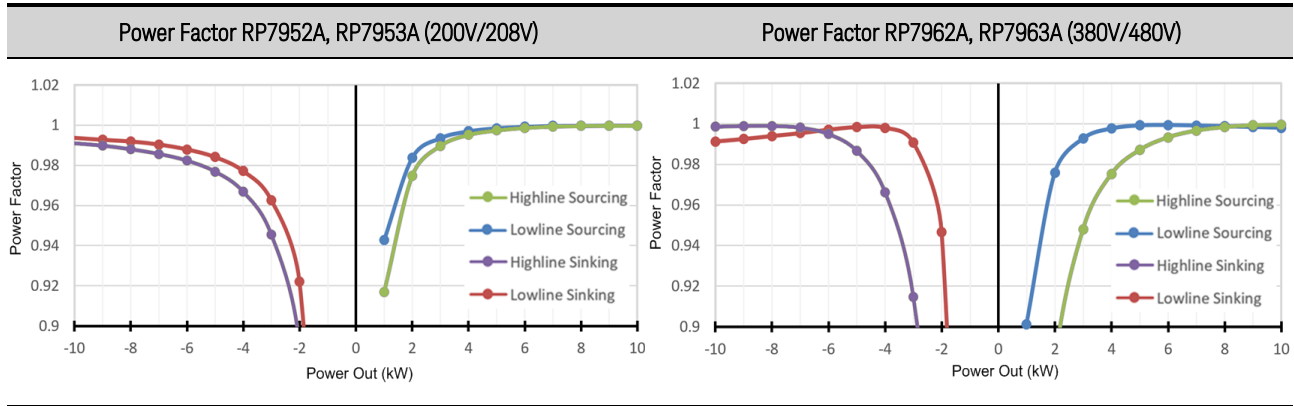

NOTE

If you are using lists or arbs to generate sinusoids near the grid frequency, there will be additional distortion currents in the line. Refer to the **Limiting Sinusoidal Outputs** section.

Output Impedance Graphs

All voltage priority impedance graphs are in High bandwidth. There are only minor differences at low frequencies on the graphs in Low bandwidth. The **bandwidth setting** has no effect in CC operation.

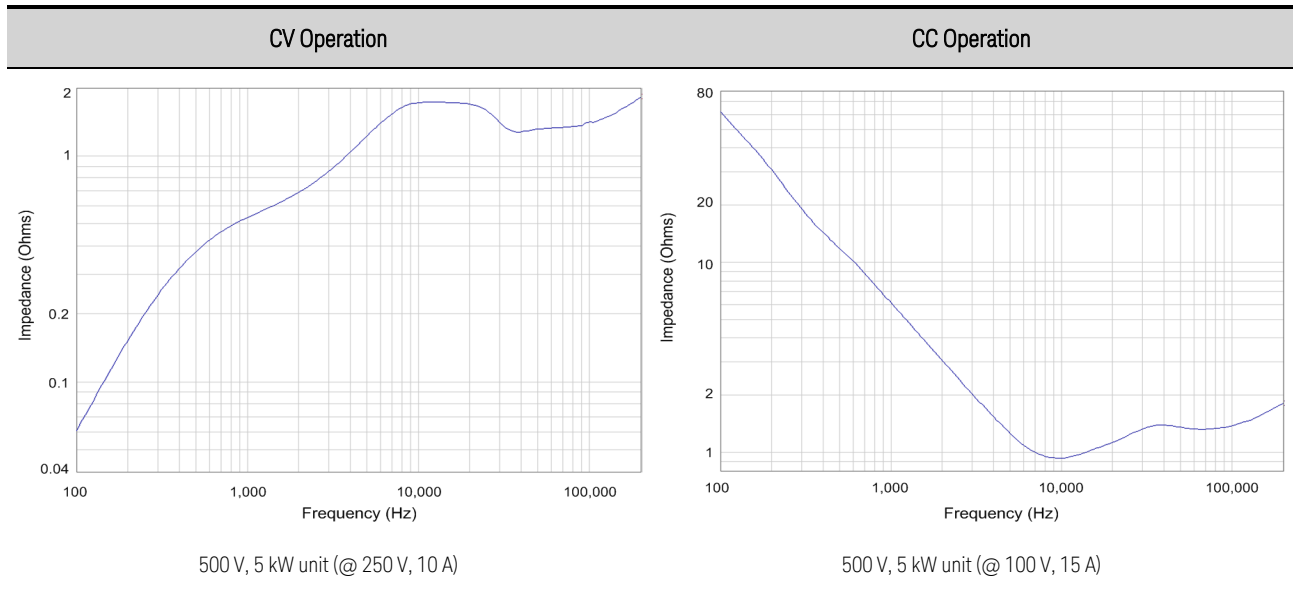

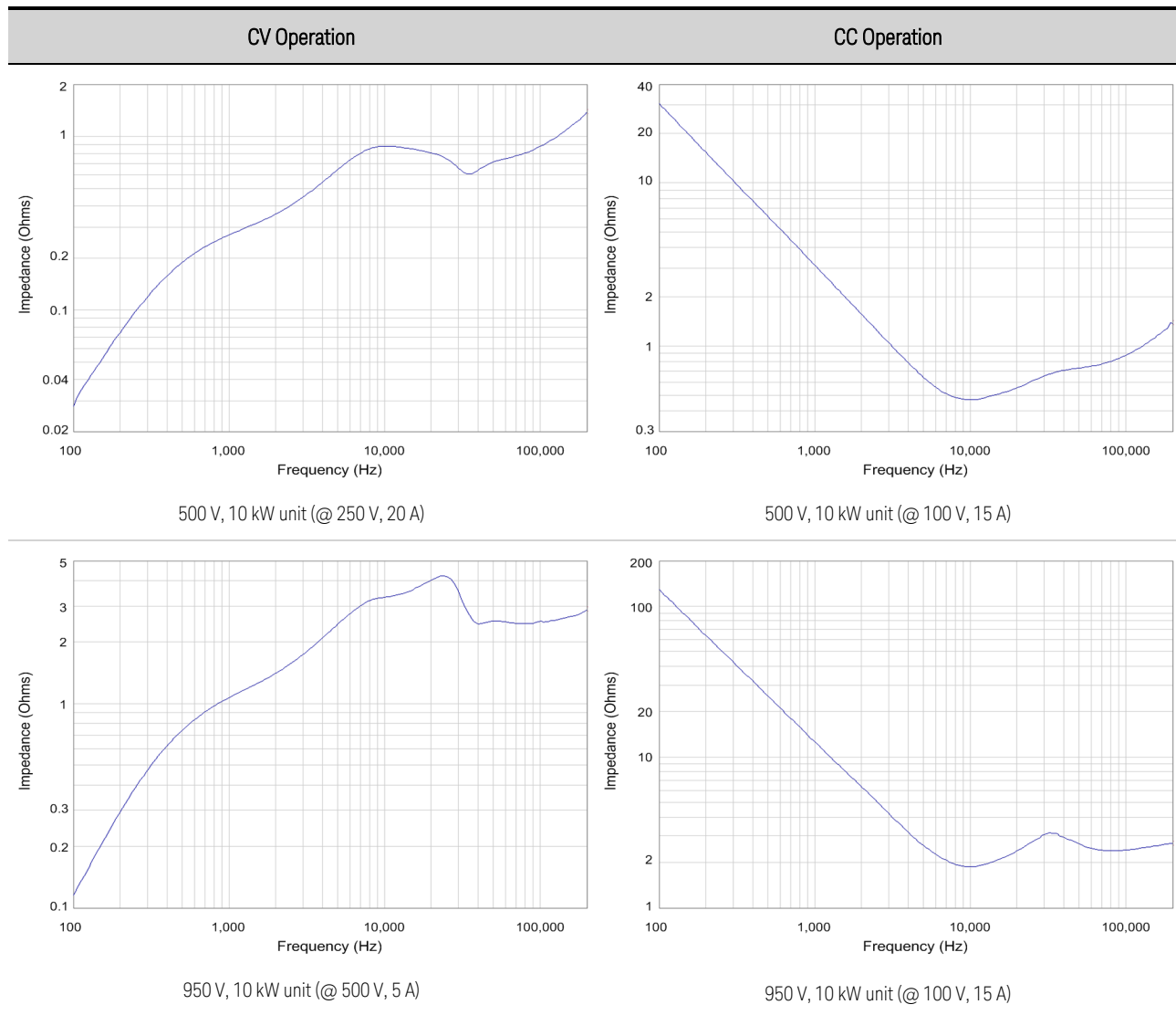

Inductive Load Boundary for Constant Current (CC) Operation

CAUTION

EQUIPMENT DAMAGE You must protect the solid-state output relays from damage with load inductance greater than $12.5 \mu\text{H}$ or twisted load leads longer than 15 meters (each wire). You can increase this length by paralleling additional twisted load leads. To minimize the di/dt and resulting voltage across the relays, make sure that the output current has been downprogrammed to zero before turning the output off.

The following figures show the boundary limitations for inductive loads (L) with series resistance (R_s) for constant current operation. Operation below the marginal stability line may result in output instability. Note that increased load resistance allows increased output inductance.

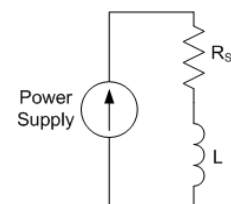

1 Quick Reference

500 V units 950 V units

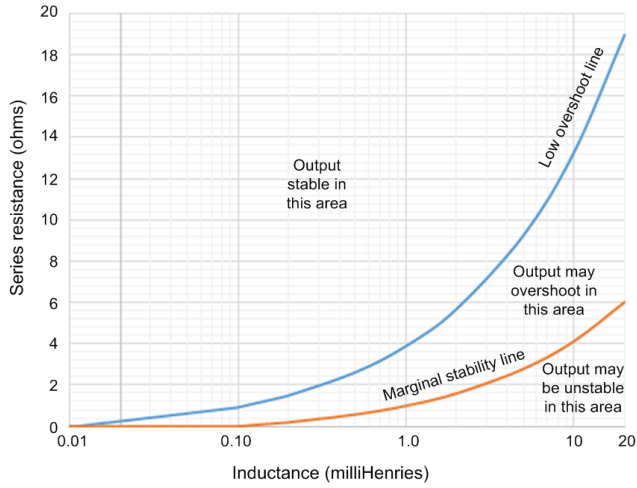

500 V, 10 kW unit

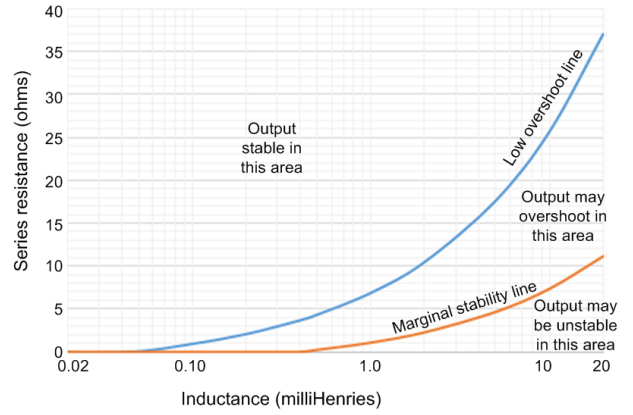

950 V, 10 kW unit

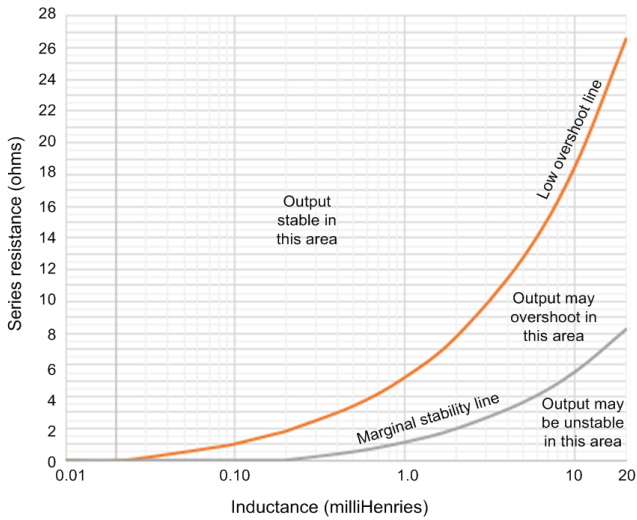

500 V, 5 kW unit

Capacitive Load Boundary for Constant Voltage (CV) Operation

The following figures show the boundary limitations for capacitive loads with equivalent series resistance for constant voltage operation. Operation *below* the two marginal stability lines when operating with either the High or Low **bandwidth setting** may result in output instability.

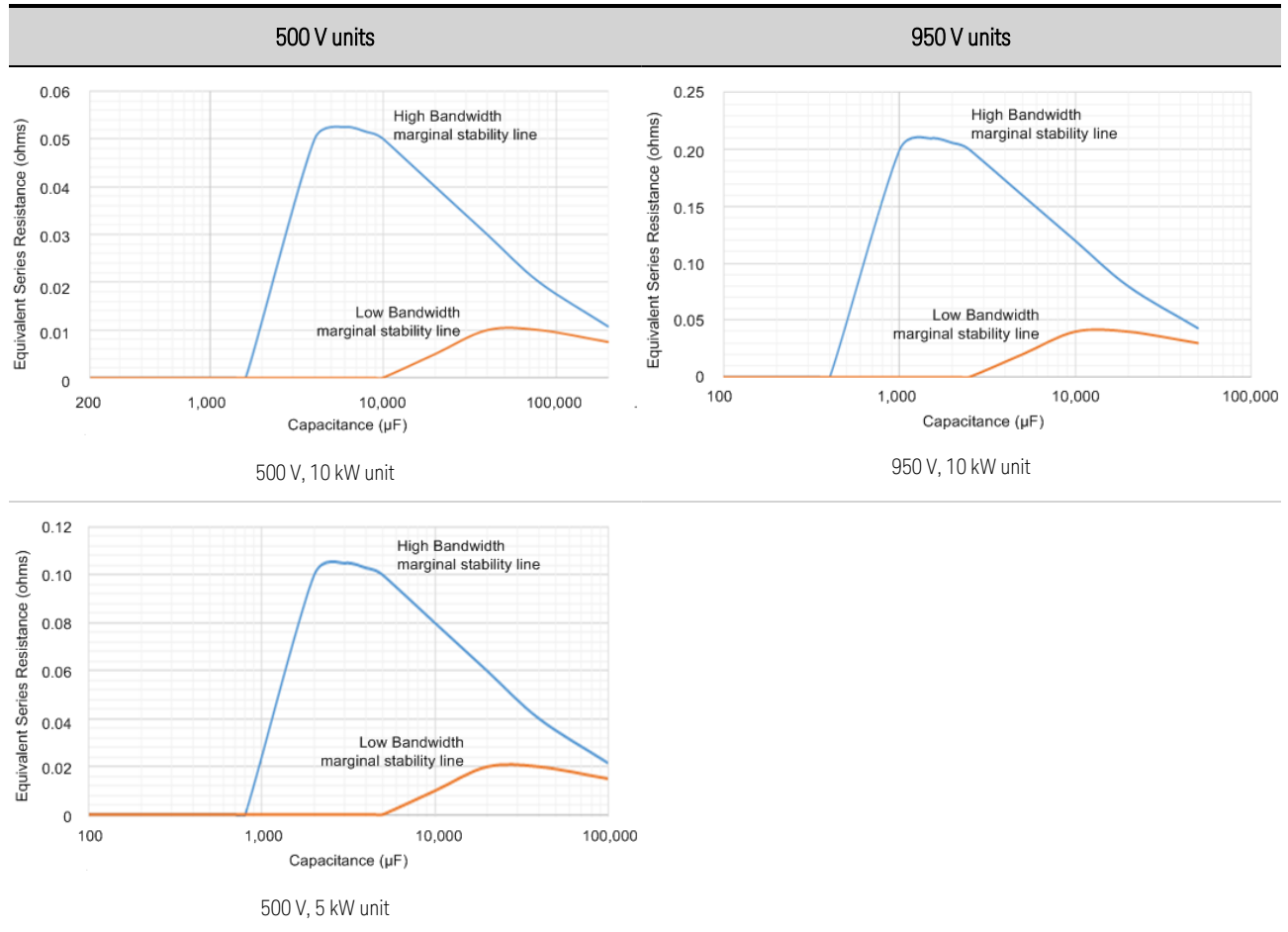

Voltage Programming Response (All Models)

The following graph shows the output voltage programming response characteristic. This applies for small signals only, under no load conditions.

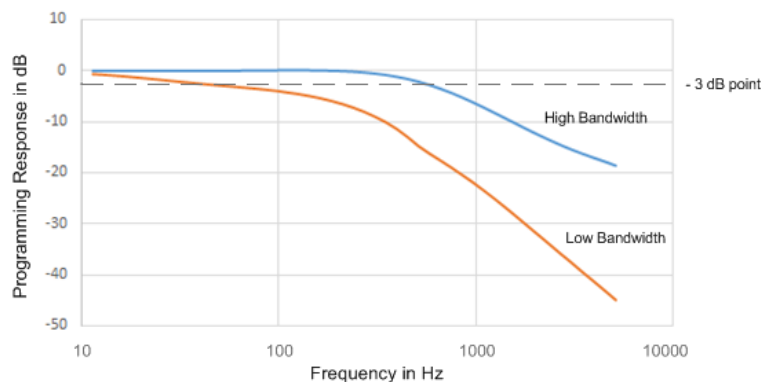

Excessive Dynamic Protection

The following graph shows the square wave amplitude thresholds versus frequency with no load. In the area above the indicated amplitude threshold, sustained generation of a square wave may engage the excessive dynamic protection (EDP) function, which disables the output. EDP protection may be engaged by programmed voltage changes, lists, Arbs, or load-induced voltage swings.

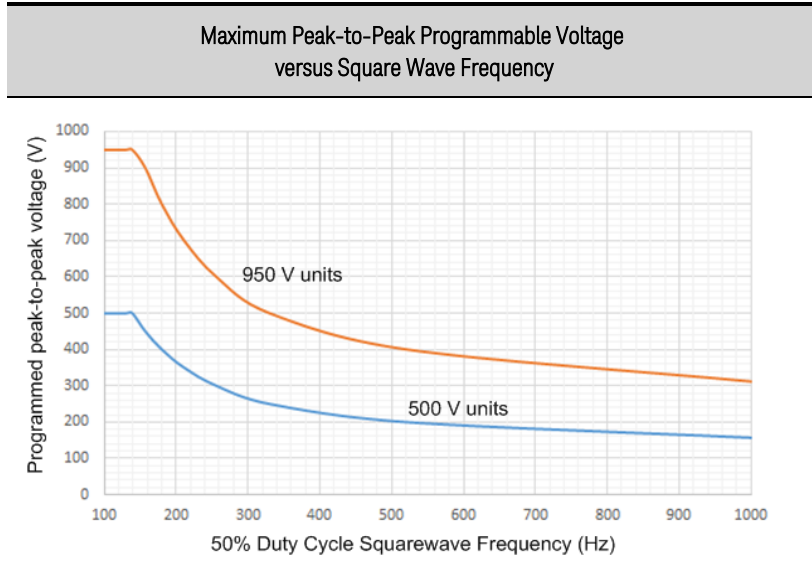

Output Quadrants

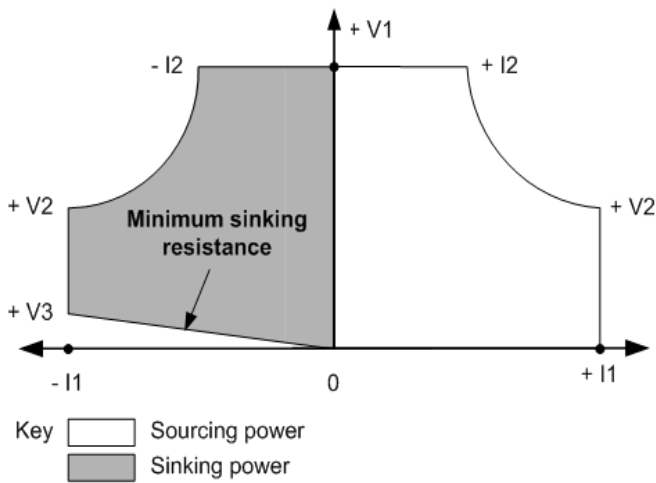

Model	+ V1	+ V2	+ V3	+/- I1	+/- I2	Minimum sink resistance
RP7951A/RP7961A	500 V	250 V	8 V	20 A	10 A	0.4 Ω
RP7952A/RP7962A	500 V	250 V	8 V	40 A	20 A	0.2 Ω
RP7953A/RP7963A	950 V	500 V	16 V	20 A	10.5 A	0.8 Ω

2

Installing the Instrument

Before Installation or Use

Rack Mounting

AC Mains Connections

Single Unit Output Connections

Multiple Unit Output Connections

Interface Connections

WARNING

Heavy Weight

Danger to hands and feet. To avoid personal injury and damage to the instrument, always use a sturdy cart or other suitable device to move the instrument. Do not lift the instrument alone; always use two people to lift the instrument.



Before Installation or Use

Inspect the Unit

When you receive your RPS unit, inspect it for any obvious damage that may have occurred during shipment. If there is damage, notify the shipping carrier and nearest Keysight Sales and Support Office immediately. Refer to www.keysight.com/find/assist. Until you have checked out the unit, save the shipping carton and packing materials in case the unit has to be returned.

Check for Items Supplied

Before getting started, check the following list and verify that you have received these items. If anything is missing, please contact your nearest Keysight Sales and Support Office.

RP7900A Items	Description	Part Number
Remote sense cable for RP795xA. RP796xA (installed)	High voltage cable with 2-pin connector for + and - sense	Keysight 5188-9516 Plug only: Phoenix Contact 1714278
Remote sense cable for RP793xA. RP794xA (installed)	Sense cable with 2-pin connector for + and - sense	Keysight 5190-4501 Plug only: Phoenix Contact 1952267
Digital connector plug ^{1,2}	8-pin connector for the digital port	Keysight 1253-6408; Phoenix Contact 1840421
Primary/secondary cable ^{1,2}	1 m cable (CAT6A) for Primary/secondary communication	Keysight 8121-2314
Input safety cover with bushing ^{1,2}	Safety cover for AC input with strain relief bushing	Cover only: Keysight 5066-1925 Bushing only: Keysight 1410-1901
Output safety cover ^{1,2}	Safety cover for high voltage output bus bars Safety cover for high current output bus bars	Keysight 5066-1927 Keysight 5188-9544
Sharing connector cable ¹	High-voltage cable with 3-pin connectors for the sharing port	Keysight 5188-9517 Plug only: Keysight 0360-3038; Phoenix Contact 1840379
Control safety cover ¹	Safety cover for current-sharing cable	Keysight 5066-1926
Ferrite core ¹	Ferrite core installs on the current sharing cable	Keysight 9170-2573
ESD cover with flange ^{1,2}	ESD cover for remote interface connections	Keysight 5003-2364 - cover Keysight 0515-1946 - screws
Hardware Kits RP795xA. RP796xA RP793xA. RP794xA	Nuts and bolts for + and - high voltage bus bars Nuts and bolts for + and - high current bus bars	Keysight 5067-6031 Keysight 5066-1936
Ferrite core for power cord	For earlier models RP7961A, RP7962A, RP7963A	Keysight 9170-2578
Calibration certificate	Calibration certificate referenced to serial number	None

¹ Parts are included in RP795xA. RP796xA Cover Kit, p/n 5066-1930.

² Parts are included in RP793xA. RP794xA Cover Kit, p/n 5066-1935.

SD1000A Items	Description	Part Number
Output power cable	Cable to connect the RP7900A output to the SD1000A input	Keysight 5188-2407
Hardware kit	Nuts and bolts for + and - bus bar connections	Keysight 5067-6031
Interface cable	1 m cable (CAT6A) for interfacing with RP7900A units	Keysight 8121-2314

Review Safety Information

This power supply is a Safety Class 1 instrument, which means it has a protective earth terminal. That terminal must be connected to earth ground through a power source equipped with an earth ground. Refer to the [Safety Summary](#) page for general safety information. Before installation or operation, check the power supply and review this guide for safety warnings and instructions. Safety warnings for specific procedures are located at appropriate places throughout this guide.

WARNING SHOCK HAZARD, LETHAL VOLTAGES Many models generate voltages greater than 60 VDC, with some models rated at 950 VDC! Ensure that all instrument connections, load wiring, and load connections are either insulated or covered using the safety covers provided, so that no accidental contact with lethal voltages can occur.

Observe Environmental Conditions

WARNING Do not operate the instrument in the presence of flammable gases or fumes.

The environmental conditions for the power supply are documented under [RP793xA-RP794xA](#) and [RP795xA-RP796xA](#) common characteristics. Basically, the unit should only be operated indoors in a controlled environment. Do not operate the unit in areas where the ambient temperature exceeds +55 degrees Celsius. This applies for rack-mounting as well as for bench use.

Provide Adequate Air Flow

CAUTION Do not block the air intake at the front, or the exhaust at the rear of the instrument.

The dimensions of your power supply as well as an outline diagram are given under [Outline Diagrams](#). Fans cool the power supply by drawing air through the front and exhausting it out the back. The unit must be installed in a location that allows sufficient space of at least 12 inches (30.5 cm) at the front and back of the unit for adequate air circulation.

Stacking Instruments

CAUTION Never stack more than three instruments on top of one another in a free-standing installation.

Outline Diagram for - RP793xA and RP794xA

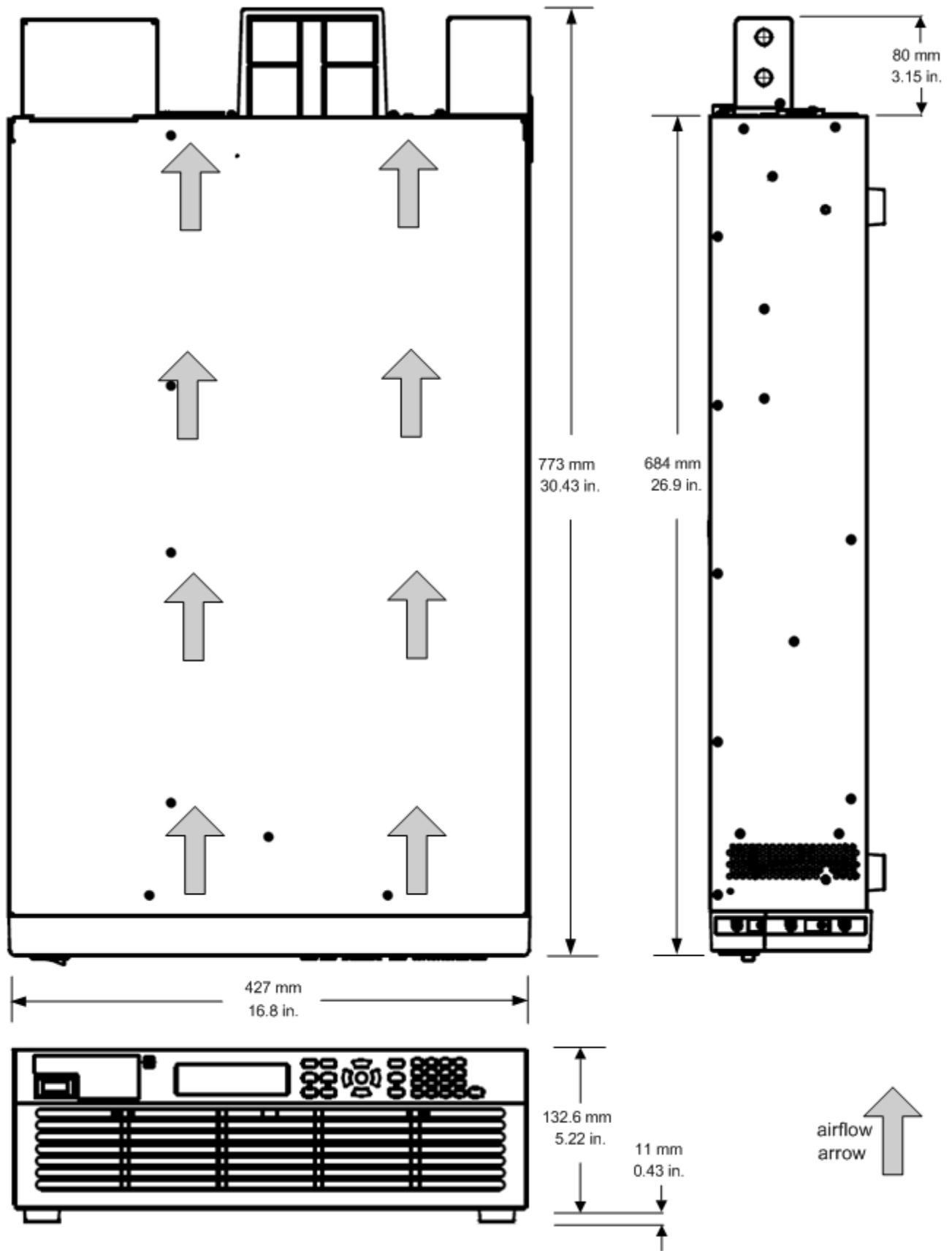

Outline Diagram for - RP795xA and RP796xA

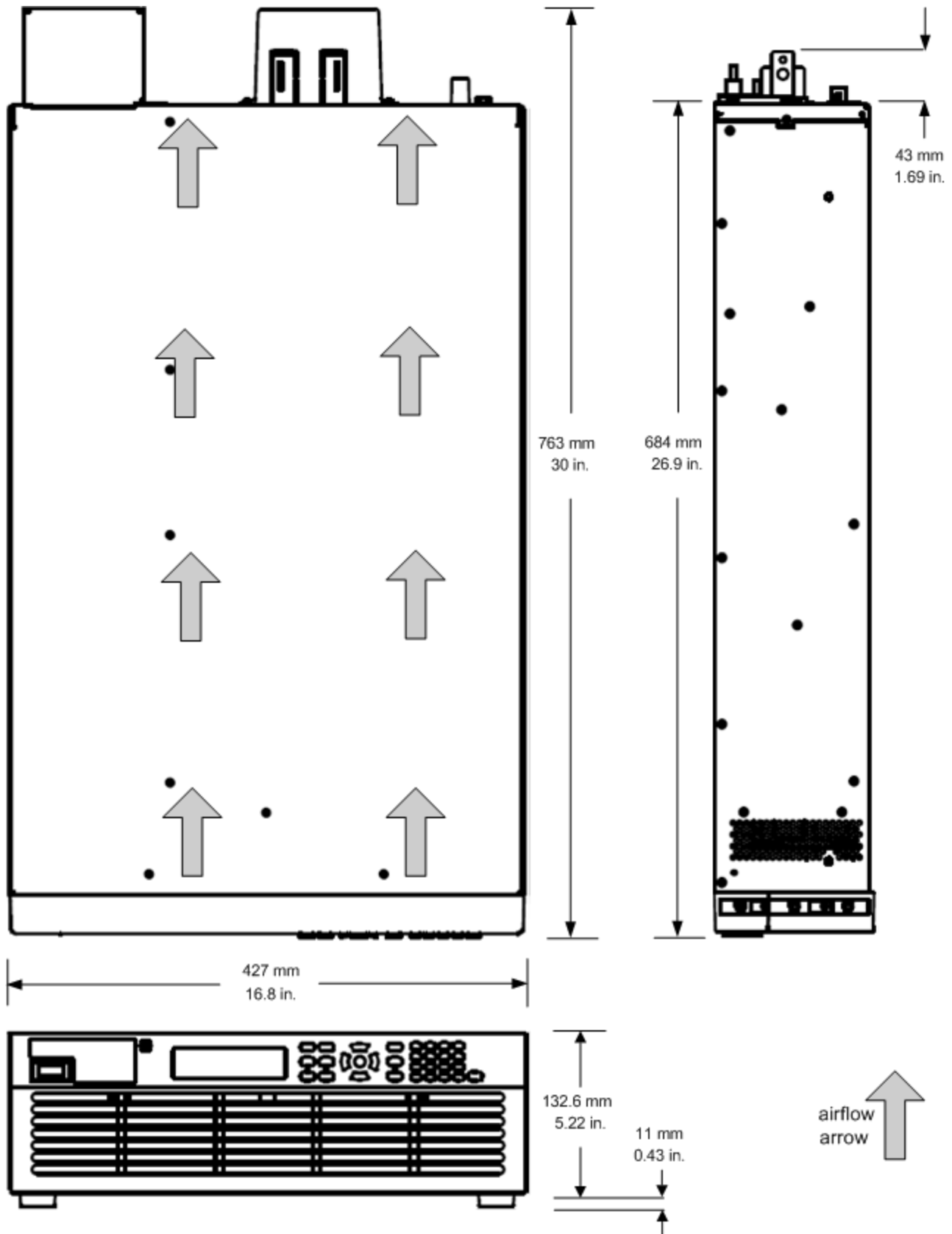

Rack Mounting

This section contains information for installing an RP7909A Rack Mount Kit. The rack mount kit allows the RPS units to be mounted in a 19-inch EIA rack cabinet.

Before getting started, check the following list and verify that you have received these items. If anything is missing, please contact your nearest Keysight Sales and Support Office.

Rack Mount Kit Contents	Keysight Part number
Slide rails, 2 pair (includes mounting hardware)	5003-1128
Rack Flange kit without handles - includes:	5067-6705
Flange mount, qty 2	5022-9638
Flange attachment screws, qty 6 (M4x0.7 10mm)	0515-1114
Front dress screws, qty 4 (10-32 x 0.625)	3030-1768
Metal clip-nuts, qty 4 (10-32 x 0.5)	0590-0804

Installing the Instrument

CAUTION

Keysight RP7900A series power supplies weigh as much as 70 lbs. (31.8 kg). Two people are required for installation. Do not lift or move the unit alone. Avoid moving the unit by hand. If unavoidable, lift only the unit's chassis; do not lift the unit using the output terminals.

Do not block the air intake at the front, or the exhaust at the rear of the instrument.

Tools required: Phillips driver, T22 Torx driver, T10 Torx driver.

1. Remove the four feet from the bottom of the instrument.
2. Install the ESD cover flange to the side of the instrument using the two screws provided. The flange and the screws (0515-1946) are provided in the Cover Kit (5066-1930) that is shipped with the instrument.
3. Install the slide rails 5003-1128. Refer to the slide rail instructions.
 - a. Install the movable part of each slide rail to the sides of the instrument using the four screws provided (0515-1013).
 - b. Install four clip-nuts on the rack frame where your instrument will be located. Install one clip nut on each corner (0590-0804).
 - c. Install the stationary part of each slide rail to the sides of the rack frame using the four screws provided (2680-0104).
4. Install the two flange mounts to the front panel corners of the instrument using the six screws provided (0515-1114).

5. Install four clip nuts on the front of the rack frame for attaching the front panel (0590-0804).
6. Slide the instrument into the rack.
7. Attach the front panel to the instrument to the rack using the four dress screws provided (3030-1768).

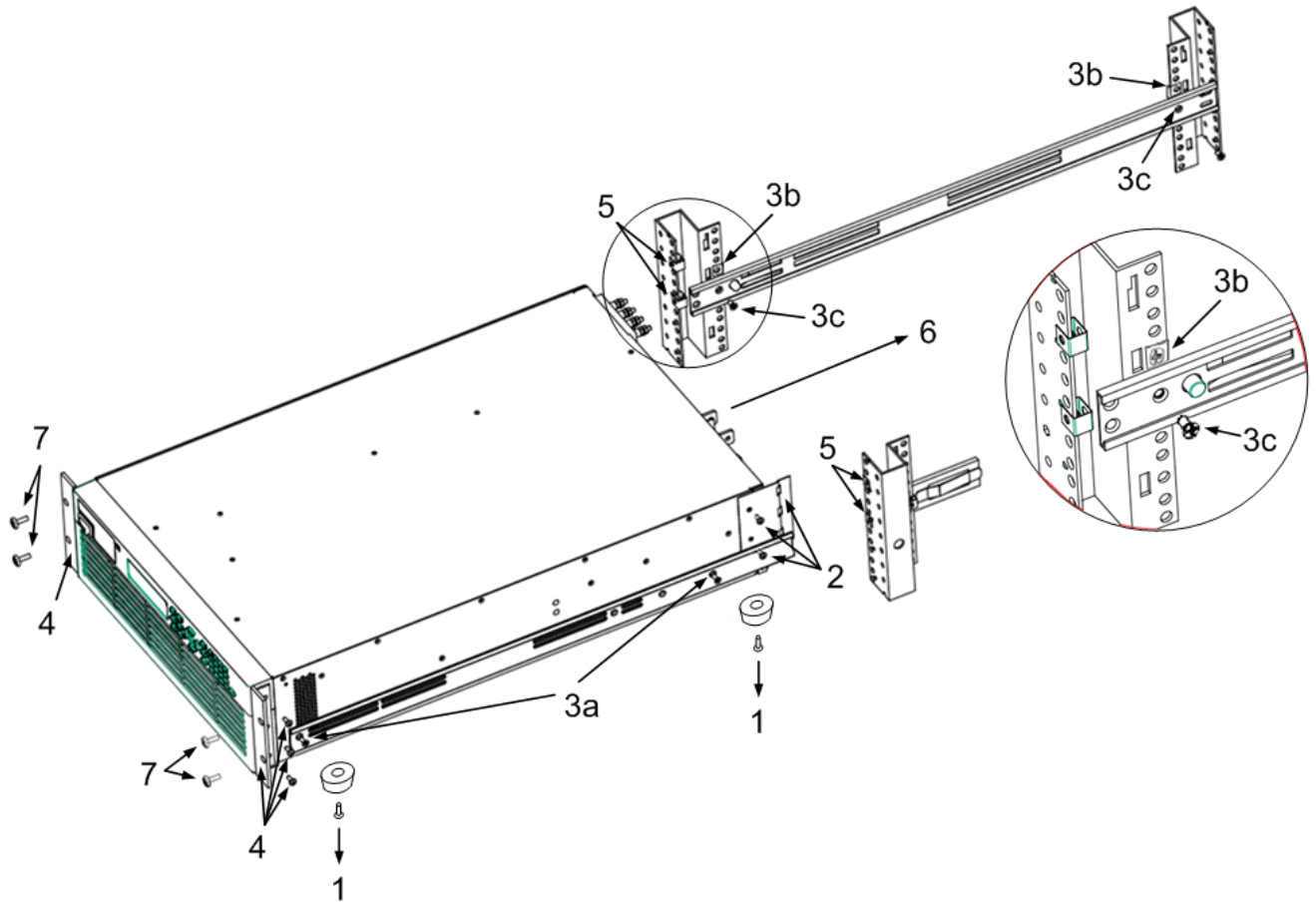

AC Mains Connections

AC Mains Considerations

Delta and Wye Type AC Distribution Considerations

Surge Protector Installation

Power Cable Connections

AC Mains Considerations

Keysight RPS models have a fully bi-directional three-phase AC input converter, which allows for seamless bi-directional power flow between the AC mains and DC output terminals. In a standard power supply, energy only flows from the AC to the DC output terminals. In a regenerative power supply, energy also flows from the DC output terminals back to the AC mains whenever the unit is sinking current, either from rapid downprogramming of the output or from discharging an energy source such as a battery. This return of energy back to the AC mains is called regenerative operation.

The AC input converter of the RPS unit employs firmware algorithms to maintain high power factor and low total harmonic distortion across a wide range of operating conditions. For more information, refer to the AC input portion under [RP793xA-RP794xA](#) and [RP795xA-RP796xA](#) common characteristics, and the [Limiting Sinusoidal Outputs](#) section.

Follow all wiring instructions for the power cord provided in this section of the manual.

CAUTION

Exceeding the AC input voltage rating or mis-wiring the line connection can create permanent damage in the following devices.

The following components are used to provide immunity against line-to-line transients as high as 1 kV, and line-to-ground transients as high as 2 kV:

- 600 Vrms voltage limit devices are installed on 400 VAC units, between line-to-line connections.
- 300 Vrms voltage limit devices are installed on 200 VAC units, between line-to-line connections.

Several internal protection functions are used to safeguard the instrument against abnormal line conditions. The following conditions cause the instrument to shut down:

- If the line voltage is greater than 120% of the highest nominal rating for two line cycles.
- If the line current is greater than 120% of the highest expected line current for about one second.
- If the line frequency shifts more than 2 Hz from the initial line frequency for more than two seconds.
- If a three-cycle line dropout occurs.

The instrument will automatically reboot if the fault condition is no longer present. The output will remain off after reboot until the operator reinstates the previous settings, either by the front panel controls or a computer program. This behavior is consistent with safe operating procedures.

The following condition will force the output into a protection state and produce a power fail (PF) status flag:

- If the line voltage is less than 85% of the lowest nominal rating for more than one second.

The following condition will prevent the instrument from turning on:

- If the line frequency is outside the range of 46.5 Hz to 63.5 Hz.

In case of an AC mains power failure, the unit will automatically disconnect from the line. This will occur with the unit either sourcing or sinking current.

Delta and Wye Type AC Distribution Considerations

Keysight RPS models can operate with Y-type or delta-type three-phase AC distribution. Configurations shown below are recommended for the 200/208 VAC units. When operating with Delta configurations, the unit should be operated either in a permanently connected configuration or use an AC input connector compliant with IEC 60309. If neither of the above is possible, a secondary conductor in addition to the ground in the three-phase connection) must be used to connect the instrument chassis to earth ground.

AC mains connections must be made by a qualified electrician who knows about 3-phase mains circuits and all applicable safety standards and requirements.

Configurations for 200/208 VAC units

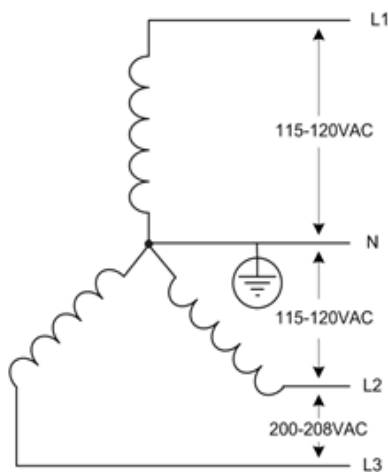

Do not connect the Neutral to the instrument.

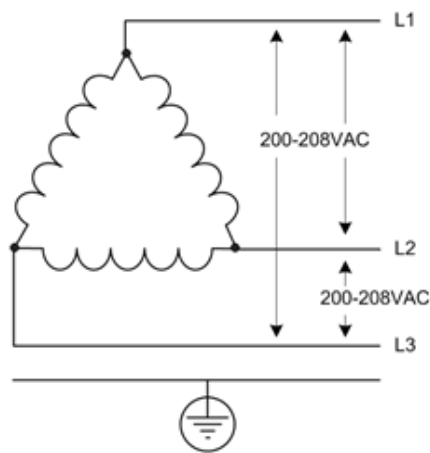

This is a floating Delta-type.

2 Installing the Instrument

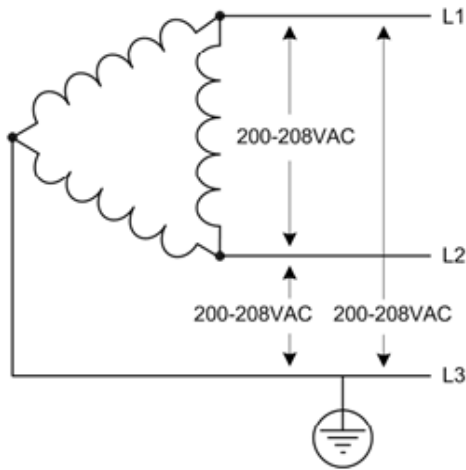

This is a Delta-type with corner ground.

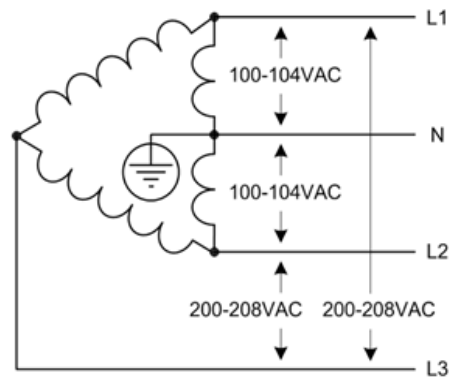

This is a Delta-type with high-leg ground.

Configurations for 400/480 VAC units

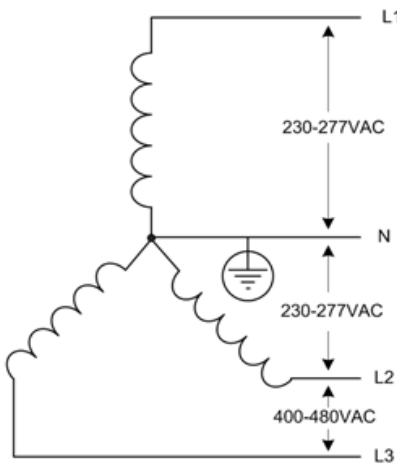

Do not connect the Neutral to the instrument.

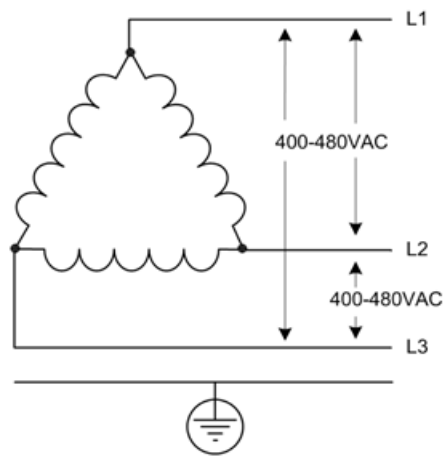

This is a floating Delta-type.

Surge Protector Installation

A Surge Protector (Kit p/n RP7961A-60007) is required for Keysight models RP7941A, RP7942A, RP7943A, RP7945A, RP7946A, RP7961A, RP7962A, and RP7963A.

CAUTION

Equipment Damage. The steady-state line rating for the surge protector is 350 VAC maximum line-to-earth; and 600 VAC maximum line-to-line.

Before getting started, check the following list and verify that you have received these items. If anything is missing, please contact your nearest Keysight Sales and Support Office.

Line Surge Protector PCA 400V - p/n 5067-6846

Screw Torx-T10 M3X0.5 35 mm - p/n 0515-1038

Bolt Hex M5X0.8 35 mm qty 3 - p/n 0515-6395

WARNING

SHOCK HAZARD. Disconnect the power cord from the AC mains before installing the surge protector..

Tools required: 8 mm Hex driver for M5 bolt, T10 Torx driver for M3 screw.

1. Remove the three existing M5 bolts from the AC input assembly using the 8 mm Hex driver. Also remove the M3 screw in the chassis to the right of the ground stud using the T10 Torx driver.

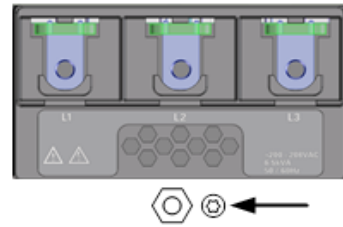

2. Position the surge protector over the AC input assembly and attach it using the M3 35 mm long screw provided with the surge protector (item A). Torque the screw using the T10 Torx driver to 9 in-lbs.

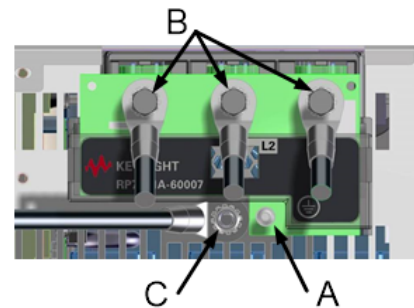

3. Install the AC line ring lugs (L1, L2, and L3) to the surge protector (item A). Use the three M5 35 mm long bolts provided with the surge protector (item C), and three lock washers originally provided with the AC input assembly (item B) to attach the wires and the surge protector to the AC input assembly (item B in Step 2). Torque the bolts using the 8 mm Hex driver to 20 in-lbs.

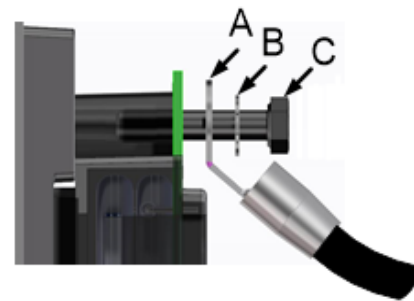

NOTE: Do NOT use the additional lock washers provided with the original M5 bolts, or the original M3 screw provided on the unit.

4. If you have not already done so, install the ground wire ring lug over the ground stud located directly below the AC input assembly (item C in Step 2). Torque the M5 combination nut using the 8 mm driver to 20 in-lbs.
5. Install the AC input cover and strain relief as described under Power Cord Installation.

Power Cable Connections

NOTE

Compliance to all regulations for the operation of and connection to the public grid of energy back-feeding equipment is required.

Connections must be made by a qualified electrician who knows about energy back-feeding equipment to ensure that all applicable safety requirements have been applied and all necessary conditions have been met. Knowledge about 3-phase mains circuits and all applicable safety standards and requirements is also required.

An AC mains power cable is not provided with the unit.

Refer to the following table for the maximum current capacity requirements for each cable conductor.

If required by local electrical codes, install a fuse or circuit breaker between the ac mains and the unit. Refer to the following table for current ratings.

Keep the AC mains cables as short as possible. The longer the cable, the greater the voltage loss due to cable resistance.

WARNING

The cable cross-section must be suitable for the maximum input current of the instrument. The ground cable must have the same cross-section as the phase cable.

NOTE

Safety agency requirements dictate that there must be a way to physically disconnect the AC mains cable from the unit. A disconnect device, either a switch or circuit breaker must be provided in the final installation. The disconnect device must be close to the equipment, be easily accessible, and be marked as the disconnect device for this equipment. It must meet the input ratings requirements listed in the following table.

Model	Unit Rating	L1 I _{max}	L2 I _{max}	L3 I _{max}
RP7931A, RP7932A, RP7951A	5 kW - 200/208 VAC	19.5 A	19.5 A	19.5 A
RP7941A, RP7942A, RP7961A	5 kW - 400/480 VAC	9.5 A	9.5 A	9.5 A
RP7933A, RP7935A, RP7936A, RP7952A, RP7953A	10 kW - 200/208 VAC	39 A	39 A	39 A
RP7943A, RP7945A, , RP7946A, RP7962A, RP7963A	10 kW - 400/480 VAC	19 A	19 A	19 A

Either a delta-type or a Y-type AC mains distribution can be used, provided that the correct line-to-line voltage is applied (see above). **Do not connect the neutral wire on Y-type AC mains distribution.** An earth-ground to chassis-ground connection through a separate conductor must always be provided.

Power Cord Installation

WARNING

SHOCK HAZARD The instrument requires a chassis ground connection through a separate conductor. The AC mains must include an earth ground connection. AC mains connections must be made by a qualified electrician who knows about 3-phase mains circuits and all applicable safety standards and requirements.

In cases where the unit is not hardwired to the electrical system, a locking connector scheme should be used such as UL 498, IEC 60309, or equivalent. Consult a local electrician for the connector scheme appropriate for your region.

208V/30A examples:

<https://www.grainger.com/product/HUBBELL-WIRING-DEVICE-KELLEMS-30-Amp-Industrial-Grade-Locking-6C549>

480V/30A examples:

<https://www.grainger.com/product/HUBBELL-WIRING-DEVICE-KELLEMS-30-Amp-Industrial-Grade-Locking-6C549>

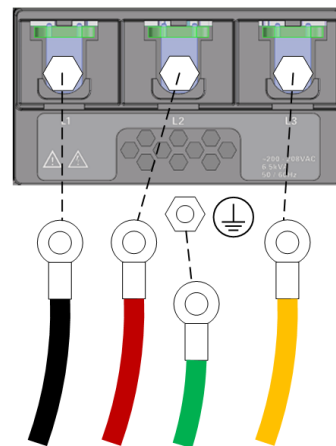
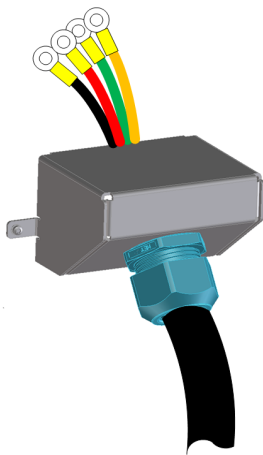

- If attached, remove the safety cover from the unit.
- Insert the terminated ends of the power cord through the strain relief of the safety cover. The safety cover strain relief is designed to accommodate both a wire cable, or individual wires.
- Do not tighten the strain relief until all wire connections are complete.
- Attach the safety cover to the unit.
- Attach the ring-terminated line wires to the AC mains terminals (U.S. color code shown). The bolt diameter is M5. Place the ring terminals between the star washers. Connect the ground wire to the chassis stud *below* the AC line filter assembly.
If provided, do not connect the neutral wire.
- Tighten the terminal bolts to 23 in-lb (2.6 Nm).
- Note that on earlier units, the AC mains terminals have hex-nut terminal connections.

2 Installing the Instrument

Ferrite Core Installation - for earlier RP7961A, RP7962A, RP7963A models

For 400/480 VAC input units that have hex-nut terminal connections (not bolts), install a ferrite core (p/n 9170-2578) to reduce RFI interference.

Place the core as close as possible to the input cover as shown.

Place a tie-wrap behind the core to prevent it from sliding down the power cord.

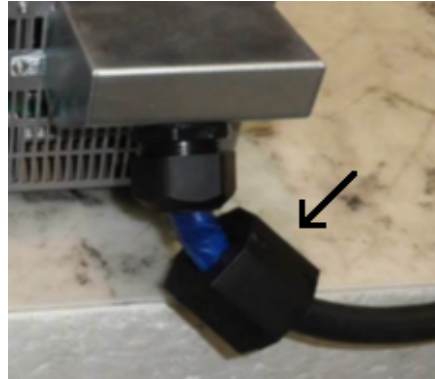

Single Unit Output Connections

Output Connections

Single Load Connections

Multiple Load Connections

Remote Sense Connections

Additional Load Considerations - all Models

Additional Load Considerations - RP793xA, RP794xA

Output Connections

Sense Connections

Ensure that the sense cable is installed on the back of the instrument as shown. The only time the sense cable should be disconnected from the output bus bars is when **remote sensing**.

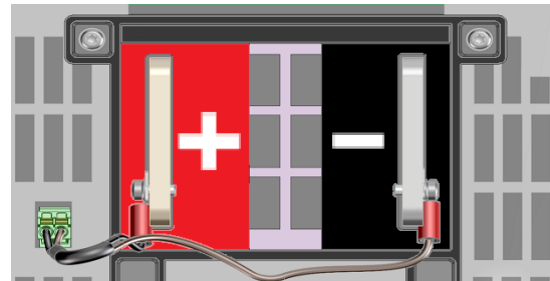

If the sense cable is not installed prior to instrument turn-on or becomes disconnected, the unit will continue to operate. The open-circuit voltage at the output terminals will be anywhere from 0% to 0.54% higher than the programmed value because the regulation point is now maintained through internal sense-protect resistors. The following table gives the change in voltage **at the output terminals** as a percent of the voltage setting when the sense leads are not connected. The readback voltage will still appear to be at the programmed value.

Model	Δ Gain percent
RP7931A, RP7941A, RP7933A, RP7943A *	0 %
RP7932A, RP7942A, RP7935A, RP7945A	+ 0.54 %
RP7936A, RP7946A	+ 0.27 %
RP7951A, RP7952A, RP7961A, RP7962A	+ 0.13 %
RP7953A, RP7963A	+ 0.06 %

* For the 20 V RPS units only, the sense leads are buffered so that there is virtually no change in the open-circuit output voltage if the sense cable is not installed or becomes disconnected.

Bus Bar Connections

WARNING **SHOCK HAZARD, LETHAL VOLTAGES** Many models generate voltages greater than 60 VDC, with some models rated at 950 VDC! Ensure that all instrument connections, load wiring, and load connections are either insulated or covered using the safety covers provided, so that no accidental contact with lethal voltages can occur.

The following factors should be considered when wiring the load to the power supply:

- Load wire current carrying capacity
- Load wire insulation rating (must be equivalent to the maximum output voltage)
- Load wire voltage drop
- Load wire noise and impedance effect

Wire Size

WARNING **FIRE HAZARD** To satisfy safety requirements, load wires must be large enough not to overheat when carrying the maximum short-circuit output current. If there is more than one load, any pair of load wires must be capable of safely carrying the full-rated current of the unit. Paralleled load wires may be required for larger-ampacity models.

The following table lists the characteristics of AWG (American Wire Gauge) copper wire.

AWG	Equivalent mm ²	Nearest Metric size	Ampacity (Note 1)	Resistance (Note 2)
18	0.82	1.0 mm ²	up to 14 A	6.385 Ω
16	1.31	1.5 mm ²	up to 18 A	4.016 Ω
14	2.1	2.5 mm ²	up to 25 A	2.525 Ω
12	3.3	4 mm ²	up to 30 A	1.588 Ω
10	5.3	6 mm ²	up to 40 A	0.999 Ω
8	8.4	10 mm ²	up to 60 A	0.628 Ω
6	13.3	16 mm ²	up to 80 A	0.395 Ω
4	21.2	25 mm ²	up to 105 A	0.248 Ω
2	33.6	35 mm ²	up to 140 A	0.156 Ω
1/0	53.5	50 mm ²	up to 195 A	0.098 Ω
2/0	67.4	70 mm ²	up to 225 A	0.078 Ω
3/0	85	95 mm ²	up to 260 A	0.062 Ω
4/0	107	120 mm ²	up to 300 A	0.049 Ω
6.2/0 (350 MCM)	177	185 mm ²	up to 420 A	N/A

Note 1 Ampacity is based on a single conductor **in free air**, 26–30 °C ambient temperature with the conductor rated at 60 °C. Ampacity decreases at higher temperatures.

Note 2 Resistance is in ohms/1000 feet, at 20 °C wire temperature.

Along with temperature, you must also consider voltage drop when selecting wire sizes. The RPS will tolerate a voltage drop of 1 V per lead while maintaining the specified programming and measurement accuracy (see **RP793xA-RP794xA** and **RP795xA-RP796xA** specifications). Voltage drops of up to 25% of the rated output voltage per lead will be tolerated with only slightly reduced programming and measurement accuracy. Of course, any voltage drop in the load leads reduces the maximum voltage available at the load. Subtract the load lead drop from the rated voltage of the unit to determine the maximum voltage available at the load.

Single Load Connections

1. As shown in the following figure, terminate all load wires with wire terminal lugs securely attached. DO NOT use unterminated wires for load connections at the power supply.
2. Route the wires through the safety cover before attaching them to the bus bars. Knockouts are provided on for larger diameter wires. The figure illustrates the recommended hardware for connecting wires to the bus bars. You must provide all cabling. Ensure that the wire-mounting hardware does not short the output terminals.
3. When attaching terminal lugs to the bus bars, ensure there is enough room for the safety cover. Twist or bundle the load wires to reduce lead inductance and noise pickup. The goal is to minimize the loop area or physical space between the + and - output leads from the bus bars to the load.
4. Attach the safety cover to the rear panel. Note that heavy wiring cables must have some form of strain relief to prevent bending the safety cover or bus bars.

High Voltage Models - RP795xA and RP796xA RP795xA, RP796xA

CAUTION

Tightening torque of the output bolts cannot exceed 10.8 Nm (8 lb-ft).

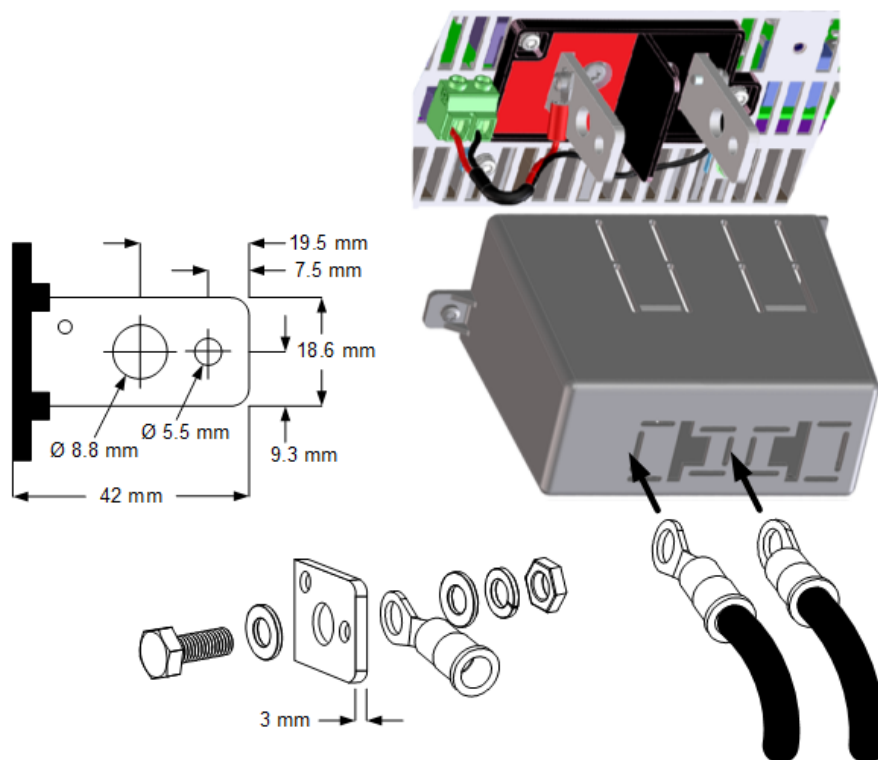

2 Installing the Instrument

High Current Models - RP793xA and RP794xA RP793xA, RP794xA

CAUTION

Tightening torque of the output bolts cannot exceed 20.3 Nm (15 lb-ft).

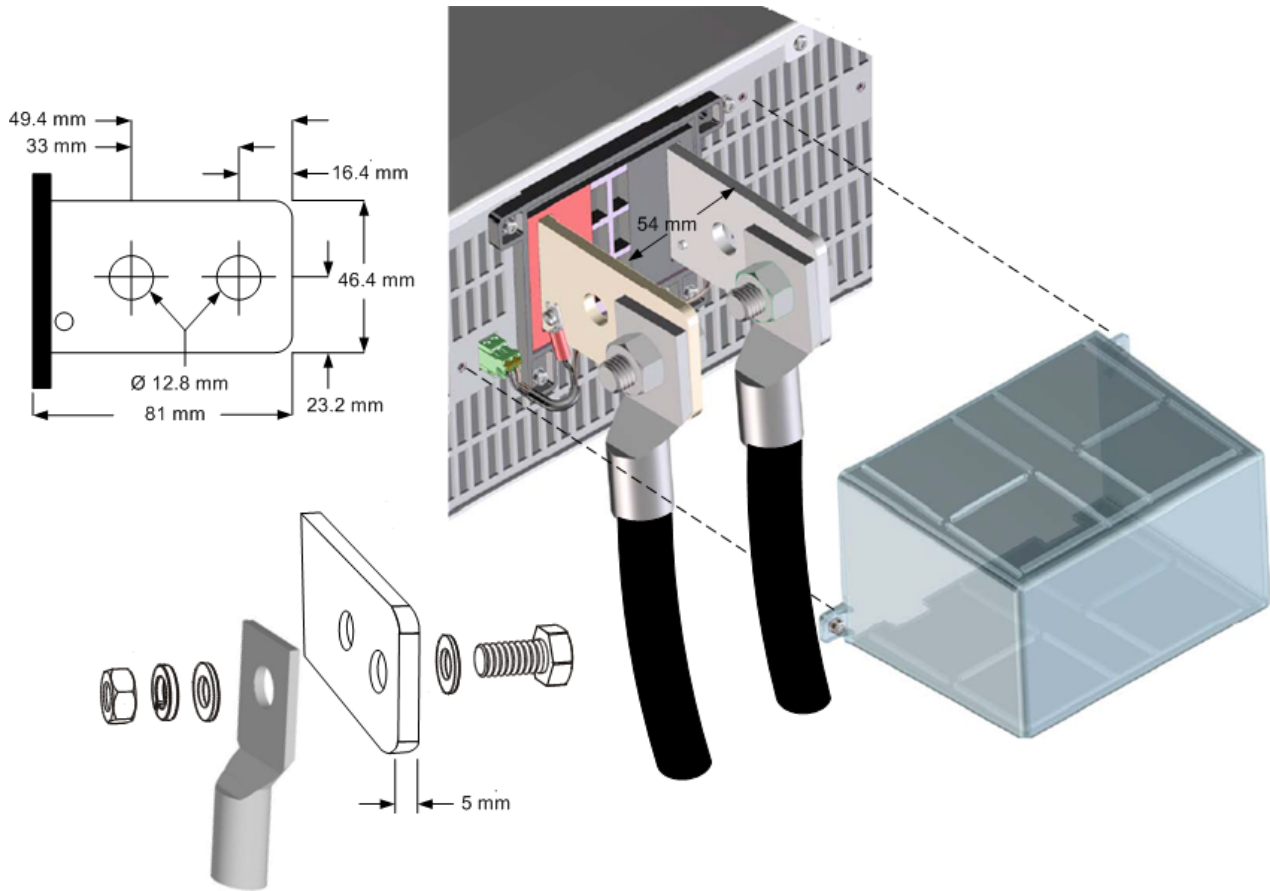

Multiple Load Connections

If you are using local sensing and are connecting multiple loads to one output, connect each load to the output terminals using separate connecting wires as shown in the following figure. This minimizes mutual coupling effects and takes full advantage of the power supply's low output impedance. Keep each pair of wires as short as possible and twist or bundle them to reduce lead inductance and noise pickup. The goal is to minimize the loop area or physical space between the + and - output leads from the bus bars to the load.

If load considerations require the use of distribution terminals that are located away from the power supply, twist or bundle the wires from the output terminals to the remote distribution terminals. Connect each load to the distribution terminals separately. Remote voltage sensing is recommended under these circumstances. Sense either at the remote distribution terminals or, if one load is more sensitive than the others, directly at the critical load.

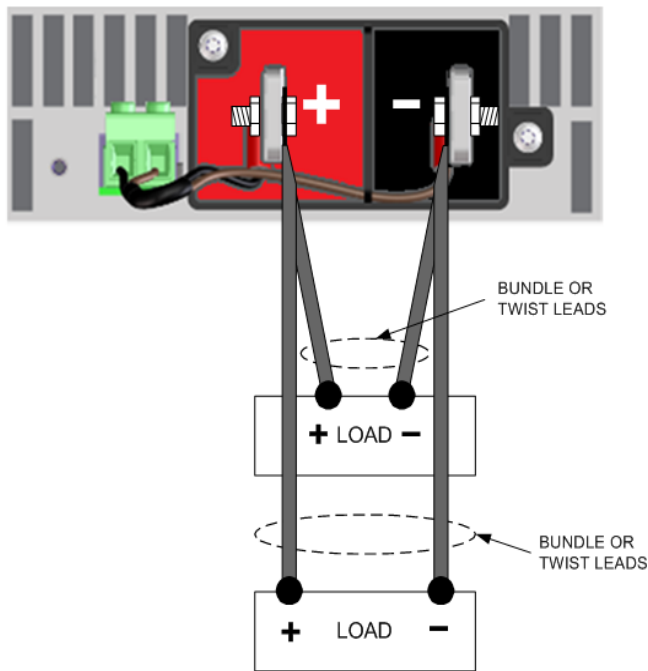

Remote Sense Connections

Remote sensing improves the voltage regulation at the load by monitoring the voltage there instead of at the output terminals. This allows the power supply to automatically compensate for the voltage drop in the load leads. Remote sensing is especially useful for CV operation with load impedances that vary or have significant lead resistance. It has no effect during CC operation. Because sensing is independent of other power supply functions, remote sensing can be used regardless of how the power supply is programmed.

Connect the unit for remote sensing by first removing the local sense cable between the sense and load terminals. Then make your connections as shown in the following figure.

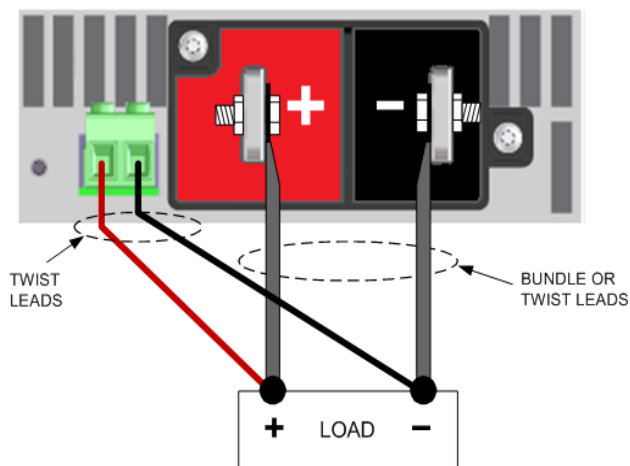

Connect the output terminals to the load using separate connecting wires. Keep the wire-pair as short as possible and twist or bundle it to reduce lead inductance and noise pickup.

2 Installing the Instrument

Sense connectors accept wire sizes between AWG 16 (1.5 mm²) maximum and AWG 24 (0.2 mm²) minimum. Strip the wire insulation back 10 mm. Tighten the screws securely.

Connect the sense leads as close to the load as possible. Do NOT bundle the sense wire-pair together with the load leads; keep the load wires and sense wires separate. Sense wiring can be of a lighter gauge than the load wiring. The sense leads can carry up to 1 mA of current without degrading the current measurement.

NOTE

Keep the sense lead resistance less than about 0.5 Ω per lead (this requires 20 AWG or heavier for a 50 foot length).

Note however, that any voltage drop in the sense leads can degrade the output voltage regulation. As the voltage drop in the load leads increases, the load voltage regulation error due to sense-lead resistance increases according to the following formula:

$$\Delta V_{\text{regulation}} = 2(V_{\text{load}}(R_{\text{sense}}/S_{\text{protect}}))$$

R_{sense} is the resistance in ohms of each sense lead. V_{load} is the voltage drop in each load lead. S_{protect} is the internal sense protect resistor (see table).

The formula assumes that the voltage drop in the + and - sense leads and in the + and - load leads are equal.

Model	S_{protect} resistor
RP7931A, RP7941A, RP7933A, RP7943A	1.96 k Ω
RP7932A, RP7942A, RP7935A, RP7945A	524 Ω
RP7936A, RP7946A	524 Ω
RP7951A, RP7952A, RP7961A, RP7962A	1.6 k Ω
RP7953A, RP7963A	1.5 k Ω

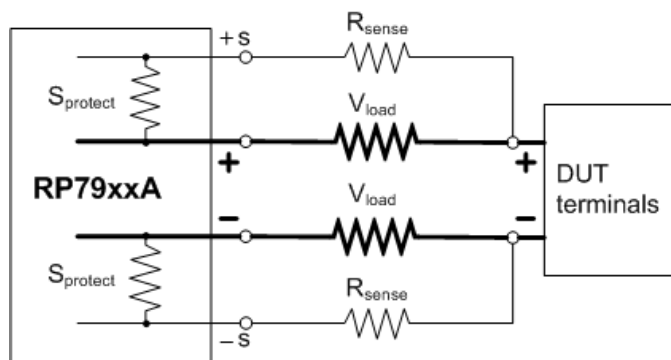

If the remote sense wires open during normal operation (with output current present), the change in output voltage **at the load** will depend on the load current and the wire resistances involved. When the sense leads open, the unit automatically reverts to local sensing. The voltage at the previous remote sense point (usually at the load) will drop by an amount given by the following equation:

$$\Delta V = I_{\text{out}} \times (\text{total resistance of load wiring})$$

Conversely, if the unit were sinking current, the voltage at the previous remote sense point would rise by the same amount.

Shorted sense leads are detected by the over-voltage protection function. This function results in the output being disabled due to an over-voltage fault (OV).

Reversed sense leads are detected by the negative over-voltage protection function. This results in the output being disabled due to a negative over-voltage fault (OV).

Refer to **Additional Load Considerations - RP793xA, RP794xA** for information about lead inductance when using remote sensing with load capacitance and lead inductance.

Over-voltage Protection

Over-voltage protection (OVP) provides a configurable over-voltage protection based on sense lead voltage. Having the OVP circuit monitor the sense lead voltage rather than the output terminal voltage allows for more precise voltage monitoring directly at the load.

Note that due to the voltage drop in the load leads, the voltage at the output of the power supply could be higher than the voltage being regulated at the load. The voltage at the output terminals of the power supply can never exceed the unit's voltage rating.

Output Noise

Any noise picked up on the sense leads will appear at the output terminals and may adversely affect CV load regulation. Twist the sense leads to minimize the pickup of external noise. In extremely noisy environments it may be necessary to shield the sense leads. Ground the shield at the power supply end only; do not use the shield as one of the sensing conductors.

The noise specifications documented in the **RP793xA-RP794xA** and **RP795xA-RP796xA** specification tables apply at the output terminals when using local sensing. However, voltage transients may be produced at the load by noise induced in the leads or by load current transients acting on the inductance and resistance of the load lead. If it is desirable to keep voltage transient levels to a minimum, place an aluminum or tantalum capacitor, with an approximate value of 10 microfarad per foot (30.5 cm) of load lead, right across the load.

Additional Load Considerations - all Models

Response Time with External Capacitor

When programming with an external capacitor, voltage response time may be longer than with purely resistive loads. Use the following formula to estimate the additional up-programming response time:

$$\text{Response Time} = \frac{(\text{added output capacitor}) \times (\text{change in } V_{\text{out}})}{(\text{current limit setting}) - (\text{load current})}$$

Note that programming into an external output capacitor may cause the RPS to briefly enter constant current operating mode, which adds additional response time. By setting the proper voltage slew rate when using an external capacitor, it may be possible to prevent mode crossover into constant current.

Positive, Negative, and Floating Voltages

Either positive or negative voltages with respect to ground can be obtained from the output by grounding (or "commoning") one of the output terminals. Always use two wires to connect the load to the output regardless of where or how the system is grounded.

- 20 V models can operate with any output terminal ± 60 VDC including output voltage from ground.
- 80 V and 160 V models can operate with any output terminal ± 240 VDC including output voltage from ground.
- 500 V and 950 V models can operate with any output terminal ± 950 VDC including output voltage from ground.

NOTE

The RPS models are optimized for grounding the negative output terminal. Grounding the positive terminal may result in increased current measurement noise and a reduction in current measurement accuracy.

Additional Load Considerations - RP793xA, RP794xA

NOTE

This information applies to models RP793xA and RP794xA only. **RP793xA, RP794xA**

Load Inductance Limitations

CAUTION

EQUIPMENT DAMAGE The instrument's internal voltage clamps are susceptible to thermal damage when the output is abruptly turned off at full load current if the lead inductance exceeds the model-dependent **Maximum Load Inductance** characteristic.

As a wire inductance reference point, a single pair of load leads typically yields between 500 nH to 1 μ H per meter of paired length (round trip), depending on the gauge of wire, thickness of insulation, and mechanical coupling of the leads. To attain greater lead lengths, wire inductance can be minimized by paralleling additional bundled sets of load leads or using specialized low inductance wiring.

Load Capacitance and Lead Inductance Considerations in Constant Voltage (CV) Operation

In CV operation, both in voltage priority mode and in current priority mode (when in voltage limit), the setup typically resembles that in the following figure where the DUT is of a resistive or high impedance nature and may have some local bypass capacitance near its own terminals. Remote sensing at the DUT terminals is recommended if accurate DC voltage regulation is required.

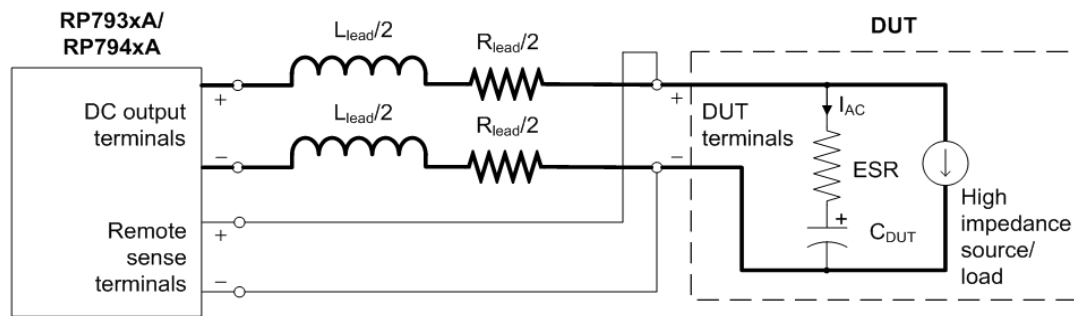

In CV operation, large capacitive loads and high inductance leads have the potential to create ringing and dynamically unstable voltage at the DUT when undergoing sudden load or voltage changes. ESR tends to mitigate this by dampening the resonance that occurs between the load capacitance and lead inductance. Lead resistance contributes to the damping effects of ESR but also increases voltage drop and power dissipation in the load leads. The **Capacitive Load Boundary** graphs in the Characteristics section have guidelines for minimum required ESR as a function of DUT capacitance under two sets of load lead conditions. This is a function of the voltage **compensation mode**.

For a DUT which has internal capacitance with insufficient ESR as shown in the Capacitive Load Boundary graphs, such as film capacitor or ceramic capacitors, additional capacitance and series resistance can be added in parallel to dampen the effects of ringing, as shown in the following figure. The additional capacitance should be at least 1 to 4 times the value of C_{DUT} and the desired ESR should be chosen based on the Capacitive Load Boundary plots for C_{DUT} . This can be implemented through either the addition of an explicit capacitor and resistor or an electrolytic capacitor with the appropriate value of rated ESR. The parallel capacitance and ESR must be able to handle DUT-specific requirements such as current or voltage ripple. In addition, parallel capacitance will limit the ability of the RPS to measure fast current edges sourced directly from the DUT, as well as slow down the voltage programming speed and bandwidth.

Typical external damping network

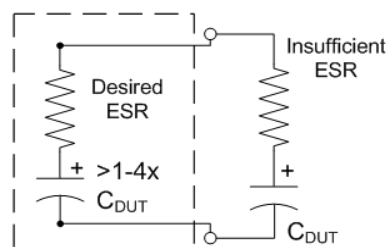

Transient Voltage Deviation

The specified voltage transient response to a load current step for the RPS may become degraded when remote sensing with long load leads, especially with low bypass capacitance at the DUT. This can be manifested as a poorly dampened ringing or even as a well dampened response with very large peak deviation. This issue is exaggerated in the case of lower voltage, higher current RPS units. To mitigate this, parallel capacitance can be added at the terminals of interest to reduce the amplitude of voltage deviation. It is likely an external parallel damping network, as previously illustrated, would be needed in place of or in addition to a pure capacitor. Generally, a capacitor with low ESR in parallel with a capacitor with high ESR allows for good stability, minimized transient response voltage deviation, as well as good voltage noise filtering.

Lead Inductance Considerations in Constant Current (CC) Operation

In CC operation, both in current priority mode and in voltage priority mode (when in current limit), the setup typically resembles that in the following figure where the DUT is of a low impedance or voltage source nature. Sense lead measurements are still utilized to detect over/under voltage protection events and when cross-over into CV operation occurs.

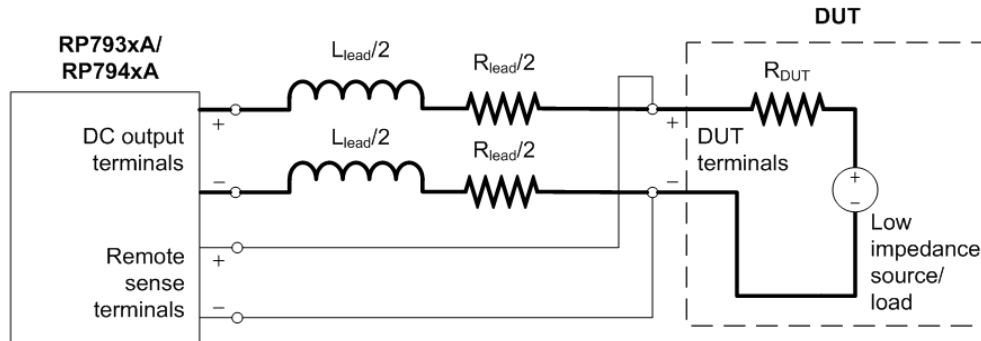

In CC operation, large inductive leads have the potential to create ringing in the output current when undergoing current programming steps or load voltage changes. This effect increases as inductance increases and lead resistance decreases. The **Inductive Load Boundary** graph in the Characteristics section shows the minimum amount of lead resistance to mitigate programming overshoot and unstable programming response under two sets of load lead conditions. This is a function of the current **compensation mode**. Note that lead and DUT resistance are indistinguishable in this context, so any resistance in the DUT is added to the effective lead resistance as specified in the graphs.

Dynamic Current Programming with Large Inductive Loads

Additional constraints may be required when programming current steps with high inductance DUTs or leads. Programming speed decreases with inductive loads greater than 1 μH . When programming large current steps, further speed degradation and overshoots may occur due to inherent voltage limitations of the RPS. Without lowering the inductance, the speed degradation cannot be improved. However, the overshoot aspect can be mitigated or removed by gradually decreasing the **programming pole** or **slew rate** setting until the desired level of performance is achieved.

Excessive Current in Current Priority Mode

CAUTION

Excessive output current may damage the device under test under certain conditions. This can occur, for example, if the DUT shorts the output of the instrument when the lower voltage limit is set substantially above zero.

When operating in current priority mode, if the voltage of a low-impedance DUT, such as a battery or short circuit, rises above the upper voltage limit setting or falls below the lower voltage limit setting, current flow exceeding the RPS unit's steady state rating can occur, potentially damaging the DUT. After a short delay, the excessive current flow will cause over-current protection to engage - disabling the output of the RPS.

Multiple Unit Output Connections

Parallel Connections

Load and Sense Connections

Primary/Secondary Connections

Current Sharing Connections - RP795xA, RP796xA

Series Connections

Parallel Connections

Connecting power supplies in parallel provides a greater current capability than can be obtained from a single unit. The use of a primary/secondary configuration is required for models RP793xA, RP794xA, and recommended for models RP795xA, RP796xA (refer to **Parallel Operation**).

Models RP795xA, RP796xA may be operated in parallel without using a primary/secondary configuration, but the Current Sharing function must be explicitly enabled (refer to **Independent Parallel Operation**).

WARNING

SHOCK HAZARD All paralleled units must be connected to ground through a grounded power cord at all times. Any interruption of the protective (grounding) conductor or disconnection of the protective earth terminal on any unit will cause a potential shock hazard that could result in injury or death.

CAUTION

To Prevent Possible Equipment Damage:

- Connect no more than twenty units of **identical voltage ratings**. All units must have the same voltage rating but current ratings can be different. All units must have the same version firmware installed. Refer to **Instrument Identification** for details.
- Always turn the **AC power** on and off together. Never leave any units powered on while the others are turned off.
- For models RP795xA and RP796xA, always connect the **negative** output terminals of all paralleled units together to prevent damaging the Sharing bus.

Load and Sense Connections

The following figures illustrate three units connected in parallel. Note the following recommendations:

- Always install the paralleled units relatively close to each other.
- Keep the cables from the power supplies to the load as short as possible and twist or bundle the leads to reduce lead inductance and noise pickup. The goal is to minimize the loop area or physical space between the + and - output leads from the bus bars to the load.

2 Installing the Instrument

- A symmetrical arrangement of separate load-wire pairs of **equal** length connecting to a common load point is highly recommended. This provides the best possible dynamic response.
- Bus bars can be used to parallel the output terminals in a stacked configuration. Ensure that the cross-section area of the bus bars will accommodate the total output current of the stack. Bus bars can be placed either on the inside or outside of the output terminals. Exposed bus bar surfaces must either be enclosed in a cabinet or insulated so that no accidental contact with lethal voltages can occur.
- To maintain the specified load regulation with paralleled units, connect all sense wires directly to the load. Twist each sense wire pair. Do not use remote sensing together with local sensing.

Although the following figures show the recommended use of remote sensing, local sensing may be used if absolutely necessary. With local sensing however, the sharing circuits will work properly only if the voltage drop measured *between* the local sense points of any unit to the local sense points of any other paralleled unit is less than 0.5% of the maximum voltage rating of the units.

Parallel connection example - RP793xA, RP794xA

The cable lengths shown are not to scale. All load cables pairs must be symmetrical and of equal length for best performance. Size the load cables according to the current rating of the unit. Double the cables on the 10 kW units so that cable inductance scales with the 5 kW units. Plus cables should be bundled with minus cables. Although the drawing shows units side by side for clarity, they may also be stacked on top of each other.

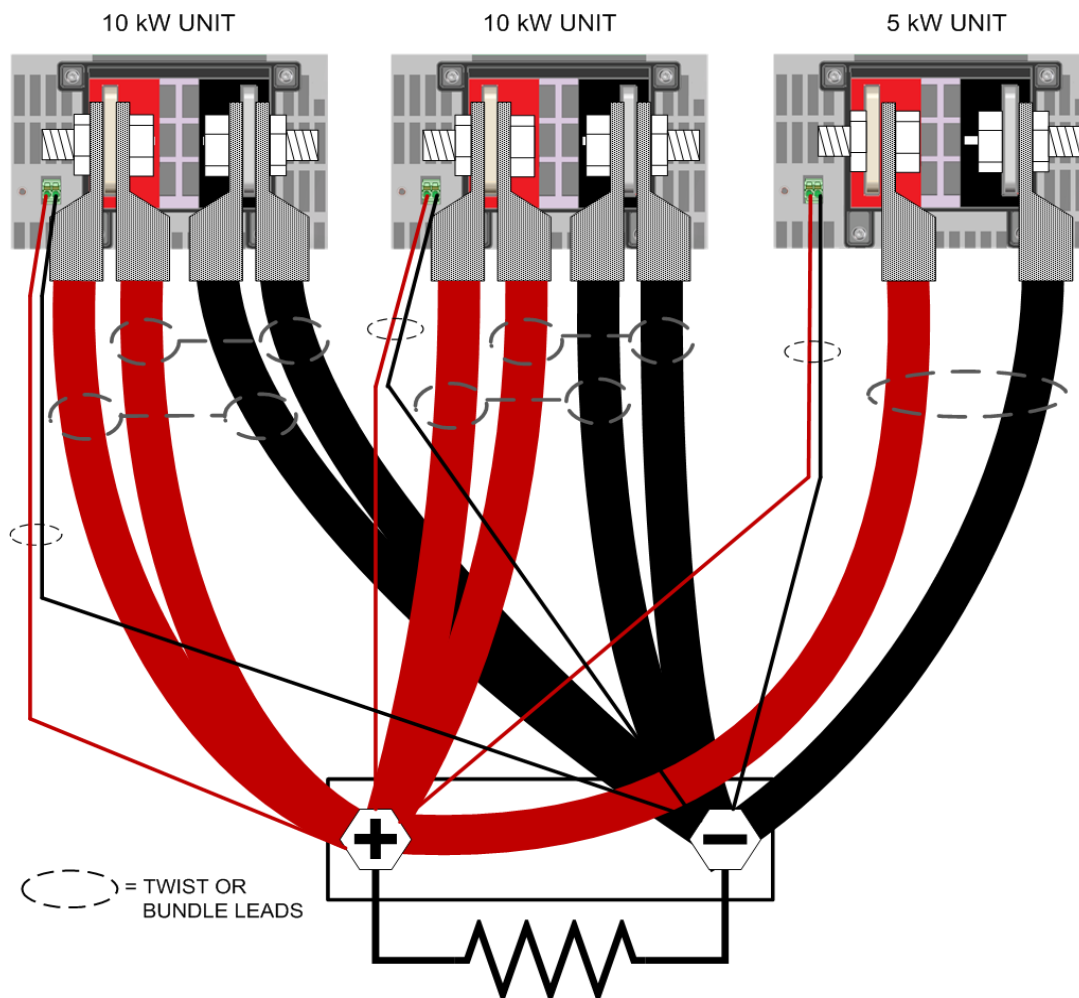

Parallel connection example - RP795xA, RP796xA

WARNING

SHOCK HAZARD, LETHAL VOLTAGES Many models generate voltages greater than 60 VDC, with some models rated at 950 VDC! Ensure that all instrument connections, load wiring, and load connections are either insulated or covered using the safety covers provided, so that no accidental contact with lethal voltages can occur.

2 Installing the Instrument

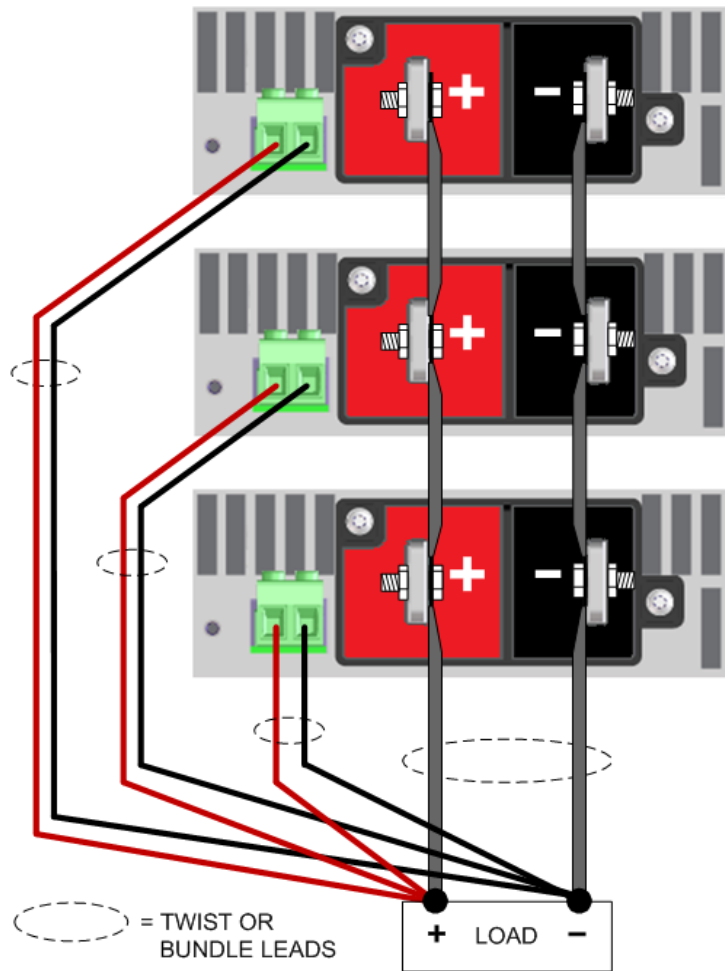

Primary/Secondary Connections - for all models

A primary/secondary configuration can be used when connecting units in parallel. This allows one designated unit to be the primary controller of all of the units in the paralleled stack. The primary/secondary communication uses a digital RS485 bus. Connections are made using the supplied, shielded CAT6A cable as shown in the following figure. For further information about primary/secondary configurations, refer to [Parallel Operation](#).

The figure also shows the termination switch settings for the paralleled units. Only the first and last units in the stack must have the switch set to the "terminated" position. The switches of the in-between units must be set to "unterminated". If only two units are connected in a primary/secondary configuration, both units must have their switches set to "terminated". A current-sharing fault (CSF) may occur if the switches are set incorrectly.

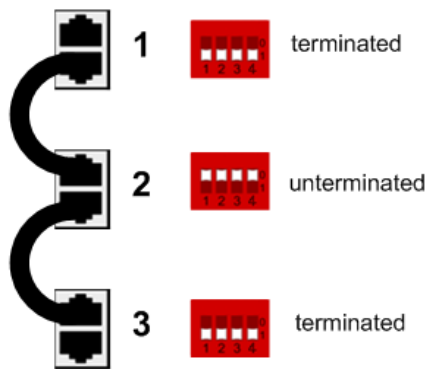

Do not install units into a primary/secondary configuration that are not actively being used as part of the primary/secondary group.

Current Sharing Connections - RP795xA, RP796xA

NOTE

Current sharing between paralleled models RP795xA and RP796xA RP795xA, RP796xA requires a separate sharing cable connecting the units. This cable provides the analog signal that allows units of the same voltage rating to share current. The current sharing function must be enabled by the user. For further information about current sharing, refer to [Enable Current Sharing](#).

Connect the **Sharing** terminals for current sharing operation as shown in the following figure. Connection plugs are attached to each end of the sharing cable as shown. When connecting multiple cables, remove a connector plugs from one of the cables and attach the wire ends to the previous cable. Parallel pins 2 together and parallel pins 3 together. Pin 1 is not used.

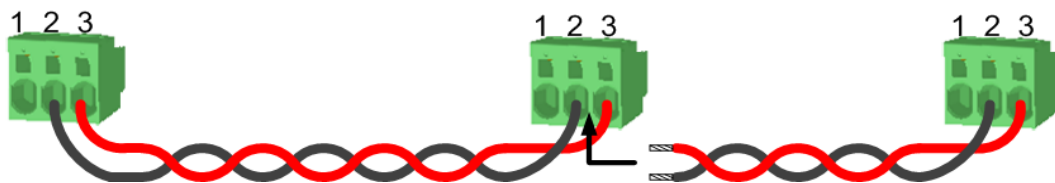

NOTE

If the Sharing cable is disconnected, the paralleled units will still operate, but will not share current or maintain constant voltage mode operation. When the output is disabled, the sharing relay opens and disconnects the unit from the Sharing bus.

Sharing Cable and Cover Installation

WARNING

SHOCK HAZARD Install the safety cover over the current sharing connectors when floating the output terminals. The sharing terminals will be at the float potential, which cannot exceed the isolation ratings given in the [characteristics](#) tables.

Because of the danger of electric shock when touching the sharing connection plugs, you must install the safety cover along with the cable. To install the cable through the cover, you must disconnect one of the connectors to fit the wires through the safety cover.

2 Installing the Instrument

A ferrite core is also provided to comply with the EMC IEC61326-1 standard. The ferrite core does not affect the functionality of this product.

The following figures detail the sharing cable incorporated with the safety cover and the ferrite core.

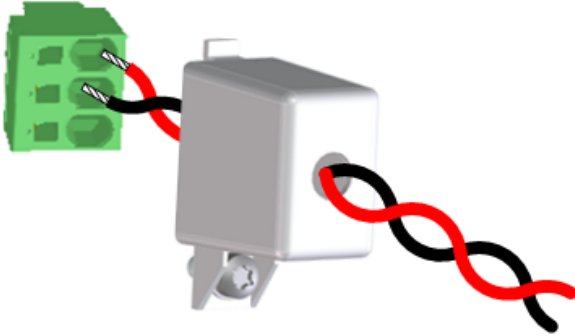

- Disconnect one of the 3-pin connector plugs.
- For EMI reduction, loop the sharing cable through the ferrite 4 times (referenced from the *inside* of the core). Each end of the sharing cable must have a core installed.
- When using multiple sharing cables, both sharing cables must loop through the core. Refer to the second core in the figure.
- Install the safety covers over the sharing cable as shown above.
- Re-connect the connector plug that you removed.
- Plug the sharing cable connector into the back of the unit.
- Connect the safety cover to the unit.



Cables are shown without covers for clarity.

Refer to [Interface Connections](#) for information about connecting the ESD cover.

Series Connections

Series connections are not permitted under any circumstances.

WARNING

SHOCK HAZARD/LETHAL VOLTAGES Series connections are not permitted for many reasons. One of the primary reasons for models RP795xA and RP796xA, for example, is that floating voltages cannot exceed the isolation ratings given in the **RP795xA**, **RP796xA** characteristics tables.

Interface Connections

GPIB Connections

USB Connections

LAN Connections - site and private

Digital Port Connections

Interface Cover Installation

This section describes how to connect to the various communication interfaces on your RPS. For further information about configuring the remote interfaces, refer to [Remote Interface Configuration](#).

If you have not already done so, install the latest Keysight IO Libraries Suite from www.keysight.com.

NOTE

For detailed information about interface connections, refer to the Keysight Technologies USB/LAN/GPIB Interfaces Connectivity Guide, included with the Keysight IO Libraries Suite.

GPIB Connections

The following figure illustrates a typical GPIB interface system.

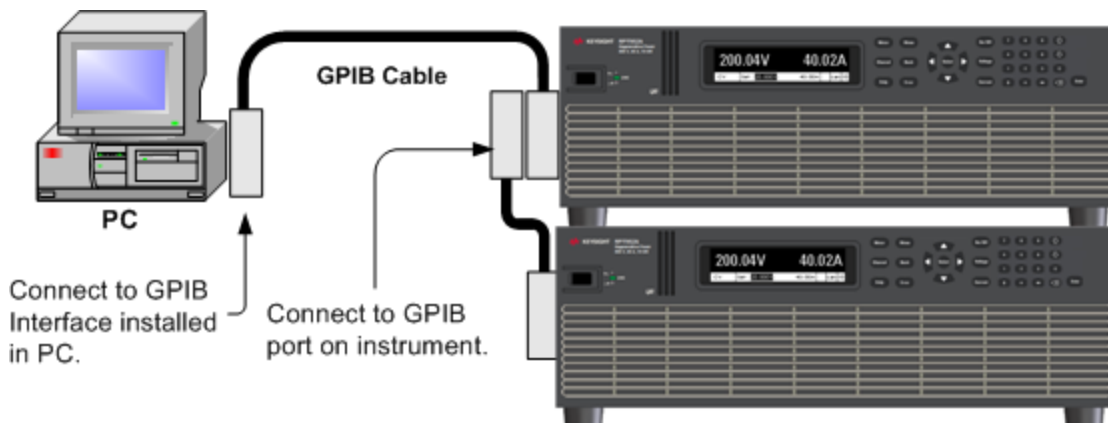

1. Connect your instrument to the GPIB interface card using a GPIB interface cable.
2. Use the Connection Expert utility of the Keysight IO Libraries Suite to configure the GPIB card's parameters.
3. You can now use Interactive IO within the Connection Expert to communicate with your instrument, or you can program your instrument using the various programming environments.

USB Connections

The following figure illustrates a typical USB interface system.

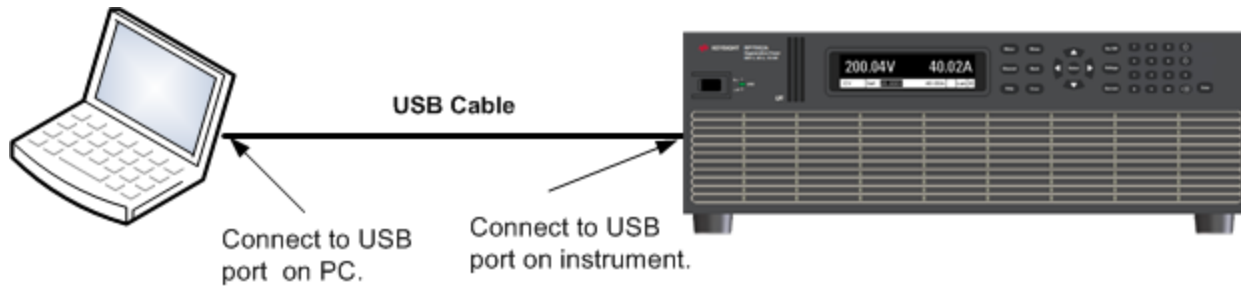

1. Connect your instrument to the USB port on your computer.
2. With the Connection Expert utility of the Keysight IO Libraries Suite running, the computer will automatically recognize the instrument. This may take several seconds. When the instrument is recognized, your computer will display the VISA alias, IDN string, and VISA address. This information is located in the USB folder.
3. You can now use Interactive IO within the Connection Expert to communicate with your instrument, or you can program your instrument using the various programming environments.

LAN Connections - site and private

A site LAN is a local area network in which LAN-enabled instruments and computers are connected to the network through routers, hubs, and/or switches. They are typically large, centrally-managed networks with services such as DHCP and DNS servers. The following figure illustrates a typical site LAN system.

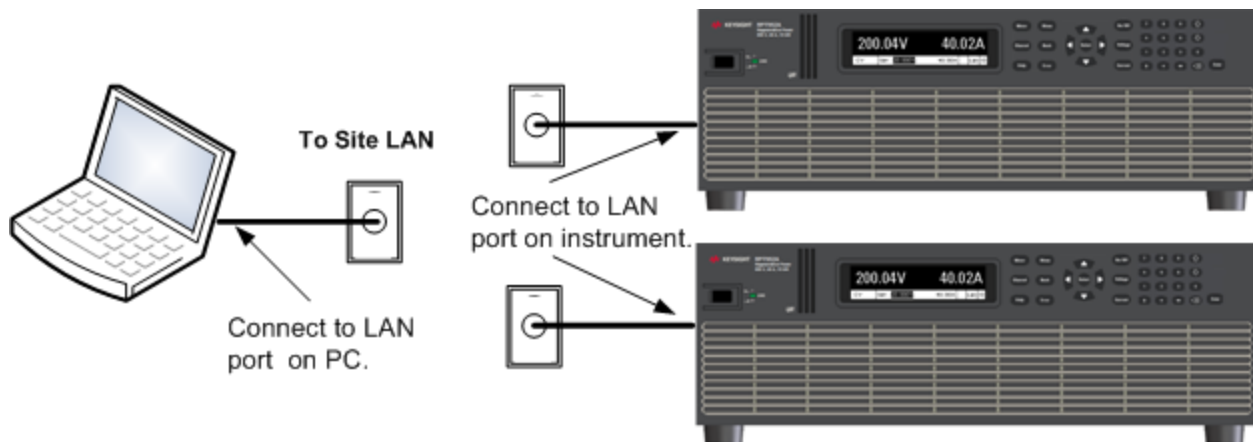

A private LAN is a network in which LAN-enabled instruments and computers are directly connected, and not connected to a site LAN. They are typically small, with no centrally-managed resources. The following figure illustrates a typical private LAN system.

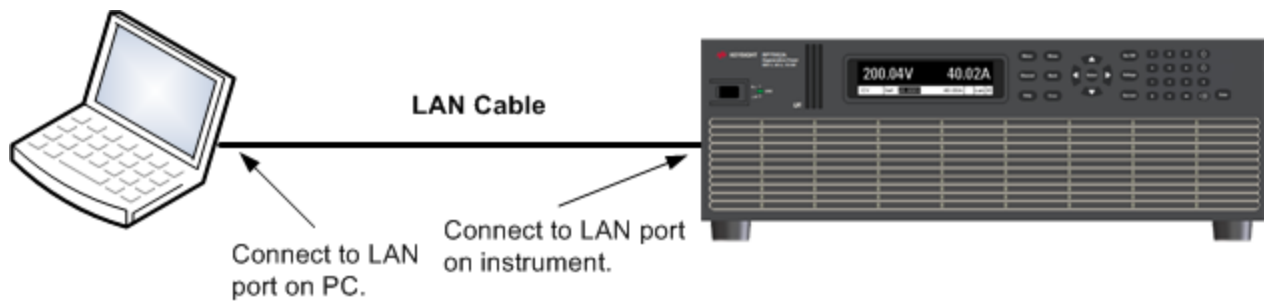

1. Connect the instrument to the site LAN or to your computer using a LAN cable. The as-shipped instrument LAN settings are configured to automatically obtain an IP address from the network using a DHCP server (DHCP is set On). The DHCP server will register the instrument's hostname with the dynamic DNS server. The hostname as well as the IP address can then be used to communicate with the instrument. If you are using a private LAN, you can leave all LAN settings as they are. Most Keysight products and most computers will automatically choose an IP address using auto-IP if a DHCP server is not present. Each assigns itself an IP address from the block 169.254.nnn. The front panel **Lan** indicator will come on when the LAN port has been configured.
2. Use the Connection Expert utility of the Keysight IO Libraries Suite to add the RPS models and verify a connection. To add the instrument, you can request the Connection Expert to discover the instrument. If the instrument cannot be found, add the instrument using the instrument's hostname or IP address.
3. You can now use Interactive IO within the Connection Expert to communicate with your instrument, or you can program your instrument using the various programming environments. You can also use the Web browser on your computer to communicate with the instrument as described under [Using the Web Interface](#).

Digital Port Connections

NOTE

It is good engineering practice to twist and shield all signal wires to and from the digital connector. If shielded wire is used, connect only one end of the shield to chassis ground to prevent ground loops.

An 8-pin connector and a quick-disconnect connector plug are provided for accessing the digital port functions. Disconnect the connector plug to make your wire connections. The connector plug accepts wire sizes from AWG 14 (1.5 mm²) to AWG 28 (0.14 mm²). Wire sizes smaller than AWG 24 (0.25 mm²) are not recommended. Strip wire insulation back 7 mm.

2 Installing the Instrument

1. Insert wires
2. Tighten screws
3. Fault/Inhibit configurable pins (observe INH polarity)
4. Output Couple configurable pins
5. Digital IO-configurable pins
6. Signal common

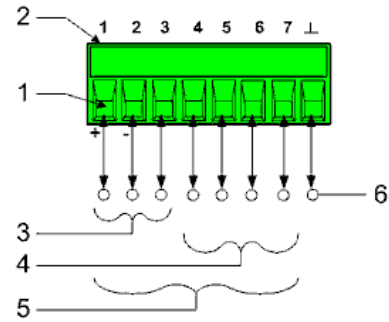

Information on using the digital port is found under **Programming the Digital Port**. The electrical characteristics are described in the **RP793xA, RP794xA** and **RP795xA, RP796xA** common characteristics tables.

Interface Cover Installation

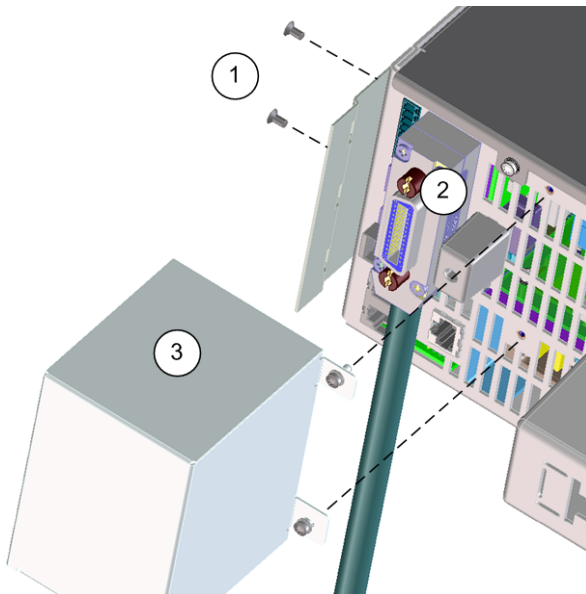

The ESD cover and hardware are shipped with the unit (see **Items Supplied**).

1. Connect the cover flange to the side of the instrument using the two screws provided. **IMPORTANT** - This must be done *before* rack mounting the unit.
2. Connect the LAN, USB, GPIB cable, and digital IO wires (GPIB shown) to the appropriate rear panel connector.
3. Install the ESD cover to the back of the unit using the two screws. Make sure the cover is inserted into the flange.

3

Getting Started

Using the Front Panel

Remote Interface Configuration

Using the Front Panel

Turn the Unit On

Set the Output Voltage

Set the Output Current

Set Over-voltage Protection

Enable the Output

Use Built-in Help System

Turn the Unit On

WARNING

SHOCK HAZARD, LETHAL VOLTAGES Many models generate voltages greater than 60 VDC, with some models rated at 950 VDC! Ensure that all instrument connections, load wiring, and load connections are either insulated or covered using the safety covers provided, so that no accidental contact with lethal voltages can occur.

Verify that the line cord is connected and plugged in.

Turn the unit on with the front panel power switch. The front panel display will light up after a few seconds. A power-on self-test occurs automatically when you turn the unit on. This test assures you that the power supply is operational.



NOTE

It may take about 30 seconds or so for the power supply to initialize before it is ready for use.

If the instrument does not turn on, verify that the power cord is firmly connected (power-line voltage is automatically sensed at power-on). Also make sure that the instrument is connected to an energized power source. If the LED next to the power switch is off, there is no AC power connected. If the LED is amber, the instrument is in standby mode with AC power connected, and if it is green, the instrument is on.

NOTE

If a self-test error occurs, a message is displayed on the front panel. For other self-test errors, see **Service and Maintenance** for instructions on returning the instrument for service.

Set the Output Voltage

Method 1

Use the left and right navigation keys to navigate to the setting that you wish to change.

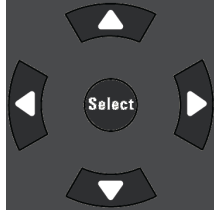

In the following display, the voltage setting is selected. Enter a value using the numeric keypad. Then press **Select**.



You can also use the numeric arrow keys to adjust the value up or down. Values become effective when the output is turned on.

In voltage priority mode, the unit will maintain the output voltage at its programmed setting. In current priority mode, the unit will limit the output voltage when it reaches the specified voltage limit value. Refer to [Set the Output Mode](#) for more information.

Method 2

Use the **Voltage** key to select the voltage entry field. In the display below, the voltage setting is selected. Enter the desired setting using the numeric keypad. Then press **Enter**.



If you make a mistake, either use the backspace key to delete the number, press **Back** to back out of the menu, or press **Meter** to return to meter mode.

Set the Output Current

Method 1

Use the left and right navigation keys to navigate to the setting that you wish to change.

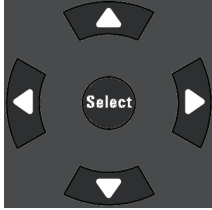

In the display below, the current setting is selected. Use the up and down navigation keys to toggle between the + and - limit entries. Enter a value using the numeric keypad. Then press **Select**.



You can also use the numeric arrow keys to adjust the value up or down. You can set both positive and negative current values. Values become effective when the output is turned on.

In current priority mode, the unit will maintain the output current at its programmed setting. In voltage priority mode, the unit will limit the output current when it reaches the specified current limit value. Refer to [Set the Output Mode](#) for more information.

Method 2

Use the **Current** key to select the current entry field. In the display below, the current setting is selected. Enter the desired setting using the numeric keypad. Then press **Enter**.

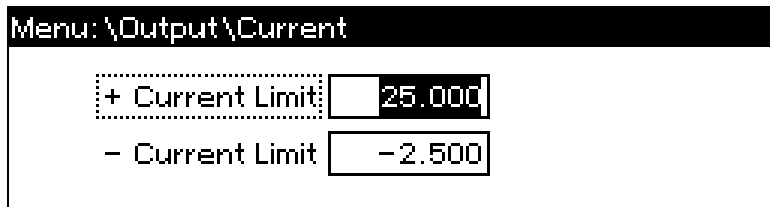

If you make a mistake, either use the backspace key to delete the number, press Back to back out of the menu, or press Meter to return to meter mode.

Set Over-voltage Protection

Use the front panel menu.

The front panel command menu lets you access most of the instrument's functions. The actual function controls are located at the lowest menu level. Briefly:

- Press the **Menu** key to access the command menu.
- Press the left and right (<, >) navigation keys to move across the menu commands.
- Press the center **Select** key to select a command and move down to the next level in the menu.
- Press the **Help** key at the lowest menu level to display help information about the function controls.
- To exit the command menu press the **Meter** key to immediately return to meter mode, or press the **Menu** key to return to the top level.

For a map of the front panel menu commands, refer to [Front Panel Menu Reference](#).

Menu example - setting over-voltage protection.

Press the **Menu** key to access the front panel command menu. The first line identifies the menu path. When the menu is first accessed, the menu is at the top or root, and the path is empty. The second line indicates the commands that are available at the present menu level. In this case, the top-level menu commands are shown, with the Output command highlighted. The third line indicates which commands are available under the Output command. If there are no lower level commands, a brief description of the highlighted command is displayed.

```
Menu: \
Output Measure Transient Protect States System
Voltage, Current, Mode, Sequence, Advanced
```

Press the right arrow navigation key > to traverse the menu until the Protect command is highlighted. Press the **Select** key to access the Protect commands.

```
Menu: \
Output Measure Transient Protect States System
OVP, UVP, OCP, Inhibit, WDog, Clear
```

Since the OVP command is already highlighted, press the Select key to access the OVP dialog.

3 Getting Started

```
Menu: \Protect
OVP UVP OCP Inhibit WDog Clear
Overvoltage protection settings.
```

The default OVP setting for this model is 600 V. You can change the OVP setting using the numeric entry keys and pressing **Enter** and **Select**. Press the **Meter** key to return to meter view.

```
Menu: \Protect\OVP
OVP Level: 600.00
```

Enable the Output

Use the **On/Off** key to enable the output. If a load is connected to the output, the front panel display will indicate that it is drawing current. Otherwise, the current reading will be zero. The status indicator shows the output's status. In this case, "CV" indicates the output is in constant voltage mode.

```
150.030V 20.015A
CV Set 150.000V Lim 25.000A Lan
```

For a description of the status indicators, refer to [Front Panel Display at a Glance](#).

Use Built-in Help System

Press the **Help** key at the lowest menu level to display help information about the menu function controls.

Whenever a limit is exceeded or any other invalid configuration is found, the instrument will display a message, including Error code information.

Press **Meter** or **Back** to exit Help.

Remote Interface Configuration

USB Configuration

GPIB Configuration

LAN Configuration

Modifying the LAN Settings

Using the Web Interface

Using Telnet

Using Sockets

Interface Lockout

Introduction

This instrument supports remote interface communication over three interfaces: GPIB, USB, and LAN. All three interfaces are "live" at power up. To use the interfaces, you must first install the latest Keysight IO Libraries Suite from www.keysight.com. Then connect your instrument to your PC.

The front panel **IO** indicator comes on whenever there is activity on the remote interfaces. The front panel **Lan** indicator comes on when the LAN port is connected and configured.

This instrument provides Ethernet connection monitoring. With Ethernet connection monitoring, the instrument's LAN port is continually monitored, and automatically reconfigured when the instrument is unplugged for a minimum of 20 seconds and then reconnected to a network.

USB Configuration

There are no configurable USB parameters. You can retrieve the USB connect string using the front panel menu:

Front Panel Menu Reference	SCPI Command
Select System\IO\USB The dialog displays the USB connect string.	Not available

GPIB Configuration

Each device on the GPIB (IEEE-488) interface must have a unique whole number address between 0 and 30. The instrument ships with the address set to 5. Your computer's GPIB interface card address must not conflict with any instrument on the interface bus. This setting is non-volatile; it will not be changed by power cycling or *RST. Use the front panel menu to change the GPIB address:

3 Getting Started

Front Panel Menu Reference	SCPI Command
Select System\IO\GPiB . Use the numeric keys to enter a new value from 0 to 30. Then press Enter .	Not available

LAN Configuration

The following sections describe the primary LAN configuration functions on the front-panel menus. Note that there are no SCPI commands to configure the LAN parameters. All LAN configuration must be done from the front panel.

NOTE

After changing the LAN settings, you must Save the changes. Select: **System\IO\LAN\Apply**. Selecting Apply activates the settings. LAN settings are non-volatile, they will not be changed by power cycling or *RST. If you do not want to save your changes select: **System\IO\LAN\Cancel**. Selecting Cancel cancels all changes.

When shipped, DHCP is on, which may enable communication over LAN. The letters DHCP stands for Dynamic Host Configuration Protocol, a protocol for assigning dynamic IP addresses to devices on a network. With dynamic addressing, a device can have a different IP address every time it connects to the network.

Viewing Active Settings

To view the currently active LAN settings:

Front Panel Menu Reference	SCPI Command
Select System\IO\LAN\Settings . Displays the active LAN settings. Use the up and down arrow key to scroll through the list.	Not available

The currently active settings for the IP Address, Subnet Mask, and Default Gateway may be different from the front panel configuration menu settings - depending on the configuration of the network. If the settings are different, it is because the network has automatically assigned its own settings

Resetting the LAN

Resetting the LAN performs a LAN Configuration Initialize (LCI) reset of the instrument which enables DHCP, DNS and ping. It also resets the web site password to the factory default password. This does not reset the hostname or the mDNS service name.

You can also reset the LAN to the as-shipped (default) settings. This returns **ALL** LAN settings to the as-shipped values and restarts networking. All default LAN settings are listed under **Non-volatile Settings**.

Front Panel Menu Reference	SCPI Command
Select System\IO\LAN\Reset	Not available
Select System\IO\LAN\Defaults	
Selecting Reset activates the selected LAN settings and restarts networking.	

Modifying the LAN Settings

IP Address

Select IP to configure the addressing of the instrument. Press the **Menu** key, then select **System\IO\LAN\Config\IP**. The configurable parameters include:

Front Panel Menu Reference	SCPI Command
Select System\IO\LAN\Modify\IP	Not available
Select Auto or Manual. See below for a full description.	

- **Auto** - automatically configures the addressing of the instrument. When selected, the instrument will first try to obtain an IP address from a DHCP server. If a DHCP server is found, the DHCP server will assign an IP address, Subnet Mask, and Default Gateway to the instrument. If a DHCP server is unavailable, the instrument will try to obtain an IP address using AutoIP. AutoIP automatically assigns an IP address, Subnet Mask, and Default Gateway addresses on networks that do not have a DHCP server.
- **Manual** - allows you to manually configure the addressing of the instrument by entering values in the following three fields. These fields only appear when Manual is selected.
- **IP Address** - This value is the Internet Protocol (IP) address of the instrument. An IP address is required for all IP and TCP/IP communications with the instrument. An IP Address consists of 4 decimal numbers separated by periods. Each decimal number ranges from 0 through 255 with no leading zeros (for example, 169.254.2.20).
- **Subnet Mask** - This value is used to enable the instrument to determine if a client IP address is on the same local subnet. The same numbering notation applies as for the IP Address. When a client IP address is on a different subnet, all packets must be sent to the Default Gateway.
- **DEF Gateway** - This value is the IP Address of the default gateway that allows the instrument to communicate with systems that are not on the local subnet, as determined by the subnet mask setting. The same numbering notation applies as for the IP Address. A value of 0.0.0.0 indicates that no default gateway is defined.

Dot-notation addresses ("nnn.nnn.nnn.nnn" where "nnn" is a byte value from 0 to 255) must be expressed with care, as most PC web software interprets byte values with leading zeros as octal (base 8) numbers. For example, "192.168.020.011" is actually equivalent to decimal "192.168.16.9" because ".020" is interpreted as "16" expressed in octal, and ".011" as "9". To avoid confusion, use only decimal values from 0 to 255, with no leading zeros.

Host Name

A hostname is the host portion of the domain name, which is translated into an IP address. To configure the hostname of the instrument:

Front Panel Menu Reference	SCPI Command
Select System\IO\LAN\Modify\Name	Not available
<p>You can enter any value from the numeric keypad. For additional characters, use the up/down navigation keys to enter an alpha character by scrolling through the selection list that appears when you press the keys. Use the left/right navigation keys to traverse the text field. Use the backspace key to delete a value. Press Enter when you are finished.</p>	

Host Name - This field registers the supplied name with the selected naming service. If the field is left blank, no name is registered. A hostname may contain upper and lower case letters, numbers and dashes (-). The maximum length is 15 characters.

Each instrument is shipped with a default hostname with the format: K-modelnumber-serialnumber, where modelnumber is the unit's 7-character model number (e.g. RP7951A), and serialnumber is the last five characters of the 10-character serial number located on the label on the top of the unit (e.g. 45678 if the serial number is MY12345678).

DNS Server

DNS is an internet service that translates domain names into IP addresses. It is also needed for the instrument to find and display its hostname assigned by the network. Normally, DHCP discovers the DNS address information; you only need to change this if DHCP is unused or not functional.

To manually configure the DNS services:

Front Panel Menu Reference	SCPI Command
Select System\IO\LAN\Modify\DNS	Not available
<p>Select Primary Address or Secondary Address. See below for a full description.</p>	

- **Primary Address** - This field enters the primary address of the server. Contact your LAN administrator for server details. The same numbering notation applies as for the IP Address. A value of 0.0.0.0 indicates that no default server is defined.
- **Secondary Address** - This field enters the secondary address of the server. Contact your LAN administrator for server details. The same numbering notation applies as for the IP Address. A value of 0.0.0.0 indicates that no default server is defined.

Dot-notation addresses ("nnn.nnn.nnn.nnn" where "nnn" is a byte value from 0 to 255) must be expressed with care, as most PC web software interprets byte values with leading zeros as octal (base 8) numbers. For example, "192.168.020.011" is actually equivalent to decimal "192.168.16.9" because ".020" is interpreted as "16" expressed in octal, and ".011" as "9". To avoid confusion, use only decimal values from 0 to 255, with no leading zeros.

mDNS Service Name

The mDNS service name is registered with the selected naming service. To configure the mDNS service name of the instrument:

Front Panel Menu Reference	SCPI Command
Select System\IO\LAN\Modify\mDNS	Not available
<p>You can enter any value from the numeric keypad. For additional characters, use the up/down navigation keys to enter an alpha character by scrolling through the selection list that appears when you press the keys. Use the left/right navigation keys to traverse the text field. Use the backspace key to delete a value. Press Enter when you are finished.</p>	

- **mDNS Service Name** - This field registers the service name with the selected naming service. If the field is left blank, no name is registered. A service name may contain upper and lower case letters, numbers and dashes(-).
- Each instrument is shipped with a default service name with the format: Keysight-modelnumber-description-serialnumber, where modelnumber is the unit's 7-character model number (e.g. RP7951A), description is the description, and serialnumber is the 10-character serial number located on the label on the top of the unit (e.g. MY12345678).

Services

This selects the LAN services to enable or disable.

Front Panel Menu Reference	SCPI Command
Select System\IO\LAN\Modify\Services	Not available
<p>Check or uncheck the services that you wish to enable or disable.</p>	

- The configurable services include: VXI-11, Telnet, Web control, Sockets, mDNS, and HiSLIP.
- You must enable Web control if you wish to remotely control your instrument using its built-in Web interface.

Using the Web Interface

Your RPS has a built-in Web interface that lets you control it directly from the Web browser on your computer. With the Web interface, you can access the front panel control functions including the LAN configuration parameters. Up to six simultaneous connections are allowed. With additional connections, performance will be reduced.

NOTE

The built-in Web interface only operates over the LAN. A Web browser is required to use the Web Interface.

The Web interface is enabled when shipped. To launch the Web interface:

1. Open the Web browser on your computer.
2. Enter the instrument's hostname or IP address into the browser's Address field. The following home page will appear.
3. Click on the Web Control tab on the top of the page to begin controlling your instrument.
4. For additional help about any of the pages, click on the ?.

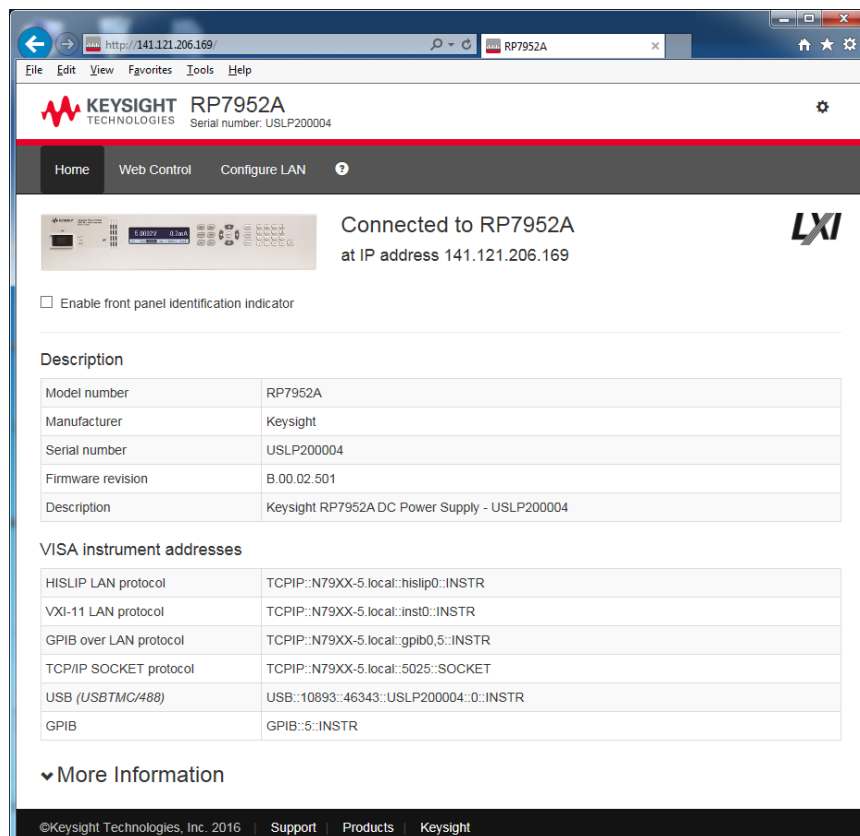

If desired, you can control access to the Web interface using password protection. As shipped, no password is set. To set a password, click on the "gear" icon. Refer to the on-line help for additional information about setting a password.

Using Telnet

In an MS-DOS Command Prompt box type: telnet hostname 5024 where hostname is the RPS hostname or IP address, and 5024 is the instrument's telnet port.

You should get a Telnet session box with a title indicating that you are connected to the power supply. Type the SCPI commands at the prompt.

Using Sockets

NOTE

Power supplies allow any combination of up to six simultaneous data socket, control socket, and telnet connections to be made.

Keysight instruments have standardized on using port 5025 for SCPI socket services. A data socket on this port can be used to send and receive ASCII/SCPI commands, queries, and query responses. All commands must be terminated with a newline for the message to be parsed. All query responses will also be terminated with a newline.

The socket programming interface also allows a control socket connection. The control socket can be used by a client to send device clear and to receive service requests. Unlike the data socket, which uses a fixed port number, the port number for a control socket varies and must be obtained by sending the following SCPI query to the data socket: **SYSTem:COMMunicate:TCPIp:CONTRol?**

After the port number is obtained, a control socket connection can be opened. As with the data socket, all commands to the control socket must be terminated with a newline, and all query responses returned on the control socket will be terminated with a newline.

To send a device clear, send the string "DCL" to the control socket. When the power supply has finished performing the device clear it echoes the string "DCL" back to the control socket.

Service requests are enabled for control sockets using the Service Request Enable register. Once service requests have been enabled, the client program listens on the control connection. When SRQ goes true the instrument will send the string "SRQ +nn" to the client. The "nn" is the status byte value, which the client can use to determine the source of the service request.

Interface Lockout

The USB interface, LAN interface, and the Web server are enabled when shipped. To enable or disable the interfaces from the front panel:

Front Panel Menu Reference	SCPI Command
Select System\Admin\IO	Not available
Enable or disable the interfaces by checking or unchecking the following items:	
Enable LAN, Enable GPIB, and Enable USB	

If you cannot access the Admin menu, it may be password protected.

4

Using the Regenerative Power System

Programming the Output

Parallel Operation

Current Sinking Operation

Programming Output Protection

Programming Output Transients

Sequencing the Output

Making Measurements

External Data Logging

Programming the Digital Port

System-Related Operations

Priority Mode Tutorial

Programming the Output

Set the Output Priority Mode

Set the Output Voltage

Set the Output Current

Set the Slew Rate

Set the Output Resistance

Set the Output Bandwidth - RP795xA, RP796xA

Set the Output Bandwidth - RP793xA, RP794xA

Set the Output Turn-On/Turn-Off Mode - RP793xA, RP794xA

Enable the Output

WARNING

SHOCK HAZARD, LETHAL VOLTAGES Many models generate voltages greater than 60 VDC, with some models rated at 950 VDC! Ensure that all instrument connections, load wiring, and load connections are either insulated or covered using the safety covers provided, so that no accidental contact with lethal voltages can occur.

NOTE

When the RPS is first turned on, it may take about 30 seconds or so to initialize the instrument before it is ready for use.

Set the Output Priority Mode

Select either voltage or current priority mode. Refer to [Priority Mode Operation](#) for more information.

Voltage priority mode keeps the output voltage constant. The output voltage remains at its programmed setting, provided the load current remains within the + or - current limit setting.

Current priority mode keeps the output current constant. The output current remains at its programmed setting, provided the load voltage remains within the voltage limit setting.

Front Panel Menu Reference	SCPI Command
Select Output\Mode . Select either Voltage priority or Current priority. Then press Select .	To specify current or voltage priority mode: FUNC CURR VOLT

NOTE

When switching between voltage priority and current priority mode, the output is turned off and the output settings revert to their Power-on or RST values.

Set the Output Voltage

When the unit is in voltage priority mode, the output voltage remains at its programmed setting as long as the load current remains within its programmed positive or negative limit.

Front Panel Menu Reference	SCPI Command
Press the Voltage key. Enter a value and press Select.	To set the output voltage to 400 volts: VOLT 400

When the unit is in current priority mode, you can specify a voltage limit which limits the output voltage at the specified value. The output current remains at its programmed setting, provided the load voltage remains within the voltage limit setting.

Front Panel Menu Reference	SCPI Command
Press the Voltage key. Specify a + Voltage limit. Then press Select .	To set the voltage limit: VOLT:LIM 420

Set the Low Voltage Limit

NOTE

This information applies to models RP793xA and RP794xA only.

RP793xA, RP794xA

Sets the low voltage limit when in current priority mode. This prevents the voltage from dropping below the low voltage limit when discharging a battery. When the low voltage limit is reached, the unit transitions from current priority mode to voltage priority mode operation, which stops discharging the battery. The low voltage limit is annunciated by the **UV** status bit.

Note that the low voltage limit also prevents the output from turning on when the output voltage is below the programmed low voltage limit. If you need to turn the output on, you must first set the low voltage limit to zero.

Front Panel Menu Reference	SCPI Command
Press the Voltage key. The Low Voltage Limit field only appears when the unit is set to operate in Current Priority mode. Specify the low voltage limit. Then press Select .	To set the low voltage limit: VOLT:LIM:LOW 4

Set the Output Current

When the unit is in voltage priority mode, you can specify a positive and negative current limit, which limits the output current at the specified value.

4 Using the Regenerative Power System

Front Panel Menu Reference	SCPI Command
Press the Current key.	To set the positive current limit: CURR:LIM 12
Specify a positive or negative Current limit. Then press Select .	To set the negative current limit: CURR:LIM:NEG -3

When the unit is in current priority mode, you can specify a positive or negative output current level, which will be maintained as long as the output voltage remains within its programmed limit.

Front Panel Menu Reference	SCPI Command
Press the Current key.	To set the current to +5 amperes: CURR 5
Enter a positive or negative value. Then press Select .	To set the current to -5 amperes: CURR -5

Set the Slew Rate

The voltage slew rate determines the rate at which the voltage changes to a new setting. This only applies to voltage settings while operating in voltage priority mode. When set to MAXimum, INFINITY, or to a very large value, the slew rate will be limited by the unit's listed programming speed and bandwidth. This setting can be used to prevent crossover into current limit while up- and down-programming capacitive loads, or to limit programming response to a controlled rate. Use the following equation to calculate the maximum slew rate limit to ensure smooth and linear up- and down-programming performance.

$$\text{Max slew rate (V/s)} = (\text{Current limit setting (A)} - \text{Load current (A)}) / (\text{Load capacitance (F)})$$

The current slew rate determines the rate at which the current changes to a new programmed setting. This only applies to current settings while operating in current priority mode. When set to MAXimum, INFINITY, or to a very large value, the slew rate will be limited by the unit's listed programming speed and bandwidth.

Front Panel Menu Reference	SCPI Command
Select Output\Advanced\Slew Then select Voltage or Current	To set the voltage slew rate to 5 V/s VOLT:SLEW 5
Enter the voltage or current slew rate in the Slew Rate field.	To set the current slew rate to 1 A/s CURR:SLEW 1
Check Max slew rate to program the fastest slew rate.	To set the fastest slew rate: VOLT:SLEW MAX

Set the Output Resistance

NOTE

Requires firmware version B.03.02.1232 and up for models RP793xA and RP794xA.

Output resistance programming is mainly used in battery testing applications and only applies in voltage priority mode. It is used to emulate the internal resistance of a non-ideal voltage source such as a battery. Values are programmed in ohms.

Refer to the **RP793xA**, **RP794xA** and **RP795xA**, **RP796xA** characteristics tables for the model-specific resistance programming ranges.

Front Panel Menu Reference	SCPI Command
Select Output\Advanced\Resistance . Specify an Output Resistance value. Then check the Enable box. Then press Select .	To select a resistance of 0.5 ohms: VOLT:RES 0.5 To enable output resistance: VOLT:RES:STAT ON

NOTE

When units are paralleled, the programmable output resistance is reduced. The programmable output resistance for a single unit must be divided by the total number of paralleled units.

Set the Output Bandwidth - RP795xA, RP796xA

NOTE

This information applies to models RP795xA and RP796xA only. **RP795xA, RP796xA**

Voltage compensation modes let you optimize output response time with capacitive loads.

High1 compensation setting provides maximum up-programming speed as well as the fastest transient response settling time. This mode is optimized for use with resistive loads; however capacitive loads up to the limits outlined in the table below can be used when using load leads shorter than 3 meters (10 feet). Exceeding these limits can lead to voltage programming overshoots and transient response instability.

Low compensation setting is optimized for use with large capacitive loads up to the limits shown in the table below, along with load leads longer than 3 meters (10 feet). In this mode, the up- and down-programming speed and voltage control-loop bandwidth are limited to prevent voltage programming overshoots and improve transient response stability. Low mode provides the best stability and overshoot minimization over all load configurations.

<frequency> specifies the low-pass corner frequency of a filter applied to the programming signal. Refer to the frequency description in the next section

NOTE

Connecting very low ESR capacitors larger than the High mode limit with load leads shorter than 3 m (10 ft.) is not recommended in either bandwidth range. This load configuration can lead to voltage programming overshoots.

Setting	5 kW Models	10 kW Models	950 V Models
High1	0 to 80 μ F	0 to 80 μ F	0 to 40 μ F
Low	0 to 100,000 μ F	0 to 100,000 μ F	0 to 50,000 μ F

Front Panel Menu Reference	SCPI Command
Select Output\Advanced\Bandwidth\Voltage .	To set the bandwidth for RP795xA and RP796xA: VOLT:BWID LOW High1
Select either Low or High 1. If desired, enter the pole frequency in the Frequency field. Then press Select .	To specify the pole frequency: VOLT:BWID:LEV 0 1, <frequency>

Set the Output Bandwidth - RP793xA, RP794xA

NOTE

This information applies to models RP793xA and RP794xA only. **RP793xA, RP794xA**

Voltage compensation modes let you optimize output response time with capacitive loads.

The **Capacitive Load Boundary** graphs in the Characteristics section illustrate the minimum ESR as a function of DUT capacitance to allow for stable operation.

Comp 0 (High speed/Small capacitive load) – provides the fastest programming speed and transient response time. Best suited for resistive DUTs with low capacitance. Default frequency = 1.4 kHz.

Comp 1 (Medium speed/Medium capacitive load) – provides intermediate programming speed and transient response time. Best suited for DUTs with higher capacitance with some trade-off in programming speed and transient response. Default frequency = 460 Hz.

Comp 2 (Slow speed/Large capacitive load) – best suited for DUTs with high capacitance/low ESR with the trade-off of a slower programming speed and transient response. Default frequency = 55 Hz .

<frequency> specifies the low-pass corner frequency of a filter applied to the programming signal. The programmed voltage is a digitized signal which passes through a single-pole low pass filter where the pole is specified in Hertz. This filter has the effect of slowing down the output with respect to changes in the programmed voltage or current. This, in combination with the configurable slew setting, allows for a trade-off between programming speed and output voltage or current overshoot. For example, increasing the filter frequency may result in more overshoot and decreasing the frequency will lower the overshoot, depending on the compensation setting and the load impedance. This frequency setting does not affect the unit's transient response to a load change.

The following table summarizes the effect that the compensation settings have on the CV Programming Speed Characteristics.

Setting	Step Conditions	Frequency	20 V Models	80 V Models
Comp 0	no load, 10-100% of rating	100 kHz	80 μ s/810 μ s	71 μ s/480 μ s
	full CC load, 0-100% of rating	2.3 kHz	140 μ s/4.2 ms	145 μ s/1.35 ms
Comp 1	full CC load, 0-100% of rating	1.4 kHz	190 μ s/2.3 ms	205 μ s/1.5 ms
Comp 2	full CC load, 0-100% of rating	900 Hz	350 μ s/3.8 ms	360 μ s/1.25 ms

The following table describes the CV small signal bandwidth characteristics

CV programming small signal bandwidth (-3dB) at no load		
Setting	20 V Models	80 V Models
Comp 0	8.3 kHz	7.5 kHz
Comp 1	4.7 kHz	6.6 kHz
Comp 2	2 kHz	5.9 kHz

Front Panel Menu Reference	SCPI Command
Select Output\Advanced\Bandwidth\Voltage .	To set the voltage compensation bandwidth: VOLT:BWID:RANG 0 1 2
Select either Comp 0, 1, or 2. If desired, enter the pole frequency in the Frequency field. Then press Select .	To specify the pole frequency: VOLT:BWID:LEV 0 1 2, <frequency>

Current compensation modes allow you to optimize output response time with inductive loads.

Comp 0 Best suited for longer load leads (higher inductance) with relatively fast programming response (see **Inductance Load Boundary** graph).

Comp 1 Optimizes programming speed for DUTs with limited lead inductance. This setting may require paralleling additional sets of leads to achieve the desired overall lead length.

<frequency> specifies the low-pass corner frequency of a filter applied to the programming signal. Refer to the previous description under Voltage Compensation modes.

The following table summarizes the effect that the compensation settings have on the CC Programming Speed Characteristics.

Setting	Step Conditions	Frequency	20 V Models	80 V Models
Comp 0	0-100% of current step at Vout	100 kHz	300 μ s/960 μ s	180 μ s/500 μ s
Comp 1	> 10% of voltage rating	100 kHz	150 μ s/350 μ s	60 μ s/300 μ s

The following table describes the CC small signal bandwidth characteristics

CC programming small signal bandwidth (-3dB) at no load		
Setting	20 V Models	80 V Models
Comp 0	2 kHz	2.7 kHz
Comp 1	2.7 kHz	3.5 kHz

Front Panel Menu Reference	SCPI Command
Select Output\Advanced\Bandwidth\Current .	To set the current compensation bandwidth: CURR:BWID:RANG 0 1 2
Select either Comp 0 or Comp 1. If desired, enter the pole frequency in the Frequency field. Then press Select .	To specify the pole frequency: CURR:BWID:LEV 0 1 2, <frequency>

Set the Output Turn-On/Turn-Off Mode - RP793xA, RP794xA

NOTE

This information applies to models RP793xA and RP794xA only. RP793xA, RP794xA

The turn-on/turn-off setting only applies when the RPS is operating in voltage priority mode. In current priority mode, the turn-on/turn-off behavior is always impedance.

The voltage priority turn-on and turn-off behavior can be set to either low impedance or high impedance mode.

Low impedance mode is for devices like power converters. During output transitions, current is sourced or discharged for fast output voltage response.

High impedance mode is for devices like batteries, where output transitions are controlled to minimize output current.

When coupling is enabled, changing the turn-on setting also changes the turn-off setting and vice-versa.

Front Panel Menu Reference	SCPI Command
Select Output\Advanced\Tmode .	To select high impedance turn-on:
Select either High impedance or Low impedance for turn-on and turn-off modes.	OUTP:TMOD:ON HIGHZ
Check Coupled to couple the turn-on and turn-off modes. Then press Select .	To select low impedance turn-off:
	OUTP:TMOD:OFF LOWZ
	To couple the turn-on and turn-off modes:
	OUTP:TMOD:COUP ON

Enable the Output

Because of internal circuit start-up procedures and any installed relay options, OUTPut ON may take tens of milliseconds to complete its function. OUTPut OFF delays may also be in effect. For more information regarding output turn-on and turn-off delays, refer to **Turn-On/Turn-Off Delays**.

Front Panel Menu Reference	SCPI Command
Press the On/Off key.	OUTP ON/OFF

In addition to the front panel and SCPI Output On and Output Off commands, you can also use OnCouple and OffCouple signals to enable and disable the output. Refer to **Output Couple Control** for more information. When coupling is enabled, changing the turn-on setting also changes the turn-off setting and vice-versa.

NOTE

During a 1-cycle AC line dropout the unit may reboot. The output will remain off after reboot until the operator reinstates the previous settings, either by the front panel controls or using a computer program. This behavior is consistent with safe operating procedures.

Parallel Operation

Introduction

Primary/Secondary Operation

Independent Parallel Operation - RP795xA, RP796xA

Introduction

WARNING

SHOCK HAZARD All paralleled units must be connected to ground through a grounded power cord at all times. Any interruption of the protective (grounding) conductor or disconnection of the protective earth terminal on any unit will cause a potential shock hazard that could result in injury or death.

CAUTION

To Prevent Possible Equipment Damage:

- Connect no more than twenty units of **identical voltage ratings**. All units must have the same voltage rating but current ratings can be different. All units must have the same version firmware installed. Refer to **Instrument Identification** for details.
 - Always turn the **AC power** on and off together. Never leave any units powered on while the others are turned off.
 - For models RP795xA and RP796xA, always connect the **negative** output terminals of all paralleled units together to prevent damaging the Sharing bus.
-

Parallel operation lets you connect multiple power supplies together to create a system with higher total current and power. This applies for current sourcing as well as current sinking operation. Refer to **Multiple Unit Connections** for detailed information on how to connect the outputs and the primary/secondary cables. Remember to also set the termination switches.

Units of dissimilar power ratings may be paralleled, provided they have identical voltage ratings. In this case, the units will share current proportionally according to their current rating. For example, a 10 kW unit rated at 40 A and a 5 kW unit rated at 20 A will share their output current in a 2-to-1 ratio.

NOTE

Models RP795xA, RP796xA **RP795xA, RP796xA** also require connecting the Sharing cable as described under **Sharing Connections**.

Two modes of parallel operation are available:

Primary/Secondary operation - In this mode, the paralleled group is controlled through the primary unit, and appears as a single higher-power supply. The primary unit provides the aggregate of most source and measurement functions. The **current sharing** function is automatically enabled during primary/secondary operation. This is the recommended method of paralleling units.

Independent parallel operation for Models RP795xA, RP796xA **RP795xA, RP796xA** - In this mode all paralleled units are programmed independently. Connect and program the output **On Couple** and

output **Off Couple** digital port signals to provide synchronized instrument turn-on and turn-off capability. You must explicitly enable the **current sharing** function on each paralleled unit.

Primary/Secondary Operation

Up to twenty paralleled instruments can be connected in a primary/secondary configuration. All units must have the same voltage rating but current ratings can be different. All units must have the same version firmware installed. Refer to **Instrument Identification** to view the firmware version. The configuration procedure for primary/secondary operation is as follows:

- Configure one unit as the primary
- Configure the other units as secondary units with unique bus addresses
- Select the connection mode and auto-connect delay time
- Perform a one-time discovery on the primary - it saves the primary/secondary configuration
- At power-on, the primary can connect to the secondary units automatically or manually
- If the primary/secondary configuration is subsequently changed, it needs to be re-discovered

Primary/Secondary Configuration

Configure each paralleled instrument as either a Primary or Secondary.

Front Panel Menu Reference	SCPI Command
Select System\Group\Function In the dialog box, select either Primary, Secondary, or None. Then press Select.	To configure the paralleled unit: INST:GRO:FUNC PRIM SEC NON

If the unit is the primary, a delay may be programmed to allow the secondary units enough time to boot up before the primary auto-connects to the secondary. If there is a delay in powering up the secondary units, the primary auto-connect may fail. "None" is for non-paralleled operation. Do not connect units configured as None to the primary/secondary bus; this may cause a CSF fault.

Front Panel Menu Reference	SCPI Command
Select System\Group\Delay In the dialog box, set the auto-connect delay. Then press Select.	To set the auto-connect delay to 10: INST:GRO:PRIM:DEL 10

If the unit is a secondary, each secondary unit must be assigned a unique bus address (from 1 - 19).

Front Panel Menu Reference	SCPI Command
Select System\Group\Secondary In the dialog box, select the address of the secondary unit. Values can range from 1 - 19. Then press Select.	To set the Secondary address to 1: INST:GRO:SEC:ADDR 1

Specify the primary unit's connection mode.

AUTO – the primary unit will automatically connect to the previously discovered secondary units at power-on.

MANual – the primary will connect to the previously discovered secondary units when it receives a connection command from the front panel or from **INST:GRO:PRIM:CONN:MODE MAN**.

Front Panel Menu Reference	SCPI Command
Select System\Group\Mode In the dialog box, select the connection mode. Then press Select.	Set the primary unit's connection mode: INST:GRO:PRIM:CONN:MODE AUTO

After the secondary unit address configuration, run "Discover" on the primary unit to initiate communication with all secondary units. After initial discovery, the discovery process does not need to be run again unless the primary/secondary configuration changes.

Front Panel Menu Reference	SCPI Command
Select System\Group\Discover In the dialog box select Discover to discover all secondary units. Then press Select.	To discover the secondary units: INST:GRO:PRIM:DISC

To manually connect the primary unit to all previously discovered secondary units.

Front Panel Menu Reference	SCPI Command
Select System\Group\Connect In the dialog box select Connect to connect all secondary units to the primary. Then press Select.	To connect the primary unit to all discovered secondary units: INST:GRO:PRIM:CONN

Primary/Secondary Programming Considerations

Program the output voltage and current settings of the primary unit the same as you would an individual unit. Refer to **Set the Output Voltage** and **Set the Output Current** for details. The secondary units are locked; you cannot program the settings of the secondary units.

Set both positive and negative current limits high to allow for up/down programming transient dynamics. Transient dynamics are mainly a result of DUT capacitance charging currents. Note that the primary unit's current limit and current setting are automatically proportioned among the paralleled group according to the current rating of each unit.

Reduce the slew rates to mitigate imperfect voltage programming synchronization. By default, the slew rates are set to their maximum values.

NOTE

In current priority mode, set the output current of the primary unit to the desired value. Set the voltage limit to a higher value than the expected operating voltage of the unit.

Primary/Secondary Front Panel Display

The current value read from the front panel of the primary unit is the aggregate of the values of the primary and the secondary units. The secondary units return their individual current values.

The following example illustrates the front panel displays during primary/secondary operation. Three units are connected in a primary/secondary configuration. The units are operating in voltage priority mode.

This is the 10 kW primary unit.

- The "P" indicates the primary unit.
- The current displayed (100 A) is the total output current of all paralleled units. The unit is only contributing 40 A to the total.



This is the 10 kW secondary unit.

- The "S" indicates a secondary unit.
- The current displayed (40 A) is the current that this unit is contributing to the total.



This is the 5 kW secondary unit.

- The "S" indicates a secondary unit.
- The current displayed (20 A) is the current that this unit is contributing to the total. This is half of the current of the 10 kW units.



Primary/Secondary Communication

While connected, the primary unit periodically polls the secondary units for status. If communication with any secondary fails, for example if a secondary unit is turned on or off, the primary and remaining secondary units go into primary/secondary protection (PSP). When the remaining secondary units detect that the primary has disconnected, they also go into PSP. Additionally, a current-sharing fault (CSF) will likely occur if the **termination switches** are not set correctly.

Secondary units use the periodic primary status poll as a timer to trip PSP. If the secondary does not receive a status poll every 10 seconds or less, it goes into PSP.

Secondary units may go into PSP 10 seconds after power-on. Once these units are discovered, the primary unit will establish communication with the secondary units, thereby clearing the PSP.

Primary/Secondary Protection

If the primary unit goes into protection, it sends a protection command to the secondary units. The primary unit indicates the type of protection event that has occurred. The secondary units indicate PROT. Once the protection condition is corrected, clearing protection on the primary clears protection on all units (see **Clearing Protection**).

If a secondary unit goes into protection, the primary and the secondary unit on which the protection event occurred indicate the type of protection event. All other secondary units indicate PROT. Once the protection condition is corrected, clearing protection on the primary clears protection on all units.

When using the **Fault** or **Inhibit** functions on the rear panel digital connector, connect the Fault/Inhibit pins only on the primary unit. You do not need to connect the Fault/Inhibit pins of the secondary units.

Primary/Secondary Command Details

Once connected, the group of units are controlled through the primary and appear as a single higher power unit. All programming commands should be sent to the primary unit.

The following SCPI commands are **not supported** in primary/secondary mode:

CURRent:SHARing	Current sharing is automatically enabled
ELOG:CURRent<:MAX :MIN>	ELOG :MAX and :MIN commands
POWer:LIMit?	Power limit query
SYSTem:REBoot	Reboot command

The following additional SCPI commands are **only** supported for units with serial numbers starting with MY63000xxx and above, along with firmware revisions B.04.04.809 and above:

ARB	all ARB commands
ELOG	all ELOG commands
FETCh:CURRent<:HIGH :LOW :MAX :MIN>	all :HIGH :LOW :MAX and :MIN commands
FETCh:POWer<:MAX :MIN>	all :MAX and :MIN commands
FETCh:VOLTage<:HIGH :LOW :MAX :MIN>	all :HIGH :LOW :MAX and :MIN commands
MEASure:CURRent<:HIGH :LOW :MAX :MIN>	all :HIGH :LOW :MAX and :MIN commands
MEASure:POWer<:MAX :MIN>	all :MAX and :MIN commands
MEASure:VOLTage<:HIGH :LOW :MAX :MIN>	all :HIGH :LOW :MAX and :MIN commands
LIST	all LIST commands
TRIGger:ARB:SOURce	ARB source command
TRIGger:ACQ<:CURR:LEV :VOLT:LEV>	Level triggered acquisitions

The following SCPI commands can be sent to the secondary unit in primary/secondary mode.

FETCh<:VOLTage :CURRent :POWer>	only :VOLT :CURR :POW commands
MEASure<:VOLTage :CURRent :POWer>	only :VOLT :CURR :POW commands
All front panel SYSTEM\IO commands	only available on front panel menu

Parallel Operation at Maximum Current - RP793xA, RP794xA

Due to individual circuit tolerances between the paralleled units in a primary/secondary configuration, the current contributed by each unit may differ slightly from the “ideal amount”, which assumes that all units share current exactly equally. When operating at the maximum current rating of the paralleled group, these individual circuit tolerances could cause one or more of the units to depart from CV operation and enter into CC operation. The maximum current rating of the group will still be available, but the dynamic transient response may change due to the transition of one of the units into CC.

4 Using the Regenerative Power System

If strict CV operation is required under all operating conditions, especially at the maximum current rating of the paralleled group, it is recommended to set the CC limit to the maximum programmable value on the primary unit. If this is not sufficient, reduce the total requested load current, or consider adding an extra unit to provide additional headroom for the group to maintain CV operation under maximum load conditions.

Troubleshooting

If the following status indicators appear on the front panel:

PSP – primary/secondary protection

There has been a communication loss between the primary and secondary units. Check that the **CAT6A cables** are installed in the primary/secondary connectors, not in the LAN or Safety Disconnect.

CSF – Current sharing fault

There has been a current sharing fault due to the primary/secondary loop being out of regulation. This can occur if the **termination switches** are set incorrectly. It can also occur temporarily if there has been a mode crossover from a load transient or due to rapid up/down programming. If this is the case, set the current limit to a higher value. CSF can also occur if the loop can no longer regulate the current imbalance between units. CSF can also be an initial indication of communication loss with the primary unit; which will transition to PSP.

If the following error messages occur:

No secondary units discovered or 1 secondary discovered (if expecting multiple secondary units)

Check that there are no duplicate secondary addresses.

Error 332, Primary/Secondary Error

This most often indicates that the primary unit has lost communication with a secondary, and is usually accompanied by PSP. Check that the primary/secondary **CAT6A cables** are installed correctly. This can also occur when changing the primary/secondary configuration. Always set the primary unit to None when changing primary/secondary configurations.

Independent Parallel Operation – RP795xA, RP796xA

CAUTION

Never leave any units powered on while the others are off. If AC power is turned on or off on a single unit, the outputs of the units that are on will be enabled and will transition to their programmed settings. To prevent this, program the outputs of all units to zero before powering them off, and always power all units on and off together.

Enable Current Sharing

NOTE

The current sharing function is automatically enabled for models **RP795xA, RP796xA**. Units can be operated in parallel without current sharing, but the output current will not be shared equally, and constant voltage mode may not be maintained on all units.

Current sharing is an analog control function that fine-tunes the output voltage up to about 0.5% of the unit's voltage rating. This improves the current readback accuracy among paralleled units. This applies whether units are connected for primary/secondary operation or whether they are connected for independent parallel operation.

Units of equivalent current ratings will share current equally. Units of dissimilar current ratings will share current according to the ratio of their current rating. For example, a unit rated at 40 A and a unit rated at 20 A will share their output current in a 2-to-1 ratio.

In Independent Parallel operation only, the front panel status displays a "P", indicating that current sharing is enabled and the sharing relay has closed to connect the unit to the sharing bus. When the output is disabled, the sharing relay opens and disconnects the unit from the sharing bus.

Front Panel Menu Reference	SCPI Command
Select Output\Advanced\CurrSharing Check Enable current sharing to enable.	To enable current sharing: CURR:SHAR ON

Current Sharing Operation

In voltage priority mode:

- Program the initial output voltage setting of each paralleled unit to the same value.
- Set the current limit of each unit according to the following equations. This lets all units share current until the *total* current limit point is reached, which is the sum of the individual current limits.

For each 5 kW unit: $I_{CL_5kW} = I_{CL_TOTAL} / (N_T + N_{10kW})^*$

For each 10 kW unit: $I_{CL_10kW} = 2(I_{CL_TOTAL}) / (N_T + N_{10kW})$

where:

I_{CL_5kW} is the current limit setting of the 5 kW unit

I_{CL_10kW} is the current limit setting of the 10 kW unit

I_{CL_TOTAL} is the sum total of all individual current limits

N_T is the total number of paralleled units of any rating

N_{10kW} is the total number of paralleled 10 kW units

*If there are no 10 kW units used, then $N_{10kW} = 0$.

Note that in a mixed power configuration, you must set the current limit of the 10 kW units to twice the value of the 5 kW units. This is because in a mixed power configuration, each 10 kW unit will contribute twice as much current as each 5 kW unit.

When the current limit setting of any paralleled unit is reached, the output current of that unit will limit at its specified setting.

In current priority mode:

- Set the voltage limit of each paralleled unit to the same value.
- Program the current setting of each paralleled unit according to the equations above if current sharing is desired. The total output current will be the sum of all the individual current settings.

Note that in current priority mode, the sharing configuration will balance the currents only if all of the units are operating in voltage limit mode, with the VL+ status annunciator on.

Parallel Effects on Load Regulation

The design of the RPS has been optimized for parallel operation. Therefore, the effect of paralleled units on the specifications has been kept to a minimum. When units are paralleled, there is no degradation of any specification other than the load regulation specification. All other specifications, including output noise, programming accuracy, readback accuracy, and transient response are unaffected by paralleled operation.

With two or more units are paralleled with current sharing enabled, there will be a small additional voltage regulation effect. The worst case additional voltage regulation effect is as follows:

$$\Delta V_{OUT(WORST_CASE)} = 0.003\%(V_{RATING})$$

To determine the total output voltage regulation effect for a specific unit, you must add the worst-case value from the following table to the **CV load regulation specification** for each paralleled unit. These are the worst-case values for each unit based on its voltage rating.

V _{RATED}	ΔV _{OUT(WORST_CASE)}	V _{RATED}	ΔV _{OUT(WORST_CASE)}
500 V	15 mV	950 V	28.5 mV

Example: You have two 500 V units connected in parallel. The load regulation effect due to current sharing is 15 mV from the table above. The CV load regulation specification is 30 mV. Therefore, the total output voltage regulation effect is 30 mV + 15 mV, or 45 mV.

Current Sinking Operation

Current Sinking

Regenerative Operation

Current Sinking

Current sinking, also referred to as downprogramming, is the ability to pull current into the positive terminal of the DC power supply. For example, the power supply pulls or sinks current into the positive terminal whenever a lower output voltage is programmed. This is necessary because stored energy from the power supply's output capacitor and external capacitance from the load including the wiring must be discharged to lower the voltage at the output terminals.

The ability to rapidly transition from a higher to a lower constant voltage level greatly improves the power supply's output response time. This is the most commonly used application of the regenerative function of the RPS, which is automatic and completely transparent to the user.

The DC power supply can continuously sink up to 100% of its rated current for an indefinite time. This **two-quadrant** sourcing and sinking capability of the DC power supply allows for seamless transitions between sourcing and sinking current without changing the power supply's output characteristics or introducing any disruptive behavior. The following controls are provided to fully utilize the two-quadrant output capability of the supply.

Current Limit control in voltage priority mode

When operating in voltage priority mode, you can program a negative and positive **current limit**. This will limit any current overshoots that may occur during rapid up- or down-programming.

Current setting control in current priority mode

When operating in current priority mode, you can program the output current to seamlessly cross the zero point when transitioning from positive to negative or negative to positive. Additionally, when operating in the negative current quadrant, you can program a negative **current setting** that will hold the sink current at the specified value. This is useful, for example, for discharging a battery at a constant current rate.

If your application requires precise control of the source and sink currents, current **slew controls** are available to specify a current slew rate when sourcing and sinking current.

Regenerative Operation

Regenerative operation is automatic and requires no programming on the part of the user. Whenever the unit is sinking current, either by rapidly downprogramming the output, or by discharging an energy source such as a battery, the unit will direct the excess power back into the AC mains. Refer to **AC Mains Considerations** for additional information.

Programming Output Protection

Set the Over-Voltage Protection

Set the Over-Current Protection

Output Watchdog Timer

Set the Under-Voltage Protection

Clear Output Protection

Introduction

The RPS models have many protection functions. These functions disable the output to protect the device under test (DUT), as well as the power supply. A front panel status indicator will turn on when a protection function has been set. Most protection functions are latching, which means that they must be cleared once they have been set.

CAUTION

All protections cause a high impedance output disconnect. The output is disconnected without actively sinking current, so the DUT's voltage discharge depends on its characteristics. The DUT and load lead inductance must be within the specified hardware limits to safely absorb any stored energy. Refer to the Maximum Load Inductance limits under **RP793xA, RP794xA characteristics**.

Of the following protection functions, the OV, OC, PROT, INH, and UV are user-programmable.

OV Over-voltage protection is a hardware protection whose trip level is user-programmable. OV protection occurs automatically if the remote sense leads are shorted. OV protection is always enabled.

OV- Negative over-voltage protection trips if the remote sense leads are reversed. At turn-on, it also trips if voltages more negative than -5V for models **RP795xA, RP796xA**, or -1% of the rated output for models **RP793xA, RP794xA** are present at the output terminals. After turn-on the level increases to -20% for models RP793xA and RP794xA. OV- protection is not programmable and is always enabled.

OC Over-current protection is a user-programmable function that can be enabled or disabled. When enabled, the output will be disabled when the output reaches the current limit setting. An OCP also occurs if internal current limitations are exceeded regardless of the OCP setting.

CP+ Positive over-power compares the output power against a built-in threshold. A CP+ protection occurs when the threshold is exceeded. CP+ protection is always enabled.

CP- Negative over-power compares the internally dissipated power against a built-in threshold. A CP- protection occurs when the threshold is exceeded. CP- protection is always enabled.

OT Over-temperature protection monitors the internal temperature of the power supply and disables the output if the temperature exceeds the pre-defined limit (see **OUTPUT:PROTECTION:TEMPERATURE:MARGIN?**). OT protection is always enabled.

PF Power-fail indicates that a power fail condition on the AC mains has occurred and has disabled the output. PF protection is always enabled.

EDP excessive dynamic protection

For models **RP795xA, RP796xA**, EDP disables the output in the event of excessive large repetitive voltage swings caused by programmed voltage changes, lists, Arbs, or load-induced voltage swings (see **Output Dynamic Response**). If unchecked, these voltage swings could result in premature failure of components in the unit. EDP protection is always enabled.

For models **RP793xA, RP794xA**, EDP disables the output in the event of large dynamic power transfers that could damage the unit. This could happen, for example, if unintended and sustained oscillations cause large power transfers - from full power sourcing to full power sinking. Assuming that the unit is operating within the suggested operating conditions, EDP should not engage under normal conditions. EDP protection is always enabled.

Prot Protection indicates the output is disabled because the programmed output watchdog timer expired. It also indicates that a PSP fault has occurred on a secondary unit.

INH The Inhibit input (pin 3) on the rear panel digital connector can be programmed to act as an external shutdown signal. Refer to **Inhibit Input** for details.

UV For models **RP793xA, RP794xA**, under-voltage protection prevents the voltage from dropping below the low-voltage limit setting when discharging a battery. It also prevents the output from turning on if the output voltage is below the programmed low-voltage level.

PSP A Primary/Secondary Protection fault has occurred in the paralleled group. All outputs of all paralleled units are disabled. PSP is always enabled. Refer to **Parallel Protection** for details.

SDP A Safety Disconnect Protection fault has occurred due to a Keysight SD1000A SDS hardware or communication failure. The unit must be rebooted to clear this protection condition. Refer to **SDP protection** for details.

DOV+ Positive DUT over-voltage is active when the output is off and then turned on in HIGHZ mode. If the DUT is applying a voltage on the output terminals less than the following voltage levels, the output will not turn on to prevent excessive current from flowing **into** the unit.

Voltage priority: if the DUT voltage exceeds the programmed voltage + 1% of the unit's rated voltage.

Current priority: if the DUT voltage exceeds the positive voltage limit + 1% of the unit's rated voltage.

DOV- Negative DUT over-voltage is active when the output is off and then turned on. If the DUT is applying a voltage on the output terminals less than the following voltage levels, the output will not turn on to prevent excessive current from flowing **out** of the unit.

Voltage priority: if the DUT voltage is less than - 1% of the unit's rated voltage.

Current priority: if the DUT voltage is less than the negative voltage limit - 1% of the unit's rated voltage.

LOV+ Positive local over-voltage protection trips if the remote sense leads are accidentally shorted. This protection minimizes the resulting rise in output voltage by comparing the voltage on the output terminals to a voltage level that is 1 volt plus 10% of rating above the user-programmed positive OVP level. If the output voltage exceeds this level the unit goes into a latched protection state. LOV is always enabled.

LOV- Negative local over-voltage protection is not available on two-quadrant models.

4 Using the Regenerative Power System

OCF+ Positive over-current fault is active when the DUT applies a reverse voltage to the output terminals. It minimizes the resulting peak current at the output terminals by comparing the actual output current to a fixed level of 105% of the unit's rated current. If the current exceeds this level, the unit will go into a latched protection.

OCF- Negative over-current fault is active in current priority mode, when the DUT applies a voltage to the output terminals that is greater than the positive current limit setting. It minimizes the resulting peak current at the output terminals by comparing the actual output current to a fixed level of 105% of the unit's rated current. If the current exceeds this level, the unit will go into a latched protection.

NOTE

DOV, LOV, OCF, are only available on units with firmware revision B.04.04.809 and up.

Set the Over-Voltage Protection

The over-voltage protection will turn the output off if the output voltage reaches the programmed over-voltage limit. The OVP circuit monitors the voltage at the + and – sense terminals. An OVP shutdown will automatically occur if the + and – sense leads are accidentally shorted to each other.

Front Panel Menu Reference	SCPI Command
Select Protect\OVP Enter a value in the OVP level box. Then press Select .	To set the OVP level to 400 volts: VOLT:PROT 400

Set the Over-Current Protection

Enable OCP

With over-current protection enabled, the output turns off when the output current reaches the current limit setting and transitions from constant voltage (CV) to current limit (CL+ or CL-).

Front Panel Menu Reference	SCPI Command
Select Protect\OCP Check Enable OCP . Then press Select .	To enable OCP: CURR:PROT:STAT ON

Delay OCP

You can specify an OCP delay to prevent momentary output settings, load, and status changes from tripping the over-current protection. In most cases these momentary conditions would not be considered an over-current protection fault, and having an OCP condition disable the output when they occur would be a nuisance. Specifying an OCP delay lets the OCP circuit ignore these momentary changes during the specified delay period. Once the OCP delay time has expired and the over-current condition persists, the output will shut down.

The following selections are available to start the over-current delay timer:

Settings Change this starts the over-current delay whenever a command changes the output settings. It includes changes made by the transient system so that the timer is started at each list step and at

each Arb output change. It also includes voltage and current slew changes, so that the timer is restarted throughout the entire slew time.

Current Limit starts the over-current delay timer by any transition of the output into current limit.

The delay can be programmed from 0 to 0.255 seconds. You can specify if the OCP delay timer is started by any transition of the output into current limit, or only at the end of a settings change in voltage, current, or output state.

Front Panel Menu Reference	SCPI Command
Select Protect\OCP	To specify a 10 millisecond delay: CURR:PROT:DEL 0.01
Enter a delay value. Then press Select .	
By default, the delay timer will be started by an output "Settings Change".	To start the delay timer by an output settings change: CURR:PROT:DEL:STAR SCH
Check "CC Transition" to start the delay timer by ANY output transition into CL mode.	To start the delay timer by ANY output transition into CL mode: CURR:PROT:DEL:STAR CCTR

Factors that influence how long the output settings or load change may last include: difference between old output value and new output value, the current limit setting, and the load capacitance in voltage priority mode or load inductance in current priority mode. The delay required must be determined empirically; the output programming-response time characteristics may be used as guidelines.

Also note that the time it takes the output to go into current limit (CL) varies - depending on the magnitude of the over-current condition compared to the current limit setting. For example, if the over-current is only slightly greater than the current limit setting, it may take several tens of milliseconds for the output to set the CC status bit. If the over-current is significantly greater than the current limit setting, it may only take a few hundred microseconds or less for the output to set the CL status bit. To determine when the output will shut down, you must add the time it takes for the CL status bit to the over-current protection delay time. If the over-current persists beyond the sum of both time intervals, the output will shut down.

In primary/secondary operation, current sharing during fast load current transitions could lead to false protection tripping if OCP is programmed independently on each unit. It is recommended that OCP is only programmed for the primary unit. The primary/secondary OCP is implemented by the primary unit's firmware polling the status of each secondary unit. Note however, that this may result in delay timing to be off by a factor of up to 0.5 seconds.

Output Watchdog Timer

When enabled, the output watchdog timer causes the output to go into protection mode if there is no SCPI I/O activity on the remote interfaces (USB, LAN, GPIB) within the user-specified time period. Note that the watchdog timer function is NOT reset by activity on the front panel - the output will still shut down after the time period has elapsed.

4 Using the Regenerative Power System

After the time period has expired, the output will be disabled, but the programmed output state is not changed. The Prot bit in the status questionable register as well as the Prot indicator on the front panel will be set. A watchdog protect can be cleared as described under Clear Output Protection Functions.

The watchdog delay can be programmed from 1 to 3600 seconds in 1-second increments. To enable the watchdog timer and specify a delay value, proceed as follows:

Front Panel Menu Reference	SCPI Command
Select Protect\WDog	To enable the output watchdog timer: OUTP:PROT:WDOG ON
Check Enable Watchdog to enable the watchdog timer.	To set the output watchdog timer to 120 seconds: OUTP:PROT:WDOG:DEL 120
Enter a value in the Watchdog Delay box. Then press Select .	

Set the Under-Voltage Protection

NOTE

This information applies to models RP793xA and RP794xA only. **RP793xA, RP794xA**

The under-voltage protection will turn the output off if the output voltage falls below the programmed low voltage setting. The voltage circuit monitors the voltage at the + and – sense terminals.

This feature is used when discharging batteries to prevent the battery voltage from dropping below the low voltage setting.

In voltage priority mode, the output voltage must be at the target value before the under-voltage protection is enabled to prevent the unit from tripping during output up-programming. A delay can be set that is longer than the output up-programming time to prevent the protection from tripping during the voltage transition.

In current priority mode, if the output is turned on with the voltage limit set to a value below the low-voltage setting, the under-voltage protection will also trip.

The under-voltage protection delay can be programmed from 20.48 microseconds to 2611 seconds in 20.48 microsecond increments. To enable the under-voltage protection and specify a delay value, proceed as follows:

Front Panel Menu Reference	SCPI Command
Select Protect\UVP	To set the UVP level to 2 volts: VOLT:PROT:LOW 2
Enter a value in the UVP level box. Then check Enable UVP	To enable low-voltage protection: VOLT:PROT:LOW:STAT ON
Enter a value in the UVP Delay box. Then press Select .	To specify a protection delay of 5 seconds: VOLT:PROT:LOW:DEL 5

Clear Output Protection

If an over-voltage, over-current, over-temperature, power-fail condition, power-limit condition, protection condition, or inhibit signal occurs, the output is disabled. The appropriate operating status indicator on the front panel will be on. To clear the protection function and restore normal operation, first remove that condition that caused the protection fault. Then, clear the protection function as follows:

Front Panel Menu Reference	SCPI Command
Select Protect\Clear Select Clear.	To clear a protection fault: OUTP:PROT:CLE

NOTE

The output is re-enabled once the output protection function is cleared.

Programming Output Transients

Common Actions for All Transients

Programming a Step Transient

Programming a List Transient

Programming an Arbitrary Waveform

Limiting Sinusoidal Outputs

Output Transients

An output transient is defined as a triggered action that causes a change in output voltage or current. The three available transient types are: step, list, and arbitrary waveforms.

Step - a one-time event that steps the output voltage or current up or down in response to a trigger.

List - describes a precisely timed, complex sequence of output steps or changes.

Arbitrary Waveform - allows the output to generate complex user-defined voltage or current waveforms of up to 65,535 data points.

Common Actions for All Transients

- Enable the output transient function
- Program the transient parameters
- Select the trigger source
- Initiate the transient system
- Trigger the transient

The transient trigger process is illustrated below. This applies to all transient types. The arrows on the right are specific to List transients. For an overview of the trigger system, refer to [Trigger Overview](#).

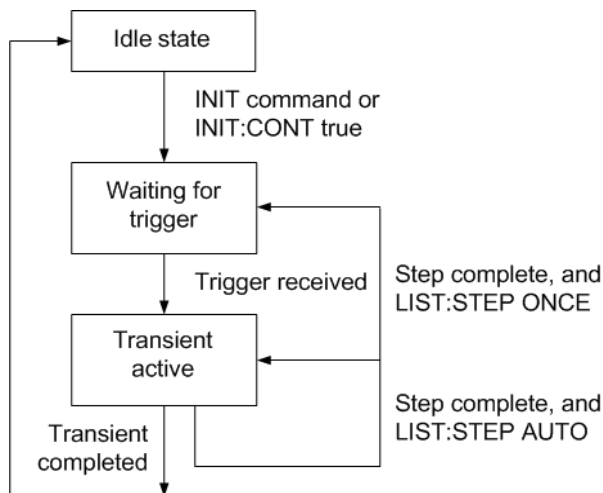

Enable the output transient function

First, you must enable the output to respond to transient triggers. Unless an output transient function enabled, nothing will happen even if you have programmed the transient parameters and generated a transient trigger.

Front Panel Menu Reference	SCPI Command
Select Transient\Mode . If you are operating in voltage priority mode select Voltage mode. If you are operating in current priority mode select Current mode. In the dropdown list, select Step, List or Arb transients. Then press Select .	To enable the transient function, use: VOLT:MODE STEP VOLT:MODE LIST VOLT:MODE:ARB or CURR:MODE STEP CURR:MODE:LIST CURR:MODE:ARB

NOTE

In Step mode, the triggered value becomes the immediate value when the trigger is received. In Fixed mode, trigger signals are ignored; the immediate values remain in effect when a trigger is received.

Program the transient parameters

For example, set the triggered voltage level if you are programming a voltage step:

Front Panel Menu Reference	SCPI Command
Select Transient\Step . Select the Trig Voltage box to set the voltage. Enter a value and press Select.	To set a voltage step level of 15 V use: VOLT:TRIG 15

Select the trigger source

NOTE

A TRIGger:TRANsient[:IMMediate] command over the bus will always generate an immediate transient trigger, regardless of the selected trigger source.

Unless you are using the front panel menu or a TRIGger:TRANsient[:IMMediate] command to trigger the transient, select a trigger source from the following:

Trigger Source	Description
Bus	Selects GPIB device trigger, *TRG, or <GET> (Group Execute Trigger).
External	Selects ANY pin that has been configured as a Trigger Input on the digital control port.
Immediate	Triggers the transient as soon as it is INITiated.
Pin<1-7>	Selects a specific pin<n> that is configured as a Trigger Input on the digital control port.

Use the following commands to select a trigger source:

4 Using the Regenerative Power System

Front Panel Menu Reference	SCPI Command
Select Transient\TrigSource .	To select Bus triggers:
To select immediate triggers, select Imm.	TRIG:TRAN:SOUR BUS
To select Bus triggers, select Bus.	To select digital pin 5 as the trigger:
To select digital pin 5 as the trigger, select Pin 5, or EXT.	TRIG:TRAN:SOUR PIN5

Initiate the transient system

When the unit is turned on, the trigger system is in the idle state. In this state, the trigger system is disabled, ignoring all triggers. The INITiate commands enable the trigger system to receive triggers.

Front Panel Menu Reference	SCPI Command
Select Transient\Control .	To initiate the transient trigger system:
Scroll to Initiate. Then press Select .	INIT:TRAN

It takes a few milliseconds for the instrument to be ready to receive a trigger signal after receiving the INITiate:TRANSient command. If a trigger occurs before the trigger system is ready for it, the trigger will be ignored. You can test the WTG_tran bit in the operation status register to know when the instrument is ready to receive a trigger after being initiated.

Front Panel Menu Reference	SCPI Command
Select Transient\Control .	To query the WTG_tran bit (bit 4):
The Trig state field indicates "Initiated".	STAT:OPER:COND?

If a bit value of 16 is returned in the query, the WTG_tran bit is true, and the instrument is ready to receive the trigger signal. Refer to [Status Tutorial](#).

NOTE

Unless INITiate:CONTinuous:TRANSient is programmed, the instrument executes one transient each time a trigger signal is received. Thus, it will be necessary to initiate the trigger system each time another triggered transient is desired.

Trigger the transient

The trigger system is waiting for a trigger signal in the initiated state. You can immediately trigger the transient as follows:

Front Panel Menu Reference	SCPI Command
Select Transient\Control .	To generate a transient trigger:
Select Trigger to generate an immediate trigger signal regardless of the trigger source setting.	TRIG:TRAN
	Alternatively, if the trigger source is BUS, you can also program a *TRG or an IEEE-488 <get> command.

If a digital pin is configured as the trigger source, the instrument will wait indefinitely for the trigger signal. If the trigger does not occur, you must manually return the trigger system to the idle state. The following commands return the trigger system to the idle state:

Front Panel Menu Reference	SCPI Command
Select Transient\Control . Then select the Abort control.	ABOR:TRAN

When a trigger is received, the triggered functions are set to their programmed transient values. When the triggered actions are completed, the trigger system returns to the idle state.

You can test the TRAN-active bit in the Operation Status register to know when the transient trigger system has returned to the idle state.

Front Panel Menu Reference	SCPI Command
Select Transient\Control . The Trig state field indicates "Idle".	To query the TRAN-active bit (bit 6): STAT:OPER:COND?

If a bit value of 64 is returned in the query, the TRAN-active bit is true, and the transient action is NOT complete. When the TRAN-active bit is false, the transient action is complete. Refer to [Status Tutorial](#) for more information.

Programming a Step Transient

Program the Step Levels

Use the following commands to program the triggered output step level. The output will go to this level when the trigger is received. In the front panel menu, you can only program the step level based on the priority mode that you are operating in - voltage or current priority.

Front Panel Menu Reference	SCPI Command
Select Transient\Step . Select the Trig Voltage box to set the voltage. Select the Trig Current box to set the current. Enter a value and press Select.	To set a voltage step level of 15 V use: VOLT:TRIG 15 To set a current step level of 1 A use: CURR:TRIG 1

Generate a Trigger Out Signal

The output step can generate a trigger signal that can be routed to a pin on the digital port that has been configured as a trigger output (TOUT). Use the following commands to generate a trigger signal when the step occurs:

Front Panel Menu Reference	SCPI Command
Select Transient\Step . Check Enable Trigger Output. Then press Select .	To program a Step trigger signal, use: STEP:TOUT ON

Programming a List Transient

- Program the list levels
- Program the dwell times
- Specify the list pacing
- Specify any trigger signals that the list should generate
- Specify how many times you want the list to repeat
- Specify how you want the list to end

Lists let you generate complex sequences of output changes with rapid, precise timing, which may be synchronized with internal or external signals. In contrast to an output step, which is a one-time output change, an output list is a sequence of output changes. Lists can contain up to 512 individually programmed steps, and can be programmed to repeat themselves. Only the parameters associated with one of the priority modes, either voltage or current priority, may be list controlled.

The voltage and current lists are paced by a separate dwell list that defines the duration or dwell of each step. Each of the up to 512 steps can have a unique dwell time associated with it, which specifies the time in seconds that the list will remain at that step before moving on to the next step. Refer to **LIST:DWEL** for information about the dwell range and resolution.

Lists can also be trigger-paced, in which the list advances one step for each trigger received. This is useful if you need an output list to closely follow triggered events. With a trigger-paced list, triggers that are received during the dwell period are ignored. You can set the list dwell time to zero ensure that no triggers are lost.

Lists can also generate trigger signals at specified steps. This is accomplished by two additional lists: a beginning-of-step (BOST) and an end-of-step (EOST) list. These lists define which steps will generate a trigger signal and if the trigger occurs at the beginning or end of the step. These trigger signals can be used to synchronize other events with the list.

All lists (voltage, current, dwell, BOST, EOST) must be set to the same number of steps, otherwise an error occurs when the list is run. For convenience, a list may be programmed with only one step or value. In this case, a single-step list is treated as if it had the same number of steps as the other lists, with all values being equal to the one value.

List data is not saved as part of a saved instrument state.

NOTE

If you are using lists or arbs to generate sinusoids near the grid frequency, there will be additional distortion currents in the line. Refer to the **Limiting Sinusoidal Outputs** section.

Program the list levels

Example 1 If you are programming a voltage pulse or pulse train, set the amplitude of the pulse. For example, to generate a pulse with an amplitude of 15 V, program the amplitude for the pulse (step 0), and the amplitude for the off time (step 1).

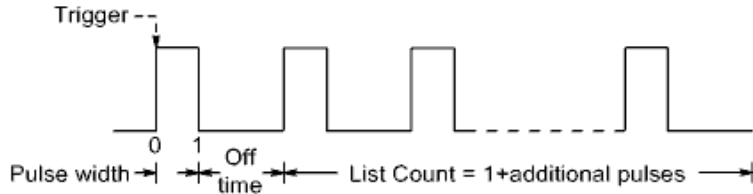

Front Panel Menu Reference	SCPI Command
Select Transient\List\Config .	To program the amplitude for step 0 (the pulse) and step 1 (the off time):
Select List Step 0 (the pulse) and enter a voltage value of 15. Press Select.	LIST:VOLT 15,0
Select List Step 1 (the off time) and enter a voltage value of 0. Press Select. Use the up/down arrows to select the next step.	

Example 2 If you are programming an arbitrary voltage list, specify the amplitudes for the list. The order in which the values are entered determines the order in which the values will be output. To generate the voltage list shown in the figure, a list may include the following values: 9, 0, 6, 0, 3, 0:

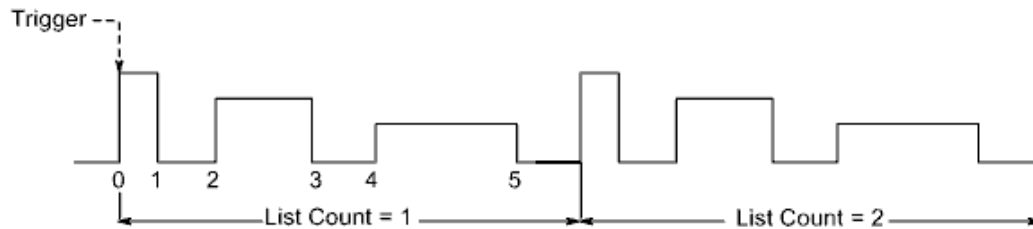

Front Panel Menu Reference	SCPI Command
Select Transient\List\Config .	To program a voltage list of 5 steps:
Select the List Step number and enter a voltage value. Press Select.	LIST:VOLT 9,0,6,0,3,0
Repeat this for each step. Use the up/down arrows to select the next step.	

Program the dwell times

Example 1 If you are programming a voltage pulse, set the dwell time of the pulse width. Also specify the dwell of the off time. This is necessary if you are generating a pulse train, since the off time determines the time between pulses. To generate a pulse with a pulse width of 1 second and an off time of 2 seconds, use:

4 Using the Regenerative Power System

Front Panel Menu Reference	SCPI Command
Select Transient\List\Config .	To program the dwell for step 0 (the pulse) and step 1 (the off time):
Select List Step 0 (the pulse) and enter a dwell value of 1. Press Select.	LIST:DWEL 1,2
Select List Step 1 (the off time) and enter a dwell value of 2. Press Select. Use the up/down arrows to select the next step.	

You have now configured a single pulse. If you wish to generate a pulse train, simply specify the number of pulse repetitions as described under "Specify How Many Times the List Repeats".

Example 2 If you are programming an arbitrary voltage list, specify the amplitudes for the list. The dwell values determine the time interval, in seconds, that the output remains at each step in the list before it advances to the next step. To specify the six dwell intervals in the figure, a list may include the following values: 2, 3, 5, 3, 7, 3:

Front Panel Menu Reference	SCPI Command
Select Transient\List\Config .	To program a dwell of 5 values, use:
Select the List Step number and enter a dwell value. Press Select.	LIST:DWEL 2,3,5,3,7,3
Repeat this for each step. Use the up/down arrows to select the next step.	

NOTE

The number of dwell steps must equal the number of voltage steps. If a dwell list has only one value, that value will be applied to all steps in the list.

Specify the list pacing

You can specify if the list will be dwell or trigger-paced. The default selection is dwell-paced.

In a dwell paced list, each step is assigned a dwell time. The dwell time determines the time that the output remains at the step. As each dwell time elapses, the next step is immediately output.

In a trigger-paced list, the list advances one step for each trigger received. You can also a dwell period if you want to ignore triggers during the dwell time, or guarantee a minimum dwell time between triggered list steps.

Front Panel Menu Reference	SCPI Command
Select Transient\List\Pace .	To set the list pacing to dwell-paced:
Select either Dwell paced or Trigger paced. Then press Select .	LIST:STEP AUTO
	To set the list pacing to trigger-paced:
	LIST:STEP ONCE

Specify any trigger signals that the list should generate

You can generate trigger signals that can be routed to other destinations. For example, you can use trigger signals to trigger actions on any external equipment connected to the digital port. The following figure gives an example of generating four trigger signals on the arbitrary list of Example 2.

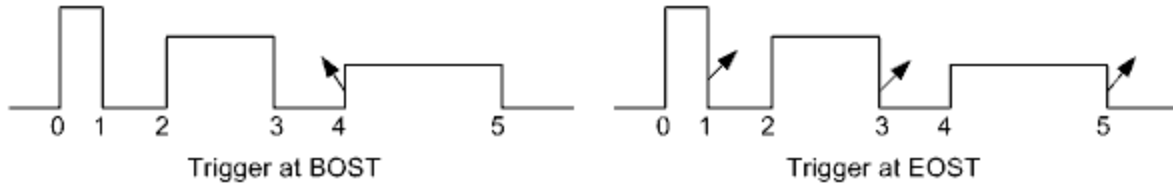

Front Panel Menu Reference	SCPI Command
Select Transient\List\Config .	To program a trigger at the beginning of step 4:
Select the List Step number 4. To generate a trigger, enter a 1 in the Tout Begin Step field.	LIST:TOUT:BOST 0,0,0,0,1,0
Select the List Step numbers 0, 2, and 4. To generate a trigger, enter a 1 in the Tout End Step field.	To program a trigger at the end of step 0, 2, and 4:
If zeroes are entered in the fields, no trigger is generated for the step.	LIST:TOUT:EOST 1,0,1,0,1,0

Specify how many times you want the list to repeat

You can specify how many times you want the list (or pulse) to repeat. At reset, the list count is set to 1 repetition. Sending the INFINITY parameter in the SCPI command makes the list repeat indefinitely.

Front Panel Menu Reference	SCPI Command
Select Transient\List\Repeat .	To program the list to repeat twice:
Enter the number of list repetitions (2) and press Select.	LIST:COUN 2

Specify how you want the list to end

Specify the output state after the list has completed. There are two choices: the output returns to the value that was in effect before the list started, or the output remains at the value of the last list step.

Front Panel Menu Reference	SCPI Command
Select Transient\List\Terminate .	To return the output to the pre-list state:
Select either Return to Start, or Stop at Last Step and press Select.	LIST:TERM:LAST OFF
	To keep the output at the end list state:
	LIST:TERM:LAST ON

Programming an Arbitrary Waveform

- Specify the Arb type and dwell
- Configure the Arb
- Specify how many times you want the Arb to repeat
- Specify how you want the Arb to end

NOTE

If you are using lists or arbs to generate sinusoids near the grid frequency, there will be additional distortion currents in the line. Refer to the [Limiting Sinusoidal Outputs](#) section.

The output of the Keysight RPS models can be modulated by the instrument's built-in arbitrary waveform generator. This allows the output to generate complex user-defined voltage or current waveforms. The following are key features of the constant-dwell arbitrary waveform generator:

- Generate voltage or current arbitrary waveforms.
- Arbs can contain up to 65,535 data points.
- A single dwell value applies to every point in the constant-dwell arbitrary waveform (see [ARB:VOLT:CDW:DWEL](#) for dwell information).
- Only the Arb that corresponds to the active priority mode, either voltage or current priority, may be generated.

Specify the Arb type and dwell

To specify the Arb type and dwell:

Front Panel Menu Reference	SCPI Command
Select Transient\Arb\Config . In the dropdown list, pick either a voltage or a current Arb. Then press Select .	To specify a voltage or current Arb: ARB:FUNC:TYPE VOLT ARB:FUNC:TYPE CURR
Enter a dwell value in the Dwell field. Then press Select .	To specify a dwell time of 1 millisecond: ARB:VOLT:CDW:DWEL 0.001 ARB:CURR:CDW:DWEL 0.001

Configure the Arb

Note that you can only view Arb point data from the front panel. You cannot *program* Arb data from the front panel. You must use the SCPI [ARB:CURRent:CDWell](#) or [ARB:VOLTage:CDWell](#) commands to program the Arb data.

Front Panel Menu Reference	SCPI Command
Select Transient\Arb\Config .	To program 10 points in a current Arb: ARB:CURR:CDW 1,2,2,3,4,4,3,2,2,1
If Arb points have been imported or programmed using the SCPI command, the Points field displays the number of points in the Arb.	To query the number of Arb points: ARB:CURR:CDW:POIN?
View the amplitude of any Arb point by entering the point number in the Point # field. The Level field displays the amplitude.	To query the Arb point values: ARB:CURR:CDW?

Specify how many times you want the Arb to repeat

Depending on your application, specify how many times you want the Arb to repeat. Sending the INFinity parameter in the SCPI command makes the Arb repeat indefinitely. At reset, the Arb count is set to 1.

Front Panel Menu Reference	SCPI Command
Select Transient\Arb\Repeat .	To program the Arb to repeat twice: ARB:COUN 2
Enter the number of list repetitions (2) and press Select.	

Specify how you want the Arb to end

Specify the output state after the Arb has completed. There are two choices: the output returns to the state it was in before the Arb started, or the output remains at the values of the last Arb point.

Front Panel Menu Reference	SCPI Command
Select Transient\Arb\Terminate .	To return the output to the pre-Arb state: ARB:TERM:LAST OFF
Select either Return to Start, or Stop at Last Step and press Select.	To keep the output at the Arb end point: ARB:TERM:LAST ON

Limiting Sinusoidal Outputs

Generating Sinusoidal Outputs

Unipolar voltage RP7900 series power supplies were not intended to operate as a sinusoidal AC source or load at the local grid frequency. Under these conditions the unit may shut down. To avoid this issue when generating sinusoidal outputs, you must shift the output sinusoid frequency away from the local grid frequency as shown in the following graphs.

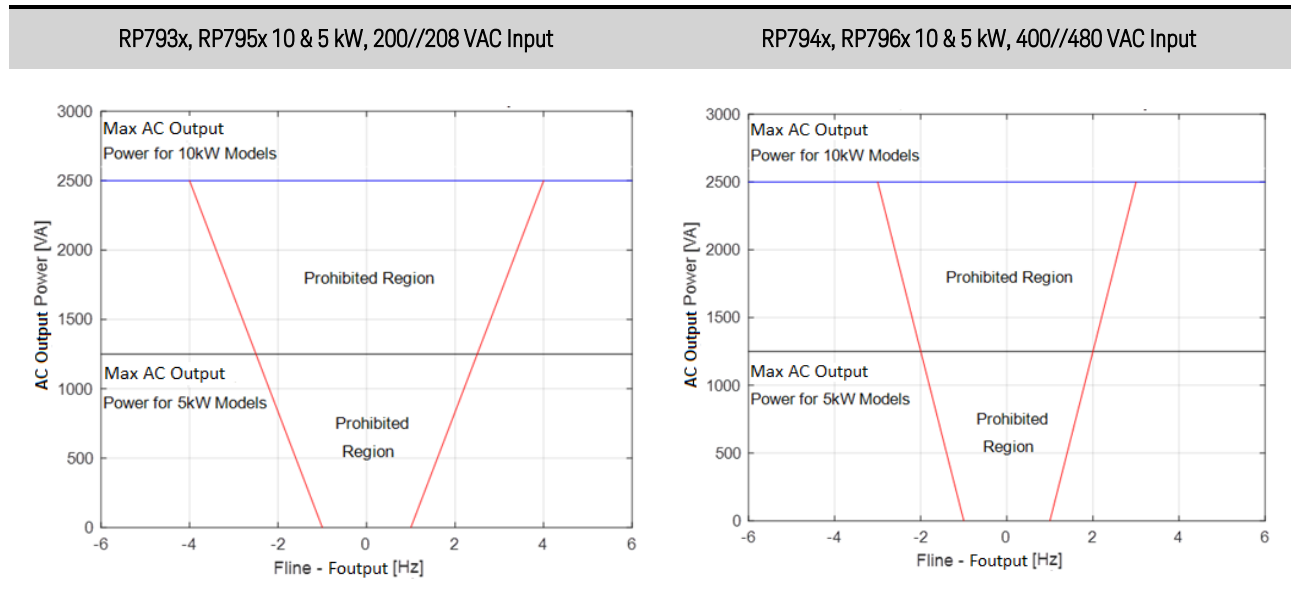

Assuming that a sinusoid is to be imposed on top of a $(1/2)*V_{max}$ DC offset voltage, the maximum possible AC power is calculated below. Note that operating the unit near the local grid frequency will generate additional harmonics on the AC input lines.

$$V_{dc} = V_{max}/2$$

$$V_{sin_amplitude} = V_{max}/2$$

$$V_{ac_rms} = V_{max}/(2*\sqrt{2})$$

$$I_{sin_amplitude} = I_{max}$$

$$I_{ac_rms} = I_{max}/\sqrt{2}$$

$$P_{peak} = (V_{sin_amplitude} + V_{dc}) * I_{max}$$

$$P_{ac} = V_{ac_rms} * I_{ac_rms} = (V_{max} * I_{max}) / 4$$

For example:

$$P_{peak} = (40V + 40V) * 125A = 10kW$$

$$P_{ac} = (80V * 125A) / 4 = 2.5kW$$

Note that the instantaneous P_{peak} cannot exceed the DC power rating of the unit.

Sequencing the Output

This section describes how you can synchronize output turn-on and turn-off sequences on single and multiple units.

Turn-On/Turn-Off Delays

Coupling the Output

Sequencing Multiple Units

Output Turn-On/Turn-Off Behavior

Turn-On/Turn-Off Delays

All power supplies exhibit an internal delay offset that applies from the time that a command to turn on the output is received until the output actually turns on. Specifying a common delay offset will serve as a reference point for any user-programmed turn-on delays. This user-defined offset also makes it possible to connect multiple power supplies together and program accurate turn-on sequences across multiple outputs. The user-programmed turn-on delay will then be added to the common user-defined reference point.

There is no need to specify a common delay offset when outputs turn off. Outputs start executing their turn-off delays as soon as an Output Off command is received. The internal delay offset is shown in the following table.

	Voltage Priority	Current Priority
Without SD1000A safety disconnect unit	≤ 12 milliseconds	≤ 14 milliseconds
With SD1000A safety disconnect unit	≤ 158 milliseconds	≤ 167 milliseconds

Coupling the Output

In addition to the front panel and SCPI Output On and Output Off commands, you can also use OnCouple and OffCouple signals to enable and disable the output. These signals provide an additional level of control when sequencing the output on individual and multiple units.

The following figure illustrates the programming path when using the OnCouple and OffCouple signals to control the output.

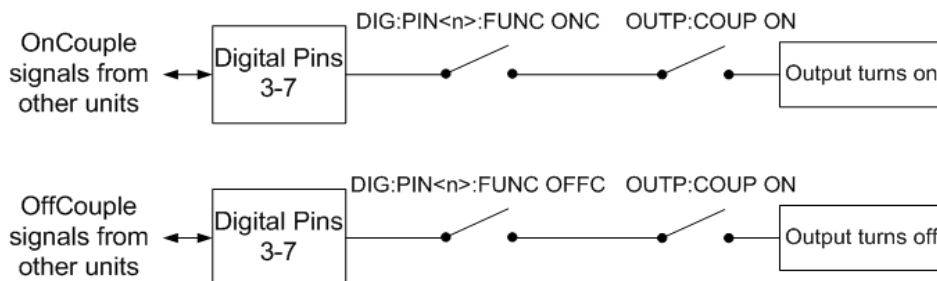

4 Using the Regenerative Power System

As shown in the figure, you can configure digital ports pins 3 through 7 to provide the OnCouple and OffCouple signals that enable or disable the output. The output is enabled or disabled when the corresponding signal is true. Refer to **Output Couple Control** for more information on configuring the digital port pins.

Lastly, you must enable output sequencing to use OnCouple and OffCouple signals to enable or disable the output. Refer to Enable Output Sequencing below.

Sequencing Multiple Units

To sequence the output turn-on for multiple units:

1. Connect and configure the digital connector pins of all units.
2. Enable the sequence function on each unit.
3. Specify the user-programmed turn-on delay for each unit.
4. This step is required if you have power supplies with **different** minimum delay offsets (see below). Specify a common delay offset for all of the sequenced units. The common delay offset must be larger or equal to the largest maximum delay offset. When the common delay offset completes, the user-programmed turn-on delays will start.

Connect and Configure the Digital Connector Pins

The digital connector pins of the sequenced units must be connected together and configured. Refer to **Output Couple Control** for more information.

Enable Output Sequencing

Output turn-on sequencing must be enabled on each unit that will participate in output turn-on synchronization.

Front Panel Menu Reference	SCPI Command
Select Output\Sequence\Couple .	To enable, send:
Check Enable to enable sequencing.	OUTP:COUP ON
Uncheck to disable.	To disable, send:
	OUTP:COUP OFF

Specify the Turn-On and Turn-Off Delays for each Unit

Turn-on delays can be specified for all coupled units. Any delay sequence can be implemented. There are no restrictions on what the sequence is or what unit comes up first.

Front Panel Menu Reference	SCPI Command
Select Output\Sequence\Couple .	Program a turn-on delay:
Specify the Turn-on delay in seconds.	OUTP:DEL:RISE .02
Repeat for each additional unit.	Repeat for each instrument.

Turn-off delays can also be specified for all coupled units. Any delay sequence can be implemented. There are no restrictions on what the sequence is or what unit turns off first.

Front Panel Menu Reference	SCPI Command
Select Output\Sequence\Delay .	Program a turn-off delay:
Specify the Turn-off delay in seconds.	OUTP:DEL:FALL .01
Repeat for each additional unit.	Repeat for each instrument.

Specify the Common Delay Offset

NOTE

There is no need to specify a common delay offset when outputs turn off. Outputs start executing their turn-off delays as soon as an Output Off command is received (and any user-programmed turn-off delay has expired).

Specifying a common delay offset lets you accurately synchronize the user-programmed turn-on delays when sequencing power supplies with different internal delay offsets.

In the following figure, you can see how the internal delay offsets are appended to the user-programmed delay times. The internal delay offsets vary based on priority mode, and whether an SD1000A unit is connected to the power supply.

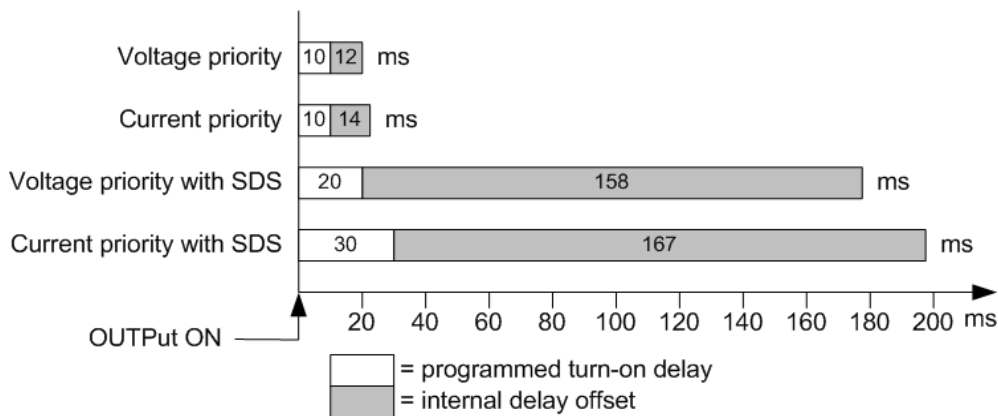

Although you cannot eliminate the internal delay offset times, you can specify a common delay offset to accurately synchronize the user-programmed turn on delays with each other. If in the above example you were to program a common delay offset of 170 ms, that common delay offset would then supersede the different internal delay times of the coupled units. The 170 ms common offset would in effect synchronize the internal delay of the coupled units.

4 Using the Regenerative Power System

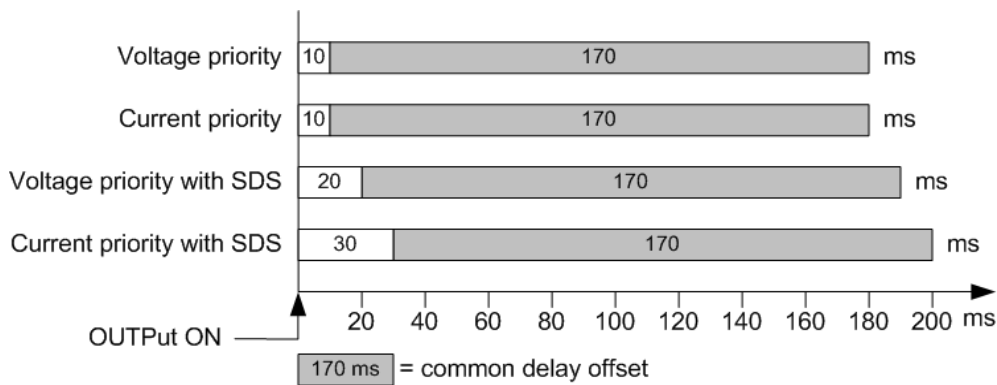

The common delay offset assures that the user-programmed turn-on delays will be synchronized to start at the completion of the common delay offset. Query the delay offset of each unit and use the slowest delay as the common delay offset.

Front Panel Menu Reference	SCPI Command
<p>Select Output\Sequence\Couple.</p> <p>The Max delay offset for this frame field displays the delay offset of the unit. Enter the delay offset value of the slowest unit in the Delay offset field in milliseconds. Then press Select.</p>	<p>To query the delay offset of the slowest unit: OUTP:COUP:MAX:DOFF?</p> <p>Use the delay offset of the slowest unit to specify the common delay offset OUTP:COUP:DOFF 0.170</p>

NOTE

To circumvent the additional relay turn-on times of the SD1000A, a non-volatile **OUTPut:RELAY:LOCK** command can be sent, after which the internal delay offset will match those of models without connected SD1000A units.

Output Turn-On Turn-Off Behavior

The turn-on and turn-off sequences are primarily controlled by three factors: the user-programmed turn-on/turn-off delays, the voltage and current priority mode settings, and the operation of the Keysight SD1000A unit (if installed).

The following table documents the output impedance setting for the turn-on and turn-off sequences. For models RP793xA and RP794xA only, you can specify either Low or High output impedance when operating in Voltage priority mode.

Output turn-on/turn-off impedance for	Voltage Priority	Current Priority
Models RP793xA; RP794xA	Impedance is user-selectable via OUTPut:TMODe command	High impedance turn-on High impedance turn-off
Models RP795xA; RP796xA	Low impedance turn-on High impedance turn-off	High impedance turn-on High impedance turn-off

The following flowcharts illustrate the output turn-on and output turn-off sequences followed by a description of the individual actions. Note that the sections under "With SD1000A" only apply when the Keysight SD1000A unit is installed.

Turn-On/Turn-Off - RP793xA and RP794xA

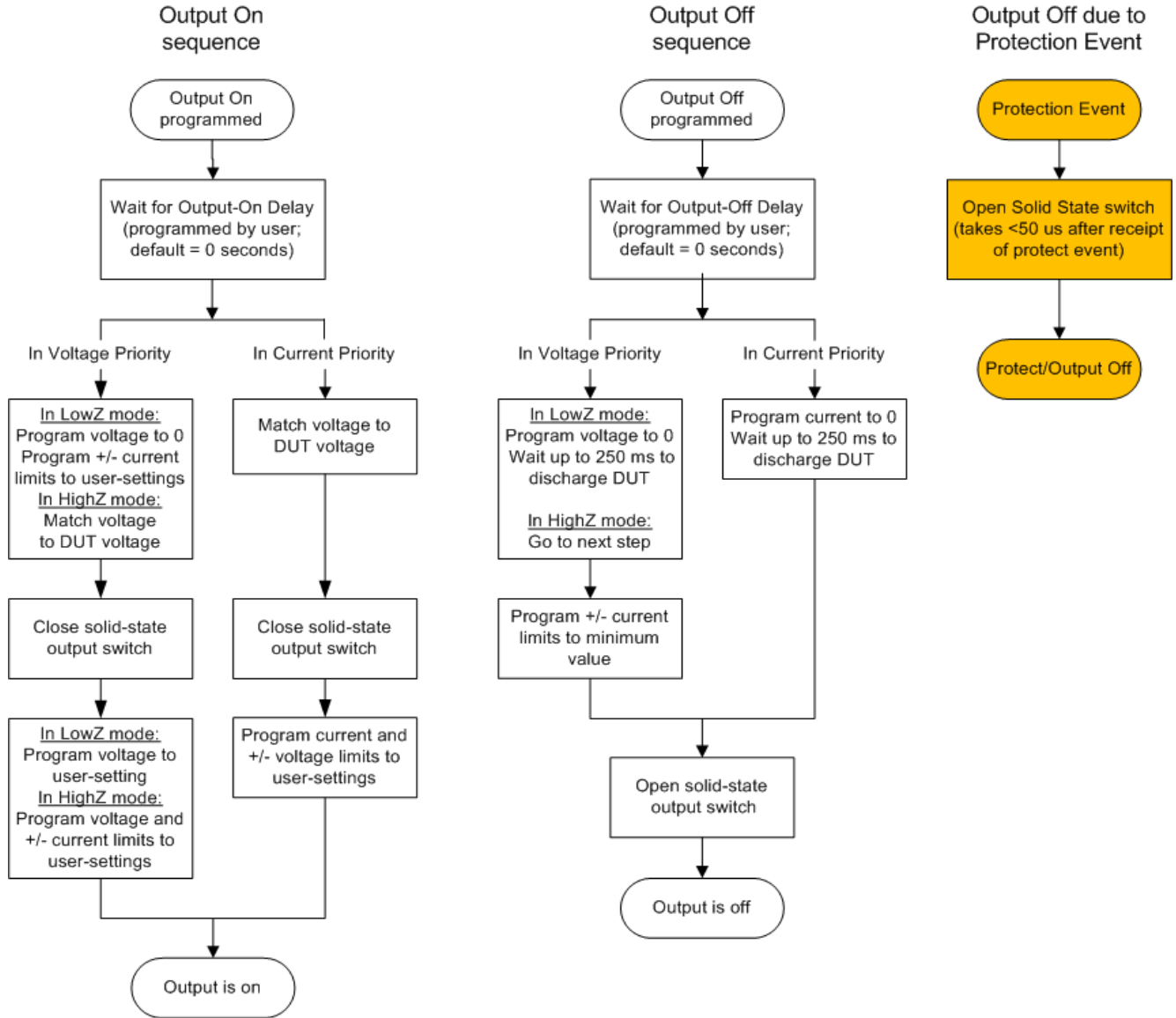

Turn-On/Turn-Off - RP795xA and RP796xA

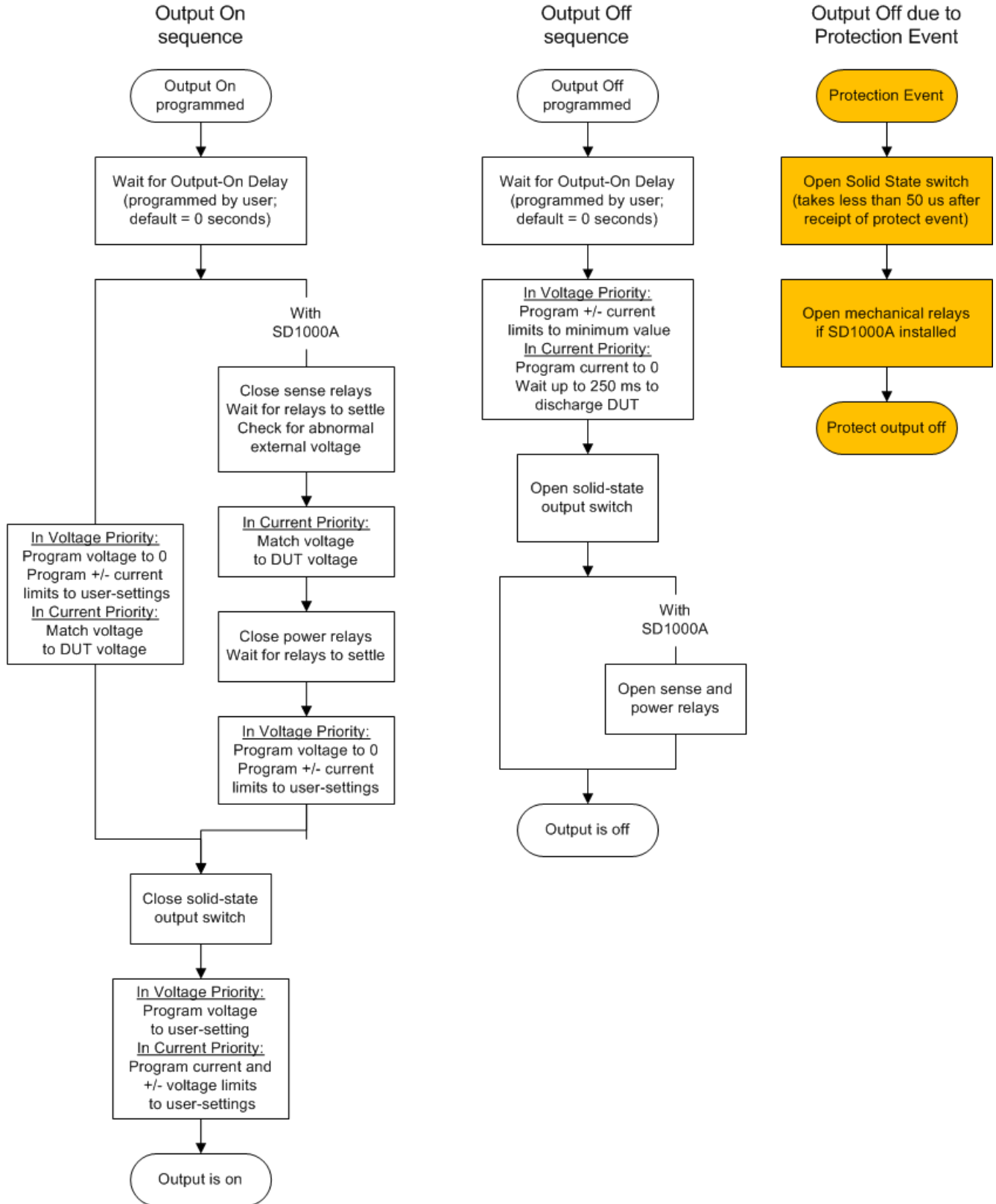

Output-On Sequence

Upon the receipt of an Output On command, the power supply waits for the duration of the user-programmed turn-on delay.

In voltage priority with LowZ, the power supply programs its internal circuits to a voltage of zero and sets the current limits to their user-programmed values. In voltage priority with HighZ, the power supply matches its voltage to the DUT voltage.

In current priority, the power supply also matches its voltage to the DUT voltage. This ensures that when a source such as a battery is connected to the output, that there is no current surge into the power supply from the DUT when the output is turned on.

If an SD1000A unit is connected, the unit's internal delay offset is significantly longer. This is due to the closure and settling times of the sense and power relays of the SDS. If an abnormal voltage is detected, the relays remain open and an error is generated.

The power supply's solid-state output switch is then closed, connecting the output to the internal power circuits. The output voltage and current are programmed to their user-settings. The output follows the slew rate setting.

Output-Off Sequence

Upon the receipt of an Output Off command, the power supply waits for the duration of the user-programmed turn-off delay.

In voltage priority with LowZ, the power supply programs the voltage to zero. It then waits up to 250 ms to discharge any current from the DUT. It then programs the current limits to their minimum settings. In voltage priority with HighZ, the power supply only programs the current limits to their minimum settings.

In current priority, the power supply programs the current to zero. It then waits up to 250 ms to discharge any current from the DUT.

The power supply's solid-state output switch is then opened, disconnecting the output from the internal power circuits. If an SD1000A unit is connected, its sense and power relays are also opened.

NOTE

If you wish to program a voltage turn-off slew rate, you must set the slew rate and program the output voltage to zero *before* you send the output off command.

Also, Models RP795xA and RP796xA use a 1 M Ω resistance, and the SD1000A uses a 25 k Ω resistance for Option 500 and a 97.5 k Ω resistance for Option 950 to downprogram any voltage from the DUT.

Output-Off Protection Sequence

The turn-off protection sequence differs from the normal turn-off sequence in that it turns off the output as fast as possible. When a protection event is detected, the power supply immediately opens the solid-state output switch. This typically takes less than 50 μ s following the initial detection.

If an SD1000A unit is connected, its output and sense relays are hot-switched open.

External Data Logging

Select the Measurement Function and Range

Specify the Integration Period

Select the Elog Trigger Source

Initiate and Trigger the Elog

Periodically Retrieve the Data

Terminate the Elog

External Data Logging

NOTE

The external data logging function can only be programmed using SCPI commands.

The Keysight RPS models have an "external" data logging function (Elog) that lets you continuously log voltage and current measurements. Data logging is external to the instrument because it can only be implemented using SCPI commands. Voltage and current measurement data is temporarily stored in a FIFO (first-in, first-out) buffer located in the instrument. However, this buffer is only large enough to hold about 20 seconds of accumulated measurements. This means that you must periodically empty the internal buffer to an external storage device; otherwise the data in the buffer will be overwritten.

The following table details the various data logging functions.

Function	Description
Data Storage	Buffers measurements for about 20 seconds and requires that the computer periodically reads measurements to prevent the internal buffer from overflowing. The computer needs to provide the external data storage.
Measurement Functions	Both output voltage and output current can be logged.
Integration Period	During the specified integration period, the samples are averaged, and min and max values are tracked.
Data viewing	No front panel view or control. Data is collected and viewed externally.

Note that the Elog function uses the **acquire trigger process** to make the measurements.

Select the Measurement Function and Range

The following commands select a measurement function:

Front Panel Menu Reference	SCPI Command
Not available	To enable voltage or current measurements: SENS:ELOG:FUNC:VOLT ON SENS:ELOG:FUNC:CURR ON
	To enable min/max measurements: SENS:ELOG:FUNC:VOLT:MINM ON SENS:ELOG:FUNC:CURR:MINM ON

Specify the Integration Period

The integration period can be set from a minimum of 102.4 microseconds to a maximum of 60 seconds.

Front Panel Menu Reference	SCPI Command
Not available	To set an integration period of 600 microseconds: SENS:ELOG:PER 0.0006

During the integration period, Elog samples are averaged, and the minimum and maximum values are tracked. At the end of each integration period the average, minimum, and maximum values are added to the internal FIFO buffer.

Although the absolute minimum integration period is 102.4 microseconds, the actual minimum depends on the number of measurements that are being logged. The formula is $102.4_microseconds \times \#_of_measurements$. For example:

- 102.4 microseconds:** 1 measurement (voltage or current)
- 204.8 microseconds:** 2 measurements (voltage and current)
- 409.6 microseconds:** 4 measurements (voltage+min+max+current)

If the specified integration period is at or near the minimum logging intervals, the data format must be specified as binary. If the REAL format is not specified, the data will be in ASCII format and the minimum logging intervals will typically be up to five times longer than what can be achieved with binary format.

Front Panel Menu Reference	SCPI Command
Not available	To set the data format to REAL: FORM[:DATA] REAL

Select the Elog Trigger Source

The TRIGger:ELOG command generates an immediate trigger regardless of the trigger source. Unless you are using this command, select a trigger source from the following:

4 Using the Regenerative Power System

Trigger Source	Description
Bus	Selects GPIB device trigger, *TRG, or <GET> (Group Execute Trigger).
External	Selects ANY pin that has been configured as a Trigger Input on the digital control port.
Immediate	Triggers the transient as soon as it is INITiated.
Pin<1-7>	Selects a specific pin<n> that is configured as a Trigger Input on the digital control port.

Use the following commands to select one of the available trigger sources:

Front Panel Menu Reference	SCPI Command
Not available	To select Bus triggers: TRIG:ELOG:SOUR BUS
	To select digital pin 5 as the trigger: TRIG:ELOG:SOUR PIN5

Initiate and Trigger the Elog

When the power supply is turned on, the trigger system is in the Idle state. In this state, the trigger system is disabled, ignoring all triggers. The INITiate command enables the measurement system to receive triggers. To initiate and trigger the Elog:

Front Panel Menu Reference	SCPI Command
Not available	To initiate the Elog: INIT:ELOG
	To trigger the Elog: TRIG:ELOG
	Alternatively, if the trigger source is BUS, you can also program a *TRG or an IEEE-488 <get> command.

When triggered, the Elog starts placing data in the internal measurement buffer. Because the buffer is only large enough to hold 20 seconds of accumulated measurement your PC application must periodically retrieve (or fetch) the data from this buffer.

Periodically Retrieve the Data

Each FETCh command returns number of requested records of the data in the buffer and removes them, making room available for more data. The Elog continues until it is aborted.

An Elog record is one set of voltage and current readings for one time interval. The exact format of a record depends on which functions have been enabled for Elog sensing. If all functions are enabled, then one record will contain the following data in the specified order:

- Current average
- Current minimum
- Current maximum
- Voltage average
- Voltage minimum
- Voltage maximum

Front Panel Menu Reference	SCPI Command
Not available	To retrieve a maximum of 1000 records: FETC:ELOG? 1000

ASCII data (the default format) is returned as comma-separated ASCII numeric data sets of average/min/max values terminated by a newline. REAL data is returned as a definite length block, with the byte order specified by the FORMat:BORDER command.

Terminate the Elog

Front Panel Menu Reference	SCPI Command
Not available	To abort the Elog: ABOR:ELOG

Making Measurements

Average Measurements

Measurement Sweep

Measurement Windowing

A-hour & W-hour measurement

Digitized Measurements

Measurement Triggering

Average Measurements

The Keysight RPS models have a fully integrated voltmeter and ammeter to measure the actual voltage and current that is being supplied to the load.

Whenever the power supply is on, the front panel automatically measures output voltage and current by acquiring a number of measurements over the specified number of power line cycles, and averaging the samples. The default number of power line cycles is 1 cycle. At 1 cycle, the number of samples (or points) is 3255 @60 Hz and 3906 @50 Hz. The default sample interval is 5.12 microseconds.

Use the following commands to make a measurement:

Front Panel Menu Reference	SCPI Command
Select the Meter key.	To measure average (DC) output voltage, current, or power:
Repeatedly press the key to cycle through the following measurement functions:	MEAS:VOLT?
Voltage, Current	MEAS:CURR?
Voltage, Power	MEAS:POW?
Voltage, Current, Power	To return measurement data from the previously acquired array:
If dashes are displayed, the front panel measurement is interrupted because a remote interface measurement is taking place.	FETC:VOLT?
	FETC:CURR?
	FETC:POW?

Measurement Sweep

You can set the measurement time in number of power line cycles (NPLC). Using an integer number of power line cycles can reduce measurement noise from line frequency sources.

Front Panel Menu Reference	SCPI Command
Select Measure\Sweep	To set the number of power line cycles to 10:
Enter the number of power line cycles in the NPLC field.	SENS:SWE:NPLC 10
Then press Select .	

NOTE

The AC line frequency is detected automatically for the SENSE:SWEep:NPLC command.

Measurement Windowing

Windowing is a signal conditioning process that reduces the error in average measurements made in the presence of periodic signals and noise. Two window functions are available: Rectangular and Hanning. At power-on, the measurement window is Rectangular.

The Rectangular window calculates average measurements without any signal conditioning. However, in the presence of periodic signals such as AC line ripple, a Rectangular window can introduce errors when calculating average measurements. This can occur when a non-integral number of cycles of data has been acquired due to the last partial cycle of acquired data.

One way of dealing with AC line ripple is to use a Hanning window. The Hanning window applies a \cos^4 weighting function to the data when calculating average measurements. This attenuates the AC noise in the measurement window. The best attenuation is achieved when at least three or more waveform cycles are in the measurement.

Front Panel Menu Reference	SCPI Command
Select Measure\Window . Select either Rectangular or Hanning. Then press Select .	To set the sense window to Hanning: SENS:WIND HANN

A-hour & W-hour measurement

Amp-hour and watt-hour measurements are available on all RPS models. These measurements are made independently of other measurements.

The amp-hour and watt-hour measurements are created by accumulating full range current and power measurements at approximately 200k samples/second. The accumulators can hold enough data for at least 100,000 hours.

The approximate limit of accumulated charge is $\pm(900,000,000 \cdot I_{\text{RATING}})$ in Coulombs or $\pm(250,000 \cdot I_{\text{RATING}})$ in Amp-hours.

The approximate limit of accumulated energy is $\pm(1,100,000,000 \cdot P_{\text{RATING}})$ in Joules or $\pm(310,000 \cdot P_{\text{RATING}})$ in Watt-hours.

I_{RATING} is the current rating of the unit. P_{RATING} is the power rating of the unit.

To return Amp-hours and Watt-hours measurements:

Front Panel Menu Reference	SCPI Command
Select Measure\AHWH . Displays the accumulated Amp-hours and Watt-hours.	To return the Amp-hours and Watt hours: FETC:AHO? FETC:WHO?

4 Using the Regenerative Power System

To reset the Amp-hours and Watt-hours measurements:

Front Panel Menu Reference	SCPI Command
Select Measure\AHWH .	To reset Amp-hours and Watt-hours:
Select Reset to return the measurements to zero.	SENS:AHO:RES SENS:WHO:RES

Digitized Measurements

In addition to the average voltage, current, and power measurements, which are available from both the front panel and via SCPI commands, digitized measurements can also be returned. Digitized measurements differ from average measurements because you can select the type of measurement returned and fine tune the measurement quality.

Measurement Types

The following digitized measurements are available. These can only be measured using the corresponding SCPI command.

ACDC is a calculation that returns the total RMS measurement (AC + DC).

HIGH level is a calculation that generates a histogram of the waveform using 16 bins between the maximum and minimum data points. The bin containing the most data points above the 50% point is the high bin. The average of all the data points in the high bin is returned as the High level. If no high bin contains more than 1.25% of the total number of acquired points, then the maximum data point is returned.

LOW level is a calculation that generates a histogram of the waveform using 16 bins between the maximum and minimum data points. The bin containing the most data points below the 50% point is the low bin. The average of all the data points in the low bin is returned as the Low level. If no low bin contains more than 1.25% of the total number of acquired points, then the minimum data point is returned.

MAX is the maximum value of the digitized measurement.

MIN is the minimum value of the digitized measurement.

Array queries are also available to return ALL values in the voltage and current measurement buffer. No averaging is applied, only raw data is returned from the buffer.

Front Panel Menu Reference	SCPI Command
Not available	To measure RMS voltage & current: MEAS:VOLT:ACDC? MEAS:CURR:ACDC?
	To measure the high level of a pulse: MEAS:VOLT:HIGH? MEAS:CURR:HIGH?
	To measure the low level of a pulse: MEAS:VOLT:LOW? MEAS:CURR:LOW?
	To measure the maximum value: MEAS:VOLT:MAX? MEAS:CURR:MAX?
	To measure the minimum value: MEAS:VOLT:MIN? MEAS:CURR:MIN?
	To take a measurement and return array data: MEAS:ARR:VOLT? MEAS:ARR:CURR? MEAS:ARR:POW?

Measurement Quality

The following figure illustrates the relationship between measurement samples (or points), and the time interval between samples in a typical measurement. You can fine tune the measurement by specifying the number of points in the measurement acquisition as well as the time interval between points.

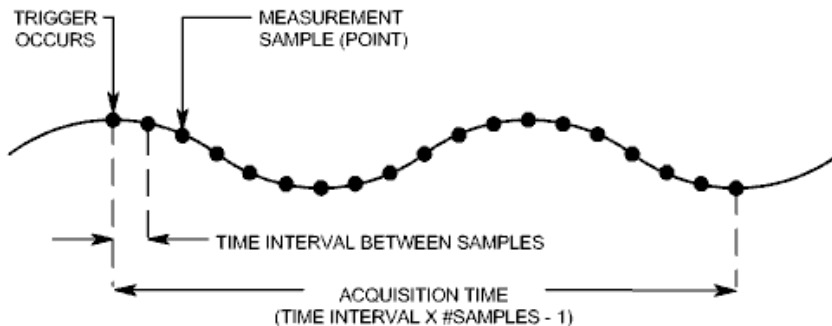

You can configure the measurement acquisition as follows:

Front Panel Menu Reference	SCPI Command
Select Measure\Sweep .	To set the time interval to 60μs with 4096 samples:
Enter the number of points. Then press Select .	SENS:SWE:TINT 60E-6
Enter the time interval. Then press Select .	SENS:SWE:POIN 4096

The maximum number of sample points that are available for all measurements is 512 K points (K = 1024).

4 Using the Regenerative Power System

Time interval values can range from 5.12 microseconds to 40,000 seconds for both voltage and current measurements. Values above 5.12 microseconds are rounded to the nearest 5.12 microsecond increment. Values above 10.24 microseconds are rounded to the nearest 10.24 microsecond increment. Values above 20.48 microseconds are rounded to the nearest 20.48 microsecond increment.

Note that Keysight RP7900 models also support the **NPLC** (number of power line cycles) command to configure measurement tint and points as previously discussed. The NPLC command automatically increases the number of points to maintain the shortest possible time interval. If the maximum number of points for that time interval is reached, it increases the time interval.

Measurement Triggering

- Capture pre-trigger data, if desired
- Select the trigger source
- Initiate the acquisition system
- Trigger the measurement
- Fetch the measurement
- Multiple trigger events per measurement

Use the acquisition trigger system to synchronize the digitized measurements with a trigger signal from a number of trigger sources. Then use FETCh commands to return voltage or current information from the acquired data.

The following figure illustrates the measurement acquisition process. This process applies to both measurement triggers and external data logging. For an overview of the trigger system, refer to **Trigger Overview**.

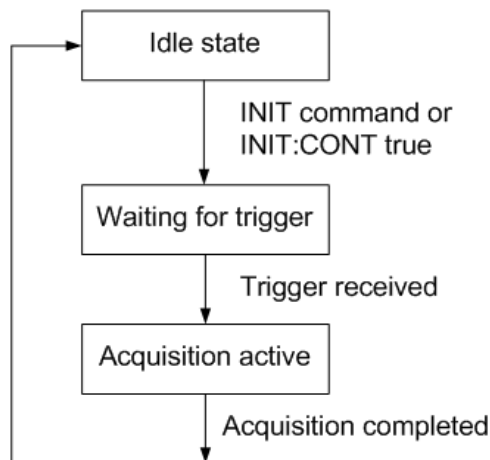

Capture pre-trigger data, if desired

The measurement system lets you capture data before, after, or at the trigger signal. As shown in the following figure, you can move the block of data being read into the acquisition buffer with reference to the trigger. This allows pre- or post-trigger data sampling.

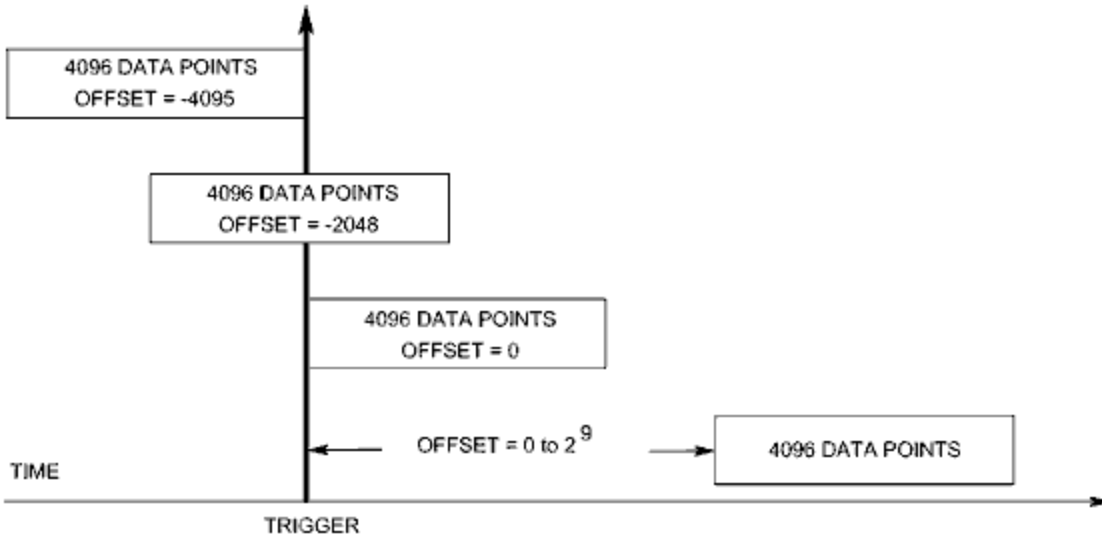

To offset the beginning of the acquisition buffer relative to the acquisition trigger:

Front Panel Menu Reference	SCPI Command
Select Measure\Sweep . Enter an Offset value. Then press Select .	To offset the measurement by 100 points: SENS:SWE:OFFS:POIN 100

When the value is 0, all measurement samples are taken after the trigger. Positive values represent the delay after the trigger occurs but before the samples are acquired. This can be used to exclude measurement samples that occur during the delay time. (Delay time = offset x sample period). Negative values represent data samples taken prior to the trigger. This lets you acquire measurement samples prior to the trigger.

Select the trigger source

NOTE

A TRIGger:ACQuire[:IMMediate] command over the bus will always generate an immediate measurement trigger, regardless of the selected trigger source.

Unless you are using TRIGger:ACQuire[:IMMediate], select a trigger source from the following:

4 Using the Regenerative Power System

Trigger Source	Description
Bus	Selects GPIB device trigger, *TRG, or <GET> (Group Execute Trigger).
Current	Selects an output current level.
External	Selects ANY pin that has been configured as a Trigger Input on the digital control port.
Pin<1-7>	Selects a specific pin<n> that is configured as a Trigger Input on the digital control port.
Transient	Selects the unit's transient system. You must also set up the transient system to generate a trigger out signal. See Programming Output Transients .
Voltage	Selects an output voltage level.

Use the following commands to select a trigger source:

Front Panel Menu Reference	SCPI Command
Not available	To select Bus triggers: TRIG:TRAN:SOUR BUS
	To select digital pin 5 as the trigger: TRIG:ACQ:SOUR PIN5
	To select a voltage or current level: TRIG:ACQ:SOUR VOLT TRIG:ACQ:SOUR CURR
	To select an output transient as trigger: TRIG:ACQ:SOUR TRAN

Initiate the acquisition system

When the unit is turned on, the trigger system is in the idle state. In this state, the trigger system is disabled, ignoring all triggers. The INITiate commands enable the trigger system to receive triggers.

Front Panel Menu Reference	SCPI Command
Not available	To initiate the measurement trigger system: INIT:ACQ

It takes a few milliseconds for the instrument to be ready to receive a trigger signal after receiving the INITiate:ACQuire command. If a trigger occurs before the trigger system is ready for it, the trigger will be ignored. You can test the WTG_meas bit in the operation status register to know when the instrument is ready to receive a trigger after being initiated.

Front Panel Menu Reference	SCPI Command
Select Measure\Control . The Trig state field indicates "Initiated".	To query the WTG_meas bit (bit 3): STAT:OPER:COND?

If bit 3 is set in the query response, the WTG_meas bit is true, and the instrument is ready to receive the trigger signal. Refer to [Status Tutorial](#) for more information.

NOTE

The instrument executes one measurement acquisition each time a bus, pin, transient, or level trigger command is received. Thus, it will be necessary to initiate the trigger system each time a triggered measurement is desired.

Trigger the Measurement

The trigger system is waiting for a trigger signal in the initiated state. You can immediately trigger the measurement as follows:

Front Panel Menu Reference	SCPI Command
Not available	<p>To generate a measurement trigger: TRIG:ACQ</p> <p>Alternatively, if the trigger source is BUS, you can also program a *TRG or an IEEE-488 <get> command.</p>

As previously discussed, a trigger can also be generated by a digital pin, an output transient, and an output voltage or current level. If a digital pin is configured as the trigger source, the instrument will wait indefinitely for the trigger signal. If the trigger does not occur, you must manually return the trigger system to the idle state. The following commands return the trigger system to the idle state:

Front Panel Menu Reference	SCPI Command
Select Measure\Control . Then select the Abort control.	ABOR:ACQ

Fetch the measurement

After a trigger is received and the measurement completes, the trigger system will return to the idle state.

Once the measurement completes, FETCh queries can retrieve the most recent measurement data without initiating a new measurement or altering the data in the measurement buffer.

Front Panel Menu Reference	SCPI Command
Not available	<p>To return RMS voltage & current: FETC:VOLT:ACDC? FETC:CURR:ACDC?</p> <p>To return the high level of a pulse: FETC:VOLT:HIGH? FETC:CURR:HIGH?</p> <p>To return the low level of a pulse: FETC:VOLT:LOW? FETC:CURR:LOW?</p> <p>To return the maximum value: FETC:VOLT:MAX? FETC:CURR:MAX?</p> <p>To return the minimum value: FETC:VOLT:MIN? FETC:CURR:MIN?</p> <p>To return array data: FETC:ARR:VOLT? FETC:ARR:CURR? FETC:ARR:POW?</p>

If a FETCh query is sent before the measurement is finished, the response will be delayed until the measurement trigger occurs and the acquisition completes. You can test the MEAS_active bit in the operation status register to know when the measurement trigger system has returned to the idle state.

Front Panel Menu Reference	SCPI Command
<p>Select Measure\Control.</p> <p>The Trig state field indicates "Idle".</p>	<p>To query the MEAS_active bit (bit 5): STAT:OPER:COND?</p>

If bit 5 is set in the query response, the MEAS_active bit is true, and the measurement is NOT complete. When the MEAS_active bit is false, you can retrieve the measurement. Refer to [Status Tutorial](#) for more information.

Multiple trigger events per measurement

The Keysight RPS models can capture other triggers that occur during the acquisition, return the number and position of those triggers, and calculate DC values based on a subset of the data surrounding those triggers. The basic concept is that a single long acquisition may contain several events of interest, and that these events are marked by locations where additional triggers occurred. The locations of these events are described as an index into the acquisition's store of acquired data. Indices range from 0 to 1 less than the number of acquired readings (see [SENse:SWEp:POINTs](#)).

You can query and return the indices where additional triggers occurred during the measurement. The number of indices returned matches the number of triggers that occurred.

Front Panel Menu Reference	SCPI Command
Not available	To query how many (if any) additional triggers occurred: TRIG:ACQ:IND:COUN?
	To return the indices where the triggers occurred: TRIG:ACQ:IND?

You can also return the actual measurement data that was captured after any of the aforementioned trigger indices.

Front Panel Menu Reference	SCPI Command
Not available	To return DC voltage or current calculated after the trigger indices: FETC:VOLT? [<start_index>, <points>] FETC:CURR? [<start_index>, <points>]
	To return instantaneous voltage or current data after the trigger indices: FETC:ARR:VOLT? [<start_index>, <points>] FETC:ARR:CURR? [<start_index>, <points>]

Programming the Digital Port

Bi-Directional Digital I/O

Digital Input only

External Trigger I/O

Fault Output

Inhibit Input

Fault/Inhibit System Protection

Output Couple

Digital Control Port

A Digital Control Port consisting of seven I/O pins is provided to access various control functions. Each pin is user-configurable. The following control functions are available for the I/O pins. See [SCPI Programming Reference](#) for details on the SCPI commands to program the Digital Port.

The following table describes the possible pin configuration for the digital port functions. For a complete description of the electrical characteristics of the digital control port, refer to the [Specifications](#) section.

Function	Description
DIO	General-purpose ground-referenced digital input/output function. The output can be set with [SOURCE:]DIGit-al:OUTPut:DATA .
DINPut	Digital input-only mode. The digital output data of the pin is ignored.
FAULt	Applies only to pin 1. Pin 1 functions as an isolated fault output. The fault signal is true when any output is in a protected state. Pin 2 serves as the isolated common for pin 1. When pin 1 is set to the FAULt function, the instrument ignores any commands to program pin 2. Queries of pin 2 will return FAULt. If pin 1 is changed from FAULt to another function, pin 2 is set to DINPut.
INHibit	Applies only to pin 3. When pin 3 is configured as an inhibit input; a true signal at the pin will disable the output.
ONCOuple	Applies only to pins 4-7. The ONCOuple pin synchronizes the output On state between instruments. Only one pin can be configured as an ONCOuple. The pin functions as both an input and an output.
OFFCOuple	Applies only to pins 4-7. The OFFCOuple pin synchronizes the output Off state between instruments. Only one pin can be configured as an OFFCOuple. The pin functions as both an input and an output.
TINPut	A trigger input pin can be selected as the source for measurement and transient trigger signals. See TRIGger:ACQuire:SOURce and TRIGger:TRANsient:SOURce
TOUTput	A trigger output pin will generate output triggers from any subsystem that has been configured to output trigger signals.
Common	Applies only to pin 8. Connected to ground.

In addition to the configurable pin functions, the signal polarity (Positive or Negative) for each pin is also configurable. For level signals, POSitive indicates a voltage high at the pin. NEGative indicates a voltage low at the pin. For edge signals, POSitive means a rising edge and NEGative means a falling edge.

Bi-Directional Digital I/O

Each of the seven pins can be configured as general purpose bi-directional digital inputs and outputs. The polarity of the pins can also be configured. Pin 8 is the signal common for the digital I/O pins. Data is programmed according to the following bit assignments:

Pin	7	6	5	4	3	2	1
Bit Weight	6 (MSB)	5	4	3	2	1	0 (LSB)

The digital I/O pin can be used to control both relay circuits as well as digital interface circuits. The following figure illustrates typical relay circuits as well as digital interface circuit connections using the digital I/O functions

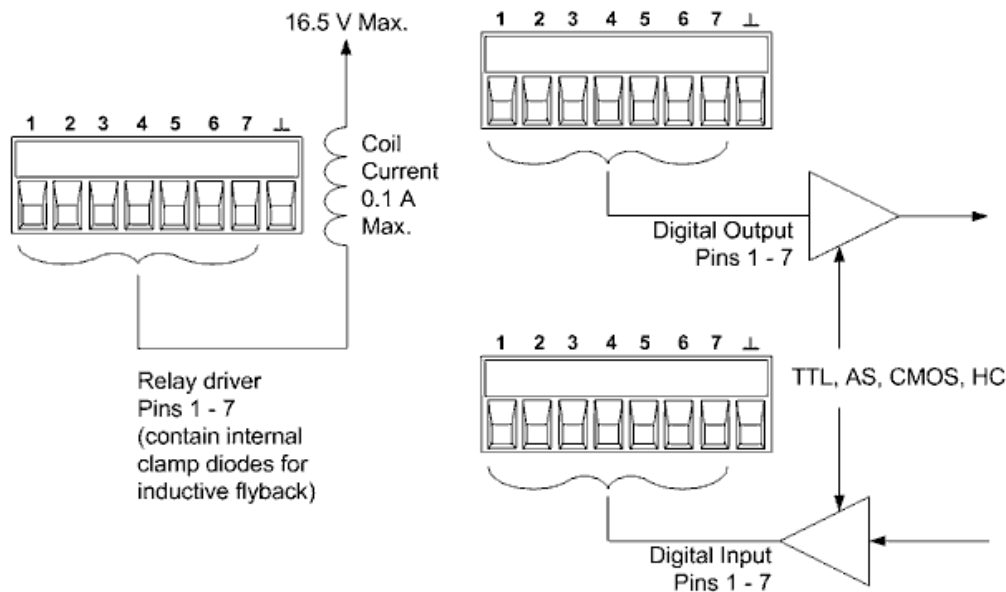

To configure the pins for digital I/O:

Front Panel Menu Reference	SCPI Command
Select System\IO\DigPort\Pins .	To select the pin function: DIG:PIN<1-7>:FUNC DIO
Select a pin in the Pin field.	
In the Function field, select Dig IO.	To select the pin polarity: DIG:PIN<1-7>:POL POS
In the Polarity field, select either Positive or Negative.	
To send data to the pins, select System\IO\DigPort\Data .	To configure pins 1 through 7 as "0000111": DIG:OUTP:DATA 7
Select the Data Out field and enter the binary word.	

Digital Input

Each of the seven pins can be configured as digital input only. The polarity of the pins can also be configured. Pin 8 is the signal common for the digital input pins. The pin status reflects the true condition of the external signal that is applied to the pin. The pin state is not affected by the setting of DIGital:OUTPut:DATA. To configure the pins for digital input only:

Front Panel Menu Reference	SCPI Command
Select System\IO\DigPort\Pins . Select a pin in the Pin field.	To select the pin function: DIG:PIN<1-7>:FUNC DINP
In the Function field, select Dig In . In the Polarity field, select either Positive or Negative.	To select the pin polarity: DIG:PIN<1-7>:POL POS
To read the data from the pins, select System\IO\DigPort\Data . The input data is displayed as a binary number in the Data In field.	To read the data on the pins: DIG:INP:DATA?

External Trigger I/O

Each of the seven pins can be configured as trigger inputs or trigger outputs. The polarity of the pins can also be configured. When you program trigger polarity, POSitive means a rising edge and NEGative means a falling edge. Pin 8 is the signal common for the trigger pins. For an overview of the trigger system, refer to [Trigger Overview](#).

When configured as a trigger input, you can apply either a negative-going or a positive-going pulse to the designated trigger input pin. The trigger latency is 5 microseconds. The minimum pulse width is 4 microseconds for positive-going signals, and 10 microseconds for negative-going signals. The pin's polarity setting determines which edge generates a trigger-in event.

When configured as a trigger output, the designated trigger pin will generate a 10 microsecond-wide pulse when a Trigger Out occurs. Depending on the polarity setting, it can be either positive-going (rising edge) or negative-going (falling-edge) when referenced to common.

Front Panel Menu Reference	SCPI Command
Select System\IO\DigPort\Pins . Select a pin in the Pin field.	To select the trigger output function for pin 1: DIG:PIN1:FUNC TOUT
In the Function field, select either the Trig In or Trig Out function. In the Polarity field, select either Positive or Negative.	To select the trigger input function for pin 2: DIG:PIN2:FUNC TINP To select the pin polarity: DIG:PIN1:POL POS DIG:PIN2:POL POS

Fault Output

Pins 1 and 2 can be configured as a fault-output pair. The Fault Output function enables a fault condition to generate a protection fault signal on the digital port. Refer to **Programming Output Protection** for a list of protection signals.

Both pins 1 and 2 are dedicated to this function. Pin 1 is the Fault output; pin 2 is the common for pin 1. This provides for an optically-isolated output. The polarity of pin 1 can also be configured. When the pin polarity is POSitive, a fault condition causes the isolated output to conduct. Note that the Fault output signal remains latched until the fault condition is removed and the protection circuit is cleared. as explained under **Clear Output Protection**.

NOTE

Pin 2's selected function is ignored. Pin 2 should be connected to the ground of the external circuit.

Front Panel Menu Reference	SCPI Command
Select System\IO\DigPort\Pins .	To configure the Fault function:
Select pin 1, then Function, then Fault Out.	DIG:PIN1:FUNC FAUL
In the Polarity field, select either Positive or Negative.	To select the pin polarity:
	DIG:PIN1:POL POS

Inhibit Input

Pin 3 can be configured as a remote inhibit input. The Inhibit Input function lets an external input signal control the output state of instrument. The input is level triggered. The signal latency is 5 microseconds. Pin 8 is the common for pin 3. The following non-volatile inhibit input modes can be programmed:

LATChing - causes a logic-true transition on the Inhibit input to disable the output. The output will remain disabled after the inhibit signal is received.

LIVE - allows the enabled output to follow the state of the Inhibit input. When the Inhibit input is true, the output is disabled. When the Inhibit input is false, the output is re-enabled.

OFF - The Inhibit input is ignored.

To configure the Inhibit Input function:

Front Panel Menu Reference	SCPI Command
Select System\IO\DigPort\Pins .	To select the Inhibit function: DIG:PIN3:FUNC INH
Select pin 3, then Function, then Inhibit In.	
In the Polarity field, select either Positive or Negative.	To select the pin polarity: DIG:PIN3:POL POS
Select Protect\Inhibit .	
Select either Latching or Live.	To specify the Inhibit mode: OUTP:INH:MODE LATC OUTP:INH:MODE LIVE OUTP:INH:MODE OFF
To disable the Inhibit signal, select Off.	

Fault/Inhibit System Protection

As shown in the following figure, when the Fault outputs and Inhibit inputs of several instruments are daisy-chained, an internal fault condition in one of the units will disable all outputs without intervention by either the controller or external circuitry. Note that when using the Fault/Inhibit signals in this manner, both signals must be set to the same polarity.

Also, as shown in the figure, you can also connect the Inhibit input to a manual switch or external control signal that will short the Inhibit pin to common whenever it is necessary to disable all outputs. **Negative** polarity must be programmed for all pins in this case. You can also use the Fault output to drive an external relay circuit or signal other devices whenever a protection fault occurs.

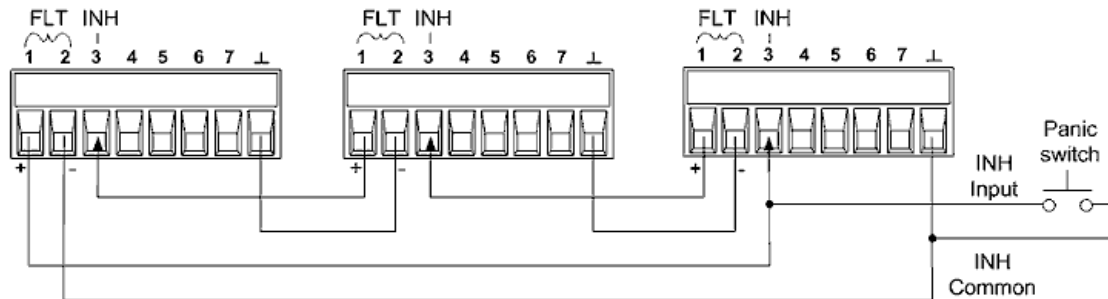

Clearing a System Protection Fault

To restore all instruments to a normal operating condition when a fault condition occurs in a daisy-chained system protection configuration, two fault conditions must be removed:

1. The initial protection fault or external Inhibit signal.
2. The subsequent daisy-chained fault signal (which is sourced by the Inhibit signal).

NOTE

Even when the initial fault condition or external signal is removed, the fault signal is still active and will continue to shut down the outputs of all the units.

To clear the daisy-chained fault signal if the operating mode of the Inhibit input is Live, simply clear the output protection on any ONE unit as explained under **Clearing Protection Functions**. If the operating mode of the Inhibit input is Latched, turn off the Inhibit input on ALL units individually. To re-enable the chain, re-program the Inhibit input on each unit to Latched mode.

Output Couple Control

This function lets you connect multiple instruments together and synchronize the output on/off sequence across all units. Each unit that will be sequenced must also be "coupled" to the other units.

1. Couple the output on each unit as described under [Sequencing the Output](#).
2. Set the delay offset of each individual unit to match the longest delay offset of the group.
3. Connect and configure the digital connector pins of the sequenced units as shown below.

Only pins 4 through 7 can be configured as "coupled" pins. The designated pins will function as both an input and an output, with a negative transition on one pin providing the sequence signal to the other pins. The polarity of the pins is not programmable; it is set to NEGative.

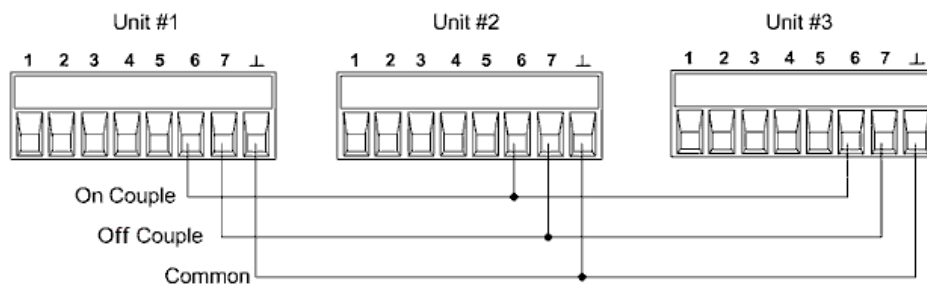

In this example, pin 6 is configured as the output On control. Pin 7 is configured as the output Off control. The ground or Common pins are connected together.

Front Panel Menu Reference	SCPI Command
Select System\IO\DigPort\Pins .	To set pin 6 of unit 1 as the ON control:
Select pin 6, then Function, then On Couple.	DIG:PIN6:FUNC ONC
Select Pins. , select pin7, then Function, then Off Couple.	To configure pin 7 of unit 1 as the OFF control:
Repeat these steps for units #2 and #3	DIG:PIN7:FUNC OFFC
	Repeat commands for units 2 and 3.

Once configured and enabled, turning the output on or off on any coupled unit will cause all coupled units to turn on or off according to their user-programmed delays.

System-Related Operations

Though not directly related to output programming, the following functions also control instrument operation.

Instrument Identification

Instrument State Storage

Front Panel Display

Front Panel Lock-Out

Password Protection

Instrument Identification

You can query the model number, serial number, options, and firmware revision. SCPI commands return information with the *IDN? and *OPT? queries.

Front Panel Menu Reference	SCPI Command
Select System\About\Frame .	To return manufacturer, model number, serial number, and firmware revision: *IDN? To return the installed options: *OPT?

Instrument State Storage

The power supply has ten storage locations in non-volatile memory to store instrument states. The locations are numbered 0 through 9. Any state previously stored in the same location will be overwritten.

Front Panel Menu Reference	SCPI Command
Select States\SaveRecall . In the SaveRecall field, enter a location from 0 to 9. Then press Select . Select Save to save the state to Recall to recall a state.	To save a state in location 1: *SAV 1 To recall a state from location 1: *RCL 1

Specifying a power-on state

When shipped, the power supply is configured to automatically recall the reset (*RST) settings at power-on. However, you can configure the power supply to use the settings you have stored in memory location 0 at power-on.

Front Panel Menu Reference	SCPI Command
Select States\PowerOn . Select Recall State 0 . Then press Select .	OUTP:PON:STAT RCL0

Front Panel Display

The power supply has a front panel screen saver that significantly increases the life of the LCD display by dimming it during periods of inactivity. The delay can be set from 30 to 999 minutes in 1 minute increments. As shipped, the screen saver comes on one hour after activity on the front panel or interface has ceased.

When the screen saver is active, the front panel display dims, and the LED next to the Line switch turns from green to amber. To restore the front panel display, simply press one of the front panel keys. The first action of the key turns the brightness up. Subsequently, the key will revert to its normal function.

If the Wake on I/O function is selected, the display is restored whenever there is activity on the remote interface. This also resets the timer on the screen saver. As shipped, Wake on I/O is active.

Front Panel Menu Reference	SCPI Command
Select System\Preferences\Display\Saver Enable or disable the screen saver by checking or unchecking the Screen Saver checkbox. Then press Select . Enter a value in minutes in the Saver Delay field to specify the time when the screen saver will activate. Check Wake on I/O to activate the display with I/O bus activity.	To turn the front panel screen saver on or off: DISP:SAV ON OFF

Specifying the power-on view

Note that you can specify which measurement functions are displayed at turn-on.

Front Panel Menu Reference	SCPI Command
Select System\Preferences\Display\View . From the dropdown menu select: Voltage,Current; Voltage,Power; or Volt,Curr,Power. Then press Select .	To select a turn-on meter view: DISP:VIEW METER_VI DISP:VIEW METER_VP DISP:VIEW METER_VIP

Front Panel Lock-Out

You can lock the front panel keys to prevent unwanted control of the instrument from the front panel. This is the most secure way of locking the front panel keys because you need a password to unlock the front panel. This parameter is saved in non-volatile memory. Therefore, the front panel remains locked even after AC power is cycled.

Front Panel Menu Reference	SCPI Command
Select System\Preferences\Lock In the dialog box, enter the password to unlock the front panel. Then select Lock.	Not available

4 Using the Regenerative Power System

The menu to unlock the front panel appears every time a key is pressed. Enter the password to unlock the front panel.

NOTE

If the password is lost, the **SYSTem:PASSword:FPANel:RESet** command can reset the front panel lockout password. Refer to **Calibration Switches** for more information.

The **SYSTem:COMMunicate:RLState RWLock** command can also lock and unlock the front panel. This command is completely independent of the front panel lockout function. If you use this command to lock the front panel, the front panel will be unlocked when AC power is cycled.

Password Protection

You can password-protect all functions located in the Admin menu. These include: instrument calibration, interface access, non-volatile memory reset, firmware update, password updates.

As shipped, the Admin menu password is 0 (zero). This means that you do not have to enter a password to access the Admin menu. Simply select **System\Admin>Login** and press Enter. To password-protect the Admin menu:

Front Panel Menu Reference	SCPI Command
Select System\Admin>Password	Enter calibration mode using the original password CAL:STAT ON, <password>
Enter a numeric password, up to 15 digits long. Then press Select.	To change the password: CAL:PASS <password>
Log out of the Admin menu to activate the password. You can now only enter the Admin menu by providing the correct password in the Password field.	To exit calibration mode and activate the password: CAL:STAT OFF

If the password is lost, access can be restored by setting an internal switch to reset the password to 0. If the message “Locked out by internal switch setting” or “Calibration is inhibited by switch setting” appears, the internal switch is set to prevent the password from being changed. Refer to **Calibration Switches** for more information.

Clock Setup

The real-time clock is used to provide time stamp information for the Keysight 14585A Control and Analysis Software, which is its only function. When shipped, the real-time clock is set to Greenwich mean time. To set the clock:

Front Panel Menu Reference	SCPI Command
Select System\Preferences\Display\Clock .	To set the date: SYSTem:DATE 2018,06,30
Enter the date in the Month, Day and Year fields. Enter the time in the Hour, Minute, and Second fields. Press Select to set the date and time.	To set the time: SYSTem:TIME 20,30,0

Priority Mode Tutorial

Voltage Priority

Current Priority

Voltage Priority

In voltage priority mode, the output is controlled by a constant-voltage feedback loop, which maintains the output voltage at its programmed setting as long as the load current remains within the positive or negative current limit settings. Voltage priority mode is best suited for use with resistive or high impedance loads, and loads that are sensitive to voltage overshoots. Do not use voltage priority mode with low-impedance sources such as batteries, power supplies, or large charged capacitors.

In voltage priority mode, the output voltage should be programmed to the desired value. A positive and negative current limit value should also be set. The current limit should always be set to a value that is greater than the actual output current requirement of the external load. The following figure shows the voltage priority operating locus of the output. The area in the white quadrants shows the output as a source (sourcing power). The area in the shaded quadrants shows the output as a load (sinking power).

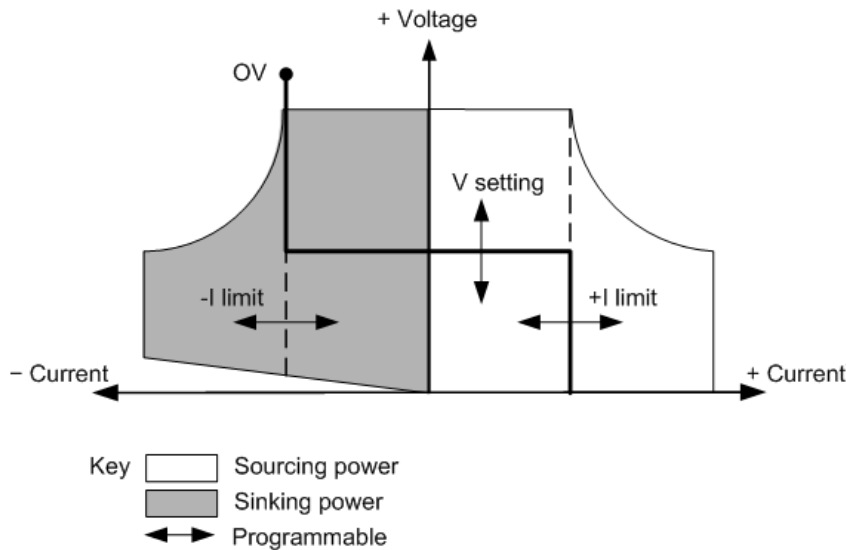

The heavy solid line illustrates the locus of possible operating points as a function of the output load. As shown by the horizontal portion of the line, the output voltage remains regulated at its programmed setting as long as the load current remains within the positive or negative current limit setting. A CV (constant voltage) status flag indicates that the output voltage is being regulated and the output current is within its limit settings.

Note that when the output current reaches either the positive or negative current limit, the unit no longer operates in constant voltage mode and the output voltage is no longer held constant. Instead, the power supply will now regulate the output current at its current limit setting. Either a LIM+ (positive

current limit), or LIM- (negative current limit) status flag is set to indicate that a current limit has been reached. These conditions are annunciated by CL+ or CL- on the front panel.

As shown by the vertical portions of the load line, the output voltage may continue to increase in the positive direction or decrease in the negative direction as current is forced into or pulled out of the unit. When the output voltage exceeds the over-voltage protection setting, the output will shut down, the output relays will open, and the OV status bit will be set.

Current Priority

In current priority mode, the output is controlled by a bi-polar constant current feedback loop, which maintains the output source or sink current at its programmed setting. The output current remains at its programmed setting, provided the load voltage remains within the voltage limit setting. Current priority mode is best suited for use with batteries, power supplies, large charged capacitors, and loads that are sensitive to current overshoots. It minimizes current overshoots during programming, turn-on, and turn-off transitions and seamlessly transitions between positive and negative currents.

In current priority mode, the output current should be programmed to the desired positive or negative value. A positive voltage limit value should also be set. The voltage limit should always be set to a value that is greater than the actual output voltage requirement of the external load. The following figure shows the current priority operating locus of the output. The area in the white quadrants shows the output as a source (sourcing power). The area in the shaded quadrants shows the output as a load (sinking power).

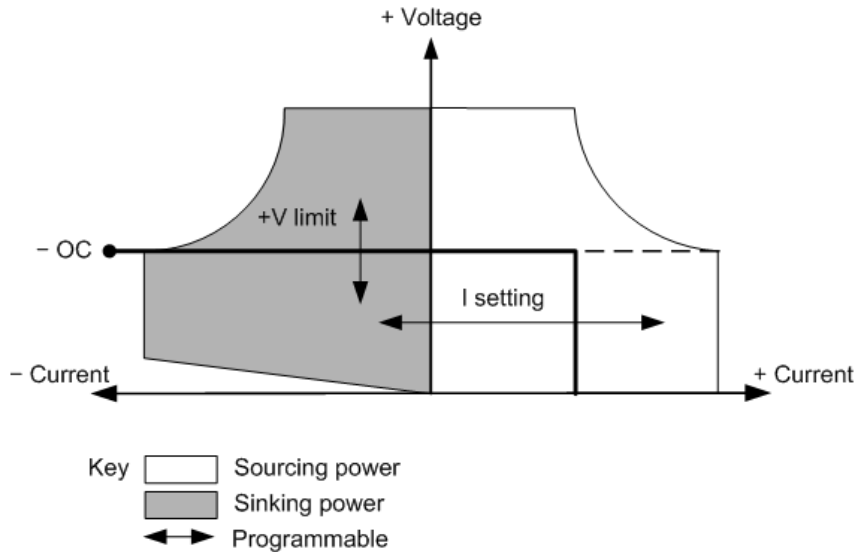

The heavy solid line illustrates the locus of possible operating points as a function of the output load. As shown by the vertical portion of the line, the output current remains regulated at its programmed setting as long as the output voltage remains within its limit setting. A CC (constant current) status flag indicates that the output current is being regulated and the output voltage is within its limit settings.

Note that when the output voltage reaches the voltage limit, the unit no longer operates in constant current mode and the output current is no longer held constant. Instead, the power supply will now regulate the output voltage at its voltage limit setting. A LIM+ (positive voltage limit) status flag is set

to indicate that the voltage limit has been reached. This condition is annunciated by VL+ on the front panel.

As shown by the horizontal portion of the load line, when the unit is sinking power, the output current may continue to increase in the negative direction as more current is forced into the unit. This can happen when the load is a power source such as a battery, and its output voltage is higher than the voltage limit setting of the power supply. Once the current exceeds the built-in negative over-current limit, the output will shut down, the output relays will open, and the OC status bits will be set. In such a case, it is important to set the voltage limit properly in order prevent this protection shutdown.

NOTE

For additional information on priority mode operation during output turn-on/turn-off, refer to **Turn-On Turn-Off Behavior**.

5

SCPI Programming Reference

[Related Information](#)

[SCPI Introduction](#)

[Commands by Subsystem](#)

[Status Tutorial](#)

[Trigger Tutorial](#)

[Reset State](#)

[SCPI Error Messages](#)

[Compatibility Commands](#)

Related Software

BV9200B and BV9201B PathWave BenchVue Advanced Power Control and Analysis Software

The BV9200 software provides fast and easy access to the advanced sourcing and measurement functionality of your RP7900 Series Regenerative Power System without any programming. The BV9200B will allow you to control up to four instruments at once, while the BV9201B will allow you to control a single instrument. These are flexible tools for any application, which let you control any of the RP7900 Series' 20 models. Note that this software does not support primary/secondary operation. Learn more and download a free trail at: www.keysight.com/find/BV9200.

IO Libraries and Instrument Drivers

You can download the Keysight IO Libraries Suite software, along with IVI-COM and LabVIEW drivers from the Keysight Developer Network at www.keysight.com/find/adn.

Interface Documentation

For detailed information about interface connections, refer to the Keysight Technologies USB/LAN/GPIB Interfaces Connectivity Guide, included with the Keysight IO Libraries Suite. Or you can download the guide from the Web at www.keysight.com/find/connectivity.

Web Interface

The RPS provides a Web interface that is built into the instrument. You can use this interface over LAN for remote access and control of the instrument via a Web browser. See [Using the Web Interface](#) for details.

SCPI Introduction

Keywords

Queries

Command Separators and Terminators

Syntax Conventions

Parameter Types

Device Clear

Typical Command Processing Times

Introduction

This instrument complies with the rules and conventions of the present SCPI version (see **SYSTem:VERSion?**).

SCPI (Standard Commands for Programmable Instruments) is an ASCII-based instrument command language designed for test and measurement instruments. SCPI has two types of commands, common and subsystem.

IEEE-488.2 Common Commands

The IEEE-488.2 standard defines a set of common commands that perform functions such as reset, self-test, and status operations. Common commands always begin with an asterisk (*), are three characters in length, and may include one or more parameters. The command keyword is separated from the first parameter by a blank space. Use a semicolon (;) to separate multiple commands as shown below:

Subsystem Commands

Subsystem commands perform specific instrument functions. They are comprised of alphabetically arranged commands that extend one or more levels below the root in a hierarchical structure, also known as a *tree system*. In this structure, associated commands are grouped together under a common node or root, thus forming *subsystems*. A portion of the OUTPut subsystem is shown below to illustrate the tree system. Note that some [optional] commands have been included for clarity.

```

OUTPut
  [:STATe] OFF|0|ON|1
  :DElay
    :FALL <value>|MIN|MAX
    :RISE <value>|MIN|MAX
  :INHibit
    :MODE LATChing|LIVE|OFF

```

Keywords

Keywords, also referred to as headers, are instructions recognized by the instrument. Common commands are also keywords.

OUTPut is the root keyword, DELay is a second-level keyword, FALL and RISE are third-level keywords. Colons (:) separate the keyword levels.

The command syntax shows most commands (and some parameters) as a mixture of upper- and lower-case letters. The upper-case letters indicate the abbreviated spelling for the command. For shorter program lines, you can send the abbreviated form. For better program readability, you can send the long form.

In the above examples, OUTP and OUTPUT are both acceptable forms. You can use upper- or lower-case letters. Therefore, OUTPUT, outp, and Outp are all acceptable. Other forms such as OUT, are not valid and will generate an error.

Queries

Following a keyword with a question mark (?) turns it into a query (Example: VOLTage?, VOLTage:TRIGgered?). If a query contains parameters, place the query indicator at the end of the last keyword, before the parameters. Insert a space between the query indicator and the first parameter.

You can query the programmed value of most parameters. For example, you can query the previously set OUTPut:DELay:FALL time by sending:

```
OUTPut:DELay:FALL?
```

You can also query the minimum or maximum allowable fall time as follows:

```
OUTPut:DELay:FALL? MIN
OUTPut:DELay:FALL? MAX
```

You must read back all the results of a query before sending another command to the instrument. Otherwise, a *Query Interrupted* error will occur and the unreturned data will be lost.

Command Separators and Terminators

Separators

Colons (:) separate keyword levels. Blank spaces must be used to separate command parameters from their corresponding keyword. If a command requires more than one parameter, use a comma to separate adjacent parameters. In the following example, the optional *startindex* and *points* parameters must be separated with a comma. Note the space between CURRent? and the first parameter.

```
FETCh:CURRent? [<start_index>, <points>]
```

Semicolons (;) separate commands within the same subsystem. This lets you send several subsystem commands within the same message string. For example, sending the following command string:

```
OUTPut:STATe ON;DELAy:RISE 1;FALL 2
```

is the same as sending the following commands:

```
OUTPut ON
OUTPut:DELAy:RISE 1
OUTPut:DELAy;FALL 2
```

Note that the semicolon follows the implied path of the hierarchical tree structure. In the above example, the optional :STATe keyword must follow the OUTput keyword to place the command parser at the second level in the hierarchy. This allows the use of the DELay keyword after the semicolon, since DELay is a second-level keyword. Next, the command parser is placed at the third level in the hierarchy by the :RISE keyword. This allows the use of the FALL keyword after the second semicolon, since FALL is a third-level keyword.

You can also combine commands of different subsystems within the same message string. In this case, you must use a colon to return the command parser to the root level in order to access another subsystem. For example, you could clear the output protection and check the status of the Operation Condition register in one message by using a root specifier as follows:

```
OUTPut:PROTEction:CLEar;:STATus:OPERation :CONDition?
```

Note the use of the colon *after* the semicolon in order to return the command parser to the root.

Terminators

A command string sent to the instrument must terminate with a new line (<NL>) character. The IEEE-488 EOI (End-Or-Identify) message is interpreted as a <NL> character and can be used to terminate a command string in place of an <NL>. A carriage return followed by a new line (<CR><NL>) is also accepted. Command string termination will always reset the current SCPI command path to the root level.

Syntax Conventions

- Triangle brackets (< >) indicate that you must specify a value for the enclosed parameter. For example, in the OUTPut:DELAy syntax statements shown above, the <value> parameter is enclosed in triangle brackets. The brackets are not sent with the command string. You must specify a value for the parameter (Example: "OUTP:DEL:FALL 0.1") unless you select another option shown in the syntax (Example: "OUTP:DEL:FALL MIN").
- A vertical bar (|) separates multiple parameter choices for a given command string. For example, LATChing|LIVE|OFF in the OUTPut:INHibit command indicates that you can specify "LATChing", "LIVE", or "OFF". The bar is not sent with the command string.

- Square brackets ([]) enclose some syntax elements – nodes and parameters for example. This indicates that the element is optional and can be omitted. The brackets are not sent with the command string. In the case of an optional parameter, if you do not specify a value for an optional parameter the instrument will ignore the parameter. In the FETCh:CURRent? example above, the optional <startindex> and <points> parameters let you return array data starting at startindex and containing the specified number of data points. If these parameters are not specified, the query returns all of the array data.
- Braces ({ }) indicate parameters that may be repeated zero or more times. It is used especially for showing lists. The notation <value>{,<value>} shows that the first value must be entered, while additional values may be omitted or may be entered one or more times.

Parameter Types

The SCPI language defines several data formats to be used in commands and queries.

Numeric Parameters

Commands that require numeric parameters will accept all commonly used decimal representations of numbers including optional signs, decimal points, and scientific notation. If a command accepts only certain specific values, the instrument will automatically round the input numeric parameters to the accepted values. The following command requires a numeric parameter for the voltage value:

```
[SOURce:]VOLTage 50V|MIN|MAX
```

Note that special values for numeric parameters such as MINimum, MAXimum, and INFINITY are also accepted. Instead of selecting a specific value for the voltage parameter, you can substitute MIN to set the voltage to its minimum allowable value, MAX to set it to its maximum allowable value.

You can also send engineering unit suffixes with numeric parameters (e.g., V for volts, A for amperes, W for Watts). All parameters values are in base units.

Discrete Parameters

Discrete parameters are used to program settings that have a limited number of values (like IMMEDIATE, EXTERNAL, or BUS). They may have a short form and a long form just like command keywords. You can use upper- or lower-case letters. Query responses will always return the short form in all upper-case letters. The following command requires a discrete parameter for the display settings:

```
DISPlay:VIEW METER_VI|METER_VP|METER VIP
```

Boolean Parameters

Boolean parameters represent a single binary condition that is either true or false. For a false condition, the instrument will accept "OFF" or "0". For a true condition, the instrument will accept "ON" or "1". When you query a Boolean setting, the instrument will always return "0" or "1". The following command requires a Boolean parameter:

```
DISPlay OFF|0|ON|1
```

ASCII String Parameters

String parameters can contain virtually any set of ASCII characters. A string must begin and end with matching quotes; either with a single quote or a double quote. You can include the quote delimiter as part of the string by typing it twice without any characters in between. The following command uses a string parameter:

```
CALibrate:DATE "12/12/12"
```

Arbitrary Block Program or Response Data

Definite-length block data <Block> allows any type of device-dependent data to be programmed or returned as a series of 8-bit binary data bytes. This is particularly useful for transferring large quantities of data or 8-bit extended ASCII codes.

Device Clear

Device Clear is an IEEE-488 low-level bus message that you can use to return the instrument to a responsive state. Different programming languages and IEEE-488 interface cards provide access to this capability through their own unique commands. The status registers, the error queue, and all configuration states are left unchanged when a Device Clear message is received.

Device Clear performs the following actions:

- If a measurement is in progress, it is aborted.
- The instrument returns to the trigger idle state.
- The instrument's input and output buffers are cleared.
- The instrument is prepared to accept a new command string.

NOTE

The ABORT command is the recommended method to terminate an instrument operation.

Typical Command Processing Times

The following table documents some typical, average command processing times for several types of setting commands and response queries. This can help you determine the impact of some commonly used SCPI commands on total test time. All times are in milliseconds.

Setting commands like VOLT <n> only account for the IO latency + command processing, not the time for the action to complete (like the output voltage to finish changing or output state completing turn on).

Query command times apply from when the command was sent to the instrument until the response is received.

5 SCPI Programming Reference

Commands	GPIB	VXI-11
Set the output voltage: VOLT <n>	0.24 ms	0.65 ms
Return the output setting: OUTP?	0.30 ms	1.35 ms
Set the unit to the reset state: *RST	5.01 ms	5.26 ms
10 point measurement		
Return 10 point measurement: MEAS:VOLT?	3.00 ms	3.30 ms
Return 10 point fetch: FETC:VOLT?	0.49	1.49 ms
1 NPLC measurement		
Return 1 NPLC measurement: MEAS:VOLT?	21.03 ms	20.96 ms
Return 1 NPLC fetch: FETC:VOLT?	0.63 ms	1.41 ms
25 k point measurement		
Return 25 k point measurement: MEAS:VOLT?	521.0 ms	521.1 ms
Return 25 k point fetch: FETC:VOLT?	5.07 ms	7.01 ms
Return 25 k point ASCII array fetch: FETC:ARR:VOLT?	4009.5 ms	1010.8 ms
Return 25 k point binary array fetch: FETC:ARR:VOLT?	694.25 ms	30.39

Commands by Subsystem

ABORt

CALibrate

DISPlay

FETCh

FORMat

HCOPy

IEEE-488 Common

INITiate

INSTrument

LXI

MEASure

OUTPut

SENSe

[SOURce:]

ARB

CURRent

DIGital

FUNction

LIST

POWer

STEP

VOLTage

STATus

SYSTem

TRIGger

ABORt Subsystem

Abort commands cancel any triggered actions and returns the trigger system back to the Idle state. Abort commands are also executed with the *RST command.

ABORt:ACQuire

ABORt:ELOG

ABORt:TRANsient

ABORt:ACQuire - Cancels any triggered measurements. It also resets the WTG-meas and MEAS-active bits in the Operation Status registers.

ABORt:ELOG - Stops external data logging. It also resets the WTG-meas and MEAS-active bits in the Operation Status registers.

ABORt:TRAN - Cancels any triggered actions. It also resets the WTG-tran and TRAN-active bits in the Operation Status registers. Note that this command does not turn off continuous triggers if INITiate:CONTInuous:TRANsient ON has been programmed. In this case, the trigger system will automatically re-initiate.

Parameter	Typical Return
(none)	(none)
Aborts the triggered measurement: ABOR:ACQ	

ARB Subsystem

ARB commands program the constant-dwell arbitrary waveforms. Constant-dwell waveforms can have up to 65,535 points assigned to them, with the same dwell time for each point.

[SOURce:]ARB:COUNT <value>|MIN|MAX|INFinity
[SOURce:]ARB:COUNT? [MIN|MAX]

Specifies the number of times the Arb repeats. Use the INFinity parameter to repeat the Arb continuously.

Parameter	Typical Return
1 – 256, *RST 1	<count>
Programs a repeat count of 10: ARB:COUN 10	

[SOURce:]ARB:CURRent:CDWell[:LEVel] <value>{,<value>}|<Block>
[SOURce:]ARB:CURRent:CDWell[:LEVel]?
[SOURce:]ARB:VOLTage:CDWell[:LEVel] <value>{,<value>}|<Block>
[SOURce:]ARB:VOLTage:CDWell[:LEVel]?

Specifies the level of each point in the Arb. Values are specified in either amperes or volts. The minimum and maximum values depend on the ratings of the unit.

Current and voltage Arbs share settings, so setting the current Arb resets the voltage Arb level to its default value and vice versa. For better performance, the list can be sent as single precision floating point values in definite length arbitrary block format instead of an ASCII list. The response format is dependent on the return format ASCII or REAL.

Parameter	Typical Return
-102% to 102% of current rating or 0 to 102% of voltage rating	<value> [,<value>] or <Block>
Programs a constant dwell Arb of 5 voltage points: ARB:VOLT:CDW 5,4,3,2,1	

[SOURce:]ARB:CURRent:CDWell:DWELL <value>
[SOURce:]ARB:CURRent:CDWell:DWELL?
[SOURce:]ARB:VOLTage:CDWell:DWELL <value>
[SOURce:]ARB:VOLTage:CDWell:DWELL?

Specifies the dwell time of each point in the Arb. Values are in seconds and are rounded to the nearest 10.24-microsecond increment.

Current and voltage Arbs share settings, so setting this parameter for a current Arb changes the voltage dwell value and vice versa.

Parameter	Typical Return
0.00001024 – 0.30, *RST 0.001	<dwel value>
Programs a constant dwell time of 0.2 seconds: ARB:CURR:CDW:DWEL 0.2	

- You can program dwell times that are much faster than the response time of the instrument. The "extra" points and dwell times can serve the purpose of smoothing the resultant waveshape.

[SOURce:]ARB:CURRent:CDWell:POINTs?

[SOURce:]ARB:VOLTage:CDWell:POINTs?

Returns the number of points in the Arb.

Parameter	Typical Return
(none)	<points>
Returns the number of current points in the Arb: ARB:CURR:CDW:POIN?	

[SOURce:]ARB:FUNcTION:TYPE CURRent|VOLTage

[SOURce:]ARB:FUNcTION:TYPE?

Specifies either a voltage or current Arb. Only one type of Arb may be output at a time. The selection must match the priority mode.

Parameter	Typical Return
CURRent VOLTage, *RST VOLTage	VOLT or CURR
Specifies a voltage Arb: ARB:FUNC:TYPE VOLT	

[SOURce:]ARB:TERMinate:LAST 0|OFF|1|ON

[SOURce:]ARB:TERMinate:LAST?

Selects the output setting after the Arb ends. When ON (1), the output voltage or current remains at the last Arb value. The last Arb voltage or current value becomes the IMMEDIATE value when the ARB completes. When OFF (0), and also when the Arb is aborted, the output returns to the settings that were in effect before the Arb started.

Parameter	Typical Return
0 OFF 1 ON, *RST OFF	0 or 1
Terminate with the output at the last Arb value: ARB:TERM:LAST ON	

CALibrate Subsystem

Calibrate commands calibrate the instrument.

NOTE

Read the **calibration section** before calibrating. Improper calibration reduces accuracy and reliability.

CALibrate:COUNT?

Returns the number of times the unit has been calibrated. The count is incremented whenever the calibration (and date) is saved, the administration password is changed or reset, or the firmware is updated.

Parameter	Typical Return
(none)	<count>
Return the calibration count: CAL:COUNT?	

CALibrate:CURRENT[:LEVEL] <value>

Calibrates the current programming and measurement. The value selects the range to calibrate.

Parameter	Typical Return
The maximum current of the output range.	(none)
Calibrates the current of the 10 A range: CAL:CURR 10	

CALibrate:CURRENT:SHARing RP795xA, RP796xA

Calibrates the Imon signal for paralleled units.

Parameter	Typical Return
(none)	(none)
Calibrates the current sharing: CAL:CURR:SHAR	

CALibrate:CURRENT:TC RP793xA, RP794xA

Calibrates the temperature coefficient.

Parameter	Typical Return
(none)	(none)
Calibrates the temperature coefficient: CAL:CURR:TC	

CALibrate:DATA <value>

Enters the calibration value read by the external meter. You must first select a calibration level for the value being entered. Data values are expressed in base units - either volts or amperes, depending on which function is being calibrated.

Parameter	Typical Return
Numeric value	(none)
Specify calibration value 0.0237: <code>CAL:DATA 2.37E-2</code>	

CALibrate:DATE <"date">**CALibrate:DATE?**

Enters the calibration date in nonvolatile memory. Enter any ASCII string up to 15 characters. The query returns the date.

Parameter	Typical Return
<"date"> String program data. Enclose string parameters in single or double quotes.	<last cal date>
Enters the calibration date: <code>CAL:DATE "12/12/12"</code>	

CALibrate:LEVel P1|P2|P3**CALibrate:LEVel?**

Advances to the next level in the calibration. P1 is the first level; P2 is the second; P3 is the third.

Parameter	Typical Return
P1 P2 P3	(none)
Selects the first calibration point: <code>CAL:LEV P1</code>	

- Some calibration sequences may require some settling time after sending CAL:LEV but before reading the data from the DVM and sending CAL:DATA.

CALibrate:PASSword <password>

Sets a numeric password to prevent unauthorized calibration. This is the same as the **Admin** password.

Parameter	Typical Return
<password> A numeric value of up to 15 digits	(none)
Set a new password to a value of 1234: <code>CAL:PASS 1234</code>	

- If the password is set to 0, password protection is removed and the ability to enter calibration mode is unrestricted. The as-shipped setting is 0 (zero).
- To change the password: unsecure calibration memory with old code, then set the new code.
- If you forget your password, refer to [Calibration Switches](#).
- This setting is non-volatile; it will not be changed by power cycling or *RST.

CALibrate:RESistance:BOUT RP795xA, RP796xA

Calibrates the bottom out resistance.

Parameter	Typical Return
(none)	(none)
Calibrates the bottom out resistance: <code>CAL:RES:BOUT</code>	

CALibrate:SAVE

Saves the calibration constants in non-volatile memory. Do this at the end of the calibration to avoid losing changes.

Parameter	Typical Return
(none)	(none)
Store calibration constants into non-volatile memory: <code>CAL:SAVE</code>	

CALibrate:STATe 0|OFF|1|ON [, <password>] **CALibrate:STATe?**

Enables or disables calibration mode. Calibration mode must be enabled for the instrument to accept any calibration commands. The first parameter specifies the state. The second optional parameter is the password.

Parameter	Typical Return
0 OFF 1 ON, *RST OFF	0 or 1
<password> a numeric value up to 15 digits	(none)
Disable calibration: <code>CAL:STAT OFF</code>	
Enable calibration: <code>CAL:STAT ON [,value]</code>	

A password is required if <password> has been set to a non-zero value.

CALibrate:VOLTage[:LEVel] <value>

Calibrates the local voltage programming and measurement. The value selects the range to calibrate.

Parameter	Typical Return
The maximum voltage of the output range.	(none)
Calibrates the voltage of the 20 V range: CAL:VOLT 20	

CURRENT Subsystem

Current commands program the output current of the instrument.

[SOURce:]CURRENT[:LEVel][:IMMediate][:AMPLitude] <value>|MIN|MAX
[SOURce:]CURRENT[:LEVel][:IMMediate][:AMPLitude]? [MIN|MAX]
[SOURce:]CURRENT[:LEVel]:TRIGgered[:AMPLitude] <value>|MIN|MAX
[SOURce:]CURRENT[:LEVel]:TRIGgered[:AMPLitude]? [MIN|MAX]

Sets the immediate or triggered current level when the output is operating in current priority mode. The triggered level is a stored value that is transferred to the output when an output Step is triggered. Units are in amperes. The maximum value depends on the current rating of the unit. The minimum value is the most negative value.

Parameter	Typical Return
-102% to 102% of rating, *RST 0	<current level>
Sets the positive current limit to 2 A: CURR:LIM 2	

[SOURce:]CURRENT:BWIDth:LEVel 0 | 1, <value>|MIN|MAX RP793xA, RP794xA
[SOURce:]CURRENT:BWIDth:LEVel? [MIN|MAX]

Specifies the low-pass filter corner frequency applied to the programming setpoint signal with the indicated range of user-configurable setpoints. The value is in Hertz. The default frequency is optimized for maximum up-programming speed as well as the fastest transient response time. It can be reduced to compensate for output overshoots.

Parameter	Typical Return
0 1	0 or 1
10 to 5,000 all ranges	<pole frequency>
Sets the current bandwidth to 1, frequency 60 Hz: CURR:BWID:LEV 1, 60	

[SOURce:]CURRENT:BWIDth:RANGe 0 | 1 RP793xA, RP794xA
[SOURce:]CURRENT:BWIDth[:RANGe]?

Sets the current compensation. This lets you optimize output response time with inductive loads. These compensation modes only apply when the unit is operating in constant current (CC), both in current priority and in voltage priority (when in current limit).

Parameter	Description
0	Best suited for stability with a wide range of output inductances. Refer to Set the Output Bandwidth for specific inductive load limits
1	Provides maximum up-programming speed and the fastest transient response time when the output inductance is restricted to small values.

Parameter	Typical Return
0 1, *RST 0	0 or 1
Sets the current bandwidth to 1: CURR:BWID 1	

[SOURce:]CURRent:LIMit[:POSitive][:IMMediate][:AMPLitude] <value>|MIN|MAX
[SOURce:]CURRent:LIMit[:POSitive][:IMMediate][:AMPLitude]? [MIN|MAX]
[SOURce:]CURRent:LIMit:NEGative[:IMMediate][:AMPLitude] <value>|MIN|MAX
[SOURce:]CURRent:LIMit:NEGative[:IMMediate][:AMPLitude]? [MIN|MAX]

Sets the current limit when in voltage priority mode. Units are in amperes. The maximum value depends on the current rating of the unit. The minimum value is the most negative value.

Parameter	Typical Return
Positive: 0 to 102% of rating, *RST 1.02% of rating	<+current limit>
Negative: -102% of rating to 0, *RST -102% of rating	<-current limit>
Sets the positive current limit to 2 A: CURR:LIM 2	
Sets the negative current limit to -2 A: CURR:LIM:NEG -2	

[SOURce:]CURRent:MODE FIXed|STEP|LIST|ARB
[SOURce:]CURRent:MODE?

Sets the transient mode. This determines what happens to the output current when the transient system is initiated and triggered.

FIXed keeps the output current at its immediate value.

STEP steps the output to the triggered level when a trigger occurs.

LIST causes the output to follow the list values when a trigger occurs.

ARB causes the output to follow the arbitrary waveform values when a trigger occurs.

Parameter	Typical Return
FIXed STEP LIST ARB, *RST FIXed	FIX, STEP, LIST, or ARB
Sets the current mode to Step: CURR:MODE STEP	

[SOURce:]CURRent:PROTection:DELAy[:TIME] <value>|MIN|MAX
[SOURce:]CURRent:PROTection:DELAy[:TIME]? [MIN|MAX]

Sets the over-current protection delay. The over-current protection function will not be triggered during the delay time. After the delay time has expired, the over-current protection function will be active. This prevents momentary changes in output status from triggering the over-current protection function. Values up to 255 milliseconds can be programmed, with a resolution of 1 millisecond.

Parameter	Typical Return
0 – 0.255, *RST 0.020 s	<delay value>
Sets the protection delay to 0.2 seconds: <code>CURR:PROT:DEL 0.2</code>	

- The operation of over-current protection is affected by the setting of the current protection delay start event, which is specified by `CURRent:PROTection:DELAy:STARt`.

[SOURce:]CURRent:PROTection:DELAy:STARt SCHange|CCTRans **[SOURce:]CURRent:PROTection:DELAy:STARt?**

Specifies what starts the over-current protection delay timer. **SCHange** starts the over-current delay whenever a command changes the output settings. **CCTRans** starts the over-current delay timer by any transition of the output into current limit mode.

Parameter	Typical Return
SCHange CCTRans, *RST SCHange	SCH or CCTR
Selects the CCTRans delay mode: <code>CURR:PROT:DEL:STAR CCTR</code>	

[SOURce:]CURRent:PROTection:STATe 0|OFF|1|ON **[SOURce:]CURRent:PROTection:STATe?**

Enables or disables the over-current protection. If the over-current protection function is enabled and the output goes into current limit, the output is disabled and the Questionable Condition status register OCP bit is set.

Parameter	Typical Return
0 OFF 1 ON, *RST OFF	0 or 1
Enable the current protection state: <code>CURR:PROT:STAT ON</code>	

- An over-current condition can be cleared with `OUTPut:PROTection:CLEar` after the cause of the condition is removed.

[SOURce:]CURRent:SHARing[:STATe] 0|OFF|1|ON RP795xA, RP796xA **[SOURce:]CURRent:SHARing[:STATe]?**

Enables or disables current sharing on paralleled units. This command must be sent to each unit that is paralleled. When enabled, the load current is shared equally among the paralleled outputs. The rear panel **Share** terminals must be connected; otherwise an error will occur.

Parameter	Typical Return
0 OFF 1 ON, *RST OFF	0 or 1
To enable current sharing: <code>CURR:SHAR ON</code>	

[SOURce:]CURRent:SLEW[:IMMEDIATE] <value>|MIN|MAX|INFINITY
[SOURce:]CURRent:SLEW[:IMMEDIATE]? [MIN|MAX]

Sets the current slew rate. The slew rate is set in amps per second and affects all programmed current changes, including those due to the output state turning on or off. The slew rate can be set to any value between 0 and 9.9E+37. For very large values, the slew rate will be limited by the unit's listed programming speed and bandwidth. The keywords MAX or INFINITY set the slew rate to maximum.

Parameter	Typical Return
0 – 9.9E+37, *RST MAX	<max value>
Sets the output slew rate to 1 A per second: <code>CURR:SLEW 1</code>	

- The query returns the value that was sent. If the value is less than the minimum slew rate, the minimum value is returned. The slew setting resolution is the same as the minimum value, which can be queried using `CURRent:SLEW? MIN`. The exact value varies slightly according to calibration.

[SOURce:]CURRent:SLEW:MAXimum 0|OFF|1|ON
[SOURce:]CURRent:SLEW:MAXimum?

Enables or disables the maximum slew rate override. When enabled, the slew rate is set to its maximum value. When disabled, the slew rate is set to the immediate value set by the `CURRent:SLEW` command. Use `CURRent:SLEW? MAX` to query the maximum slew rate that was set.

Parameter	Typical Return
0 OFF 1 ON, *RST ON	0 or 1
Enable the maximum slew rate: <code>CURR:SLEW:MAX ON</code>	

- The `CURRent:SLEW:MAX` command is coupled to the `CURRent:SLEW` command. If `CURRent:SLEW` sets the rate to MAX or INFINITY, `CURRent:SLEW:MAX` is enabled. If the slew rate is set to any other value, `CURRent:SLEW:MAX` is disabled.

DIGital Subsystem

Digital commands program the digital control port on the rear panel of the instrument.

[SOURce:]DIGital:INPut:DATA?

Reads the state of the digital control port. Returns the binary-weighted value of the state of pins 1 through 7 in bits 0 through 6 respectively.

Parameter	Typical Return
(none)	<bit value>
Reads the state of the digital control port: <code>DIG:INP:DATA?</code>	

[SOURce:]DIGital:OUTPut:DATA <value>

[SOURce:]DIGital:OUTPut:DATA?

Sets the state of the digital control port. This only affects the pins whose function has been set to Digital IO operation. The port has seven signal pins and a digital ground pin. In the binary-weighted value that is written to the port, the pins are controlled according to the following bit assignments:

Pin	1	2	3	4	5	6	7
Bit number	0	1	2	3	4	5	6
Decimal value	1	2	4	8	16	32	64

Bit values corresponding to digital port pins that are not configured as DIO are ignored.

Parameter	Typical Return
0 – 127, *RST 0	<bit value>
Programs pins 1, 3, and 5 on: <code>DIG:OUTP:DATA?</code>	

[SOURce:]DIGital:PIN<1-7>:FUNctIon <function>

[SOURce:]DIGital:PIN<1-7>:FUNctIon?

Sets the pin function. The functions are saved in non-volatile memory.

DIO	General-purpose ground-referenced digital input/output function.
DINPut	Digital input-only mode.
FAULt	Pin 1 functions as an isolated fault output. Pin 2 is common for pin 1
INHibit	Pin 3 functions as an inhibit input.
ONCouple	Pins 4 -7 synchronize the output On state.
OFFCouple	Pins 4 -7 synchronize the output Off state.
TINPut	A trigger input function.
TOUtput	A trigger output function

Parameter	Typical Return
DIO DINPut FAULt INHibit ONCouple OFFCouple TINPut TOUTput	DIO, DINP, FAUL, INH, ONC, OFFC, TINP, or TOUT
Sets pin 1 to FAULt mode: DIG:PIN1:FUNC FAUL	

[SOURce:]DIGital:PIN<1-7>:POLarity POSitive|NEGative
[SOURce:]DIGital:PIN<1-7>:POLarity?

Sets the pin polarity. **POSitive** means a logical true signal is a voltage high at the pin. For trigger inputs and outputs, POSitive means a rising edge. **NEGative** means a logical true signal is a voltage low at the pin. For trigger inputs and outputs, NEGative means a falling edge. The pin polarities are saved in non-volatile memory.

Parameter	Typical Return
POSitive NEGative	POS or NEG
Sets pin 1 to POSitive polarity: DIG:PIN1:POL POS	

[SOURce:]DIGital:TOUTput:BUS[:ENABLE] 0|OFF|1|ON
[SOURce:]DIGital:TOUTput:BUS[:ENABLE]?

Enables or disables BUS triggers on digital port pins. This allows a BUS trigger to be sent to any digital port pin that has been configured as a trigger output. A trigger out pulse is generated when the state is on and a bus trigger is received. A BUS trigger is generated using the *TRG command.

Parameter	Typical Return
0 OFF 1 ON, *RST OFF	0 or 1
Enable BUS triggered signals on the digital pins: CURR:TOUT:BUS ON	

- The query returns 0 (OFF) if the trigger signal will NOT be generated with a BUS trigger command, and 1 (ON) if a trigger signal will be generated with a BUS trigger command.

DISPlay Subsystem

Display commands control the front panel display.

DISPlay[:WINDow][:STATe] 0|OFF|1|ON
DISPlay[:WINDow][:STATe]?

Turns the front panel display on or off.

Parameter	Typical Return
0 OFF 1 ON, *RST ON	0 or 1
Turns the front panel display off: <code>DISP OFF</code>	

DISPlay[:WINDow]:VIEW METER_VI|METER_VP|METER_VIP
DISPlay[:WINDow]:VIEW?

Selects the parameters to display on the front panel. **METER_VI** displays output voltage and current. **METER_VP** displays output voltage and power. **METER_VIP** displays output voltage, current, and power.

Parameter	Typical Return
METER_VI METER_VP METER_VIP, *RST METER_VI	METER_VI, METER_VP, or METER_VIP
To display voltage and power: <code>DISP:VIEW METER_VP</code>	

DISPlay:SAVer[:STATe] 0|OFF|1|ON
DISPlay:SAVer[:STATe]?

Turns the front panel screen saver on or off.

Parameter	Typical Return
0 OFF 1 ON, *RST OFF	0 or 1
Turns the front panel screen saver on: <code>DISP:SAV ON</code>	

FETCh Subsystem

Fetch commands return measurement data that has been previously acquired. FETCh queries do not generate new measurements, but allow additional measurement calculations from the same acquired data. The data is valid until the next MEASure or INITiate command occurs.

FETCh[:SCALar]:CURRent[:DC]? [<start_index>, <points>]

FETCh[:SCALar]:VOLTage[:DC]? [<start_index>, <points>]

FETCh[:SCALar]:POWer[:DC]?

Returns the averaged measurement. Values returned are either in amperes, volts, or watts.

Optional parameters specify a subset starting at <startindex> and of length <points>.

Parameter	Typical Return
[<startindex>] the start index [<points>] the number of points	<DC value>
Returns the measured DC current FETC:CURR?	

FETCh[:SCALar]:CURRent:ACDC?

FETCh[:SCALar]:VOLTage:ACDC?

Returns the RMS measurement (AC + DC). Values returned are either in amperes, or volts.

Parameter	Typical Return
(none)	<ACDC value>
Returns the measured RMS voltage FETC:VOLT:ACDC?	

FETCh[:SCALar]:CURRent:HIGH?

FETCh[:SCALar]:VOLTage:HIGH?

Returns the High level of a pulse waveform. Values returned are either in amperes, or volts. See [Measurement Types](#).

Parameter	Typical Return
(none)	<HIGH value>
Returns the measured high level current FETC:CURR:HIGH?	

FETCh[:SCALar]:CURRent:LOW?
FETCh[:SCALar]:VOLTage:LOW?

Returns the Low level of a pulse waveform. Values returned are either in amperes, or volts. See [Measurement Types](#).

Parameter	Typical Return
(none)	<LOW value>
Returns the measured low level voltage <code>FETC:VOLT:LOW?</code>	

FETCh[:SCALar]:CURRent:MAXimum?
FETCh[:SCALar]:VOLTage:MAXimum?
FETCh[:SCALar]:POWer:MAXimum]?
FETCh[:SCALar]:CURRent:MINimum?
FETCh[:SCALar]:VOLTage:MINimum?
FETCh[:SCALar]:POWer:MINimum]?

Returns the maximum or minimum value. Values returned are either in amperes, volts, or watts.

Parameter	Typical Return
(none)	<MIN value> <MAX value>
Returns the measured maximum current <code>FETC:CURR:MAX?</code>	
Returns the measured minimum voltage <code>FETC:VOLT:MIN?</code>	
Returns the measured maximum power <code>FETC:POW:MAX?</code>	

FETCh:AHOur? [IGNORE_OVLD]
FETCh:WHOur? [IGNORE_OVLD]

FETCh:AHOur? - Returns the accumulated amp-hours.

FETCh:WHOur? - Returns the accumulated watt-hours.

See [Amp-Hour and Watt-Hour Measurements](#) for details.

If any measurement sample was overrange, the query returns SCPI Not a Number (9.91E37). If the optional IGNORE_OVLD parameter is sent, the accumulated measurement will be returned even if some samples were outside of the measurement range.

Parameter	Typical Return
IGNORE_OVLD ignore overload measurements	<amp-hours> <watt-hours>
Returns the amp-hour measurement <code>FETC:AHO?</code>	
Returns the watt-hour measurement <code>FETC:WHO?</code>	

FETCh:ARRay:CURRent[:DC]? [<start_index>, <points>]

FETCh:ARRay:VOLTage[:DC]? [<start_index>, <points>]

FETCh:ARRay:POWer[:DC]?

Returns the instantaneous measurement. Values returned are either in amperes, volts, or watts.

Optional parameters specify a subset starting at <startindex> and of length <points>.

The return format depends on the settings of the FORMat:BORDER and FORMat[:DATA] commands. When the data format is set to ASCII, returned values are comma separated. When the data format is set to REAL, data is returned as single precision floating point values in definite length arbitrary block response format.

Parameter	Typical Return
[<startindex>] the start index	<value> [,<value>]
[<points>] the number of points	or <Block>

Returns the measured current array **FETC:ARR:CURR?**

FETCh:ELOG? <maxrecords>

Returns the most recent external datalog records. Data must be read from the buffer periodically to avoid the buffer overflowing. Whenever data is read using FETCh:ELOG? then that buffer space is made available in the instrument for storing more acquired data.

Maxrecords is the maximum number of records of datalog data that the controller will return.

The return format depends on the settings of the FORMat:BORDER and FORMat[:DATA] commands. When the data format is set to ASCII, returned values are comma separated. When the data format is set to REAL, data is returned as single precision floating point values in definite length arbitrary block response format.

Parameter	Typical Return
[<maxrecords>] the number of records returned (1 to 16,384)	<value> [,<value>] or <Block>

Returns 100 data records **FETC:ELOG? 100**

FORMat Subsystem

FORMat commands specify the format for transferring measurement data.

FORMat[:DATA] ASCII|REAL FORMat[:DATA]?

Specifies the format of the returned data. This is used by queries that can return a block of data. **ASCII** returns data as ASCII bytes in numeric format as appropriate. The numbers are separated by commas. **REAL** returns data in a definite length block as IEEE single precision floating point values. In this case the 4 bytes of each value can be returned in either big-endian or little-endian byte order, determined by the FORMat:BORDER setting.

Parameter	Typical Return
ASCII REAL, *RST ASCII	ASCII or REAL
Sets the data format to ASCII: <code>FORMat ASCII</code>	

- The data format is used by a small sub set of queries that can return large quantities of data.

FORMat:BORDER NORMal|SWAPped FORMat:BORDER?

Specifies how binary data is transferred. This only applies when the FORMat:DATA is set to REAL. **NORMal** transfers data in normal order. The most significant byte is returned first, and the least significant byte is returned last (big-endian). **SWAPped** transfers data in swapped-byte order. The least significant byte is returned first, and the most significant byte is returned last (little-endian).

Parameter	Typical Return
NORMal SWAPped, *RST NORMal	NORM or SWAP
Sets the data transfer to Swapped: <code>FORM:BORD SWAP</code>	

- The byte order is used when fetching real data from SCPI measurements.

FUNCTION Command

[SOURce:]FUNCTION CURRent|VOLTage
[SOURce:]FUNCTION?

Sets the output regulation - voltage priority or current priority. In voltage priority mode, the output is controlled by a constant voltage feedback loop, which maintains the output voltage at its programmed setting. In current priority mode, the output is controlled by a constant current feedback loop, which maintains the output current at its positive or negative programmed setting.

Refer to [Priority Mode Tutorial](#) for more information.

Parameter	Typical Return
CURRent VOLTage, *RST VOLTage	CURR or VOLT
Sets the output regulation to current priority: FUNC CURR	

HCOPy Subsystem

HCOPy commands return the display image.

HCOPy:SDUMp:DATA? [BMP|GIF|PNG]

Returns an image of the front panel display. The format may be specified by the optional parameter. If no format is specified, the format is determined by HCOPy:SDUMp:DATA:FORMat.

The response is a SCPI 488.2 definite length binary block of the form: #<nonzero digit><digits><8 bit data-bytes> where:

<nonzero digit> specifies the number of digits to follow,
 <digits> specify the number of 8 bit data bytes to follow, and
 <8 bit data bytes> contain the data to be transferred.

Parameter	Typical Return
[BMP GIF PNG]	<Block>

Returns the image in GIF format: `HCOP:SDUM:DATA? GIF`

HCOPy:SDUMp:DATA:FORMat BMP|GIF|PNG HCOPy:SDUMp:DATA:FORMat?

Specifies the format for front panel images returned.

Parameter	Typical Return
BMP GIF PNG, *RST PNG	BMP, GIF, or PNG

Specify GIF as the image format: `HCOP:SDUM:DATA:FORM GIF`

IEEE-488 Common Commands

IEEE-488 Common commands generally control overall instrument functions, such as reset, status, and synchronization. All common commands consist of a three-letter mnemonic preceded by an asterisk: *RST *IDN? *SRE 8.

*CLS

Clear status command. Clear Status Command. Clears the **event registers** in all register groups. Also clears the status byte and error queue. If *CLS immediately follows a program message terminator (<NL>), then the output queue and the MAV bit are also cleared. Refer to **Status Tutorial** for more information.

Parameter	Typical Return
(none)	(none)
Clear event registers, status byte, and error queue: *CLS	

*ESE <value>

*ESE?

Event status enable command and query. Sets the value in the **enable register** for the **Standard Event Status** group. Each set bit of the register enables a corresponding event. All enabled events are logically ORed into the ESB bit of the status byte. The query reads the enable register. Refer to **Status Tutorial** for more information.

Parameter	Typical Return
A decimal value corresponding to the binary-weighted sum of the register's bits.	<bit value>
Enable bits 3 and 4 in the enable register: *ESE 24	

- The value returned is the binary-weighted sum of all enabled bits in the register. For example, with bit 2 (value 4) and bit 4 (value 16) set, the query returns +20.
- Any or all conditions can be reported to the ESB bit through the enable register. To set the enable register mask, write a decimal value to the register using *ESE.
- *CLS does not clear the enable register, but does clear the **event register**.

*ESR?

Event status event query. Reads and clears the **event register** for the **Standard Event Status** group. The event register is a read-only register, which latches all standard events. Refer to **Status Tutorial** for more information.

Parameter	Typical Return
(none)	<bit value>

Read event status enable register: ***ESR?**

- The value returned is the binary-weighted sum of all enabled bits in the register.
- Any or all conditions can be reported to the ESB bit through the enable register. To set the enable register mask, write a decimal value to the register using ***ESE**.
- Once a bit is set, it remains set until cleared by this query or ***CLS**.

***IDN?**

Identification Query. Returns instrument's identification string, which contains four comma-separated fields. The first field is the manufacturer's name, the second field is the instrument model number, the third field is the serial number, and the fourth field is the firmware revision.

Parameter	Typical Return
(none)	Keysight Technologies,RP7951A,MY12345678,A.01.01

Return the instrument's identification string: ***IDN?**

***OPC**

Sets the OPC (operation complete) bit in the standard event register. This occurs at the completion of the pending operation. Refer to [Status Tutorial](#) for more information.

Parameter	Typical Return
(none)	(none)

Set the Operation Complete bit: ***OPC**

- The purpose of this command is to synchronize your application with the instrument.
- Used in conjunction with initiated acquisitions, transients, output state changes, and output settling time to provide a way to poll or interrupt the computer when these pending operations complete.
- Other commands may be executed before the operation complete bit is set.
- The difference between ***OPC** and ***OPC?** is that ***OPC?** returns "1" to the output buffer when the current operation completes.

***OPC?**

Returns a 1 to the output buffer when all pending operations complete. The response is delayed until all pending operations complete.

5 SCPI Programming Reference

Parameter	Typical Return
(none)	1
Return a 1 when commands complete: <code>*OPC?</code>	

- The purpose of this command is to synchronize your application with the instrument.
- Other commands cannot be executed until this command completes.

***OPT?**

Returns a string identifying any installed options. A 0 (zero) indicates no options are installed.

Parameter	Typical Return
(none)	OPT 760
Returns installed options <code>*OPT?</code>	

***RCL <0-9>**

Recalls a saved instrument state. This restores the instrument to a state that was previously stored in locations 0 through 9 with the `*SAV` command. All instrument states are recalled except: (1) the output state is set to OFF, (2) the trigger systems are set to the Idle state, (3) calibration is disabled, (4) all lists are set to their `*RST` values, and (5) the non-volatile settings are not affected.

Parameter	Typical Return
0 - 9	(none)
Recall state from location 1: <code>*RCL 1</code>	

- Location 0 is automatically recalled at power turn-on when the Output Power-On state is set to RCL 0.
- Stored instrument states are not affected by `*RST`.

***RST**

Resets the instrument to pre-defined values that are either typical or safe. These settings are described in [Reset State](#).

Parameter	Typical Return
(none)	(none)
Reset the instrument: <code>*RST</code>	

- `*RST` forces the ABORt commands. This cancels any measurement or transient actions presently in process. It resets the WTG-meas, MEAS-active, WTG-tran, and TRAN-active bits in the Operation Status registers.

***SAV <0-9>**

Saves the instrument state to one of ten non-volatile memory locations. For safety reasons, when a saved state is recalled, the output state will be set to OFF.

Parameter	Typical Return
0 - 9	(none)
Save state to location 1: *SAV 1	

- If a particular state is desired at power-on, it should be stored in location 0. Location 0 is automatically recalled at power turn-on when the Output Power-On state is set to RCL 0.
- Output state, List data, and the calibration state is NOT saved as part of the *SAV operation.
- Data saved in non-volatile memory, described under **Non-Volatile Settings**, is not affected by the *SAV command.
- When shipped, locations 0 through 9 are empty.

SRE <value>**SRE?**

Service request enable command and query. This sets the value of the Service Request Enable register. This determines which bits from the **Status Byte Register** are summed to set the Master Status Summary (MSS) bit and the Request for Service (RQS) summary bit. A 1 in any Service Request Enable register bit position enables the corresponding Status Byte register bit. All such enabled bits are then logically OR-ed to cause the MSS bit of the Status Byte register to be set. Refer to **Status Tutorial** for more information.

Parameter	Typical Return
A decimal value corresponding to the binary-weighted sum of the register's bits.	<bit value>
Enable bit 3 and bit 4 in the enable register: *SRE 24	

- When a serial poll is conducted in response to SRQ, the RQS bit is cleared, but the MSS bit is not. When *SRE is cleared (by programming it with 0), the power supply cannot generate an SRQ.

***STB?**

Status byte query. Reads the **Status Byte Register**, which contains the status summary bits and the Output Queue MAV bit. The Status Byte is a read-only register and the bits are not cleared when it is read. Refer to **Status Tutorial** for more information.

Parameter	Typical Return
(none)	<bit value>
Read status byte: *STB?	

***TRG**

Trigger command. Generates a trigger when the trigger subsystem has BUS selected as its source. The command has the same effect as the Group Execute Trigger (<GET>) command.

Parameter	Typical Return
(none)	(none)
Generates an immediate trigger: *TRG	

***TST?**

Self-test query. Performs a instrument self-test. If self-test fails, one or more error messages will provide additional information. Use SYSTem:ERRor? to read error queue. See [SCPI Error Messages](#) for more information.

Parameter	Typical Return
(none)	0 (pass) or +1 (failed)
Perform self-test: *TST?	

- The power-on self-test is the same self-test performed by *TST.
- *TST? also forces an *RST command.

***WAI**

Pauses additional command processing until all pending operations are complete. See [OPC](#) for more information.

Parameter	Typical Return
(none)	(none)
Wait until all pending operations complete. *WAI	

- *WAI can only be aborted by sending the instrument a Device Clear command.

INITiate Subsystem

Initiate commands initialize the trigger system. This moves the trigger system from the "idle" state to the "wait-for-trigger" state; which enables the instrument to receive triggers. An event on the selected trigger source causes the trigger to occur.

INITiate[:IMMediate]:ACQuire

INITiate[:IMMediate]:ELOG

INITiate[:IMMediate]:TRANsient

INITiate:ACQuire - Initiates the measurement trigger system.

INITiate:ELOG - Initiates external data logging.

INITiate:TRANsient - Initiates the transient trigger system.

Parameter	Typical Return
(none)	(none)
Initiate the measurement-trigger system: <code>INIT:ACQ</code>	

- It takes a few milliseconds for the instrument to be ready to receive a trigger signal after receiving the INITiate command.
- If a trigger occurs before the trigger system is ready for it, the trigger will be ignored. Check the WTG_meas bit in the operation status register to know when the instrument is ready.
- Use ABORt commands to return the instrument to Idle.

INITiate:CONTInuous:TRANsient 0|OFF|1|ON

INITiate:CONTInuous:TRANsient?

Continuously initiates the transient trigger system. This allows multiple triggers to generate multiple output transients.

Parameter	Typical Return
0 OFF 1 ON, *RST ON	0 or 1
Continually initiates the output trigger system: <code>INIT:CONT:TRAN ON</code>	

- With initiate continuous disabled, the output trigger system must be initiated for each trigger using the INITiate:TRANsient command.
- ABORt:TRANsient does not turn off continuous triggers if INITiate:CONTInuous:TRANsient ON has been programmed. In this case, the trigger system will automatically re-initiate.

INSTRument Subsystem

Instrument commands program the Primary/Secondary function of the instrument.

Primary/secondary operation is used when connecting a number of instruments in parallel to create a system with higher total current and, hence, higher power.

NOTE

In this document the terms “master” and “slave” have been replaced with “primary” and “secondary.” The previous firmware version INSTRument Subsystem command syntax is still supported in this and later firmware versions.

INSTRument:GROup:FUNction PRIMary|SECondary|NONE INSTRument:GROup:FUNction?

Set the function of an instrument in a primary/secondary configuration. This setting is saved in non-volatile memory.

PRIMary - Configures the instrument as the primary unit in a primary/secondary group.

SECondary - Configures the instrument as a secondary unit in a primary/secondary group.

NONE - disables the primary/secondary function. The unit operates independently.

Parameter	Typical Return
PRIMary SECondary NONE	PRIM, SEC, or NONE
Configures the instrument as the primary <code>INST:GRO:FUNC:PRIM</code>	

INSTRument:GROup:PRIMary:CONNect[::STATe] [,0|OFF|1|ON]

Instructs the primary unit to connect to the previously discovered secondary units. If the secondary configuration on the bus matches the discovered one, the primary will start normal operation. Otherwise the command will fail with an error, and all units will operate independently.

Parameter	Typical Return
optional 0 OFF 1 ON	0 or 1
Connect the primary to the secondary units <code>INST:GRO:PRIM:CONN</code>	

INSTRument:GROup:PRIMary:CONNect:DELay <value>|MIN|MAX INSTRument:GROup:PRIMary:CONNect:DELay? [MIN|MAX]

Set the delay after power-on before the primary unit attempts to connect to secondary units. This only applies if the connect mode is set to AUTO. This setting is saved in-volatile memory.

Parameter	Typical Return
0 to 120 seconds	0
Configures the connection delay for 10 seconds <code>INST:GRO:PRIM:CONN:DEL 10</code>	

INSTrument:GROup:PRIMary:CONNect:MODE AUTO|MANual **INSTrument:GROup:PRIMary:CONNect:MODE?**

Specifies the connection mode of the primary unit. This setting is saved in non-volatile memory.

AUTO - the primary unit will try to connect to the previously discovered secondary units at power-on.

MANual - the primary will connect to the previously discovered secondary units when it receives a connection command from the front panel or from INST:GROUP:PRIM:CONN.

Parameter	Typical Return
AUTO MANual	AUTO or MAN
Specifies automatic connection mode <code>INST:GRO:PRIM:CONN:MODE AUTO</code>	

INSTrument:GROup:PRIMary:DISCover

Instructs the primary unit to discover all secondary units connected to the primary/secondary bus.

Parameter	Typical Return
(none)	(none)
Discover all secondary units <code>INST:GRO:PRIM:DISC</code>	

INSTrument:GROup:PRIMary:RESet

Resets the primary-discovered secondary configuration. It disconnects any secondary-connected units and returns them to independent operation.

Parameter	Typical Return
(none)	(none)
Resets all secondary units <code>INST:GRO:PRIM:RES</code>	

INSTrument:GROup:SECondary:ADDRess <value>

Sets the secondary unit's bus address. Each secondary unit in a primary/secondary group must have a unique bus address or bus communication will fail. This setting is saved in non-volatile memory.

Parameter	Typical Return
1 - 19	1
Set the secondary unit's address to 1 <code>INST:GRO:SEC:ADDR 1</code>	

LIST Subsystem

List commands program an output sequence of multiple voltage or current settings. A comma-delimited list of up to 512 steps may be programmed. Note that these commands only apply in the presently active priority mode, either voltage priority or current priority.

[SOURce:]LIST:COUNT <value>|MIN|MAX|INFINITY
[SOURce:]LIST:COUNT? [MIN|MAX]

Sets the list repeat count. This sets the number of times that a list is executed before it completes. The count range is 1 through 4096. Infinity runs the list continuously.

Parameter	Typical Return
1 – 4096, *RST 1	<count>
Sets the list count to 10: LIST:COUN 10	

[SOURce:]LIST:CURREnt[:LEVel] <value>{,<value>}
[SOURce:]LIST:CURREnt[:LEVel]?
[SOURce:]LIST:VOLTage[:LEVel] <value>{,<value>}
[SOURce:]LIST:VOLTage[:LEVel]?

Specifies the setting for each list step. Values are specified in either amperes or volts.

Parameter	Typical Return
Voltage: 0 to 102% of rating Current: -102% to 102% of rating	<list value 1>,<list value 2>,<list value 3>
Programs a current list. The list contains 3 steps: LIST:CURR 3,2,1	
Programs a voltage list. The list contains 3 steps: LIST:VOLT 20,10,5	

[SOURce:]LIST:DWELL <value>{,<value>}
[SOURce:]LIST:DWELL?

Specifies the dwell time for each list step. Dwell time is the time that the output will remain at a specific step. Dwell times can be programmed from 0 through 262.144 seconds with the following resolution:

Range in seconds	Resolution
0 - 0.262144	1 microsecond
0.262144 - 2.62144	10 microseconds
2.62144 - 26.2144	100 microseconds
26.2144 - 262.144	1 millisecond

Parameter	Typical Return
0 – 262.144, *RST 1 ms	<list value 1>,<list value 2>,<list value 3>
Programs a dwell list. The list contains 3 steps: LIST:DWEL 0.2,0.8,1.6	

[SOURce:]LIST:CURRent:POINts?
[SOURce:]LIST:DWELL:POINts?
[SOURce:]LIST:VOLTage:POINts?
[SOURce:]LIST:TOUTput:BOStep:POINts?
[SOURce:]LIST:TOUTput:EOStep:POINts?

Returns the number of list points. Points are the same as steps. The queries do not return the point values.

Parameter	Typical Return
(none)	<points>
Returns the number of points in the dwell list: LIST:DWEL:POIN?	

[SOURce:]LIST:STEP ONCE|AUTO
[SOURce:]LIST:STEP?

Specifies how the list responds to triggers. **ONCE** causes the output to remain at the present step until a trigger advances it to the next step. Triggers that arrive during the dwell time are ignored. **AUTO** causes the output to automatically advance to each step, after the receipt of an initial starting trigger. Steps are paced by the dwell list. As each dwell time elapses, the next step is immediately output.

Parameter	Typical Return
ONCE AUTO, *RST AUTO	ONCE or AUTO
Specifies the list steps to be paced by trigger signals: LIST:STEP ONCE	

[SOURce:]LIST:TERMinate:LAST 0|OFF|1|ON
[SOURce:]LIST:TERMinate:LAST?

Determines the output value when the list terminates. When ON (1), the output voltage or current remains at the last list step. The value of the last voltage or current list step becomes the IMMEDIATE value when the list completes. When OFF (0), and also when the list is aborted, the output returns to the settings that were in effect before the list started.

Parameter	Typical Return
0 OFF 1 ON, *RST OFF	0 or 1
Terminate with the output at the last step value: LIST:TERM:LAST ON	

[SOURce:]LIST:TOUTput:BOSTep[:DATA] 0|OFF|1|ON {,0|OFF|1|ON}
[SOURce:]LIST:TOUTput:BOSTep[:DATA]?
[SOURce:]LIST:TOUTput:EOSTep[:DATA] 0|OFF|1|ON {,0|OFF|1|ON}
[SOURce:]LIST:TOUTput:EOSTep[:DATA]?

Specifies which list steps generate a trigger signal at the beginning of step (BOSTep) or end of step (EOSTep). A trigger is only generated when the state is set to ON. The trigger signal can be used as a trigger source for measurements and transients of other units, and for digital port pins configured as trigger outputs.

Parameter	Typical Return
0 OFF 1 ON	0 or 1
To generate triggers at the beginning of the second step of a 3-step list: LIST:TOUT:BOST OFF,ON,OFF	

LXI Subsystem

LXI:IDENtify[:STATe] 0|OFF|1|ON
LXI:IDENtify[:STATe]?

Turns the front panel LXI identify indicator on or off. When turned on, the "LAN" status indicator on the front panel blinks on and off to identify the instrument that is being addressed.

Parameter	Typical Return
0 OFF 1 ON, *RST OFF	0 or 1
To blink the front panel LXI indicator: LXI:IDEN ON	

LXI:MDNS[:STATe] 0|OFF|1|ON
LXI:MDNS[:STATe]?

Sets the MDNS state on or off.

Parameter	Typical Return
0 OFF 1 ON, *RST OFF	0 or 1
To set the MDNS state on: LXI:MDNS ON	

MEASure Subsystem

Measure commands measure the output voltage or current. They trigger the acquisition of new data before returning the reading. Measurements are performed by digitizing the instantaneous output voltage or current for a specified measurement time, storing the results in a buffer, and calculating the value for the specified measurement type.

MEASure[:SCALar]:CURRent[:DC]?

MEASure[:SCALar]:POWer[:DC]?

MEASure[:SCALar]:VOLTage[:DC]?

Initiates, triggers, and returns the averaged output measurement. Values returned are either in amperes, volts, or watts.

Parameter	Typical Return
(none)	<DC value>
Returns the measured DC current MEAS:CURR?	

MEASure[:SCALar]:CURRent:ACDC?

MEASure[:SCALar]:VOLTage:ACDC?

Initiates, triggers, and returns the total RMS measurement (AC + DC). Values returned are either in amperes, or volts.

Parameter	Typical Return
(none)	<ACDC value>
Returns the measured RMS voltage MEAS:VOLT:ACDC?	

MEASure[:SCALar]:CURRent:HIGH?

MEASure[:SCALar]:VOLTage:HIGH?

Initiates, triggers, and returns the High level of a pulse waveform. Values returned are either in amperes, or volts. See [Measurement Types](#).

Parameter	Typical Return
(none)	<HIGH value>
Returns the measured high level current MEAS:CURR:HIGH?	

MEASure[:SCALar]:CURRent:LOW?

MEASure[:SCALar]:VOLTage:LOW?

Initiates, triggers, and returns the Low level of a pulse waveform. Values returned are either in amperes, or volts. See [Measurement Types](#).

Parameter	Typical Return
(none)	<LOW value>
Returns the measured low level voltage <code>MEAS:VOLT:LOW?</code>	

MEASure[:SCALar]:CURRent:MAXimum?**MEASure[:SCALar]:VOLTage:MAXimum?****MEASure[:SCALar]:POWer:MAXimum?****MEASure[:SCALar]:CURRent:MINimum?****MEASure[:SCALar]:VOLTage:MINimum?****MEASure[:SCALar]:POWer:MINimum?**

Initiates, triggers, and returns the maximum or minimum values of a measurement. Values returned are either in amperes, volts, or watts.

Parameter	Typical Return
(none)	<MIN value>, <MAX value>
Returns the measured maximum current <code>MEAS:CURR:MAX?</code>	
Returns the measured minimum voltage <code>MEAS:VOLT:MIN?</code>	
Returns the measured maximum power <code>MEAS:POW:MAX?</code>	

MEASure:ARRay:CURRent[:DC]?**MEASure:ARRay:VOLTage[:DC]?****MEASure:ARRay:POWer[:DC]?**

Initiates and triggers a measurement; returns a list of the digitized output measurement samples. Values returned are either in amperes, volts, or watts.

The return format depends on the settings of the `FORMat:BORDER` and `FORMat[:DATA]` commands. When the data format is set to ASCII, returned values are comma separated. When the data format is set to REAL, data is returned as single precision floating point values in definite length arbitrary block response format.

Parameter	Typical Return
(none)	<value> [, <value>] or <Block>
Returns the measured current array <code>MEAS:ARR:CURR?</code>	

OUTPut Subsystem

The Output subsystem controls the output state, power-on, protection, and relay functions.

OUTPut [:STATe] 0|OFF|1|ON OUTPut[STATe]?

Enables or disables the output. The state of a disabled output is a condition of zero output voltage and zero source current. If a Keysight SD1000A SDS is connected, the SDS relays will open when the output is disabled and close when the output is enabled.

Parameter	Typical Return
0 OFF 1 ON, *RST OFF	0 or 1
Turns the output off: <code>OUTP OFF</code>	

- When output is enabled, the front-panel status indicator changes from **OFF** to indicate the operating status of the instrument (**CV**, **CC**, etc.).
- Separate delays can be programmed for the off-to-on and the on-to-off transition using `OUTPut:DElay:RISE` and `OUTput:DElay:FALL`.
- Because of internal circuit start-up procedures, `OUTPut ON` may take 12 milliseconds to complete its function in voltage priority mode, and 14 milliseconds in current priority mode. If a Keysight SD1000A SDS is connected, the start-up will take longer (see [Turn-On/Turn-Off Delays](#)).

OUTPut[:STATe]:COUPlE[:STATe] 0|OFF|1|ON OUTPut[:STATe]:COUPlE[:STATe]?

Enables or disables output coupling. Output coupling allows the outputs of multiple instruments to turn on and off sequentially according to their specified `OUTPut:DElay:RISE` and `OUTput:DElay:FALL` programming delays. This parameter is saved in non-volatile memory.

Parameter	Typical Return
0 OFF 1 ON	0 or 1
Turns the output coupling state on: <code>OUTP:COUP ON</code>	

- You must connect and configure the `ONCouple` and `OFFCouple` digital connector pins of all synchronized instruments as described in the [Output Couple Control](#) section.
- Because some power supplies have different minimum delay offsets, you must also specify a common delay offset for all of the synchronized units. This value must be the largest delay offset of the synchronized group. Use `OUTPut:COUPlE:MAX:DOFFset?` to query the delay offset for each unit. The largest value returned must be specified as the common delay offset for each unit.

OUTPut[:STATe]:COUPle:DOFFset <value>|MIN|MAX
OUTPut[:STATe]:COUPle:DOFFset? [MIN|MAX]

Sets a delay offset to synchronize coupled output state changes. Units are in seconds. Setting this time to the maximum delay offset specified for any instrument that is being coupled will cause all coupled outputs to synchronize to the turn-on times specified by OUTPut:DElay:RISE. This parameter is saved in non-volatile memory.

Parameter	Typical Return
0 to 1.023	<delay value>
Specifies a delay of 60 milliseconds: OUTP:COUP:DOFF 0.06	

OUTPut[:STATe]:COUPle:MAX:DOFFset?

Returns the delay offset required for this instrument. As a minimum, the OUTPut:COUPle:DElay:OFFSet value must be set to the maximum delay offset returned for any coupled output.

Parameter	Typical Return
(none)	<offset value>
Returns the maximum delay offset: OUTP:COUP:MAX:DOFF?	

OUTPut[:STATe]:DElay:FALL <value>|MIN|MAX
OUTPut[:STATe]:DElay:FALL? [MIN|MAX]
OUTPut[:STATe]:DElay:RISE <value>|MIN|MAX
OUTPut[:STATe]:DElay:RISE? [MIN|MAX]

Specifies the delay in seconds that the instrument waits before turning the output on (rise) or off (fall). This allows multiple instruments to turn on or off in sequence. The output will not turn on or off until its delay time has elapsed. This command affects on-to-off state transitions. It does NOT affect transitions to off caused by protection functions. Delay times can be programmed with the following resolution:

Range in seconds	Resolution	Range in seconds	Resolution
0 to 1.023E-4	100 nanoseconds	1.03E-1 to 1.023E+0	1 millisecond
1.03E-4 to 1.023E-3	1 microsecond	1.03E+0 to 1.023E+1	10 milliseconds
1.03E-3 to 1.023E-2	10 microseconds	1.03E+1 to 1.023E+2	100 milliseconds
1.03E-2 to 1.023E-1	100 microseconds	1.03E+2 to 1.023E+3	1 second

Note that both Rise and Fall commands use the same resolution; which is determined by whichever delay time (fall or rise) is the longest.

Parameter	Typical Return
0 - 1023, *RST 0	<delay value>

Sets a delay of 0.5 s before turning the output on: `OUTP:DEL:RISE 0.5`

- Each RPS model exhibits a minimum delay offset that applies from the time that a command to turn on the output is received until the output actually turns on. If you specify a turn-on delay, this delay will be added to the minimum delay offset, resulting in a turn-on delay that is actually longer than the one you programmed.
- Use `OUTput:COUPlE:MAX:DOFFset?` to query the delay offset that is required for each instrument.

OUTPut[:STATe]:TMODe:COUPlE 0|OFF|1|ON RP793xA, RP794xA **OUTPut[:STATe]TMODe:COUPlE?**

When coupling is enabled, changing the turn-on setting also changes the turn-off setting and vice-versa. If the turn-on and turn-off settings are not the same and coupling is enabled, the turn-off setting will be changed to agree with the turn-on setting.

Parameter	Typical Return
0 OFF 1 ON	0 or 1

Couples the Turn-on/turn/off modes: `OUTP:REL:LOCK ON`

OUTPut[:STATe]:TMODe[:OFF] HIGHZ | LOWZ RP793xA, RP794xA **OUTPut:TMODe:OFF?** **OUTPut[:STATe]:TMODe:ON HIGHZ | LOWZ** RP793xA, RP794xA **OUTPut:TMODe:ON?**

These commands set the output turn-on and turn-off behavior to Low impedance or High impedance.

Low Impedance - programs the output voltage to zero, then disconnects the output. Maximum negative current sinking occurs for up to 250 ms during the turn-off transition.

High Impedance - disconnects the output without actively sinking current.

Parameter	Typical Return
HIGHZ LOWZ	HIGHZ or LOWZ

Sets the turn-on state to high impedance: `OUTP:TMOD:ON HIGHZ`
Sets the turn-off state to low impedance: `OUTP:TMOD:OFF LOWZ`

- The turn-on/turn-off setting only applies when the RPS is operating in voltage priority mode. In current priority mode, the turn-on/turn-off behavior is always high impedance.

OUTPut:INHibit:MODE LATChing|LIVE|OFF OUTPut:INHibit:MODE?

Sets the operating mode of the remote inhibit digital pin. The inhibit function shuts down the output in response to an external signal on the Inhibit input pin. The Inhibit mode is stored in non-volatile memory. See [Programming the Digital Port](#).

LATChing - a logic-true signal on the Inhibit input causes the output state to latch OFF. The output remains disabled until the Inhibit input is returned to logic-false and the latched INH status bit is cleared by sending the OUTPut:PROTection:CLEar command or a protection clear command from the front panel.

LIVE - allows the enabled output to follow the state of the Inhibit input. When the Inhibit input is true, the output is disabled. When the Inhibit input is false, the output is re-enabled.

OFF - The Inhibit input is ignored.

Parameter	Typical Return
LATChing LIVE OFF	LATC, LIVE, or OFF
Sets the Inhibit Input to Live mode: <code>OUTP:INH:MODE LIVE</code>	

OUTPut:PON:STATe RST|RCL0 OUTPut:PON:STATe?

Sets the output power-on state. This determines whether the power-on state is set to the *RST state (RST) or the state stored in memory location 0 (RCL0). Instrument states can be stored using the *SAV command. This parameter is saved in non-volatile memory.

Parameter	Typical Return
RST RCL0	RST or RCL0
Sets the power-on state to the *RST state: <code>OUTP:PON:STAT RST</code>	

- If the power-on state is set to 0 with no state stored, a self-test error "file not found; 0 state" is generated and the instrument is set to the *RST state.
- If a primary **auto-connect** command fails, the power-on state is set to *RST.

OUTPut:PROTection:CLEar

Resets the latched protection. This clears the latched protection status that disables the output when a protection condition occurs (see [Programming Output Protection](#)).

Parameter	Typical Return
(none)	(none)
Clears the latched protection status: <code>OUTP:PROT:CLE</code>	

- All conditions that generate the fault must be removed before the latched status can be cleared. The output is restored to the state it was in before the fault condition occurred.
- If a protection shutdown occurs during an output list, the list continues running even though the output is disabled. When the protection status is cleared and the output becomes enabled again, the output will be set to the values of the step that the list is presently at.

OUTPut:PROTection:TEMPerature:MARGin?

Returns the minimum difference between the internal temperature sensors and the over-temperature trip level. The margin is returned in degrees Celsius.

Parameter	Typical Return
(none)	<margin value>
Returns the temperature margin: <code>OUTP:PROT:TEMP:MARG?</code>	

OUTPut:PROTection:WDOG[:STATe] 0|OFF|1|ON OUTPut:PROTection:WDOG[:STATe]?

Enables or disables the I/O watchdog timer. When enabled, the output will be disabled if there is no I/O activity on any remote interface within the time period specified by the `OUTPut:PROTection:WDOG:DELay` command. The output is latched off but the programmed output state is not changed.

Parameter	Typical Return
0 OFF 1 ON, *RST OFF	0 or 1
Enables the watchdog timer protection: <code>OUTP:PROT:WDOG ON</code>	

OUTPut:PROTection:WDOG:DELay <value>|MIN|MAX OUTPut:PROTection:WDOG:DELay? [MIN|MAX]

Sets the watchdog delay time. When the watchdog timer is enabled, the output is disabled if there is no SCPI I/O activity on any remote interface (USB, LAN, GPIB) within the delay time. The watchdog timer function is NOT reset by activity on the front panel - the output will still shut down after the time period has elapsed. Programmed values can range from 1 to 3600 seconds in 1 second increments.

Parameter	Typical Return
0 - 3600, *RST 60 seconds	<delay value>
Sets a watchdog delay for 600 seconds: <code>OUTP:PROT:WDOG:DEL 600</code>	

OUTPut:RELy:LOCK[:STATe] 0|OFF|1|ON
OUTPut:RELy:LOCK[:STATe]?

Enables or disables the locked relay-state of the Keysight SD1000A Safety Disconnect System. When locked, the output relays of the SDS remain closed and do not change along with the output state of the power supply. This improves the output response time for applications that do not require a physical output disconnect during normal output on/off operation. This parameter is saved in non-volatile memory.

Parameter	Typical Return
0 OFF 1 ON	0 or 1
Locks the SDS relays closed: <code>OUTP:REL:LOCK ON</code>	

POWer Query**[SOURce:]POWer:LIMit?**

Returns the power limit of the instrument in Watts, either 5 kW or 10 kW.

Parameter	Typical Return
None	5,000 or 10,000
Return the power limit: POWer:LIMit?	

SENSe Subsystem

Sense commands control the current measurement ranges and window as well as the data acquisition sequence.

SENSe:AHOuR:RESet SENSe:WHOuR:RESet

Resets the amp-hour or watt-hour measurement to zero.

Parameter	Typical Return
(none)	(none)
Resets the amp-hour measurement: SENS:AHO:RES Resets the watt-hour measurement: SENS:WHO:RES	

SENSe:ELOG:FUNcTION:CURRent 0|OFF|1|ON SENSe:ELOG:FUNcTION:CURRent? SENSe:ELOG:FUNcTION:VOLTage 0|OFF|1|ON SENSe:ELOG:FUNcTION:VOLTage?

Enables or disables the Elog current or voltage measurement function.

Parameter	Typical Return
0 OFF 1 ON, *RST OFF	0 or 1
Enables datalog current measurements: SENS:ELOG:FUNC:CURR ON	

SENSe:ELOG:FUNcTION:CURRent:MINMax 0|OFF|1|ON SENSe:ELOG:FUNcTION:CURRent:MINMax? SENSe:ELOG:FUNcTION:VOLTage:MINMax 0|OFF|1|ON SENSe:ELOG:FUNcTION:VOLTage:MINMax?

Enables or disables logging of the minimum and maximum current or voltage values.

Parameter	Typical Return
0 OFF 1 ON, *RST OFF	0 or 1
Enables MIN/MAX logging values: SENS:ELOG:FUNC:VOLT:MINM ON	

SENSe:ELOG:PERiod <value>|MIN|MAX SENSe:ELOG:PERiod? [MIN|MAX]

Sets the integration time of an Elog measurement.

Although the absolute minimum logging period is 102.4 microseconds, the actual minimum varies as a function of the number of readings that are being logged (see [Integration Period](#)).

Parameter	Typical Return
0.0001024 to 60, *RST MAX	<period>
Specifies a datalog period of 0.01 seconds: <code>SENS:ELOG:PER 0.01</code>	

SENSe:FUNCTION:CURRENT 0|OFF|1|ON

SENSe:FUNCTION:CURRENT?

SENSe:FUNCTION:VOLTage 0|OFF|1|ON

SENSe:FUNCTION:VOLTage?

Enables or disables current or voltage measurements.

Parameter	Typical Return
0 OFF 1 ON, *RST ON	0 or 1
Enables current measurements: <code>SENS:FUNC:CURR ON</code> Disables voltage measurements: <code>SENS:FUNC:VOLT OFF</code>	

SENSe:SWEep:NPLCycles <value>|MIN|MAX

SENSe:SWEep:NPLCycles? [MIN|MAX]

Sets the measurement time in number of power line cycles. Increasing the number of power line cycles reduces the measurement noise on current and voltage measurements. Changing the NPLC changes the number of points and time interval setting. The number of points in 1 NPLC depends on the line frequency setting (see [SYSTEM:LFR:MODE](#)).

Parameter	Typical Return
0.0003072 to 1,258,290,000,000, *RST 1	<NPLC value>
Specifies 100 power line cycles: <code>SENS:SWE:NPLC 100</code>	

SENSe:SWEep:OFFSet:POINTs <value>|MIN|MAX

SENSe:SWEep:OFFSet:POINTs? [MIN|MAX]

Defines the offset in a data sweep for triggered measurements. Positive values represent the delay after the trigger occurs but before the samples are acquired. Negative values represent data samples taken prior to the trigger.

Parameter	Typical Return
-524,287 to 2,000,000,000, *RST 0	<offset points>
Specifies -2048 offset points: <code>SENS:SWE:OFFS:POIN -2048</code>	

SENSe:SWEep:POINts <value>|MIN|MAX
SENSe:SWEep:POINts? [MIN|MAX]

Defines the number of points in a measurement. The number of points depends on the line frequency (50 Hz or 60 Hz). The default number of points result in a measurement of 1 NPLC.

Parameter	Typical Return
1 to 524,288 MIN MAX, *RST 3255 (60 Hz); 3906 (50 Hz)	<points>
Specifies 2048 points: SENS:SWE:POIN 2048	

SENSe:SWEep:TINterval <value>|MIN|MAX
SENSe:SWEep:TINterval? [MIN|MAX]

Defines the time period between measurement samples. Units are in seconds. Values are rounded to the nearest 20.48 microsecond increment. Below 20.48 microseconds, values are rounded to the nearest 10.24 or 5.12 microsecond increment respectively.

Parameter	Typical Return
0.00000512 to 40,000, *RST 0.00000512	<time interval>
Specifies an interval of 1 ms between points: SENS:SWE:TINT 0.001	

SENSe:WINDow[:TYPE] HANNing|RECTangular
SENSe:WINDow[:TYPE]?

Selects the measurement window. This sets a signal conditioning function used in scalar DC measurement calculations. Neither window function alters the instantaneous voltage or current data returned in the measurement array.

Hanning window is a "raised cosine" function. It is a signal conditioning function that reduces errors in DC measurement calculations in the presence of periodic signals such as AC line ripple. This window only works up to 4883 measurement points. The instrument will revert to a rectangular window when the points exceed 4883.

Rectangular window returns measurement calculations with no signal conditioning.

Parameter	Typical Return
HANNing RECTangular, *RST RECTangular	RECT or HANN
Specifies a Hanning window function: SENS:WIND HANN	

[SOURce] Subsystem

The SOURce keyword is optional in many commands that set parameters for a source or output, such as [SOURce:]CURRent <value>.

Because SOURce subsystem commands are often used without the optional SOURce keyword, these commands are listed by their individual subsystems, below:

Subsystems and Commands Using the Optional [SOURce:] Keyword

ARB

CURRent

DIGital

FUNction

LIST

POWer:LIMit

STEP:TOUTput

VOLTage

STATus Subsystem

Status register programming lets you determine the operating condition of the instrument at any time. The instrument has three groups of status registers; Operation, Questionable, and Standard Event. The Operation and Questionable status groups each consist of the Condition, Enable, and Event registers as well as NTR and PTR filters.

The Status subsystem is also programmed using Common commands. Common commands control additional status functions such as the Service Request Enable and the Status Byte registers. Refer to [Status Tutorial](#) for more information.

STATus:OPERation[:EVENT]

Queries the **event register** for the **Operation Status** group. This is a read-only register, which stores (latches) all events that are passed by the Operation NTR and/or PTR filter. Reading the Operation Status Event register clears it.

Parameter	Typical Return
(none)	<bit value>
Read the operation status event register: STAT:OPER?	

- The value returned is the binary-weighted sum of all enabled bits in the register. For example, with bit 3 (value 8) and bit 5 (value 32) set and enabled, the query returns +40.
- *RST has no effect on this register.

STATus:OPERation:CONDition?

Queries the **condition register** for the **Operation Status** group. This is a read-only register, which holds the live (unlatched) operational status of the instrument. Reading the Operation Status Condition register does not clear it.

Parameter	Typical Return
(none)	<bit value>
Read the operation status condition register: STAT:OPER:COND?	

- The value returned is the binary-weighted sum of all enabled bits in the register. For example, with bit 3 (value 8) and bit 5 (value 32) set and enabled, the query returns +40.
- The condition register bits reflect the current condition. If a condition goes away, the corresponding bit is cleared.
- *RST clears this register, other than those bits where the condition still exists after *RST.

STATus:OPERation:ENABLE <value>**STATus:OPERation:ENABLE?**

Sets the value of the **enable register** for the **Operation Status** group. The enable register is a mask for enabling specific bits from the Operation Event register to set the OPER (operation summary) bit of the Status Byte register. STATus:PRESet clears all bits in the enable register.

Parameter	Typical Return
A decimal value corresponding to the binary-weighted sum of the register's bits.	<bit value>
Enable bit 3 and 4 in the enable register: STAT:OPER:ENAB 24	

- For example, with bit 3 (value 8) and bit 5 (value 32) set and enabled, the query returns +40.
- *CLS does not clear the enable register, but does clear the **event register**.

STATus:OPERation:NTRansition <value>**STATus:OPERation:NTRansition?****STATus:OPERation:PTRansition <value>****STATus:OPERation:PTRansition?**

Sets and queries the value of the **NTR** (Negative-Transition) and **PTR** (Positive-Transition) registers. These registers serve as a polarity filter between the Operation Condition and Operation Event registers.

When a bit in the NTR register is set to 1, then a 1-to-0 transition of the corresponding bit in the Operation Condition register causes that bit in the Operation Event register to be set.

When a bit in the PTR register is set to 1, then a 0-to-1 transition of the corresponding bit in the Operation Condition register causes that bit in the Operation Event register to be set.

STATus:PRESet sets all bits in the PTR registers and clears all bits in the NTR registers.

Parameter	Typical Return
A decimal value corresponding to the binary-weighted sum of the register's bits.	<bit value>
Enable bit 3 and 4 in the NTR register: STAT:OPER:NTR 24	
Enable bit 3 and 4 in the PTR register: STAT:OPER:PTR 24	

- If the same bits in both NTR and PTR registers are set to 1, then any transition of that bit at the Operation Condition register sets the corresponding bit in the Operation Event register.
- If the same bits in both NTR and PTR registers are set to 0, then no transition of that bit at the Operation Condition register can set the corresponding bit in the Operation Event register.
- The value returned is the binary-weighted sum of all enabled bits in the register.

STATus:PRESet

Presets all Enable, PTR, and NTR registers.

Operation register	Questionable register	Preset setting
STAT:OPER:ENAB	STAT:QUES<1 2>:ENAB	all defined bits are disabled
STAT:OPER:NTR	STAT:QUES<1 2>:NTR	all defined bits are disabled
STAT:OPER:PTR	STAT:QUES<1 2>:PTR	all defined bits are enabled

Parameter	Typical Return
(none)	(none)

Preset the Operation and Questionable registers: STAT:PRES

STATus:QUEStionable<1|2>[:EVENT]?

Queries the **event register** for the **Questionable Status** group. This is a read-only register, which stores (latches) all events that are passed by the Operation NTR and/or PTR filter. Reading the Questionable Status Event register clears it.

Parameter	Typical Return
(none)	<bit value>

Read questionable status event register #1: STAT:QUES1?

- The value returned is the binary-weighted sum of all enabled bits in the register. For example, with bit 2 (value 4) and bit 4 (value 16) set, the query returns +20.
- *RST has no effect on this register.

STATus:QUEStionable<1|2>:CONDition?

Queries the **condition register** for the **Questionable Status** group. This is a read-only register, which holds the live (unlatched) operational status of the instrument. Reading the Questionable Status Condition register does not clear it.

Parameter	Typical Return
(none)	<bit value>

Read questionable status condition register #1: STAT:QUES1:COND?

- The value returned is the binary-weighted sum of all enabled bits in the register. For example, with bit 2 (value 4) and bit 4 (value 16) set, the query returns +20.
- The condition register bits reflect the current condition. If a condition goes away, the corresponding bit is cleared.
- *RST clears this register, other than those bits where the condition still exists after *RST.

STATus:QUESTionable<1|2>:ENABLE <value>
STATus:QUESTionable<1|2>:ENABLE?

Sets the value of the **enable register** for the **Questionable Status** group. The enable register is a mask for enabling specific bits from the Operation Event register to set the QUES (questionable summary) bit of the Status Byte register. STATus:PRESet clears all bits in the enable register.

Parameter	Typical Return
A decimal value corresponding to the binary-weighted sum of the register's bits.	<bit value>
Enable bit 2 and 4 in the questionable enable register #1: STAT:QUES1:ENAB 24	

- For example, with bit 2 (value 4) and bit 4 (value 16) set, the query returns +20.
- *CLS does not clear the enable register, but does clear the **event register**.

STATus:QUESTionable<1|2>:NTRansition <value>
STATus:QUESTionable<1|2>:NTRansition?
STATus:QUESTionable<1|2>:PTRansition <value>
STATus:QUESTionable<1|2>:PTRansition?

Sets and queries the value of the **NTR** (Negative-Transition) and **PTR** (Positive-Transition) registers. These registers serve as a polarity filter between the Questionable Condition and Questionable Event registers.

When a bit in the NTR register is set to 1, then a 1-to-0 transition of the corresponding bit in the Questionable Condition register causes that bit in the Questionable Event register to be set.

When a bit in the PTR register is set to 1, then a 0-to-1 transition of the corresponding bit in the Questionable Condition register causes that bit in the Questionable Event register to be set.

STATus:PRESet sets all bits in the PTR registers and clears all bits in the NTR registers.

Parameter	Typical Return
A decimal value corresponding to the binary-weighted sum of the register's bits.	<bit value>
Enable bit 3 and 4 in the questionable NTR register #1: STAT:QUES:NTR 24	
Enable bit 3 and 4 in the questionable PTR register #1: STAT:QUES:PTR 24	

- If the same bits in both NTR and PTR registers are set to 1, then any transition of that bit at the Questionable Condition register sets the corresponding bit in the Questionable Event register.
- If the same bits in both NTR and PTR registers are set to 0, then no transition of that bit at the Questionable Condition register can set the corresponding bit in the Questionable Event register.
- The value returned is the binary-weighted sum of all enabled bits in the register.

STEP Command

[SOURce:]STEP:TOUTput 0|OFF|1|ON

[SOURce:]STEP:TOUTput?

Specifies whether a trigger out is generated when a transient step occurs. A trigger is generated when the state is on (true).

Parameter	Typical Return
0 OFF 1 ON, *RST OFF	0 or 1
Sets the step trigger signal to ON: STEP:TOUT ON	

SYSTem Subsystem

System commands control system functions that are not directly related to output control, measurement, or status functions. Note that IEEE-488 Common commands also control system functions such as self-test, saving and recalling states, and others. SYSTem:SDS commands program the Keysight SD1000A Safety Disconnect System.

SYSTem:COMMunicate:LAN:CONTrol? SYSTem:COMMunicate:TCPIP:CONTrol?

Returns the initial socket control connection port number. This connection is used to send and receive commands and queries. Unlike the data socket, which uses a fixed port number, the control socket port number varies and must be obtained using these queries.

Parameter	Typical Return
(none)	<port #> (0 if sockets not supported)

Query the Control connection port number:
SYST:COMM:LAN:CONT? or SYST:COMM:TCP:CONT?

SYSTem:COMMunicate:RLState LOCAL|REMOte|RWLock SYSTem:COMMunicate:RLState?

Configures the remote/local state of the instrument. Remote and local do the same thing and are included for compatibility with other products. **LOCAL** sets instrument to front panel control. **REMOte** sets the instrument to front panel control. **RWLock** disables the front panel keys. The instrument can only be controlled via the remote interface. This programmable setting is completely independent from the front panel lock/unlock function.

Parameter	Typical Return
LOCAL REMOte RWLock , *RST LOCAL	LOC, REM, or RWL

Sets the remote/local state to remote: SYST:COMM:RLST REM

- The remote/local state is unaffected by *RST or any SCPI commands other than SYSTem:COMMunicate:RLState.
- The remote/local instrument state can also be set by other interface commands over the GPIB and some other I/O interface.
- When multiple remote programming interfaces are active, the interface with the most recently changed remote/local state determines the instrument's remote/local state.

SYSTem:DATE <yyyy>, <mm>, <dd> SYSTem:DATE?

Sets the date of the system clock. Specify the year (2000 to 2099), month (1 to 12), and day (1 to 31). The real time clock is only used in conjunction with the Keysight 14585A Control and Analysis software.

Parameter	Typical Return
<yyyy>,<mm>,<dd>	+2018,+04,+30
Set the date to June 30, 2018: SYST:DATE 2018,06,30	

- The real-time clock does not adjust itself for time zone changes or daylight savings time.

SYSTem:ERRor?

Reads and clears one error from the error queue.

Parameter	Typical Return
(none)	<+0,"No error">
Reads and clear first error in error queue: SYST:ERR?	

- The front-panel ERR annunciator turns on when one or more errors are currently stored in the error queue. Error retrieval is first-in-first-out (FIFO), and errors are cleared as you read them. When you have read all errors from the error queue, the ERR annunciator turns off.
- If more than 20 errors have occurred, the last error stored in the queue (the most recent error) is replaced with -350,"Error queue overflow". No additional errors are stored until you remove errors from the queue. If no errors have occurred when you read the error queue, the instrument responds with +0,"No error".
- The error queue is cleared by the *CLS and when power is cycled. It is not cleared by a *RST.
- Errors have the following format (the error string may contain up to 255 characters).
<error code>,<error string>
For a list of error codes and message strings, see [SCPI Error Messages](#).

SYSTem:LFRrequency?

Returns the power-line reference frequency. This determines the integration time used by [SENSe:SWEep:NPLC](#) command.

At power-on, if the line frequency mode is set to Auto, the power supply automatically detects the power-line frequency (50 Hz or 60 Hz) and uses this value to determine the integration time used.

If the auto line detect fails because the line is noisy or out of tolerance, it uses a setting of 60 Hz.

Parameter	Typical Return
(none)	50 or 60

Parameter	Typical Return
Query the power line frequency: SYST:LFR?	

SYSTem:LFRequency:MODE AUTO|MAN50|MAN60 SYSTem:LFRequency:MODE?

Specifies automatic or manual line frequency detection.

AUTO specifies automatic detection.

MAN50 specifies a setting of 50 Hz.

MAN60 specifies a setting of 60 Hz.

This parameter is saved in non-volatile memory.

Parameter	Typical Return
AUTO MAN50 MAN60	AUTO, MAN50, or MAN60
Sets the line frequency mode to 60 Hz: SYST:LFR:MODE MAN60	

SYSTem:PASSword:FPANel:RESet

Resets the front panel lockout password to zero. This command does not reset the calibration password.

Parameter	Typical Return
(none)	<+0,"No error">
Resets the front panel password: SYST:PASS:FPAN:RES	

SYSTem:REBoot

Reboots the instrument to its power-on state.

Parameter	Typical Return
(none)	(none)
Reboots the instrument: SYST:REB	

SYSTem:SDS:CONNect RP795xA, RP796xA

Connects the power supply to the Keysight SD1000A SDS unit. This command is used when the SDS connect mode is set to MANual.

Parameter	Typical Return
(none)	(none)
Connect the SDS unit: SYST:SDS:CONN	

SYSTem:SDS:CONNect:MODE AUTO|MANual RP795xA, RP796xA **SYSTem:SDS:CONNect:MODE?**

Specifies the connection method to the SDS unit at turn-on. This setting is non-volatile.

AUTO - automatically connect the SDS unit to the power supply at turn-on.

MANual - wait for a front panel or SCPI command to connect the SDS to the power supply.

Parameter	Typical Return
AUTO MANual	AUTO or MAN
Sets the connect mode to manual: SYST:SDS:CONN:MODE MAN	

SYSTem:SDS:DIGital:DATA:INPut? RP795xA, RP796xA

Returns the SDS input state. The bits indicate the state of the SDS external input signals.

Bit	Description	Bit	Description
0	Estop is activated, the power supply is inhibited	2	The remote start is active
1	The cover is open, the power supply is inhibited	3	The relay control mode is set to external

Parameter	Typical Return
(none)	<integer>
Return the state of the SDS inputs: SYST:SDS:DIG:DATA:INP?	

SYSTem:SDS:DIGital:DATA:OUTPut 0|1 RP795xA, RP796xA **SYSTem:SDS:DIGital:DATA:OUTPut?**

Send an integer whose bits set the state of the SDS external output signals - either on or off. At present there is only one digital output signal available - on the **DI/DO** connector. This setting is volatile and is not part of the instrument saved state.

Parameter	Typical Return
0 1, *RST 0	0 or 1
Sets the state of the external signals on: SYST:SDS:DIG:DATA:OUTP 1	

SYSTem:SDS:ENABle 0|OFF|1|ON RP795xA, RP796xA **SYSTem:SDS:ENABle?**

The SDS must be enabled to allow the power supply to communicate with it. This is a non-volatile setting.

Parameter	Typical Return
0 OFF 1 ON	0 or 1
Enables the SDS unit: SYST:SDS:ENAB ON	

SYSTem:SDS:STATus? RP795xA, RP796xA

Returns the protection status of the SDS unit. The integer bits indicate the reason for the SDS protection.

Bit	Description
0	A power supply-to-SDS communication failure
1	AC contact fault - the AC contact input is not active
2	An Internal SDS hardware failure

These faults can only be cleared by turning off the power supply, correcting the problem and rebooting the power supply.

Parameter	Typical Return
(none)	<integer>
Return the status of the SDS unit: SYST:SDS:STAT?	

SYSTem:SECurity:IMMEDIATE

Clears all user memory and reboots the instrument. This command is typically used to prepare the instrument for removal from a secure area. It sanitizes all user data. It writes all zeros to flash memory and then performs a chip erase as per manufacturer's data sheet. Identification data (instrument firmware, model number, serial number, MAC address and calibration data) is not erased. After the data is cleared, the instrument is rebooted.

This procedure is not recommended for use in routine applications because of the possibility of unintended loss of data.

Parameter	Typical Return
(none)	(none)
Sanitizes the instrument: SYST:SEC:IMM	

SYSTem:SET <block data> SYSTem:SET?

Get and set the instrument state. The query form of the command returns a definite length block that contains the instrument state. This block data can be sent back to the instrument to restore it to the state in the block.

Parameter	Typical Return
<block data>	<block data>
Sends the block data back to the instrument: SYST:SET <block data>	

SYSTem:TIME <hh>, <mm>, <ss>

SYSTem:TIME?

Sets the time of the system clock. Specify hours (0 to 23), minutes (0 to 59), and seconds (0 to 59). The real time clock is only used in conjunction with the Keysight 14585A Control and Analysis software.

Parameter	Typical Return
<hh>,<mm>,<ss>	<hh,mm,ss>
Set the clock to 8:30 PM: SYST:TIME2018,06,30	

SYSTem:VERSion?

Returns the SCPI version that the instrument complies with. Cannot be determined from front panel.

Parameter	Typical Return
(none)	<"version">
Return the SCPI version: SYST:VERS?	

- The command returns a string in the form "YYYY.V", where YYYY represents the year of the version and V represents a version for that year.

TRIGger Subsystem

Trigger commands control the transient and acquisition subsystems. Refer to [Trigger Overview](#) for more information.

TRIGger:ACQuire[:IMMEDIATE]

TRIGger:ELOG[:IMMEDIATE]

TRIGger:TRANSient[:IMMEDIATE]

Generates an immediate trigger. This overrides any selected trigger source.

TRIGger:ACQuire triggers the acquisition system.

TRIGger:ELOG triggers the external datalogger.

TRIGger:TRANSient triggers the transient system.

Parameter	Typical Return
(none)	(none)

Generate a measurement trigger: TRIG:ACQ

TRIGger:ACQuire:CURREnt[:LEVel] <value>|MIN|MAX

TRIGger:ACQuire:CURREnt[:LEVel]? [MIN|MAX]

TRIGger:ACQuire:VOLTage[:LEVel] <value>|MIN|MAX

TRIGger:ACQuire:VOLTage[:LEVel]? [MIN|MAX]

Sets the triggered level of the output. Applies when the measurement trigger source is set to a level. Values are specified in either amperes or volts. The minimum and maximum values depend on the ratings of the unit.

Parameter	Typical Return
Voltage: 0 to 102% of rating, *RST 0 Current: -102% to 102% of rating	<level value>

Set the triggered current level to 3 A: TRIG:ACQ:CURREnt 3
Set the triggered voltage level to 50 V: TRIG:ACQ:VOLTage 50

TRIGger:ACQuire:CURREnt:SLOPe POSitive|NEGative

TRIGger:ACQuire:CURREnt:SLOPe?

TRIGger:ACQuire:VOLTage:SLOPe POSitive|NEGative

TRIGger:ACQuire:VOLTage:SLOPe?

Sets the slope of the signal. Applies when the measurement trigger source is set to a level. **POSitive** specifies a rising slope of the output signal. **NEGative** specifies a falling slope of the output signal.

Parameter	Typical Return
POSitive NEGative, *RST POSitive	POS or NEG
Set current slope to negative (falling edge): TRIG:ACQ:CURR:SLOP NEG Set voltage slope to negative (falling edge): TRIG:ACQ:VOLT:SLOP NEG	

TRIGger:ACQuire:INDices[:DATA]?

Returns the indices into the acquired data where triggers were captured during the acquisition. The number of indices returned is the same as the value returned by TRIGger:ACQuire:INDices:COUNT?

Parameter	Typical Return
(none)	<time>
Returns the number of indices: TRIG:ACQ:IND?	

TRIGger:ACQuire:INDices:COUNT?

Returns the number of triggers captured during the acquisition.

Parameter	Typical Return
(none)	<time>
Return the number of triggers: TRIG:ACQ:IND:COUN?	

TRIGger:ACQuire:TOUTput[:ENABLE] 0|OFF|1|ON TRIGger:ACQuire:TOUTput[:ENABLE]?

Enables measurement triggers to be sent to a digital port pin. The digital port pin must be configured as trigger output before it can be used as a trigger source (see [External Trigger I/O](#)).

Parameter	Typical Return
0 OFF 1 ON, *RST OFF	0 or 1
Enable sending measurement triggers to digital pins: TRIG:ACQ:TOUT ON	

TRIGger:ACQuire:SOURce <source> TRIGger:ACQuire:SOURce?

Selects the trigger source for the acquisition system:

BUS	Selects a remote interface trigger command.
CURRent1	Selects an output current level.
EXTernal	Selects ALL digital port pins that have been configured as trigger sources.
PIN<1-7>	Selects a digital port pin configured as a trigger input.
TRANSient1	Selects the transient system as the trigger source.
VOLTage1	Selects an output voltage level.

5 SCPI Programming Reference

Parameter	Typical Return
BUS CURRent1 EXTernal PIN<1-7> TRANsient1 VOLTage1, *RST BUS	BUS, CURR1, EXT, PIN<n>, TRAN1, or VOLT1
Select digital port pin 1 as the measurement trigger source: TRIG:ACQ:SOUR PIN1	

TRIGger:ARB:SOURce <source>

TRIGger:ARB:SOURce?

TRIGger:ELOG:SOURce <source>

TRIGger:ARB:SOURce?

TRIGger:TRANsient:SOURce <source>

TRIGger:TRANsient:SOURce?

TRIG:ARB:SOURce - Selects the trigger source for arbitrary waveforms:

TRIG:ELOG:SOURce - Selects the trigger source for external data logging:

TRIG:TRANsient:SOURce - Selects the trigger source for the transient system:

- BUS** Selects a remote interface trigger command.
- EXTernal** Selects ALL digital port pins that have been configured as trigger sources.
- IMMediate** Triggers the transient as soon as it is INITiated.
- PIN<1-7>** Selects a digital port pin configured as a trigger input.

Parameter	Typical Return
BUS EXTernal IMMediate PIN<1-7> *RST BUS	BUS, EXT, IMM, PIN<n>
Select digital port pin 1 as the Arb trigger source: TRIG:ARB:SOUR PIN1	
Select digital port pin 1 as the transient trigger source: TRIG:TRAN:SOUR PIN1	

VOLTage Subsystem

Voltage commands program the output voltage of the instrument.

[SOURce:]VOLTage[:LEVel][:IMMediate][:AMPLitude] <value>|MIN|MAX
[SOURce:]VOLTage[:LEVel][:IMMediate][:AMPLitude]? [MIN|MAX]
[SOURce:]VOLTage[:LEVel]:TRIGgered[:AMPLitude] <value>|MIN|MAX
[SOURce:]VOLTage[:LEVel]:TRIGgered[:AMPLitude]? [MIN|MAX]

Sets the immediate or triggered voltage level when the output is operating in voltage priority mode. The triggered level is the value that is transferred to the output when an output Step is triggered. Units are in volts. The maximum value depends on the voltage rating of the unit.

Parameter	Typical Return
0.1% to 102% of rating, *RST 0.1% of rating	<voltage level>
Sets the output voltage to 20 V: <code>VOLT 20</code> Sets the triggered voltage to 10 V: <code>VOLT:TRIG 10</code>	

[SOURce:]VOLTage:BWIDth LOW|HIGH1 RP795xA, RP796xA
[SOURce:]VOLTage:BWIDth?

NOTE

This command is provided for backward compatibility with previous RP795xA and RP796xA units. Newer units should use the `VOLT:BWID:RANG` command.

Sets the voltage compensation. This lets you optimize output response time with capacitive loads. These compensation modes only apply when the unit is operating in constant voltage (CV), both in voltage priority and in current priority (when in voltage limit).

Parameter	Description
LOW (0)	Optimized for stability with a wide range of output capacitors.
HIGH1 (1)	Provides maximum up-programming speed as well as the fastest transient response time when the output capacitance is restricted to small values. Refer to Set the Output Bandwidth for specific capacitive load limits.

Parameter	Typical Return
LOW HIGH1, *RST HIGH1	LOW or HIGH1
Sets the voltage bandwidth to Low: <code>VOLT:BWID LOW</code>	

[SOURce:]VOLTage:BWIDth:LEVel 0 | 1 | 2, <value>|MIN|MAX
[SOURce:]VOLTage:BWIDth:LEVel? 0 | 1 | 2, [MIN|MAX]

Sets the programming pole frequency associated with each voltage priority compensation range. The value is in Hertz. The default frequency is optimized for maximum up-programming speed as well as the fastest transient response time. It can be reduced to compensate for output overshoots.

Parameter	Typical Return
0 1 2	0, 1, or 2
200 to 500,000 for RP795xA and RP796xA range 0, *RST 200 17,000 to 500,000 for RP795xA and RP796xA range 1, #RST 17,000 10 to 100,000 for RP793xA and RP794xA range 0, *RST 1,400 10 to 100,000 for RP793xA and RP794xA range 1, *RST 460 10 to 100,000 for RP793xA and RP794xA range 2, *RST 55	<pole frequency>
Sets the voltage bandwidth to 1, frequency 10 kHz: VOLT:BWID:LEV 1, 10,000	

[SOURce:]VOLTage:BWIDth:RANGe 0 | 1 | 2 [SOURce:]VOLTage:BWIDth:RANGe?

Sets the voltage compensation. This lets you optimize output response time with capacitive loads. These compensation modes only apply when the unit is operating in constant voltage (CV), both in voltage priority and in current priority (when in voltage limit). Refer to [Set the Output Bandwidth](#) for information about the effect that the compensation settings have on the Programming Speed Characteristics.

RP795xA/ RP796xA Parameter	Description
0 (Low speed)	Optimized for stability with a wide range of output capacitors.
1 (High speed)	Provides maximum up-programming speed as well as the fastest transient response time when the output capacitance is restricted to small values. Refer to Set the Output Bandwidth for specific capacitive load limits.

RP793xA/ RP794xA Parameter	Description
0 (High speed/Small capacitive load)	Provides the fastest programming speed and transient response time
1 (Medium speed/Medium capacitive load)	Provides intermediate programming speed and transient response time. setting is optimized for stability with a wide range of output capacitors.
2 (Slow speed/Large capacitive load)	Best suited for DUTs with high capacitance/low ESR with the trade-off of a slower programming speed and transient response

Parameter	Typical Return
0 1 2, *RST 0	0, 1, or 2
Sets the voltage bandwidth to comp 1: VOLT:BWID:RANG 1	

[SOURce:]VOLTage:LIMit[:POSitive][:IMMEDIATE][:AMPLitude] <value>|MIN|MAX [SOURce:]VOLTage:LIMit[:POSitive][:IMMEDIATE][:AMPLitude]? [MIN|MAX]

Sets the voltage limit when in current priority mode. Units are in volts.

Parameter	Typical Return
0.1% to 102% of rating, *RST 1% of rating	<voltage limit>
Sets the voltage limit to 20 V: VOLT:LIM 20	

[SOURce:]VOLTage:LIMit:LOW <value>|MIN|MAX
[SOURce:]VOLTage:LIMit:LOW? [MIN|MAX]

Sets the low voltage limit when in current priority mode. This prevents the voltage from dropping below the low voltage limit when discharging a battery. When the voltage drops to the specified low limit value, the output transitions from current priority to negative voltage limit and the discharging stops. This sets the LIM- bit in the Questionable Status Register.

Parameter	Typical Return
0 to 102% of rating, *RST 0	<low voltage limit>
Sets the low voltage limit to 2 V: <code>VOLT:LIM:LOW 2</code>	

- This command is coupled to the VOLTage:LIMit command. The voltage limit must always be programmed to a higher value than low voltage limit.
- The low voltage limit also prevents the output from turning on when the output voltage is below the programmed low voltage limit.

[SOURce:]VOLTage:MODE FIXed|STEP|LIST|ARB
[SOURce:]VOLTage:MODE?

Sets the transient mode. This determines what happens to the output voltage when the transient system is initiated and triggered.

FIXed keeps the output voltage at its immediate value.

STEP steps the output to the triggered level when a trigger occurs.

LIST causes the output to follow the list values when a trigger occurs.

ARB causes the output to follow the arbitrary waveform values when a trigger occurs.

Parameter	Typical Return
FIXed STEP LIST ARB, *RST FIXed	FIX, STEP, LIST, or ARB
Sets the voltage mode to Step: <code>VOLT:MODE STEP</code>	

[SOURce:]VOLTage:PROTection[:LEVel] <value>|MIN|MAX
[SOURce:]VOLTage:PROTection[:LEVel]? [MIN|MAX]

Sets the over-voltage protection level. Units are in volts. If the output voltage exceeds the OVP level, the output is disabled and the Questionable Condition status register OV bit is set.

Parameter	Typical Return
0 to 120% of rating, *RST 120% of rating	<protect level>
Sets the over-voltage protection to 24 V: <code>VOLT:PROT 24</code>	

- An over-voltage condition can be cleared with the OUTput:PROTection:CLEar command after the cause of the condition has been removed.

[SOURce:]VOLTage:PROTection:LOW[:LEVel] <value>|MIN|MAX RP793xA, RP794xA
[SOURce:]VOLTage:PROTection:LOW[:LEVel] ? [MIN|MAX]

Prevents the output from turning on if the output voltage is below the low-voltage protection level. When the low-voltage condition is true, the Questionable Status Register UV bit is set.

Parameter	Typical Return
0 to 102% of rating, *RST 0	<low-voltage protect setting>
Sets the protection level to 2 V: <code>VOLT:PROT:LOW 2</code>	

[SOURce:]VOLTage:PROTection:LOW:DElAY <value>|MIN|MAX RP793xA, RP794xA
[SOURce:]VOLTage:PROTection:LOW:DElAY? [MIN|MAX]

Sets the low-voltage protection delay in seconds. The low-voltage protection function will not be triggered during the delay time. After the delay time has expired, the low-voltage protection function will be active. This can be used to prevent false tripping when protection is enabled, as well as momentary changes in output state from triggering the over-current protection function. The minimum delay is 20.48 microseconds, and a maximum delay of 2611 seconds.

Parameter	Typical Return
0.00002048 – 2611 seconds *RST 20.48 μ s	<delay value>
Sets the protection delay to 0.2 seconds: <code>VOLT:PROT:LOW:DEL 0.2</code>	

[SOURce:]VOLTage:PROTection:LOW:STATe 0|OFF|1|ON RP793xA, RP794xA
[SOURce:]VOLTage:PROTection:LOW:STATe?

Enables or disables low-voltage protection.

Parameter	Typical Return
0 OFF 1 ON, *RST OFF	0 or 1
Enable the under-voltage protection state: <code>VOLT:PROT:LOW:STAT ON</code>	

- A low-voltage condition can be cleared with `OUTPut:PROTection:CLEar` after the cause of the condition is removed.

[SOURce:]VOLTage:RESistance[:LEVel][:IMMediate][:AMPLitude] <value>|MIN|MAX
[SOURce:]VOLTage:RESistance[:LEVel][:IMMediate][:AMPLitude]? [MIN|MAX]

Sets the output resistance level. Only applies in voltage priority mode. Units are in ohms. Refer to the [RP793xA, RP794xA](#) and [RP795xA, RP796xA](#) characteristics for the resistance programming ranges.

Parameter	Typical Return
0 to maximum (model dependent) MIN MAX, *RST 0	0
Specifies an output resistance of 0.5 ohms: <code>VOLT:RES 0.5</code>	

- Requires firmware version B.03.02.1232 and up for models RP793xA and RP794xA.
- When units are paralleled, the programmable output resistance is reduced. The programmable output resistance for a single unit must be divided by the total number of paralleled units.

[SOURce:]VOLTage:RESistance:STATe 0|OFF|1|ON
[SOURce:]VOLTage:RESistance:STATe?

Enables or disables output resistance programming. Only applies in voltage priority mode.

Parameter	Typical Return
0 OFF 1 ON, *RST OFF	0 or 1
Turns resistance programming on: <code>VOLT:RES:STAT ON</code>	

- Requires firmware version B.03.02.1232 and up for models RP793xA and RP794xA.

[SOURce:]VOLTage:SLEW[:IMMEDIATE] <value>|MIN|MAX|INFINITY
[SOURce:]VOLTage:SLEW[:IMMEDIATE]? [MIN|MAX]

Sets the voltage slew rate. The slew rate is set in volts per second and affects all programmed voltage changes, including those due to the output state turning on or off. The slew rate can be set to any value between 0 and 9.9E+37. For very large values, the slew rate will be limited by the unit's listed programming speed and bandwidth. The keywords MAX or INFINITY set the slew rate to maximum.

Parameter	Typical Return
0 – 9.9E+37, *RST MAX	<max value>
Sets the output slew rate to 5 V per second: <code>VOLT:SLEW 5</code>	

- The query returns the value that was sent. If the value is less than the minimum slew rate, the minimum value is returned. The slew setting resolution is the same as the minimum value, which can be queried using `VOLTage:SLEW? MIN`. The exact value varies slightly according to calibration.

[SOURce:]VOLTage:SLEW:MAXimum 0|OFF|1|ON
[SOURce:]VOLTage:SLEW:MAXimum?

Enables or disables the maximum slew rate override. When enabled, the slew rate is set to its maximum value. When disabled, the slew rate is set to the immediate value set by the `VOLTage:SLEW` command. Use `VOLTage:SLEW? MAX` to query the maximum slew rate that was set.

Parameter	Typical Return
0 OFF 1 ON, *RST ON	0 or 1
Enable the maximum slew rate override: <code>VOLT:SLEW:MAX ON</code>	

- The `VOLTage:SLEW:MAX` command is coupled to the `VOLTage:SLEW` command. If `VOLTage:SLEW` sets the rate to MAX or INFINITY, `VOLTage:SLEW:MAX` is enabled. If the slew rate is set to any other value, `VOLTage:SLEW:MAX` is disabled.

Status Tutorial

This section provides a detailed description of the individual registers and register groups. The status diagram provides an graphical view of how the status registers and groups are interconnected.

Status Registers

Operation Status Group

Questionable Status Groups

Standard Event Status Group

Status Byte Register

Error and Output Queues

Status Diagram

Status Registers

The Operation and Questionable status groups use four different types of registers to track qualify, flag, and enable instrument events. The Standard Event group only uses Event and Enable registers.

- A Condition register continuously monitors the state of the instrument. The bits in the condition register are updated in real time and the bits are not latched.
- An PTR/NTR register qualifies the signal that passes to the event register. When a PTR bit is set, signals with positive edge transition pass to the event register. When an NTR bit is set, signals with a negative edge transition pass to the event register. When both bits are set, all signal pass. When neither bits are set, no signals pass.
- An Event register latches transitions that pass through the PTR and NTR registers. When an event bit is set, it remains set until the Event register is read. Reading the Event register clears it.
- An Enable register defines which bits in the event register will be reported to the Status Byte register. You can write to or read from an enable register.

Operation Status Group

These registers record signals that occur during normal operation. The groups consist of a Condition, PTR/NTR, Event, and Enable register. The outputs of the Operation Status register group are logically-ORed into the OPERation summary bit (7) of the Status Byte register. Refer to [Status Diagram](#).

The following table describes the Operation Status register bit assignments.

Bit	Bit Name	Decimal Value	Definition
0	CV	1	Output is in constant voltage
1	CC	2	Output is in constant current
2	OFF	4	Output is programmed off
3	WTG-meas	8	Measurement system is waiting for a trigger
4	WTG-tran	16	Transient system is waiting for a trigger
5	MEAS-active	32	Measurement system is initiated or in progress
6	TRAN-active	64	Transient system is initiated or in progress
7-15	not used	not used	0 is returned

Questionable Status Groups

These registers record signals that indicate abnormal operation. The groups consist of a Condition, PTR/NTR, Event, and Enable register. The outputs of the Questionable Status groups are logically-ORed into the QUESTIONABLE summary bit (3) of the Status Byte register. Refer to [Status Diagram](#).

The following table describes the Questionable1 Status register bit assignments.

Bit	Bit Name	Decimal Value	Definition
0	OV	1	Output is disabled by the over-voltage protection
1	OC	2	Output is disabled by the over-current protection
2	PF	4	Output is disabled by power-fail (low-line or brownout on AC line)
3	CP+	8	Output is disabled by the positive over-power limit
4	OT	16	Output is disabled by the over-temperature protection
5	CP-	32	Output is disabled by the negative over-power limit
6	OV-	64	Output is disabled by a negative OV due to reversed sense leads
7	LIM+	128	Output is in positive voltage or current limit
8	LIM-	256	Output is in positive voltage or negative current limit
9	INH	512	Output is disabled by an external INHibit signal
10	UNR	1024	Output is unregulated
11	PROT	2048	Output is disabled by a watchdog timer protection
12	EDP	4096	Output is disabled by excessive output dynamic protection
13-15	not used	not used	0 is returned

The following table describes the Questionable2 assignments.

Bit	Bit Name	Decimal Value	Definition
0	not used	not used	0 is returned
1	IPK+	2	Output is in positive peak current limit
2	IPK-	4	Output is in negative peak current limit
3	CSF	8	A current sharing fault has occurred
4	PSP	16	Output is disabled by a primary/secondary protection
5	SDP	32	Output is disabled by a Safety Disconnect System protection
6	UV	64	An under-voltage protection has occurred.
7	OCF	128	An internal over-current fault has occurred
8	LOV	256	An internal over-voltage fault has occurred
9	DOV	512	A DUT-applied over-voltage fault has occurred
10-15	not used	not used	0 is returned

NOTE

DOV, LOV, OCF, are only available on units with firmware revision B.04.04.809 and up.

Standard Event Status Group

These registers are programmed by Common commands. The group consists of an Event and Enable register. The Standard Event event register latches events relating to communication status. It is a read-only register that is cleared when read. The Standard Event enable register functions similarly to the enable registers of the Operation and Questionable status groups. Refer to [Status Diagram](#).

The following table describes the Standard Event Status register bit assignments.

Bit	Bit Name	Decimal Value	Definition
0	Operation Complete	1	All commands before and including *OPC have been executed.
1	not used	not used	0 is returned
2	Query Error	4	The instrument tried to read the output buffer but it was empty, a new command line was received before a previous query has been read, or both the input and output buffers are full.
3	Device- specific Error	8	A device-specific error, including a self-test error, calibration error or other device-specific error occurred. Error Messages
4	Execution Error	16	An execution error occurred. Error Messages
5	Command	32	A command syntax error occurred. Error Messages
6	not used	not used	0 is returned
7	Power On	128	Power has been cycled since the last time the event register was read or cleared.

Status Byte Register

This register summarizes the information from all other status groups as defined in the IEEE 488.2 Standard Digital Interface for Programmable Instrumentation. Refer to [Status Diagram](#).

The following table describes the Status Byte register bit assignments.

Bit	Bit Name	Decimal Value	Definition
0	not used	not used	0 is returned
1	not used	not used	0 is returned
2	Error Queue	4	One or more errors in the Error Queue. Use <code>SYSTem:ERRor?</code> to read and delete errors.
3	Questionable Status Summary	8	One or more bits are set in the Questionable Data Register. Bits must be enabled, see <code>STATus:QUESTionable:ENABle</code> .
4	Message Available	16	Data is available in the instrument's output buffer.
5	Event Status Summary	32	One or more bits are set in the Standard Event Register. Bits must be enabled, see <code>*ESE</code> .
6	Master Status Summary	64	One or more bits are set in the Status Byte Register and may generate a Request for Service. Bits must be enabled, see <code>*SRE</code> .
7	Operation Status Summary	128	One or more bits are set in the Operation Status Register. Bits must be enabled, see <code>STATus:OPERation:ENABle</code> .

Master Status Summary and Request for Service Bits

MSS is a real-time (unlatched) summary of all Status Byte register bits that are enabled by the Service Request Enable register. MSS is set whenever the instrument has one or more reasons for requesting service. `*STB?` reads the MSS in bit position 6 of the response but does not clear any of the bits in the Status Byte register.

The RQS bit is a latched version of the MSS bit. Whenever the instrument requests service, it sets the SRQ interrupt line true and latches RQS into bit 6 of the Status Byte register. When the controller does a serial poll, RQS is cleared inside the register and returned in bit position 6 of the response. The remaining bits of the Status Byte register are not disturbed.

Error and Output Queues

The Error Queue is a first-in, first-out (FIFO) data register that stores numerical and textual description of an error or event. Error messages are stored until they are read with `SYSTem:ERRor?` If the queue overflows, the last error/event in the queue is replaced with error -350, "Queue overflow".

The Output Queue is a first-in, first-out (FIFO) data register that stores messages until the controller reads them. Whenever the queue holds messages, it sets the MAV bit (4) of the Status Byte register.

Status Diagram

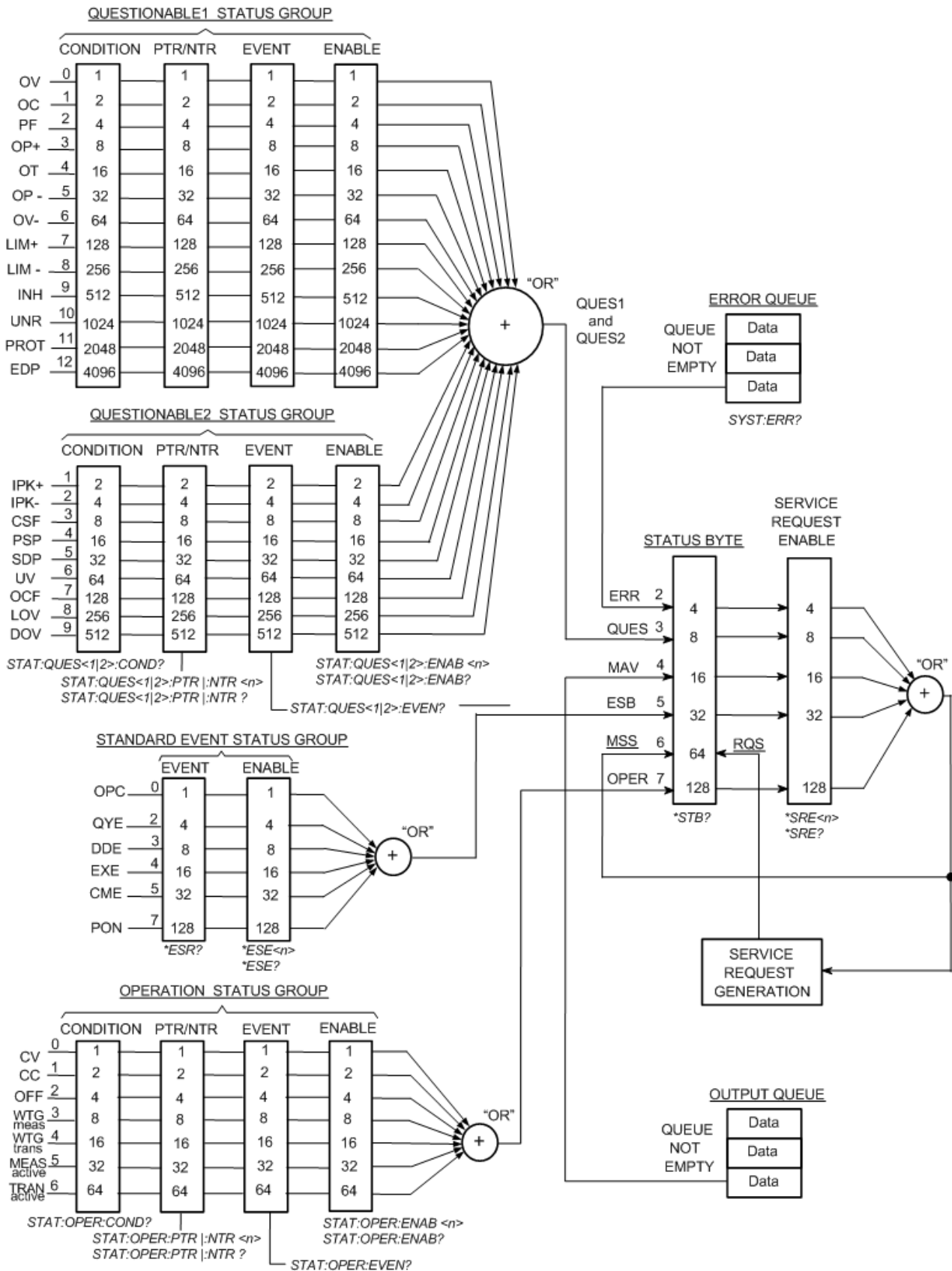

Trigger Tutorial

The RPS trigger system is a flexible, multi-purpose system that controls the operation of the instrument to suit a variety of user-defined applications. The trigger diagram below provides a graphical view of how the trigger sources and destinations are interconnected.

Trigger Sources

Trigger Destinations

Trigger Diagram

Trigger Sources

The following table describes the available trigger sources, which are shown on the left of the trigger diagram. Not all trigger sources can be applied to every trigger subsystem.

Source	Description
BUS	Enables GPIB device triggers, *TRG, or <GET> (Group Execute Trigger).
CURR1	Selects an output current level.
IMMediate	Triggers the transient as soon as it is INITiated.
PIN<n> EXtErnal	Selects a digital port pin configured as a trigger input. <n> specifies the pin number. EXtErnal selects ALL connector pins that have been configured as trigger inputs.
TRAN1	Selects the transient system as the trigger source.
TRIG:ACQ:IMM	Triggers the acquisition immediately.
TRIG:TRAN:IMM	Triggers the transient immediately.
VOLT1	Selects an output voltage level.

Trigger Destinations

The following table describes the trigger system destinations.

Destination	Description
Digital pin	Sends the trigger to the designated digital pin. See Programming the Digital Port .
Transient system	Sends the trigger to the designated transient (STEP, BOST, EOST)
Acquisition system	Sends the trigger to the acquisition system (TOUT)
Arb	Starts the arbitrary waveform. Note that the waveform must first be enabled and initiated. See Programming Output Transients .

Trigger Diagram

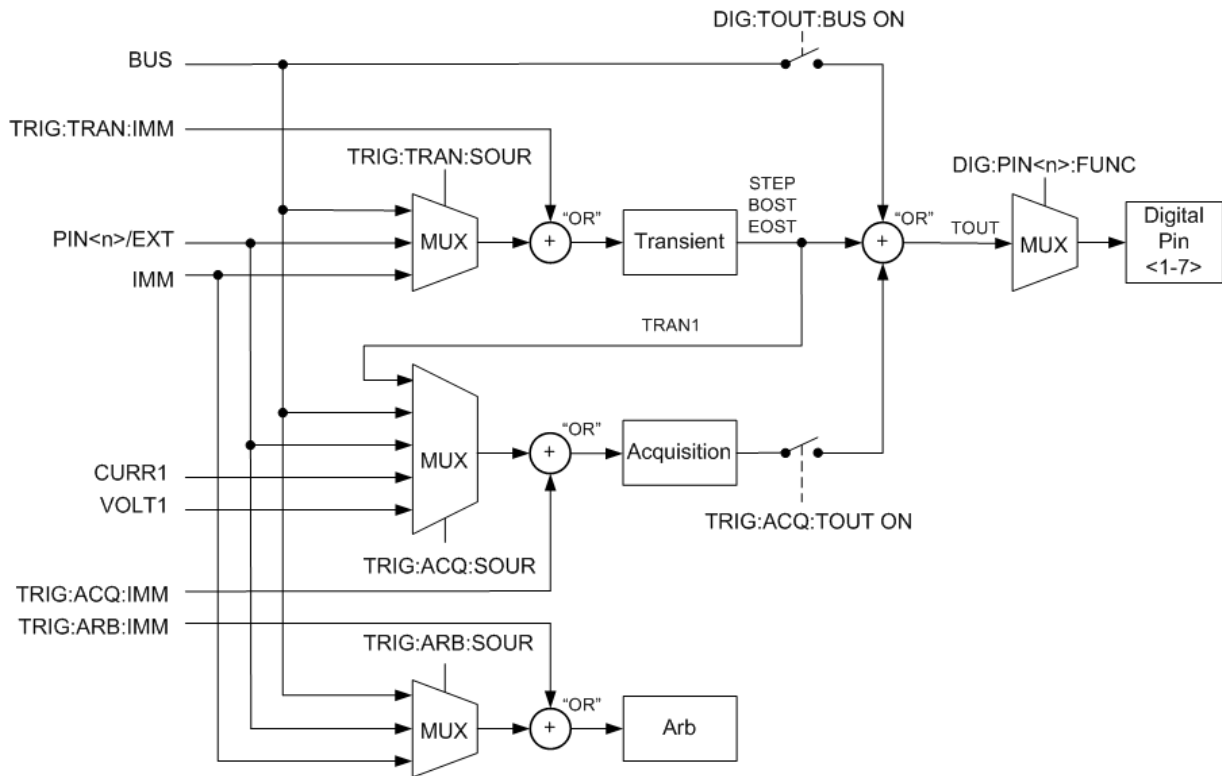

Reset State (*RST)

NOTE

The power-on/reset state may differ from that shown below if you have enabled power-on state recall mode from the **States** menu (see **Instrument State Storage**).

Reset Settings

The following table shows the reset state. These parameters are reset to the indicated values at power-on or after *RST.

SCPI Command *RST Settings	
ARB:COUNT	1
ARB:CURRENT:CDWELL:DWELL	0.001
ARB:FUNCTION:SHAPE	CDW
ARB:FUNCTION:TYPE	VOLTAGE
ARB:TERMINATE:LAST	OFF
ARB:VOLTAGE:CDWELL:DWELL	0.001
CALIBRATE:STATE	OFF
CURRENT	0
CURRENT:LIMIT	1.02% of rating
CURRENT:LIMIT:NEGATIVE	-10.2% of rating
CURRENT:MODE	FIXED
CURRENT:PROTECTION:DELAY	20 ms
CURRENT:PROTECTION:DELAY:START	SCHANGE
CURRENT:PROTECTION:STATE	OFF
CURRENT:SHARING	OFF
CURRENT:SLEW	MAX
CURRENT:SLEW:MAXIMUM	ON
CURRENT:TRIGGERED	0
DIGITAL:OUTPUT:DATA	0
DIGITAL:TOUTPUT:BUS	OFF
DISPLAY	ON

5 SCPI Programming Reference

SCPI Command *RST Settings	
DIGital:OUTPut:DATA	0
DIGital:TOUTPut:BUS	OFF
FORMat:DATA	ASCII
FORMat:BORDER	NORMAL
FUNction	VOLTage
INITialize:CONTinuous:TRANsient	OFF
LIST:COUNT	1
LIST:CURRent	1 step set to 0
LIST:DWELL	1 step set to 0.001
LIST:STEP	AUTO
LIST:TERMinate:LAST	OFF
LIST:TOUTput:BOStep	1 step set to OFF
LIST:TOUTput:EOStep	1 step set to OFF
LIST:VOLTage	1 step set to 0.1% of rating
LXI:IDENTify	OFF
LXI:MDNS	OFF
OUTPut	OFF
OUTPut:DElay:FALL	0
OUTPut:DElay:RISE	0
OUTPut:PROTection:WDOG	OFF
OUTPut:PROTection:WDOG:DElay	60
RESistance	0
RESistance:STATe	0
SENSe:CURRent:RANGe:AUTO	102.5% of rating
SENSe:FUNction:CURRent	1
SENSe:FUNction:VOLTage	1
SENSe:SWEep:NPLCycles	1
SENSe:SWEep:OFFSet:POINts	0
SENSe:SWEep:POINts	3255 (60 Hz); 3906 (50 Hz)

SCPI Command *RST Settings	
SENSe:SWEEp:TINterval	5.12E-6
SENSe:WINDow	RECTangular
STEP:TOUTput	OFF
TRIGger:ACQuire:CURRent	0
TRIGger:ACQuire:CURRent:SLOPe	POSitive
TRIGger:ACQuire:SOURce	BUS
TRIGger:ACQuire:TOUTput	OFF
TRIGger:ACQuire:VOLTage	0
TRIGger:ACQuire:VOLTage:SLOPe	POSitive
TRIGger:ARB:SOURce	BUS
TRIGger:TRANSient:SOURce	BUS
VOLTage	0.1% of rating
VOLTage:LIMit	1% of rating
VOLTage:MODE	FIXed
VOLTage:PROTection	120% of rating
VOLTage:RESistance	0
VOLTage:RESistance:STATe	OFF
VOLTage:SLEW	MAX
VOLTage:SLEW:MAXimum	ON
VOLTage:TRIGgered	0.1% of rating

Non-Volatile Settings

The following table shows the as-shipped settings of the **non-volatile** parameters. These are not affected by power cycling or *RST.

SCPI as-shipped settings	
CALibrate:DATE	empty string
CALibrate:PASSword	0
DIGital:PIN<all>:FUNctIon	DINput
DIGital:PIN<all>:POLarity	POSitive

5 SCPI Programming Reference

SCPI as-shipped settings	
DISPlay:VIEW	METER_VI
INSTrument:GROup:FUNCTion	NONE
INSTrument:GROup:SECOndary:ADDRes	1
OUTPut:COUPle	OFF
OUTPut:COUPle:DOFFset	0
OUTPut:INHibit:MODE	OFF
OUTPut:PON:STATe	RST
OUTPut:RELAy:LOCK	OFF
SYSTem:LFRequency:MODE	AUTO
SYSTem:SDS:DIGital:DATA:OUTPut	0
SYSTem:SDS:ENABLE	OFF
Front Panel as-shipped settings	
Front panel lockout password	Disabled
Firmware update password protected	Disabled
GPIB address	5
GPIB interface	Enabled
LAN interface	Enabled
USB interface	Enabled
Screen saver	Enabled
Screen saver delay	60 minutes
Wake on I/O	Enabled
Interface as-shipped settings	
Get GPIB Address	Automatic
Subnet mask	255.255.0.0
Default gateway	0.0.0.0
Host name	K- <serial number>
mDNS service name	Keysight RP79xxx Regenerative Power System <serial number>
LAN service - VXI-11	Enabled
LAN service - Telnet	Enabled

SCPI as-shipped settings	
LAN service - mDNS	Enabled
LAN service - Web server	Enabled
LAN service - sockets	Enabled
Web password	Blank

SCPI Error Messages

The Keysight instrument returns error messages in accord with the SCPI standard.

- Up to 20 errors can be stored in each interface-specific error queue (one each for GPIB, USB, VXI-11, and Telnet/Sockets.) Errors appear in the error queue of the I/O session that caused the error.
- The front-panel ERR annunciator turns on when there are one or more errors are in the error queue.
- A special global error queue holds all power-on and hardware-related errors (for example, over-temperature).
- Error retrieval is first-in-first-out (FIFO), and errors are cleared as you read them. Once you have read all interface-specific errors, the errors in the global error queue are retrieved. When you have read all errors from the error queue, the ERR annunciator turns off.
- If more than 20 errors have occurred, the last error stored in the queue (the most recent error) is replaced with -350, "Error queue overflow". No additional errors are stored until you remove errors from the queue. If no errors have occurred when you read the error queue, the instrument responds with +0, "No error".
- The front panel reports errors from all I/O sessions and the global error queue. To read the error queue from the front panel, press the ERROR key.
- Error conditions are also summarized in the Status Byte Register. See [Status Subsystem Introduction](#) for details
- The interface-specific error queues are cleared by power cycles and *CLS. The error queue is not cleared by *RST.
- **SCPI:**

`SYSTem:ERRor?` *Read and clear one error from the queue*

Errors have the following format (the error string may contain up to 255 characters):

Error Device-dependent Errors (these errors set Standard Event Status register bit #3)

0 No error

This is the response to the ERR? query when there are no errors.

101 Calibration state is off

Calibration is not enabled. The instrument will not accept calibration commands.

102 Calibration password is incorrect

The calibration password is incorrect.

103 Calibration is inhibited by switch setting

Calibration mode is locked out by the calibration switch.

104 Bad sequence of calibration commands

Calibration commands have not been entered in the proper sequence.

105 Unexpected output current

The measured output current is outside the acceptable range.

106 Zero measurement out of range error

The “zero” measurement value is outside the acceptable range.

107 Programming cal constants out of range

The programmed calibration constant is outside the acceptable range.

108 Measurement cal constants out of range

The measurement calibration constant is outside the acceptable range.

109 Over voltage cal constants out of range

The over voltage calibration constant is outside the acceptable range.

110 Wrong V+I

The instrument was unable to set the correct voltage or current value.

114 Wrong status

An incorrect status function has been reported.

116 Locked out by internal switch setting

This function has been locked out by an internal switch.

117 Calibration error

A calibration error has occurred. Do not save calibration constants. Try re-calibrating the unit.

200 Hardware error channel <1 >

A hardware error has occurred on the output.

201 Invalid configuration

An invalid parallel or SDS configuration is not allowed.

202 Selftest Fail

A selftest failure has occurred. See selftest failure list for details.

203 Compatibility function not implemented

The requested compatibility function is not available.

204 NVRAM checksum error

5 SCPI Programming Reference

A checksum error has occurred in the instrument's nonvolatile random access memory.

205 NVRAM full

The nonvolatile random access memory of the instrument is full.

206 File not found

The internal calibration file or the internal channel attribute file was not found in NVRAM.

207 Cal file version error

The calibration file was written or read using old firmware. Firmware must be updated.

208 Running backup firmware

The instrument is presently running the backup (previous) version of the firmware.

210 Frame NVRAM error

A non-volatile RAM error has occurred in the instrument.

212 State file not loaded

A previously saved output state file has failed to load.

214 Line frequency error

A discrepancy has occurred between the line frequency and the line frequency setting.

215 Hardware failure

A hardware failure has occurred on the power supply

302 Option not installed

The option that is programmed by this command is not installed.

303 There is not a valid acquisition to fetch from

There is no valid data in the measurement buffer.

304 Volt and curr in incompatible transient modes

Voltage and current cannot be in Step and List mode at the same time.

305 A triggered value is on a different range

A triggered value is on a different range than the one that is presently set.

306 Too many list points

Too many list points have been specified.

307 List lengths are not equivalent

One or more lists are not the same length.

308 This setting cannot be changed while transient trigger is initiated

Setting cannot be changed while the instrument is waiting for or executing a trigger sequence.

309 Cannot initiate, voltage and current in fixed mode

Cannot initiate transient generator. Either the voltage or current function is set to Fixed mode.

310 The command is not supported by this model

This instrument either does not have the hardware capability or the options required to support this command.

315 Settings conflict error

A data element could not be programmed because of the present instrument state.

316 Mass storage error

The mass storage memory has been exceeded.

317 Invalid format

An invalid data format was found in the command string.

320 Firmware update error

This may be due to the instrument hardware not being able to support the firmware version.

324 Inconsistent arb settings

The arb settings are inconsistent; most likely a mismatch in the arb lengths.

327 Initiated with no sense function enabled

A measurement has been initiated without specifying the measurement (sense) function.

328 Too many measurement points

Too many measurement points have been specified.

331 Illegal parameter value

The parameter value is out of range or does not exist.

332 Primary/secondary error

An error has occurred in the primary/secondary configuration

333 Safety Disconnect error

An error has occurred in the SDS unit.

Command Errors (these errors set Standard Event Status register bit #5)

-100 Command error

Generic syntax error.

-101 Invalid character

5 SCPI Programming Reference

An invalid character was found in the command string.

-102 Syntax error

Invalid syntax was found in the command string. Check for blank spaces.

-103 Invalid separator

An invalid separator was found in the command string. Check for proper use of , ; :

-104 Data type error

A different data type than the one allowed was found in the command string.

-105 GET not allowed

A group execute trigger is not allowed in a command string.

-108 Parameter not allowed

More parameters were received than were expected.

-109 Missing parameter

Fewer parameters were received than were expected.

-110 Command header error

An error was detected in the header.

-111 Header separator error

A character that was not a valid header separator was found in the command string.

-112 Program mnemonic too long

The header contains more than 12 characters.

-113 Undefined header

A command was received that was not valid for this instrument.

-114 Header suffix out of range

The value of the numeric suffix is not valid.

-120 Numeric data error

Generic numeric data error.

-121 Invalid character in number

An invalid character for the data type was found in the command string.

-123 Exponent too large

The magnitude of the exponent was larger than 32000.

-124 Too many digits

The mantissa of a numeric parameter contained more than 255 digits, excluding leading zeros.

-128 Numeric data not allowed

A numeric parameter was received but a character string was expected.

-130 Suffix error

Generic suffix error

-131 Invalid suffix

A suffix was incorrectly specified for a numeric parameter.

-134 Suffix too long

The suffix contains more than 12 characters.

-138 Suffix not allowed

A suffix is not supported for this command.

-140 Character data error

Generic character data error

-141 Invalid character data

Either the character data element contains an invalid character, or the element is not valid.

-144 Character data too long

The character data element contains more than 12 characters.

-148 Character data not allowed

A discrete parameter was received, but a string or numeric parameter was expected.

-150 String data error

Generic string data error

-151 Invalid string data

An invalid character string was received. Check that the string is enclosed in quotation marks.

-158 String data not allowed

A character string was received, but is not allowed for this command.

-160 Block data error

Generic block data error

-161 Invalid block data

The number of data bytes sent does not match the number of bytes specified in the header.

-168 Block data not allowed

Data was sent in arbitrary block format but is not allowed for this command.

Execution Errors (these errors set Standard Event Status register bit #4)

-200 Execution error

Generic syntax error

-220 Parameter error

A data element related error occurred.

-221 Settings conflict

A data element could not be executed because of the present instrument state.

-222 Data out of range

A data element could not be executed because the value was outside the valid range.

-223 Too much data

A data element was received that contains more data than the instrument can handle.

-224 Illegal parameter value

An exact value was expected but not received.

-225 Out of memory

The device has insufficient memory to perform the requested operation.

-226 Lists not same length

One or more lists are not the same length.

-230 Data corrupt or stale

Possible invalid data. A new reading was started but not completed.

-231 Data questionable

The measurement accuracy is suspect.

-232 Invalid format

The data format or structure is inappropriate.

-233 Invalid version

The version of the data format is incorrect to the instrument.

-240 Hardware error

The command could not be executed because of a hardware problem with the instrument.

-241 Hardware missing

The command could not be executed because of missing hardware, such as an option.

Query Errors (these errors set Standard Event Status register bit #2)

-400 Query Error

Generic error query

-410 Query INTERRUPTED

A condition causing an interrupted query error occurred.

-420 Query UNTERMINATED

A condition causing an unterminated query error occurred.

-430 Query DEADLOCKED

A condition causing a deadlocked query error occurred.

-440 Query UNTERMINATED after indefinite response

A query was received in the same program message after a query indicating an indefinite response was executed.

Compatibility Commands

This section describes the compatibility of the Keysight RPS7900-series with existing Keysight N7900-series Advanced Power Systems (APS). Because of their feature sets, only programs written for the N7900 Advanced Power Systems are compatible with the Regenerative Power System (RPS) models. Note that not all features are common to both families.

APS code-compatible commands with RPS models

These Keysight N7900 APS commands are compatible with the RPS models.

N7900-series APS commands	Action or equivalence on RPS models
[SOURce] :RESistance <value> :STATe <Bool>	[SOURce] :VOLTage :RESistance <value> :STATe <Bool>

APS feature set comparison with RPS models

The following table compares the feature set of the Keysight N7900 APS models with the feature set of the RPS models

Feature	In N7900 APS models?
Two quadrant operation	Yes
Voltage and current priority operation	Yes
Voltage and current slew rates	Yes
Resistance programming (in voltage priority mode)	Yes
Output bandwidth selection (in voltage priority mode)	Yes
Output triggering	
Single step output change	Yes
Output list of up to 512 points	Yes
Constant-dwell arbitrary waveform – up to 64k points	Yes
Scalar measurements	
DC, RMS, High/Low, Min/Max current scalar measurements	Yes
DC, RMS, High/Low, Min/Max voltage scalar measurements	Yes
Average Power	Yes
Amp hours and Watt hours	Yes
Digitized measurements	
Simultaneous voltage and current measurements	Yes
Current, voltage, and power array data	Yes
External data logging	Yes

Feature	In N7900 APS models?
Trigger systems	
Measurements	Yes
Transients	Yes
Digital port pins	Yes
Output state	Yes
User defined protection	Yes
Black box events	Yes
Trigger routing	Yes
Protection functions	
Remote and local over-voltage	Yes
Over-current	Yes
Over-temperature	Yes
Excessive output dynamics	Yes
High Z/Low Z	Yes
User protection	Yes
Available auxiliary safety disconnect system	No
System features	
Digital port pins	Yes
Remote Inhibit/Fault output	Yes
Fan speed control	Yes
Coupled output On/Off	Yes
Two wire current sharing	Yes
Output Relay	Yes
Black Box recorders	Yes
Sense fault detection	Yes
Primary/secondary mode capability	No

6

Verification and Calibration

Test Equipment and Setups

Performance Verification

Instrument Calibration

Test Record Forms

Test Equipment and Setups

Test Equipment

Measurement Setups

Test Equipment

The test equipment recommended for the performance verification and adjustment procedures is listed below. If the exact instrument is not available, substitute calibration standards of equivalent accuracy.

Instrument	Requirements	Recommended Model	Use ¹
Digital Multimeter	Resolution: 10 nV @ 1V; Readout: 8 1/2 digits Accuracy: 20 ppm	Keysight 3458A	V, C
Current Shunt ²	100 A (0.01Ω) 0.01%, TC=4ppm/ΩC 300 A (0.001Ω) 0.01%, TC=4ppm/ΩC 1000A, 0.1mΩ 0.02%, TC=25ppm/ΩC	Guildline 9230A/100 Guildline 9230A/300 Guildline 9230A/1000 or equivalent	V, C
Electronic load and source	Refer to table under	Electronic Load section	V
DC power supply ³	80 V, 40 A	Keysight RP7935A/RP7945A or equivalent	C
GPIO controller	Full GPIO capabilities	Keysight 82350B or equivalent	V, C
Oscilloscope	Sensitivity: 1 mV Bandwidth: 20 MHz Probe: 10:1 with RF tip Probe: 100:1 with RF tip	Keysight DS06054A or equivalent Keysight 10073D Keysight 10076C	V
RMS Voltmeter	True RMS Bandwidth: 20 MHz Sensitivity: 100 μV	Rhode and Schwartz Model URE3 or equivalent	V
Differential Amplifier	Bandwidth: 20 MHz	LeCroy 1855A, DA1850A, or equivalent	V
Differential Probe	10:1/100:1 selectable	LeCroy DXC100A, or equivalent	V
Terminations	50Ω BNC termination		V

¹ V=Verification; C=Calibration

² Dependent on output voltage rating of the model being tested

³ Required for calibration on models RP795xA/RP796xA only

Measurement Setups

Voltmeter

To ensure that the values read by the voltmeter during both the verification procedure and the calibration procedure are not affected by the instantaneous measurement of the AC peaks of the output current ripple, make several DC measurements and average them.

If you are using a Keysight 3458A DMM, you can set up the voltmeter to do this automatically. From the instrument's front panel, program 100 power line cycles per measurement. Press NPLC 100 ENTER. Additionally, turn on auto-calibration (ACAL) and the autorange function (ARANGE).

Current Shunt

The 4-terminal current shunt is used to eliminate output current measurement error caused by voltage drops in the load leads and connections. It has special current-monitoring terminals inside the load connection terminals. Connect the voltmeter directly to these current-monitoring terminals.

Electronic Load

The following table describes the electronic load and source equipment required to test the RP79xxA models. Note that in most cases equivalent RP79xxA models can be used as both loads and sources in the verification tests. Model EA-EL 9160-300 electronic loads are only used for transient response tests on the high current RP79xxA units.

Device Under Test	Electronic Load & Source	Electronic load for transient response only
RP7931A/RP7941A	RP7933A/RP7943A ¹	1 - EA-EL 9160-300 or equivalent ²
RP7932A/RP7942A	RP7935A/RP7945A	no change
RP7933A/RP7943A	RP7933A/RP7943A ¹	2 - EA-EL 9160-300 or equivalent ^{2, 3}
RP7935A/RP7945A	RP7935A/RP7945A	no change
RP7936A/RP7946A	RP7936A/RP7946A	no change
RP7951A/RP7961A	RP7972A ⁴	no change
RP7952A/RP7962A	RP7972A ⁴	no change
RP7953A/RP7963A	RP7972A ⁴	no change

¹ For all tests except transient response

² Must have current rise time of 35µs or faster

³ Used in Director/Follower mode

⁴ **CAUTION** Set OVP to 110% of DUT voltage rating

Fixed load resistors may be used in place of a variable load, with minor changes to the test procedures. To avoid contact with any high voltages during operation, use switches to connect, disconnect, or short the load resistors.

Also, if computer controlled test setups are used, the relatively slow (compared to computers and system voltmeters) settling times and slew rates of the RPS may have to be taken into account. "Wait" statements can be used in the test program if the test system is faster than the RPS.

Performance Verification

Introduction

Verification Setups

Test Considerations

Voltage Programming and Readback Accuracy

Constant Voltage Load Effect

Constant Voltage Ripple and Noise

Transient Recovery Time

Current Programming and Readback Accuracy

Constant Current Load Effect

Current Sink Capability Verification

Test Record Forms

Introduction

WARNING

SHOCK HAZARD, LETHAL VOLTAGES Many models generate voltages greater than 60 VDC, with some models rated at 950 VDC! Ensure that all instrument connections, load wiring, and load connections are either insulated or covered using the safety covers provided, so that no accidental contact with lethal voltages can occur.

Use the performance verification tests to verify that the unit under test (UUT) is operating normally and meets its published specifications. You can perform two different levels of performance verification tests:

- **Performance Verification Tests** An extensive set of tests that are recommended as an acceptance test when you first receive the instrument or after performing adjustments.
- **Calibration-Tests** These tests verify that the instrument is operating within its calibration limits.

The performance verification tests are recommended as acceptance tests when you first receive the instrument. The acceptance test results should be compared against the instrument specifications.

Keysight Technologies recommends that you repeat the performance verification tests at every calibration interval. This ensures that the instrument will remain within specifications for the next calibration interval and provides the best long-term stability. Performance data measured using this method may be used to extend future calibration intervals.

Perform the verification tests before calibrating your power supply. If the instrument passes the verification tests, the unit is operating within its calibration limits and does not need to be re-calibrated.

If the instrument fails any of the tests or if abnormal test results are obtained, try calibrating the unit. If calibration is unsuccessful, return the unit to a Keysight Technologies Service Center.

Refer to the **Recommended Test Equipment and Setups** section for a list of the equipment and test setups required for verification. Also refer to the **Measurement Setups** section for information about connecting the voltmeter, current shunt, and load.

WARNING

SHOCK HAZARD, LETHAL VOLTAGES Many models generate voltages greater than 60 VDC, with some models rated at 950 VDC! Ensure that all instrument connections, load wiring, and load connections are either insulated or covered using the safety covers provided, so that no accidental contact with lethal voltages can occur.

Always turn off the output when connecting or disconnecting any equipment on the sense or output terminals of the unit.

CAUTION

Equipment Damage It is recommended to set the overvoltage protection function of the instrument slightly higher than its operating point during the verification procedure. This will prevent damage to any external equipment (electronic load, differential amplifier) that may occur if the output voltage is accidentally programmed higher than the prescribed voltage setting.

NOTE

Turn the unit off or send a Reset command after completing the verification procedure to return all instrument settings to their default values.

Verification Setups

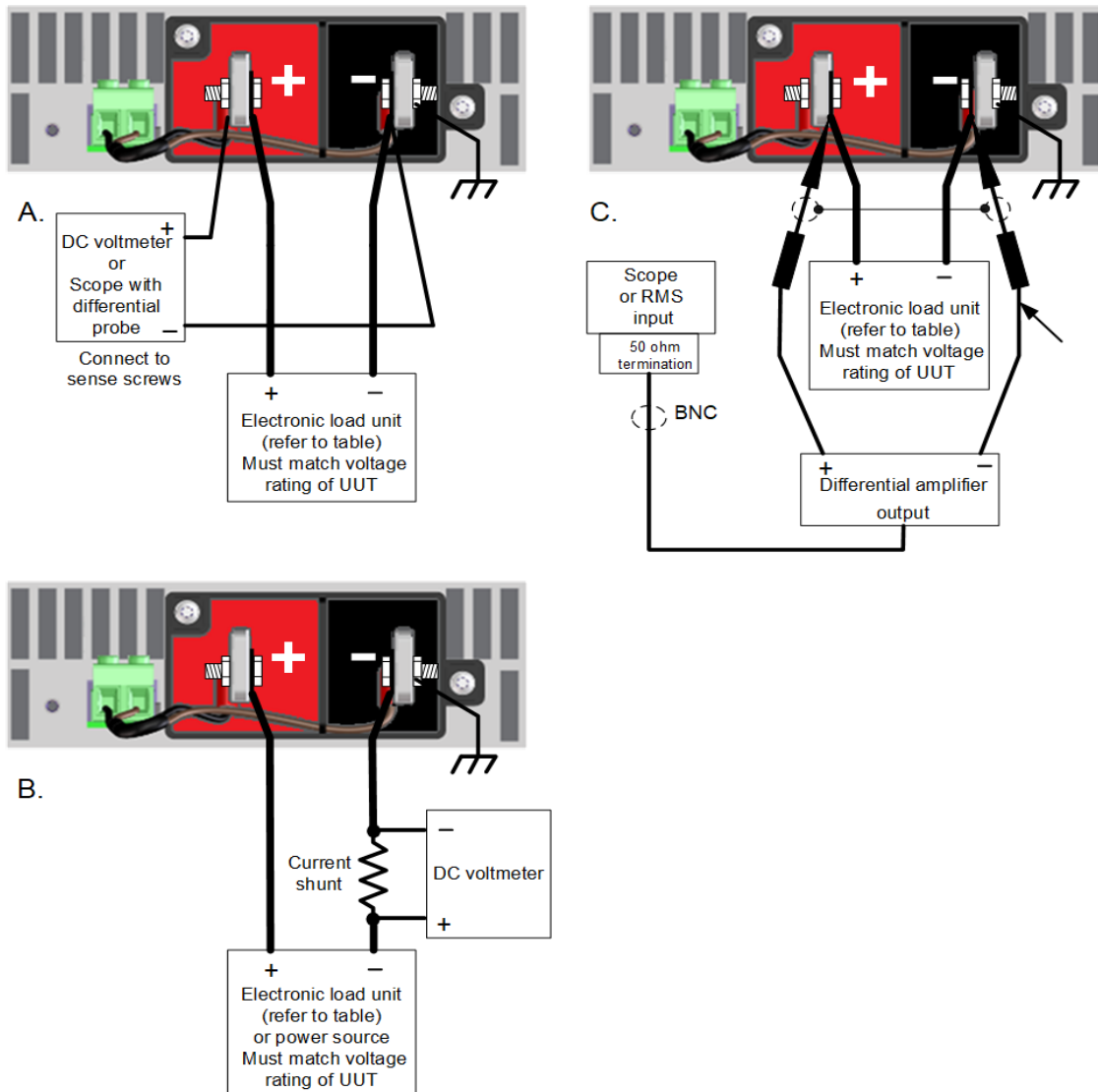

Test Considerations

For optimum performance, all verification and calibration procedures should comply with the following:

- Ambient temperature is stable, between 18 and 28 °C.
- Ambient relative humidity is less than 80%.
- 30 minute warm-up period before verification or adjustment.
- Cables as short as possible, twisted or shielded to reduce noise.

Verification Procedure

Voltage Programming and Readback Accuracy

This test verifies that the voltage programming and measurement functions are within specifications.

Step 1. Turn off the unit under test. Only connect the DMM to the sense screws (see **Test Setup A**). Do **NOT** connect the load unit.

Step 2. Turn on the unit under test and program the instrument settings as described in the test record form under “Voltage Programming & Readback, Min Voltage”. Turn the output on. The output status should be “CV”, with the output current close to zero.

Step 3. Record the output voltage reading from the DMM (V_{out}) and the voltage measured by the instrument over the interface. The readings should be within the limits specified in the test record form for the appropriate model under “Voltage Programming & Readback, Minimum Voltage”.

WARNING The next step applies the full output voltage of the unit under test to the output.

Step 4. Program the instrument settings as described in the test record form under “Voltage Programming & Readback, High Voltage”.

Step 5. Record the output voltage reading from the DMM (V_{out}) and the voltage measured by the instrument over the interface. The readings should be within the limits specified in the test record form for the appropriate model under “Voltage Programming & Readback, High Voltage”.

Constant Voltage Load Effect

This test measures the change in voltage resulting from a change in current from full load to no load.

Step 1. Turn off the unit under test. Connect the DMM to the sense screws and connect the load unit. Make sure that the voltage rating of the load unit matches the voltage rating of the unit under test. (see **Test Setup A**).

Step 2. Turn on the unit under test and program the instrument settings as described in the test record form under “CV Load Effect”. Turn the output on.

Step 3. Set the load unit for the output current as described in the test record form under “CV Load Effect”. Turn the output on. The output status of the unit under test should be “CV”. If it isn't, adjust the load so that the output current drops slightly.

Step 4. Record the output voltage reading from the DMM.

Step 5. Turn off the output of the load unit. Record the voltage reading from the DMM again. The difference between the DMM readings in steps 4 and 5 is the load effect, which should not exceed the value listed in the test record form for the appropriate model under “CV Load Effect”.

Constant Voltage Ripple and Noise

Periodic and random deviations in the output combine to produce a residual AC voltage superimposed on the DC output voltage. This residual voltage is specified as the rms or peak-to-peak noise in the indicated frequency range (see **RP793xA**, **RP794xA** and **RP795xA**, **RP796xA** specifications).

Step 1. Turn off the unit under test. Connect the load unit, differential amplifier, and an oscilloscope (ac coupled) to the output (see **Test Setup C**). Make sure that the voltage rating of the load unit matches the voltage rating of the unit under test.

Step 2. As shown in the diagram, use the differential probes to connect the differential amplifier to the + and - output terminals. The shields of the two probes should be connected together. Connect the output of the differential amplifier to the oscilloscope with a 50Ω termination at the input of the oscilloscope.

Step 3. For models RP795xA, RP796xA, set the probe to 1:100 and set the inputs of the differential amplifier to match the probe setting. For models RP794xA, RP795xA, set the probe to 1:10 and set the inputs of the differential amplifier to match the probe setting. Set the inputs to AC coupling. Set the input resistance to 1 MΩ. Set the oscilloscope's time base to 5 ms/div, and set the vertical scale to the maximum sensitivity without clipping the waveform. Turn the bandwidth limit on (usually 20 MHz), and set the sampling mode to peak detect.

Step 4. Turn on the unit under test and program the instrument settings as described in the in the test record form under "CV Ripple and Noise". Turn the output on. Program the load unit as shown in the test record card and turn the output on. Let the oscilloscope run for a few seconds to generate enough measurement points. On the Keysight Infiniium scope, the maximum peak-to-peak voltage measurement is indicated at the bottom of the screen on the right side. The result should not exceed the peak-to-peak limits in the test record form under "CV Ripple and Noise, peak-to-peak".

NOTE

If the measurement contains any question marks, clear the measurement and try again. This means that some of the scope data received was questionable.

Step 5. Disconnect the oscilloscope and connect an rms voltmeter in its place. Do not disconnect the 50 ohm termination. Divide the reading of the rms voltmeter according to the differential amplifier setting. The result should not exceed the rms limits in the test record form for the appropriate model under "CV Ripple and Noise, rms".

Transient Recovery Time

This test measures the time for the output voltage to recover to within the specified value following a 50% change in the instrument's rated load current.

Step 1. Turn off the unit under test. Connect an oscilloscope with the specified probe across the sense terminals (see **Test Setup A**). Connect the load unit to the output terminals. Make sure that the voltage rating of the load unit matches the voltage rating of the unit under test.

Step 2. Turn on the unit under test and program the instrument settings as described in the test record form under "Transient Response".

Step 3. Set the load unit's list generator to generate a 100 Hz current waveform with a duty cycle of 50%.

RP79xxA load unit commands to program the list:

FUNC CURR - specifies current priority
 VOLT:LIM <value> - refer to test record card for voltage limit value
 CURR:BWID:LEV 0, 100000 - specifies the bandwidth frequency
 CURR:MODE LIST - specifies current priority
 LIST:CURR <low_value>, <high_value> - refer to test record card for low and high current values
 LIST:DWEL 0.005, 0.005 - specifies a 100 Hz current waveform with a 50% duty cycle
 LIST:COUN INF - sets the list count to infinity
 INIT:TRAN - initiates the transient system
 TRIG:TRAN - triggers the transient system
 OUTP ON - turns on the load

EA-EL 9160-300 load unit front panel procedure to program the list:

Set the Mode switch to CC
 Set the Level Control to A/B
 Use the Selection knob to select Level A
 Use the Setting knob to set the current to 250 A ¹
 Use the Selection knob to select Level B
 Use the Setting knob to set the current to 50 A ¹
 Use the Selection knob to show the A and B dwell times
 Use the Setting knob to set the dwell time to 5.00 ms ²
 Use the Selection knob to select the slew rate in the upper right
 Use the Setting knob to set the slew rate to 35 μ s or less
 The total step of the programmed current jump shows 200 A ¹

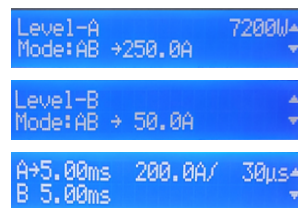

¹ In Director/Follower mode, the current is automatically doubled

² This sets the frequency to 100Hz and duty cycle to 50%

Step 4. Adjust the oscilloscope for a waveform similar to that shown in the following figure.

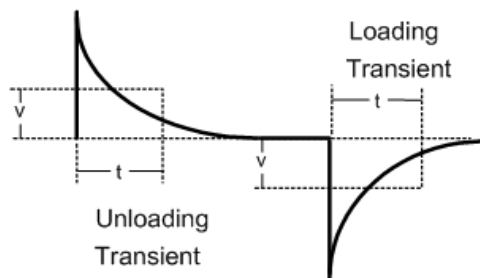

Step 5. The output voltage should return to within the specified voltage at the specified time after the load change. Check both loading and unloading transients by triggering on the positive and negative slope. Record the voltage at time "t" in the performance test record form under "Transient Response".

Current Programming and Readback Accuracy

This test verifies that the current programming and measurement functions are within specifications.

Step 1. Turn off the unit under test. Connect the current shunt directly across the output terminals. Connect the DMM directly across the current shunt (see **Test Setup B**). Note that the load unit is not used in this portion of the test.

Step 2. Turn on the unit under test and program the instrument settings as described in the test record form under “Current Programming & Readback, Min Current”. The output status should be “CC”, with the output voltage close to zero. Wait 5 minutes for the temperature to settle.

Step 3. Divide the voltage drop (DMM reading) across the current shunt by the shunt resistance to convert to amps and record this value. (I_{out}). Also, record the current measured by the instrument over the interface. The readings should be within the limits specified in the test record form under “Current Programming & Readback, Minimum Current”.

Step 4. Program the instrument settings as described in the test record form under “Current Programming & Readback, High Current”. Wait 5 minutes for the temperature to settle.

Step 5. Divide the voltage drop (DMM reading) across the current shunt by the shunt resistance to convert to amps and record this value. (I_{out}). Also, record the current reading measured by the instrument over the interface. The readings should be within the limits specified in the test record form under “Current Programming & Readback, High Current”.

Constant Current Load Effect

This test measures the change in current resulting from a change in voltage from a short to full scale.

Step 1. Turn off the unit under test. Connect the current shunt directly across the output terminals. Connect the DMM directly across the current shunt (see **Test Setup B**).

Step 2. Turn on the unit under test and program the instrument settings as described in the test record under “CC Load Effect”. The output status should be “CC”, with the output voltage be close to zero. Wait 5 minutes for the temperature to settle.

Step 3. Divide the voltage drop (DMM reading) across the current shunt by the shunt resistance to convert to amps and record this value.

Step 4. Turn off the unit under test and connect the load unit between the current shunt and the output terminals (see **Test Setup B**). Make sure that the voltage rating of the load unit matches the voltage rating of the unit under test.

Step 5. Set the load unit for voltage priority mode and program it to the voltage as described in the test record under “CC Load Effect”. Enable the load's output.

Step 6. Program the unit under test to the settings as described in the test record under “CC Load Effect”. Enable the output of the unit under test. The output status should be “CC”. If it isn't, adjust the load so that the output voltage drops slightly.

Step 7. Divide the voltage drop (DMM reading) across the current shunt by the shunt resistance to convert to amps and record this value. The difference in the current reading in step 3 is the load effect, which should not exceed the value specified in the test record for the appropriate model under “CC Load Effect”.

Current Sink Capability Verification

This test checks the ability of the power supply to sink up to 100% of its rated output current.

Step 1. Turn off the unit under test and connect the RP79xxA as an external source to the + and - output terminals (see **Test Setup C**). Make sure that the voltage rating of the RP79xxA source matches the voltage rating of the unit under test.

Step 2. Set the RP79xxA external source as follows: Voltage setting = 50 % of the rated output voltage of the unit under test. Current limit setting = 110% of the rated output current of the unit under test.

Step 3. Turn on the unit under test. Set the operating mode to current priority. Program the instrument settings as described in the test record under “Current Sink Verification”.

Step 4. Check the front panel display of the RP79xxA source and verify that the supply is sinking 100% of its rated current. Divide the voltage drop (DMM reading) across the current shunt by the shunt resistance to convert to amps and record this value. The readings should be within the limits specified in the test record form under “Current Sink Tests”.

Instrument Calibration

Introduction

Calibration Interval

Calibration Setups

Test Considerations

Enter Calibration Mode

Voltage Calibration

Current Temperature Coefficient Calibration - RP793xA, RP794xA

Current Calibration

Current Sharing Calibration - RP795xA, RP796xA

Resistance Bottom-Out Calibration - RP795xA, RP796xA

Enter a Calibration Date

Save Calibration and Log Out

Introduction

WARNING

SHOCK HAZARD, LETHAL VOLTAGES Many models generate voltages greater than 60 VDC, with some models rated at 950 VDC! Ensure that all instrument connections, load wiring, and load connections are either insulated or covered using the safety covers provided, so that no accidental contact with lethal voltages can occur.

The instrument features closed-case electronic calibration; no internal mechanical adjustments are required. The instrument calculates correction factors based on input reference values that you set and stores correction factors in non-volatile memory until the next calibration adjustment is performed. This EEPROM calibration memory is not changed by cycling power or *RST.

Refer to the **Recommended Test Equipment and Setups** section for a list of the equipment and test setups required for calibration. Also refer to the **Measurement Setups** section for information about connecting the voltmeter, current shunt, and load. Additional information about calibration follows.

- The correct password is required to enter the Admin menu, which contains the calibration function. The password is pre-set to 0 (zero). You can change the password once calibration mode is entered to prevent unauthorized access to the calibration mode. Refer to **Password Protection** for more information.
- When calibrating the unit using SCPI commands, most steps involve sending a *OPC? query to synchronize with the power supply's command completion before proceeding. The response from the instrument must be read each time *OPC? is given. In some steps, it may take up to 30 seconds for *OPC? to respond.

- Once started, you must complete each calibration section in its entirety. As each calibration section is completed, the instrument calculates new calibration constants and begins using them. However, these constants are not saved in nonvolatile memory until a SAVE command is explicitly given.
- Exit the calibration mode either by logging out of the Admin menu or by sending CAL:STAT OFF. Note that any calibration section that was calibrated but not saved will revert to its previous calibration constants.

Calibration Interval

One Year Calibration Interval

The instrument should be calibrated on a regular interval determined by the accuracy requirements of your application. A **one-year** interval is adequate for most applications. Accuracy specifications are warranted only if adjustment is made at regular calibration intervals. Published accuracy specifications are not warranted beyond the one-year calibration interval.

Three Year Calibration Interval

Voltage and current programming and measurement accuracy specifications can be extended to a three-year period calibration interval by multiplying (or increasing) the one-year calibration accuracy specifications shown in the verification **Test Record Forms** by a factor of three.

Calibration Setups

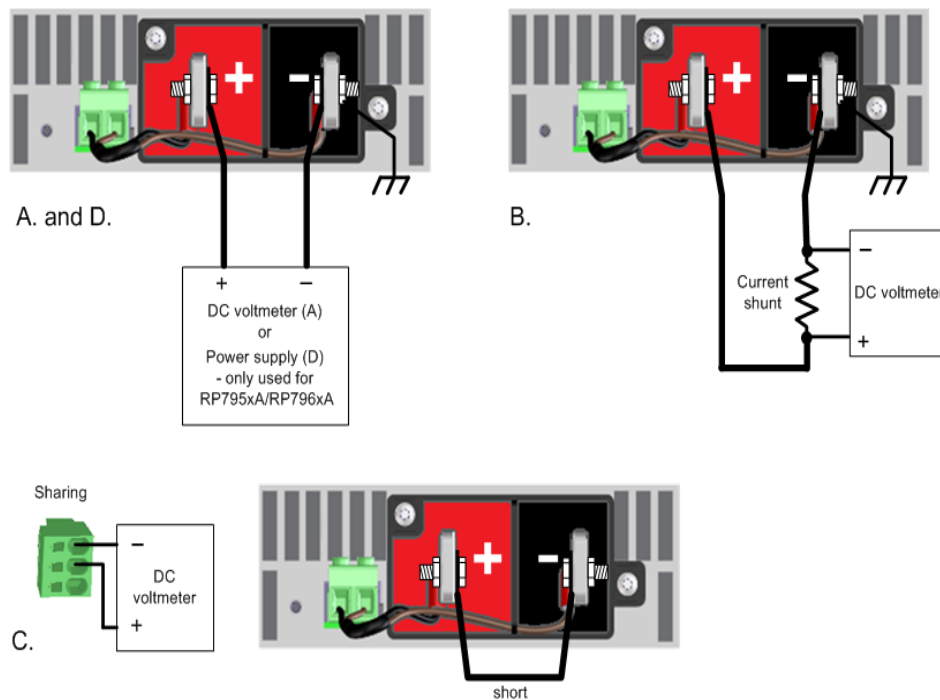

Test Considerations

For optimum performance, all verification and calibration procedures should comply with the following:

- Ambient temperature is stable, between 18 and 28 °C.
- Ambient relative humidity is less than 80%.
- 30 minute warm-up period before verification or adjustment.
- Cables as short as possible, twisted or shielded to reduce noise.

Calibration Procedure

Enter Calibration Mode

Front Panel Menu Reference	SCPI Command
Select System\Admin>Login . Enter your password in the Password field. Then press Select .	CAL:STAT ON <password>

Voltage Calibration

Voltage Programming and Measurement

Step 1. Connect the voltage input of the Keysight 3458A DMM to the output (see **Cal Setup A**).

Step 2. Select the voltage programming and measurement calibration.

Front Panel Menu Reference	SCPI Command
Select System\Admin\Cal\Vprog . Check that the voltmeter is connected and select Next .	Specify the full-scale voltage range. Full scale ranges vary by model. This selects the 500 V range: CAL:VOLT 500

Step 3. Select the first voltage calibration point. Measure the output voltage with the DMM and enter the data.

Front Panel Menu Reference	SCPI Command
Display shows: "Enter P1 measured data". Enter the data from the external DMM. Press Enter when done.	CAL:LEV P1 *OPC? CAL:DATA <data>

WARNING

The next step applies the full output voltage of the unit under test to the output.

Step 4. Select the second voltage calibration point. Measure the output voltage with the DMM and enter the data.

Front Panel Menu Reference	SCPI Command
Display shows: "Enter P2 measured data". Enter the data from the external DMM. Press Enter when done. Press Back to finish.	CAL:LEV P2 *OPC? CAL:DATA <data>

Current Temperature Coefficient Calibration RP793xA, RP794xA

NOTE

The temperature coefficient calibration procedure must be performed **Before** any other current calibration procedures.

Step 1. Connect a precision shunt resistor to the output. The shunt resistor should be able to measure the output's **full-scale** current (see **Cal Setup B**). Connect the Keysight 3458A DMM across the shunt resistor.

Step 2. Select the temperature coefficient calibration.

Front Panel Menu Reference	SCPI Command
Select System\Admin\Cal\Misc\CurrTC . Check that the shunt is connected and select Next.	CAL:CURR:TC

Step 3. Select the first current calibration point. Wait 5 minutes for the temperature to settle. Calculate the shunt current ($I=V/R$) and enter the data.

Front Panel Menu Reference	SCPI Command
Display shows: "Enter P1 measured data". This should be about 50% of the full-scale current rating. Press Enter when done.	CAL:LEV P1 *OPC? CAL:DATA <data>

Step 4. Select the second current calibration point. Wait 5 minutes for the temperature to settle. Calculate the shunt current ($I=V/R$) and enter the data.

Front Panel Menu Reference	SCPI Command
Display shows: "Enter P2 measured data". Enter the data from the external DMM. This should be about 80% of the full-scale current rating. Press Enter when done.	CAL:LEV P2 *OPC? CAL:DATA <data>

Step 5. Select the third current calibration point. Wait 5 minutes for the temperature to settle. Calculate the shunt current ($I=V/R$) and enter the data.

Front Panel Menu Reference	SCPI Command
Display shows: "Enter P3 measured data". Enter the data from the external DMM. This should be about 100% of the full-scale current rating. Press Enter when done. Press Back to finish.	CAL:LEV P3 *OPC? CAL:DATA <data>

Current Calibration

Current Programming and Measurement

Step 1. Disconnect all equipment from the output terminals.

Step 2. Select the current programming and measurement calibration.

Front Panel Menu Reference	SCPI Command
Select System\Admin\Cal\Curr\Iprog . Check that nothing is connected to the output and select Next.	Specify the full-scale current range. Full scale ranges vary by model. This selects the 20 A range: CAL:CURR 20

Step 3. Wait 5 minutes for the temperature to settle. Select the first current calibration point.

Front Panel Menu Reference	SCPI Command
Wait 5 minutes, then select Next again.	CAL:LEV P1 *OPC?

Step 4. Connect a precision shunt resistor to the output. The shunt resistor should be able to measure at least 70% of the output's full-scale current (see **Cal Setup B**). Connect the Keysight 3458A DMM across the shunt resistor.

Front Panel Menu Reference	SCPI Command
Check that the shunt is connected and select Next.	Not applicable

Step 5. Select the second current calibration point. Wait 5 minutes for the temperature to settle. Calculate the shunt current ($I=V/R$) and enter the data.

Front Panel Menu Reference	SCPI Command
Display shows: "Enter P2 measured data". Enter the data from the external DMM. This should be about 70% of the full-scale current rating. Press Enter when done. Press Back to finish.	CAL:LEV P2 *OPC? CAL:DATA <data>

Current Sharing Calibration RP795xA, RP796xA

This procedure calibrates the Imon signal that is used when units are connected in parallel.

Step 1. Connect a short across the + and - output terminals. Connect the Keysight 3458A DMM across pins 2 and 3 of the Sharing connector (see **Cal Setup C**).

Step 2. Select the current sharing calibration.

Front Panel Menu Reference	SCPI Command
Select System\Admin\Cal\Misc\CurrShar . Check that the short is connected and select Next.	CAL:CURR:SHAR

Step 3. Select the first calibration point. Measure the voltage across the sharing connector and enter the data.

Front Panel Menu Reference	SCPI Command
Display shows: "Enter P1 measured data". Enter the data from the external DVM. This should be about 1 volt. Press Enter when done. Press Back to finish.	CAL:LEV P1 *OPC? CAL:DATA <data>

Step 4. After the calibration completes, disconnect the voltmeter and short.

Resistance Bottom-Out Calibration RP795xA, RP796xA

This procedure calibrates the minimum voltage that can be achieved while sinking current.

Step 1. Connect an external power supply to the + and - output terminals (see [Cal Setup D](#)).

Step 2. Set the external supply as follows: Voltage setting = $(0.9 \text{ V} + 0.08 * \text{maximum output voltage of the unit under test})$. The voltage must be within 10% of this value. Current limit = $(0.95 * \text{rated output current of the unit under test})$. The current limit must be within 2% of this value.

Step 3. Select the resistance bottom-out calibration. Calibration takes approximately 5 seconds.

Front Panel Menu Reference	SCPI Command
Select System\Admin\Cal\Misc\ResBout . Check that the power supply is connected and select Next.	CAL:RES:BOUT *OPC?

Step 4. After the calibration completes, disconnect the power supply.

Enter a Calibration Date

Front Panel Menu Reference	SCPI Command
Select System\Admin\Cal\Date . Enter the calibration date in the Date field. If desired, you can enter alphanumeric data in this field.	CAL:DATE "<date>"

Save Calibration and Log Out

Front Panel Menu Reference	SCPI Command
Select System\Admin\Cal\Save . Select Save to save all calibration data.	To save calibration data: CAL:SAVE
Select System\Admin\Logout to exit calibration mode.	To exit calibration mode: CAL:STAT OFF

Test Record Forms

Keysight RP7951A/RP7961A

RP7951A/RP7961A Test Record		Report Number _____	Date _____	
Test Description	Model	Min. Specs	Results	Max. Specs
Voltage Programming & Readback				
Minimum voltage (Vout):	Both	0.43985	_____	0.56015
Voltage measured over interface:	Both	Vout - 0.08015	_____	Vout + 0.08015
High voltage (Vout):	Both	499.79	_____	500.21
Voltage measured over interface:	Both	Vout - 0.230	_____	Vout + 0.230
CV Load Effect:				
	Both	- 0.030	_____	+ 0.030
CV Ripple and Noise				
peak-to-peak:	Both	N/A	_____	0.500
rms:	Both	N/A	_____	0.100
Transient response @ 500 µs:				
	Both	- 1.25	_____	+ 1.25
Current Programming & Readback				
Minimum current (Iout):	Both	- 0.012	_____	0.012
Current measured over interface:	Both	Iout - 0.012	_____	Iout + 0.012
High current (Iout):	Both	19.968	_____	20.032
Current measured over interface:	Both	Iout - 0.032	_____	Iout + 0.032
CC Load Effect:				
	Both	- 0.009	_____	+ 0.009
Current Sink Tests				
100% of current rating:	Both	- 20.032	_____	- 19.968
RP7951A/RP7961A UUT Settings		RP7972A Load Settings *		
Voltage Programming & Readback Min:	Voltage priority: 0.5 V, 10.25 A	not used		
Voltage Programming & Readback High:	Voltage priority: 500 V, 10.25 A	not used		
CV Load Effect, CV Ripple and Noise:	Voltage priority: 250 V, 20.5 A	Current priority: 255 V, -20 A		
Transient Response:	Voltage priority: 250 V, 20.5 A	Current priority: 285 V, -10 A to -20 A, slew=max		
Current Programming & Readback Min:	Current priority: 255 V, 0 A	Voltage priority: 250 V, 0 A		
Current Programming & Readback High:	Current priority: 255 V, 20 A	Voltage priority: 250 V, -20.5 A		
CC Load Effect:	Current priority: 510 V, 10 A	Voltage priority: 500 V, -10.25 A		
100% of current rating (Isink):	Current priority: 255 V, - 20 A	Voltage priority: 250 V, -20.5 A		

* **CAUTION** set OVP to 110% of DUT voltage rating

Keysight RP7952A/RP7962A

RP7952A/RP7962A Test Record	Report Number _____	Date _____		
Test Description	Model	Min. Specs	Results	Max. Specs
Voltage Programming & Readback				
Minimum voltage (Vout):	Both	0.43985	_____	0.56015
Voltage measured over interface:	Both	Vout - 0.08015	_____	Vout + 0.08015
High voltage (Vout):	Both	499.78	_____	500.21
Voltage measured over interface:	Both	Vout - 0.230	_____	Vout + 0.230
CV Load Effect:	Both	- 0.030	_____	+ 0.030
CV Ripple and Noise				
peak-to-peak:	Both	N/A	_____	0.500
rms:	Both	N/A	_____	0.100
Transient response @ 500 μ s:	Both	- 1.25	_____	+ 1.25
Current Programming & Readback				
Minimum current (Iout):	Both	- 0.024	_____	0.024
Current measured over interface:	Both	Iout - 0.024	_____	Iout + 0.024
High current (Iout):	Both	39.936	_____	40.064
Current measured over interface:	Both	Iout - 0.064	_____	Iout + 0.064
CC Load Effect:	Both	- 0.017	_____	+ 0.017
Current Sink Tests				
100% of current rating:	Both	- 40.064	_____	- 39.936
RP7952A/RP7962A UUT Settings		RP7972A Load Settings *		
Voltage Programming & Readback Min:	Voltage priority: 0.5 V, 20.5 A	not used		
Voltage Programming & Readback High:	Voltage priority: 500 V, 20.5 A	not used		
CV Load Effect, CV Ripple and Noise:	Voltage priority: 250 V, 41 A	Current priority: 255 V, -40 A		
Transient Response:	Voltage priority: 250 V, 41 A	Current priority: 285 V, -20 A to -40 A, slew=max		
Current Programming & Readback Min:	Current priority: 255 V, 0 A	Voltage priority: 250 V, 0 A		
Current Programming & Readback High:	Current priority: 255 V, 40 A	Voltage priority: 250 V, -41 A		
CC Load Effect:	Current priority: 510 V, 20 A	Voltage priority: 500 V, -20.5 A		
100% of current rating (Isink):	Current priority: 255 V, - 40 A	Voltage priority: 250 V, -41 A		

* **CAUTION** set OVP to 110% of DUT voltage rating

Keysight RP7953A/RP7963A

RP7953A/RP7963A Test Record		Report Number _____	Date _____	
Test Description	Model	Min. Specs	Results	Max. Specs
Voltage Programming & Readback				
Minimum voltage (Vout):	Both	0.8797	_____	1.1203
Voltage measured over interface:	Both	Vout - 0.1603	_____	Vout + 0.1603
High voltage (Vout): *	Both	949.595	_____	950.405
Voltage measured over interface:	Both	Vout - 0.445	_____	Vout + 0.445
CV Load Effect:				
	Both	- 0.060	_____	+ 0.060
CV Ripple and Noise				
peak-to-peak:	Both	N/A	_____	1.000
rms:	Both	N/A	_____	0.200
Transient response @ 500 µs:				
	Both	- 2.375	_____	+ 2.375
Current Programming & Readback				
Minimum current (Iout):	Both	- 0.012	_____	0.012
Current measured over interface:	Both	Iout - 0.012	_____	Iout + 0.012
High current (Iout):	Both	19.968	_____	20.032
Current measured over interface:	Both	Iout - 0.032	_____	Iout + 0.032
CC Load Effect:				
	Both	- 0.009	_____	+ 0.009
Current Sink Tests				
100% of current rating:	Both	- 20.032	_____	- 19.968
RP7953A/RP7963A UUT Settings		RP7972A Load Settings *		
Voltage Programming & Readback Min:	Voltage priority: 1.0 V, 10.75 A	not used		
Voltage Programming & Readback High:	Voltage priority: 950 V, 10.75 A	not used		
CV Load Effect, CV Ripple and Noise:	Voltage priority: 500 V, 20.5 A	Current priority: 510 V, -20 A		
Transient Response:	Voltage priority: 500 V, 20.5 A	Current priority: 570 V, -10 A to -20 A, slew=max		
Current Programming & Readback Min:	Current priority: 510 V, 0 A	Voltage priority: 500 V, 0 A		
Current Programming & Readback High:	Current priority: 510 V, 20 A	Voltage priority: 500 V, -20.5 A		
CC Load Effect:	Current priority: 969 V, 10 A	Voltage priority: 950 V, -10.75 A		
100% of current rating (Isink):	Current priority: 510 V, - 20 A	Voltage priority: 500 V, -20.5 A		

* **CAUTION** set OVP to 110% of DUT voltage rating

Keysight RP7931A/RP7941A

RP7931A/RP7941A Test Record		Report Number _____	Date _____	
Test Description	Model	Min. Specs	Results	Max. Specs
Voltage Programming & Readback				
Minimum voltage (Vout):	Both	0.017996	_____	0.022004
Voltage measured over interface:	Both	Vout - 0.002004	_____	Vout + 0.002004
High voltage (Vout):	Both	19.994	_____	20.006
Voltage measured over interface:	Both	Vout - 0.006	_____	Vout + 0.006
CV Load Effect:				
	Both	- 0.001	_____	+ 0.001
CV Ripple and Noise				
peak-to-peak:	Both	N/A	_____	0.030
rms:	Both	N/A	_____	0.003
Transient response @ 300 μ s:				
	Both	- 0.20	_____	+ 0.20
Current Programming & Readback				
Minimum current (Iout):	Both	- 0.045	_____	0.045
Current measured over interface:	Both	Iout - 0.045	_____	Iout + 0.045
High current (Iout):	Both	399.795	_____	400.205
Current measured over interface:	Both	Iout - 0.205	_____	Iout + 0.205
CC Load Effect:				
	Both	- 0.025	_____	+ 0.025
Current Sink Tests				
100% of current rating:	Both	- 399.795	_____	- 400.205
RP7931A/RP7941A UUT Settings		RP7933A/RP7943A Load Settings		
Voltage Programming & Readback Min:	Voltage priority: 0.02 V, 204 A	not used		
Voltage Programming & Readback High:	Voltage priority: 20 V, 204 A	not used		
CV Load Effect, CV Ripple and Noise:	Voltage priority: 10 V, 408 A	Current priority: 10.2 V, -400 A		
Transient Response:	Voltage priority: 10 V, 408 A	For EL9160-300: CC mode, 50 A to 250 A, rise time=35 μ s*		
Current Programming & Readback Min:	Current priority: 10.2 V, 0 A	Voltage priority: 10 V, 0 A		
Current Programming & Readback High:	Current priority: 10.2 V, 400 A	Voltage priority: 10 V, -408 A		
CC Load Effect:	Current priority: 20.4 V, 200 A	Voltage priority: 20 V, -204 A		
100% of current rating (Isink):	Current priority: 10.2 V, - 400 A	Voltage priority: 10 V, -408 A		

* Use 1x or 2x EL9160-300 or equivalent; must have current rise time of 35 μ s or faster

Keysight RP7932A/RP7942A

RP7932A/RP7942A Test Record		Report Number _____	Date _____	
Test Description	Model	Min. Specs	Results	Max. Specs
Voltage Programming & Readback				
Minimum voltage (Vout):	Both	0.071984	_____	0.088016
Voltage measured over interface:	Both	Vout - 0.008016	_____	Vout + 0.008016
High voltage (Vout):	Both	79.976	_____	80.024
Voltage measured over interface:	Both	Vout - 0.024	_____	Vout + 0.024
CV Load Effect:				
	Both	- 0.003	_____	+ 0.003
CV Ripple and Noise				
peak-to-peak:	Both	N/A	_____	0.080
rms:	Both	N/A	_____	0.008
Transient response @ 300 μs:				
	Both	- 0.80	_____	+ 0.80
Current Programming & Readback				
Minimum current (Iout):	Both	- 0.013	_____	0.013
Current measured over interface:	Both	Iout - 0.013	_____	Iout + 0.013
High current (Iout):	Both	124.9495	_____	125.0505
Current measured over interface:	Both	Iout - 0.0505	_____	Iout + 0.0505
CC Load Effect:				
	Both	- 0.013	_____	+ 0.013
Current Sink Tests				
100% of current rating:	Both	- 124.9495	_____	- 125.0505
RP7932A/RP7942A UUT Settings		RP7935A/RP7945A Load Settings		
Voltage Programming & Readback Min:	Voltage priority: 0.08 V, 63.75 A	not used		
Voltage Programming & Readback High:	Voltage priority: 80 V, 63.75 A	not used		
CV Load Effect, CV Ripple and Noise:	Voltage priority: 40 V, 127.5 A	Current priority: 40.4 V, -125 A		
Transient Response:	Voltage priority: 40 V, 127.5 A	Current priority: 60 V, -50 A to -112.5 A, slew=2 A/μs		
Current Programming & Readback Min:	Current priority: 40.4 V, 0 A	Voltage priority: 40 V, 0 A		
Current Programming & Readback High:	Current priority: 40.4 V, 125 A	Voltage priority: 40 V, -127.5 A		
CC Load Effect:	Current priority: 80.8 V, 62.5 A	Voltage priority: 80 V, -63.75 A		
100% of current rating (Isink):	Current priority: 40.4 V, - 125 A	Voltage priority: 40 V, -127.5 A		

Keysight RP7933A/RP7943A

RP7933A/RP7943A Test Record		Report Number _____	Date _____	
Test Description	Model	Min. Specs	Results	Max. Specs
Voltage Programming & Readback				
Minimum voltage (Vout):	Both	0.017996	_____	0.022004
Voltage measured over interface:	Both	Vout - 0.002004	_____	Vout + 0.002004
High voltage (Vout):	Both	19.994	_____	20.006
Voltage measured over interface:	Both	Vout - 0.006	_____	Vout + 0.006
CV Load Effect:				
	Both	- 0.001	_____	+ 0.001
CV Ripple and Noise				
peak-to-peak:	Both	N/A	_____	0.030
rms:	Both	N/A	_____	0.003
Transient response @ 300 μ s:				
	Both	- 0.2	_____	+ 0.2
Current Programming & Readback				
Minimum current (Iout):	Both	- 0.090	_____	0.090
Current measured over interface:	Both	Iout - 0.090	_____	Iout + 0.090
High current (Iout):	Both	799.59	_____	800.41
Current measured over interface:	Both	Iout - 0.41	_____	Iout + 0.41
CC Load Effect:				
	Both	- 0.050	_____	+ 0.050
Current Sink Tests				
100% of current rating:	Both	- 799.59	_____	- 800.41
RP7933A/RP7943A UUT Settings		RP7933A/RP7943A Load Settings		
Voltage Programming & Readback Min:	Voltage priority: 0.02 V, 408 A	not used		
Voltage Programming & Readback High:	Voltage priority: 20 V, 408 A	not used		
CV Load Effect, CV Ripple and Noise:	Voltage priority: 10 V, 816 A	Current priority: 10.2 V, -800 A		
Transient Response:	Voltage priority: 10 V, 816 A	For EL9160-300: CC mode, 100 A to 500 A, rise time =35 μ s*		
Current Programming & Readback Min:	Current priority: 10.2 V, 0 A	Voltage priority: 10 V, 0 A		
Current Programming & Readback High:	Current priority: 10.2 V, 800 A	Voltage priority: 10 V, -816 A		
CC Load Effect:	Current priority: 20.4 V, 400 A	Voltage priority: 20 V, -408 A		
100% of current rating (Isink):	Current priority: 10.2 V, - 800 A	Voltage priority: 10 V, -816 A		

* Use 2x EL9160-300 or equivalent; must have current rise time of 35 μ s or faster

Keysight RP7935A/RP7945A

RP7935A/RP7945A Test Record		Report Number _____	Date _____	
Test Description	Model	Min. Specs	Results	Max. Specs
Voltage Programming & Readback				
Minimum voltage (Vout):	Both	0.071984	_____	0.088016
Voltage measured over interface:	Both	Vout - 0.008016	_____	Vout + 0.008016
High voltage (Vout):	Both	79.976	_____	80.024
Voltage measured over interface:	Both	Vout - 0.024	_____	Vout + 0.024
CV Load Effect:				
	Both	- 0.003	_____	+ 0.003
CV Ripple and Noise				
peak-to-peak:	Both	N/A	_____	0.080
rms:	Both	N/A	_____	0.008
Transient response @ 300 μs:				
	Both	- 0.80	_____	+ 0.80
Current Programming & Readback				
Minimum current (Iout):	Both	- 0.025	_____	0.025
Current measured over interface:	Both	Iout - 0.025	_____	Iout + 0.025
High current (Iout):	Both	249.9	_____	250.1
Current measured over interface:	Both	Iout - 0.1	_____	Iout + 0.1
CC Load Effect:				
	Both	- 0.025	_____	+ 0.025
Current Sink Tests				
100% of current rating:	Both	- 249.9	_____	- 250.1
RP7935A/RP7945A UUT Settings		RP7935A/RP7945A Load Settings		
Voltage Programming & Readback Min:	Voltage priority: 0.08 V, 127.5 A	not used		
Voltage Programming & Readback High:	Voltage priority: 80 V, 127.5 A	not used		
CV Load Effect, CV Ripple and Noise:	Voltage priority: 40 V, 255 A	Current priority: 40.4 V, -250 A		
Transient Response:	Voltage priority: 40 V, 255 A	Current priority: 60 V, -100 A to -225 A, slew=4 A/μs		
Current Programming & Readback Min:	Current priority: 40.4 V, 0 A	Voltage priority: 40 V, 0 A		
Current Programming & Readback High:	Current priority: 40.4 V, 250 A	Voltage priority: 40 V, -255 A		
CC Load Effect:	Current priority: 80.8 V, 125 A	Voltage priority: 80 V, -127.5 A		
100% of current rating (Isink):	Current priority: 40.4 V, - 250 A	Voltage priority: 40 V, -255 A		

Keysight RP7936A/RP7946A

RP7936A/RP7946A Test Record		Report Number _____	Date _____	
Test Description	Model	Min. Specs	Results	Max. Specs
Voltage Programming & Readback				
Minimum voltage (Vout):	Both	0.143968	_____	0.176032
Voltage measured over interface:	Both	Vout - 0.016032	_____	Vout + 0.016032
High voltage (Vout):	Both	159.952	_____	160.048
Voltage measured over interface:	Both	Vout - 0.048	_____	Vout + 0.048
CV Load Effect:				
	Both	- 0.006	_____	+ 0.006
CV Ripple and Noise				
peak-to-peak:	Both	N/A	_____	0.200
rms:	Both	N/A	_____	0.020
Transient response @ 300 μ s:				
	Both	- 1.6	_____	+ 1.6
Current Programming & Readback				
Minimum current (Iout):	Both	- 0.013	_____	0.013
Current measured over interface:	Both	Iout - 0.013	_____	Iout + 0.013
High current (Iout):	Both	124.9495	_____	125.0505
Current measured over interface:	Both	Iout - 0.0505	_____	Iout + 0.0505
CC Load Effect:				
	Both	- 0.013	_____	+ 0.013
Current Sink Tests				
100% of current rating:	Both	- 124.9495	_____	- 125.0505
RP7936A/RP7946A UUT Settings		RP7936A/RP7946A Load Settings		
Voltage Programming & Readback Min:	Voltage priority: 0.16 V, 63.75 A	not used		
Voltage Programming & Readback High:	Voltage priority: 160 V, 63.75 A	not used		
CV Load Effect, CV Ripple and Noise:	Voltage priority: 80 V, 125 A	Current priority: 80.8 V, -125 A		
Transient Response:	Voltage priority: 80 V, 62.5 A	Current priority: 120 V, -50 A to -112.5 A, slew=2 A/ μ s		
Current Programming & Readback Min:	Current priority: 80.8 V, 0 A	Voltage priority: 80 V, 0 A		
Current Programming & Readback High:	Current priority: 80.8 V, 125 A	Voltage priority: 80 V, -127.5 A		
CC Load Effect:	Current priority: 161.6 V, 62.5 A	Voltage priority: 160 V, -63.75 A		
100% of current rating (Isink):	Current priority: 80.8 V, - 125 A	Voltage priority: 80 V, -127.5 A		

7

Service and Maintenance

Introduction

Self-Test Procedure

Firmware Update

Instrument Sanitize

Calibration Switches

Battery Replacemst

Disassembly

Introduction

Repair Service Available

If your instrument fails during the warranty period, Keysight Technologies will repair or replace it under the terms of your warranty. After your warranty expires, Keysight offers repair services at competitive prices.

Many Keysight products have optional service contracts that extend coverage after the standard warranty expires.

Obtaining Repair Service (Worldwide)

To obtain service for your instrument, contact your nearest [Keysight Technologies Service Center](#). They will arrange to have your unit repaired or replaced, and can provide warranty or repair–cost information where applicable. Ask the Keysight Technologies Service Center for shipping instructions, including what components to ship. Keysight recommends that you retain the original shipping carton for return shipments.

Before Returning the Unit

Before returning the unit, make sure the failure is in the instrument rather than any external connections. Also make sure that the instrument was accurately calibrated within the last year (see [Calibration Interval](#)).

If the unit is inoperative, verify that:

- the AC power cord is securely connected to the instrument
- the AC power cord is plugged into a live outlet
- the front-panel Power On/Standby switch has been pushed

If self-test failed, verify that:

Ensure that all connections (front and rear) are removed when self-test is performed. During self-test, errors may be induced by signals present on external wiring, such as long test leads that can act as antennae.

Repackaging for Shipment

To ship the unit to Keysight for service or repair:

- Attach a tag to the unit identifying the owner and indicating the required service or repair. Include the model number and full serial number.
- Place the unit in its original container with appropriate packaging material.

- Secure the container with strong tape or metal bands.
- If the original shipping container is unavailable, Keysight strongly recommends obtaining one of the following packaging kits to ensure that the unit is not damaged in shipment:
 - P/N 5188-9520 - Packaging kit for models RP795xA/RP796xA
 - P/N 5188-9614 - Packaging kit for models RP793xA/RP794xA.

Keysight suggests that you always insure shipments.

Cleaning

WARNING SHOCK HAZARD To prevent electric shock, disconnect the AC mains before cleaning.

Clean the outside of the instrument with a soft, lint-free, slightly damp cloth. Do not use detergent. Disassembly is not required or recommended for cleaning.

Self-Test Procedure

Power-On Self-Test

Each time the instrument is powered on, a self-test is performed. This test assures you that the instrument is operational.

Self-test checks that the minimum set of logic and power mesh systems are functioning properly. Self-test does not enable the output or place any voltages on the output. It leaves the instrument in the **reset state**.

User-Initiated Self-Test

The user-initiated self-test is the same as the power-on self-test.

Front Panel Menu Reference	SCPI Command
Cycle ac power.	*TST?
If self-test fails, the front panel ERR indicator comes on. Press the Error key to display the list of errors.	If 0, self-test passed. If 1, self-test failed. If self test-fails, use SYSTem:ERRor? to view the self-test error.

For a list of errors, see **SCPI Error Messages**.

Firmware Update

NOTE

Refer to **Instrument Identification** to determine which firmware version is installed on your instrument. To obtain the latest firmware for the RP793xA and RP794xA series, go to www.keysight.com/find/RPSfirmware. To obtain the latest firmware for the RP795xA and RP796xA series, go to www.keysight.com/find/RPS2firmware.

Software Required

To update the firmware you need to download the following two items onto your computer from the RPS product page at the RPS firmware link referenced above.

- The Universal Firmware Update Utility
- The latest firmware version

Update Procedure

Once you have copied both items to your computer, proceed as follows:

1. Run the Universal Firmware Update Utility
2. Browse to the location of the firmware that you just downloaded. Press Next.
3. Select the interface that you are using to communicate with your instrument and enter the address or connections string. Press Next.
4. Verify that the information is correct for the instrument you are updating. Press Begin Update.

The update utility will now update the firmware and restart your instrument.

Restricting Access

Note that you can restrict access to the instrument by the firmware update utility. This prevents unauthorized users from updating the firmware.

Front Panel Menu Reference	SCPI Command
Select System\Admin\Update	Not available
Check the Must log in as admin box.	
This requires a user to log into the Admin menu before the firmware update utility performs a firmware update.	

Instrument Sanitize

NOTE

This procedure is not recommended for use in routine applications because of the possibility of unintended loss of data.

This procedure sanitizes all user data. It writes all zeros to flash memory and then performs a full chip erase as per the manufacturer's data sheet. Identification data such as instrument firmware, model number, serial number, MAC address, and calibration data is not erased. After the data is cleared, the instrument is rebooted.

If you cannot access the Admin menu, it may be password protected.

Front Panel Menu Reference	SCPI Command
Select System\Admin\Sanitize Select Sanitize. Selecting Sanitize removes all user-data from the instrument and cycles power.	SYST:SEC:IMM

Refer to <http://rfmw.em.keysight.com/aerospace/index.aspx> for detailed information.

Turn-on after Sanitization

The first time the unit is turned on after it has been sanitized, several NVRAM checksum errors will be generated. These errors annunciate the fact that two files were missing, which have been recreated with default values. The next time the unit turns on, there should be no errors.

Sanitizing an Inoperative Instrument

If the instrument is no longer functioning and you are unable to use the sanitization procedure described above, you must physically remove the P600 board from the instrument and destroy it. Refer to [Disassembly](#).

Calibration Switches

WARNING

SHOCK HAZARD Only qualified, service-trained personnel who are aware of the hazards involved should remove instrument covers. Always disconnect the power cable and any external circuits before removing the instrument cover. Some circuits are active and have power for a short time even when the power switch is turned off.

Two switches control the access to calibration commands. The switches are on the interface board and are accessible by removing the top cover.

Accessing the Calibration Switch

1. Remove the instrument cover as described under **Disassembly**.
2. The calibration switch is on the interface board at the rear corner of the unit. To change the calibration switch settings, use a small screwdriver to move the switches. As shipped, all switches are set toward the ON position (see below).
3. Replace the top cover when finished.

CAUTION

Do not use a pencil to move the switches. Any graphite dust that gets on the switches will conduct electricity.

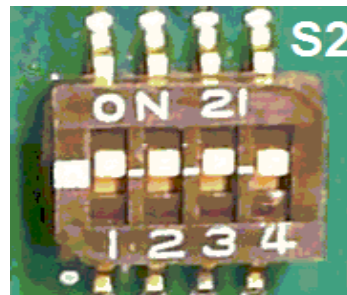
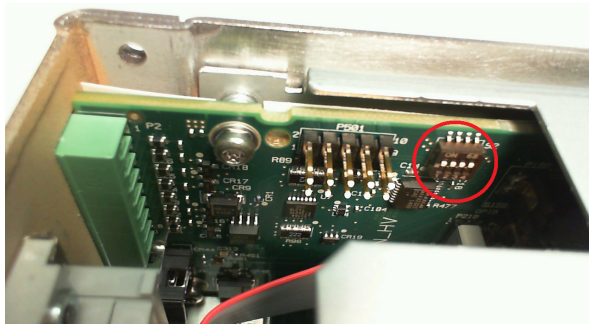

Switch Functions

Switches 1 and 2 set the calibration configuration as follows. Switches 3 and 4 are not used.

	Switch 1	Switch 2	Description
Normal	ON	ON	This is the as-shipped switch setting. The calibration functions are accessible after entering a numeric password. The default password is 0 (zero).
Clear Password	OFF	ON	The admin/calibration password is reset to 0 when the instrument is first powered on. Use this setting if you have forgotten the password.
Inhibit Calibration	ON	OFF	All calibration commands are disabled. This is useful where access is guarded by instrument seals.

Battery Replacement

WARNING

SHOCK HAZARD Only qualified, service-trained personnel who are aware of the hazards involved should remove instrument covers. Always disconnect the power cable and any external circuits before removing the instrument cover. Some circuits are active and have power for a short time even when the power switch is turned off.

The internal battery powers the real-time clock. The primary function of the clock is to provide time stamp information for the Keysight 14585A Control and Analysis Software. If the battery fails, the time will not be available for the software. No other instrument functions are affected.

Under normal use at room temperature, the lithium battery has a life expectancy between seven and ten years. Note that battery life will be reduced if the instrument is stored for a prolonged period at temperatures above 40 degrees C.

The part number of the battery is Panasonic CR 2032.

Replacement Procedure

1. Remove the instrument cover as described under **Disassembly**.
2. Remove the Control board as described under **Disassembly**.
3. The battery is located on the Constellation board under the ribbon cable.

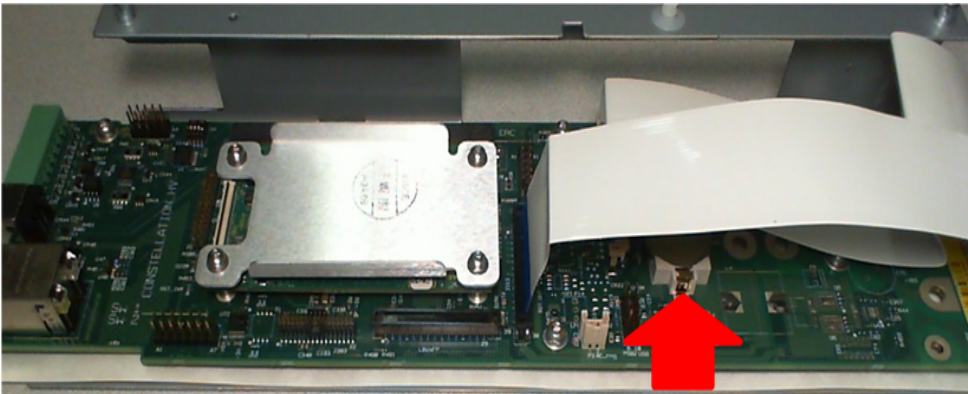

4. To access the battery, release the ribbon cables by pulling up on the locking tab.

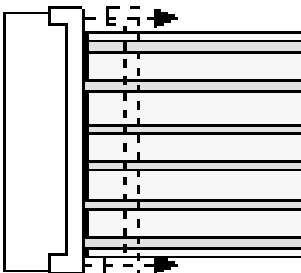

5. Use a flat-bladed screwdriver and carefully pry up on the side of the battery indicated by the arrow.

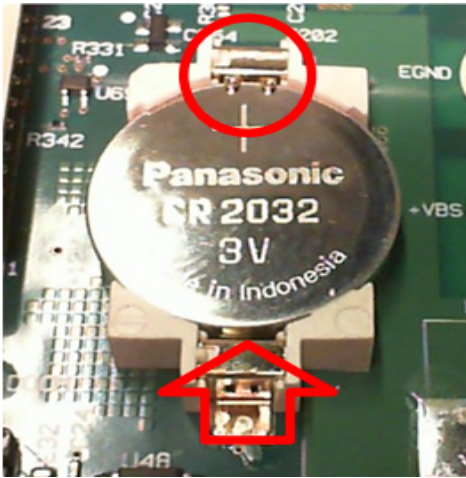

6. Install the new battery. Make sure that the positive side (+) is facing up. Place the battery *under* the small spring clips indicated by the circle, then push down on the opposite end of the battery indicated by the red arrow. The top of the small spring clips should be visible after the battery is seated (see red circle).
7. Replace the ribbon cables by fully inserting the cables into the connector; then pushing down on the locking tab to secure the cables.
8. Replace the Control board and top cover when finished.
9. Reset the date and time (see [Clock Setup](#)).

Disassembly

WARNING

SHOCK HAZARD Only qualified, service-trained personnel who are aware of the hazards involved should remove instrument covers. Always disconnect the power cable and any external circuits before removing the instrument cover. Some circuits are active and have power for a short time even when the power switch is turned off.

Electrostatic Discharge (ESD) Precautions

Almost all electrical components can be damaged by electrostatic discharge (ESD) during handling. Component damage can occur at electrostatic discharge voltages as low as 50 V.

The following guidelines will help prevent ESD damage during service operations:

- Disassemble instruments only in a static-free work area.
- Use a conductive work area to reduce static charges.
- Use a conductive wrist strap to reduce static charge accumulation.
- Minimize handling.
- Keep replacement parts in original static-free packaging.
- Remove all plastic, foam, vinyl, paper, and other static-generating materials from the immediate work area.

Tools Required

- T10 Torx driver for cover and board disassembly
- T8 Torx driver for P600 disassembly
- Small flat bladed screwdriver for battery removal

Cover Disassembly

1. Turn off the power. Remove all cables from the instrument.
2. Remove the 7 flat-head screws located on the top, the 10 flat-head screws along the sides, and the 3 pan-head screws on the back (see figure below). Place the screws in a container so that you do not lose them.
3. Remove the instrument cover.

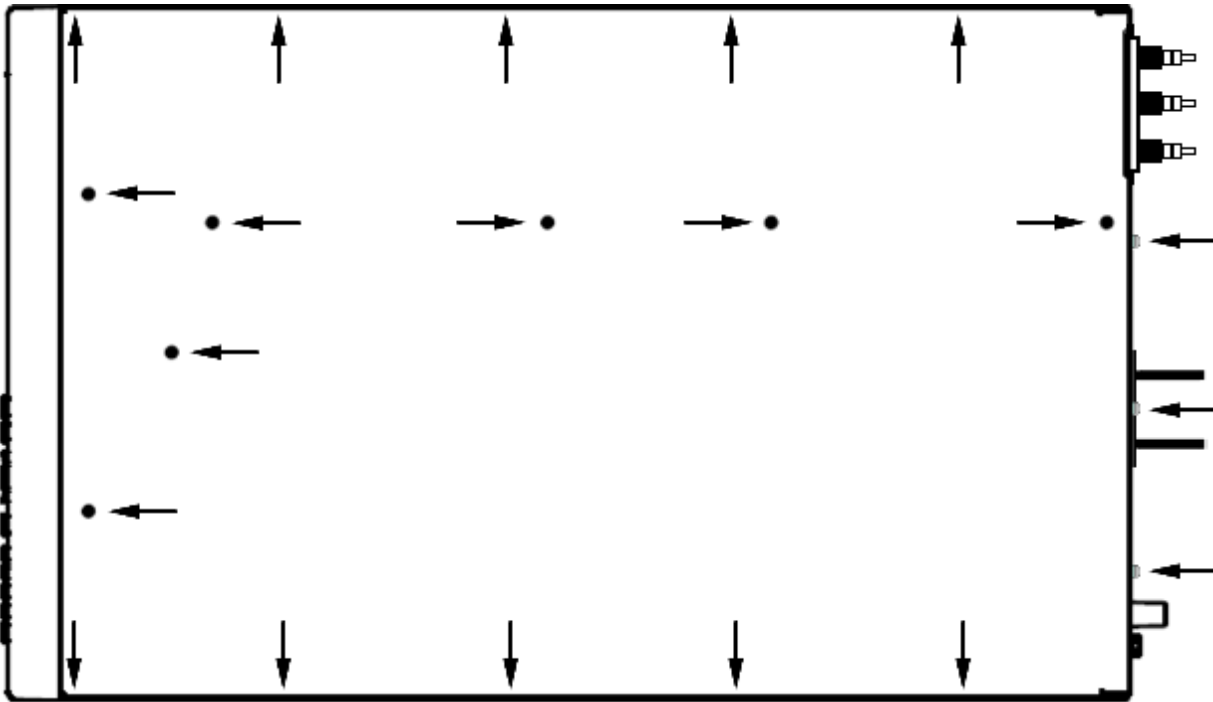

Control Board Disassembly

The Control board is located on the outside of the Constellation board. It must be removed to provide access to the battery and the P600 board, which are both located on the Constellation board.

1. As indicated below, first remove the two screws along the top of the Control board. Place the screws in a container so that you do not lose them.

RP793xA
RP794xA

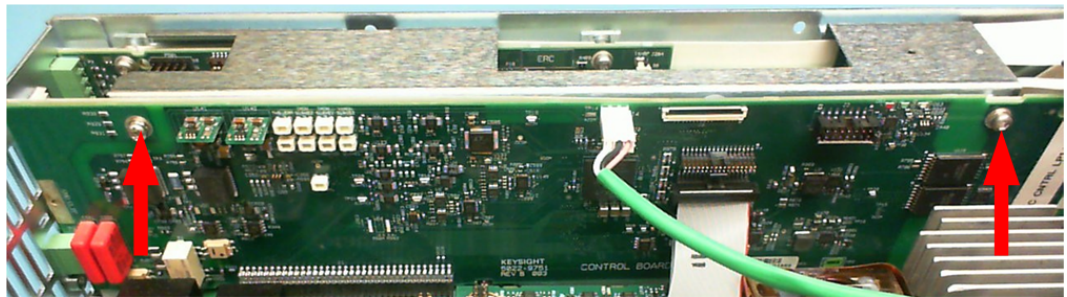

RP795xA
RP796xA

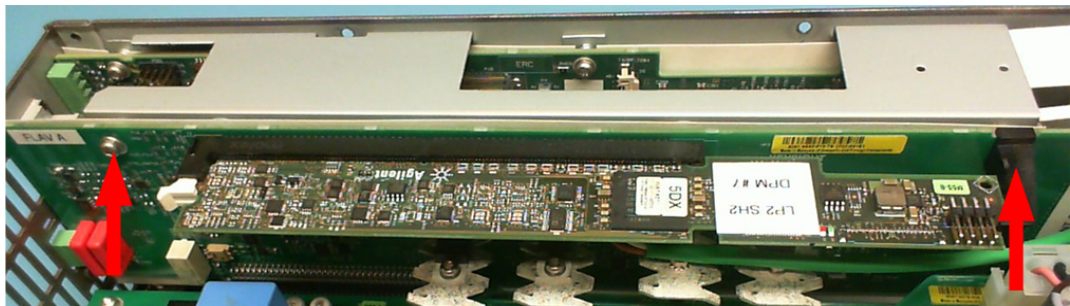

2. You can now lift the board out of its socket and move it to the side.
(When reassembling the Control board, don't forget to replace the insulator behind the board.)

Constellation Board Disassembly

If you have trouble accessing the Constellation board after you have moved the Control board out of the way, you can remove the Constellation board assembly.

1. Remove the three screws along the side of the chassis that attach the Constellation board. Place the screws in a container so that you do not lose them.

Remove
screws

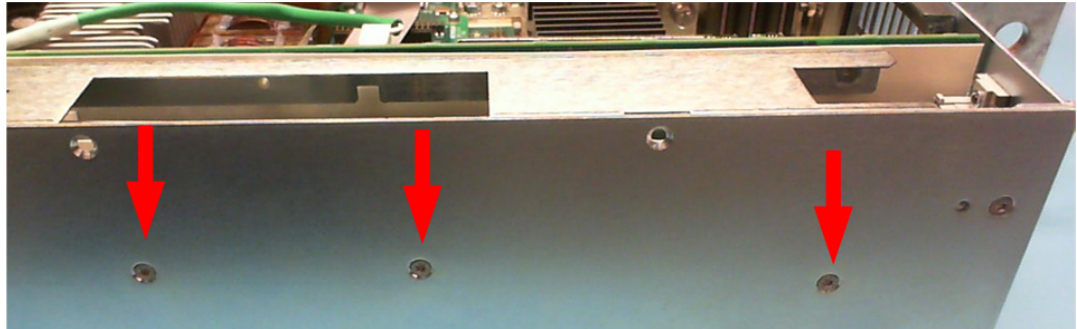

2. You can now lift the Constellation assembly out of the unit to access the P600 board and battery.
3. To access the P600 board, use a T8 Torx driver to remove the four heatsink screws. You can now remove the P600 board from its socket.

Remove 4
heatsink
screws to
remove the
P600 board

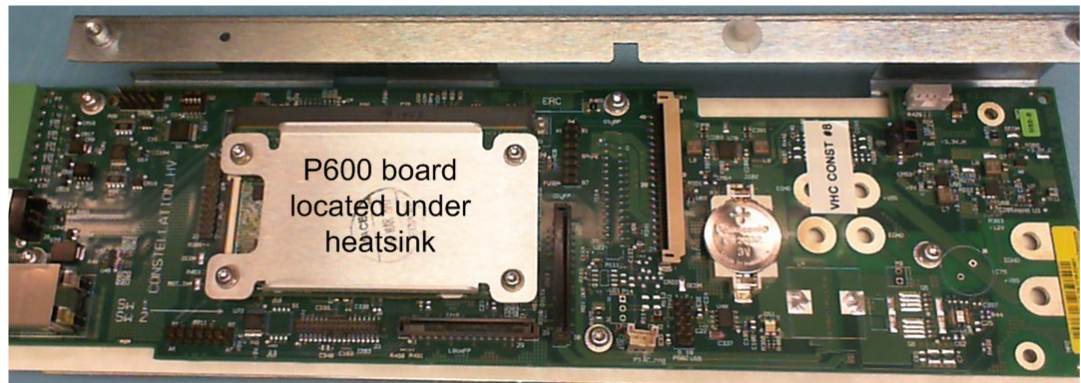

Appendix A

Keysight SD1000A Safety Disconnect System

Description

Installation

Operation

Keysight SD1000A Safety Disconnect System

Introduction

Safety Disconnect System at a Glance

Supplemental Characteristics

CAUTION

The Keysight SD1000A SDS with option 500 can only be used with Keysight Models RP7951A, RP7952A, RP7961A, and RP7962A.

The Keysight SD1000A SDS with option 950 can only be used with Keysight Models RP7953A and RP7963A.

Introduction

NOTE

All **legal and safety information** for the Keysight RP7900 series also applies to the Keysight SD1000A unit.

The Keysight SD1000A Safety Disconnect System (SDS) is an automated switching interface between the Keysight RP7900 series power supply and the unit under test (UUT). It is intended to ensure operator safety when the RP7900 power supply is used in a production environment. The SDS provides the interface between safety inputs such as an emergency stop switch or fixture cover switch and UUT, so that the operator is never exposed to harmful voltages when operating the test system.

The SDS contains redundant series-connected relays (two power and two sense relays) which provide an additional level of safety when disconnecting high voltage from the UUT. The SDS is connected to the Keysight RP7900 series power supply with a dedicated interface cable. Operation of the SDS is integrated into the Keysight RP7900 series to make it work as though the relays are internal to the power supply.

Keysight SD1000A Safety Disconnect System at a Glance

Front View

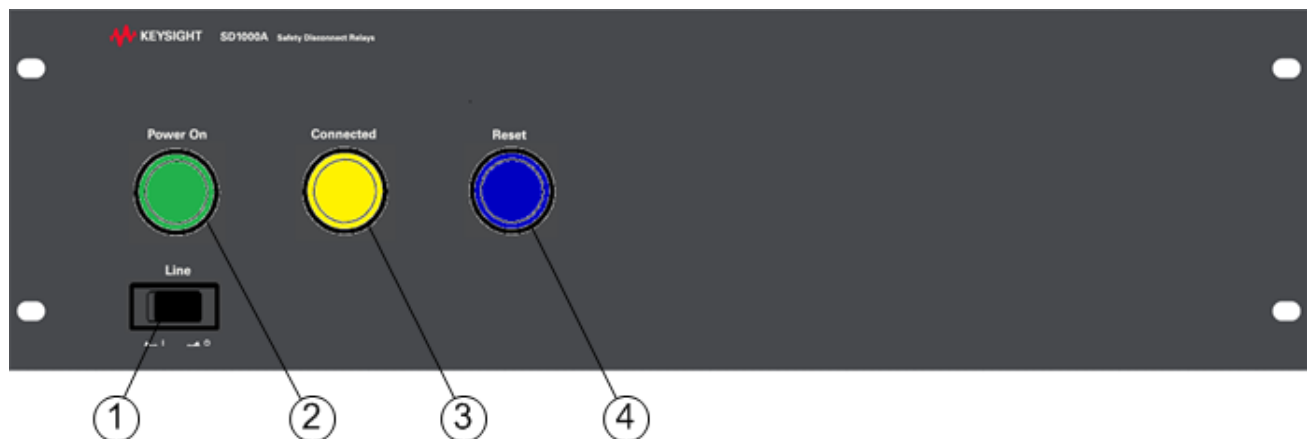

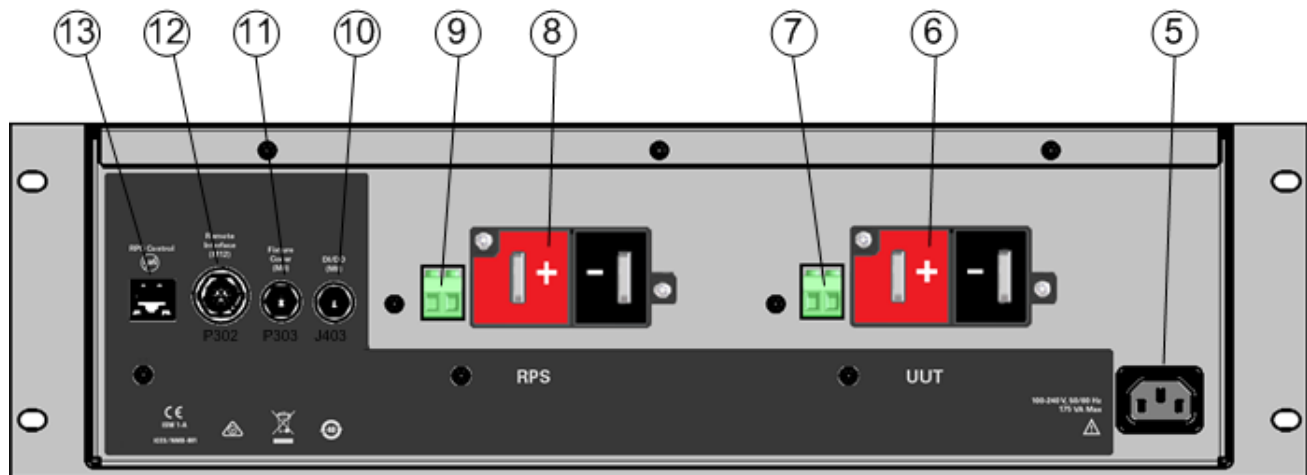
Rear View

1. **Line switch** Turns the unit on or off.
2. **Green Power On light** Indicates that the SDS unit has been turned on when illuminated
3. **Yellow Connected light** Indicates that one or more relays are closed when illuminated
4. **Blue Reset light** Indicates that the SDS must be reset when illuminated
5. **AC input** Universal AC input (100–240 VAC)
6. **UUT output terminals** + and - output connections for powering the UUT
7. **UUT sense terminals** ¹ + and - connections for local or remote sensing
8. **RPS input terminals** + and - input connections from the RP7900 unit
9. **RPS sense terminals** ¹ + and - connections for local or remote sensing
10. **DI/DO connector** Female connector for digital IO control
11. **Fixture Cover connector** Male connector for fixture cover (refer to **Cover switch**)
12. **Remote Interface connector** Male connector for status and control interface (refer to **ESTOP switch**)
13. **RPS Control interface** Interface connector for the RP7900 series power supplies

Note 1 As shipped, sense terminals are connected for local sensing.

Supplemental Characteristics

Supplemental characteristics are not warranted but are descriptions of performance determined either by design or by type testing. All supplemental characteristics are typical unless otherwise noted.

Characteristic	Keysight SD1000A
Power relay ratings	
Option 500:	500 VDC; 60 ADC
Option 950:	950 VDC; 60 ADC
Power relay, mechanical life:	1,000,000 cycles
Power relay, hot-switched life:	10,000 cycles
Sense relay life:	1,000,000 cycles
Discharge resistor	
Option 500:	25 k Ω , 10 W
Option 950:	97.5 k Ω , 10 W
Regulatory Compliance	
EMC:	Complies with European EMC Directive for test and measurement products Complies with Australian standard and carries C-Tick mark This ISM device complies with Canadian ICES-001 Cet appareil ISM est conforme à la norme NMB-001 du Canada
Safety:	Complies with European Low Voltage Directive and carries the CE-marking. Conforms to US and Canadian safety regulations. Declarations of Conformity for this product may be downloaded from the Web. Go to http://regulations.corporate.keysight.com and click on "Declarations of Conformity."
Environmental	
Operating environment:	Indoor use, installation category II (for AC input), pollution degree 2
Temperature range: ¹	0°C to 55°C
Relative humidity:	95% or less (non-condensing)
Altitude:	Up to 2000 meters
Storage temperature:	-30°C to 70°C
Output Terminal Isolation:	No output terminal may be more than \pm 950 VDC from any other terminal or chassis ground.
AC Input	
Nominal Rating:	Single phase; 100–240 VAC input, 50-60 Hz
Input Range:	86–264 VAC; 47–63 Hz
Power consumption:	150 W
Typical Weight	33 lbs (15 kg)

¹Maximum continuous power available is derated at 1% of rating per degree C from 40°C to 55°C

Dimensions

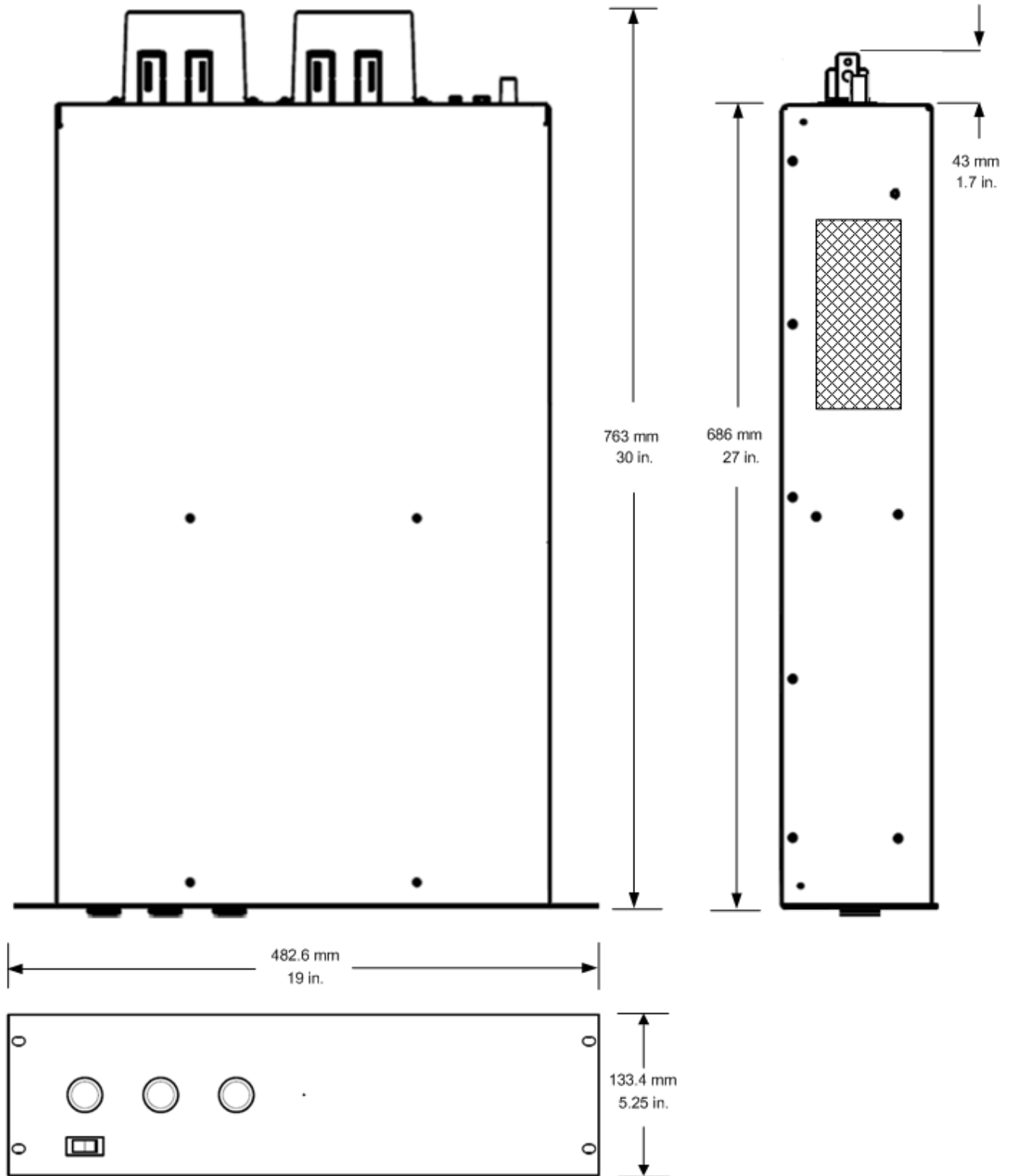

NOTE

The SDS is passive-cooled and does not require a fan or other cooling considerations - provided that the venting holes on the sides of the unit are not blocked.

Installing the Keysight SD1000A Safety Disconnect System

Keysight SD1000A-to-RP7900 Connections

External Control Connections

For items supplied, refer to **Items Supplied**. For detailed connection information and wire sizes, refer to **Single Unit Connections**.

Keysight SD1000A-to-RP7900 Connections

As shown in the following figures, Install the SDS unit as close as possible to the RP7900 series unit. Both units are designed to fit into a standard System II racks. Rack ears are built into the SDS unit.

If you are using a primary/secondary power supply configuration, the primary power supply must be connected to the SDS unit.

Simplified SDS Block Diagram

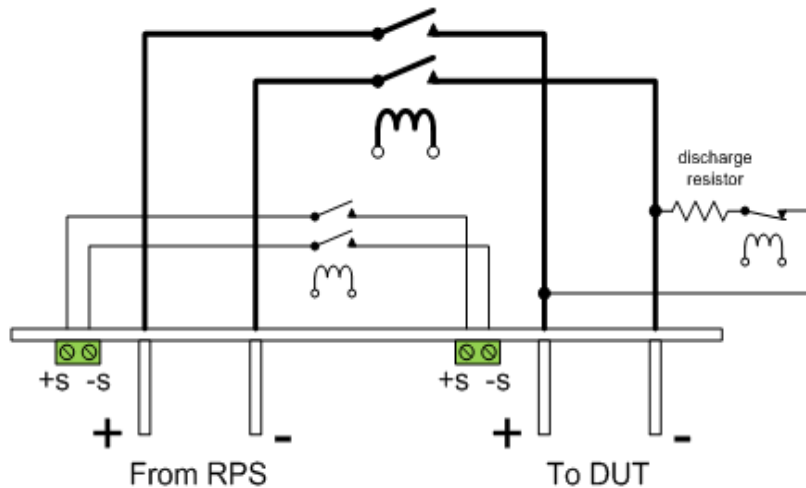

Wire Connections

The following factors should be considered when wiring the RPS, SDS, and DUT:

- Load wire current carrying capacity
- Load wire insulation rating must be equivalent to the maximum output voltage
- Load wire voltage drop, noise, and impedance effect

CAUTION

Tightening torque of the output bolts cannot exceed 10.8 Nm (8 lb-ft). Sense connections on the SDS unit must NOT be used when local sensing.

Connections with Local Sensing

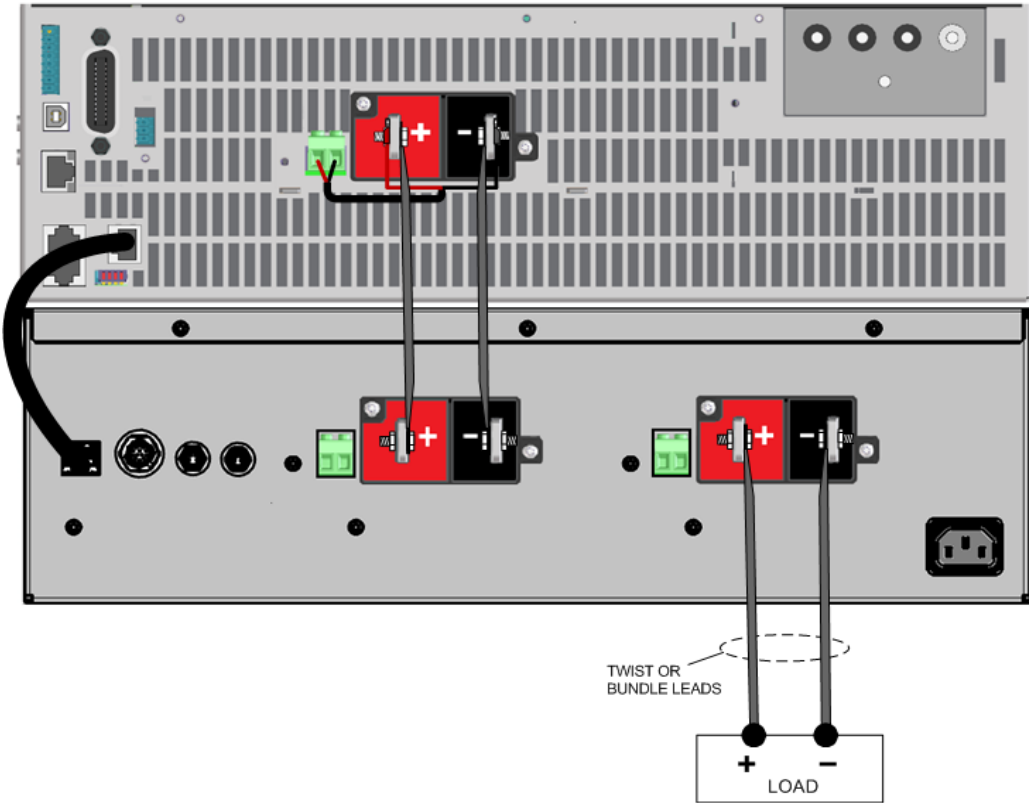

Connections with Remote Sensing

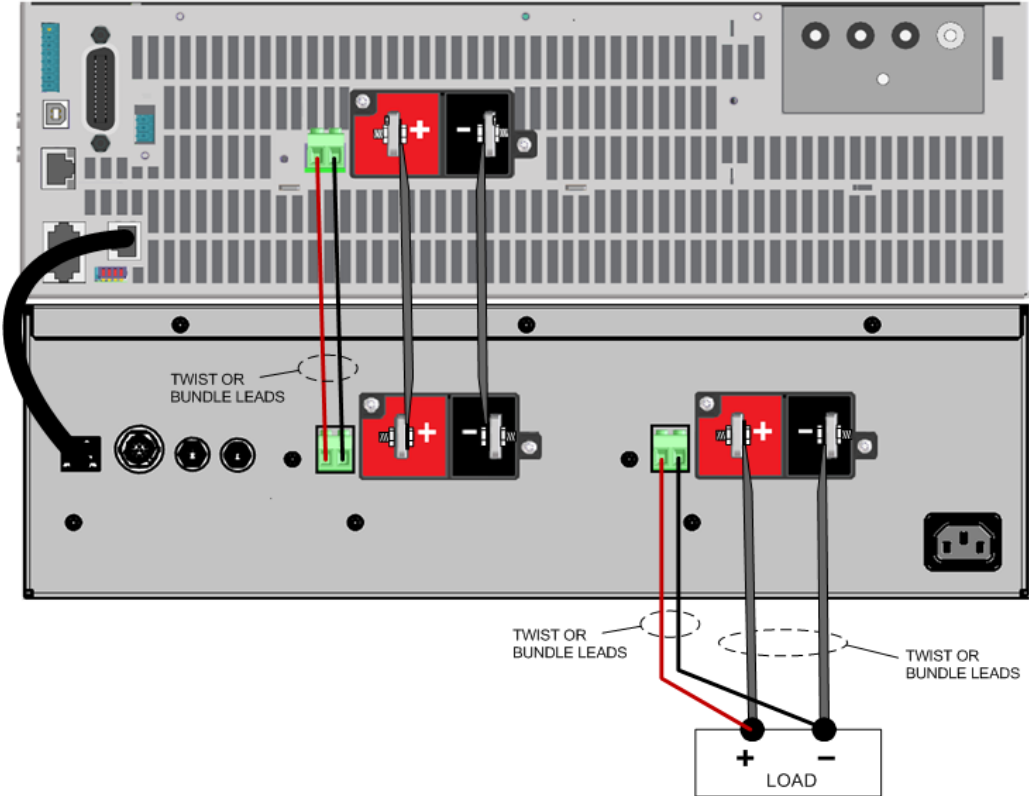

1. Connect the interface cable from the RP7900 unit to the SDS unit.
2. Connect the output of the RP7900 series to the input of the SDS unit.
3. Connect the output of the SDS unit to the device under test (the load).
4. If remote sensing is used, do NOT bundle the sense wire-pair together with the load leads; keep the load wires and sense wires separate.
5. Install the bus bar **safety covers**. Depending on how the units are wired, you may need to remove the bus bar cut-outs from the safety covers.

Connections with Paralleled Units

The limiting factor as to how many Keysight RP7900 units you can connect to one SDS unit is the current rating of the SDS relays, which is 60 A. For example, you can connect one 500 V, 10 kW unit and one 500 V, 5 kw unit to one SDS unit and still be within the maximum current rating of 60 A.

- In a primary/secondary configuration, connect the SDS interface cable to the primary RP7900 unit.
- For detailed connection information for paralleled units, refer to **Multiple Unit Connections**.
- If remote sensing is being used, connect the sense leads of both RP7900 units to the **RPS** sense terminals on the SDS unit.
- If multiple RPS units are used in a paralleled group, each 60 A group will require its own dedicated SDS unit.

External Control Connections

Several customer-configurable functions are available on the rear panel of the SDS (see **Controlling the SDS Using Externally Wired Controls**). The connectors and pin-out functions are described as follows:

Remote Interface (M12) Connector

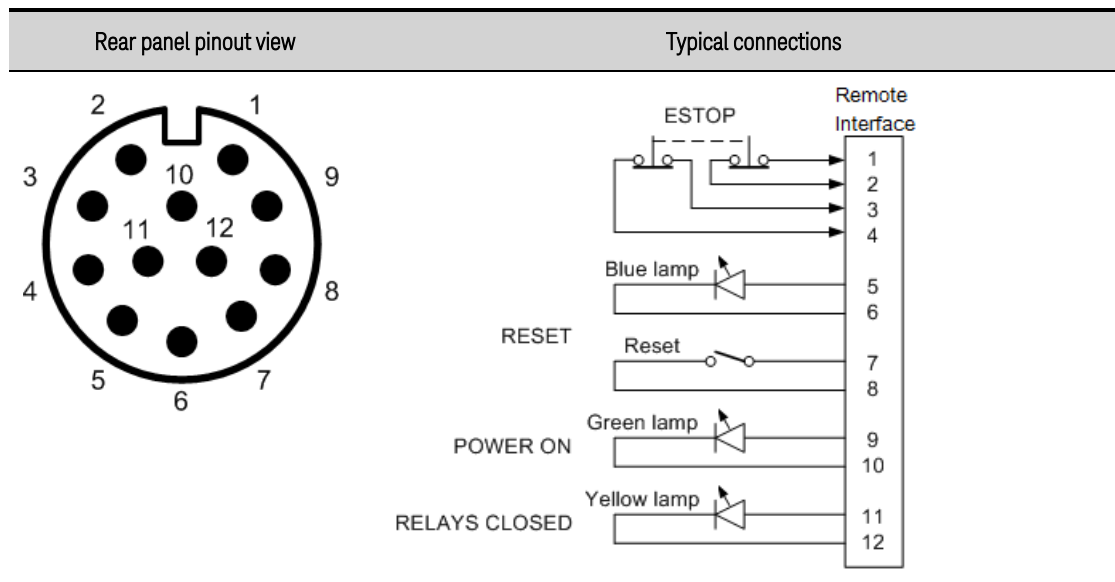

Pin	Description
1	ESTOP switch , pins 1-2 switch contact normally-closed
2	ESTOP switch , pins 1-2 switch contact normally-closed
3	ESTOP switch , pins 3-4 switch contact normally-closed
4	ESTOP switch , pins 3-4 switch contact normally-closed
5	RESET lamp (blue) +24V
6	RESET lamp (blue) 24V return
7	RESET switch , contact normally-open
8	RESET switch , contact normally-open
9	Power On lamp (green) +24V
10	Power On lamp (green) 24V return
11	Relays Closed lamp (yellow) +24V
12	Relays Closed lamp (yellow) 24V return

Fixture Cover (M8) Connector

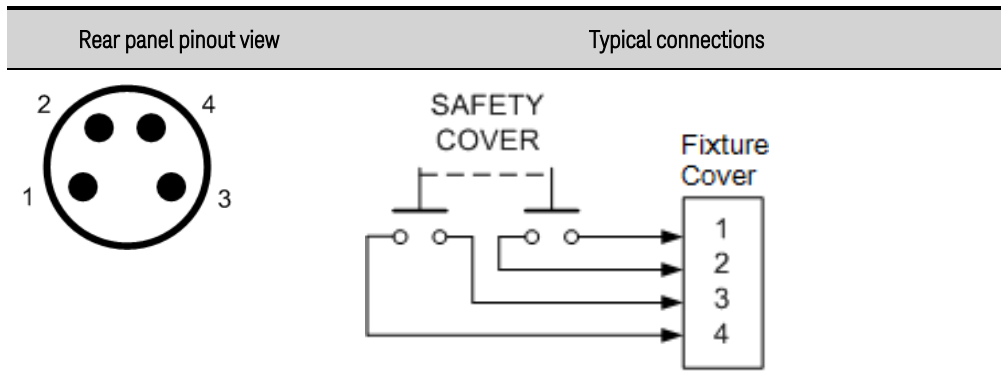

Pin	Description
1	Safety cover switch, pins 1-2 switch contact normally-open
2	Safety cover switch, pins 1-2 switch contact normally-open
3	Safety cover switch, pins 3-4 switch contact normally-open
4	Safety cover switch, pins 3-4 switch contact normally-open

DI/DO (M8) Connector

In Safety Disconnect mode the DI/DO inputs and outputs are intended to control an auxiliary AC contactor.

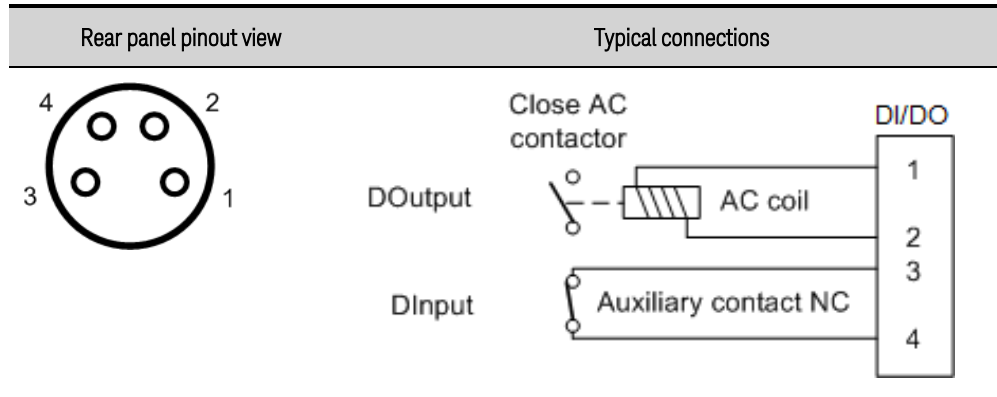

Pin	Description
1	DOutput, +24V drive signal for AC contactor (drive current ≤ 500 mA)
2	DOutput, 24V drive signal return
3	DInput, AC contactor OK when shorted to pin 4
4	DInput, AC contactor OK when shorted to pin 3

Mating Connector Part Numbers

Connector	Mates with	Phoenix Contact part number
M12 female	Remote Interface (M12)	1404420 (Wire gauge 24-28 AWG)
M8 female	Fixture Cover (M8)	1681185 (Wire gauge 22-28 AWG)
M8 male	DI/DO (M8)	1681169 (Wire gauge 22-28 AWG)

Typical Customer-supplied Components

Component	Description	Part number
ESTOP switch	2-pole NC, latching, compatible with 24V	Eaton C22-PVT45P-K02
RESET lamp/switch	Blue LED 24V with momentary contact NO switch	Eaton C22S-DL-B-K10-24
POWER ON lamp	Green LED 24V	Eaton C22-L-G-24
RELAYS CLOSED lamp	Yellow LED 24V	Eaton C22-L-Y-24
Safety cover switch	Mates directly with a magnetic relay	Pilz magnetic relay 504222
AC contactor	3-phase AC contactor with NC auxiliary contacts	Omron J7KNA-09-01

Operating the Keysight SD1000A Safety Disconnect System

Controlling the SDS Using the RP7900 Power Supply

Controlling the SDS Using Externally Wired Controls

Controlling the SDS Using the RP7900 series Power Supply

When connected to the RP7900 series power supply, the relays of the SDS automatically open and close along with the output state of the power supply.

Connecting to the SDS

Step 1. Make sure that the interface cable to the SDS has been installed (see [Installation](#)).

Step 2. Turn on the SDS first. The green Power On light on the SDS indicates that AC power is applied. The blue Reset light is also on because the SDS is not communicating with the RP7900 yet.

Step 3. Turn on the RP7900.

Step 4. Enable the SDS using the front panel of the RP7900 or the SCPI command.

Front Panel Menu Reference	SCPI Command
Select System\SDS	SYST:SDS:ENAB ON
Check <input checked="" type="checkbox"/> hardware present	

Step 5. Connect the SDS unit to the RP7900 power supply. If the attempt to connect to the SDS fails, the RP7900 unit will go into an **SDP protection**.

Front Panel Menu Reference	SCPI Command
Select System\SDS\Config	SYST:SDS:CONN
Click the Connect button to connect the SDS.	

Step 6. (optional) You can program the RP7900 to automatically connect to the SDS at power-on.

Front Panel Menu Reference	SCPI Command
Select System\SDS\Config	SYST:SDS:CONN:MODE AUTO
Select Auto in the Connect dropdown menu. Then press Select .	

Step 7. Check the connection status of the SDS as follows:

Front Panel Menu Reference	SCPI Command
Select System\SDS>Status	SYST:SDS:STAT?
The State dialog will indicate the connection status of the SDS.	

Normal Relay Open/Close Sequence

In normal operation, the RP7900 power supply directly controls the state of the SDS relays to prevent hot-switching the DC relays. The following is the normal closing sequence of the SDS and the power supply:

1. Close the power relays
2. Enable the power supply output
3. Up-program the power supply output
4. Close the sense relays

The following is the normal opening sequence of the SDS and power supply:

1. Disable the power supply output
2. Open the sense and power relays

You may choose to Lock the output relays of the SDS closed to improve the output response time for applications that do not require a physical output disconnect during normal output on/off operation of the RP7900 power supply (see **OUTput:RELAy:LOCK**).

The following is the latched "safe" state of the SDS after a safety disconnect event has occurred:

1. Power relays are open
2. Sense relays are open
3. "Connected" light is off
4. Power supply output is disabled
5. Discharge relays are closed and are discharging the DUT
6. Auxiliary output is disabled
7. General purpose output is disabled

As part of the safety-disconnect sequence, the SDS will discharge the UUT terminals to a level under 40V within three seconds. This provides for an additional level of safety at the UUT. This is accomplished by switching a 25 k Ω resistance for Option 500 and a 97.5 k Ω resistance for Option 950 across the output terminals of the SDS. In the unlikely event that UUT does not stop sourcing power, the SDS resistors are sized to tolerate the power draw continuously.

System Disconnect Protection

The RP7900 power supply periodically checks the status of the SDS. If at power-on or at any other time the SDS does not respond, the RP7900 will go into a latched System Disconnect Protection (SDP). If the SDS status indicates a fault condition, the RP7900 will also go into a latched SDP protection. Finally, latched protection will also occur if an external AC contactor is connected, but not active when the SDS relays are instructed to close.

A **SYST:SDS:STAT?** query can be used to determine the cause of an SDP.

An SDP protection can only be cleared by turning off the RP7900 unit, correcting the problem, and rebooting the RP7900 unit.

NOTE

The SDS has a watchdog timer that will also put it into a safe state if communication with the RP7900 unit is lost.

Controlling the SDS Using Externally Wired Controls

NOTE

The SDS must still be connected to the RP7900 when being controlled externally.

The external control lines described in this section must be wired to the appropriate connectors on the back of the SDS unit (see installation section). These external control lines provide an extra layer of operator safety, as they allow the SDS to be programmed externally of the RP7900 power supply.

Customer-supplied Emergency Stop (ESTOP) Switch

NOTE

If an Emergency Stop safety switch is not being used, you must short Remote Interface pin 1 to pin 2 and pin 3 to pin 4. If the pins are not shorted, there will be a SDP protection event - requiring power cycling.

The ESTOP safety switch must be a dual-channel normally-closed switch that when pressed, puts the SDS in a latched, safe state that includes opening the main and sense relays and discharging the unit under test. Pressing ESTOP is a latched safety state requiring the operator to reset the SDS to exit the safe state. The ESTOP signals are located on the Remote Interface connector on the SDS rear panel.

The opening sequence in response to an ESTOP event is as follows:

1. Open the power relays
2. Open the sense relays
3. Disable the power supply output
4. Discharge the UUT
5. Remain in this latched safety state until the ESTOP event is removed and the RESET switch is pressed

When the SDS is in ESTOP mode, the power supply indicates a status of Inhibit (INH). A SCPI query can be used to determine the cause of the power supply inhibit.

It is recommended to provide a reset switch for the operator to clear the SDS condition and turn the output back on (see Reset Switch).

Customer-supplied Reset Switch

RESET is a momentary-contact, operator input switch used to manually reset the SDS and exit the latched safety state. Once the ESTOP switches are closed or any other error condition is rectified, the operator must press the RESET switch to use the system again. The RESET switch must be an

illuminated blue switch that is located remotely, which indicates a reset is required when lit. An additional blue RESET lamp is also located on the SDS front panel. The RESET signals are located on the Remote Interface connector on the SDS rear panel.

The operation of the Reset lamps is defined as follows:

- Turns on when an ESTOP switch closes
- Turns on when an error condition occurs (loss of power, loss of communication, etc.)
- Turns off when ESTOP button is released and SDS and power supply are reset

Customer-supplied Fixture Cover Switches

NOTE

If a fixture cover is not being used, you must short Fixture Cover pin 1 to pin 2 and pin 3 to pin 4. If the pins are not shorted, there will be a SDP protection event - requiring power cycling.

Fixture cover switches must be dual-channel, normally-open switches that are mechanically interlocked to a safety cover. This safety cover must limit access to the UUT during normal operation. The fixture cover input is a non-resetting input. When the fixture cover is opened allowing access to the UUT, the fixture cover switches open - initiating a disconnect sequence. When the fixture cover is closed all switches close, returning the SDS to the previous state. The fixture cover signals are located on the Fixture Cover connector on the SDS rear panel.

The operating sequence of the SDS in response to an open fixture cover input is as follows:

1. Opens the power relays
2. Opens the sense relays
3. Disables the power supply output
4. Discharges the UUT
5. Returns the SDS and power supply to the prior state when the cover is closed

The SDS remains in the safe state as long as the fixture cover input is true (open). When the fixture cover is open, the power supply indicates a status of Inhibit (INH). A SCPI query can be used to determine the cause of the power supply inhibit.

Customer-supplied AC Contactor

NOTE

If an AC contactor is not being used, you must short DI/DO pin 3 to pin 4. If the pins are not shorted, there will be a SDP protection event - requiring power cycling.

A programmable general purpose output, +24V (DOutput-1) with a return (DOutput-2), is available on the DI/DO connector on the SDS rear panel to control the relay coil of an external AC contactor. Normally-closed auxiliary contacts from the AC contactor should also be wired to DInput-3 and DInput-4 to sense the state of the AC contactor. The DInput-DOutput combination form a safety handshake with the AC contactor.

Select the general purpose output as follows:

Front Panel Menu Reference	SCPI Command
Select System\SDS\Output	SYST:SDS:DIG:DATA:OUTP 1
Specify a 1 to enable the general purpose output. Then press Select.	

The operating mode of the SDS when an external AC contactor is installed is as follows:

- When either the SDS relays or the AC contactor is enabled (programmed to close), the SDS checks to see if the AC contactor is presently open (DInput-3 and DInput-4 shorted).
- If the digital input is shorted, the SDS relays and the contactor can be enabled and disabled.
- If the digital input is open without the contactor being enabled, the SDS goes into SDP protection.
- If the digital input opens after the contactor is enabled via the front panel or a SCPI command, the SDS relays can be enabled or disabled.
- The SDS contactor-check will reset when both the SDS relays and the contactor are disabled.

NOTE

The command processing time is much faster than the time it takes to change the relay state of the contactor. If you quickly send an AC contactor enable command, then an off command, and then another on command, the digital input could read an open causing the unit to go into protect.

External Control Status Information

You can return the status of the external control functions via the front panel of the power supply.

Front Panel Menu Reference	SCPI Command
Select System\SDS\Data\Input	not available
Safety Cover - closed or open	
EStop signal - off or on	
Relay Control - internal or external	
Remote start - off or on	

Index

*
*CLS 208
*ESE 208
*ESR? 208
*IDN? 209
*OPC 209
*OPC? 209
*OPT? 210
*RCL 210
*RST 210
*SAV 211
*SRE 211
*STB? 211
*TRG 212
*TST? 212
*WAI 212

A

ABORt Subsystem 188
AC dropout 118
AC input
 details 39, 56
AC mains
 considerations 70
 Delta and Wye type 71
Accessories 34
Air flow 65

Amp-hour
 measurements 157
ARB Subsystem 189
Average measurements 156

B

Battery replacement 308

C

CALibrate Subsystem 191
Calibration 286
 interval 287
 switches 307
 test equipment 276
Capacitive Load 45, 61
Characteristics
 common 37, 55
 RP7900 regenerative 36,
 54
Cleaning 13, 303
Clear Status 264
CLS 208, 264
command language
 quick reference 24
Command Separators 182
Command Terminators 182
communication remote inter-
 face 103
Compatibility
 Commands 272

Connections
 AC mains 70
 interface 93
 parallel 87
 primary/secondary 90
 series 92
 single unit 77
Contacting
 Keysight 15
Current 100
Current sharing 119
Current sinking 127
CURRent Subsyetem 195

D

data logging 152
DC Offset 102
DC Offset Voltage 102
DIGital Subsyetem 199
Disassembly 310
Display
 lockout 173
 saver 173
DISPlay Subsystem 201

E

EDP
 excessive dynamic pro-
 tection 129
End-Or-Identify 183

Environment 65
 Error Messages 264
 ESE 208
 ESR? 208

F

Factory Reset 210, 264
 features 16
 FETCh Subsystem 202
 FIFO 264
 Firmware Update 305
 First-in-first-out 264
 FORMat Subsystem 205
 front-panel menus 21
 front panel 17, 19-21
 FUNction Command 206

G

GPIB 264

H

HCOPy Subsystem 207
 Help 102
 Help system 102

I

I/O 264
 queue 264
 IDN? 209
 IEEE-488 Common Com-
 mands 208

Impedance graphs 41, 58
 Inductive Load 43, 59
 INITiate Subsystem 213
 Inspect 64
 Instrument
 identification 172
 Instrument Sanitize 306
 INSTrument Subsystem 214
 Introduction 181
 SCPI Language 181

K

Keywords 182

L

Legal information 9
 Limiting
 sinusoidal outputs 144
 LIST Subsyetem 216
 LXI Command 219

M

Maintenance 301
 Making Measurements 156
 MEASure Subsystem 220
 menus 21
 Message Available 211
 Models 33

N

Non-Volatile Settings 261

O

OPC 209
 OPC? 209
 OPT? 210
 Options 34
 Output
 current 100
 list 138
 sequencing 145
 transient 134
 Output Step 137
 OUTPut Subsystem 222
 Output Voltage 99
 over-current 128
 over-temperature 128
 over-voltage 128
 Over-voltage 101

P

Parallel operation 119
 Parameter Types 184
 Password
 setting 174
 POWer Query 228
 Primary/secondary
 operation 120
 programming 121
 Priority Mode
 current 176

- voltage 175
- Programming
 - ARB 142
 - bandwidth 115-116
 - current 113
 - current sinking 127
 - digital port 166
 - priority 112
 - protection 128
 - resistance 114
 - slew rate 114
 - transients 134
 - voltage 113
- Programming Response 51, 61

Q

- Queries 182
- Querying
 - Status Byte Register 211
- Questionable Data Summary 211
- Queue 264
 - I/O 264
- Quick command
 - reference 24

R

- Rack mounting 68
- RCL 210
- rear panel 18

- REfERENCE 24
- Regenerative
 - operation 17, 70
- remote interface 103
- Repackaging for shipment 302
- Repair service 302
- Reset State 259
- RST 210

S

- Safety 65
- Safety cover 79
- Safety Disconnect Unit
 - description 314
 - installation 318
 - operation 323
- Safety Notices 12
- SAV 211
- SCPI 181
 - quick reference 24
- SCPI Language 181
 - Introduction 181
- SCPI Status System 264
- Self-test 212
- Self-test procedure 304
- SENSe Subsystem 229
- Service 301
- Set DC Offset Voltage 102
- Set Output Current 100

- Set Output Voltage 99
- Set Over-voltage 101
- Sinusoidal outputs 144
- SOURce Subsystem 232
- Specifications
 - RP7900 regenerative 35, 53
- SRE 211
- Standard Event Summary 211
- Standard Operation Register 211
- Standard Operation Summary 211
- State storage 172
- Status Byte 211
- Status Byte Register 211
- Status Diagram 256
- STATus Subsystem 233
- Status Tutorial 252
- STB? 211
- STEP Command 237
- Subsystem commands 187
- Surge Protect 72
- Syntax Conventions 183
- SYSTEM Subsystem 238

T

- Test record forms 292
- TRG 212
- Trigger Diagram 258

TRIGger Subsystem 244

Trigger Tutorial 257

TST? 212

U

Using Device Clear 185

V

Verification 278

test equipment 276

Voltage 99

VOLTage Subsystem 247

W

WAI 212

Wait-for-trigger 212

Watt-hour

measurements 157

Systeme d'alimentations régénératrices Keysight Série RP7900

Guide d'utilisation
et de maintenance

Informations légales et de sécurité	9
Mentions légales	9
Symboles de sécurité	11
Consignes de sécurité	12
1 Aide-mémoire	15
Présentation de l'instrument	16
Présentation succincte du système d'alimentations régénératrices	16
Présentation succincte du panneau avant	18
Présentation succincte du panneau arrière	19
Présentation succincte de l'écran du panneau avant	20
Présentation succincte des touches du panneau avant	21
Aide-mémoire des menus du panneau avant	23
Aide-mémoire des commandes	26
Fonctionnalités et options des modèles	35
Fonctionnalités des modèles	35
Options/Accessoires	36
Spécifications et caractéristiques - RP793xA, RP794xA	37
Spécifications - RP793xA, RP794xA	37
Caractéristiques supplémentaires - RP793xA, RP794xA	39
Caractéristiques communes	40
Efficacité de l'entrée CA, facteur de puissance et DHT	42
Graphiques des impédances de sortie	45
Limite de charge inductive pour un fonctionnement en courant constant (CC)	47
Limite de charge capacitive pour un fonctionnement en tension constante (CV)	49
Réponse de programmation des signaux faibles (tous les modèles)	55
Précision et résolution de la mesure - avec des intervalles de mesure plus courts	55
Protection dynamique excessive	56
Quadrants de sortie	56
Spécifications et caractéristiques - RP795xA, RP796xA	58
Spécifications - RP795xA, RP796xA	58
Caractéristiques supplémentaires - RP795xA, RP796xA	60
Caractéristiques communes	61
Efficacité de l'entrée CA, facteur de puissance et DHT	63
Graphiques des impédances de sortie	65
Limite de charge inductive pour un fonctionnement en courant constant (CC)	66
Limite de charge capacitive pour un fonctionnement en tension constante (CV)	68
Réponse de programmation de la tension (Tous les modèles)	68
Protection dynamique excessive	69
Quadrants de sortie	70
2 Installation de l'instrument	71
Avant l'installation ou l'utilisation	72
Inspection de l'appareil	72
Vérification des composants livrés	72
Examen des informations de sécurité	73
Observation des conditions environnementales	73
Circulation d'air adéquate	74

Empilage des instruments	74
Schéma de principe pour : RP793xA et RP794xA	75
Schéma de principe pour : RP795xA et RP796xA	76
Montage en baie	77
Connexions de l'alimentation secteur	79
Caractéristiques communes de l'alimentation secteur	79
Considérations relatives à la distribution de courant alternatif de type triangle et étoile	80
Installation d'un limiteur de surtension	82
Connexions des câbles d'alimentation	83
Connexions de sortie d'un appareil unique	86
Connexions de sortie	86
Connexions de charge unique	88
Connexions de charges multiples	90
Connexions de mesure à distance	91
Autres considérations relatives à la charge - tous les modèles	94
Autres considérations relatives à la charge - RP793xA, RP794xA	94
Connexions de sortie de plusieurs appareils	98
Connexions en parallèle	98
Connexions de mesure et de charge	98
Connexions principale/secondaire - pour tous les modèles	101
Connexions de partage de courant - RP795xA, RP796xA	102
Connexions en série	103
Connexions de l'interface	105
Connexions GPIB	105
Connexions USB	106
Connexions réseau (LAN) - locales et privées	106
Connexions du port numérique	107
Installation du capot de l'interface	108
3 Mise en route	109
Utilisation du panneau avant	110
Mise sous tension de l'appareil	110
Définition de la tension de sortie	111
Définition du courant de sortie	112
Définition de la protection contre les surtensions	113
Activation de la sortie	114
Utilisation du système d'aide intégrée	114
Configuration de l'interface de commande à distance	115
Introduction	115
Configuration USB	115
Configuration GPIB	115
Configuration LAN	116
Modification des paramètres LAN	117
Utilisation de l'interface Web	120
Utilisation de Telnet	121
Utilisation de sockets	121
Verrouillage de l'interface	122

4 Utilisation du système d'alimentations régénératrices	123
Programmation de la sortie	124
Définir le mode de priorité de sortie	124
Définition de la tension de sortie	125
Définition du courant de sortie	126
Définir la vitesse de balayage	126
Définir la résistance de sortie	127
Définir la bande passante de sortie - RP795xA, RP796xA	127
Définir la bande passante de sortie - RP793xA, RP794xA	128
Régler le mode d'activation/désactivation de la sortie - RP793xA, RP794xA	131
Activation de la sortie	131
Fonctionnement en parallèle	133
Introduction	133
Fonctionnement principal/secondaire	134
Fonctionnement en parallèle indépendant - RP795xA, RP796xA	139
Utilisation de la fonction d'absorption de courant	142
Absorption de courant	142
Fonctionnement régénératif	142
Programmation de la protection des sorties	144
Introduction	144
Définir la protection contre les surtensions	146
Définir la protection contre les surintensités	147
Temporisateur de surveillance de la sortie	148
Définir la protection contre les sous-tensions	149
Supprimer la protection de la sortie	149
Programmation des transitoires de sortie	151
Transitoires de sortie	151
Actions communes à tous les transitoires	151
Programmation d'un transitoire de palier	155
Programmation d'un transitoire de liste	155
Programmation d'un signal arbitraire	160
Limitation des sorties sinusoïdales	162
Séquencement de la sortie	164
Délais d'activation/de désactivation	164
Couplage de la sortie	164
Séquencement de plusieurs appareils	165
Comportement d'activation/de désactivation de la sortie	168
Enregistrement de données externe	172
Enregistrement de données externe	172
Sélection de la fonction et de la gamme de mesure	173
Spécifier la période d'intégration	173
Sélectionner la source de déclenchement des données externes (Elog)	174
Démarrer et déclencher l'enregistrement de données externe	174
Récupérer régulièrement les données	175
Interrompre l'enregistrement de données externe (Elog)	175
Réalisation de mesures	176
Mesures moyennes	176

Balayage de mesure	176
Fenêtrage de la mesure	177
Mesures A-heures et W-heures	177
Mesures numérisées	178
Déclenchement de la mesure	180
Programmation du port numérique	186
Port de commande numérique	186
Entrées/sorties numériques bidirectionnelles	187
Entrée numérique	188
E/S de déclenchement externe	188
Sortie de défaillance	189
Entrée d'inhibition	189
Protection du système de défaillance/inhibition	190
Commande de couplage des sorties	191
Opérations système	193
Identification de l'instrument	193
Stockage des configurations de l'instrument	193
Affichage du panneau avant	194
Verrouillage du panneau avant	195
Protection par mot de passe	195
Clock Setup (Réglage de l'horloge)	196
Didacticiel du mode de priorité	197
Priorité de tension	197
Priorité de courant	198
5 Aide-mémoire de la programmation SCPI	201
Logiciels associés	202
Présentation du SCPI	203
Introduction	203
Mots-clés	204
Requêtes	204
Séparateurs et caractères de fin de commande	204
Conventions syntaxiques	205
Types de paramètres	206
Device Clear	207
Temps de traitement de commande type	208
Commandes par sous-système	209
Sous-système ABORt	210
Sous-système ARB	211
Sous-système CALibrate	213
Sous-système CURRent	217
Sous-système DIGital	222
Sous-système DISPlay	224
Sous-système FETCh	225
Sous-système FORMat	228
Commande FUNCtion	229
Sous-système HCOPy	230
Commandes courantes IEEE-488	231

Sous-système INITiate	237
Sous-système INSTRument	238
Sous-système LIST	241
Sous-système LXI	244
Sous-système MEASure	245
Sous-système OUTPut	247
Requête POWer	253
Sous-système SENSE	254
Sous-système [SOURce]	258
Sous-système STATus	259
Commande STEP	264
Sous-système SYSTem	265
Sous-système TRIGger	271
Sous-système VOLTage	274
Didacticiel d'état	280
Registres d'état	280
Groupe d'états de fonctionnement	280
Groupes d'état suspects	281
Groupe d'états d'événement standard	282
Registre d'octet d'état	283
Files d'erreurs et de sortie	284
Schéma d'état	285
Didacticiel de déclenchement	286
Sources de déclenchement	286
Destinations de déclenchement	286
Schéma de déclenchement	287
État de réinitialisation (*RST)	288
Messages d'erreur SCPI	293
Commandes de compatibilité	301
Commandes compatibles avec le code APS avec des modèles RPS	301
Comparaison des ensembles de fonctionnalités APS avec les modèles RPS	301
6 Vérification et étalonnage	303
Équipement et configurations de test	304
Équipement de test	304
Configurations de mesure	305
Vérification du fonctionnement	306
Introduction	306
Configurations de vérification	308
Considérations relatives aux tests	308
Procédure de vérification	309
Étalonnage de l'instrument	314
Introduction	314
Fréquence de l'étalonnage	315
Configurations d'étalonnage	316
Considérations relatives aux tests	316
Procédure d'étalonnage	316
Formulaires de relevé de test	321

7 Maintenance et réparation	329
Introduction	330
Service de réparation disponible	330
Avant de retourner l'appareil	330
Remballage pour l'expédition	330
Nettoyage	331
Procédure d'autotest	332
Autotest à la mise sous tension	332
Autotest initié par l'utilisateur	332
Mise à jour du microprogramme	333
Logiciel requis	333
Procédure de mise à jour	333
Restriction de l'accès	333
Nettoyage de la mémoire de l'instrument	335
Commutateurs d'étalonnage	336
Accès au commutateur d'étalonnage	336
Fonctions de commutation	336
Remplacement de la batterie	337
Démontage	340
Précautions contre les décharges électrostatiques (ESD)	340
Outils nécessaires	340
Démontage du capot	340
Démontage de la carte de commande	341
Démontage de la carte Constellation	342
Annexe A Système de déconnexion de sécurité Keysight SD1000A	343
Système de déconnexion de sécurité Keysight SD1000A	344
Introduction	344
Présentation succincte du système de déconnexion de sécurité Keysight SD1000A	345
Caractéristiques supplémentaires	347
Installation du système de déconnexion de sécurité Keysight SD1000A	350
Connexions Keysight SD1000A à RP7900	350
Connexions de commandes externes	353
Fonctionnement du système de déconnexion de sécurité SD1000A	356
Contrôle du SDS à l'aide de l'alimentation de la série RP7900	356
Contrôle du SDS à l'aide des commandes raccordées à l'extérieur	358
Index	363

Informations légales et de sécurité

Mentions légales

Symboles de sécurité

Consignes de sécurité

Mentions légales

© Copyright Keysight Technologies 2017-2021

Edition 6, août 2021

Mise à jour : Septembre 2021

Référence du manuel RP7900-90901

Conformément aux lois internationales relatives à la propriété intellectuelle, toute reproduction, tout stockage électronique et toute traduction de ce manuel, totaux ou partiels, sous quelque forme et par quelque moyen que ce soit, sont interdits sauf consentement écrit préalable de la société Keysight Technologies.

Dans ce document, les termes « maître » et « esclave » ont été remplacés par les termes « principal » et « secondaire ».

Keysight Technologies
550 Clark Drive, Suite 101
Budd Lake, NJ 07828 États-Unis

Logiciels

Ce produit utilise Microsoft Windows CE. Keysight recommande instamment que tous les ordinateurs sous Windows connectés aux instruments sous Windows CE utilisent un antivirus courant.

Le matériel et le logiciel décrits dans ce document sont protégés par un accord de licence ; leur utilisation ou leur reproduction est soumise aux termes et conditions de ladite licence.

Fichiers de licences

Dans le code source gifencode C :

- * Code extrait de ppmtogif.c, du kit pbmplus basé sur GIFENCOD
- * de David Rowley <mgardi@watdscu.waterloo.edu>. A Lempel-Zim
- * compression basée sur « compress ». Modifié par Marcel Wijkstra
- * <wijkstra@fwi.uva.nl> Copyright (C) 1989 de Jef Poskanzer. L'autorisation
- * d'utiliser, de copier, de modifier et de distribuer ce logiciel et sa
- * documentation pour tout usage et sans frais est accordée par les présentes,
- * à condition que l'avis de droit d'auteur ci-dessus apparaisse dans toutes les copies et que
- * cet avis de droit d'auteur et cet avis d'autorisation apparaissent dans
- * la documentation à l'appui. Ce logiciel est fourni « tel quel » sans
- * garantie expresse ou implicite. Le format Graphics Interchange Format(c) est le
- * propriété intellectuelle de CompuServe Incorporated. GIF(sm) est un service
- * Marquer la propriété intellectuelle de CompuServe Incorporated. ;

Garantie

Les informations contenues dans ce document sont fournies "en l'état" et peuvent faire l'objet de modifications sans préavis dans les éditions ultérieures. Par ailleurs, dans les limites de la législation en vigueur, Keysight exclut en outre toute garantie, expresse ou implicite, concernant ce manuel et les informations qu'il contient, y compris, mais non exclusivement, les garanties de qualité marchande et d'adéquation à un usage particulier. Keysight ne saurait en aucun cas être tenu responsable des erreurs ou des dommages incidents ou indirects, liés à la fourniture, à l'utilisation ou à l'exactitude de ce document ou aux performances de tout produit Keysight auquel il se rapporte. Si Keysight a passé un contrat écrit avec l'utilisateur et que certains termes de ce contrat semblent contradictoires avec ceux de ce document, les termes et conditions de la garantie prévalent.

Certificat

Keysight Technologies certifie que ce produit était conforme à ses spécifications publiées au moment de son expédition de l'usine. Keysight Technologies certifie en outre la traçabilité des mesures d'étalonnage conformément à l'United States National Institute of Standards and Technology, aux extensions autorisées par l'établissement d'étalonnage de l'Institut et aux établissements d'étalonnage des autres membres de l'organisation Internationale de Normalisation (ISO).

Droits du Gouvernement des États-Unis

Le Logiciel est un « logiciel informatique commercial » tel que défini par la Federal Acquisition Regulation (« FAR ») 2.101. Conformément aux FAR 12.212 et 27.405-3 et à l'addenda FAR du Ministère de la Défense (« DFARS ») 227.7202, le gouvernement des États-Unis acquiert des logiciels informatiques commerciaux dans les mêmes conditions que celles dans lesquelles les logiciels sont habituellement fournis au public. Par conséquent, Keysight met le Logiciel à la disposition des clients du gouvernement des États-Unis dans le cadre de sa licence commerciale standard, qui est intégrée dans son Contrat de licence utilisateur final (CLUF), dont une copie est disponible à l'adresse suivante : www.keysight.com/find/sweula. La licence mentionnée dans le CLUF représente l'autorité exclusive par laquelle le gouvernement des États-Unis est autorisé à utiliser, modifier, distribuer ou divulguer le Logiciel. Le CLUF et la licence qui y sont mentionnés, n'exigent ni ne permettent, entre autres, que Keysight : (1) Fournisse des données techniques relatives aux logiciels informatiques commerciaux ou à la documentation afférente qui ne sont pas mis habituellement à la disposition du public ; ou (2) Renonce aux droits gouvernementaux ou confère les droits gouvernementaux en plus des droits habituellement mis à la disposition du public pour utiliser, modifier, reproduire, publier, exécuter, afficher ou divulguer des logiciels informatiques commerciaux ou la documentation afférente. Aucune exigence gouvernementale additionnelle outre que celles énoncées dans le CLUF ne s'applique, sauf si ces conditions, droits ou licences sont explicitement exigés par tous les fournisseurs de logiciels informatiques commerciaux conformément à la FAR et aux DFARS et sont énoncés expressément par écrit ailleurs dans le CLUF. Keysight n'est en aucun cas tenu de mettre à jour, de réviser ou de modifier de quelque façon que ce soit le Logiciel. En ce qui concerne toutes les données techniques telles que définies par la FAR 2.101, conformément aux FAR 12.211 et 27.404.2 et au DFARS 227.7102, le gouvernement des États-Unis acquiert des droits n'excédant pas les Droits limités tels que définis dans la FAR 27.401 ou le DFARS 227.7103-5 (c), applicables dans toutes les données techniques.

Directive européenne 2012/19/EU relative aux déchets d'équipements électriques et électroniques (DEEE)

Le symbole de poubelle barrée suivant indique que la collecte sélective des déchets d'équipements électriques et électroniques (DEEE) est obligatoire, conformément à la DIRECTIVE 2012/19/EU et à d'autres lois nationales.

Ne pas éliminer avec les ordures ménagères. Veuillez vous reporter à about.keysight.com/en/companyinfo/environment/takeback.shtml pour comprendre vos options d'échange avec Keysight en plus des instructions de reprise des produits.



Symboles de sécurité

AVERTISSEMENT

La mention AVERTISSEMENT signale un danger pour la sécurité de l'opérateur. Elle attire l'attention sur une procédure ou une pratique qui, si elle n'est pas respectée ou correctement réalisée, peut se traduire par des accidents graves, voire mortels. En présence de la mention AVERTISSEMENT, il convient de s'interrompre tant que les conditions indiquées n'ont pas été parfaitement comprises et respectées.

ATTENTION

La mention ATTENTION signale un danger pour le matériel. Elle attire l'attention sur une procédure ou une pratique qui, si elle n'est pas respectée ou correctement réalisée, peut se traduire par un endommagement de l'appareil ou une perte de données importante. En présence de la mention ATTENTION, il convient de ne pas continuer tant que les conditions indiquées n'ont pas été parfaitement comprises et respectées.



Courant continu



Courant alternatif



Borne reliée au cadre ou au châssis



Alimentation en mode veille. L'appareil n'est pas complètement déconnecté du secteur si l'interrupteur est éteint.



AVERTISSEMENT risque d'électrocution



AVERTISSEMENT consultez la documentation fournie



Borne de mise à la terre



Le marquage CE est une marque déposée de la Communauté européenne.

ISM1-A

Cela indique que l'appareil est un produit industriel, scientifique et médical de classe A et du groupe 1 (CISPER 11, clause 4).

ICES/NMB-001

Cela indique la conformité du produit aux Normes canadiennes sur le matériel brouilleur (Canadian Interference-Causing Equipment Standard).



La marque ETL est une marque déposée de la société Intertek. Le texte indique la conformité du produit aux Normes canadiennes des Équipements provoquant des Interférences (Canadian Interference-Causing Equipment Standard - ICES-001).



La marque RCM est une marque déposée de l'Australian Communications and Media Authority.



Contient une ou plusieurs des 6 substances dangereuses supérieures à la valeur de concentration maximale (MCV), période d'utilisation de protection environnementale (EPUP) de 40 ans.



Déclaration sud-coréenne de CEM de classe A.

Cet équipement a été jugé conforme pour une utilisation dans des environnements professionnels. Dans un environnement résidentiel, cet équipement pourrait causer des interférences radio. Cette déclaration de CEM s'applique à cet équipement pour une utilisation dans un environnement professionnel uniquement.

사 용 자 안 내 문

<p>이 기기는 업무용 환경에서 사용할 목적으로 적합성평가를 받은 기기로서 가정용 환경에서 사용하는 경우 전파간섭의 우려가 있습니다.</p>
--

※ 사용자 안내문은 "업무용 방송통신기자재"에만 적용한다.

Consignes de sécurité

Les consignes de sécurité présentées dans cette section doivent être appliquées au cours des différentes phases d'utilisation de cet instrument. Le non-respect de ces précautions ou des avertissements et instructions spécifiques mentionnés dans ce manuel constitue une violation des normes de sécurité établies lors de la conception, de la fabrication et de l'usage normal de l'instrument. Keysight Technologies ne saurait être tenu pour responsable du non-respect de ces consignes.

L'équipement est à usage industriel. Les opérateurs de l'équipement doivent respecter toutes les réglementations de sécurité applicables. En plus des avertissements et avis de sécurité présents dans ce manuel, toutes les réglementations pertinentes relatives à la sécurité, la prévention des accidents et l'environnement doivent être respectées. Il convient en particulier de noter que les opérateurs de l'équipement :

- doivent être informés des exigences de sécurité pertinentes ;
- doivent avoir lu et compris le guide d'utilisation avant d'utiliser l'équipement ;
- doivent utiliser l'équipement de sécurité désigné et recommandé.

AVERTISSEMENT

Généralités

N'utilisez ce produit que de la manière préconisée par le fabricant. Les fonctions de sécurité de ce produit peuvent être perturbées si vous ne respectez pas les consignes d'utilisation.

AVERTISSEMENT

Conditions d'environnement

N'utilisez jamais l'instrument en dehors des conditions environnementales spécifiées décrites dans les Conditions ambiantes des spécifications.

AVERTISSEMENT

Poids élevé.

Danger relatif aux mains et aux pieds. Afin d'éviter toute blessure ou dommage à l'instrument, utilisez toujours un chariot solide ou tout autre appareil adéquat pour déplacer l'instrument. Ne soulevez jamais l'instrument seul(e) ; veillez à toujours être au moins deux personnes pour soulever l'instrument.



AVERTISSEMENT

RISQUE D'ÉLECTROCUTION Mise à la terre de l'instrument

Ce produit comporte une borne de terre de protection. Afin de réduire les risques d'électrocution, l'instrument doit être relié à une source de courant alternatif par l'intermédiaire d'un cordon d'alimentation secteur pourvu d'un fil de terre connecté fermement à une terre électrique (terre de sécurité) au niveau de la prise de courant. Toute interruption du conducteur de protection (mise à la terre) ou tout débranchement de la borne de terre de protection entraîne un risque d'électrocution pouvant provoquer des accidents graves, voire mortels.

AVERTISSEMENT

Avant la mise sous tension

Vérifiez que vous avez bien respecté toutes les consignes de sécurité. Tous les branchements doivent être effectués alors que l'unité est hors tension, et ils doivent être réalisés par du personnel qualifié conscient des dangers inhérents. Toute action inappropriée est susceptible de provoquer des blessures mortelles et d'endommager l'équipement. Lisez les mentions apposées sur l'extérieur de l'instrument décrites à la section "Symboles de sécurité".

AVERTISSEMENT

RISQUE D'ÉLECTROCUTION, TENSION LÉTALES De nombreux modèles génèrent des tensions supérieures à 60 V CC, certains modèles ayant une tension nominale de 950 V CC ! Assurez-vous que toutes les connexions des instruments, le câblage de charge et les connexions de charge sont isolés ou recouverts à l'aide des capots de sécurité fournis, de sorte qu'aucun contact accidentel avec des tensions létales ne peut se produire.

AVERTISSEMENT

RISQUE D'ÉLECTROCUTION Ne touchez jamais les câbles ou les connexions immédiatement après avoir éteint l'appareil. En fonction du modèle, des tensions létales demeurent aux bornes de sortie pendant plusieurs secondes après la mise hors tension. Vérifiez qu'il n'y a pas de tension dangereuse sur les bornes de sortie ou de mesure avant de les toucher.

AVERTISSEMENT

RISQUE D'ÉLECTROCUTION avec les sources d'énergie externes.

Étant donné que l'instrument peut être utilisé comme charge pour courant absorbé, des tensions dangereuses provenant d'une source d'énergie externe, telle qu'une batterie, peuvent être présentes sur les bornes de sortie, même si l'appareil est éteint. Prévoyez de débrancher la source d'énergie externe avant de toucher les bornes de sortie ou de mesure.

AVERTISSEMENT

Ne pas utiliser en atmosphère explosive

N'utilisez pas l'instrument en présence de gaz ou de vapeurs inflammables.

AVERTISSEMENT

Ne pas démonter le capot de l'instrument

Seules des personnes qualifiées, formées à la maintenance et conscientes des risques d'électrocution encourus peuvent démonter les capots de l'instrument. Débranchez toujours le cordon d'alimentation secteur et tous les circuits externes avant de démonter le capot de l'instrument.

AVERTISSEMENT

Ne pas modifier l'instrument

Ne pas installer de composants de rechange et ne pas apporter de modifications non autorisées à l'appareil. Pour garantir les caractéristiques de sécurité de l'instrument, retournez-le à votre bureau de vente et d'après-vente Keysight le plus proche en vue d'une opération de maintenance et de réparation.

AVERTISSEMENT

Fusibles

L'instrument contient un fusible interne non accessible à l'utilisateur.

AVERTISSEMENT

Nettoyage

Pour éviter toute électrocution, débranchez toujours la source de courant alternatif avant le nettoyage. Utilisez un chiffon sec ou légèrement humidifié avec de l'eau pour nettoyer les parties externes. N'utilisez pas de détergent ou de solvant. Ne tentez aucune opération de nettoyage interne.

AVERTISSEMENT

En cas de dommages

Les instruments endommagés ou défectueux doivent être désactivés et protégés contre toute utilisation involontaire jusqu'à ce qu'ils aient été réparés par une personne qualifiée.

1

Aide-mémoire

Informations légales et de sécurité

Présentation de l'instrument

Aide-mémoire des menus du panneau avant

Aide-mémoire des commandes

Fonctionnalités et options des modèles

Spécifications et caractéristiques - RP793xA, RP794xA

Spécifications et caractéristiques - RP795xA, RP796xA

Ce document contient des informations sur l'utilisation, la maintenance et la programmation de la gamme de systèmes d'alimentations régénératrices (RPS) Keysight.

Documentation, microprogramme et assistance technique

Vous pouvez télécharger la dernière version de ce document à l'adresse www.keysight.com/find/RPS-doc. La dernière version est également disponible pour les appareils mobiles à l'adresse www.keysight.com/find/RPS-mobilehelp.

Pour obtenir la dernière version du microprogramme, accédez à la page [Mises à jour du microprogramme](#).

Pour toute question concernant votre livraison ou pour obtenir des informations sur la garantie, la maintenance ou l'assistance technique, contactez Keysight Technologies.

Contactez Keysight Technologies

Pour pouvoir contacter Keysight dans le monde entier, ou votre représentant Keysight Technologies, rendez-vous sur www.keysight.com/find/assist.

Présentation de l'instrument

Présentation succincte du système d'alimentations régénératrices

Présentation succincte du panneau avant

Présentation succincte du panneau arrière

Présentation succincte de l'écran du panneau avant

Présentation succincte des touches du panneau avant

Présentation succincte du système de déconnexion de sécurité

Présentation succincte du système d'alimentations régénératrices

La gamme de systèmes d'alimentations régénératrices (RPS) Keysight comprend des modules d'alimentation en courant continu montables sur baie 3U dotés de performances et de fonctionnalités optimisées pour les systèmes de test automatisés. Les caractéristiques de sortie et système sont décrites ci-dessous. La section **Modèles et options** décrit les fonctionnalités qui s'appliquent à certains modèles.

Caractéristiques de sortie

- Des fonctionnalités de programmation complètes pour toute la plage de tension et de courant de sortie
- Commutation automatique de plage de sortie pour une plus grande flexibilité
- La sortie peut fonctionner en mode de priorité de tension ou de courant
- Programmation de sortie amont et aval haut débit
- Programmation de la résistance de sortie
- Les délais d'activation/de désactivation permettent de séquencer l'activation et la désactivation de la sortie sur plusieurs appareils
- Fonctionnalité de partage de courant pour les sorties parallèles
- La capacité de protection comprend la surtension, la surintensité et la surchauffe
- Le fonctionnement sur deux quadrants offre une capacité d'alimentation en courant ou d'absorption de courant
- Capacité de dissipation de courant nominale de 100%
- Modèles dotés de valeurs nominales à 5 kW et 10 kW

Fonctionnalités de mesure

- Fréquence d'échantillonnage de 5,12 microsecondes
- Mesures de puissance en temps réel

- Mesures A-heures et W-heures
- Capacité de mesures numérisées

Caractéristiques du système

- Enregistrement et rappel de 10 configurations d'instrument maximum dans la mémoire non volatile
- Les interfaces de programmation à distance GPIB (IEEE-488), LAN et USB sont intégrées
- Configuration du menu du panneau avant pour les paramètres GPIB et LAN
- Conformité à LXI Core 2011, serveur Web intégré inclus
- Compatibilité SCPI (Standard Commands for Programmable Instruments)
- La fonction principale/secondaire permet de contrôler des sorties composites et l'affichage sur un appareil

Fonctionnement régénératif

Le fonctionnement régénératif est automatique et ne nécessite aucune programmation de la part de l'utilisateur. Chaque fois que le RPS absorbe du courant, soit par programmation amont rapide de la sortie, soit par déchargement d'une source d'énergie comme une batterie, l'appareil dirigera la puissance excessive vers la source de courant alternatif. Vous ne pouvez pas désactiver le fonctionnement régénératif.

Lors du fonctionnement régénératif, le facteur de puissance de 0,99 est maintenu. La distorsion du courant sinusoïdal est inférieure à 2 % à pleine charge. Cela garantit la qualité du signal CA qui est renvoyé à la source de courant alternatif.

Lorsqu'une panne secteur est détectée, les relais galvaniques déconnectent la source de courant alternatif et l'appareil s'arrête. Pour protéger votre appareil testé, le RPS fournit un « anti-îlotage » qui détecte que le réseau est sous tension avant de régénérer l'alimentation du réseau.

Reportez-vous à la section **Caractéristiques communes de l'alimentation secteur** pour obtenir plus d'informations sur l'arrêt et le redémarrage de l'appareil.

Présentation succincte du panneau avant

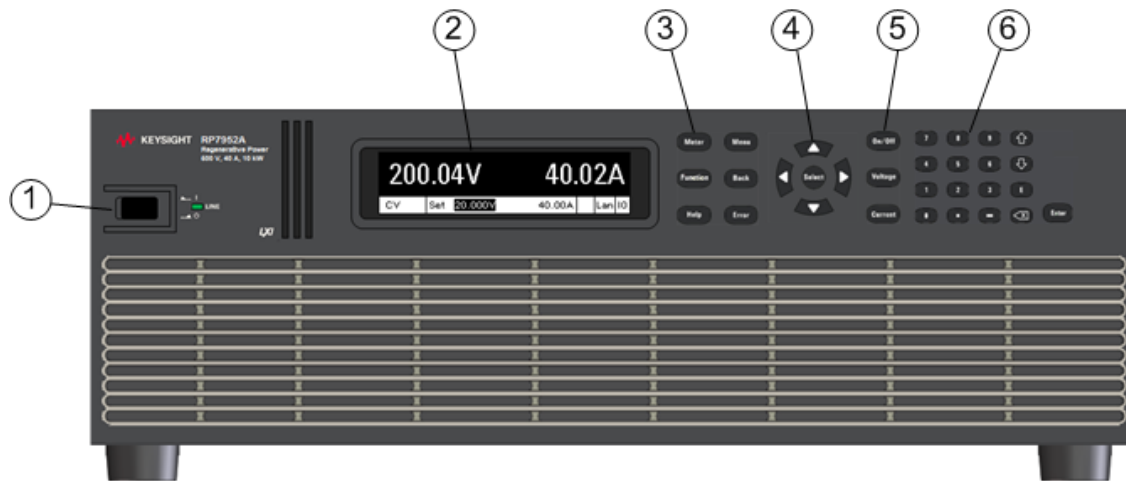

1. **Commutateur et voyant On/Off (Marche/arrêt)** : le voyant indique que l'appareil est sous tension. Un voyant vert indique un fonctionnement normal. Le voyant orange indique un écran en mode veille.
2. **Affichage** : s'éteint après une heure d'inactivité. Appuyez sur une touche pour rallumer l'écran.
3. **Touches du système** : sélectionnent la fonction de mesure. Accédez aux menus de commande, d'aide et d'erreur du panneau avant.
4. **Touches de navigation** : placent le curseur sur un élément de menu. Sélectionnent l'élément de menu en surbrillance.
5. **Touches de sortie** : activent ou désactivent les sorties. Permettent la saisie des valeurs de tension ou de courant.
6. **Touches d'entrée numérique** : permettent de saisir des valeurs. Les touches fléchées augmentent ou diminuent les paramètres numériques.

Présentation succincte du panneau arrière

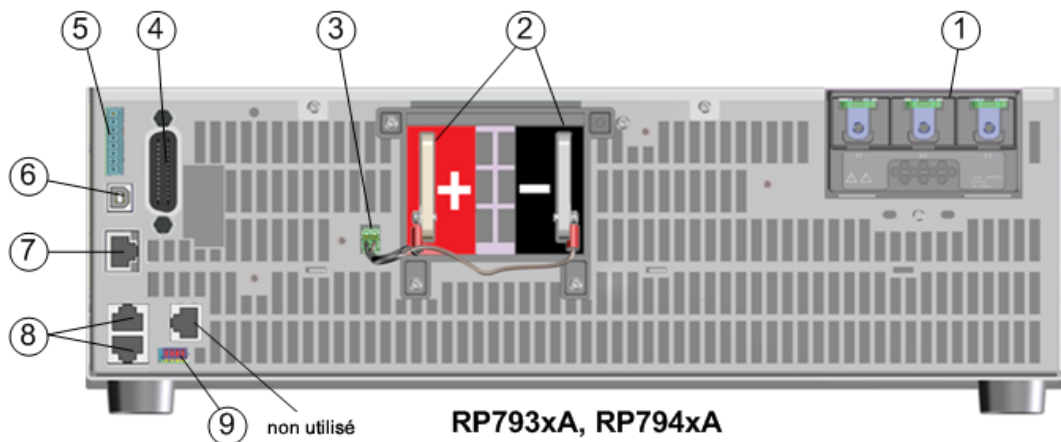
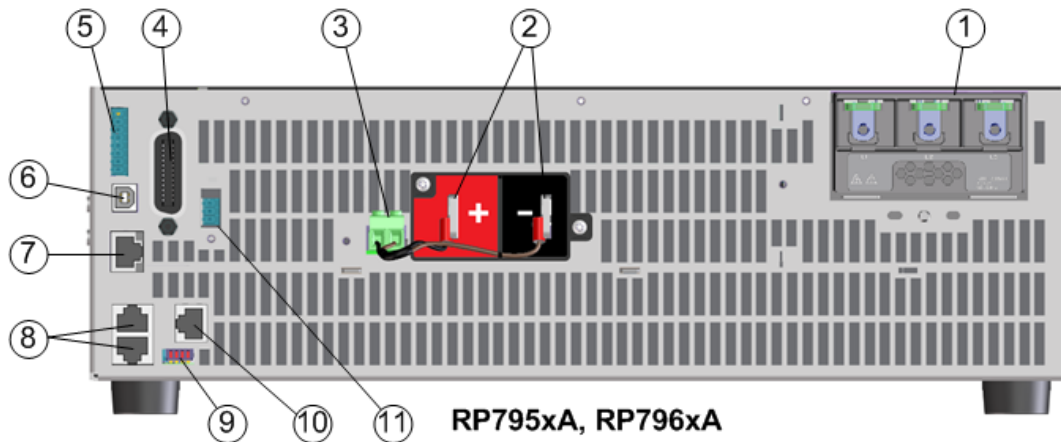

1. **Entrée CA** : entrée CA triphasée (L1, L2, L3) avec masse du châssis. L'entrée CA est bidirectionnelle.
2. **Sorties CC** : bornes de sortie positives et négatives.
3. **Mesures** : bornes de mesure à distance, connectées en mode de mesure locale.
4. **GPIB** : connecteur de l'interface GPIB.
5. **E/S numérique** : connecteur d'E/S numérique. Les broches sont configurables par l'utilisateur.
6. **USB** : connecteur de l'interface USB.
7. **LAN** : le voyant de gauche 10/100/1000 Base-T indique l'activité. Le voyant de droite indique l'intégrité de la liaison.
8. **Principal/secondaire** : connecteurs pour le regroupement d'appareils en parallèle.
9. **Commutateurs de terminaison** : spécifie les types de terminaison principal/secondaire.
10. **Connecteur SDS** : connexion du système Keysight SD1000A, pour les modèles **RP795xA, RP796xA** seulement.
11. **Partage** : connexion de partage de courant, pour les modèles **RP795xA, RP796xA** seulement.

Présentation succincte de l'écran du panneau avant

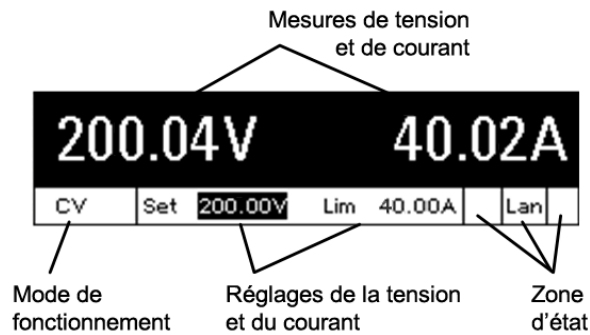

Mesures de tension et de courant	Affiche la valeur réelle de la tension et du courant de sortie
Mode de fonctionnement	Indique l'une des options suivantes : OFF = la sortie est désactivée CV = la sortie est en mode de tension constante CC = la sortie est en mode de courant constant CP+ = la sortie est désactivée par la limite de puissance positive CP- = la sortie est désactivée par la limite de puissance négative VL+ = la sortie est en mode de limitation de tension positive CL+/- = la sortie est en mode de limitation de courant positive ou négative T-on = la sortie est activée T-off = la sortie est désactivée OV = la sortie est désactivée par la protection contre les surtensions OV- = la sortie est désactivée par la protection contre les surtensions négatives OC = la sortie est désactivée par la protection contre les surintensités OT = la protection contre les surchauffes est déclenchée PF = la sortie est désactivée par une panne d'alimentation P = l'instrument a été connecté en parallèle avec un autre instrument Inh = la sortie est désactivée par un signal d'inhibition externe Unr = la sortie n'est pas régulée Prot = la sortie est désactivée par une condition de protection sur un autre appareil EDP = la sortie est désactivée par une protection contre les dynamiques de sortie excessives IPK+/- = la sortie se trouve dans la limite de courant de crête positive ou négative CSF = une erreur de partage de courant s'est produite PSP = une protection principale/secondaire s'est produite SDP = une panne du système de déconnexion de sécurité s'est produite UV = la sortie est désactivée par la protection contre les sous-tensions LOV+/- = la tension de sortie a dépassé une limite interne positive ou négative DOV+/- = une tension appliquée par le DUT a dépassé la limite de tension positive ou négative OCF+/- = les limites internes de courant positives ou négatives sont dépassées - éventuellement en raison d'une tension appliquée par un DUT qui a dépassé la limite de tension positive ou négative

Réglages de la tension et du courant

Affiche la tension et le courant programmés. Il est possible que ces réglages ne correspondent pas à la tension ou au courant de sortie mesuré. Par exemple, dans le cas d'un fonctionnement en tension constante, le réglage du courant de sortie (limite) peut être défini à 1 A, mais le courant de sortie (mesuré) réel doit être inférieur à 1 A pour que la sortie demeure en mode de tension constante. Si la limite de courant est atteinte, la sortie ne fonctionnera plus en mode de tension constante, mais en mode de limitation de courant. Dans ce cas, la tension de sortie réelle sera maintenant inférieure au réglage de la tension de sortie.

Zone d'état

Indique l'activité d'interface de commande à distance suivante :

Err = une erreur s'est produite (appuyez sur la touche Erreur pour afficher le message d'erreur)

Lan = le réseau local est connecté et a été configuré

IO = l'une des interfaces de programmation à distance est active

Présentation succincte des touches du panneau avant

L'interrupteur marche/arrêt permet d'allumer ou d'éteindre l'appareil. Le voyant indique que le module est sous tension. Un voyant **vert** indique un fonctionnement normal. Un voyant **jaune** indique que l'écran est en mode écran de veille. Il est également jaune pendant le processus de démarrage. Appuyez sur une touche quelconque pour quitter le mode écran de veille.

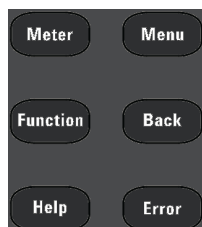

Les touches de système permettent d'accéder aux menus de mesure et de commande du panneau avant suivants :

La touche Meter (Multimètre) renvoie l'affichage en mode appareil de mesure. Bascule également entre les mesures de courant et de puissance.

La touche Menu permet d'accéder au menu des commandes.

La touche Function (Fonction) est réservée à une utilisation future.

La touche Back (Précédent) permet de quitter un menu sans valider les modifications.

La touche Help (Aide) permet d'accéder à des informations sur la commande de menu affichée.

La touche Error (Erreur) permet d'afficher des messages d'erreurs de la file d'erreurs.

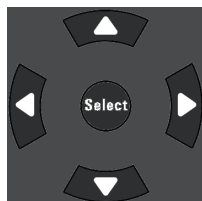

Les touches de navigation permettent d'effectuer les actions suivantes :

Les touches fléchées permettent de se déplacer dans les menus de commandes. Elles permettent également de sélectionner des caractères alphabétiques dans les champs de saisie alphanumériques.

La touche Select (Sélectionner) permet d'effectuer un choix dans les menus de commandes. Elle permet également d'activer le mode de modification des paramètres numériques.

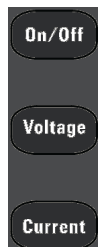

Les touches de sortie permettent d'effectuer les actions suivantes :

On/Off (Activer/Désactiver) contrôle la sortie.

La touche Voltage (Tension) vous permet de modifier le réglage de tension.

La touche Current (Courant) vous permet de modifier le réglage de courant.

1 Aide-mémoire



Les touches du clavier numérique permettent d'effectuer les actions suivantes :

Les touches de 0 à 9 permettent de saisir des chiffres.

La touche (.) est le séparateur décimal.

La touche - permet de saisir un signe moins.

Les touches fléchées haut/bas permettent d'augmenter ou de diminuer les valeurs de tension ou de courant. Elles permettent également de sélectionner des lettres dans les champs de saisie alphabétique.

La touche E permet de saisir un exposant. Ajoutez la valeur à droite de la lettre E.

La touche de retour arrière permet de supprimer des chiffres et de les corriger.

La touche Enter permet de valider la saisie d'une valeur. Si vous quittez un champ sans avoir appuyé sur la touche Enter, la valeur est ignorée.

REMARQUE

Appuyez sur la touche Help (Aide) pour accéder à l'aide contextuelle.

Aide-mémoire des menus du panneau avant

Appuyez sur la touche **Menu** pour accéder aux menus du panneau avant. Pour obtenir un bref didacticiel, reportez-vous à **Utilisation du menu du panneau avant**. Si une option du menu est grisée, elle n'est pas disponible pour le modèle en cours de programmation.

1er niveau du menu	2ème niveau	3ème et 4ème niveaux	Description	
Output	Voltage		Programme les réglages de la tension de sortie	
	Current		Programme les réglages du courant de sortie	
	Mode		Programme le mode de priorité de sortie	
	Sequence	Delay		Programme le délai d'activation/de désactivation des sorties
		Couple		Configure le couplage des états de sortie
	Advanced	Slew		Programme les vitesses de balayage du courant ou de la tension de sortie
		Resistance		Programme la résistance de sortie
			Bandwidth Current	Programme la bande passante de courant
			Voltage	Programme la bande passante de tension
		Tmode		Mode d'activation/désactivation de la sortie des programmes
		CurrSharing		Active/désactive le partage de courant de sortie
Measure	Sweep		Configure l'échantillonnage de mesure	
	Window		Sélectionne une fenêtre de mesure	
	Control		Initialise, déclenche et interrompt les acquisitions ; affiche l'état de déclenchement	
	AhWh		Mesure ou réinitialise les ampères-heures et les watts-heures	
Transient	Mode		Sélectionne les modes de transitoire de tension et de courant	
	Step		Configure les paliers de tension ou de courant et les signaux de déclenchement	
	List	Pace		Définit une liste de temps de palier ou de pas de déclenchement
		Repeat		Indique le nombre de répétitions de la liste ou une liste continue
		Terminate		Indique les conditions de terminaison de la liste
		Config		Configure les paramètres individuels des paliers de la liste
		Reset		Annule la liste et rétablit tous les paramètres correspondants

1 Aide-mémoire

1er niveau du menu	2ème niveau	3ème et 4ème niveaux	Description
	Arb	Repeat	Indique le nombre de répétitions du signal arbitraire ou un signal arbitraire continu
		Terminate	Indique les conditions de terminaison du signal arbitraire
		Config	Configure les paramètres individuels du signal arbitraire
	TrigSource		Indique la source de déclenchement du transitoire et du signal arbitraire CD
	Control		Initialise, déclenche et interrompt les transitoires ; affiche l'état de déclenchement
Protect	OVP		Configure les paramètres de protection contre les surtensions
	UVP		Configure les paramètres de protection contre les sous-tensions
	OCP		Configure les paramètres de protection contre les surintensités
	Inhibit		Configure les paramètres du mode d'entrée d'inhibition
	WDog		Configure les paramètres de protection du temporisateur de surveillance de sortie
	Clear		Efface les conditions de protection et indique l'état de la sortie
States	Reset		Rétablit tous les réglages de l'instrument à l'état de réinitialisation (*RST)
	SaveRecall		Enregistre et rappelle les réglages de l'instrument
	PowerOn		Sélectionne l'état de mise sous tension de l'instrument
System	IO	LAN	Settings Affiche les paramètres réseau actuellement activés
			Modify Modifie la configuration du réseau (IP, Nom, DNS, mDNS, Services)
			Apply Applique les changements de configuration et redémarre l'appareil
			Cancel Annule les changements de configuration
			Reset Effectue une réinitialisation LXI LCI des paramètres LAN et redémarre l'appareil
			Defaults Rétablit les paramètres d'usine par défaut du réseau et redémarre l'appareil
		USB	Affiche la chaîne d'identification USB
		GPIB	Affiche ou modifie l'adresse GPIB
		DigPort	Pins Configure les broches individuelles du port numérique
			Data Lit/écrit les données vers le port numérique
	Groups	Function	Spécifie la fonction principale/secondaire
		Primary	Découvre et connecte le principal des appareils secondaires

1er niveau du menu	2ème niveau	3ème et 4ème niveaux	Description
		Secondary	Indique l'adresse secondaire
	SDS	Status	Renvoie l'état de connexion du système de coupure de sécurité SD1000A
		Config	Configure la connexion à l'appareil SDS
		Data	Input Lit les données d'état à partir du port numérique de l'appareil SDS
			Output Règle l'état des signaux de sortie externes de l'appareil SDS
	Preferences	Horloge	Règle l'horloge en temps réel
		Display	Configure le mode écran de veille et multimètre de démarrage
		LineFreq	Indique une détection automatique ou manuelle de la fréquence réseau.
		Lock	Verrouille les touches du panneau avant à l'aide d'un mot de passe
	Admin	Login	Saisit un mot de passe pour accéder aux fonctions d'administration
		Cal	Vprog Étalonne la programmation de la tension
			Curr Étalonne la programmation et la mesure du courant
			Misc Étalonne CurrSharing, ResBout et CurrTC
			Count Affiche le nombre de points d'étalonnage
			Date Enregistre la date d'étalonnage
			Save Enregistre les données d'étalonnage
		IO	Active/désactive les services USB, GPIB et LAN
		Sanitize	Effectue un effacement sécurisé NISPOM de toutes les données utilisateur
		Update	Met à jour le microprogramme avec une protection par mot de passe
		Password	Modifie le mot de passe Admin
	About		Affiche le modèle, les options, le numéro de série et le microprogramme

Aide-mémoire des commandes

Certaines commandes [facultatives] ont été ajoutées à des fins de clarté. Toutes les commandes des paramètres correspondent à une requête. Voir la section **Conventions syntaxiques** du langage SCPI.

ABORt

:ACQuire	Annule toutes les mesures déclenchées.
:ELOG	Arrête l'enregistrement de données externe.
:TRANsient	Annule toutes les actions déclenchées.

CALibrate

:COUNT?	Renvoie le nombre de fois que l'appareil a été étalonné.
:CURRent	
[:LEVe] <valeur>	Étalonne la programmation et la mesure du courant.
:SHARing	Étalonne le signal Imon des appareils connectés en parallèle. (RP795xA, N676xA)
:TC	Étalonne le coefficient de température. (RP793xA, RP794xA)
:DATA <valeur>	Saisit la valeur d'étalonnage relevée sur le multimètre externe.
:DATE <"date">	Enregistre la date d'étalonnage dans la mémoire non volatile.
:LEVeL P1 P2 P3	Passe au niveau d'étalonnage suivant.
:PASSword <valeur>	Définit un mot de passe numérique pour empêcher tout étalonnage non autorisé.
:RESistance	
:BOUTh	Étalonne la résistance de sortie inférieure. RP795xA, RP796xA)
:SAVE	Enregistre les constantes d'étalonnage dans la mémoire non volatile.
:STATe 0 OFF 1 ON	Active ou désactive le mode d'étalonnage.
:VOLTagE	
[:LEVe] <valeur>	Étalonne la programmation et la mesure de la tension locale.

DISPlay

[:WINDow]	
[:STATe] 0 OFF 1 ON	Allume ou éteint l'écran du panneau avant.
:VIEW METER_VI METER_VP METER_VIP	Sélectionne les paramètres à afficher sur le panneau avant.
:SAVer	
[:STATe] 0 OFF 1 ON	Allume ou éteint l'écran de veille du panneau avant.

FETCh

[:SCALar]	
:CURRent	
[:DC]? [<start_index>, <points>]	Renvoie la mesure moyenne.
:ACDC?	Renvoie la mesure de valeur efficace vraie (CA + CC).
:HIGH?	Renvoie le niveau élevé d'un signal d'impulsion.
:LOW?	Renvoie le niveau faible d'un signal d'impulsion.
:MAXimum?	Renvoie la valeur maximale ou minimale.
:MINimum?	
:POWer	
[:DC]?	Renvoie la mesure moyenne.

:MAXimum?	Renvoie la valeur maximale ou minimale.
:MINimum?	
:VOLTage	
[:DC]? [<start_index>, <points>]	Renvoie la mesure moyenne.
:ACDC?	Renvoie la mesure de valeur efficace vraie (CA + CC).
:HIGH?	Renvoie le niveau élevé d'un signal d'impulsion.
:LOW?	Renvoie le niveau faible d'un signal d'impulsion.
:MAXimum?	Renvoie la valeur maximale ou minimale.
:MINimum?	
:AHOu? [IGNORE_OVLD]	Renvoie les ampères-heures cumulés.
:ARRAY	
:CURRent	
[:DC]? [<start_index>, <points>]	Renvoie la mesure instantanée.
:POWer	
[:DC]?	Renvoie la mesure instantanée.
:VOLTage	
[:DC]? [<start_index>, <points>]	Renvoie la mesure instantanée.
:ELOG <nbre max d'enregistrements>	Renvoie les enregistrements de données externes les plus récents.
:WHOu? [IGNORE_OVLD]	Renvoie les watts-heures cumulés.

FORMat

[:DATA] ASCII REAL	Indique le format des données renvoyées.
:BORDer NORMal SWAPped	Indique comment les données binaires sont transférées.

HCOPy

:SDUMp	
:DATA? [BMP GIF PNG]	Renvoie une image de l'écran du panneau avant.
:DATA	
:FORMat BMP GIF PNG	Spécifie le format des images du panneau avant renvoyées.

Commandes courantes IEEE-488

*CLS	Commande d'effacement de l'état.
*ESE <valeur>	Commande et requête d'activation de l'état des événements.
*ESR?	Requête d'événement de l'état des événements.
*IDN?	Requête d'identification.
*OPC	Active le bit OPC (opération terminée) dans le registre des événements standard.
*OPC?	Renvoie la valeur 1 dans le tampon de sortie une fois toutes les opérations en attente terminées.
*OPT?	Renvoie une chaîne identifiant toutes les options installées.
*RCL <valeur>	Rappelle un état d'instrument enregistré.
*RST	Rétablit les valeurs prédéfinies de l'instrument qui sont des valeurs types ou sûres.
*SAV <valeur>	Enregistre l'état de l'instrument à l'un des dix emplacements de mémoire non volatile.
*SRE <valeur>	Commande et requête d'activation des demandes de service.
*STB?	Requête de l'octet d'état.
*TRG	Commande de déclenchement.

1 Aide-mémoire

*TST?	Requête d'autotest.
*WAI	Interrompt momentanément le traitement des commandes supplémentaires jusqu'à ce que toutes les opérations en attente soient terminées.

INITiate

[:IMMediate]	
:ACQuire	Démarre le système de déclenchement de mesure.
:ELOG	Démarre l'enregistrement de données externe.
:TRANsient	Démarre le système de déclenchement de transitoire.
:CONTInuous	
:TRANsient 0 OFF 1 ON	Démarre continuellement le système de déclenchement de transitoire.

INSTrument

:GROup	
:FUNcTION PRIMary/SECondary NONE	Définit la fonction principale/secondaire
:PRIMary (Principale)	
:CONNect	
[:STATe] 0 OFF 1 ON	Connecte le principal aux appareils secondaires précédemment découverts.
:DElay <délai>	Indique un délai de connexion automatique après la mise sous tension.
:MODE AUTO MANual	Connexion automatique à la mise sous tension ou par commande.
:DISCover	Découvre les appareils principaux connectés par bus
:RESet	Réinitialise la configuration principale
:SECondary	
:ADDRes <adresse bus>	Définit l'adresse du bus secondaire.

LXI

:IDENtify	
[:STATe] 0 OFF 1 ON	Allume ou éteint le voyant d'identification LXI du panneau avant.
:MDNS	
[:STATe] 0 OFF 1 ON	Définit l'état MDNS.

MEASure

[:SCALar]	
:CURRent	
[:DC]?	Effectue une mesure ; renvoie le courant moyen.
:ACDC?	Effectue une mesure ; renvoie le courant efficace vrai (CA + CC).
:HIGH?	Effectue une mesure ; renvoie le niveau élevé d'une impulsion de courant.
:LOW?	Effectue une mesure ; renvoie le niveau faible d'une impulsion de courant.
:MAXimum?	Effectue une mesure ; renvoie le courant maximal.
:MINimum?	Effectue une mesure ; renvoie le courant minimal.
:POWer	
[:DC]?	Effectue une mesure ; renvoie la puissance moyenne.
:MAXimum?	Effectue une mesure ; renvoie la puissance maximale.

:MINimum?	Effectue une mesure ; renvoie la puissance minimale.
:VOLTage	
[:DC]?	Effectue une mesure ; renvoie la tension moyenne.
:ACDC?	Effectue une mesure ; renvoie la tension efficace vraie (CA + CC).
:HIGH?	Effectue une mesure ; renvoie le niveau élevé d'une impulsion de tension.
:LOW?	Effectue une mesure ; renvoie le niveau faible d'une impulsion de tension.
:MAXimum?	Effectue une mesure ; renvoie la tension maximale.
:MINimum?	Effectue une mesure ; renvoie la tension minimale.
:ARRAY	
:CURRent [:DC]?	Effectue une mesure ; renvoie le courant instantané.
:POWer[:DC]?	Effectue une mesure ; renvoie la puissance instantanée.
:VOLTage [:DC]?	Effectue une mesure ; renvoie la tension instantanée.

OUTPut

[:STATe] 0 OFF 1 ON	Active ou désactive la sortie.
:COUPle	
[:STATe] 0 OFF 1 ON	Active ou désactive la fonction de couplage des sorties.
:DOFFset <valeur>	Définit un décalage de délai pour synchroniser les modifications de l'état de sortie couplé.
:MAX	
:DOFFset?	Renvoie le décalage de délai requis pour cet instrument.
:DELay	
:FALL <valeur>	Règle le délai de la séquence de désactivation de la sortie.
:RISE <valeur>	Règle le délai de la séquence d'activation de la sortie.
:TMODE	
:COUPle 0 OFF 1 ON	Couple les réglages de mise en marche et d'arrêt (RP793xA, RP794xA).
[:OFF] LOWZ HIGHZ	Sélectionne le mode de désactivation de la sortie (RP793xA, RP794xA).
:ON LOWZ HIGHZ	Sélectionne le mode de mise sous tension de la sortie (RP793xA, RP794xA).
:INHibit	
:MODE LATCHing LIVE OFF	Définit le mode de fonctionnement de la broche numérique d'inhibition à distance.
:PON	
:STATe RST RCL0	Définit la configuration de mise sous tension de la sortie.
:PROTection	
:CLEar	Réinitialise la protection verrouillée.
:TEMPerature	
:MARGin?	Renvoie la marge restante avant les déclenchements en surchauffe.
:WDOG	
[:STATe] 0 OFF 1 ON	Active ou désactive le temporisateur de surveillance des E/S.
:DELay <valeur>	Définit le délai de surveillance.
:RELay	
:LOCK	
[:STATe] 0 OFF 1 ON	Active ou désactive l'état du relais verrouillé de l'appareil SD1000A.

SENSe

1 Aide-mémoire

:AHOuR	
:RESet	Réinitialise la mesure en ampères-heures ou en watts-heures à zéro.
:ELOG	
:FUNction	
:CURRent 0 OFF 1 ON	Active ou désactive l'enregistrement du courant externe.
:MINMax 0 OFF 1 ON	Active ou désactive l'enregistrement du courant min/max.
:VOLTage 0 OFF 1 ON	Active ou désactive l'enregistrement externe de la tension externe.
:MINMax 0 OFF 1 ON	Active ou désactive l'enregistrement de la tension min/max.
:PERiod <valeur>	Règle le temps d'intégration de l'enregistrement externe.
:FUNction	
:CURRent 0 OFF 1 ON	Active ou désactive les mesures de courant.
:VOLTage 0 OFF 1 ON	Active ou désactive les mesures de tension.
:SWEep	
:NPLCycles <valeur>	Définit le temps de mesure en nombre de cycles de tension d'alimentation.
:OFFSet	
:POINts <valeur>	Définit le décalage d'un balayage de données pour les mesures déclenchées.
:POINts <valeur>	Définit le nombre de points d'une mesure.
:TINTerval <valeur>	Définit la période qui s'écoule entre les échantillons de mesure.
:WHOuR	
:RESet	Réinitialise la mesure des watts-heures cumulés.
:WINDow	
[:TYPE] HANNing RECTangular	Sélectionne la fenêtre de mesure.

[SOURce:]

ARB

:COUNT <valeur> INfinity	Indique le nombre de répétitions du signal arbitraire.
:CURRent	
:CDWell	
[:LEVel] <valeur>{,<valeur>}<Bloc>	Indique le temps de chaque point dans le signal arbitraire.
:DWELL <valeur>	Indique le temps de palier de chaque point dans le signal arbitraire.
:POINts?	Renvoie le nombre de points dans le signal arbitraire.
:FUNction	
:TYPE CURRent VOLTage	Indique un signal arbitraire de tension ou de courant.
:TERMinate	
:LAST 0 OFF 1 ON	Sélectionne le réglage de sortie à la fin du signal arbitraire.

[SOURce:]

CURRent

[:LEVel]	
[:IMMediate]	
[:AMPLitude] <valeur>	Définit le courant de sortie en mode de priorité de courant.
:TRIGgered	
[:AMPLitude] <valeur>	Définit le courant de sortie déclenché.
:BWIDth	

:RANGe 0 1	Définit la compensation du courant. (RP793xA,RP794xA)
:LEVel 0 1, <valeur>	Définit la fréquence de compensation. (RP793xA, RP794xA)
:LIMit	
[:POSitive]	
[:IMMediate]	
[:AMPLitude] <valeur>	Définit la limite de courant en mode de priorité de tension.
:NEGative	
[:IMMediate]	
[:AMPLitude] <valeur>	Définit la limite de courant en mode de priorité de tension.
:MODE FIXed STEP LIST ARB	Définit le mode de transitoire.
:PROTection	
:DELay	
[:TIME] <valeur>	Définit le délai de protection contre les surintensités.
:STARt SCHange CCTRans	Indique l'événement déclencheur du temporisateur de protection contre les surintensités.
:STATe 0 OFF 1 ON	Active ou désactive la fonction de protection contre les surintensités.
:SHARing	
[:STATe] 0 OFF 1 ON	Active ou désactive la fonction de partage de courant sur les appareils connectés en parallèle. (RP795xA, RP796xA)
:SLEW	
[:IMMediate] <valeur> INFinity	Définit la vitesse de balayage du courant.
:MAXimum 0 OFF 1 ON	Active ou désactive le remplacement de la vitesse de balayage maximale.
[SOURce:]	
DIGital	
:INPut	
:DATA?	Lit l'état du port de commande numérique.
:OUTPut	
:DATA <valeur>	Définit l'état du port de commande numérique.
:PIN<1-7>	
:FUNction <fonction>	Définit la fonction de la broche. DIO DINPut FAULt INHibit ONCouple OFFCouple TOUTput TINPut
:POLarity POSitive NEGative	Définit la polarité de la broche.
:TOUTput	
:BUS	
[:ENABLE] 0 OFF 1 ON	Active ou désactive les déclencheurs BUS sur les broches du port numérique.
[SOURce:]	
FUNction CURRent VOLTage	Définit la régulation de sortie : priorité de tension ou priorité de courant.
[SOURce:]	
LIST	
:COUNT <valeur> INFinity	Définit le nombre de répétitions de la liste.
:CURRent	
[:LEVel] <valeur>{,<valeur>}	Indique le réglage de chaque palier de liste.

1 Aide-mémoire

:POINTS?	Renvoie le nombre de points de liste.
:DWELL <valeur>{,<valeur>}	Indique la durée de chaque palier de liste.
:POINTS?	Renvoie le nombre de points de liste.
:STEP ONCE AUTO	Indique comment la liste répond aux déclenchements.
:TERMinate	
:LAST 0 OFF 1 ON	Détermine la valeur de sortie lorsque la liste s'arrête.
:TOUTput	
:BOSTep	
[:DATA] <Booléen>{,<Booléen>}	Génère un signal de sortie de déclenchement en début de palier (Beginning Of Step).
:POINTS?	Renvoie le nombre de points de liste.
:EOSTep	
[:DATA] <Booléen>{,<Booléen>}	Génère un signal de sortie de déclenchement en fin de palier (End Of Step).
:POINTS?	Renvoie le nombre de points de liste.
:VOLTage	
[:LEVel] <valeur>{,<valeur>}	Indique le réglage de chaque palier de liste.
:POINTS?	Renvoie le nombre de points de liste.

[SOURce:]

POWer

:LIMit? Renvoie la limite de puissance de sortie de l'instrument.

[SOURce:]

STEP

:TOUTput0|OFF|1|ON Indique si une sortie de déclenchement est générée lorsqu'un palier de transitoire se produit.

[SOURce:]

VOLTage

[:LEVel]

[:IMMediate]

[:AMPLitude] <valeur> Définit la tension de sortie en mode de priorité de tension.

:TRIGgered

[:AMPLitude] <valeur> Règle la tension de sortie déclenchée.

:BWIDth LOW|HIGH1 Définit la compensation de la tension (RP795xA, RP796xA)

:RANGe 0 | 1 | 2 Définit la compensation de tension. (RP793xA, RP794xA)

:LEVel 0 | 1 | 2, <valeur> Définit la fréquence de compensation. (RP793xA, RP794xA)

:LIMit

[:POSitive]

[:IMMediate]

[:AMPLitude] <valeur> Définit la limite de tension en mode de priorité de courant.

:LOW <valeur> Définit la limite basse de tension. (RP793xA, RP794xA)

:MODE FIXed|STEP|LIST|ARB Définit le mode de transitoire.

:PROTection

[:LEVel] <valeur>	Règle le niveau de protection contre les surtensions.
:LOW	
[:LEVel] <valeur>	Définit le niveau de protection contre les sous-tensions. (RP793xA, RP794xA)
:DElay <valeur>	Définit le délai de protection contre les sous-tensions. (RP793xA, RP794xA)
:STATe 0 OFF 1 ON	Active ou désactive la protection contre les surtensions. (RP793xA, RP794xA)
:RESistance	
[:LEVel]	
[:IMMediate]	
[:AMPLitude] <valeur>	Définit le niveau de résistance de sortie.
:STATe 0 OFF 1 ON	Active ou désactive la programmation de résistance de sortie.
:SLEW	
[:IMMediate] <valeur> INFinity	Définit la vitesse de balayage de tension.
:MAXimum 0 OFF 1 ON	Active ou désactive le remplacement de la vitesse de balayage maximale.

STATus

:OPERation	
[:EVENT]?	Effectue une recherche dans le registre des événements de fonctionnement.
:CONDition?	Effectue une recherche dans le registre des conditions de fonctionnement.
:ENABle <valeur>	Définit le registre d'activation du fonctionnement.
:NTRansiton <valeur>	Règle le filtre de transition négatif.
:PTRansiton <valeur>	Règle le filtre de transition positif.
:PRESet	Prédéfini tous les registres d'activation, PTR et NTR.
:QUEStionable <1 2>	
[:EVENT]?	Effectue une recherche dans le registre des événements suspects.
:CONDition?	Effectue une recherche dans le registre des conditions suspectes.
:ENABle <valeur>	Définit le registre d'activation suspect.
:NTRansiton <valeur>	Règle le filtre de transition négatif.
:PTRansiton <valeur>	Règle le filtre de transition positif.

SYSTem

:COMMunicate	
:LAN TCPip:CONTRol?	Renvoie le numéro de port de connexion par socket de contrôle initial.
:RLSTate LOCAl REMOte RWLock	Configure la configuration distante/locale de l'instrument.
:DATE <aaa>, <mm>, <jj>	Règle la date de l'horloge système.
:ERRor?	Lit et efface une erreur dans la file d'erreurs.
:LFRequency?	Renvoie la fréquence de référence de la tension d'alimentation.
:LFRequency	
:MODE AUTO MAN50 MAN60	Indique une détection automatique ou manuelle de la fréquence réseau.
:PASSword	
:FPANel	
:RESet	Réinitialise le mot de passe de verrouillage du panneau avant à zéro.
:REBoot	Redémarre l'instrument à son état de mise sous tension.
:SDS	(Les commandes SDS s'appliquent uniquement à N795xA, N796xA)
:CONNect	Se connecte à l'appareil SDS.

1 Aide-mémoire

:MODE AUTO MANual	Sélectionne le mode de connexion à la mise sous tension.
:DIGital	
:DATA	
:INPut?	Lit les signaux du port numérique SDS.
:OUTPut <valeur>	Définit les signaux de sortie numérique SDS.
:ENABle 0 OFF 1 ON	Active ou désactive l'appareil SDS.
:STATus?	Renvoie l'état SDS.
:SECurity	
:IMMediate	Efface toute la mémoire utilisateur et redémarre l'instrument.
:SET <données de bloc>	Obtient et définit l'état de l'instrument.
:TIME <hh>, <mm>, <ss>	Règle l'heure de l'horloge système.
:VERSion?	Renvoie la version SCPI à laquelle l'instrument est conforme.

TRIGger

:ACQuire	
[:IMMediate]	Génère un événement de déclenchement immédiat.
:CURRent	
[:LEVel] <valeur>	Définit le niveau déclenché de la sortie.
:SLOPe POSitive NEGative	Définit la pente du signal.
:INDices	
[:DATA]?	Renvoie les indices où les déclenchements ont été capturés.
:COUNT?	Renvoie le nombre de déclenchements capturés pendant l'acquisition.
:SOURce <source>	Sélectionne la source de déclenchement du système d'acquisition : BUS CURRent1 EXTer-nal PIN<1-7> TRANSient1 VOLTage1
:TOUTput	
[:ENABle] 0 OFF 1 ON	Active les déclencheurs de mesure à envoyer à une broche de port numérique.
:VOLTage	
[:LEVel] <valeur>	Définit le niveau déclenché de la sortie.
:SLOPe POSitive NEGative	Définit la pente du signal.
:ARB	
:SOURce <source>	Sélectionne la source de déclenchement des signaux arbitraires : BUS EXTer-nal IMMe-diate PIN<1-7>
:ELOG	
[:IMMediate]	Génère un événement de déclenchement immédiat.
:SOURce <source>	Sélectionne la source de déclenchement de l'enregistrement de données externe : BUS EXTer-nal IMMediate PIN<1-7>
:TRANSient	
[:IMMediate]	Génère un événement de déclenchement immédiat.
:SOURce <source>	Sélectionne la source de déclenchement du système de transitoire : BUS EXTer-nal IMMe-diate PIN<1-7>

Fonctionnalités et options des modèles

Fonctionnalités des modèles

	Modèles 5 kW - Modèles 10 kW -	RP7931A/RP7941A RP7933A/RP7943A	RP7932A/RP7942A RP7935A/RP7945A	RP7936A/RP7946A	RP7951A/RP7961A RP7952A/RP7962A	RP7953A/RP7963A
Valeurs nominales de tension, courant et puissance	0 à 20 V 0 à ±400 A (5 kW) 0 à ±800 A (10 kW)	0 à 80 V 0 à ±125 A (5 kW) 0 à ±250 A (10 kW)	0 à 160 V 0 à ±125 A (10 kW)	0 à 500 V 0 à ±20 A (5 kW) 0 à ±40 A (10 kW)	0 à 950 V 0 à ±20 A (10 kW)	
Triphasé, valeur nominale de 200–208 V CA	RP7931A/RP7933A	RP7932A/RP7935A	RP7936A	RP7951A/RP7952A	RP7953A	
Triphasé, valeur nominale de 400–480 V CA	RP7941A/RP7943A	RP7942A/RP7945A	RP7946A	RP7961A/RP7962A	RP7963A	
Fonctionnement par absorption / sur source à 2 quadrants	Oui	Oui	Oui	Oui	Oui	
Commutation automatique de plage de sortie	1,6 à 1	2 à 1	2 à 1	2 à 1	2 à 1	
Listes de sortie	Oui	Oui	Oui	Oui	Oui	
Signaux arbitraires	Oui	Oui	Oui	Oui	Oui	
Largeur de bande réglable	Tension et courant	Tension et courant	Tension et courant	Tension seulement	Tension seulement	
Fonctionnement en parallèle	Oui	Oui	Oui	Oui	Oui	
Mode principal/secondaire	Oui	Oui	Oui	Oui	Oui	
Programmation de la tension et du courant	Oui	Oui	Oui	Oui	Oui	
Programmation de la résistance de sortie	Oui*	Oui*	Oui	Oui	Oui	
Mesure de la tension et du courant	Oui	Oui	Oui	Oui	Oui	
Ampères-heures, watts-heures et mesure de la puissance	Oui	Oui	Oui	Oui	Oui	
Relecture de tableau	Oui	Oui	Oui	Oui	Oui	
Échantillonnage réglable	Oui	Oui	Oui	Oui	Oui	

1 Aide-mémoire

	Modèles 5 kW - Modèles 10 kW -	RP7931A/RP7941A RP7933A/RP7943A	RP7932A/RP7942A RP7935A/RP7945A	RP7936A/RP7946A	RP7951A/RP7961A RP7952A/RP7962A	RP7953A/RP7963A
Enregistrement de données externe	Oui	Oui	Oui	Oui	Oui	Oui
Protection contre les sous-tensions	Oui	Oui	Oui	Oui	Non	Non
Appareil SDS disponible	Non	Non	Non	Non	Oui	Oui

*Nécessite la version B.03.02.1232 et supérieure du microprogramme.

Options/Accessoires

Option/Accessoire	Description
Option UK6	Étalonnage commercial avec données des résultats de test
Option 056	Ajout d'une licence pour le logiciel de contrôle et d'analyse Keysight 14585A
Keysight SD1000A Option 500 Keysight SD1000A Option 950	Système de déconnexion de sécurité : comprend des relais de déconnexion de mesure et d'alimentation redondante. Cet accessoire nécessite l'utilisation de l'option 500 sur les modèles 500 V et de l'option 950 sur les modèles 950 V. Cet accessoire ne peut pas être utilisé sur les modèles RP793xA et RP794xA.
RP7909A Keysight	Kit de montage en baie et sur glissière : pour les monter les appareils dans les armoires EIA de 48 cm (19 pouces)
Keysight 1CP108A	Kit de brides pour montage en rack avec poignées
Keysight E3663AC	Kit de rails de base pour les supports d'instruments Keysight du système II

Spécifications et caractéristiques - RP793xA, RP794xA

Spécifications - RP793xA, RP794xA

Caractéristiques supplémentaires - RP793xA, RP794xA

Caractéristiques communes

Efficacité de l'entrée CA, facteur de puissance et DHT

Graphiques des impédances de sortie

Limite de charge inductive pour un fonctionnement en courant constant (CC)

Limite de charge capacitive pour un fonctionnement en tension constante (CV)

Précision et résolution de la mesure

Protection dynamique excessive

Quadrants de sortie

Spécifications - RP793xA, RP794xA

Sauf indication contraire, les spécifications sont garanties sur la plage de température ambiante comprise entre 0 et 40 °C après un délai de préchauffage de 30 minutes. Les spécifications s'appliquent aux bornes de sortie, les bornes de mesure étant connectées aux bornes de sortie (mesure locale).

Spécification	RP7931A, RP7941A	RP7932A, RP7942A	RP7933A, RP7943A	RP7935A, RP7945A	RP7936A, RP7946A
Valeurs nominales en courant continu					
Source de tension :	0 à 20 V	0 à 80 V	0 à 20 V	0 à 80 V	0 à 160 V
Source et absorption de courant :	0 à ±400 A	0 à ±125 A	0 à ±800 A	0 à ±250 A	0 à ±125 A
Puissance :	0 à ±5 kW	0 à ±5 kW	0 à ±10 kW	0 à ±10 kW	0 à ±10 kW
Ondulation et bruit de sortie					
Valeur crête à crête en mode CV : ¹	30 mV	80 mV	30 mV	80 mV	200 mV
Valeur efficace en mode CV : ²	3 mV	8 mV	3 mV	8 mV	20 mV
Régulation de charge					
Tension :	1 mV	3 mV	1 mV	3 mV	6 mV
Courant :	25 mA	13 mA	50 mA	25 mA	13 mA
Précision de programmation et de mesure du courant ³					
	0,02% + 2 mV	0,02% + 8 mV	0,02% + 2 mV	0,02% + 8 mV	0,02% + 16 mV
Précision de programmation et de mesure du courant : ³					
	0,04 % + 45 mA	0,03% + 13 mA	0,04 % + 90 mA	0,03% + 25 mA	0,03% + 13 mA
Réponse transitoire ⁴					
Temps de récupération :	300 µs	300 µs	300 µs	300 µs	300 µs
Bande de stabilisation :	0,2 V	0,8 V	0,2 V	0,8 V	1,6 V

¹ De 20 Hz à 20 MHz (bande passante de -3dB) avec charge résistive, bornes non raccordées à la masse ou bornes raccordées à la masse

² De 20 Hz à 10 MHz (bande passante de -3dB) avec charge résistive, bornes non raccordées à la masse ou bornes raccordées à la masse

³ Pourcentage de valeur + décalage à 25°C ±5 °C après un délai de préchauffage de 30 minutes ; NPLC de mesure = 1 ; valide pendant 1 an. Voir

1 Aide-mémoire

Intervalle d'étalonnage:

avec une chute de tension des fils de charge pouvant atteindre 1 V par fil - reportez-vous à la section **Taille des fils** pour des informations complémentaires sur la chute de tension des fils de charge

⁴ Temps nécessaire pour revenir à la bande de stabilisation après une variation de palier de 40 à 90% de la charge totale (temps d'augmentation de courant de 35 μ s)

Caractéristiques supplémentaires - RP793xA, RP794xA

Les caractéristiques supplémentaires ne sont pas garanties, mais décrivent les performances déterminées par définition ou par test type. Les caractéristiques supplémentaires sont standard, sauf indication contraire.

Caractéristique	RP7931A, RP7941A	RP7932A, RP7942A	RP7933A, RP7943A	RP7935A, RP7945A	RP7936A, RP7946A
Limites de conformité minimales					
Priorité de tension :	±400 mA	±125 mA	±800 mA	±250 mA	±125 mA
Priorité de courant ¹ :	0 et 20 mV	0 et 80 mV	0 et 20 mV	0 et 80 mV	0 et 160 mV
Plage de programmation de la tension :					
Résolution :	0,02 à 20,4 V	0,08 à 81,6 V	0,02 à 20,4 V	0,08 à 81,6 V	0,16 V à 163,2 V
	191 µV	800 µV	191 µV	800 µV	1,6 mV
Résolution					
Plage :	-408 A à 408 A	-127,5 A à 127,5 A	-816 A à 816 A	-255 A à 255 A	-127,5 A à 127,5 A
Résolution :	7,7 mA	2,5 mA	15,5 mA	5 mA	2,5 mA
Programmation de la résistance					
Plage :	0 à 0,098 Ω	0 à 1,25 Ω	0 à 0,049 Ω	0 à 0,625 Ω	0 à 2,5 Ω
Résolution :	0,8 µΩ	9,8 µΩ	0,4 µΩ	4,8 µΩ	19,6 µΩ
Précision :	0,05% + 4 µΩ	0,05% + 32 µΩ	0,05% + 2 µΩ	0,05% + 16 µΩ	0,05% + 50 µΩ
Décalage de la programmation en V supplémentaire / Ohm :					
	50 mV	15 mV	100 mV	30 mV	15 mV
Plage de mesure					
Tension :	-25 V à 25 V	-100 V à 100 V	-25 V à 25 V	-100 V à 100 V	-200 V à 200 V
Courant :	-1014 A à 1014 A	-315 A à 315 A	-2028 A à 2028 A	-630 A à 630 A	-315 A à 315 A
Bruit de numérisation de la mesure ²					
Tension :	4 mV	20 mV	4 mV	20 mV	40 mV
Courant :	400 mA	200 mA	800 mA	400 mA	200 mA
Programmation et mesure tempCo ³					
Tension :	0,0015% +80 µV/°C	0,0015% +300 µV/°C	0,0015% +80 µV/°C	0,0015% +300 µV/°C	0,0015% +600 µV/°C
Courant :	0,0075% +1,2 mA/°C	0,0025% +400 µA/°C	0,0075% +2,3 mA/°C	0,0025% +800 µA/°C	0,0025% +400 µA/°C
Ondulation et bruit du courant de sortie (CC rms) :					
	200 mA	70 mA	200 mA	70 mA	50 mA
Courant de mode commun					
Valeur efficace en mode CC :	2 mA	2,5 mA	2 mA	2,5 mA	3,5 mA
Valeur crête à crête en mode CC :	20 mA	24 mA	20 mA	24 mA	30 mA
Protection contre les surtensions ⁴					
Réglage maximal :	24 V	96 V	24 V	96 V	192 V
Temps de réponse :	< 30 µs	< 30 µs	< 30 µs	< 30 µs	< 30 µs
Précision :	0,02% + 2 mV	0,02% + 8 mV	0,02% + 2 mV	0,02% + 8 mV	0,02% + 16 mV
Vitesse de programmation de la tension, à vide ⁵					
Temps de montée/descente de 10 % à 90 % du palier :	80 µs	75 µs	80 µs	75 µs	75 µs
Temps d'établissement à 0,1 % du palier :	810 µs	480 µs	810 µs	480 µs	550 µs

1 Aide-mémoire

Caractéristique	RP7931A, RP7941A	RP7932A, RP7942A	RP7933A, RP7943A	RP7935A, RP7945A	RP7936A, RP7946A
Vitesse de programmation de la tension, à pleine charge ⁶	140 µs	130 µs	140 µs	130 µs	170 µs
Temps de montée/descente de 10 % à 90 % du palier :	4,2 ms	1,35 ms	4,2 ms	1,35 ms	1,35 ms
Temps d'établissement à 0,1 % du palier :					
Vitesse de programmation haut/bas du courant ⁷	300 µs	180 µs	300 µs	180 µs	190 µs
Temps de montée/descente de 10 % à 90 % du palier :	960 µs	500 µs	960 µs	500 µs	550 µs
Temps de stabilisation à 0,1 % du palier :					
Sortie selon le délai de temporisation ⁸					
Priorité de tension - haute impédance :	8,1 ms	8,1 ms	8,1 ms	8,1 ms	8,1 ms
Priorité de tension - faible impédance :	8,1 ms	8,1 ms	8,1 ms	8,1 ms	8,1 ms
Priorité de courant :	7,1 ms	7,1 ms	7,1 ms	7,1 ms	7,1 ms
Inductance en charge maximale : ⁹	20 µH	200 µH	10 µH	100 µH	400 µH
Régulation de secteur					
Tension :	< 10 µV	< 10 µV	< 10 µV	< 10 µV	< 10 µV
Courant :	< 20 µA	< 10 µA	< 40 µA	< 10 µA	< 10 µA
Courant de fuite typique					
Sortie désactivée - instantanée : ¹⁰	2 µA	800 µA	4 µA	800 µA	800 µA
Sortie désactivée - long terme : ¹¹	0,4 µA	800 µA	0,8 µA	800 µA	800 µA
Appareil débranché de l'alimentation secteur :	2 µA	800 µA	4 µA	800 µA	800 µA

¹ Pour la conformité de la tension inférieure et supérieure, respectivement

² Pour la numérisation à une fréquence d'échantillonnage de 5,12 µs

³ Valable pour des températures ambiantes supérieures à 30°C ou inférieures à 20°C

⁴ Entre l'occurrence d'une surtension et le début de l'arrêt

⁵ Dans la plage CV Comp 0, Fréquence = 100 kHz, à vide, et une variation de palier de 10% à 100% de la puissance de sortie nominale

⁶ Dans la plage CV Comp 0, Fréquence = 2,3 kHz, à pleine charge, et une variation de palier de 1% à 100% de la puissance de sortie nominale

⁷ Dans la plage CC Comp 0, Fréquence = 100 kHz, et une variation de palier de 10% à 100% du courant nominal, en source CC basse impédance.

⁸ Temps entre la réception de la commande d'activation de sortie et le début de l'activation de la sortie

⁹ **ATTENTION** L'appareil est susceptible de subir des dommages internes si les limites d'inductance de charge maximale sont dépassées en courant nominal ; pour plus d'informations, reportez-vous aux **graphiques de charge inductive**.

¹⁰ Appareil mis sous tension avec la sortie désactivée pendant > 1 seconde après le fonctionnement à pleine charge

¹¹ Appareil mis sous tension avec la sortie désactivée pendant > 10 secondes après le fonctionnement à pleine charge

Caractéristiques communes

Caractéristique commune	Tous les modèles
Temps de traitement des commandes	≤ 1 ms entre la réception de la commande et le début du changement de la sortie. S'applique aux commandes de paramètres simples sur l'interface GPIB (voir Temps de traitement de commande type)

Caractéristique commune	Tous les modèles
Signaux arbitraires à palier constant	Jusqu'à 65 535
Nombre de points :	Un paramètre de temporisation s'applique à l'ARB entier, de 10,24 µs à 0,30 seconde
Plage de temporisation :	Les valeurs sont arrondies à l'incrément de 10,24 microsecondes le plus proche
Résolution de temporisation :	
<hr/>	
Interfaces informatiques	
LXI :	Spécification de l'appareil LXI 1.5 2016
LAN :	LAN 10 Mo, 100 Mo, 1 Go
USB :	USB 2.0 (protocole USB-TMC488)
GPIB :	Interface conforme SCPI - 1993, IEEE 488.2
<hr/>	
Conditions environnementales	
Conditions de fonctionnement :	Utilisation interne, catégorie d'installation II (pour l'entrée secteur), degré de pollution 2 0 à 55 °C (le courant continu maximal est déclassé à 1 % de la puissance nominale par degré C)
Plage de températures :	entre 40 et 55 °C 95% au maximum (sans condensation)
Humidité relative :	Jusqu'à 2 000 mètres
Altitude :	-30 à 70°C
Température de stockage :	
<hr/>	
Déclaration acoustique (Directive européenne relative aux machines)	Émission de bruit acoustique LpA 79 dB à l'emplacement de l'utilisateur LpA 73 dB à proximité LpA 61,4 à la vitesse du ventilateur inactif Mode de fonctionnement normal conforme à la norme ISO 7779
<hr/>	
Port numérique	
Tension nominale max. :	+16,5 V CC/- 5 V CC entre les broches
Broches 1 et 2 en tant que sortie de défaillance :	Tension de sortie de niveau faible maximale = 0,5 V à 4 mA Courant absorbé de niveau faible maximal = 4 mA Courant de fuite de niveau élevé type = 1 mA à 16,5 V CC
Broches 1-7 en tant que sorties :	Tension de sortie de niveau faible maximale = 0,5 V à 4 mA ; 1 V à 50 mA ; 1,75 V à 100 mA Courant absorbé de niveau faible maximal = 100 mA Courant de fuite de niveau élevé type = 0,8 mA à 16,5 V CC
Broches 1-7 en tant qu'entrées :	Tension d'entrée de niveau faible maximale = 0,8 V Tension d'entrée de niveau élevé minimale = 2 V Courant de niveau faible type = 2 mA à 0 V (résistance interne 2,2 k) Courant de fuite de niveau élevé type = 0,12 mA à 16,5 V CC
Broche 8 :	La broche 8 est commune (connectée en interne à la masse du châssis)

Caractéristique commune	Tous les modèles
Conformité réglementaire	
CEM :	Conforme à la directive CEM relative aux produits de test et de mesure. Conforme à la norme Australienne et porte la marque C-Tick. This ISM device complies with Canadian ICES-001. Cet appareil ISM est conforme à la norme NMB-001 du Canada.
Sécurité :	Conforme à la directive basse tension européenne et porte la marque CE. Conforme aux réglementations de sécurité américaines et canadiennes. Vous pouvez télécharger sur Internet les déclarations de conformité concernant ce produit. Accédez à la page http://www.keysight.com/go/conformity et cliquez sur Déclarations de conformité.
Entrée secteur	
Phase et plage :	Triphasé ; 200 V CA nominal $\pm 10\%$, et 208 V CA nominal $\pm 10\%$ Triphasé ; 400 V CA nominal $\pm 15\%$, et 480 V CA nominal $\pm 10\%$
Fréquence :	50/60 Hz
VA en entrée :	RP7931A, RP7932A, RP7941A, RP7942A, RP7936A : 6,5 kVA RP7933A, RP7935A, RP7936A, RP7943A, RP7945A, RP7946A : 11,5 kVA
Courant d'entrée par phase	
Entrée 200 V CA :	RP7931A, RP7932A : 17,3 A ; RP7933A, RP7935A, RP7936A : 35 A
Entrée 400 V CA :	RP7941A, RP7942A : 8,66 A ; RP7943A, RP7945A, RP7946A : 17,3 A
Efficacité à pleine puissance :	RP7931A, RP7932A, RP7941A, RP7942A : 84% RP7933A, RP7935A, RP7936A, RP7943A, RP7945A, RP7946A : 85%
Facteur de puissance :	0,99 @ entrée nominale et puissance nominale
	REMARQUE Au cours d'une coupure de ligne sur 1 cycle, l'appareil peut redémarrer. La sortie restera désactivée après le redémarrage jusqu'à ce que l'opérateur rétablisse les réglages précédents, soit grâce aux commandes du panneau avant, soit en utilisant un programme informatique. Ce comportement est conforme aux procédures d'exploitation sécuritaires.
Isolation des bornes de sortie :	
Pour modèles 20 V CC :	Aucune borne de sortie ne doit être soumise à une tension de plus de 60 V CC par rapport à une autre borne ou à la masse du châssis.
Pour modèles 80 et 160 V CC :	Aucune borne de sortie ne doit être soumise à une tension de plus de 240 V CC par rapport à une autre borne ou à la masse du châssis.
Poids type	
	RP7931A, RP7932A, RP7941A, RP7942A : 60 livres. (27,3 kg) RP7933A, RP7935A, RP7936A, RP7943A, RP7945A, RP7946A : 70 livres. (31,8 kg)
Dimensions	
	Hauteur 3U ; largeur de baie complète (voir Schémas de principe pour plus de détails)

Efficacité de l'entrée CA, facteur de puissance et DHT

Les graphiques suivants fournissent des détails supplémentaires sur l'efficacité de l'entrée CA, le facteur de puissance et la distorsion harmonique totale sur toute la gamme de puissance de l'instrument. Notez que les tensions de ligne haute sont respectivement de 208 et de 480 V CA. Les tensions de ligne basse sont respectivement de 200 V CA et de 400 V CA.

Efficacité de la source/de l'absorption RP7931A (200 V/208 V)

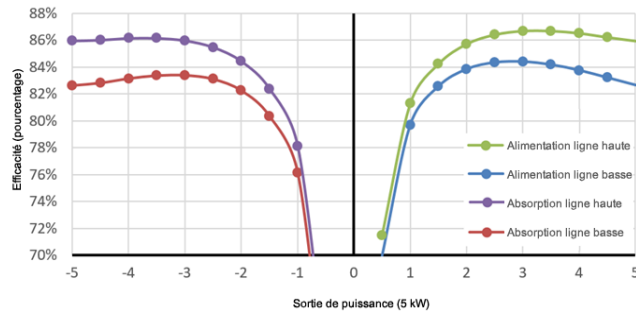

Facteur de puissance RP7931A, RP7932A (200 V/208 V)

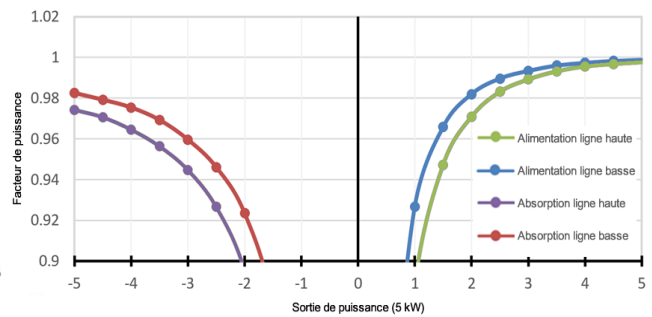

Efficacité de la source/de l'absorption RP7932A (200 V/208 V)

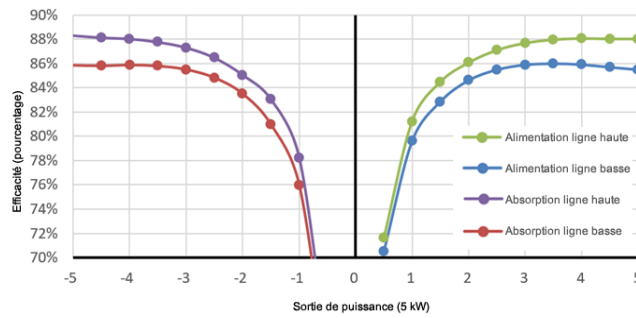

Distorsion harmonique totale RP7931A, RP7932A (200 V/208 V)

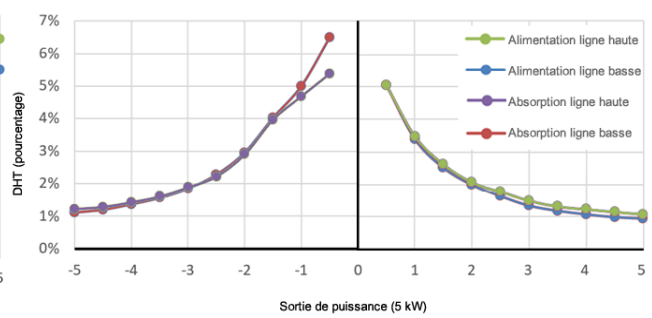

Efficacité de la source/de l'absorption RP7933A (200 V/208 V)

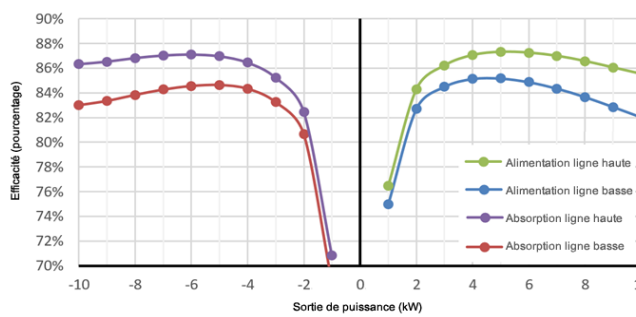

Efficacité de la source/de l'absorption RP7943A (400 V/480 V)

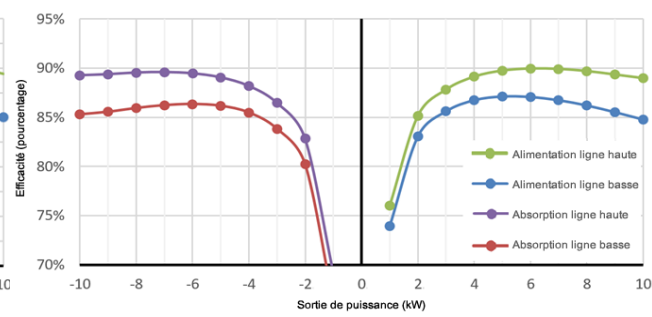

Efficacité de la source/de l'absorption RP7935A, RP7936A (200 V/208 V)

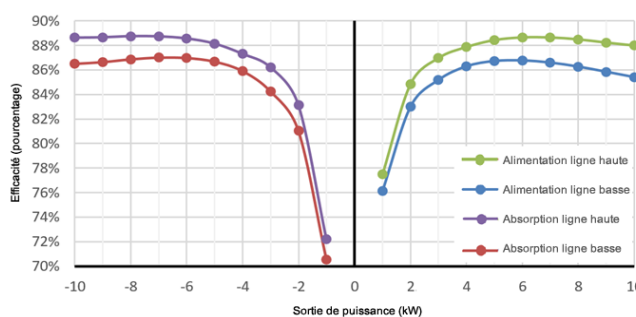

Efficacité de la source/de l'absorption, RP7946ARP7945A (400 V/480 V)

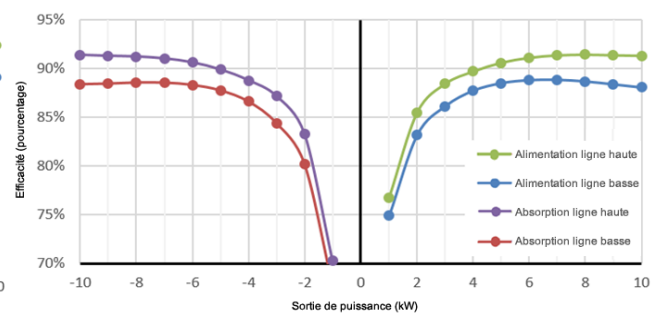

Facteur de puissance RP7933A, RP7935A, RP7936A (200 V/208 V)

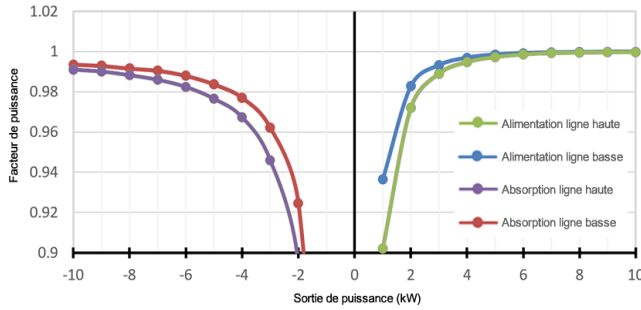

Facteur de puissance RP7943A, RP7945A, RP7946A (400 V/480 V)

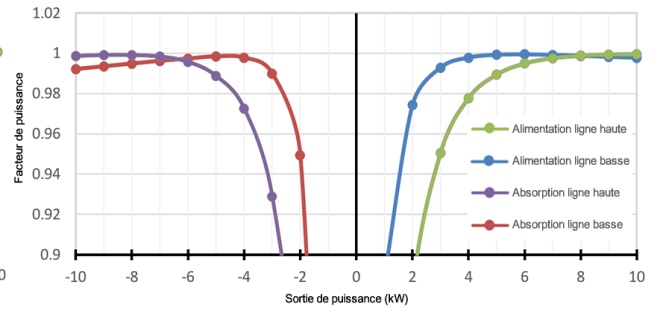

Distorsion harmonique totale RP7933A RP7935A RP7936A (200 V/208 V)

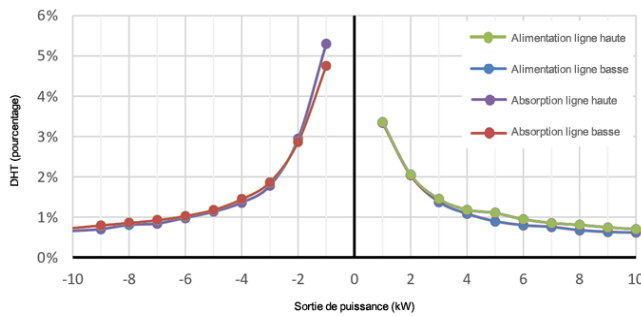

Distorsion harmonique totale RP7943A RP7945A RP7946A (400 V/480 V)

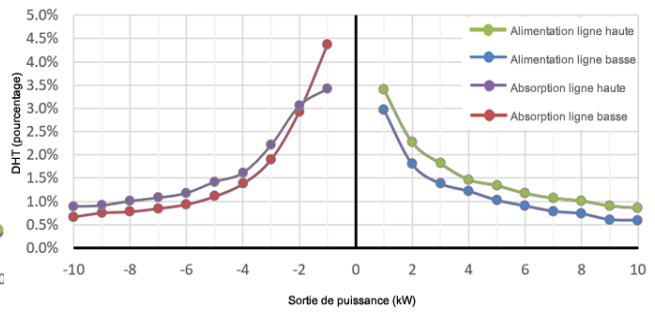

REMARQUE

Si vous utilisez des listes ou des signaux arbitraires pour générer des sinusoïdes proches de la fréquence du réseau, des courants de distorsion supplémentaires se produisent dans la ligne. Reportez-vous à la section **Limitation des sorties sinusoïdales**.

Graphiques des impédances de sortie

Les graphiques suivants indiquent l'impédance de sortie des signaux faibles des modes de compensation pour un fonctionnement en tension constante (CV) et en courant constant (CC). Les impédances sont capturées lors de la mesure au niveau des fils de charge à une distance de 15 cm (6 pouces) des barres conductrices.

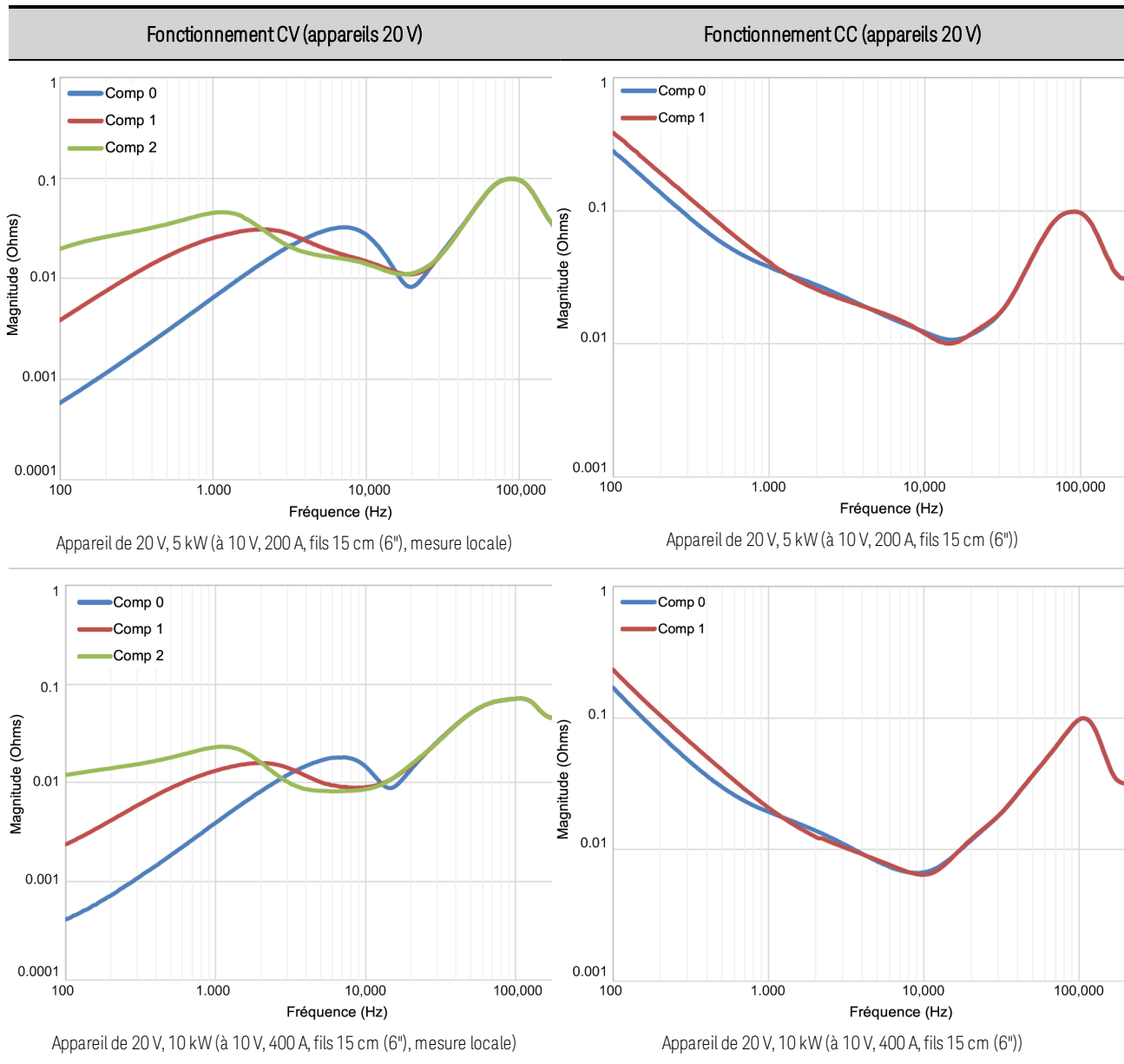

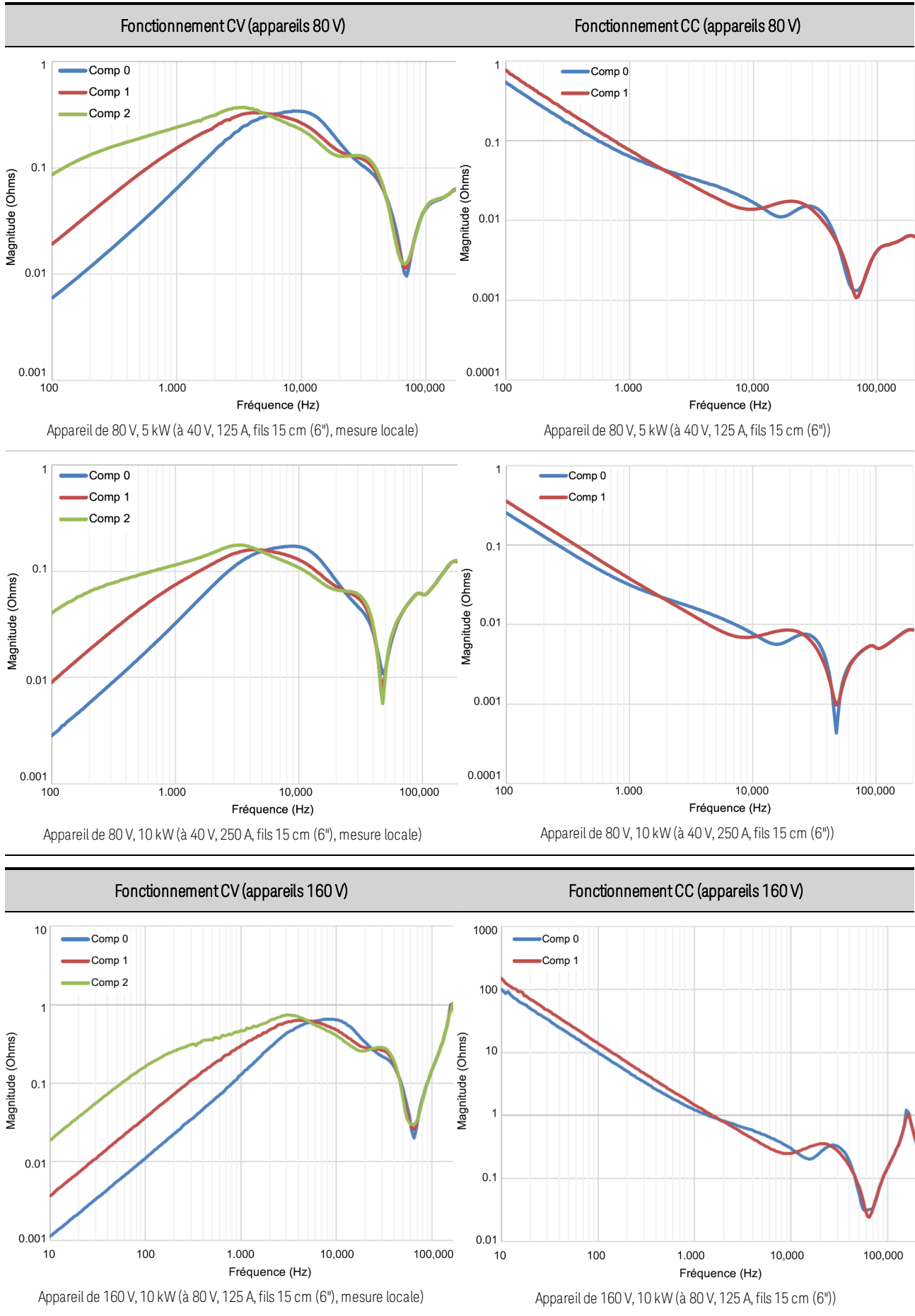

Limite de charge inductive pour un fonctionnement en courant constant (CC)

Les figures suivantes indiquent les limites maximales des charges inductives avec la résistance en série pour un fonctionnement en courant constant. Cela s'applique également lors d'un fonctionnement en tension constante à la limite de courant définie. Un fonctionnement en dessous des lignes de stabilité marginales avec les réglages de largeur de bande **Comp 0** ou **Comp 1** peut entraîner une instabilité de sortie. Notez que la résistance du fil et celle de l'appareil testé sont indifférenciables dans ce contexte. Il est également important de tenir compte de la chute de tension et de la dissipation d'énergie dans les fils en raison de la résistance accrue des fils. Reportez-vous à la section **Considérations relatives à l'inductance** pour plus de détails. Pour éviter tout endommagement de l'appareil, reportez-vous à la section **Inductance de charge maximale**.

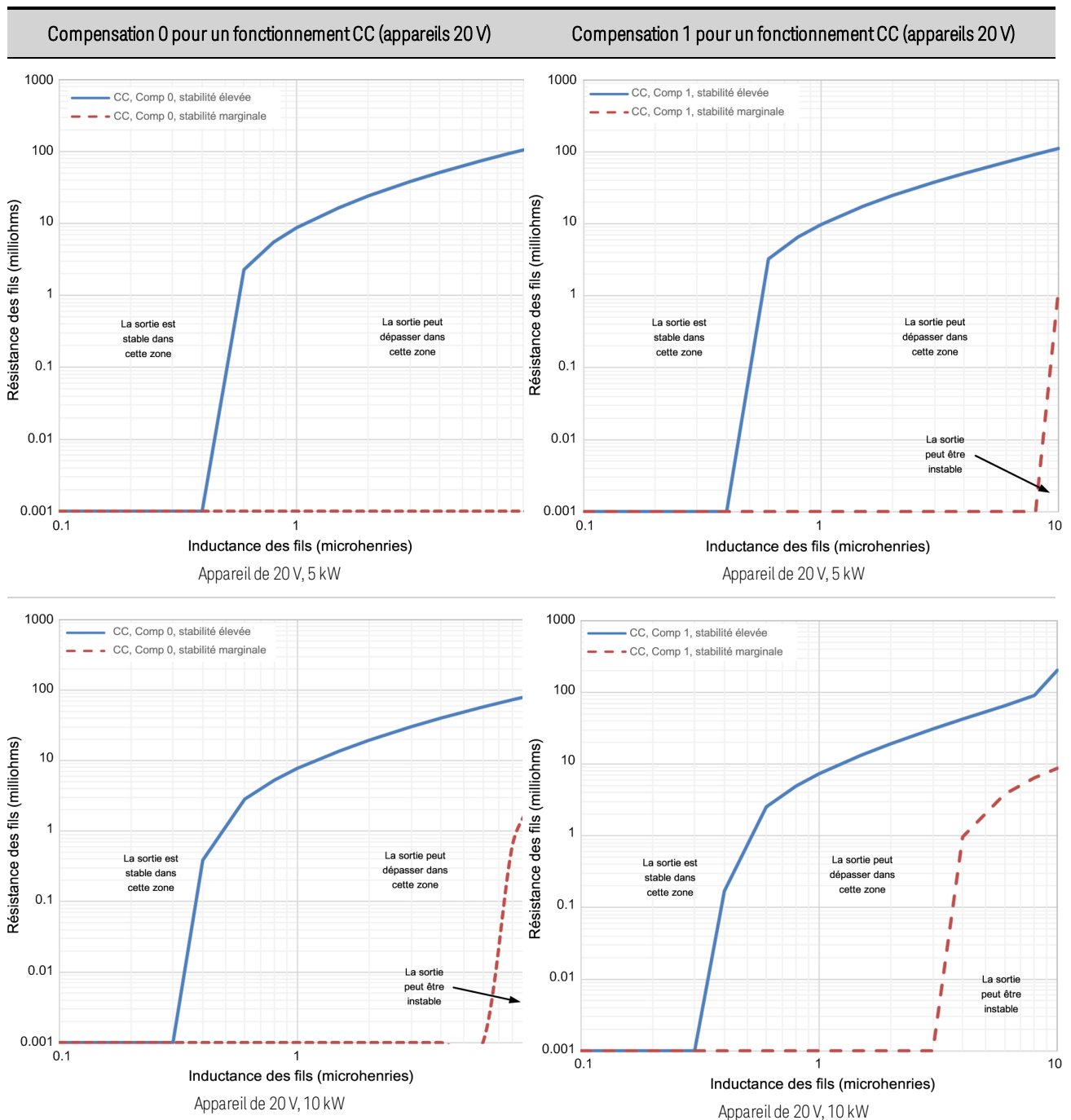

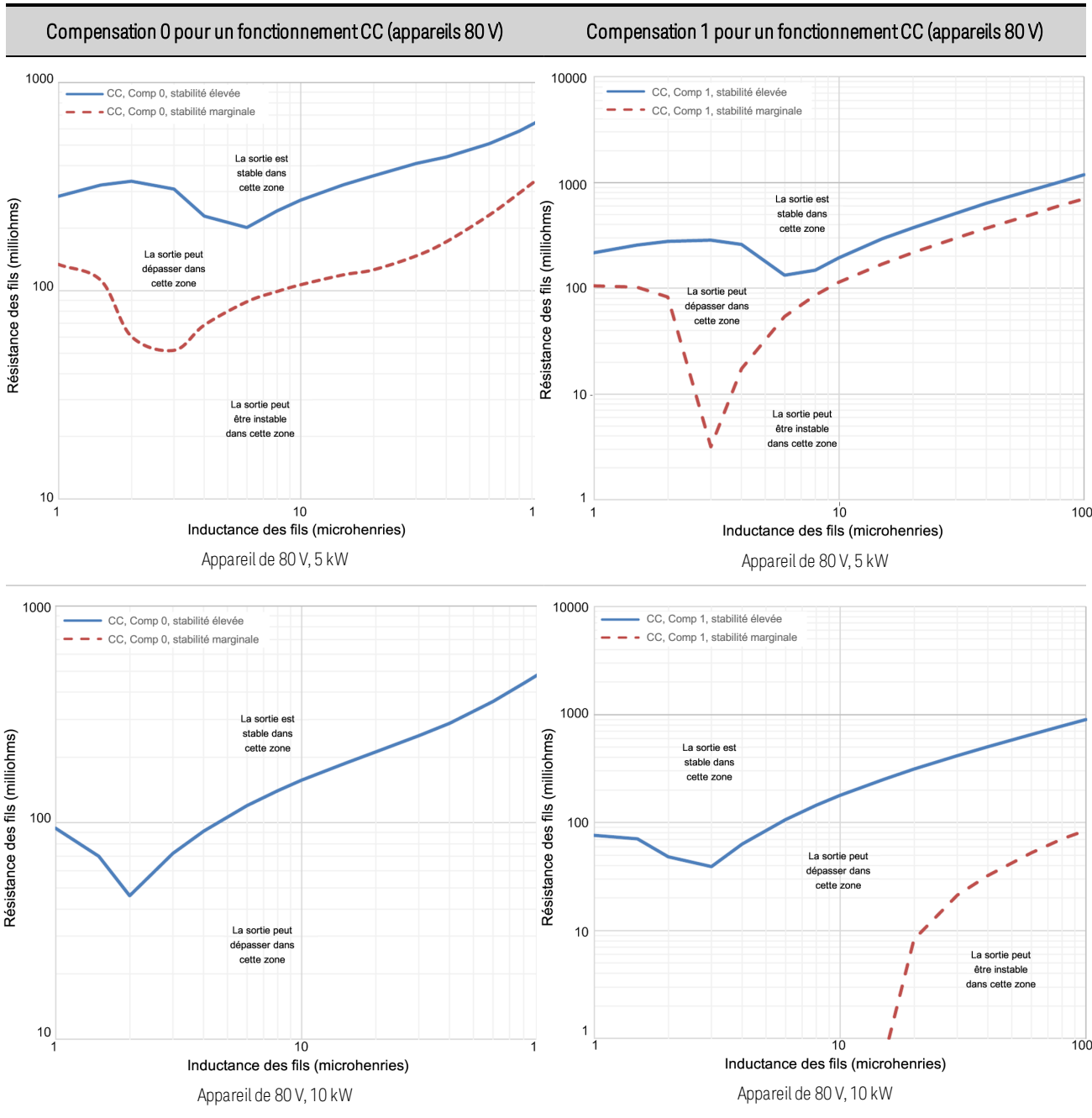

Compensation 0 pour un fonctionnement CC (appareils 160 V)

Compensation 1 pour un fonctionnement CC (appareils 160 V)

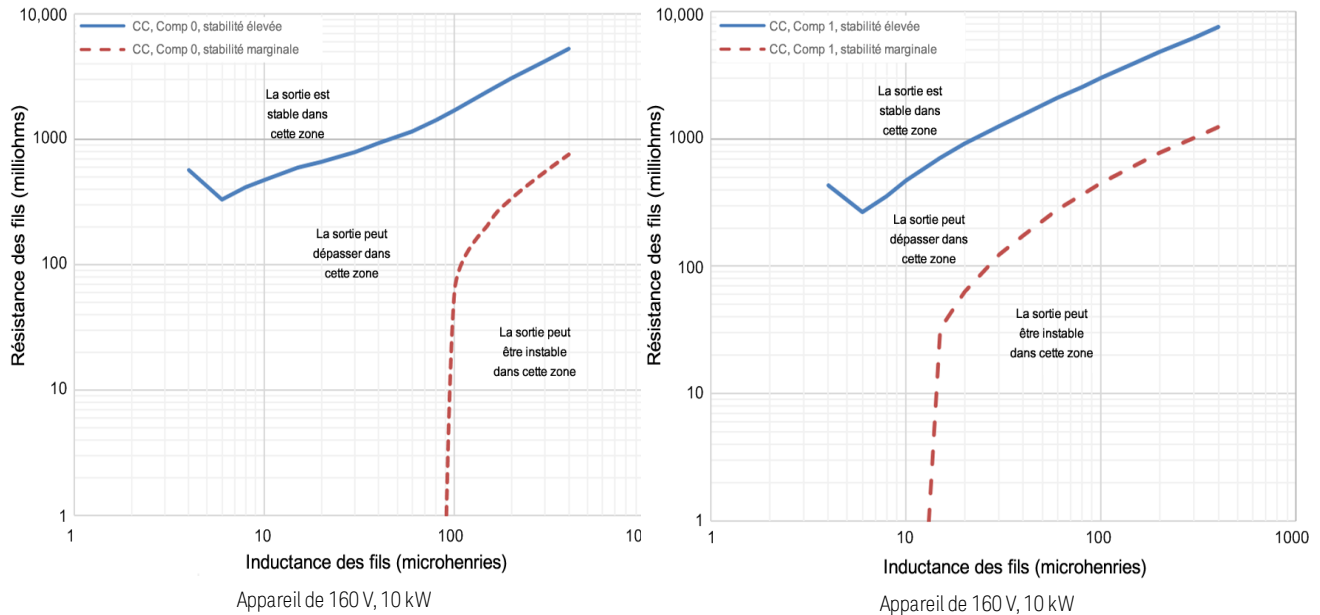

Limite de charge capacitive pour un fonctionnement en tension constante (CV)

Les figures suivantes indiquent les limites maximales des charges capacitives avec une résistance série équivalente pour un fonctionnement en tension constante. Un fonctionnement en dessous des lignes de stabilité marginales avec les réglages de largeur de bande de **Compensation** peut entraîner une instabilité de sortie. Les conditions avec et sans fil de charge illustrent les effets supplémentaires de l'inductance sur la stabilité de tension constante. Il n'y a pas de limites absolues pour la capacité de l'appareil testé, car la stabilité est aussi une fonction de l'ESR. Reportez-vous à la section **Capacité de charge et Considérations relatives à l'inductance des fils** pour plus de détails.

ESR minimum par rapport à la capacité de l'appareil testé pour les appareils de 20 V, 5 kW

Avec mesure locale et
appareil testé directement raccordé aux barres conductrices

Avec mesure à distance et
fils de charge autour de $6 \mu\text{H}/2 \text{ m}\Omega$

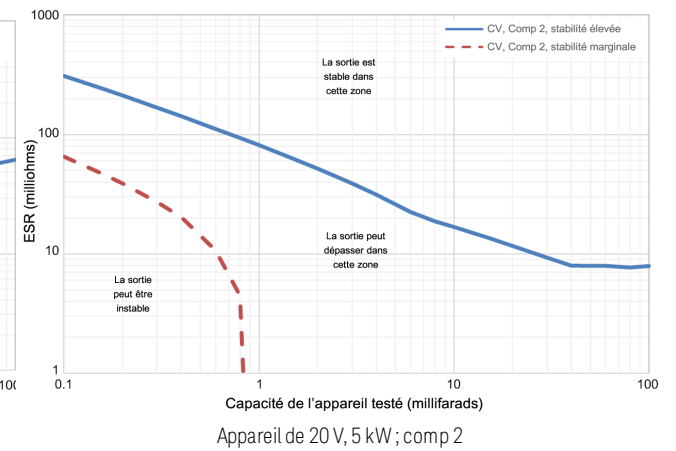
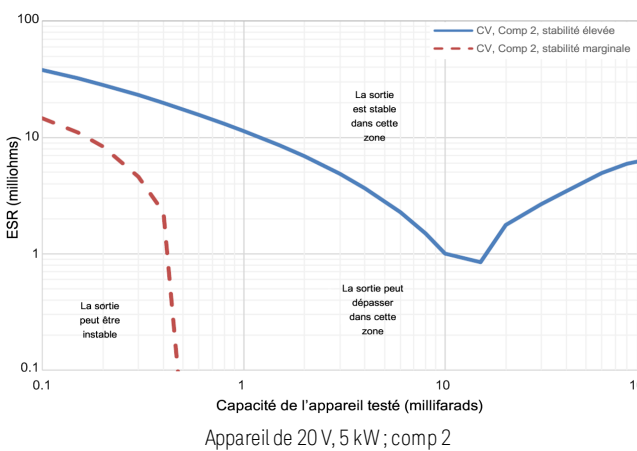
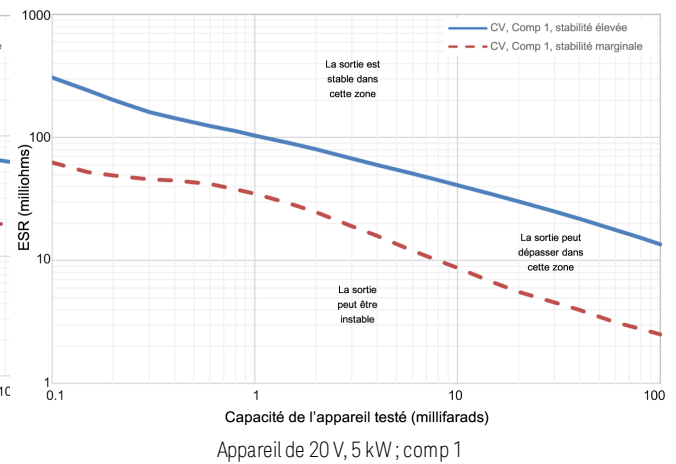
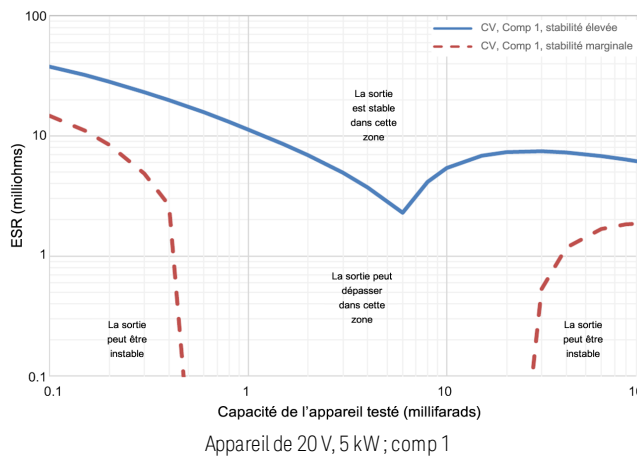
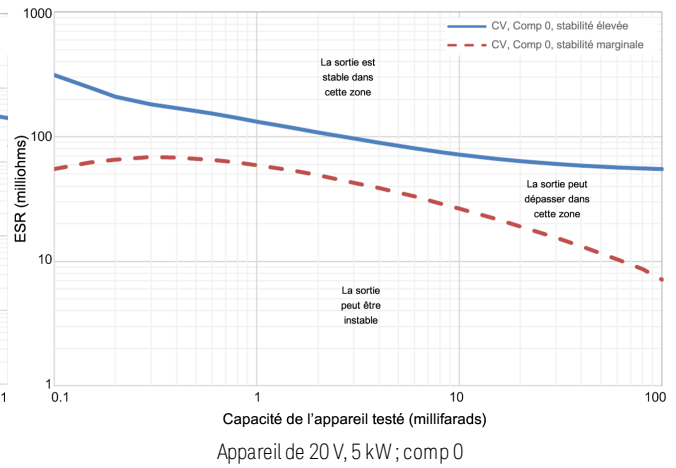
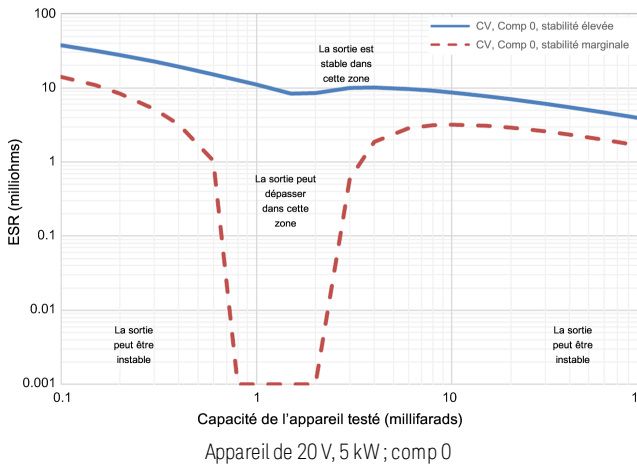

ESR minimum par rapport à la capacité de l'appareil testé pour les appareils de 20 V, 10 kW

Avec mesure locale et
appareil testé directement raccordé aux barres conductrices

Avec mesure à distance et
fils de charge autour de 3 μH/1 mΩ

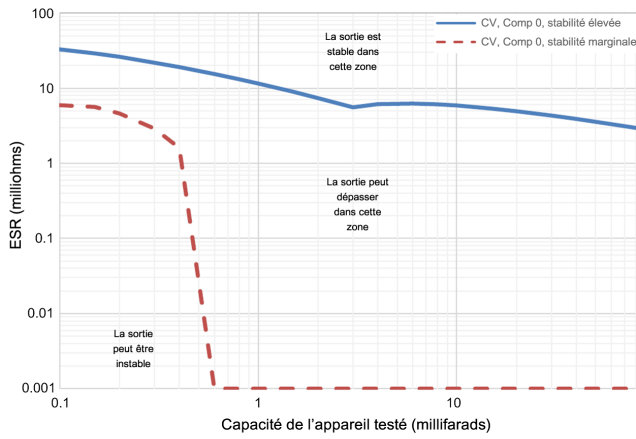

Appareil de 20 V, 10 kW ; comp 0

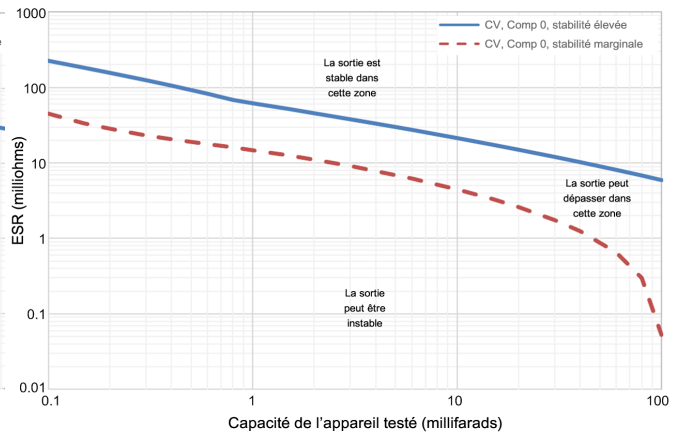

Appareil de 20 V, 10 kW ; comp 0

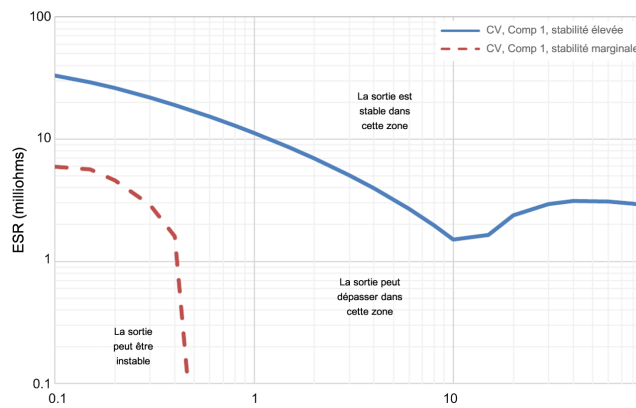

Appareil de 20 V, 10 kW ; comp 1

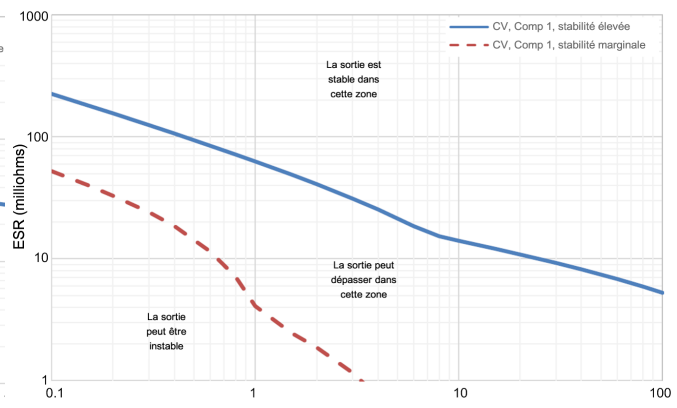

Appareil de 20 V, 10 kW ; comp 1

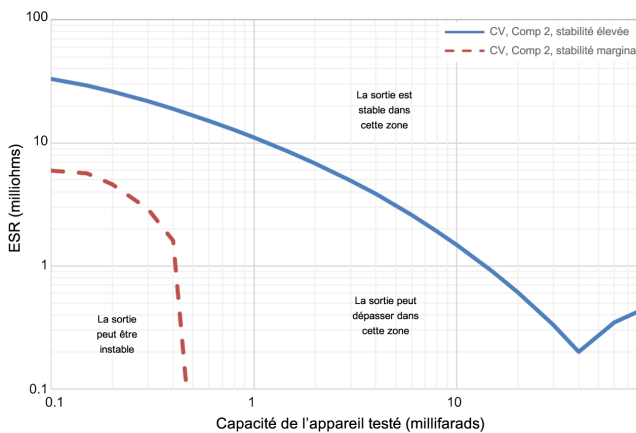

Appareil de 20 V, 10 kW ; comp 2

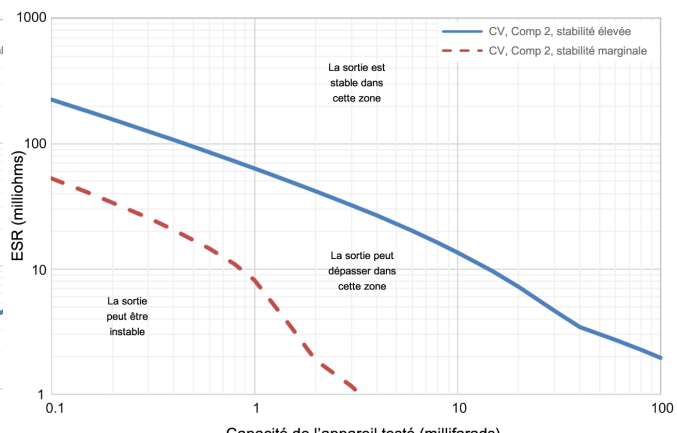

Appareil de 20 V, 10 kW ; comp 2

ESR minimum par rapport à la capacité de l'appareil testé pour les appareils de 80 V, 5 kW

Avec mesure locale et
appareil testé directement raccordé aux barres conductrices

Avec mesure à distance et
fils de charge autour de 6 $\mu\text{H}/2\text{ m}\Omega$

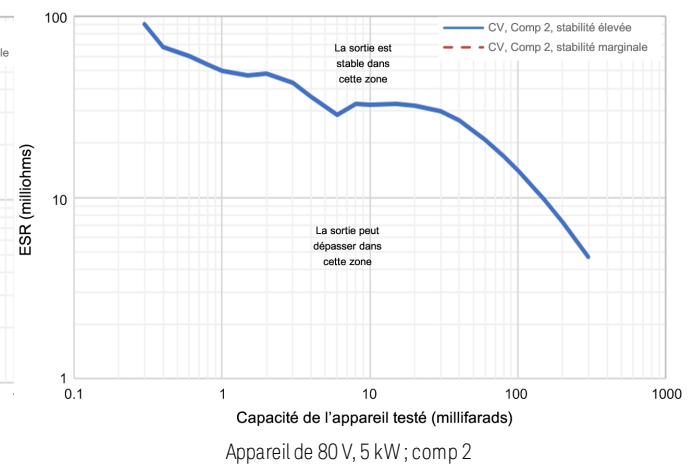
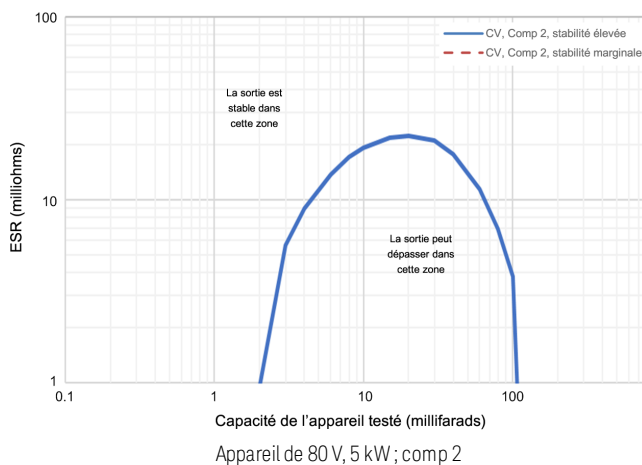
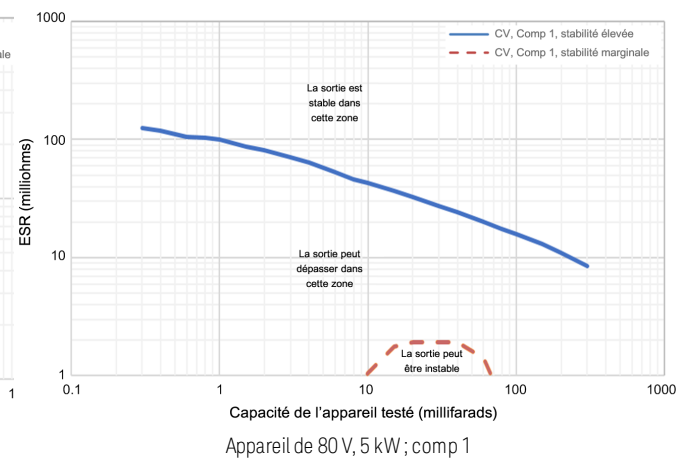
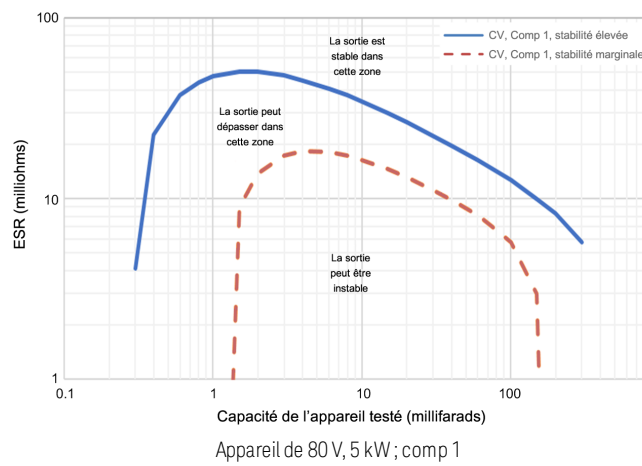
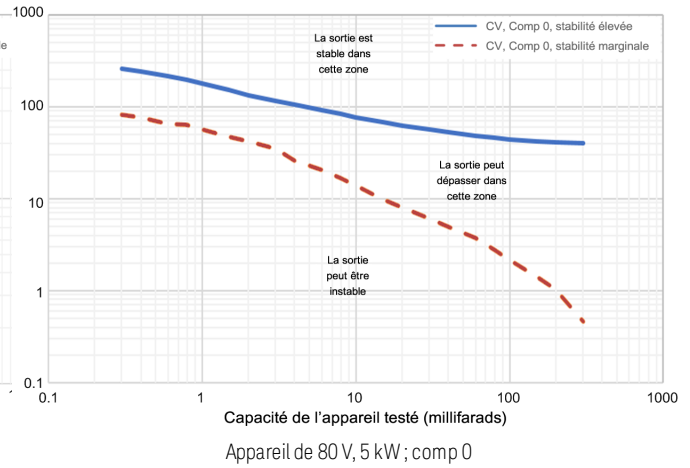
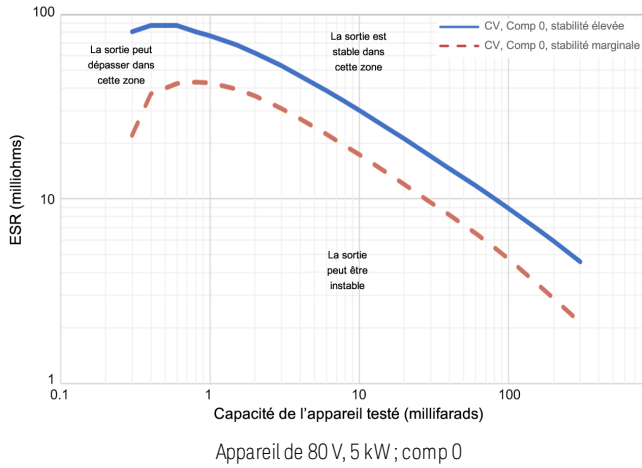

ESR minimum par rapport à la capacité de l'appareil testé pour les appareils de 80 V, 10 kW

Avec mesure locale et
appareil testé directement raccordé aux barres conductrices

Avec mesure à distance et
fils de charge autour de $3 \mu\text{H}/1 \text{ m}\Omega$

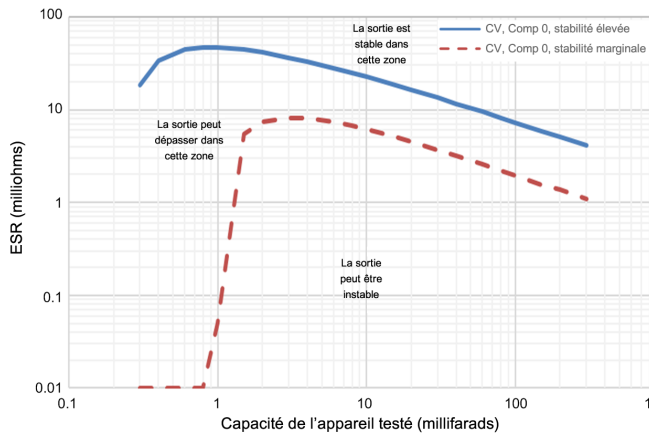

Appareil de 80 V, 10 kW ; comp 0

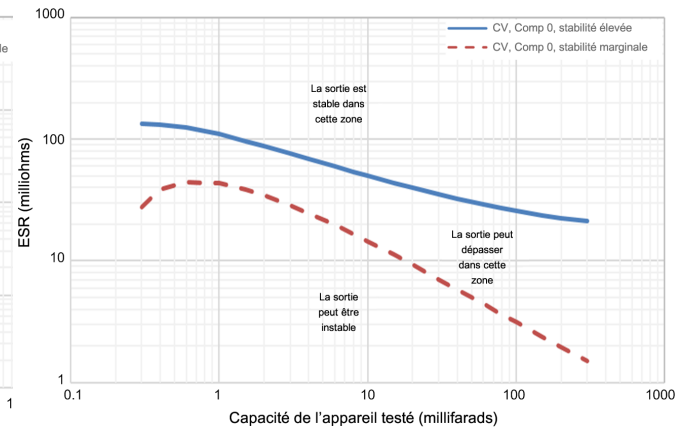

Appareil de 80 V, 10 kW ; comp 0

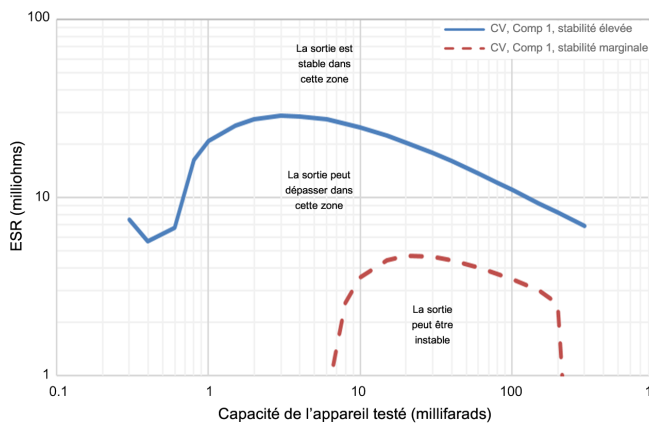

Appareil de 80 V, 10 kW ; comp 1

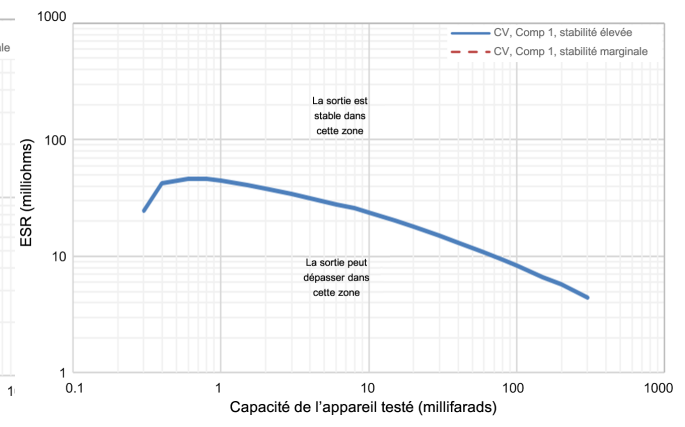

Appareil de 80 V, 10 kW ; comp 1

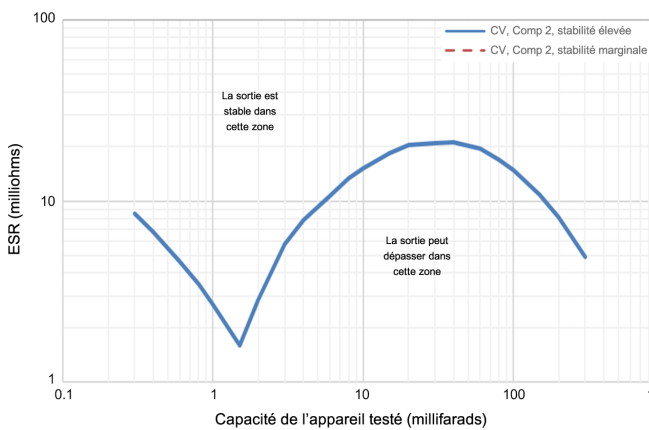

Appareil de 80 V, 10 kW ; comp 2

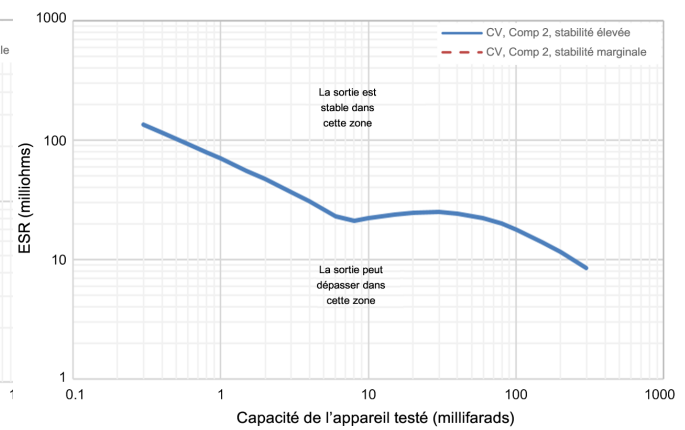

Appareil de 80 V, 10 kW ; comp 2

ESR minimum par rapport à la capacité de l'appareil testé pour les appareils de 160 V, 10 kW

Avec mesure locale et
appareil testé directement raccordé aux barres conductrices

Avec mesure à distance et
fils de charge autour de 6 $\mu\text{H}/2 \text{ m}\Omega$

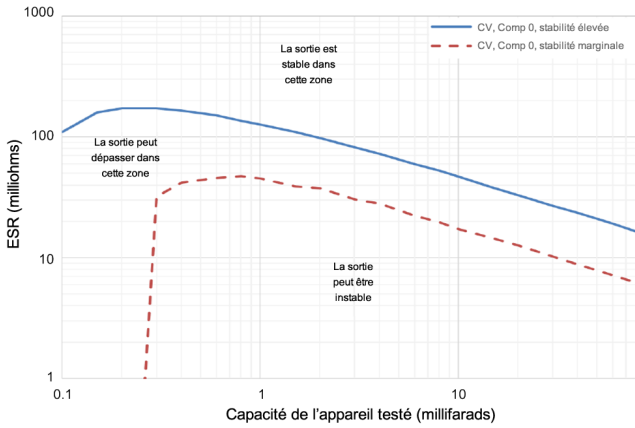

Appareil de 160 V, 10 kW ; comp 0

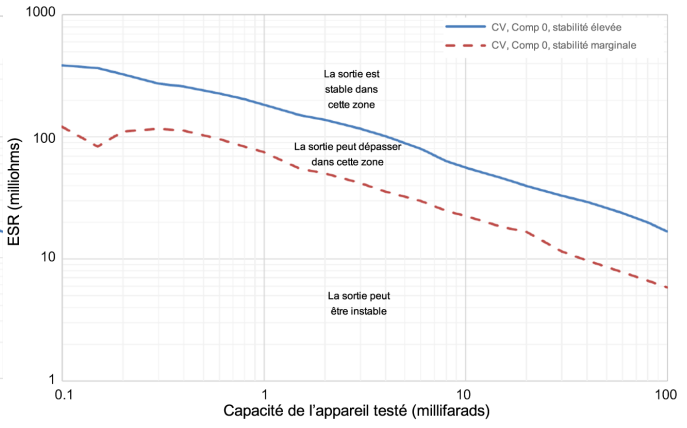

Appareil de 160 V, 10 kW ; comp 0

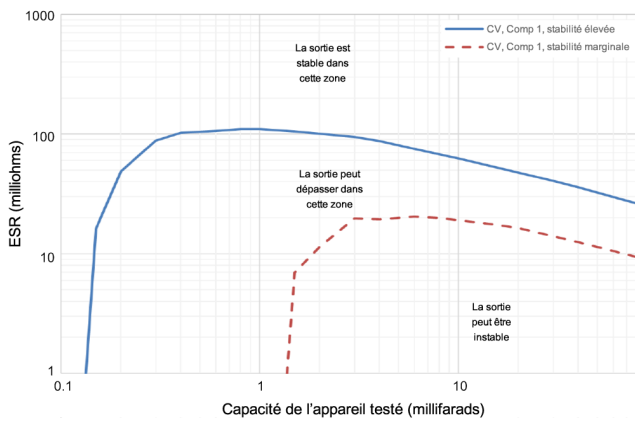

Appareil de 160 V, 10 kW ; comp 1

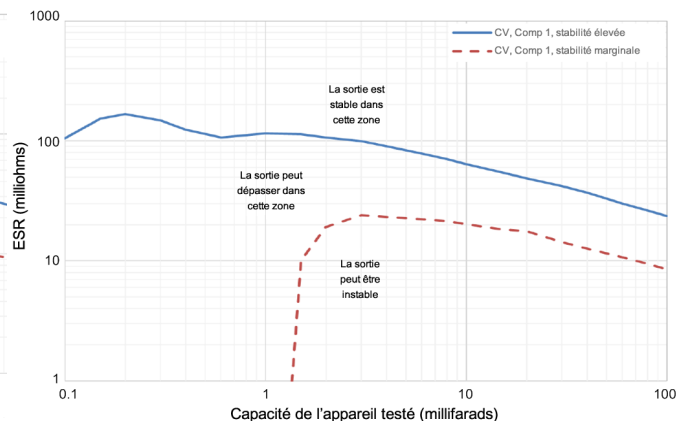

Appareil de 160 V, 10 kW ; comp 1

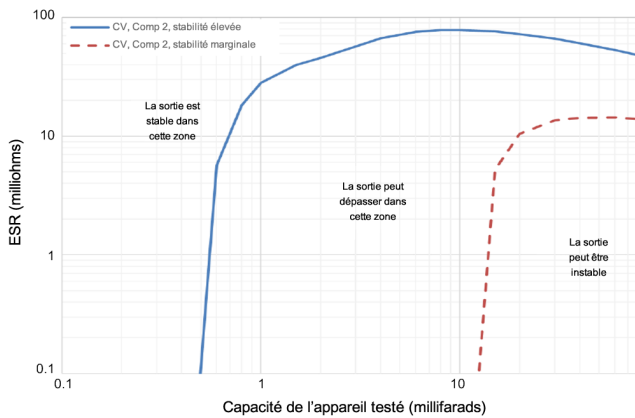

Appareil de 160 V, 10 kW ; comp 2

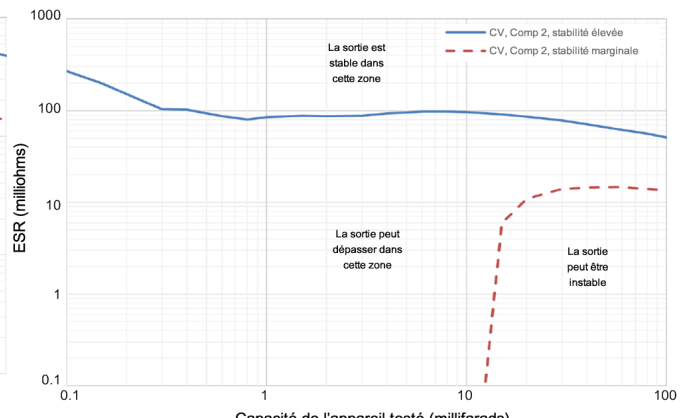

Appareil de 160 V, 10 kW ; comp 2

Réponse de programmation des signaux faibles (tous les modèles)

Les graphiques suivants illustrent les caractéristiques de réponse de programmation de la tension et du courant de sortie. La réponse de la tension s'applique à vide. La réponse du courant s'applique en court-circuit CA lorsque l'appareil testé est une faible impédance fonctionnant au-dessus de 10% de la sortie nominale du RPS, avec moins de 30 cm (1 pied) de fils de charge. Le tableau fournit des détails supplémentaires sur la largeur de bande.

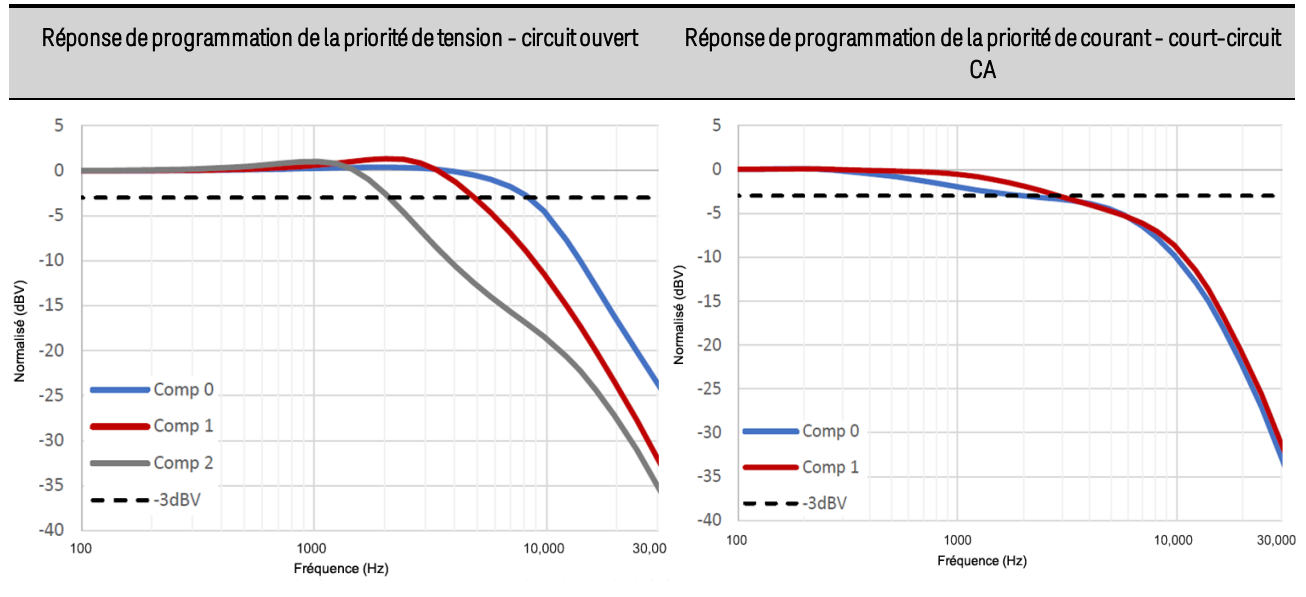

	Fonctionnement	Comp 0 (-1dB)	Comp 0 (-3dB)	Comp 1 (-1dB)	Comp 1 (-3dB)	Comp 2 (-1dB)	Comp 2 (-3dB)
20 V modèles	CV	5,6 kHz	8,3 kHz	3,8 kHz	4,7 kHz	1,6 kHz	2,0 kHz
	CC	550 Hz	2,0 kHz	1,3 kHz	2,7 kHz	S.O.	S.O.
80 V modèles	CV	5,7 kHz	7,5 kHz	5,3 kHz	6,6 kHz	4,9 kHz	5,9 kHz
	CC	1,9 kHz	2,7 kHz	3,1 kHz	3,5 kHz	S.O.	S.O.
160 V modèles	CV	5,5 kHz	7,0 kHz	5,1 kHz	6,2 kHz	4,8 kHz	5,6 kHz
	CC	1,9 kHz	2,5 kHz	3,0 kHz	3,5 kHz	S.O.	S.O.

Précision et résolution de la mesure - avec des intervalles de mesure plus courts

Le tableau suivant illustre les modifications apportées à la précision et la résolution de la mesure à court terme avec divers paramètres de mesure du nombre de cycles de tension d'alimentation (PLC). Les modifications sont dues aux performances de bruit du convertisseur A-D. La ligne de base du tableau est 1 NPLC sans bruit ajouté. Pour déterminer la précision de la mesure à intervalles de pondération plus courts, il suffit de calculer le pourcentage de plage à ajouter, puis de l'ajouter à la valeur de précision fixe dans le tableau des spécifications.

Par exemple, pour déterminer le pourcentage de plage à ajouter à la spécification de précision de la mesure de tension lors de la réalisation de mesures à 0,003 NPLC, multipliez simplement la tension

1 Aide-mémoire

nominale totale par « % de plage ajouté à la valeur spécifiée » comme suit : $20 \text{ V} \times 0,006\% = 1,2 \text{ mV}$. Ajoutez ce nombre à la partie de décalage de la spécification de précision de la mesure : $2 \text{ mV} + 1,2 \text{ mV}$. La nouvelle précision de mesure de la tension est $0,02\% + 3,2 \text{ mV}$ à 0,003 NPLC.

NPLC à 60Hz	Nombre de points moyennés	Mesure de tension	Mesure du courant
		% de plage ajouté à la valeur spécifiée	% de plage ajouté à la valeur spécifiée
1	3255	0	0
0,6	1953	0,0013%	0,0005%
0,1	325	0,0005%	0,004%
0,06	195	0,0009%	0,005%
0,031	100	0,0015%	0,008%
0,010	33	0,0025%	0,015%
0,006	20	0,004%	0,020%
0,003	10	0,006%	0,03%
0,0003	1	0,02%	0,10%

Protection dynamique excessive

Pour les modèles à courant élevé, l'EDP ne limite pas l'amplitude ou la fréquence du signal programmable admissible. Vous pouvez programmer un signal carré à pleine échelle à une fréquence maximale de 97,6 kHz indéfiniment.

Quadrants de sortie

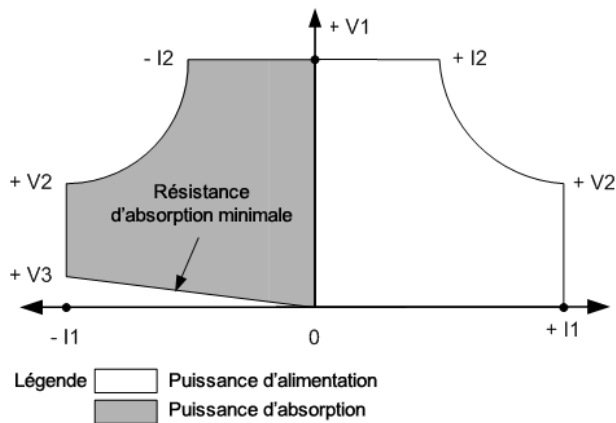

Modèle	+ V1	+ V2	+ V3	+/- I1	+/- I2	Résistance d'absorption minimale
RP7931A/RP7941A	20 V	12,5 V	0,5 V	400 A	250 A	1,25 mΩ
RP7933A/RP7943A	20 V	12,5 V	0,5 V	800 A	500 A	625 μΩ
RP7932A/RP7942A	80 V	40 V	0,75 V	125 A	62,5 A	8 mΩ
RP7935A/RP7945A	80 V	40 V	0,75 V	250 A	125 A	4 mΩ
RP7936A/RP7946A	160 V	80 V	1,5 V	125 A	62,5 A	12 mΩ

Spécifications et caractéristiques - RP795xA, RP796xA

Spécifications - RP795xA, RP796xA

Caractéristiques supplémentaires - RP795xA, RP796xA

Caractéristiques communes

Efficacité de l'entrée CA, facteur de puissance et DHT

Graphiques des impédances de sortie

Limite de charge inductive pour un fonctionnement en courant constant (CC)

Limite de charge capacitive pour un fonctionnement en tension constante (CV)

Réponse de programmation de la tension

Protection dynamique excessive

Quadrants de sortie

Spécifications - RP795xA, RP796xA

Sauf indication contraire, les spécifications sont garanties sur la plage de température ambiante comprise entre 0 et 40 °C après un délai de préchauffage de 30 minutes. Les spécifications s'appliquent aux bornes de sortie, les bornes de mesure étant connectées aux bornes de sortie (mesure locale).

Spécification	RP7951A, RP7961A	RP7952A, RP7962A	RP7953A, RP7963A
Valeurs nominales en courant continu			
Source de tension :	0 à 500 V	0 à 500 V	0 à 950 V
Source et absorption de courant :	0 à ±20 A	0 à ±40 A	0 à ±20 A
Puissance :	0 à ±5 kW	0 à ±10 kW	0 à ±10 kW
Ondulation et bruit de sortie			
Valeur crête à crête en mode CV : ¹	500 mV	500 mV	1000 mV
Valeur efficace en mode CV : ²	100 mV	100 mV	200 mV
Régulation de charge			
Tension :	30 mV	30 mV	60 mV
Courant :	9 mA	17 mA	9 mA
Précision de programmation de la tension : ³			
	0,03% + 60 mV	0,03% + 60 mV	0,03% + 120 mV
Précision des mesures de tension : ³			
	0,03% + 80 mV	0,03% + 80 mV	0,03% + 160 mV
Précision de programmation et de mesure du courant : ³			
	0,1% + 12 mA	0,1% + 24 mA	0,1% + 12 mA
Réponse transitoire ⁴			
Temps de récupération :	500 µs	500 µs	500 µs
Bande de stabilisation :	1,25 V	1,25 V	2,375 V

¹ De 20 Hz à 20 MHz (bande passante de -3dB) avec charge résistive, bornes non raccordées à la masse ou bornes raccordées à la masse

² De 20 Hz à 10 MHz (bande passante de -3dB) avec charge résistive, bornes non raccordées à la masse ou bornes raccordées à la masse

³ Pourcentage de valeur + décalage à 25°C ±5 °C après un délai de préchauffage de 30 minutes ; NPLC de mesure = 1 ; valide pendant 1 an. Voir

Intervalle d'étalonnage

avec une chute de tension des fils de charge pouvant atteindre 1 V par fil - reportez-vous à la section **Taille des fils** pour des informations

complémentaires sur la chute de tension des fils de charge

⁴ Temps nécessaire pour revenir à la bande de stabilisation après une variation de palier de 50 à 100 % de la charge totale à la vitesse de balayage maximale

Caractéristiques supplémentaires - RP795xA, RP796xA

Les caractéristiques supplémentaires ne sont pas garanties, mais décrivent les performances déterminées par définition ou par test type. Les caractéristiques supplémentaires sont standard, sauf indication contraire.

Caractéristique	RP7951A, RP7961A	RP7952A, RP7962A	RP7953A, RP7963A
Ondulation et bruit de sortie Valeur efficace en mode CC :	100 mA	200 mA	100 mA
Plage de programmation de la tension :	0,5 à 510 V	0,5 à 510 V	1,0 à 969 V
Résolution :	10,5 mV	10,5 mV	21 mV
Résolution Plage :	-20,5 A à 20,5 A	-41 A à 41 A	-20,5 A à 20,5 A
Résolution :	190 μ A	380 μ A	190 μ A
Programmation de la résistance Plage :	0 à 25 Ω	0 à 12,5 Ω	0 à 50 Ω
Résolution :	140 $\mu\Omega$	70 $\mu\Omega$	280 $\mu\Omega$
Précision :	0,08 % + 200 $\mu\Omega$	0,08 % + 110 $\mu\Omega$	0,08 % + 280 $\mu\Omega$
Programmation V supplémentaire décalée par rapport à la programmation de la résistance activée :	+157 mV +(0,36 Ω x A)	+157 mV +(0,36 Ω x A)	+313 mV +(0,72 Ω x A)
Décalage de la programmation en V supplémentaire / Ohm :	175 mV	175 mV	350 mV
Vitesse de programmation de la tension (Comp 0) ^{1,2} Temps de montée/descente de 10 % à 90 % du palier :	1 ms 6 ms	1 ms 6 ms	1 ms 6 ms
Temps d'établissement à 0,1% du palier :			
Vitesse de programmation de la tension (Comp 1) ^{1,2} Temps de montée/descente de 10 % à 90 % du palier :	15 ms 50 ms	15 ms 50 ms	15 ms 50 ms
Temps d'établissement à 0,1% du palier :			
Vitesse de programmation du courant ¹ Temps de montée de 10 % à 90 % du palier :	2 ms	2 ms	2 ms
Vitesse de balayage maximale Tension :	200 kV/s	200 kV/s	400 kV/s
Courant :	1,6 kA/s	3,2 kA/s	1,6 kA/s
Bande passante de programmation de signal faible Tension à 3 dB à vide :	500 Hz	500 Hz	500 Hz
Courant avec sortie court-circuitée :	40 Hz	40 Hz	40 Hz
Régulation de secteur Tension :	< 10 mV	< 10 mV	< 20 mV
Courant :	< 290 μ A	< 580 μ A	< 290 μ A
Charges réactives Capacité par défaut/faible :	80 μ F/800 μ F	160 μ F/1600 μ F	40 μ F/400 μ F
Inductance : ³	5 μ H	5 μ H	5 μ H

¹ Programmation amont avec une charge résistive complète et une variation de palier comprise entre 0,1% et 100% de la valeur de sortie nominale

² Programmation aval avec une charge nulle et une variation de palier comprise entre 100% et 0,1% de la valeur de sortie nominale

³ Équivalent à 3 m (10 pieds) de fils de charge

Caractéristiques communes

Caractéristique commune	Tous les modèles
Temps de traitement des commandes	≤ 1 ms entre la réception de la commande et le début du changement de la sortie. S'applique aux commandes de paramètres simples sur l'interface GPIB (voir Temps de traitement de commande type)
Signaux arbitraires à palier constant	Jusqu'à 65 535
Nombre de points :	Un paramètre de temporisation s'applique à l'ARB entier, de 10,24 µs à 0,30 seconde
Plage de temporisation :	Les valeurs sont arrondies à l'incrément de 10,24 microsecondes le plus proche
Résolution de temporisation :	
Interfaces informatiques	
LXI :	Spécification de l'appareil LXI 1.5 2016
LAN :	LAN 10 Mo, 100 Mo, 1 Go
USB :	USB 2.0 (protocole USB-TMC488)
GPIB :	Interface conforme SCPI - 1993, IEEE 488.2
Conditions environnementales	
Conditions de fonctionnement :	Utilisation interne, catégorie d'installation II (pour l'entrée secteur), degré de pollution 2 0 à 55 °C (le courant continu maximal est déclassé à 1 % de la puissance nominale par degré C)
Plage de températures :	entre 40 et 55 °C 95% au maximum (sans condensation)
Humidité relative :	Jusqu'à 2 000 mètres
Altitude :	-30 à 70°C
Température de stockage :	
Déclaration acoustique (Directive européenne relative aux machines)	Émission de bruit acoustique LpA 79 dB à l'emplacement de l'utilisateur LpA 73 dB à proximité LpA 61,4 à la vitesse du ventilateur inactif Mode de fonctionnement normal conforme à la norme ISO 7779

Caractéristique commune	Tous les modèles
Port numérique	
Tension nominale max. :	+16,5 V CC/- 5 V CC entre les broches
Broches 1 et 2 en tant que sortie de défaillance :	Tension de sortie de niveau faible maximale = 0,5 V à 4 mA Courant absorbé de niveau faible maximal = 4 mA Courant de fuite de niveau élevé type = 1 mA à 16,5 V CC
Broches 1-7 en tant que sorties :	Tension de sortie de niveau faible maximale = 0,5 V à 4 mA ; 1 V à 50 mA ; 1,75 V à 100 mA Courant absorbé de niveau faible maximal = 100 mA Courant de fuite de niveau élevé type = 0,8 mA à 16,5 V CC
Broches 1-7 en tant qu'entrées :	Tension d'entrée de niveau faible maximale = 0,8 V Tension d'entrée de niveau élevé minimale = 2 V Courant de niveau faible type = 2 mA à 0 V (résistance interne 2,2 k) Courant de fuite de niveau élevé type = 0,12 mA à 16,5 V CC
Broche 8 :	La broche 8 est commune (connectée en interne à la masse du châssis)
Conformité réglementaire	
CEM :	Conforme à la directive CEM relative aux produits de test et de mesure. Conforme à la norme Australienne et porte la marque C-Tick. This ISM device complies with Canadian ICES-001. Cet appareil ISM est conforme à la norme NMB-001 du Canada.
Sécurité :	Conforme à la directive basse tension européenne et porte la marque CE. Conforme aux réglementations de sécurité américaines et canadiennes.
	Vous pouvez télécharger sur Internet les déclarations de conformité concernant ce produit. Accédez à la page http://www.keysight.com/go/conformity et cliquez sur Déclarations de conformité.
Entrée secteur	
Phase et plage :	Triphasé ; 200 V CA nominal $\pm 10\%$, et 208 V CA nominal $\pm 10\%$ Triphasé ; 400 V CA nominal $\pm 15\%$, et 480 V CA nominal $\pm 10\%$
Fréquence :	50/60 Hz
VA en entrée :	RP7951A, RP7961A : 6,5 kVA RP7952A, RP7962A, RP7953A, RP7963A : 11,5 kVA
Courant d'entrée par phase	
Entrée 200 V CA :	RP7951A : 17,3 A ; RP7952A, RP7953A : 35 A
Entrée 400 V CA :	RP7961A : 8,66 A ; RP7962A, RP7963A : 17,3 A
Efficacité à pleine puissance :	RP7951A, RP7952A, RP7953A : 86,3% RP7961A, RP7962A, RP7963A : 91,5%
Facteur de puissance :	0,99 @ entrée nominale et puissance nominale
	REMARQUE Au cours d'une coupure de ligne sur 1 cycle, l'appareil peut redémarrer. La sortie restera désactivée après le redémarrage jusqu'à ce que l'opérateur rétablisse les réglages précédents, soit grâce aux commandes du panneau avant, soit en utilisant un programme informatique. Ce comportement est conforme aux procédures d'exploitation sécuritaires.
Isolation des bornes de sortie :	Aucune borne de sortie ne doit être soumise à une tension de plus de 950 V CC par rapport à une autre borne ou à la masse du châssis.
Poids type	RP7951A, RP7961A : 60 livres. (27,3 kg) RP7952A, RP7962A, RP7953A, RP7963A : 70 livres. (31,8 kg)
Dimensions	Hauteur 3U ; largeur de baie complète (voir Schémas de principe pour plus de détails)

Efficacité de l'entrée CA, facteur de puissance et DHT

Les graphiques suivants fournissent des détails supplémentaires sur l'efficacité de l'entrée CA, le facteur de puissance et la distorsion harmonique totale sur toute la gamme de puissance de l'instrument. Notez que les tensions de ligne haute sont respectivement de 208 et de 480 V CA. Les tensions de ligne basse sont respectivement de 200 V CA et de 400 V CA.

Efficacité de la source/de l'absorption RP7951A (200 V/208 V)

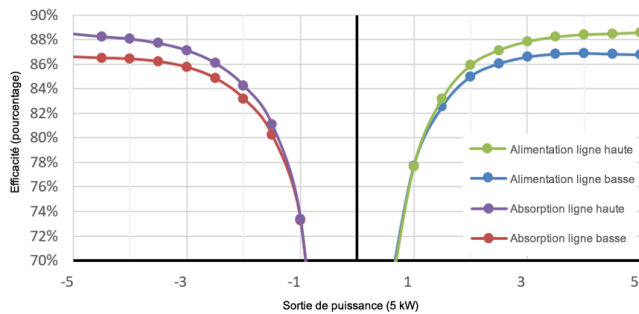

Facteur de puissance RP7951A (200 V/208 V)

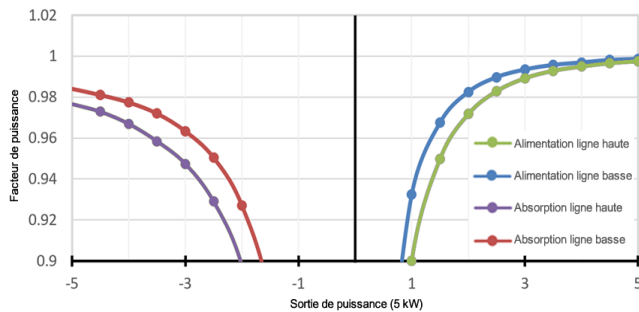

Distorsion harmonique totale RP7951A (200 V/208 V)

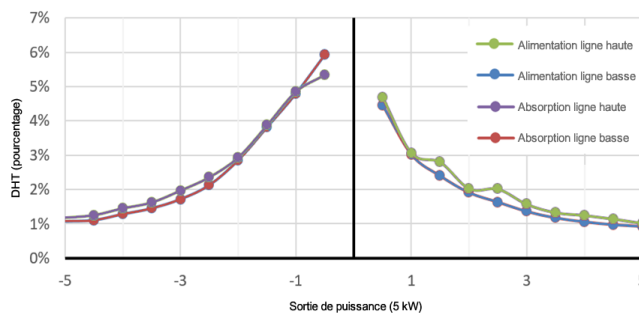

1 Aide-mémoire

Efficacité de la source/de l'absorption RP7952A (200 V/208 V)

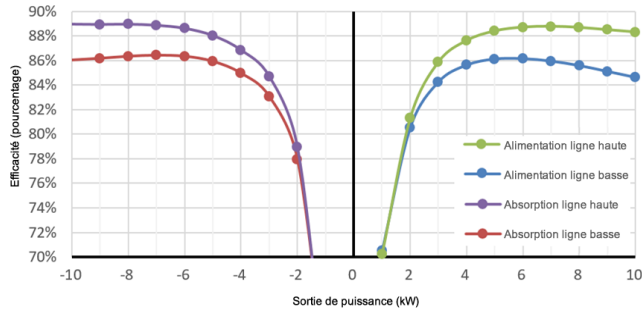

Efficacité de la source/de l'absorption RP7962A (380 V/480 V)

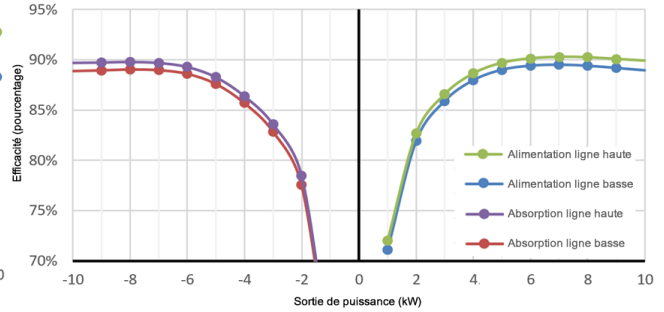

Efficacité de la source/de l'absorption RP7953A (200 V/208 V)

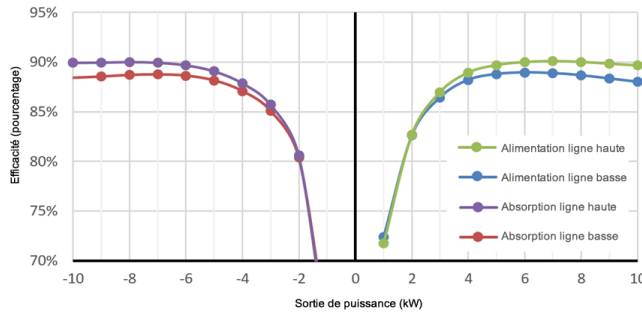

Efficacité de la source/de l'absorption RP7963A (380 V/480 V)

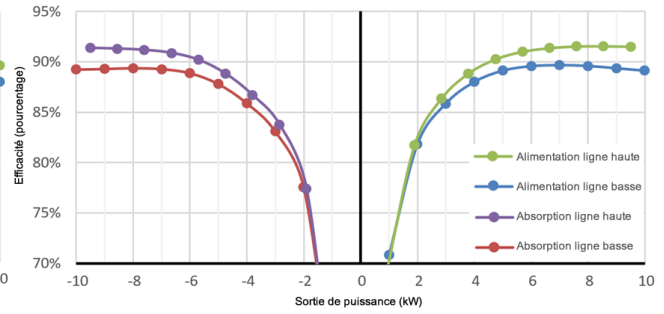

Facteur de puissance RP7952A, RP7953A (200 V/208 V)

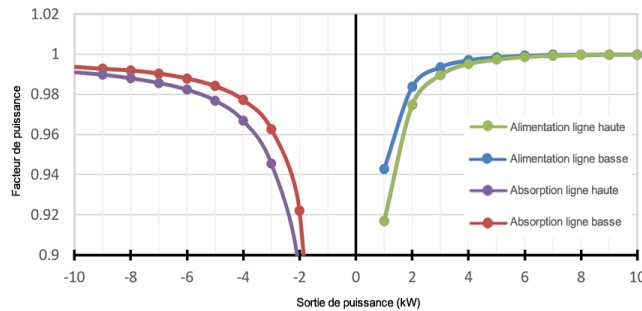

Facteur de puissance RP7962A, RP7963A (380 V/480 V)

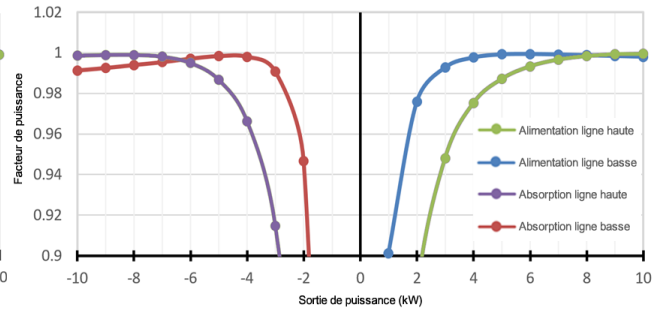

Distorsion harmonique totale RP7952A, RP7953A (200 V/208 V)

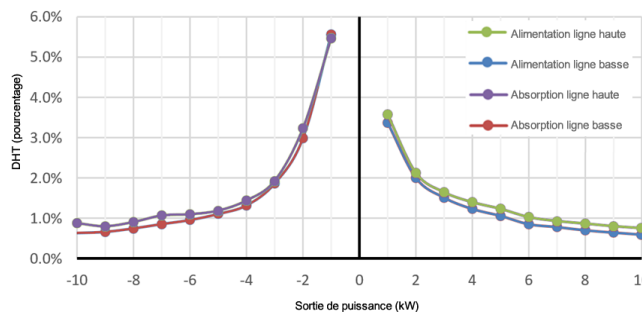

Distorsion harmonique totale RP7962A, RP7963A (380 V/480 V)

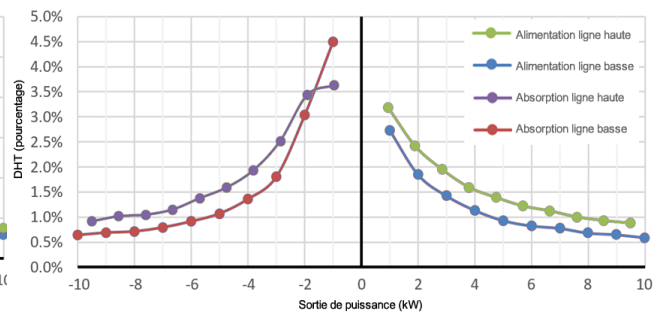

REMARQUE

Si vous utilisez des listes ou des signaux arbitraires pour générer des sinusoïdes proches de la fréquence du réseau, des courants de distorsion supplémentaires se produisent dans la ligne. Reportez-vous à la section **Limitation des sorties sinusoïdales**.

Graphiques des impédances de sortie

Tous les graphiques d'impédance de priorité de tension sont en mode de bande passante élevée. Il n'y a que des différences mineures à basses fréquences sur les graphiques en mode de bande passante faible. Le **paramètre de bande passante** n'a aucun effet en mode de fonctionnement CC.

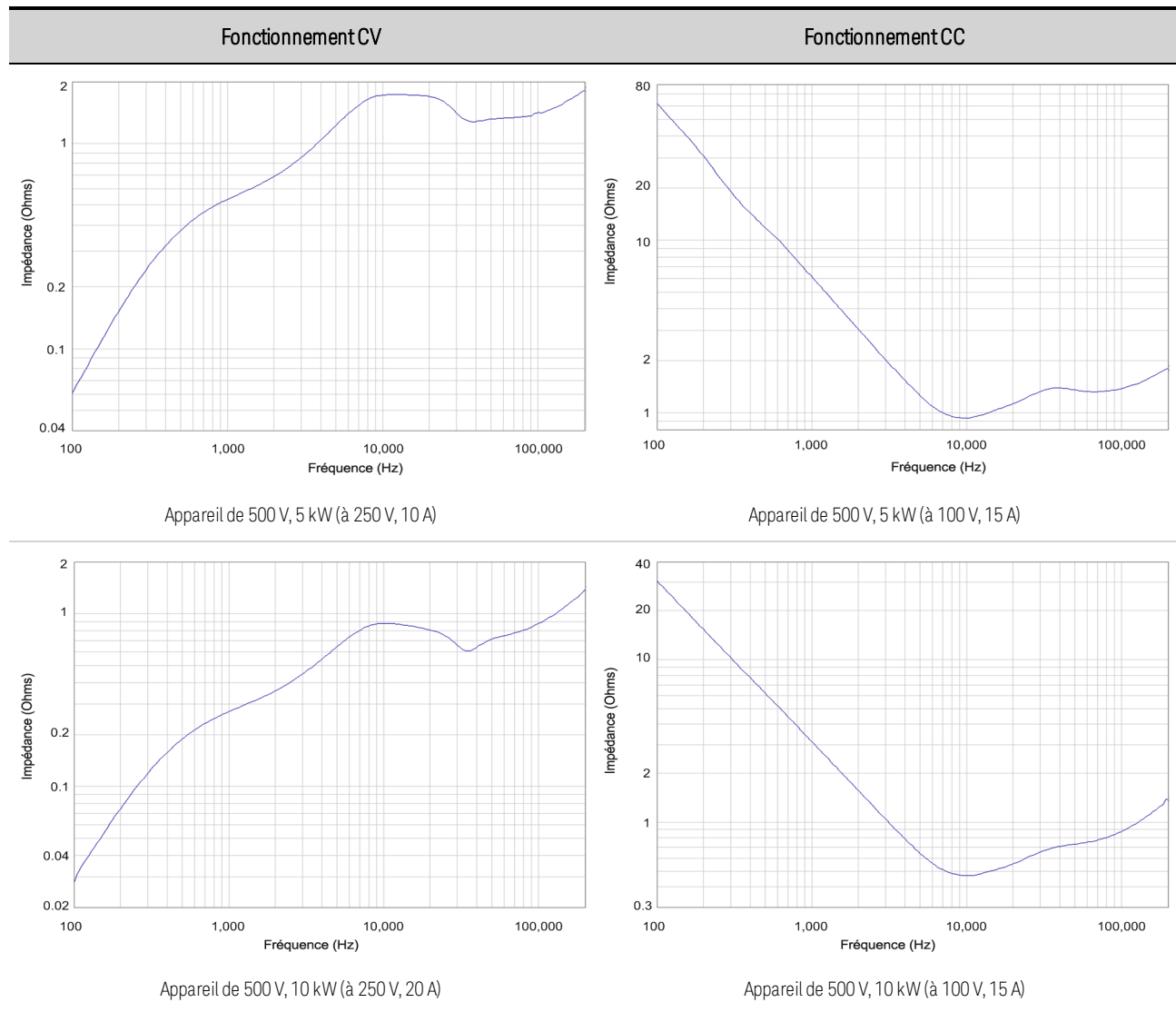

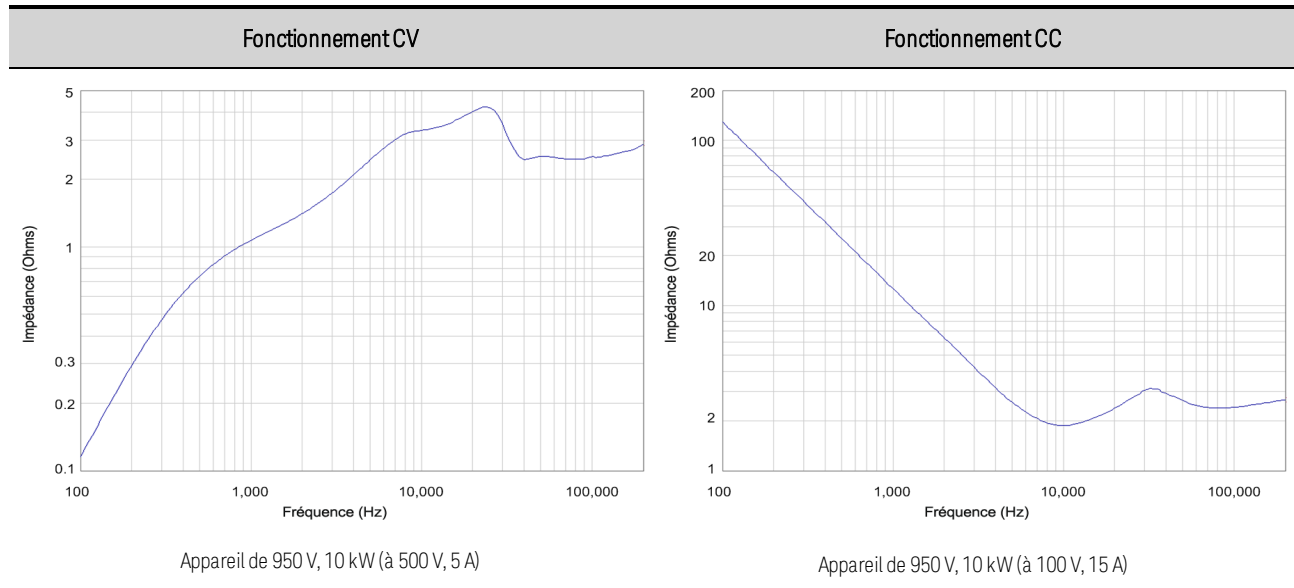

Limite de charge inductive pour un fonctionnement en courant constant (CC)

ATTENTION

DOMMAGES MATÉRIELS Vous devez protéger les relais de sortie statiques contre les dommages dues à une inductance de charge supérieure à $12,5 \mu\text{H}$ ou des fils de charge torsadés de plus de 15 mètres (chacun). Vous pouvez augmenter cette longueur en mettant en parallèle des fils de charge torsadés supplémentaires. Pour réduire la tension di/dt et la tension obtenue sur les relais, vérifiez que le courant de sortie a été ramené à zéro avant de mettre la sortie hors tension.

Les figures suivantes montrent les limites maximales des charges inductives (L) avec la résistance en série (R_s) pour un fonctionnement à courant constant. Tout fonctionnement en dessous de la ligne de stabilité marginale peut entraîner une instabilité de la sortie. Notez qu'une résistance de charge accrue permet d'augmenter l'inductance de sortie.

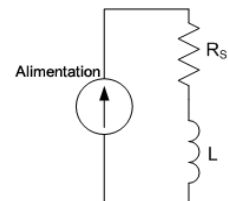

Appareils de 500 V

Appareils de 950 V

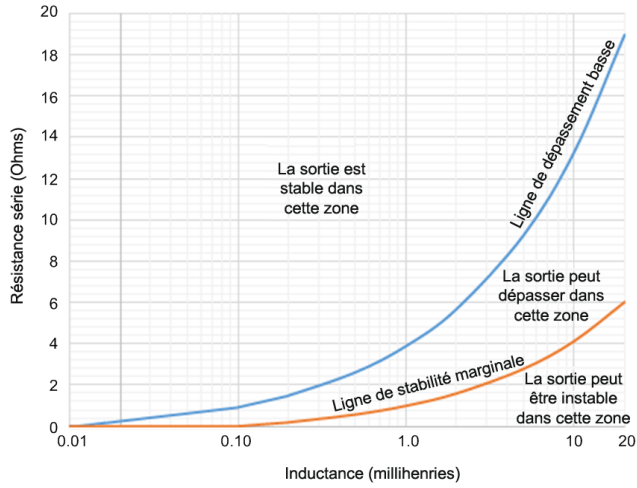

Appareil de 500 V, 10 kW

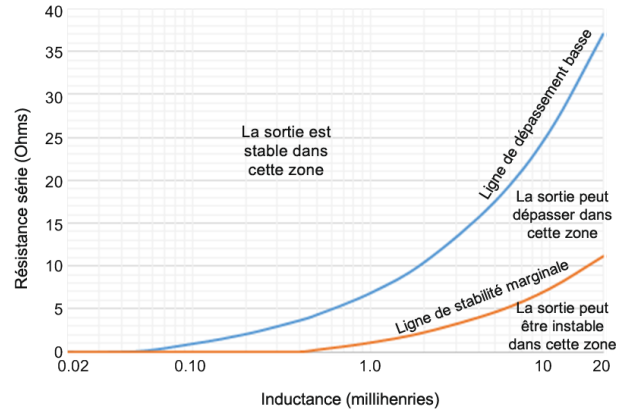

Appareil de 950 V, 10 kW

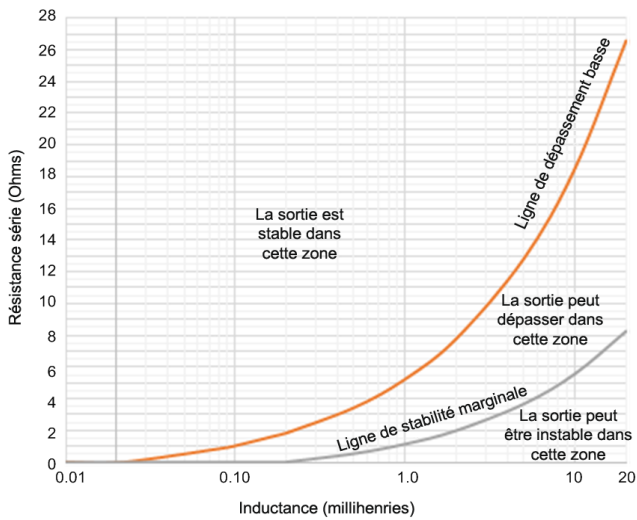

Appareil de 500 V, 5 kW

Limite de charge capacitive pour un fonctionnement en tension constante (CV)

Les figures suivantes indiquent les limites maximales des charges capacitives avec une résistance série équivalente pour un fonctionnement à courant constant. Le fonctionnement *en dessous* des deux lignes de stabilité marginales lorsque vous utilisez le **paramètre de bande passante** élevée ou faible peut entraîner une instabilité de la sortie.

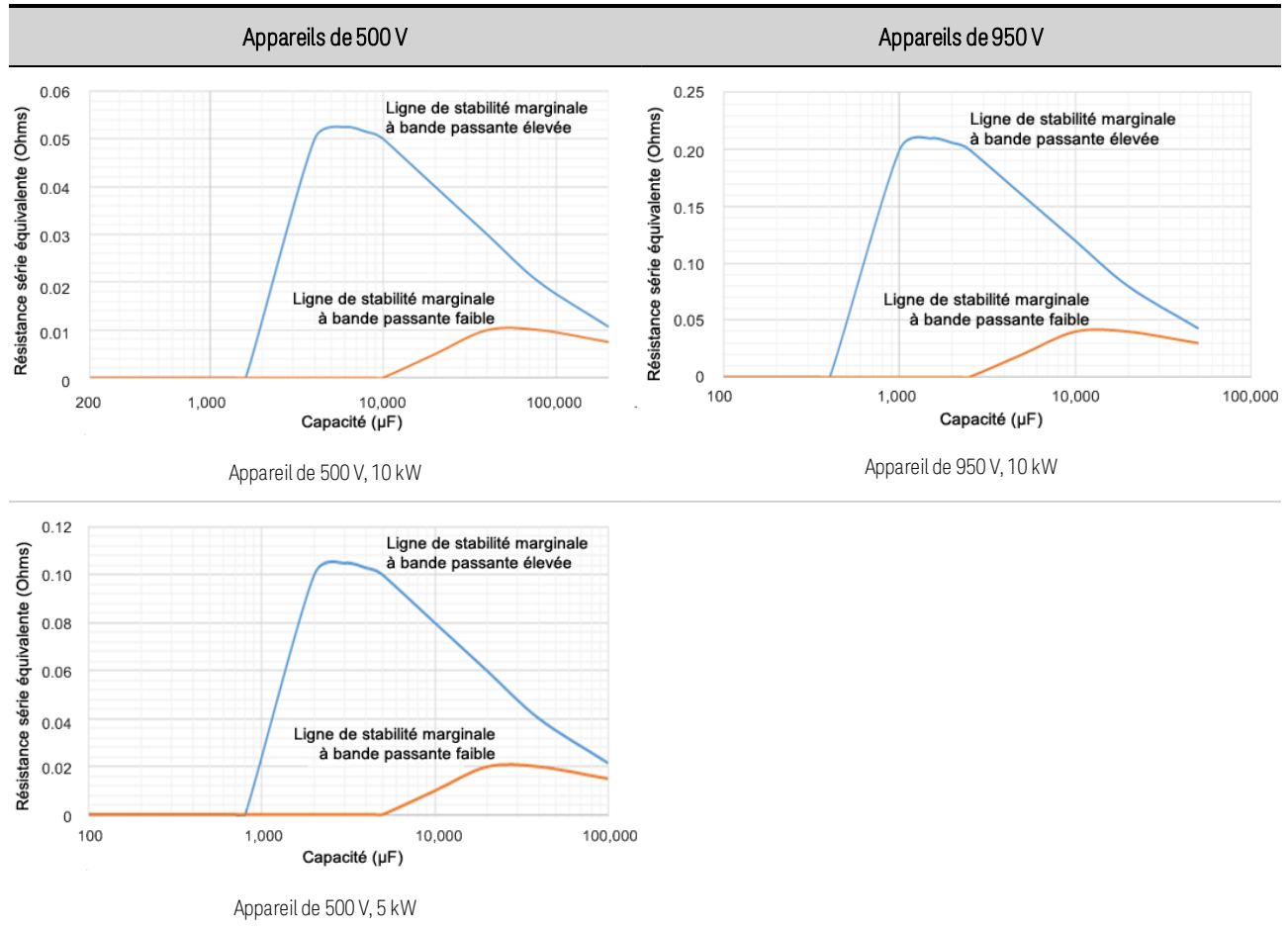

Réponse de programmation de la tension (Tous les modèles)

La représentation graphique illustre les caractéristiques de réponse de programmation de la tension de sortie. Cela s'applique uniquement à de petits signaux, dans des conditions à vide.

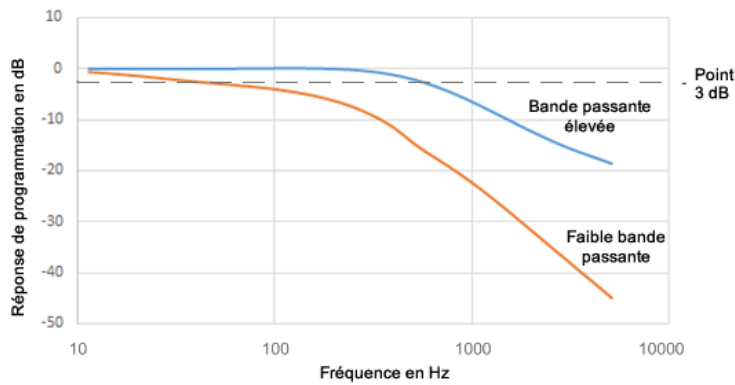

Protection dynamique excessive

La représentation graphique suivante compare les seuils d'amplitude du signal carré à la fréquence sans charge. Dans la zone *au-delà* du seuil d'amplitude indiqué, la génération soutenue d'un signal carré peut activer la fonction de protection contre les dynamiques excessives (EDP), qui désactive la sortie. La protection EDP peut être activée par des changements de tension programmés, des listes, des signaux arbitraires ou des fluctuations de tension induites par une charge.

Tension programmable crête à crête maximale
par rapport à la fréquence à signal carré

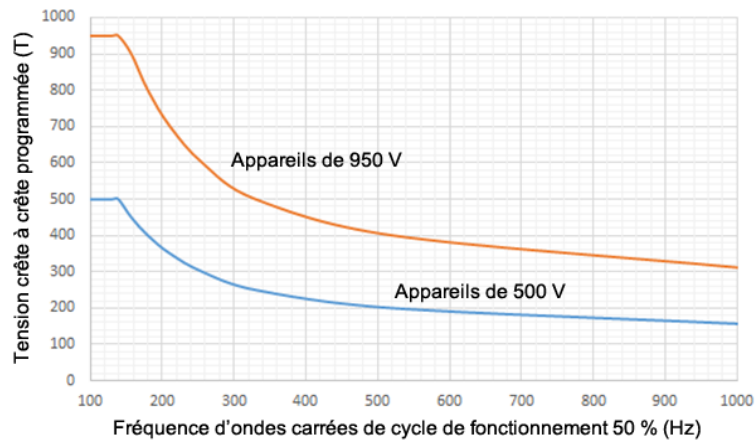

Quadrants de sortie

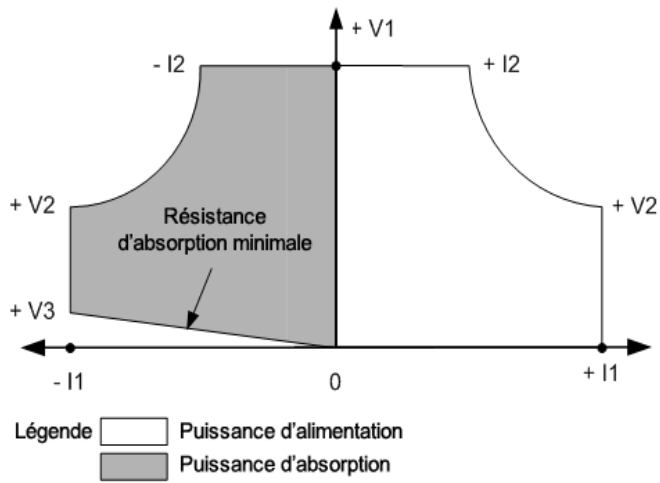

Modèle	+V1	+V2	+V3	+/- I1	+/- I2	Résistance d'absorption minimale
RP7951A/RP7961A	500 V	250 V	8 V	20 A	10 A	0,4 Ω
RP7952A/RP7962A	500 V	250 V	8 V	40 A	20 A	0,2 Ω
RP7953A/RP7963A	950 V	500 V	16 V	20 A	10,5 A	0,8 Ω

2

Installation de l'instrument

Avant l'installation ou l'utilisation

Montage en baie

Connexions de l'alimentation secteur

Connexions de sortie d'un appareil unique

Connexions de sortie de plusieurs appareils

Connexions de l'interface

AVERTISSEMENT

Poids élevé.

Danger relatif aux mains et aux pieds. Afin d'éviter toute blessure ou dommage à l'instrument, utilisez toujours un chariot solide ou tout autre appareil adéquat pour déplacer l'instrument. Ne soulevez jamais l'instrument seul(e) ; veillez à toujours être au moins deux personnes pour soulever l'instrument.



Avant l'installation ou l'utilisation

Inspection de l'appareil

Dès réception de votre système RPS, recherchez tout signe d'endommagement apparent qui aurait pu se produire pendant le transport. Si vous en constatez la présence, faites les réserves d'usage auprès du transporteur et prévenez immédiatement le bureau commercial et d'assistance Keysight le plus proche. Rendez-vous sur www.keysight.com/find/assist. Tant que vous n'avez pas vérifié l'appareil, conservez son conteneur d'expédition et les matériaux d'emballage : ceux-ci vous serviront au cas où il devrait être retourné.

Vérification des composants livrés

Avant de commencer, vérifiez la liste suivante et la bonne réception des éléments suivants. Si un composant est manquant, contactez votre bureau commercial et d'assistance Keysight le plus proche.

Éléments RP7900A	Description	Numéro de référence
Câble de mesure à distance pour RP795xA. RP796xA (installé)	Câble haute tension avec connecteur à 2 broches pour mesure + et -	Keysight 5188-9516 Prise uniquement : Phoenix Contact 1714278
Câble de mesure à distance pour RP793xA. RP794xA (installé)	Câble de mesure avec connecteur à 2 broches pour mesure + et -	Keysight 5190-4501 Prise uniquement : Phoenix Contact 1952267
Prise de connecteur numérique ^{1,2}	Connecteur 8 broches pour le port numérique	Keysight 1253-6408 ; Phoenix Contact 1840421
Câble principal/secondaire ^{1,2}	Câble de 1 m (CAT6A) pour communication principale/secondaire	Keysight 8121-2314
Capot de sécurité d'entrée avec bague ^{1,2}	Capot de sécurité pour entrée CA avec bague serre-câble	Capot uniquement : Keysight 5066-1925 Bague uniquement : Keysight 1410-1901
Capot de sécurité de sortie ^{1,2}	Capot de sécurité pour les barres conductrices de sortie à haute tension Capot de sécurité pour les barres conductrices de sortie à courant élevé	Keysight 5066-1927 Keysight 5188-9544
Câble de connecteur de partage ¹	Câble haute tension avec connecteurs à 3 broches pour port de partage	Keysight 5188-9517 Prise uniquement : Keysight 0360-3038 ; Phoenix Contact 1840379
Capot de sécurité de contrôle ¹	Capot de sécurité pour câble de partage de courant	Keysight 5066-1926
Noyau de ferrite ¹	Noyau de ferrite installé sur le câble de partage de courant	Keysight 9170-2573
Capot contre les décharges électrostatiques avec bride ^{1,2}	Capot contre les décharges électrostatiques pour connexions d'interface à distance	Keysight 5003-2364 - capot Keysight 0515-1946 - vis

Kits matériels RP795xA. RP796xA RP793xA. RP794xA	Écrous et boulons pour barres conductrices + et - à haute tension Écrous et boulons pour barres conductrices + et - à courant élevé	Keysight 5067-6031 Keysight 5066-1936
Noyau de ferrite pour cordon d'alimentation	Pour les modèles RP7961A, RP7962A, RP7963A antérieurs	Keysight 9170-2578
Certificat d'étalonnage	Certificat d'étalonnage renvoyant au numéro de série	Aucun

¹ Les éléments sont inclus dans le modèle RP795xA. Kit du capot RP796xA, réf. 5066-1930.

² Les éléments sont inclus dans le modèle RP793xA. Kit du capot RP794xA, réf. 5066-1935.

Éléments SD1000A	Description	Numéro de référence
Câble d'alimentation de sortie	Câble permettant de connecter la sortie RP7900A à l'entrée SD1000A	Keysight 5188-2407
Kit matériel	Écrous et boulons pour connexions de barre conductrice + et -	Keysight 5067-6031
Câble d'interface	Câble de 1 m (CAT6A) pour interface avec les appareils RP7900A	Keysight 8121-2314

Examen des informations de sécurité

Ce système d'alimentation est un appareil de catégorie de sécurité 1. Il possède une borne de terre de protection. Celle-ci doit être reliée à la terre via une prise d'alimentation secteur munie d'une borne de terre. Pour obtenir des informations générales sur la sécurité, reportez-vous à la section **Consignes de sécurité**. Avant d'installer ou d'utiliser cet appareil, vérifiez l'alimentation et passez en revue les avertissements et consignes de sécurité rencontrés tout au long de ce guide. Les avertissements de sécurité propres aux procédures spécifiques se situent aux endroits appropriés tout au long de ce document.

AVERTISSEMENT

RISQUE D'ÉLECTROCUTION, TENSION LÉTALES De nombreux modèles génèrent des tensions supérieures à 60 V CC, certains modèles ayant une tension nominale de 950 V CC ! Assurez-vous que toutes les connexions des instruments, le câblage de charge et les connexions de charge sont isolés ou recouverts à l'aide des capots de sécurité fournis, de sorte qu'aucun contact accidentel avec des tensions létales ne peut se produire.

Observation des conditions environnementales

AVERTISSEMENT

N'utilisez pas l'instrument en présence de gaz ou de vapeurs inflammables.

Les conditions environnementales de l'alimentation électrique sont décrites sous les caractéristiques communes de **RP793xA-RP794xA** et de **RP795xA-RP796xA**. En règle générale, l'appareil doit être uniquement utilisé dans des locaux abrités, dans un environnement contrôlé. N'utilisez pas l'appareil

2 Installation de l'instrument

dans des espaces où la température ambiante est supérieure à +55 degrés Celsius. Cela concerne le montage en baie, ainsi que l'utilisation en paillasse.

Circulation d'air adéquate

ATTENTION N'obstruez pas l'entrée de ventilation à l'avant de l'instrument ou la sortie à l'arrière.

Les dimensions de votre bloc d'alimentation ainsi qu'un schéma de principe sont fournis dans la section **Schéma de principe**. Des ventilateurs refroidissent l'appareil en aspirant de l'air à l'avant et en le rejetant à l'arrière. L'appareil doit être installé à un emplacement prévoyant un espace suffisant d'au moins 30,5 cm (12 pouces) à l'avant et à l'arrière afin d'assurer une ventilation adéquate.

Empilage des instruments

ATTENTION N'empilez jamais plus de trois instruments les uns sur les autres dans une installation autonome.

Schéma de principe pour : RP793xA et RP794xA



Schéma de principe pour : RP795xA et RP796xA



Montage en baie

Cette section contient des informations sur l'installation d'un kit de montage en baie RP7909A. Le kit de montage en baie permet de monter les appareils RPS dans une armoire de baie EIA de 19 pouces.

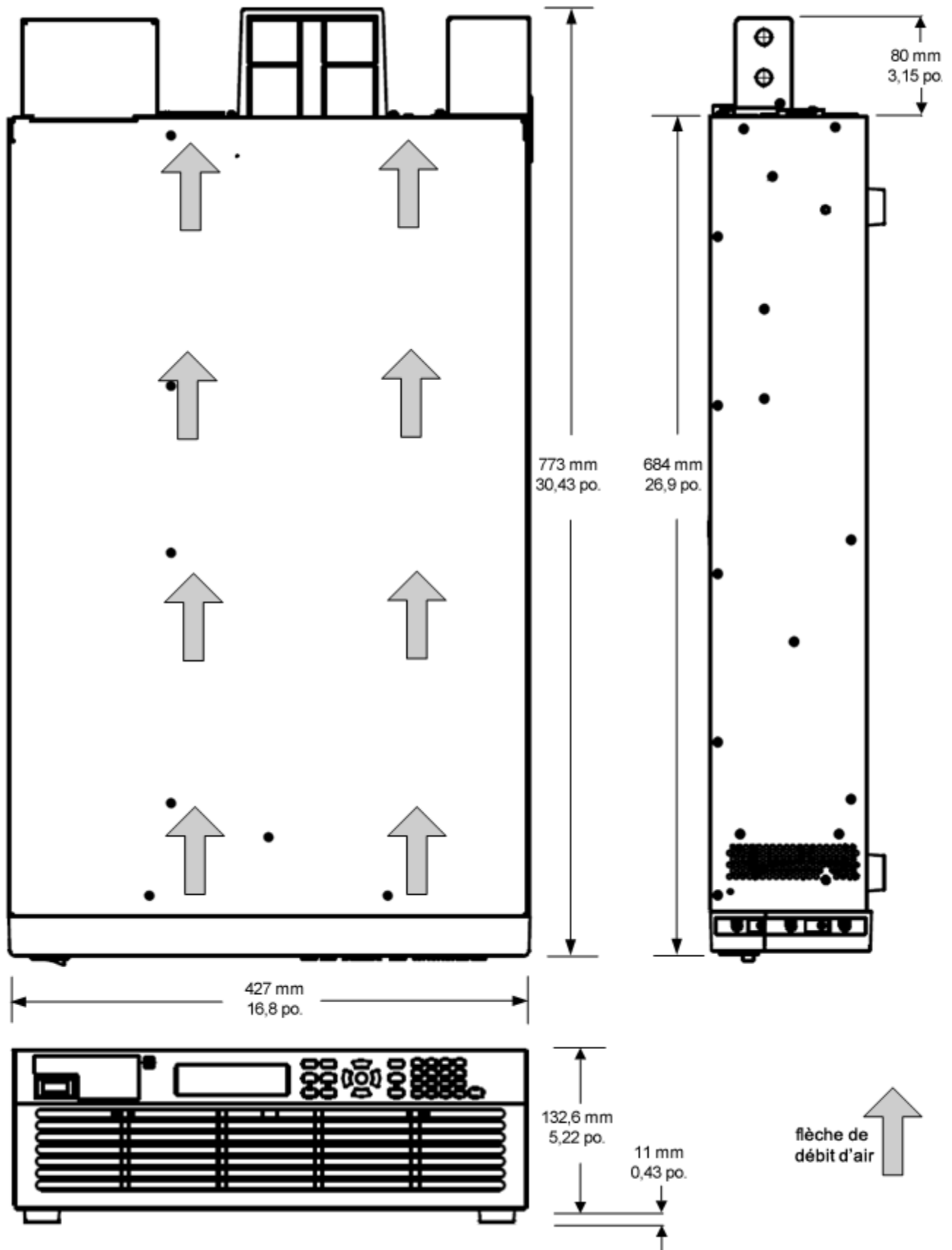
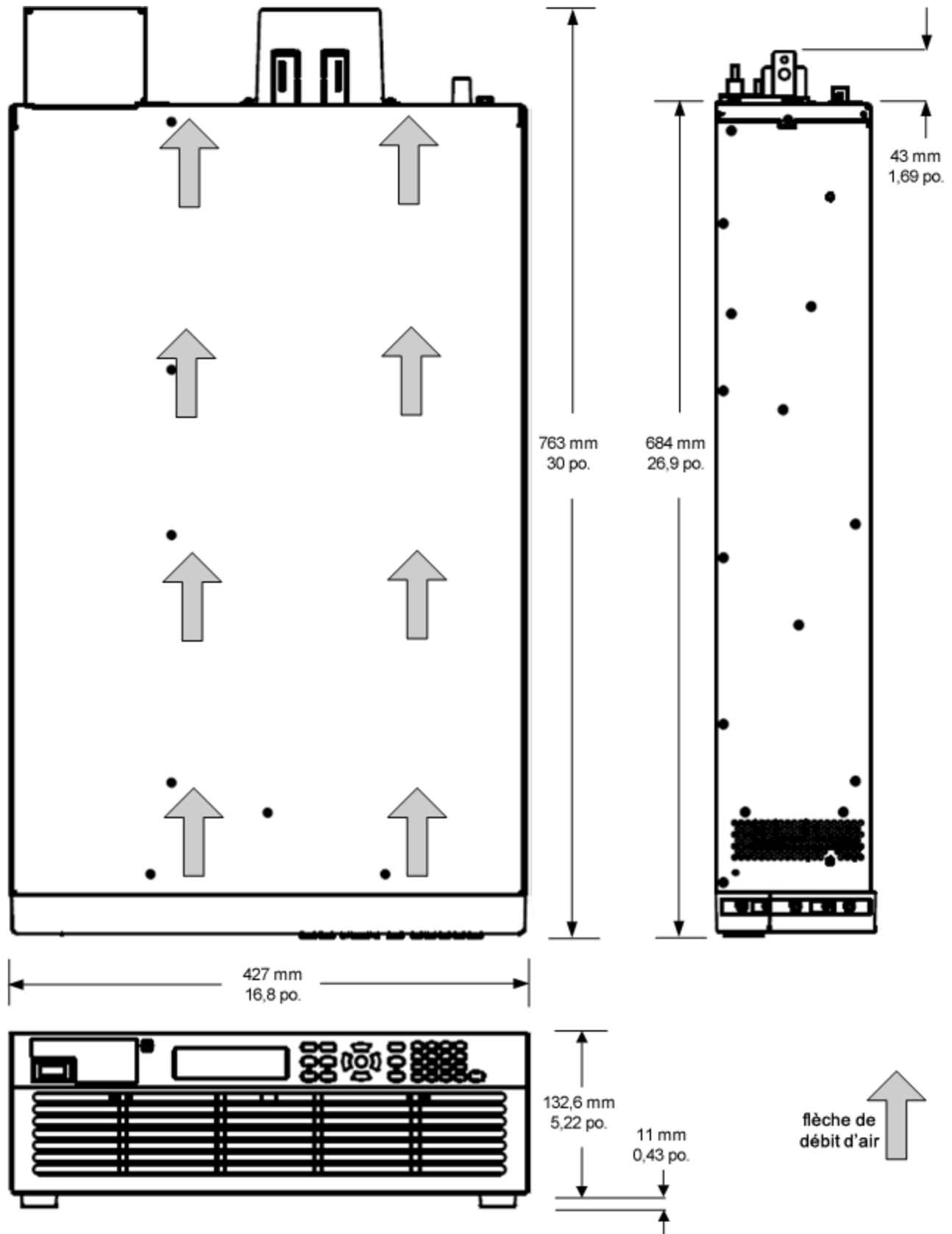
Avant de commencer, vérifiez la liste suivante et la bonne réception des éléments suivants. Si un composant est manquant, contactez votre bureau commercial et d'assistance Keysight le plus proche.

Contenu du kit de montage en baie	Référence Keysight
Glissières, 2 paires (matériel de fixation inclus)	5003-1128
Le kit de brides pour baie sans poignées comprend :	5067-6705
Brides de montage, qté 2	5022-9638
Vis de fixation de bride, qté 6 (M4x0,7 10 mm)	0515-1114
Vis à tête avant, qté 4 (10-32 x 0,625)	3030-1768
Écrous à clip en métal, qté 4 (10-32 x 0,5)	0590-0804

Installation de l'instrument

ATTENTION

Les alimentations de la série RP7900A Keysight pèsent jusqu'à 70 lbs. (31,8 kg). Il faut deux personnes pour l'installation. Ne soulevez ou ne déplacez pas l'appareil seul. Évitez de déplacer l'appareil à la main. Si cela est inévitable, soulevez uniquement le châssis de l'appareil ; ne soulevez pas l'appareil par les bornes de sortie.

N'obstruez pas l'entrée de ventilation à l'avant de l'instrument ou la sortie à l'arrière.

Outils nécessaires : Tournevis cruciforme, tournevis T22 Torx, tournevis T10 Torx.

1. Retirez les quatre pieds du dessous de l'instrument.
2. Installez la bride du capot contre les décharges électrostatiques sur le côté de l'instrument à l'aide des deux vis fournies. La bride et les vis (0515-1946) sont fournies dans le kit du capot (5066-1930) qui est livré avec l'instrument.
3. Installez les glissières 5003-1128. Reportez-vous aux instructions des glissières.
 - a. Posez la partie amovible de chaque glissière sur les côtés de l'instrument à l'aide des quatre vis fournies (0515-1013).
 - b. Installez quatre écrous à clip sur le cadre de l'armoire de baie où vous installez l'instrument. Installez un écrou à clip à chaque angle (0590-0804).
 - c. Posez la partie fixe de chaque glissière sur les côtés du cadre de l'armoire de baie à l'aide des quatre vis fournies (2680-0104).

2 Installation de l'instrument

4. Installez les deux brides sur les coins du panneau avant de l'instrument à l'aide des six vis fournies (0515-1114).
5. Installez quatre écrous à clip à l'avant du cadre de l'armoire de baie pour fixer le panneau avant (0590-0804).
6. Faites glisser l'instrument dans la baie.
7. Fixez le panneau avant à l'instrument sur l'armoire de baie à l'aide des quatre vis fournies (3030-1768).

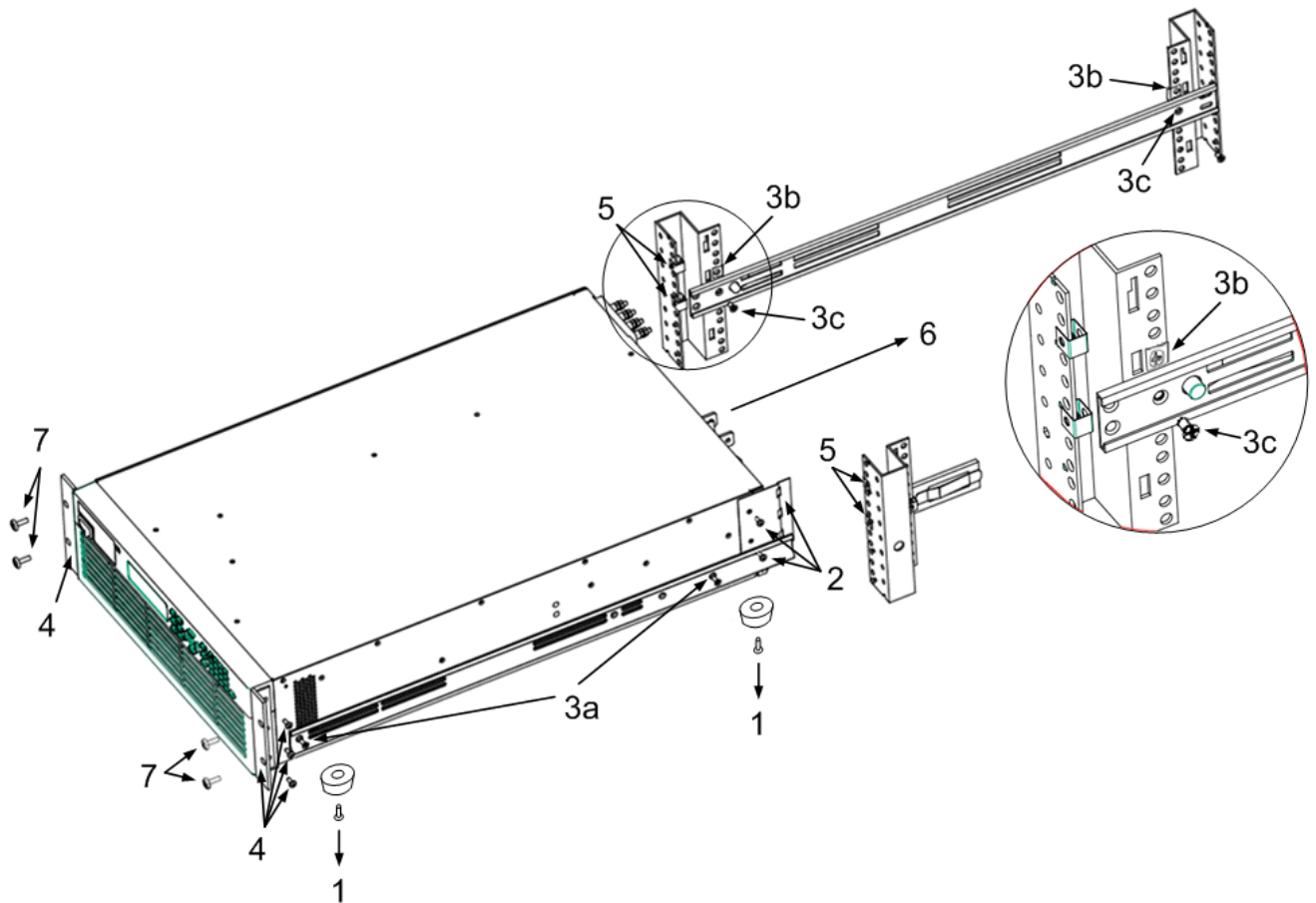

Connexions de l'alimentation secteur

Caractéristiques communes de l'alimentation secteur

Considérations relatives à la distribution de courant alternatif de type triangle et étoile

Installation d'un limiteur de surtension

Connexions des câbles d'alimentation

Caractéristiques communes de l'alimentation secteur

Les modèles Keysight RPS sont équipés d'un convertisseur d'entrée CA triphasé entièrement bidirectionnel, qui permet un flux de puissance bidirectionnel et sans faille entre l'alimentation secteur et les bornes de sortie CC. Dans une alimentation électrique standard, l'énergie circule uniquement des bornes de sortie du courant alternatif vers les bornes de sortie du courant continu. Dans une alimentation électrique régénérative, l'énergie circule également des bornes de sortie en courant continu vers l'alimentation secteur lorsque l'appareil fonctionne en courant d'absorption, soit en raison d'une programmation en aval rapide de la sortie ou de la décharge d'une source d'énergie telle qu'une batterie. Ce retour de l'énergie à l'alimentation secteur est appelé fonctionnement régénératif.

Le convertisseur d'entrée CA de l'appareil RPS PVS utilise des algorithmes de microprogramme pour maintenir un facteur de puissance élevé et une faible distorsion harmonique totale dans un large éventail de conditions de fonctionnement. Pour plus d'informations, reportez-vous à la partie consacrée à l'entrée CA dans les caractéristiques communes des modèles **RP793xA-RP794xA** et **RP795xA-RP796xA** et à la section **Limitation des sorties sinusoïdales**.

Suivez toutes les instructions de câblage pour le cordon d'alimentation fournies dans cette section du manuel.

ATTENTION Le dépassement de la tension d'entrée CA ou un mauvais câblage de la connexion de ligne peut créer des dommages permanents dans les appareils suivants.

Les composants suivants sont utilisés pour assurer l'immunité contre les transitoires ligne à ligne jusqu'à 1 kV et les transitoires ligne à terre jusqu'à 2 kV :

- Des limiteurs de tension de 600 Vrms sont installés sur les appareils avec entrée 400 V CA entre les connexions ligne à ligne.
- Des limiteurs de tension de 300 Vrms sont installés sur les appareils avec entrée 200 V CA entre les connexions ligne à ligne.

Plusieurs fonctions de protection internes sont utilisées pour protéger l'instrument contre les conditions anormales de la ligne tout en empêchant l'îlotage de l'alimentation secteur. Les conditions suivantes provoquent l'arrêt de l'instrument :

2 Installation de l'instrument

- Si la tension de ligne est supérieure à 120 % de la valeur nominale la plus élevée pour un cycle de ligne.
- Si la tension de ligne est inférieure à 50 % de la valeur nominale la plus basse pour trois cycles de ligne.
- Si le courant de ligne est supérieur à 120 % du courant de ligne le plus élevé attendu pendant environ une seconde.
- Si la fréquence de ligne se décale de plus de 2 Hz par rapport à la fréquence de ligne initiale pendant plus d'une seconde.
- En cas d'abandon d'une ligne à un cycle.

L'instrument redémarre automatiquement si la condition de défaillance n'est plus présente. La sortie restera désactivée après le redémarrage jusqu'à ce que l'opérateur rétablisse les réglages précédents, soit grâce aux commandes du panneau avant, soit à l'aide d'un programme informatique. Ce comportement est conforme aux procédures d'exploitation sécuritaires.

La condition suivante forcera la sortie dans un état de protection et produiront un indicateur d'état de panne de courant (PF) :

- Si la tension de ligne est inférieure à 83 % de la valeur nominale la plus basse pendant plus d'une seconde.

La condition suivante empêchera l'instrument de se mettre en marche :

- Si la fréquence de la ligne est en dehors de la plage de 46,5 Hz à 63,5 Hz.

En cas de panne secteur, l'appareil se déconnecte automatiquement de la ligne. Cela se produira avec l'appareil qu'il soit en courant d'alimentation ou en courant d'absorption.

Considérations relatives à la distribution de courant alternatif de type triangle et étoile

Les modèles Keysight RPS peuvent fonctionner avec une distribution triphasée de type triangle ou étoile. Les configurations présentées ci-dessous sont recommandées pour les appareils avec entrée 200/208 V CA. En cas de fonctionnement avec des configurations triangle, l'appareil doit être utilisé dans une configuration connectée en permanence ou avec un connecteur d'entrée CA conforme à la norme CEI 60309. Si aucune des deux solutions ci-dessus n'est possible, un conducteur secondaire (en plus de la masse dans la connexion triphasée) doit être utilisé pour relier le châssis de l'instrument à la terre.

Les connexions CA doivent être effectuées par un électricien qualifié qui connaît les circuits électriques triphasés et toutes les normes et exigences de sécurité applicables.

Configurations pour les appareils avec entrée 200/208 V CA

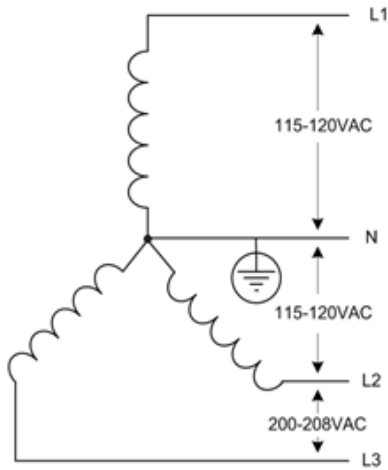

Ne connectez pas le neutre à l'instrument.

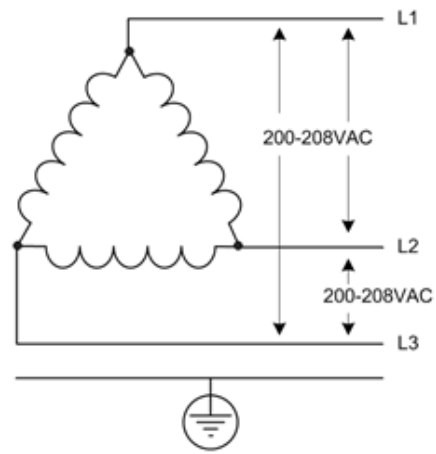

Cette configuration est de type triangle flottant.

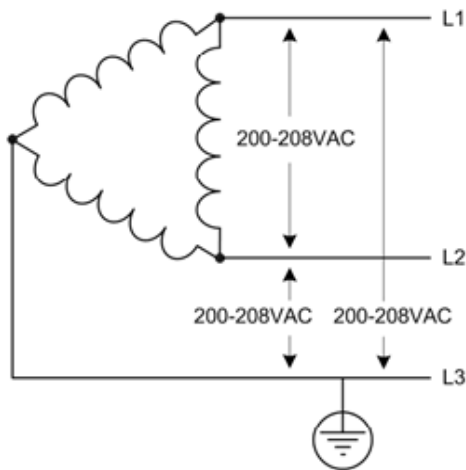

Cette configuration est de type triangle avec mise à la terre sur une phase.

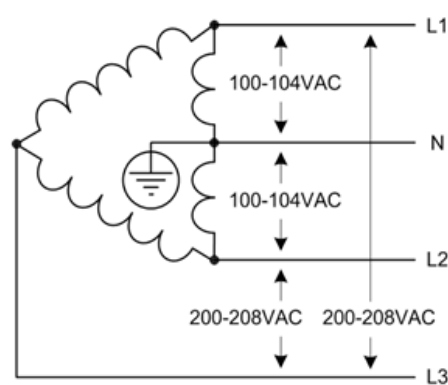

Cette configuration est de type triangle avec mise à la terre à sommet au neutre.

Configurations pour les appareils avec entrées 400/480 V CA

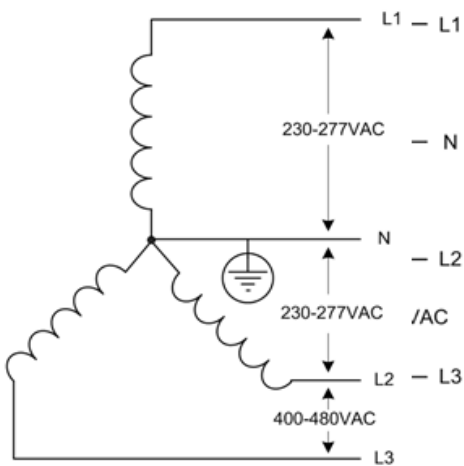

Ne connectez pas le neutre à l'instrument.

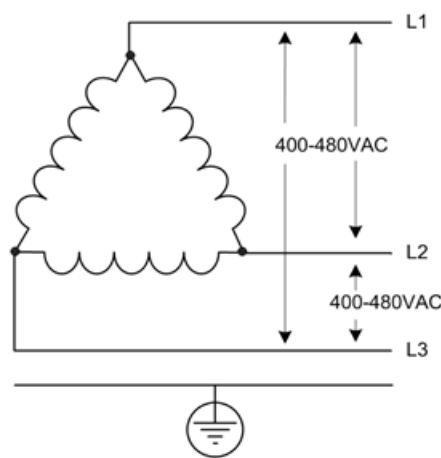

Cette configuration est de type triangle flottant.

Installation d'un limiteur de surtension

Un limiteur de surtension (kit réf. RP7961A-60007) est nécessaire pour les modèles Keysight RP7941A, RP7942A, RP7943A, RP7945A, RP7946A, RP7961A, RP7962A et RP7963A.

ATTENTION **Dégâts matériels.** La valeur nominale de la ligne en régime permanent pour le limiteur de surtension est de 350 V CA maximum ligne à terre ; et de 600 V CA maximum ligne à ligne.

Avant de commencer, vérifiez la liste suivante et la bonne réception des éléments suivants. Si un composant est manquant, contactez votre bureau commercial et d'assistance Keysight le plus proche.

Limiteur de surtension PCA 400 V - réf. 5067-6846

Vis Torx-T10 M3 x 0,5 35 mm - réf. 0515-1038

Boulon hexagonal M5 x 0,8 35 mm qté 3 - réf. 0515-6395

AVERTISSEMENT **RISQUE D'ELECTROCUTION.** Débranchez le cordon d'alimentation du secteur avant d'installer le limiteur de surtension.

Outils nécessaires : Tournevis hexagonal de 8 mm pour boulon M5, tournevis Torx T10 pour vis M3.

1. Retirez les trois boulons M5 existants de l'ensemble d'entrée CA à l'aide du tournevis hexagonal de 8 mm. Retirez également la vis M3 dans le châssis, à droite du plot de terre, à l'aide du tournevis Torx T10.

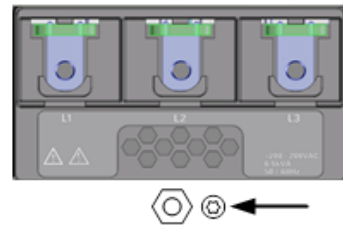

2. Positionnez le limiteur de surtension sur l'ensemble d'entrée CA et fixez-le à l'aide de la vis M3 de 35 mm de long fournie avec le limiteur de surtension (élément A). Serrez la vis à l'aide du tournevis Torx T10 à 9 Nm.

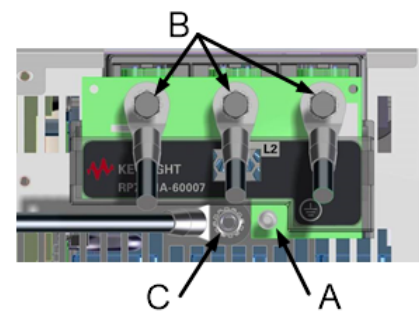

3. Installez les cosses annulaires de la ligne CA (L1, L2 et L3) sur le limiteur de surtension (élément A). Utilisez les trois boulons M5 de 35 mm de long fournis avec le limiteur de surtension (élément C) et les trois rondelles de blocage initialement fournies avec l'ensemble d'entrée CA (élément B) pour fixer les fils et le limiteur de surtension à l'ensemble d'entrée CA (élément B à l'étape 2). Serrez les boulons à l'aide du tournevis hexagonal de 8 mm à 20 Nm.

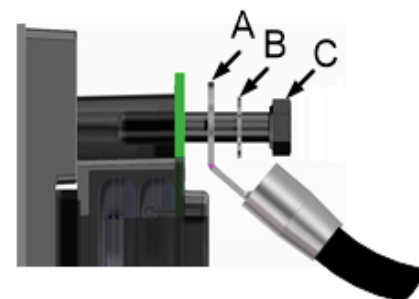

NOTE : N'utilisez PAS les rondelles de blocage supplémentaires fournies avec les boulons M5 d'origine, ni la vis M3 d'origine fournie sur l'appareil.

4. Si vous ne l'avez pas encore fait, installez la cosse annulaire du fil de terre sur le plot de terre situé directement sous l'ensemble d'entrée CA (élément C à l'étape 2). Serrez l'écrou de combinaison M5 à l'aide du tournevis de 8 mm à 20 Nm.
5. Installez le capot d'entrée CA et le serre-câble comme décrit dans la section Installation du cordon d'alimentation.

Connexions des câbles d'alimentation

REMARQUE Le respect de toutes les réglementations pour l'exploitation et la connexion au réseau public d'équipement de récupération d'énergie est obligatoire.

Les connexions doivent être effectuées par un électricien qualifié qui connaît des équipements de récupération d'énergie afin de s'assurer que toutes les exigences de sécurité applicables ont été suivies et toutes les conditions nécessaires respectées. Il doit également connaître les circuits triphasés et toutes les normes et exigences de sécurité applicables.

Aucun cordon d'alimentation secteur n'est fourni avec l'appareil.

Consultez le tableau suivant pour obtenir les exigences de capacité en courant maximale pour chaque câble conducteur.

Si des codes d'électricité locaux l'exigent, installez un fusible ou un disjoncteur entre l'alimentation secteur et l'appareil. Les valeurs de courant sont disponibles dans le tableau suivant.

Raccourcissez au maximum les câbles d'alimentation secteur. Plus le câble est long, plus la baisse de tension est importante en raison de la résistance du câble.

AVERTISSEMENT La section du câble doit être adaptée au courant d'entrée maximum de l'instrument. Le câble de masse doit avoir la même section que le câble de phase.

REMARQUE Les exigences de sécurité des organismes stipulent qu'il doit être possible de déconnecter physiquement le câble d'alimentation secteur de l'appareil. Un appareil de coupure (interrupteur ou disjoncteur) doit être fourni dans l'installation finale. L'appareil de coupure doit être proche de l'équipement, être facilement accessible et être marqué en tant qu'appareil de coupure de cet équipement. Il doit satisfaire aux exigences de valeurs d'entrée répertoriées dans le tableau suivant.

Modèle	Valeur nominale de l'appareil	L1 I _{max}	L2 I _{max}	L3 I _{max}
RP7931A, RP7932A, RP7951A	5 kW - 200/208 V CA	19,5 A	19,5 A	19,5 A

2 Installation de l'instrument

Modèle	Valeur nominale de l'appareil	L1 I _{max}	L2 I _{max}	L3 I _{max}
RP7941A, RP7942A, RP7961A	5 kW - 400/480 V CA	9,5 A	9,5 A	9,5 A
RP7933A, RP7935A, RP7936A, RP7952A, RP7953A	10 kW - 200/208 V CA	39 A	39 A	39 A
RP7943A, RP7945A, , RP7946A, RP7962A, RP7963A	10 kW - 400/480 V CA	19 A	19 A	19 A

Il est possible d'utiliser une distribution de type triangle ou étoile, à condition qu'une tension entre phases correcte soit appliquée. **Ne branchez pas le fil neutre sur un répartiteur secteur de type Y.** Il faut toujours prévoir une mise à la terre à la masse du châssis par un conducteur séparé.

Installation des cordons d'alimentation

AVERTISSEMENT

RISQUE D'ÉLECTROCUTION L'instrument requiert un raccordement à la terre du châssis via un conducteur distinct. Le secteur doit comporter une connexion à la masse.

Les connexions CA doivent être effectuées par un électricien qualifié qui connaît les circuits électriques triphasés et toutes les normes et exigences de sécurité applicables.

Dans les cas où l'appareil n'est pas câblé au système électrique, un schéma de connecteur de verrouillage doit être utilisé tel que UL 498, CEI 60309, ou équivalent. Consultez un électricien local pour connaître le schéma de connexion adapté à votre région.

Exemples 208 V/30 A :

<https://www.grainger.com/product/HUBBELL-WIRING-DEVICE-KELLEMS-30-Amp-Industrial-Grade-Locking-6C549>

Exemples 480 V/30 A :

<https://www.grainger.com/product/HUBBELL-WIRING-DEVICE-KELLEMS-30-Amp-Industrial-Grade-Locking-6C549>

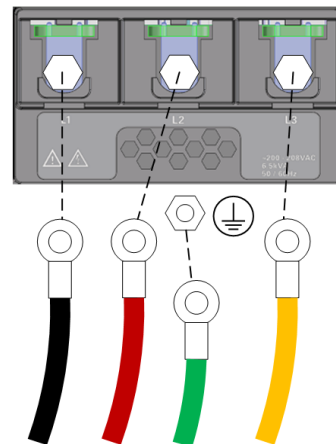
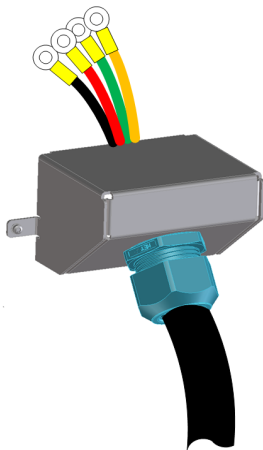

- En cas de fixation, retirez le capot de sécurité de l'appareil.
- Insérez les terminaisons du cordon d'alimentation dans le serre-câble du capot de sécurité. Le serre-câble du capot de sécurité est conçu pour recevoir un câble métallique ou des fils individuels.
- Ne serrez pas les serre-câble tant que toutes les connexions ne sont pas effectuées.
- Connectez le capot de sécurité à l'appareil.
- Fixez les fils des lignes à terminaison annulaire aux bornes CA (code de couleur américain indiqué). Le diamètre du boulon est M5. Placez les bornes annulaires entre les rondelles en étoile. Connectez le fil de masse au goujon du châssis *sous* l'ensemble du filtre de la ligne CA. **Ne connectez pas le fil neutre, s'il est fourni.**
- Serrez les boulons des bornes à 2,6 Nm (23 in-lb).
- Notez que sur les appareils plus anciens, les bornes d'alimentation secteur ont des connexions à écrou hexagonal.

Installation du noyau de ferrite - pour les modèles RP7961A, RP7962A, RP7963A antérieurs

Pour les appareils avec entrée 400/480 V CA qui ont des connexions à écrou hexagonal (pas de boulons), installez un noyau en ferrite (réf. 9170-2578) pour réduire les interférences RFI.

Placez le noyau le plus près possible du capot d'entrée tel qu'illustré.

Placez une attache de câble derrière le noyau pour éviter qu'il ne glisse du cordon d'alimentation.

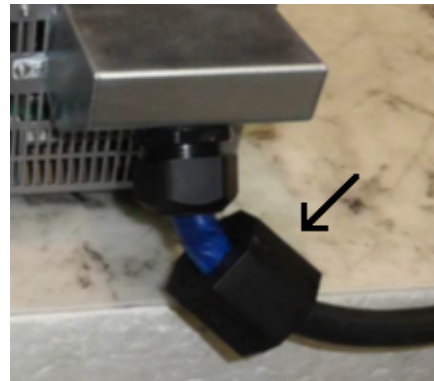

Connexions de sortie d'un appareil unique

Connexions de sortie

Connexions de charge unique

Connexions de charges multiples

Connexions de mesure à distance

Autres considérations relatives à la charge - tous les modèles

Autres considérations relatives à la charge - RP793xA, RP794xA

Connexions de sortie

Connexions de mesure

Vérifier que le câble de mesure est installé à l'arrière de l'instrument comme illustré. Le seul moment où le câble de mesure doit être déconnecté des barres conductrices de sortie est lors de la **mesure à distance**.

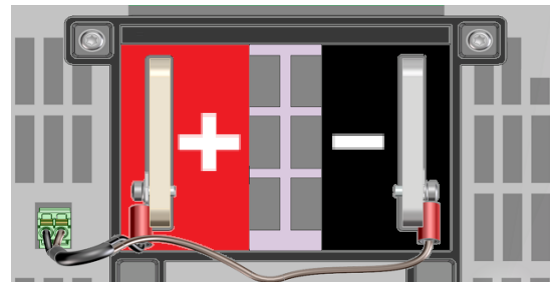

Si le câble de mesure n'est pas installé avant la mise sous tension de l'instrument ou s'il est débranché, l'appareil continuera à fonctionner. La tension à vide aux bornes de sortie sera de 0% à 0,54% plus élevée que la valeur programmée, car le point de régulation est maintenant maintenu par des résistances internes de protection de mesure. Le tableau suivant indique la variation de la tension **aux bornes de sortie** en pourcentage du réglage de tension lorsque les fils de mesure ne sont pas connectés. La tension de relecture apparaîtra toujours à la valeur programmée.

Modèle	Δ Gain en pourcentage
RP7931A, RP7941A, RP7933A, RP7943A *	0 %
RP7932A, RP7942A, RP7935A, RP7945A	+ 0,54 %
RP7936A, RP7946A	+ 0,27 %
RP7951A, RP7952A, RP7961A, RP7962A	+ 0,13 %
RP7953A, RP7963A	+ 0,06 %

* Pour les RPS 20 V uniquement, les fils de mesure sont placés en mémoire tampon de manière à ce qu'il n'y ait pratiquement aucune modification de la tension de sortie en circuit ouvert si le câble de mesure n'est pas installé ou est débranché.

Connexions de barre conductrice

AVERTISSEMENT **RISQUE D'ÉLECTROCUTION, TENSION LÉTALES** De nombreux modèles génèrent des tensions supérieures à 60 V CC, certains modèles ayant une tension nominale de 950 V CC ! Assurez-vous que toutes les connexions des instruments, le câblage de charge et les connexions de charge sont isolés ou recouverts à l'aide des capots de sécurité fournis, de sorte qu'aucun contact accidentel avec des tensions létales ne peut se produire.

Les facteurs suivants doivent être pris en compte lors du raccordement de la charge à l'alimentation :

- Intensité du courant des fils de charge
- Facteur d'isolation des fils de charge (doit être équivalent à la tension de sortie nominale)
- Chute de tension dans les fils de charge
- Effets du bruit et de l'impédance sur les fils de charge

Section des fils

AVERTISSEMENT **RISQUE D'INCENDIE** Pour satisfaire aux exigences de sécurité, les fils de charge doivent avoir une section suffisante pour ne pas surchauffer lors du passage du courant de sortie de court-circuit maximal. En présence de charges multiples, toute paire de fils de charge doit pouvoir conduire en toute sécurité le courant nominal maximal de l'appareil. Des fils de charge connectés en parallèle peuvent être nécessaires pour les modèles ayant un courant permanent admissible supérieur.

Le tableau suivant répertorie les caractéristiques du fil de cuivre AWG (American Wire Gauge).

AWG	Équivalent en mm ²	Format métrique le plus proche	Courant permanent admissible (remarque 1)	Résistance (remarque 2)
18	0,82	1 mm ²	Jusqu'à 14 A	6,385 Ω
16	1,31	1,5 mm ²	Jusqu'à 18 A	4,016 Ω
14	2,1	2,5 mm ²	Jusqu'à 25 A	2,525 Ω
12	3,3	4 mm ²	Jusqu'à 30 A	1,588 Ω
10	5,3	6 mm ²	Jusqu'à 40 A	0,999 Ω
8	8,4	10 mm ²	Jusqu'à 60 A	0,628 Ω
6	13,3	16 mm ²	Jusqu'à 80 A	0,395 Ω
4	21,2	25 mm ²	Jusqu'à 105 A	0,248 Ω
2	33,6	35 mm ²	Jusqu'à 140 A	0,156 Ω

2 Installation de l'instrument

1/0	53,5	50 mm ²	Jusqu'à 195 A	0,098 Ω
2/0	67,4	70 mm ²	Jusqu'à 225 A	0,078 Ω
3/0	85	95 mm ²	Jusqu'à 260 A	0,062 Ω
4/0	107	120 mm ²	Jusqu'à 300 A	0,049 Ω
6,2/0 (350 MCM)	177	185 mm ²	Jusqu'à 420 A	S.O.

Remarque 1 Le courant permanent admissible est basé sur un seul conducteur **à l'air libre**, température ambiante comprise entre 26 et 30 °C, le conducteur étant calibré à 60 °C. Le courant permanent admissible diminue à des températures plus élevées.

Remarque 2 La résistance est exprimée en ohms/300 m (1 000 pieds) à une température de fil de 20 °C.

Outre la température, vous devez également tenir compte de la chute de tension lors du choix de sections de fils. Le RPS tolère une chute de tension de 1 V par fil tout en assurant la précision de la programmation et de la mesure spécifiée (voir les spécifications des modèles **RP793xA-RP794xA** et **RP795xA-RP796xA**). Des chutes de tension maximales de 25 % par rapport à la tension de sortie nominale par fil sont tolérées et ne diminuent que très sensiblement la précision de la programmation et de la mesure. Naturellement, toute chute de tension dans les fils de charge réduit la tension maximale disponible au niveau de la charge. Soustrayez la chute de tension dans les fils de charge de la tension nominale de l'appareil pour déterminer la tension maximale disponible au niveau de la charge.

Connexions de charge unique

1. Comme illustré dans la figure suivante, dotez tous les fils de charge de cosses solidement fixées aux bornes. N'utilisez pas de fils nus pour raccorder la charge au bloc d'alimentation.
2. Faites passer les fils à travers le capot de sécurité avant de les fixer aux barres conductrices. Des alvéoles perforables sont prévues pour les fils d'un diamètre supérieur. La figure illustre le matériel recommandé pour brancher les fils aux barres conductrices. Vous devez fournir tout le câblage. Assurez-vous que le matériel de montage des fils ne court-circuite pas les bornes de sortie.
3. Lors de la fixation des cosses sur les barres conductrices, veiller à ce qu'il y ait suffisamment d'espace pour le capot de sécurité. Torsadez ou rassemblez les fils de charge afin de réduire les effets d'inductance et du bruit. L'objectif est de réduire les surfaces de boucle ou l'espace physique entre les fils de sortie + et - des barres conductrices et la charge.
4. Fixez le capot de sécurité au panneau arrière. Notez que les câbles lourds doivent être munis de dispositifs réducteurs de contrainte pour éviter la torsion du capot de sécurité ou des barres conductrices.

Modèles haute tension - RP795xA et RP796xA RP795xA, RP796xA

ATTENTION

Le couple de serrage de boulons de sortie ne doit pas dépasser 10,8 Nm (8 lb-ft).

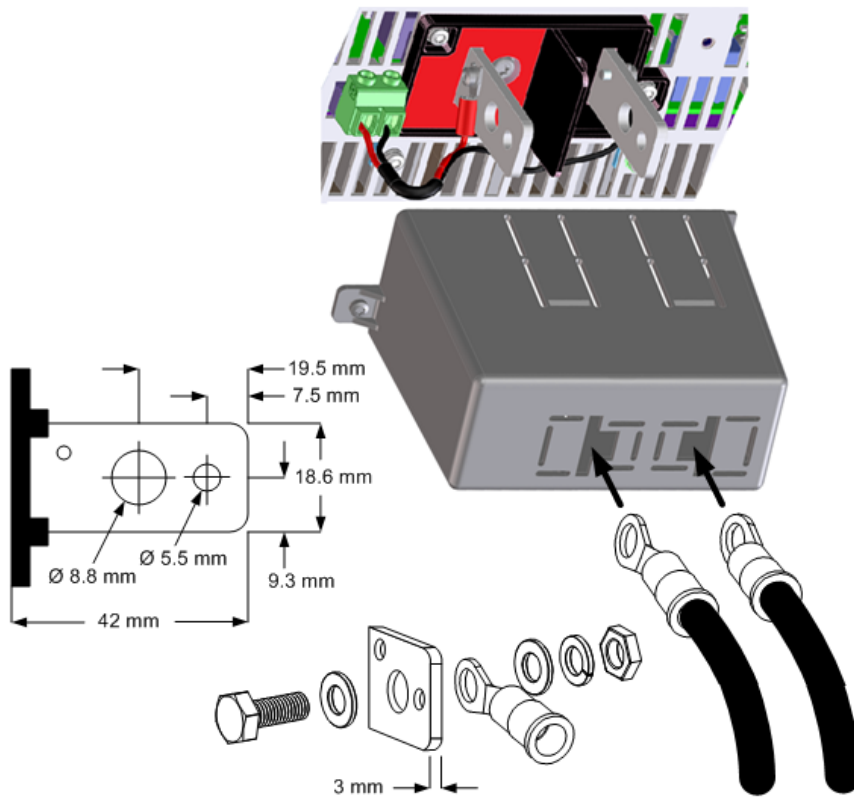

Modèles à courant élevé - RP793xA et RP794xA **RP793xA, RP794xA**

ATTENTION Le couple de serrage de boulons de sortie ne doit pas dépasser 20,3 Nm (15 lb-ft).

2 Installation de l'instrument

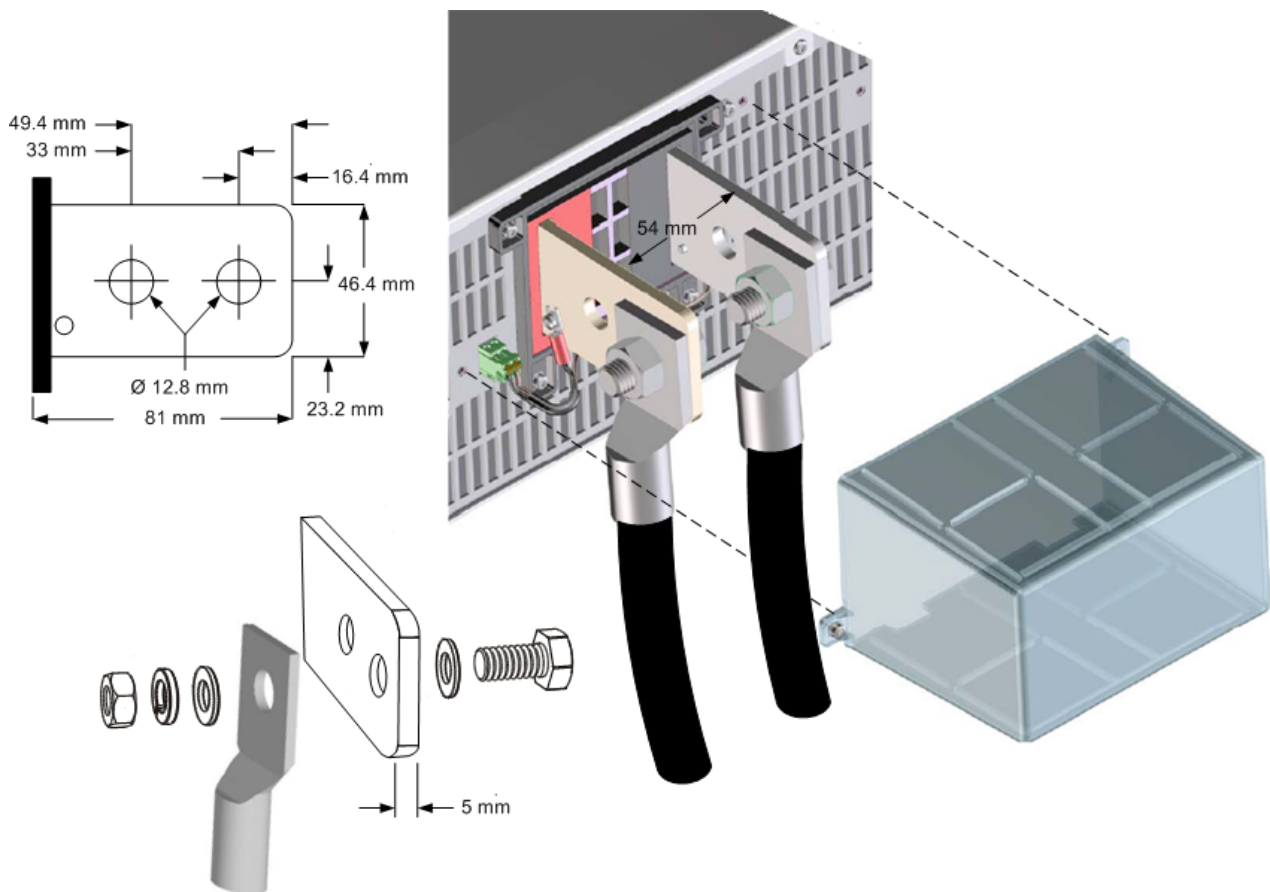

Connexions de charges multiples

Si vous utilisez les mesures locales et connectez plusieurs charges à une sortie, branchez chacune d'elles aux bornes de sortie à l'aide de fils de connexion distincts comme indiqué sur la figure suivante. Cela réduit les effets de couplage mutuel et permet de profiter pleinement de la faible impédance de sortie du bloc d'alimentation. Maintenez chaque paire de fils aussi courte que possible ; torsadez ou rassemblez ces fils afin de réduire les effets d'inductance et de bruit. L'objectif est de réduire les surfaces de boucle ou l'espace physique entre les fils de sortie + et - des barres conductrices et la charge.

Si des considérations de charge requièrent l'utilisation de bornes situées à distance du bloc d'alimentation, torsadez ou rassemblez les fils entre les bornes de sortie et les bornes de distribution à distance. Branchez chaque charge séparément aux bornes de distribution. La régulation à distance de la tension est recommandée dans ces circonstances. Effectuez la mesure sur les bornes de distribution à distance ou, si une charge est plus sensible que les autres, directement sur cette dernière.

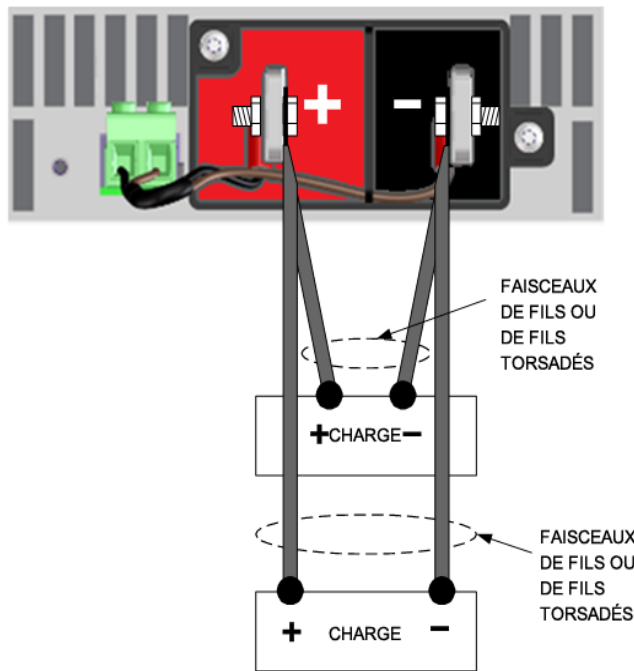

Connexions de mesure à distance

La mesure à distance améliore la régulation de la tension au niveau de la charge en la surveillant directement en ce point plutôt qu'aux bornes de sortie. Ainsi, le bloc d'alimentation peut compenser automatiquement la chute de tension dans les fils de charge. La mesure à distance est particulièrement utile dans le cadre du fonctionnement en tension constante où les impédances de charge varient ou dont les fils présentent une résistance significative. Elle n'a aucun effet sur le fonctionnement en courant constant. La mesure ne dépendant pas des autres fonctions d'alimentation, la mesure à distance peut être utilisée, quelle que soit la façon dont l'alimentation est programmée.

Branchez l'appareil pour une mesure à distance en retirant d'abord le câble de mesure local reliant les bornes de mesure aux bornes de charge. Réalisez ensuite vos connexions (voir la figure ci-dessous).

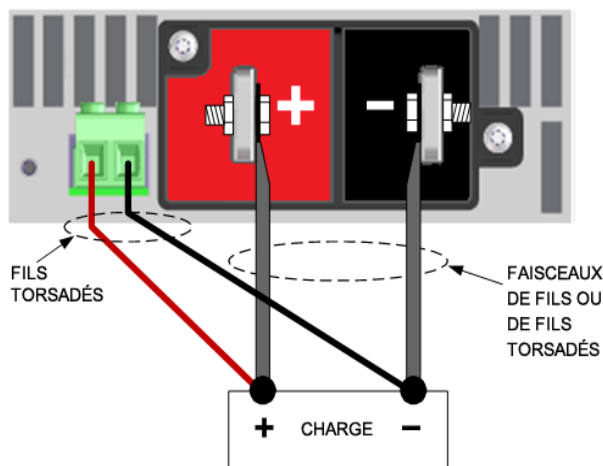

2 Installation de l'instrument

Raccordez les bornes de sortie à la charge à l'aide de fils de connexion séparés. Maintenez la paire de fils aussi courte que possible ; torsadez ou regroupez-la afin de réduire les effets d'inductance et de bruit.

Maintenez les sections de fils de connecteurs de mesure comprises entre 1,5 mm² (AWG 16) maximum et 0,2 mm² (AWG 24) minimum. Retirez l'isolant du fil sur 10 mm. Serrez fermement les vis.

Connectez les fils de mesure aussi près que possible de la charge. Ne regroupez PAS la paire de fils torsadée et les fils de charge ; maintenez les fils de charge à l'écart des fils de mesure. La section des fils de mesure peut être inférieure à celle du câblage de charge. Les fils de mesure peuvent conduire jusqu'à 1 mA de courant sans diminuer la mesure du courant.

REMARQUE Maintenez la résistance des fils de mesure en dessous de 0,5 Ω par fil environ (ceci nécessite 20 AWG ou plus pour une longueur de 15,24 m (50 pieds)).

Notez toutefois qu'une chute de tension dans les fils de mesure peut compromettre la régulation de la tension de sortie. Lorsque la chute de tension dans les fils de charge augmente, l'erreur de régulation de la tension de charge due à la résistance des fils de mesure augmente selon la formule suivante :

$$\Delta V_{\text{regulation}} = 2(V_{\text{load}}(R_{\text{sense}}/S_{\text{protect}}))$$

R_{sense} est la résistance en ohms de chaque fil de mesure. V_{load} est la chute de tension dans chaque fil de mesure. S_{protect} est la résistance de protection interne de mesure (voir tableau).

La formule suppose que la chute de tension dans les fils de mesure + et - et dans les fils de charge + et - est égale.

Modèle	Résistance S_{protect}
RP7931A, RP7941A, RP7933A, RP7943A	1,96 kΩ
RP7932A, RP7942A, RP7935A, RP7945A	524 Ω
RP7936A, RP7946A	524 Ω
RP7951A, RP7952A, RP7961A, RP7962A	1,6 kΩ
RP7953A, RP7963A	1,5 kΩ

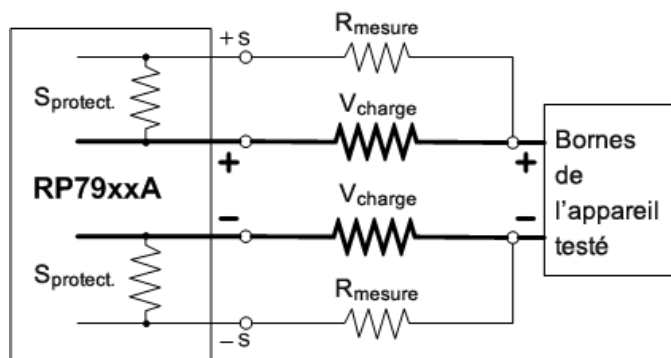

Si les fils de mesure à distance s'ouvrent lors du fonctionnement normal (en présence de courant de sortie), la variation de la tension de sortie **à la charge** dépend du courant de charge et des résistances des fils concernés. Lorsque les fils de mesure s'ouvrent, l'appareil revient automatiquement à la

mesure locale. La tension au point de mesure à distance précédent (habituellement à la charge) diminue d'une valeur donnée selon l'équation suivante :

$$\Delta V = I_{\text{sortie}} \times (\text{résistance totale du câblage de charge})$$

Inversement, si l'appareil absorbait du courant, la tension au point de mesure à distance précédent aurait augmenté de la même valeur.

Les fils de mesure court-circuités sont détectés par la fonction de protection contre les surtensions. Cette fonction entraîne la désactivation de la sortie en raison d'une erreur de surtension (OV).

Les fils de mesure inversés sont détectés par la fonction de protection contre les surtensions négatives. Cette fonction entraîne la désactivation de la sortie en raison d'une erreur de surtension négative (OV-).

Reportez-vous aux **Autres considérations relatives à la charge - RP793xA, RP794xA** pour obtenir des informations sur l'inductance des fils lors de l'utilisation de la télédétection avec la capacité de charge et l'inductance des fils.

Protection contre les surtensions

La fonctionnalité de protection contre les surtensions (OVP) assure une protection contre les surtensions configurable basée sur la tension des fils de mesure. Demander au circuit OVP de surveiller la tension des fils de mesure plutôt que la tension des bornes de sortie permet de contrôler plus précisément la tension directement sur la charge.

Notez qu'en cas de chute de tension dans les fils de charge, la tension mesurée à la sortie de l'alimentation peut être supérieure à celle qui est régulée au niveau de la charge. La tension aux bornes de sortie de l'alimentation ne peut jamais dépasser la tension nominale de l'appareil.

Bruit de sortie

Les bruits captés sur les fils de mesure apparaissent au niveau des bornes de sortie et peuvent avoir un effet néfaste sur la régulation de la charge CV. Torsadez les fils de mesure pour capter moins de bruits externes. Dans les environnements extrêmement bruyants, il peut être nécessaire de blinder les fils de mesure. Mettez le blindage à la terre seulement à l'extrémité du bloc d'alimentation ; n'utilisez pas le blindage comme conducteur de mesure.

Les spécifications de bruit indiquées dans les tableaux des spécifications **RP793xA-RP794xA** et **RP795xA-RP796xA** s'appliquent aux bornes de sortie lorsque des mesures locales sont utilisées. Il se peut toutefois que des transitoires de tension soient générés au niveau de la charge par le bruit induit dans les fils ou par les états transitoires de courant de la charge agissant sur l'inductance et la résistance du fil de charge. S'il est souhaitable de conserver les niveaux de transitoires de tension au minimum, placez en travers de la charge un condensateur en aluminium ou en tantale d'une valeur de 10 microfarad/pied (30,5 cm) de fil de charge environ.

Autres considérations relatives à la charge - tous les modèles

Temps de réponse avec un condensateur externe

Lorsque vous effectuez une programmation avec un condensateur externe, le temps de réponse de la tension peut être plus long que celui indiqué avec les charges purement résistives. La formule suivante permet d'évaluer le temps de réponse supplémentaire dû à la programmation :

$$\text{Temps de réponse} = \frac{(\text{condensateur de sortie ajouté}) \times (\text{changement de } V_{\text{out}})}{(\text{valeur limite de courant}) - (\text{courant de charge})}$$

Notez que la programmation dans un condensateur de sortie externe peut faire brièvement passer le RPS en mode de courant constant, ce qui ajoute également du temps de réponse supplémentaire. En définissant le balayage de tension approprié lors de l'utilisation d'un condensateur externe, il peut être possible d'empêcher le basculement en mode de courant constant.

Tensions positive, négative et flottante

Vous pouvez obtenir des tensions positives ou négatives à la sortie par rapport à la masse en mettant l'une des bornes de sortie à la terre (commun). Utilisez toujours deux fils pour relier la charge à la sortie, quel(le) que soit l'emplacement ou la méthode de mise à la terre du système.

- Les modèles 20 V peuvent fonctionner avec toute borne de sortie portée à une tension de ± 60 V CC, tension de sortie par rapport à la terre comprise.
- Les modèles 80 V et 160 V peuvent fonctionner avec toute borne de sortie portée à une tension de ± 240 V CC, tension de sortie par rapport à la terre comprise.
- Les modèles 500 V et 950 V peuvent fonctionner avec toute borne de sortie portée à une tension de ± 950 V CC, tension de sortie par rapport à la terre comprise.

REMARQUE Les modèles RPS sont optimisés pour une mise à la terre de la borne de sortie négative. La mise à la terre de la borne positive peut provoquer une augmentation du bruit de mesure du courant et une réduction de la précision de mesure du courant.

Autres considérations relatives à la charge - RP793xA, RP794xA

REMARQUE Ces informations s'appliquent uniquement aux modèles RP793xA et RP794xA seulement. **RP793xA, RP794xA**

Limites d'inductance de charge

ATTENTION **DOMMAGES MATÉRIELS** Les fixations internes du niveau de tension de l'instrument sont sensibles aux dommages thermiques lorsque la sortie est coupée brusquement à pleine charge si l'inductance du fil dépasse la caractéristique d'**Inductance de charge maximale** dépendante du modèle.

Comme point de référence d'inductance des fils, une seule paire de fils de charge produit habituellement entre 500 nH et 1 μ H par mètre de longueur couplée (aller-retour), selon la section du fil, l'épaisseur de l'isolation et le couplage mécanique des fils. Pour obtenir de plus grandes longueurs de fil, l'inductance des fils peut être réduite au minimum en mettant en parallèle des faisceaux de fils de charge supplémentaires ou en utilisant un câblage spécialisé à faible inductance.

Capacité de charge et considérations relatives à l'inductance des fils lors d'un fonctionnement en tension constante (CV)

Lors d'un fonctionnement CV, en mode de priorité de tension et en mode de priorité de courant (lorsque l'appareil se trouve en limite de tension), la configuration ressemble habituellement à celle de la figure suivante où l'appareil testé est de nature résistive ou à impédance élevée et peut avoir une certaine capacité de dérivation locale près de ses propres bornes. Il est recommandé d'utiliser la mesure à distance au niveau des bornes de l'appareil testé lorsqu'une régulation précise de la tension continue est nécessaire.

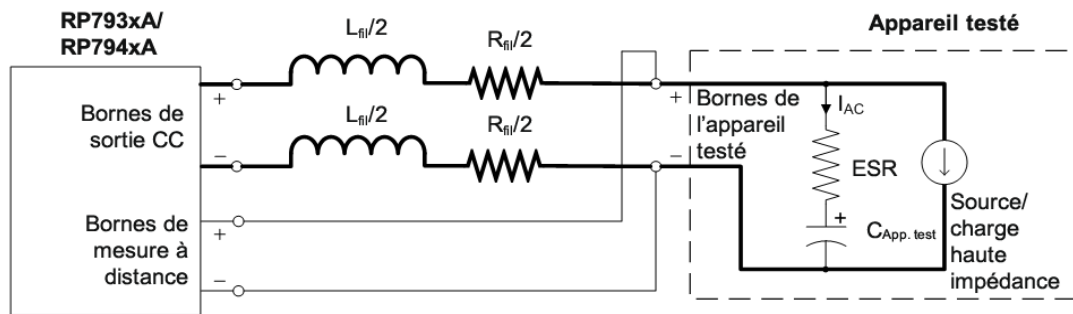

Lors d'un fonctionnement CV, les charges capacitatives importantes et des fils à inductance élevée peuvent créer une suroscillation et une tension dynamiquement instable au niveau de l'appareil testé lors de variations brutales de la charge ou de la tension. L'ESR tend à atténuer ce phénomène en amortissant la résonance qui se produit entre la capacité de charge et l'inductance des fils. La résistance des fils contribue aux effets d'amortissement de l'ESR, mais augmente également la chute de tension et la dissipation de puissance dans les fils de charge. Les graphiques de **Limites de charge capacitive** dans la section Caractéristiques comportent des recommandations pour l'ESR minimum requis en tant que fonction de la capacité de l'appareil testé selon deux ensembles de conditions de fils de charge. Il s'agit d'une fonction du **mode de compensation** de la tension.

Dans le cas d'un appareil testé qui a une capacité interne avec un ESR insuffisant, comme le montrent les graphiques des limites de charge capacitive, tel que les condensateurs à couche ou les condensateurs céramiques, il est possible d'ajouter une capacité et une résistance en série supplémentaires en parallèle pour atténuer les effets de suroscillation, comme l'illustre la figure suivante. La capacité supplémentaire doit être d'au moins 1 à 4 fois la valeur de C_{DUT} et l'ESR désiré doit être choisi en fonction des tracés de limites de charge capacitive pour le C_{DUT} . Ceci peut être réalisé soit en ajoutant un condensateur et une résistance explicites, soit en ajoutant un condensateur électrolytique avec la valeur appropriée de l'ESR nominal. La capacité parallèle et l'ESR doivent être en mesure de satisfaire aux exigences spécifiques à l'appareil testé, telles que l'ondulation du courant ou de la tension. De plus, la capacité parallèle limitera la capacité du RPS à mesurer des fronts de courant rapides provenant directement de l'appareil testé, ainsi qu'à ralentir la vitesse de programmation de la tension et la bande passante.

2 Installation de l'instrument

Réseau amortisseur
typique externe

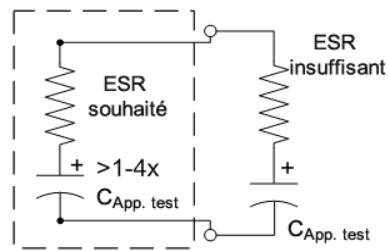

Variation de tension transitoire

La réponse transitoire de tension spécifiée à un palier de courant de charge pour le RPS peut se dégrader en cas de mesure à distance avec de longs fils de charge, en particulier avec une faible capacité de dérivation au niveau de l'appareil testé. Cela peut se manifester par un mauvais amortissement de l'oscillation ou même par un bon amortissement de la réponse bien avec une variation maximale très importante. Ce problème est exagéré dans le cas d'appareils RPS à basse tension et à courant élevé. Pour atténuer ce phénomène, il est possible d'ajouter une capacité parallèle aux bornes concernées afin de réduire l'amplitude de la variation de tension. Il est probable qu'un réseau d'amortissement parallèle externe, comme illustré précédemment, soit nécessaire à la place ou en plus d'un condensateur pur. Généralement, un condensateur à faible ESR connecté en parallèle avec un condensateur à ESR élevé permet une bonne stabilité, une variation minimale de la tension de réponse transitoire, ainsi qu'un bon filtrage du bruit de tension.

Considérations relatives à l'inductance du fil lors d'un fonctionnement à courant constant (CC)

Lors d'un fonctionnement CC, en mode de priorité de courant et en mode de priorité de tension (lorsque l'appareil se trouve en limite de courant), la configuration ressemble habituellement à celle de la figure suivante où l'appareil testé a une faible impédance ou source de tension. Les mesures de fils de mesure sont toujours utilisées pour détecter les événements de protection contre les surtensions/sous-tensions et lors du passage en mode CV.

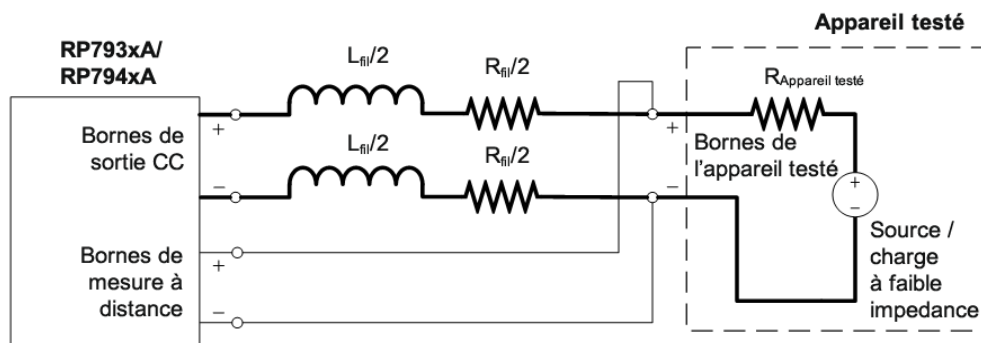

Lors d'un fonctionnement CC, de gros fils inductifs peuvent créer des suroscillations dans le courant de sortie lors des paliers de programmation du courant ou des variations de la tension de charge. Cet effet augmente à mesure que l'inductance augmente et que la résistance des fils diminue. Le graphique de **Limite de charge inductive** dans la section Caractéristiques indique le niveau minimum de résistance des fils pour atténuer le dépassement de la programmation et l'instabilité de la réponse de programmation dans deux ensembles de conditions de fils de charge. C'est une fonction du **mode de compensation** de courant. Notez que la résistance du fil et celle de l'appareil testé sont

indifférenciables dans ce contexte, donc la résistance de l'appareil testé est ajoutée à la résistance effective des fils indiquée dans les graphiques.

Programmation dynamique du courant avec de fortes charges inductives

D'autres contraintes peuvent être nécessaires lors de la programmation des paliers de courant avec des appareils testés ou des fils à inductance élevée. La vitesse de programmation diminue avec des charges inductives supérieures à 1 μH . Lors de la programmation de paliers de courant importants, une dégradation supplémentaire de la vitesse et des dépassements peuvent survenir en raison des limites de tension inhérentes au RPS. Sans réduction de l'inductance, il est impossible d'améliorer la dégradation de la vitesse. Cependant, il est possible d'atténuer ou de supprimer l'aspect de dépassement en diminuant progressivement le réglage du **pôle de programmation** ou de la **vitesse de balayage** jusqu'à ce que le niveau de performance souhaité soit atteint.

Courant excessif en mode de priorité de courant

ATTENTION

Un courant de sortie excessif peut endommager l'appareil testé dans certaines conditions. Cela peut se produire, par exemple, si l'appareil testé court-circuite la sortie de l'instrument lorsque la limite inférieure de tension est réglée sensiblement au-dessus de zéro.

En mode priorité de courant, si la tension d'un appareil testé à faible impédance, comme une batterie ou un court-circuit, dépasse la limite supérieure de tension ou passe en dessous de la limite inférieure de tension, le courant peut dépasser la valeur nominale en régime permanent de l'appareil RPS et potentiellement endommager l'appareil testé. Après un court délai, le flux de courant excessif entraînera l'activation de la protection contre les surintensités, ce qui désactivera la sortie du RPS.

Connexions de sortie de plusieurs appareils

Connexions en parallèle

Connexions de mesure et de charge

Connexions principale/secondaire

Connexions de partage de courant - RP795xA, RP796xA

Connexions en série

Connexions en parallèle

La connexion en parallèle des blocs d'alimentation permet d'obtenir un courant supérieur à celui obtenu avec un seul appareil. L'utilisation d'une configuration principale/secondaire est nécessaire pour les modèles RP793xA, RP794xA et recommandée pour les modèles RP795xA, RP796xA (voir [Fonctionnement en parallèle](#)).

Les modèles RP795xA, RP796xA peuvent fonctionner en parallèle sans utiliser de configuration principale/secondaire, mais la fonction Partage de courant doit être explicitement activée (voir [Fonctionnement en parallèle indépendant](#)).

AVERTISSEMENT

RISQUE D'ÉLECTROCUTION Tous les appareils en parallèle doivent être raccordés à la masse en permanence par un cordon d'alimentation mis à la terre. Toute interruption du conducteur de protection (mise à la terre) ou tout débranchement de la borne de terre de protection d'un appareil vous expose à un risque d'électrocution susceptible de provoquer des blessures ou la mort.

ATTENTION

Pour éviter d'éventuels dommages de l'équipement :

- Ne connectez pas plus de vingt appareils **de tensions nominales identiques**. Tous les appareils doivent avoir la même tension, mais les valeurs nominales de courant peuvent varier. Tous les appareils doivent disposer de la même version du micro-programme. Pour plus de détails, reportez-vous à la section [Identification de l'instrument](#).
- Activez et désactivez toujours simultanément l'**alimentation CA**. Ne laissez jamais d'appareils sous tension lorsque les autres sont éteints.
- Dans le cas des modèles RP795xA et RP796xA, connectez toujours les bornes de sortie **négatives** de tous les appareils en parallèle ensemble afin d'éviter tout endommagement du bus de partage.

Connexions de mesure et de charge

Les figures suivantes illustrent trois appareils connectés en parallèle. Observez les recommandations suivantes :

- Installez toujours les appareils connectés en parallèle relativement près les uns des autres.
- Raccourcissez autant que possible les câbles entre les systèmes d'alimentation et la charge, et torsadez ou rassemblez les fils afin de réduire les effets d'inductance et de bruit. L'objectif est de réduire les surfaces de boucle ou l'espace physique entre les fils de sortie + et - des barres conductrices et la charge.
- Une configuration asymétrique de paires de fils conducteurs de charge distinctes de longueur **égale** connectées à un point de charge commun est hautement recommandée. Cela permet d'obtenir la meilleure réponse dynamique possible.
- Les barres conductrices peuvent être utilisées pour connecter en parallèle les bornes de sortie dans une configuration en pile. Vérifiez que la section des barres conductrices s'adapte au courant de sortie total de la pile. Les barres conductrices peuvent être placées à l'intérieur ou à l'extérieur des bornes de sortie. Les surfaces exposées des barres conductrices doivent être enfermées dans une armoire ou isolées afin d'éviter tout contact accidentel avec des tensions mortelles.
- Pour maintenir la régulation de charge spécifiée avec les appareils connectés en parallèle, branchez tous les fils de mesure directement à la charge. Torsadez chaque paire de fils de mesure. N'utilisez pas la mesure à distance en même temps que la mesure locale.

Même si les figures suivantes illustrent l'utilisation recommandée de la mesure locale, cette fonction peut être utilisée en cas d'absolue nécessité. Cependant, dans le cas de la mesure locale, les circuits de partage ne fonctionneront correctement que si la chute de tension mesurée *entre* les points de mesure locaux d'un appareil et ceux d'un autre appareil connecté en parallèle est inférieure à 0,5 % de la tension nominale maximale des appareils.

Exemple de connexion en parallèle - RP793xA, RP794xA

Les longueurs de câble indiquées ne sont pas à l'échelle. Toutes les paires de câbles de charge doivent être symétriques et de longueur égale pour obtenir les meilleures performances. Dimensionnez les câbles de charge en fonction du courant nominal de l'appareil. Doublez les câbles sur les appareils de 10 kW pour que l'inductance du câble ajuste l'échelle avec les appareils de 5 kW. Les câbles « Plus » doivent être regroupés avec les câbles « Moins ». Bien que le schéma présente les appareils côte à côte à des fins de clarté, elles peuvent également être empilées les unes sur les autres.

2 Installation de l'instrument

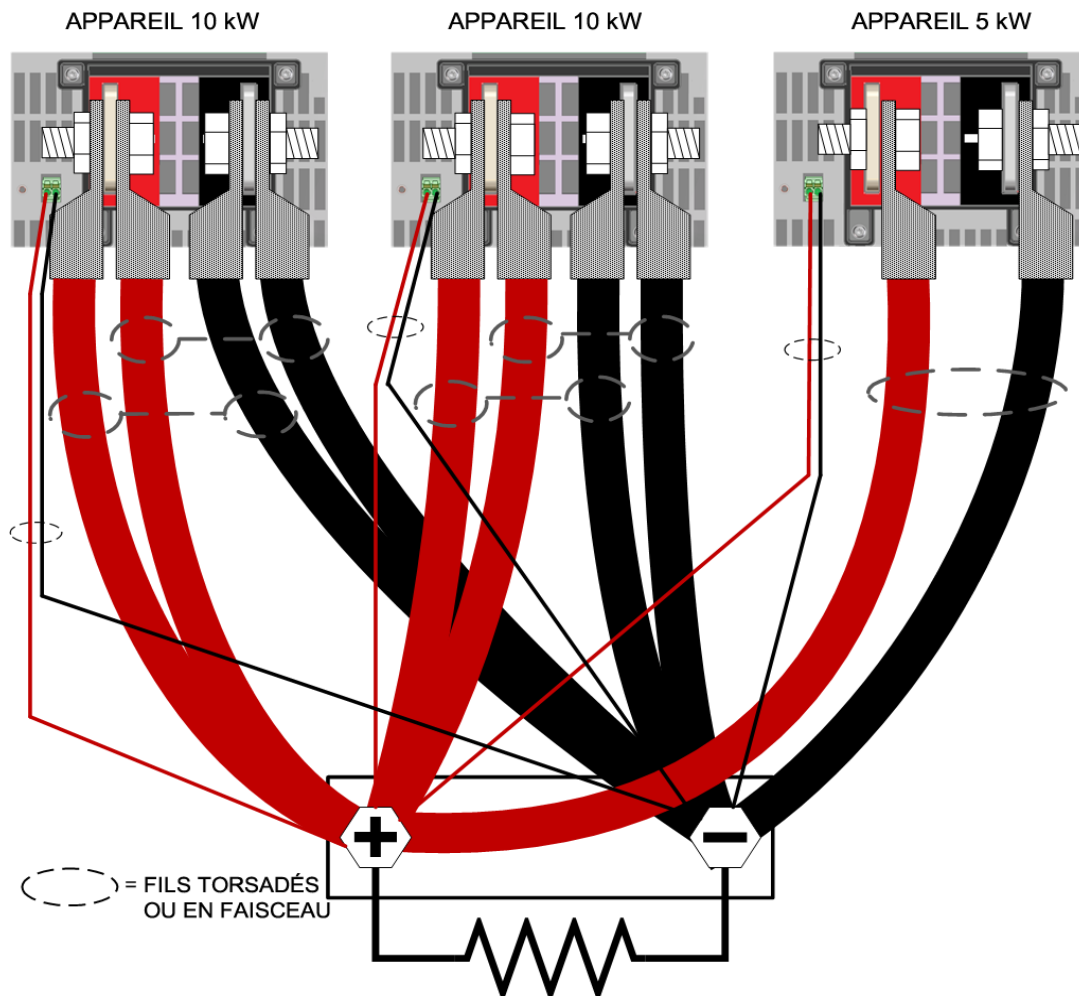

Exemple de connexion en parallèle - RP795xA, RP796xA

AVERTISSEMENT

RISQUE D'ÉLECTROCUTION, TENSION LÉTALES De nombreux modèles génèrent des tensions supérieures à 60 V CC, certains modèles ayant une tension nominale de 950 V CC ! Assurez-vous que toutes les connexions des instruments, le câblage de charge et les connexions de charge sont isolés ou recouverts à l'aide des capots de sécurité fournis, de sorte qu'aucun contact accidentel avec des tensions létales ne peut se produire.

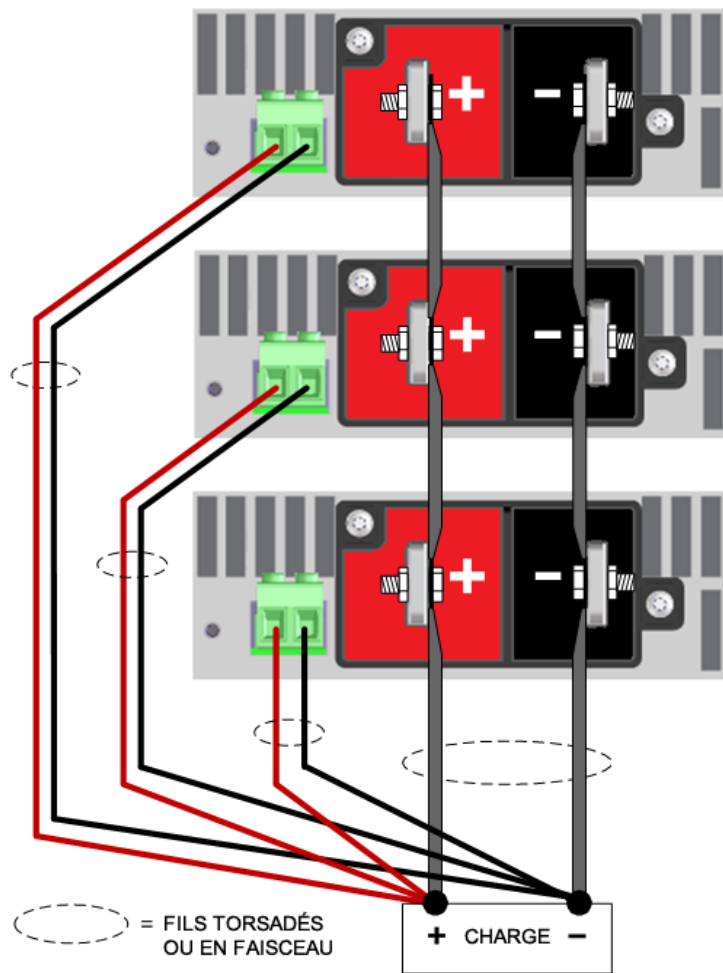

Connexions principale/secondaire - pour tous les modèles

Une configuration principale/secondaire peut être utilisée pour connecter des appareils en parallèle. Cela permet à un appareil désigné d'agir en tant que contrôleur principal de tous les appareils de la pile connectée en parallèle. La communication principale/secondaire utilise un bus numérique RS485. Les connexions sont effectuées à l'aide du câble CAT6A blindé fourni, comme le montre la figure suivante. Pour plus d'informations sur les configurations principale/secondaire, reportez-vous au **Fonctionnement en parallèle**.

La figure détaille également les paramètres des commutateurs de terminaison des appareils connectés en parallèle. Seuls les premier et dernier appareils de la pile doivent avoir le commutateur réglé sur la position « terminaison fermée ». Les commutateurs des appareils intermédiaires doivent être réglés sur « terminaisons ouvertes ». Si seulement deux appareils sont connectés dans une configuration principale/secondaire, les deux appareils doivent avoir leurs commutateurs sur « terminaison fermée ». Une erreur de partage de courant (CSF) peut se produire si les commutateurs sont mal réglés.

2 Installation de l'instrument

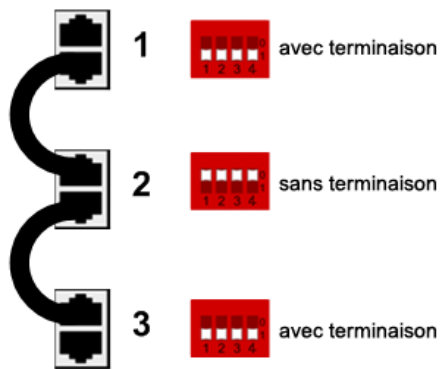

N'installez pas d'appareils dans une configuration principale/secondaire qui n'est pas activement utilisée dans le cadre du groupe principal/secondaire.

Connexions de partage de courant - RP795xA, RP796xA

REMARQUE Le partage de courant entre les modèles connectés en parallèles RP795xA et RP796xA **RP795xA, RP796xA** nécessite un câble de partage séparé pour connecter les appareils. Ce câble fournit le signal analogique qui permet aux appareils de même tension nominale de partager le courant. La fonction de partage de courant doit être activée par l'utilisateur. Pour plus d'informations sur de partage de courant, reportez-vous à la section **Activer le partage de courant**.

Connectez les bornes de **partage** pour pouvoir utiliser la fonction de partage de courant, comme indiqué dans la figure suivante. Les prises de connexion sont fixées à chaque extrémité du câble de partage comme illustré. En cas de connexion de plusieurs câbles, retirez un connecteur de l'un des câbles et branchez les extrémités des fils sur le câble précédent. 2 broches en parallèle ensemble et 3 broches en parallèle ensemble. La broche 1 n'est pas utilisée.

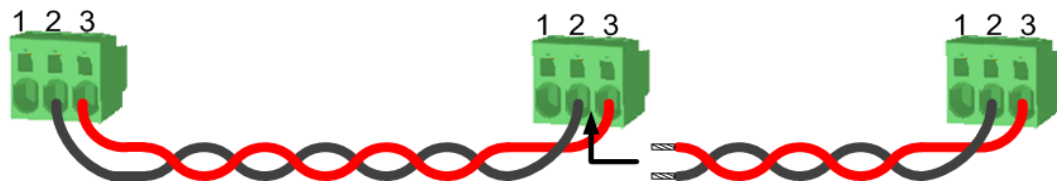

REMARQUE Si le câble de partage est débranché, les appareils connectés en parallèle fonctionnent toujours, mais ne partagent pas le courant ou ne maintiennent pas un fonctionnement en mode de tension constante. Une fois la sortie désactivée, le relais de partage s'ouvre et déconnecte l'appareil du bus de partage.

Installation du câble de partage du capot

AVERTISSEMENT **RISQUE D'ÉLECTROCUTION** Installez le capot de sécurité sur les connecteurs de partage de courant lors du flottage des bornes de sortie. Les bornes de partage seront au potentiel de flottage, qui ne peut pas dépasser les valeurs nominales d'isolation indiquées dans les tableaux de **caractéristiques**.

En raison du risque d'électrocution lors du contact avec les prises de connexion, vous devez installer le capot de sécurité avec le câble. Pour installer le câble dans le capot, vous devez débrancher l'un des connecteurs afin de passer les fils à travers le capot de sécurité.

Un noyau de ferrite est également fourni conformément à la norme CEM CEI61326-1. Le noyau de ferrite n'affecte pas la fonctionnalité de ce produit.

Les figures suivantes exposent en détails le câble de partage incorporé au capot de sécurité et le noyau de ferrite.



- Débranchez l'une des fiches de connecteur à 3 broches.
- Pour la réduction des interférences électromagnétiques, bouchez 4 fois le câble de partage à travers la ferrite (référéncé depuis l'intérieur du noyau). Chaque extrémité du câble de partage doit être dotée d'un noyau.
- Lors de l'utilisation de plusieurs câbles de partage, les deux câbles de partage doivent passer par le noyau. Reportez-vous au deuxième noyau sur la figure.
- Installez les capots de sécurité sur le câble de partage comme indiqué ci-dessus.
- Rebranchez le connecteur que vous avez retiré.
- Branchez le connecteur du câble de partager à l'arrière de l'appareil.
- Connectez le capot de sécurité à l'appareil.

Reportez-vous à la section **Connexions d'interface** pour plus d'informations sur la connexion du capot contre les décharges électrostatiques.

Connexions en série

Les connexions en série ne sont autorisées en aucune circonstance.

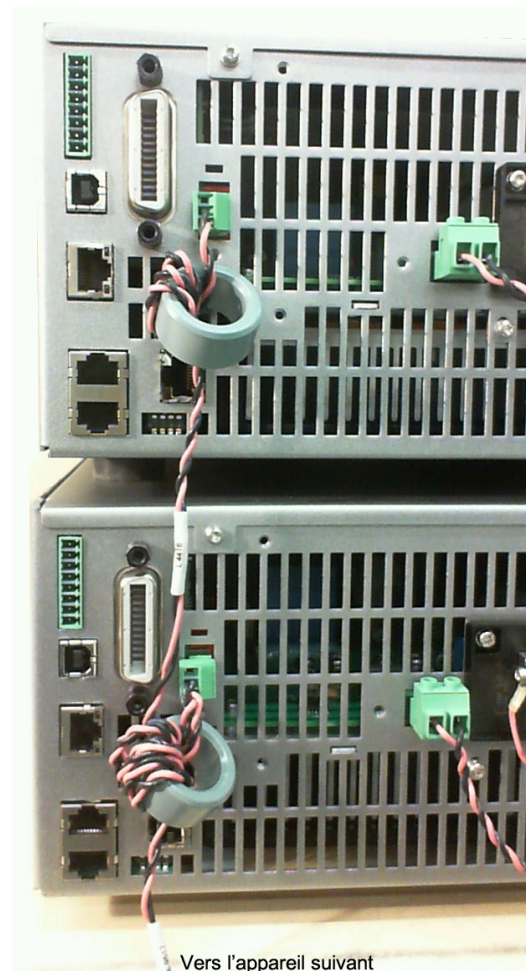

Les câbles sont illustrés sans capot pour plus de clarté.

2 Installation de l'instrument

AVERTISSEMENT

RISQUE D'ÉLECTROCUTION/TENSIONS LÉTHALES Les connexions en série ne sont pas autorisées pour de nombreuses raisons. L'une des principales raisons pour les modèles RP795xA et RP796xA, par exemple, est que les tensions flottantes ne peuvent pas dépasser les valeurs d'isolation données dans les tableaux de caractéristiques des modèles **RP795xA, RP796xA**.

Connexions de l'interface

Connexions GPIB

Connexions USB

Connexions réseau (LAN) - locales et privées

Connexions du port numérique

Installation du capot de l'interface

Cette section décrit la procédure à suivre pour connecter les diverses interfaces de communication à votre système RPS. Pour plus d'informations sur la configuration des interfaces de commande à distance, reportez-vous à la section [Configuration des interfaces de commande à distance](#).

Si ce n'est pas déjà fait, installez la dernière version de Keysight IO Libraries Suite à partir de www.keysight.com.

REMARQUE Pour plus d'informations sur les connexions des interfaces, reportez-vous au document Keysight Technologies USB/LAN/GPIB Interfaces Connectivity Guide (en anglais), fourni avec la suite Keysight IO Libraries.

Connexions GPIB

La figure ci-dessous illustre un système d'interface GPIB classique.

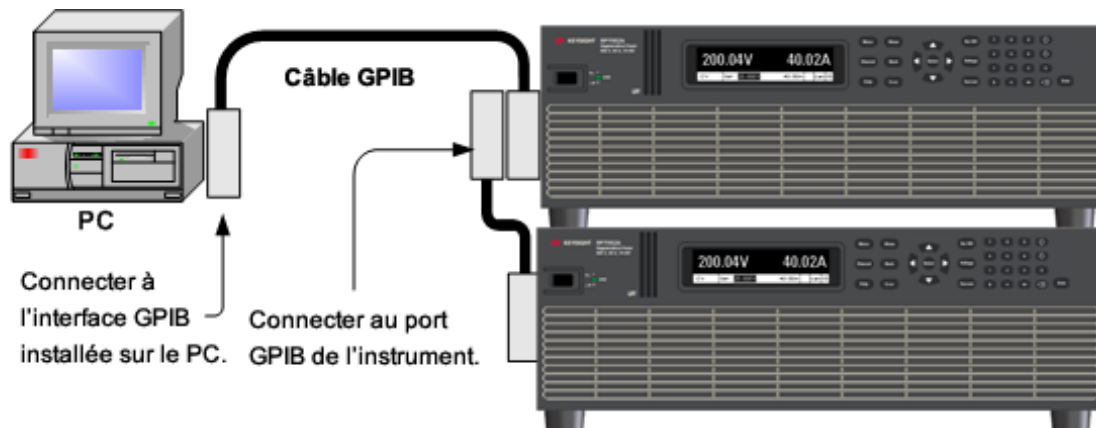

1. Branchez votre instrument à la carte d'interface GPIB à l'aide d'un câble GPIB.
2. Utilisez l'utilitaire Connection Expert de la suite Keysight IO Libraries Suite pour configurer les paramètres de la carte GPIB.
3. Vous pouvez désormais utiliser Interactive IO depuis l'utilitaire Connection Expert pour communiquer avec votre instrument, ou le programmer à l'aide des divers environnements de programmation.

Connexions USB

La figure ci-dessous illustre un système d'interface USB classique.

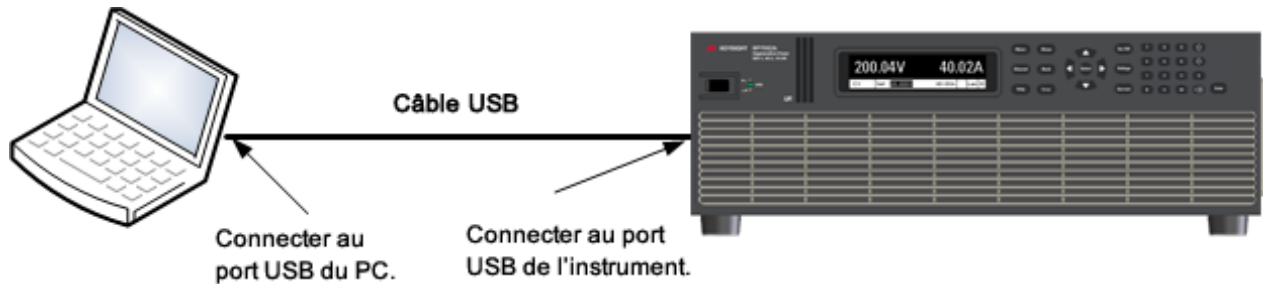

1. Branchez votre instrument au port USB de votre ordinateur.
2. Une fois l'utilitaire Connection Expert de la suite Keysight IO Libraries Suite exécuté, l'ordinateur reconnaît automatiquement l'instrument. Cette opération peut durer quelques secondes. Une fois l'instrument reconnu, votre ordinateur affiche l'alias VISA, la chaîne IDN et l'adresse VISA. Ces informations sont situées dans le dossier USB.
3. Vous pouvez désormais utiliser Interactive IO depuis l'utilitaire Connection Expert pour communiquer avec votre instrument, ou le programmer à l'aide des divers environnements de programmation.

Connexions réseau (LAN) - locales et privées

Un LAN de site est un réseau local dans lequel les instruments et les ordinateurs sont connectés au réseau au moyen de routeurs, de concentrateurs et/ou de commutateurs. Il s'agit habituellement de grands réseaux administrés de manière centralisée, avec des services tels que des serveurs DHCP et DNS. La figure ci-dessous illustre un système LAN de site classique.

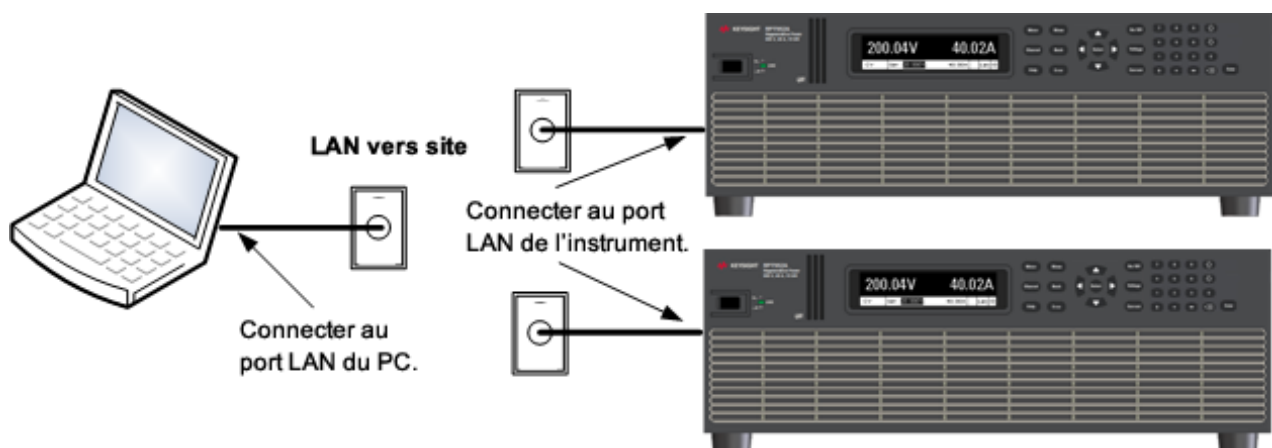

Un LAN privé est un réseau dans lequel les instruments et les ordinateurs sont reliés directement, et non branchés à un LAN de site. Il s'agit habituellement de petits réseaux, sans ressources administrées de manière centralisée. La figure ci-dessous illustre un système LAN privé classique.

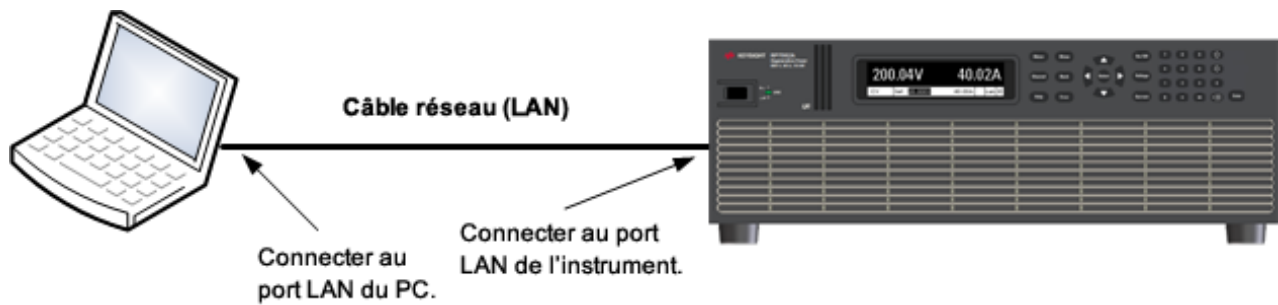

1. Branchez l'instrument au LAN de site ou à votre ordinateur à l'aide d'un câble LAN. Les paramètres LAN de l'instrument sont configurés en usine pour obtenir automatiquement une adresse IP du réseau à l'aide d'un serveur DHCP (DHCP est activé). Le serveur DHCP enregistre le nom d'hôte de l'instrument avec le serveur DNS dynamique. Le nom d'hôte ainsi que l'adresse IP permettent alors de communiquer avec l'instrument. Si vous utilisez un LAN privé, vous pouvez laisser tous les paramètres LAN tels quels. La plupart des produits Keysight et des ordinateurs choisissent automatiquement une adresse IP via l'option Auto-IP s'il n'existe pas de serveur DHCP. Chacun s'auto-attribue une adresse IP à partir du bloc 169.254.nnn. Le voyant **Lan** du panneau avant s'allume lorsque le port LAN a été configuré.
2. L'utilitaire Connection Expert de la Suite Keysight IO Libraries Suite permet d'ajouter les modèles RPS et de vérifier une connexion. Pour ajouter l'instrument, demandez à Connection Expert de le rechercher. Si l'instrument demeure introuvable, ajoutez-le à l'aide de son nom d'hôte et de son adresse IP.
3. Vous pouvez désormais utiliser Interactive IO depuis l'utilitaire Connection Expert pour communiquer avec votre instrument, ou le programmer à l'aide des divers environnements de programmation. Vous pouvez également utiliser le navigateur Web de votre ordinateur pour communiquer avec l'instrument comme décrit dans la section **Utilisation de l'interface Web**.

Connexions du port numérique

REMARQUE Il est recommandé d'un point de vue technique de torsader et de blinder tous les fils de signaux en direction et en provenance du connecteur numérique. Si les fils utilisés sont blindés, branchez uniquement une extrémité du blindage à la masse du châssis afin d'éviter les boucles de masse.

Un connecteur à 8 broches et une prise de déconnexion rapide sont fournis pour accéder aux fonctions du port numérique. Retirez la prise de connecteur avant de brancher les fils. Le bouchon accepte des fils de section comprise entre 1,5 mm² (AWG14) et 0,14 mm² (AWG 28). Il n'est pas recommandé d'utiliser des fils d'une section inférieure à 0,25 mm² (AWG 24). Dénudez 7 mm de l'isolation des fils.

2 Installation de l'instrument

1. Insertion des fils
2. Serrage des vis
3. Broches de défaillance/inhibition configurables (observer la polarité INH)
4. Broches de couplage de sorties configurables
5. Broches E/S numériques configurables
6. Commun des signaux

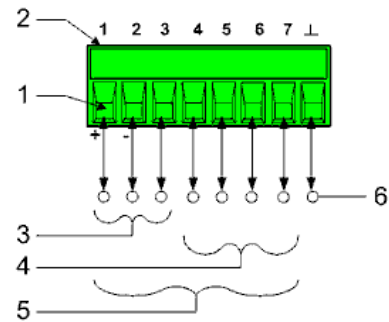

Pour plus d'informations sur l'utilisation du port numérique, reportez-vous à section **Programmation du port numérique**. Les caractéristiques électriques sont décrites dans les tableaux des caractéristiques communes de **RP793xA**, **RP794xA** et **RP795xA**, **RP796xA**.

Installation du capot de l'interface

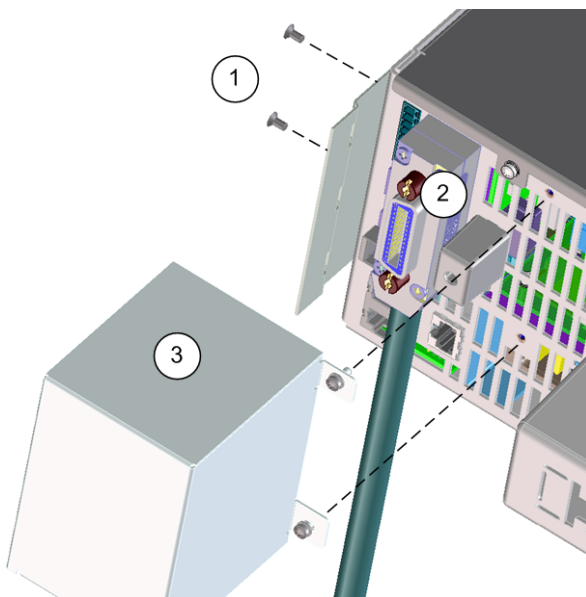

Le capot et le matériel protégeant contre les décharges électrostatiques sont livrés avec l'appareil (voir les **Éléments fournis**).

1. Branchez la bride du capot sur le côté de l'instrument à l'aide des deux vis fournies. **IMPORTANT** : ceci doit être effectué *avant* le montage en baie de l'appareil.
2. Branchez le câble LAN, USB ou GPIB (illustration du GPIB) au connecteur approprié du panneau arrière.
3. Installez le capot contre les décharges électrostatiques à l'arrière de l'appareil à l'aide des deux vis. Assurez-vous que le capot est inséré dans la bride.

3

Mise en route

Utilisation du panneau avant

Configuration de l'interface de commande à distance

Utilisation du panneau avant

Mise sous tension de l'appareil

Définition de la tension de sortie

Définition du courant de sortie

Définition de la protection contre les surtensions

Activation de la sortie

Utilisation du système d'aide intégrée

Mise sous tension de l'appareil

AVERTISSEMENT

RISQUE D'ÉLECTROCUTION, TENSION LÉTALES De nombreux modèles génèrent des tensions supérieures à 60 V CC, certains modèles ayant une tension nominale de 950 V CC ! Assurez-vous que toutes les connexions des instruments, le câblage de charge et les connexions de charge sont isolés ou recouverts à l'aide des capots de sécurité fournis, de sorte qu'aucun contact accidentel avec des tensions létales ne peut se produire.

Vérifiez que le cordon d'alimentation est branché.

Mettez l'appareil sous tension à l'aide de l'interrupteur du panneau avant. Après quelques secondes, l'écran du panneau avant s'allume. Un autotest de mise sous tension est effectué automatiquement dès la mise sous tension de l'appareil. Il certifie que le bloc d'alimentation est opérationnel.



REMARQUE

Un délai approximatif de 30 secondes peut être nécessaire pour que le bloc d'alimentation soit initialisé et prêt à être utilisé.

Si l'instrument ne s'allume pas, vérifiez que le cordon d'alimentation est solidement branché (la tension secteur est automatiquement détectée à la mise sous tension). Vérifiez également que l'instrument est connecté à une source d'alimentation sous tension. Si le voyant en regard de l'interrupteur d'alimentation est éteint, la tension secteur est absente. Si le voyant est orange, l'instrument est alimenté en courant secteur et en veille ; s'il est vert, l'instrument est en service.

REMARQUE

Si une erreur d'autotest se produit, un message s'affiche sur le panneau avant. Pour connaître d'autres erreurs d'autotest, reportez-vous à la section **Maintenance et réparation** pour obtenir des instructions sur le retour de l'instrument en vue de son entretien.

Définition de la tension de sortie

Méthode 1

Utilisez les touches de navigation vers la gauche et vers la droite pour accéder au paramètre à modifier.

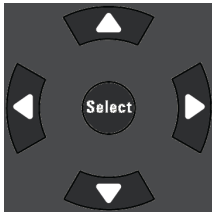

Sur l'écran suivant, le réglage de tension est sélectionné. Saisissez une valeur à l'aide du pavé numérique. Appuyez ensuite sur **Select**.



Vous pouvez également utiliser les touches numériques pour augmenter ou réduire la valeur. Les valeurs deviennent effectives lorsque la sortie est activée.

En mode de priorité de tension, l'appareil maintient la tension de sortie à sa valeur programmée. En mode de priorité de courant, l'appareil limite la tension de sortie lorsqu'il atteint la valeur limite de tension spécifiée. Pour plus d'informations, reportez-vous à la section **Définir le mode de sortie**.

Méthode 2

Utilisez la touche **Voltage** pour sélectionner le champ d'entrée de la tension. Sur l'écran ci-dessous, le réglage de tension est sélectionné. Entrez le paramètre désiré à l'aide du clavier numérique. Appuyez ensuite sur **Enter**.



En cas d'erreur, appuyez sur la touche de retour arrière pour effacer le nombre, sur Back pour quitter le menu ou sur Meter pour revenir au mode multimètre.

Définition du courant de sortie

Méthode 1

Utilisez les touches de navigation vers la gauche et vers la droite pour accéder au paramètre à modifier.

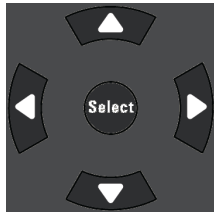

Le réglage de courant est sélectionné dans l'écran ci-dessous. Utilisez les touches de navigation haut/bas pour basculer entre les entrées limites + et -. Saisissez une valeur à l'aide du pavé numérique. Appuyez ensuite sur **Select**.



Vous pouvez également utiliser les touches numériques pour augmenter ou réduire la valeur. Vous pouvez définir des valeurs de courant positives et négatives. Les valeurs deviennent effectives lorsque la sortie est activée.

En mode de priorité de courant, l'appareil maintient le courant de sortie à sa valeur programmée. En mode de priorité de tension, l'appareil limite le courant de sortie lorsqu'il atteint la valeur limite de courant spécifiée. Pour plus d'informations, reportez-vous à la section **Définir le mode de sortie**.

Méthode 2

Utilisez la touche **Current** pour sélectionner le champ d'entrée du courant. Le réglage de courant est sélectionné dans l'écran ci-dessous. Entrez le paramètre désiré à l'aide du clavier numérique. Appuyez ensuite sur **Enter**.

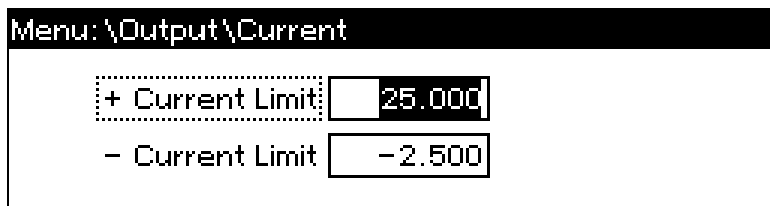

En cas d'erreur, appuyez sur la touche de retour arrière pour effacer le nombre, sur Back pour quitter le menu ou sur Meter pour revenir au mode multimètre.

Définition de la protection contre les surtensions

Utilisation du menu du panneau avant

Le menu de commandes du panneau avant vous permet d'accéder à la plupart des fonctions de l'instrument. Les commandes de fonctions réelles sont situées au niveau le plus bas du menu. En résumé :

- Appuyez sur la touche **Menu** pour accéder au menu des commandes.
- Appuyez sur les touches de navigation vers la gauche et vers la droite (<, >) pour parcourir les commandes du menu.
- Appuyez sur la touche centrale **Select** pour sélectionner une commande et passer au niveau suivant du menu.
- Appuyez sur la touche **Help** située au niveau le plus bas du menu pour afficher des informations d'aide relatives aux commandes des fonctions.
- Pour quitter le menu des commandes, appuyez sur la touche **Meter** pour retourner immédiatement au mode multimètre, ou sur la touche **Menu** pour retourner au niveau supérieur.

Pour un plan des commandes du menu du panneau avant, reportez-vous à la section **Aide-mémoire des menus du panneau avant**.

Exemple de menu - réglage de la protection contre les surtensions.

Appuyez sur la touche **Menu** pour accéder au menu des commandes du panneau avant. La première ligne identifie le chemin d'accès au menu. Lorsque vous accédez pour la première fois au menu, il s'affiche en haut ou en bas de l'écran et le chemin d'accès est vide. La deuxième ligne indique les commandes disponibles au niveau présent du menu. Dans le cas présent, les commandes du niveau supérieur du menu sont présentées, avec la commande Output en surbrillance. La troisième ligne indique les commandes disponibles sous la commande Output. S'il n'existe aucune commande de niveau inférieur, une brève description de la commande en surbrillance s'affiche.

```
Menu: \
Output Measure Transient Protect States System
Voltage, Current, Mode, Sequence, Advanced
```

Appuyez sur la touche de navigation vers la droite > pour parcourir le menu jusqu'à ce que la commande Protect soit mise en surbrillance. Appuyez sur la touche **Select** pour accéder aux commandes Protect.

```
Menu: \
Output Measure Transient Protect States System
OVP, UVP, OCP, Inhibit, WDog, Clear
```

3 Mise en route

Étant donné que la commande OVP est déjà mise en surbrillance, appuyez sur la touche **Select** pour accéder à la boîte de dialogue OVP.

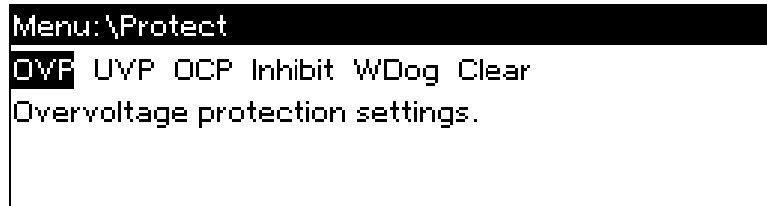

Le réglage OVP par défaut pour ce modèle est 600 V. Vous pouvez le modifier à l'aide du clavier numérique et en appuyant sur les touches **Enter** et **Select**. Appuyez sur la touche **Meter** pour retourner à la vue du multimètre.



Activation de la sortie

Activez la sortie à l'aide de la touche **On/Off**. Si une charge est connectée à la sortie, l'écran du panneau avant indiquera qu'un courant est débité. Autrement, la lecture du courant sera nulle. Le voyant d'état indique l'état de la sortie. Dans ce cas, « CV » indique que la sortie est en mode de tension constante.



Pour une description des voyants d'état, reportez-vous à la section [Présentation succincte de l'écran du panneau avant](#).

Utilisation du système d'aide intégrée

Au niveau le plus bas du menu, appuyez sur la touche **Help** pour afficher les informations d'aide relatives aux commandes des fonctions du menu.

Lorsqu'une limite est dépassée ou qu'une autre configuration incorrecte est détectée, l'instrument affiche un message, et notamment des informations sur le code d'erreur.

Appuyez sur **Meter** ou sur **Back** pour quitter l'aide.

Configuration de l'interface de commande à distance

Configuration USB

Configuration GPIB

Configuration LAN

Modification des paramètres LAN

Utilisation de l'interface Web

Utilisation de Telnet

Utilisation de sockets

Verrouillage de l'interface

Introduction

Cet instrument prend en charge les communications par interface de commande à distance sur 3 interfaces : GPIB, USB et LAN. Ces trois interfaces sont actives à la mise sous tension. Pour utiliser les interfaces, vous devez commencer par installer la dernière suite logicielle Keysight IO Libraries Suite, disponible à l'adresse www.keysight.com. Branchez ensuite l'instrument à votre ordinateur.

Le voyant **IO** du panneau avant s'allume chaque fois qu'il y a une activité sur les interfaces de commande à distance. Le voyant **Lan** du panneau avant s'allume lorsque le port LAN est connecté et configuré.

Cet instrument assure la surveillance de la connexion Ethernet. Le port LAN de l'instrument est ainsi surveillé de manière continue, et reconfiguré automatiquement lorsque l'instrument est débranché pendant plus de 20 secondes puis rebranché au secteur.

Configuration USB

Les paramètres USB ne peuvent pas être configurés. Vous pouvez extraire la chaîne de connexion USB via le menu du panneau avant :

Aide-mémoire des menus du panneau avant	Commande SCPI
Sélectionnez System\IO\USB .	Non disponible
La boîte de dialogue affiche la chaîne de connexion USB.	

Configuration GPIB

Chaque périphérique connecté à l'interface GPIB (IEEE-488) doit avoir une adresse unique comprise entre 0 et 30. L'instrument est livré avec une adresse définie à 5. L'adresse de la carte d'interface GPIB

3 Mise en route

de votre ordinateur ne doit pas entrer en conflit avec un instrument sur le bus d'interface. Ce paramètre est non volatile ; une coupure/rétablissement de l'alimentation ou la commande *RST ne le modifie pas. Utilisez le menu du panneau avant pour modifier l'adresse GPIB :

Aide-mémoire des menus du panneau avant	Commande SCPI
Sélectionnez System\IO\GPIB . Saisissez une nouvelle valeur comprise entre 0 et 30 à l'aide du clavier numérique. Appuyez ensuite sur Enter .	Non disponible

Configuration LAN

Les paragraphes suivants décrivent les fonctions de base de configuration du réseau local via les menus du panneau avant. Notez qu'il n'existe aucune commande SCPI pour configurer les paramètres du réseau local. L'intégralité de la configuration du LAN doit être effectuée à partir du panneau avant.

REMARQUE Après avoir modifié les paramètres du LAN, vous devez enregistrer les modifications. Sélectionnez : **System\IO\LAN\Apply**. Sélectionnez Apply pour activer les paramètres. Les paramètres du LAN ne sont pas volatiles. Ils ne sont pas modifiés après une remise sous tension ou la commande *RST. Si vous ne souhaitez pas enregistrer les modifications, sélectionnez : **System\IO\LAN\Cancel**. La sélection de l'option Cancel entraîne l'annulation de toutes les modifications.

Par défaut, le protocole DHCP est activé pour permettre les communications sur un réseau local. L'acronyme DHCP signifie Dynamic Host Configuration Protocol ; il s'agit d'un protocole d'attribution d'adresses IP dynamiques à des périphériques sur un réseau. Avec l'adressage dynamique, un périphérique peut avoir une adresse IP différente chaque fois qu'il se connecte au réseau.

Affichage des paramètres actifs

Pour afficher les paramètres du réseau local actuellement activés :

Aide-mémoire des menus du panneau avant	Commande SCPI
Sélectionnez System\IO\LAN\Settings . Affiche les paramètres LAN actifs. Parcourez la liste à l'aide des touches fléchées haut/bas.	Non disponible

Les paramètres actuellement actifs de l'adresse IP, du masque de sous-réseau et de la passerelle par défaut peuvent être différents de ceux du menu de configuration du panneau avant, selon la configuration du réseau. Les paramètres sont différents lorsque le réseau a affecté les siens automatiquement.

Réinitialisation du réseau local

La réinitialisation du LAN effectue une réinitialisation LAN Configuration Initialize (LCI) de l'instrument qui active le DHCP, DNS et ping. Cela réinitialise également le mot de passe du site Web avec le mot

de passe par défaut d'usine. Cela ne réinitialise pas le nom d'hôte ou le nom du service mDNS.

Vous pouvez également rétablir les paramètres (par défaut) configurés en usine du LAN. Cela permet de rétablir les valeurs configurées en usine de **TOUS** les paramètres du LAN et de redémarrer le réseau. Tous les paramètres par défaut du LAN sont répertoriés dans la section **Paramètres non volatiles**.

Aide-mémoire des menus du panneau avant	Commande SCPI
Sélectionnez System\IO\LAN\Reset	Non disponible
Sélectionnez System\IO\LAN\Defaults	
Cette option permet d'activer les paramètres de LAN sélectionnés et de redémarrer le réseau.	

Modification des paramètres LAN

Adresse IP

Sélectionnez une adresse IP pour configurer l'adressage de l'instrument. Appuyez sur la touche **Menu**, puis sélectionnez **System\IO\LAN\Config\IP**. Les paramètres suivants peuvent être configurés :

Aide-mémoire des menus du panneau avant	Commande SCPI
Sélectionnez System\IO\LAN\Modify\IP	Non disponible
Sélectionnez Auto ou Manual. Pour une description complète, voir ci-dessous.	

- **Auto** : permet de configurer automatiquement l'adressage de l'instrument. Lorsqu'il est sélectionné, l'instrument tente d'abord d'obtenir une adresse IP auprès d'un serveur DHCP. Si un serveur DHCP est détecté, celui-ci affecte une adresse IP, un masque de sous-réseau et une passerelle par défaut à l'instrument. En l'absence de serveur DHCP, l'instrument tente d'abord d'obtenir une adresse IP via la fonction AutoIP. AutoIP affecte automatiquement une adresse IP, un masque de sous-réseau et des adresses de passerelles par défaut sur les réseaux qui n'ont pas de serveur DHCP.
- **Manual** : vous permet de configurer manuellement l'adressage de l'instrument en saisissant des valeurs dans les trois champs suivants. Ces champs ne sont visibles que si l'option Manuel est sélectionnée.
- **IP Address** : ce paramètre correspond à l'adresse IP (Internet Protocol) de l'instrument. Une adresse IP est nécessaire pour toutes les communications IP et TCP/IP avec l'instrument. Une adresse IP comporte 4 nombres décimaux séparés par des points. Chaque nombre décimal est compris entre 0 et 255 et ne contient aucun zéro initial (par exemple, 169.254.2.20).

3 Mise en route

- **Subnet Mask** : ce paramètre permet à l'instrument de déterminer si l'adresse IP d'un client se trouve sur le même sous-réseau local. La même notation de numérotation s'applique à l'adresse IP. Lorsque l'adresse IP d'un client se trouve sur un sous-réseau différent, tous les paquets doivent être envoyés à la passerelle par défaut.
- **DEF Gateway** : ce paramètre correspond à l'adresse IP de la passerelle par défaut qui permet à l'instrument de communiquer avec des systèmes qui ne se trouvent pas sur le sous-réseau local, comme indiqué par le réglage du masque de sous-réseau. La même notation de numérotation s'applique à l'adresse IP. La valeur 0.0.0.0 indique qu'aucune passerelle par défaut n'est définie.

Les adresses notées par points (« nnn.nnn.nnn.nnn » où « nnn » est la valeur d'un octet comprise entre 0 et 255) doivent être soigneusement exprimées du fait que la plupart des logiciels des PC interprètent les octets avec des zéros initiaux comme des nombres en base 8. Par exemple, « 192.168.020.011 » est équivalent à la notation décimale « 192.168.16.9 » car « .020 » est interprété comme « 16 » en base 8 et « .011 » comme « 9 ». Pour éviter toute confusion, utilisez uniquement des valeurs décimales comprises entre 0 et 255 sans zéro d'en-tête.

Nom d'hôte

Un nom d'hôte est la partie hôte du nom du domaine qui est traduite en adresse IP. Pour configurer le nom d'hôte de l'instrument :

Aide-mémoire des menus du panneau avant	Commande SCPI
Sélectionnez System\IO\LAN\ModifyName	Non disponible
Vous pouvez saisir une valeur sur le clavier numérique. Pour des caractères supplémentaires, saisissez un caractère alphanumérique à l'aide des touches de navigation haut/bas en parcourant la liste de sélection qui s'affiche lorsque vous appuyez sur les touches. Pour parcourir le champ de texte, utilisez les touches de navigation gauche/droite. Pour supprimer une valeur, utilisez la touche de retour. Appuyez sur Enter une fois l'opération terminée.	

Host Name : ce champ enregistre le nom fourni avec le service de désignation sélectionné. Si ce champ reste vide, aucun nom n'est enregistré. Un nom d'hôte peut contenir des lettres majuscules et minuscules, des nombres et des traits d'union (-). La longueur maximale est de 15 caractères.

Chaque instrument est livré avec un nom d'hôte par défaut au format suivant : K-numérodemodelé-numérodésérie, où numérodemodelé représente le numéro de modèle de l'appareil principal à 7 caractères (par exemple, RP7951A), et numérodésérie correspond aux cinq derniers caractères du numéro de série à 10 caractères situé sur l'étiquette placée au-dessus de l'appareil (par exemple, 45678 si le numéro de série est MY12345678).

Serveur DNS

DNS est un service Internet qui traduit les noms de domaine en adresses IP. Il est également nécessaire pour que l'instrument recherche et affiche le nom d'hôte que le réseau lui a attribué. Normalement, DHCP recherche l'adresse DNS ; il vous suffit d'indiquer si le protocole DHCP est inutilisé ou non fonctionnel.

Pour configurer manuellement les services DNS :

Aide-mémoire des menus du panneau avant	Commande SCPI
Sélectionnez System\IO\LAN\Modify\DNS	Non disponible
Sélectionnez Primary Address ou Secondary Address. Pour une description complète, voir ci-dessous.	

- **Primary Address** : ce champ indique l'adresse principale du serveur. Pour plus d'informations sur le serveur, contactez votre administrateur réseau. La même notation de numérotation s'applique à l'adresse IP. La valeur 0.0.0.0 indique qu'aucun serveur par défaut n'est défini.
- **Secondary Address** : ce champ indique l'adresse secondaire du serveur. Pour plus d'informations sur le serveur, contactez votre administrateur réseau. La même notation de numérotation s'applique à l'adresse IP. La valeur 0.0.0.0 indique qu'aucun serveur par défaut n'est défini.

Les adresses notées par points (« nnn.nnn.nnn.nnn » où « nnn » est la valeur d'un octet comprise entre 0 et 255) doivent être soigneusement exprimées du fait que la plupart des logiciels des PC interprètent les octets avec des zéros initiaux comme des nombres en base 8. Par exemple, « 192.168.020.011 » est équivalent à la notation décimale « 192.168.16.9 » car « .020 » est interprété comme « 16 » en base 8 et « .011 » comme « 9 ». Pour éviter toute confusion, utilisez uniquement des valeurs décimales comprises entre 0 et 255 sans zéro d'en-tête.

Nom du service mDNS

Le nom du service mDNS est enregistré avec le service de désignation sélectionné. Pour configurer le nom du service mDNS de l'instrument :

Aide-mémoire des menus du panneau avant	Commande SCPI
Sélectionnez System\IO\LAN\Modify\mDNS	Non disponible
<p>Vous pouvez saisir une valeur sur le clavier numérique. Pour des caractères supplémentaires, saisissez un caractère alphanumérique à l'aide des touches de navigation haut/bas en parcourant la liste de sélection qui s'affiche lorsque vous appuyez sur les touches.</p> <p>Pour parcourir le champ de texte, utilisez les touches de navigation gauche/droite. Pour supprimer une valeur, utilisez la touche de retour. Appuyez sur Enter une fois l'opération terminée.</p>	

- **mDNS Service Name** : ce champ enregistre le nom du service avec le service de désignation sélectionné. Si ce champ reste vide, aucun nom n'est enregistré. Un nom de service peut contenir des lettres majuscules et minuscules, des nombres et des traits d'union (-).
- Chaque instrument est livré avec un nom de service par défaut au format suivant : Keysight-numérodemodelle-numérodésérie, où numérodemodelle représente le numéro de modèle de l'appareil principal à 7 caractères (par exemple, RP7951A), description représente la description et numérodésérie correspond au numéro de série à 10 caractères situé sur l'étiquette placée au-dessus de l'appareil (par exemple, MY12345678).

Services

Cette option permet de sélectionner les services LAN à activer ou désactiver.

Aide-mémoire des menus du panneau avant	Commande SCPI
Sélectionnez System\IO\LAN\Modify\Services	Non disponible
Cochez ou désélectionnez les cases correspondant aux services que vous souhaitez activer ou désactiver.	

- Les services pouvant être configurés sont : VXI-11, Telnet, Contrôle Web, Sockets, mDNS et HiSLIP.
- Vous devez activer Web Control si vous souhaitez contrôler à distance votre instrument via son interface Web intégrée.

Utilisation de l'interface Web

Le système RPS comprend une interface Web intégrée qui vous permet de le contrôler directement depuis le navigateur Web de votre ordinateur. Grâce à cette interface, vous pouvez accéder aux fonctions des commandes du panneau avant, notamment aux paramètres de configuration du réseau local. Jusqu'à six connexions simultanées sont autorisées. En cas de connexions supplémentaires, les performances seraient réduites.

REMARQUE L'interface Web intégrée ne fonctionne que sur le réseau local. Un navigateur Web est requis pour utiliser l'interface Web.

L'interface Web est activée lors de la livraison de l'appareil. Pour lancer l'interface Web :

1. Ouvrez le navigateur Web de votre ordinateur.
2. Saisissez le nom d'hôte ou l'adresse IP dans le champ d'adresse du navigateur. La page d'accueil suivante apparaît.
3. Cliquez sur l'onglet « Web Control » en haut de la page pour commencer à commander votre instrument.
4. Pour obtenir une aide supplémentaire sur l'une des pages, cliquez sur ?.

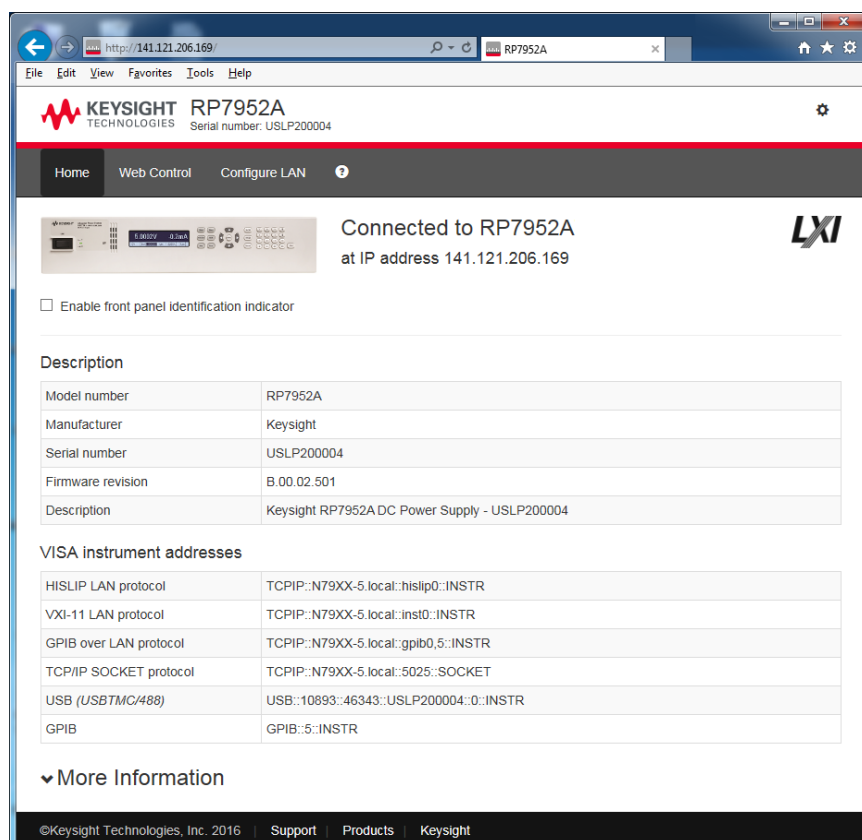

Si vous le désirez, vous pouvez restreindre l'accès à l'interface Web à l'aide d'une protection par mot de passe. Par défaut, aucun mot de passe n'est défini. Pour définir un mot de passe, cliquez sur l'icône d'engrenage. Pour plus d'informations sur la définition d'un mot de passe, consultez l'aide en ligne.

Utilisation de Telnet

Dans une fenêtre d'invite de commandes MS-DOS, saisissez : telnet nom_hôte 5024 où nom_hôte représente le nom d'hôte ou l'adresse IP du RPS et 5024 le port telnet de l'instrument.

Vous devriez obtenir une fenêtre de session Telnet dont le titre indique que vous êtes connecté au bloc d'alimentation. Saisissez les commandes SCPI à l'invite.

Utilisation de sockets

REMARQUE Les blocs d'alimentation acceptent toute combinaison d'un maximum de six connexions par socket de données, socket de contrôle et telnet.

Les instruments Keysight ont normalisé l'utilisation du port 5025 pour les services de sockets SCPI. Un socket de données sur ce port permet d'émettre ou de recevoir des commandes, des demandes et des réponses ASCII/SCPI. Toutes les commandes doivent se terminer par une nouvelle ligne pour le message à traiter. Toutes les réponses doivent également se terminer par une nouvelle ligne.

L'interface de programmation par sockets permet en outre une connexion par socket de contrôle. Le socket de contrôle permet aux clients d'envoyer des commandes Device Clear et de recevoir des

3 Mise en route

demandes de service. Contrairement au socket de données, qui utilise un numéro de port fixe, le numéro de socket de contrôle varie et doit être obtenu en envoyant la demande SCPI suivante au socket de données : **SYSTem:COMMunicate:TCPIp:CONTRol?**

Après avoir obtenu le numéro de port, ouvrez une connexion par socket de contrôle. Comme avec le socket de données, toutes les commandes envoyées au socket de contrôle doivent se terminer par une nouvelle ligne, et toutes les réponses renvoyées par le socket de contrôle sont terminées par une nouvelle ligne.

Pour envoyer une commande Device Clear, envoyez la chaîne « DCL » au socket de contrôle. Lorsque le système d'alimentation a terminé l'exécution de la commande Device Clear, il renvoie la chaîne « DCL » au socket de contrôle.

Les demandes de service sont activées pour les sockets de contrôle à l'aide du registre d'activation des demandes de service. Dès que les demandes de service ont été activées, le programme client écoute la connexion de contrôle. Lorsque SRQ devient vrai, l'instrument envoie la chaîne « SRQ +nn » au client. « nn » représente la valeur de l'octet d'état, que le client peut utiliser pour déterminer la source de la demande de service.

Verrouillage de l'interface

L'interface USB, l'interface LAN et le serveur Web sont activés lors de la livraison. Pour activer ou désactiver les interfaces à partir du panneau avant :

Aide-mémoire des menus du panneau avant	Commande SCPI
Sélectionnez System\Admin\IO	Non disponible
Activez ou désactivez les interfaces en cochant ou en désélectionnant les cases suivantes :	
Enable LAN, Enable GPIB et Enable USB	

Si le menu Admin est inaccessible, il est probablement protégé par un mot de passe.

4

Utilisation du système d'alimentations régénératrices

Programmation de la sortie

Fonctionnement en parallèle

Utilisation de la fonction d'absorption de courant

Programmation de la protection des sorties

Programmation des transitoires de sortie

Séquencement de la sortie

Réalisation de mesures

Enregistrement de données externe

Programmation du port numérique

Opérations système

Didacticiel du mode de priorité

Programmation de la sortie

Définir le mode de priorité de sortie

Définition de la tension de sortie

Définition du courant de sortie

Définir la vitesse de balayage

Définir la résistance de sortie

Définir la bande passante de sortie - RP795xA, RP796xA

Définir la bande passante de sortie - RP793xA, RP794xA

Régler le mode d'activation/désactivation de la sortie - RP793xA, RP794xA

Activation de la sortie

AVERTISSEMENT

RISQUE D'ÉLECTROCUTION, TENSION LÉTALES De nombreux modèles génèrent des tensions supérieures à 60 V CC, certains modèles ayant une tension nominale de 950 V CC ! Assurez-vous que toutes les connexions des instruments, le câblage de charge et les connexions de charge sont isolés ou recouverts à l'aide des capots de sécurité fournis, de sorte qu'aucun contact accidentel avec des tensions létales ne peut se produire.

REMARQUE

Lors de la mise sous tension initiale du système RPS, l'instrument peut mettre environ 30 secondes à démarrer avant d'être prêt.

Définir le mode de priorité de sortie

Sélectionnez le mode de priorité de tension ou de courant. Pour plus d'informations, reportez-vous à la section [Utilisation du mode de priorité](#).

Le mode **Voltage priority (Priorité de tension)** maintient la tension de sortie à une valeur constante. La tension de sortie conserve sa valeur programmée à condition que le courant de charge soit inférieur aux limites de courant + ou -.

Le mode **Priorité de courant** maintient le courant de sortie à une valeur constante. Le courant de sortie conserve sa valeur programmée à condition que le courant de charge soit inférieur au réglage de la limite de courant.

Aide-mémoire des menus du panneau avant	Commande SCPI
Sélectionnez Output\Mode .	Pour spécifier le mode de priorité de courant ou de tension :
Sélectionnez Voltage priority ou Current priority.	FUNC CURR VOLT
Appuyez ensuite sur Select .	

REMARQUE

Lors du basculement entre les modes de priorité de tension et de priorité de courant, la sortie est désactivée et les réglages de sortie retournent à leurs valeurs indiquées à la mise sous tension ou après l'exécution de la commande RST.

Définition de la tension de sortie

Lorsque l'appareil fonctionne en mode de priorité de tension, la tension de sortie conserve sa valeur programmée dès lors que le courant de charge est inférieur à sa limite positive ou négative programmée.

Aide-mémoire des menus du panneau avant	Commande SCPI
Appuyez sur la touche Voltage . Saisissez une valeur et appuyez sur Select .	Pour régler la tension de sortie sur 400 volts : VOLT 400

Si l'appareil est en mode de priorité de courant, vous pouvez spécifier une limite de tension qui limite la tension de sortie à la valeur indiquée. Le courant de sortie conserve sa valeur programmée à condition que le courant de charge soit inférieur au réglage de la limite de courant.

Aide-mémoire des menus du panneau avant	Commande SCPI
Appuyez sur la touche Voltage . Spécifiez une limite de tension +. Appuyez ensuite sur Select .	Pour régler la limite de tension : VOLT:LIM 420

Définir la limite de sous-tension

REMARQUE

Ces informations s'appliquent uniquement aux modèles RP793xA et RP794xA seulement. **RP793xA, RP794xA**

Définit la limite de sous-tension en mode de priorité de courant. Ceci permet d'éviter que la tension ne descende en dessous de la limite de sous-tension lors du déchargement d'une batterie. Lorsque la limite de sous-tension est atteinte, l'appareil passe du mode de priorité de courant au mode de priorité de tension, ce qui arrête le déchargement de la batterie. La limite de sous-tension est annoncée par le bit d'état **UV**.

Notez que la limite de sous-tension empêche également la sortie de se mettre en marche lorsque la tension de sortie est inférieure à la limite de sous-tension programmée. Si vous avez besoin d'activer la sortie, vous devez d'abord définir la limite de sous-tension à zéro.

Aide-mémoire des menus du panneau avant	Commande SCPI
Appuyez sur la touche Voltage . Le champ Low Voltage Limit n'apparaît que lorsque l'appareil est réglé pour fonctionner en mode Priorité du courant. Spécifiez la limite de sous-tension. Appuyez ensuite sur Select .	Pour définir la limite de sous-tension : VOLT:LIM:LOW 4

Définition du courant de sortie

Lorsque l'appareil est configuré en mode de priorité de tension, vous pouvez spécifier une limite de courant positive ou négative, qui limite le courant de sortie à la valeur indiquée.

Aide-mémoire des menus du panneau avant	Commande SCPI
Appuyez sur la touche Current .	Pour régler la limite de courant positive : CURR:LIM
Spécifiez une limite de courant positive ou négative.	12
Appuyez ensuite sur Select .	Pour régler la limite de courant négative : CURR:LIM:NEG -3

Lorsque l'appareil fonctionne en mode de priorité de courant, vous pouvez spécifier un niveau de courant de sortie positif ou négatif, qui ne change pas dès lors que la tension de sortie est inférieure à sa limite programmée.

Aide-mémoire des menus du panneau avant	Commande SCPI
Appuyez sur la touche Current .	Pour régler le courant sur +5 ampères : CURR 5
Saisissez une valeur positive ou négative. Appuyez ensuite sur Select .	Pour régler le courant sur -5 ampères : CURR - 5

Définir la vitesse de balayage

La vitesse de balayage de tension détermine la vitesse à laquelle la tension passe à une nouvelle valeur. Cela ne s'applique qu'aux réglages de tension lorsque l'appareil fonctionne en mode de priorité de tension. Lorsqu'elle est définie sur MAXimum, INFINITY ou une valeur très élevée, la vitesse de balayage est limitée par la vitesse de programmation et la bande passante indiquées de l'appareil. Ce réglage permet d'éviter toute transition vers la limite de courant pendant la programmation amont et aval des charges capacitives ou de limiter la réponse de programmation à une vitesse contrôlée. Utilisez l'équation suivante pour calculer la vitesse de balayage limite maximale afin d'assurer des performances de programmation amont et aval linéaires et régulières.

Vitesse de balayage max. (V/s) = (limite de courant (A) – courant de charge (A))/(capacité de charge (F))

La vitesse de balayage de courant détermine la vitesse à laquelle le courant passe à une nouvelle valeur programmée. Cela ne s'applique qu'aux réglages de courant lorsque l'appareil fonctionne en mode de priorité du courant. Lorsqu'elle est définie sur MAXimum, INFINITY ou une valeur très élevée, la vitesse de balayage est limitée par la vitesse de programmation et la bande passante indiquées de l'appareil.

Aide-mémoire des menus du panneau avant	Commande SCPI
---	---------------

Sélectionnez Output\Advanced\Slew .	Pour régler la vitesse de balayage de tension sur 5 V/s
Sélectionnez ensuite Voltage ou Current.	VOLT:SLEW 5
Entrez la vitesse de balayage de tension ou de courant dans le champ Slew Rate (Vitesse de balayage).	Pour régler la vitesse de balayage de courant sur 1 A/s
Cochez la case Max slew rate (Vitesse de balayage max.) pour programmer la vitesse maximale.	CURR:SLEW 1
	Pour régler la vitesse de balayage maximale :
	VOLT:SLEW MAX

Définir la résistance de sortie

REMARQUE Nécessite la version du microprogramme B.03.02.1232 et supérieure pour les modèles RP793xA et RP794xA.

La programmation de résistance de sortie est principalement utilisée dans les applications de test de batteries et ne s'applique qu'en mode de priorité de tension. On l'utilise pour émuler la résistance interne d'une source de tension non idéale, telle qu'une batterie. Les valeurs sont programmées en ohms.

Reportez-vous aux tableaux de caractéristiques des modèles **RP793xA**, **RP794xA** et **RP795xA**, **RP796xA** pour les plages de programmation de résistance spécifiques au modèle.

Aide-mémoire des menus du panneau avant	Commande SCPI
Sélectionnez Output\Advanced\Resistance .	Pour sélectionner une résistance de 0,5 ohms :
Indiquez une valeur de résistance de sortie. Cochez ensuite la case Enable (Activer) . Appuyez ensuite sur Select .	VOLT:RES 0.5
	Pour activer la résistance de sortie :
	VOLT:RES:STAT ON

REMARQUE Lorsque les appareils sont connectés en parallèle, la résistance de sortie programmable est réduite. La résistance de sortie programmable pour un seul appareil doit être divisée par le nombre total d'appareils connectés en parallèle.

Définir la bande passante de sortie - RP795xA, RP796xA

REMARQUE Ces informations s'appliquent uniquement aux modèles RP795xA et RP796xA seulement. **RP795xA, RP796xA**

Les modes de compensation vous permettent d'optimiser le temps de réponse de la sortie avec des charges capacitives.

Le réglage de compensation **High1 (Élevé 1)** offre une vitesse de programmation amont maximale ainsi qu'un délai de stabilisation de la réponse transitoire extrêmement court. Ce mode est optimisé pour une utilisation avec des charges résistives. Cependant, vous pouvez employer les charges capacitives maximales définies dans le tableau ci-dessous en cas d'utilisation de fils de charge d'une longueur inférieure à 3 mètres (10 pieds). Le dépassement de ces limites peut provoquer des dépassements de programmation de la tension et une instabilité de la réponse transitoire.

4 Utilisation du système d'alimentations régénératrices

Le réglage de compensation **Low (Faible)** est optimisé pour une utilisation avec des charges capacitatives importantes jusqu'aux limites définies dans le tableau ci-dessous, ainsi que des fils de charge d'une longueur supérieure à 3 mètres (10 pieds). Dans ce mode, la vitesse de programmation amont et aval et la bande passante à boucle de contrôle de tension sont limitées afin d'éviter les dépassements de programmation de la tension et améliorer la stabilité de la réponse transitoire. Le mode Faible assure une meilleure stabilité et minimise les dépassements dans toutes les configurations de charge.

<fréquence> spécifie la fréquence d'angle passe-bas d'un filtre appliquée au signal de programmation. Reportez-vous à la description des fréquences dans la section suivante

REMARQUE Le raccordement de condensateurs à très faible ESR au-dessus de la limite du mode High (Élevé) avec des fils de charge d'une longueur inférieure à 3 m (10 pieds) est déconseillé dans ces deux plages de bande passante. Cette configuration de charge peut provoquer des dépassements de programmation de la tension.

Réglage	Modèles 5 kW	Modèles 10 kW	Modèles 950 V
High1	0 à 80 µF	0 à 80 µF	0 à 40 µF
Low	0 à 100 000 µF	0 à 100 000 µF	0 à 50 000 µF

Aide-mémoire des menus du panneau avant	Commande SCPI
Sélectionnez Output\Advanced\Bandwidth\Voltage . Sélectionnez Low ou High 1. Si vous le souhaitez, saisissez la fréquence polaire dans le champ Frequency (Fréquence). Appuyez ensuite sur Select .	Pour définir la bande passante pour RP795xA et RP796xA : VOLT:BWID LOW High1 Pour spécifier la fréquence polaire : VOLT:BWID:LEV 0 1, <fréquence>

Définir la bande passante de sortie - RP793xA, RP794xA

REMARQUE Ces informations s'appliquent uniquement aux modèles RP793xA et RP794xA seulement. **RP793xA, RP794xA**

Les modes de compensation vous permettent d'optimiser le temps de réponse de la sortie avec des charges capacitatives.

Les graphiques de **Limite de charge capacitive** dans la section Caractéristiques illustrent l'ESR minimum en fonction de la capacité de l'appareil testé pour permettre un fonctionnement stable.

Comp 0 (haute vitesse/faible charge capacitive) : indique la vitesse de programmation la plus rapide et le temps de réponse transitoire. Convient mieux aux appareils testés résistifs à faible capacité. Fréquence par défaut = 1,4 kHz.

Comp 1 (vitesse moyenne/charge capacitive moyenne) : indique la vitesse de programmation intermédiaire et le temps de réponse transitoire. Convient mieux aux appareils testés ayant une

capacité plus élevée avec un compromis entre la vitesse de programmation et la réponse transitoire. Fréquence par défaut = 460 Hz.

Comp 2 (vitesse faible/grande charge capacitive) : convient mieux aux appareils testés à haute capacité/faible ESR avec compromis entre la vitesse de programmation plus lente et la réponse transitoire. Fréquence par défaut = 55 Hz.

<fréquence> spécifie la fréquence d'angle passe-bas d'un filtre appliquée au signal de programmation. La tension programmée est un signal numérisé qui passe à travers un filtre passe-bas unipolaire où le pôle est indiqué en Hertz. Ce filtre a pour effet de ralentir la sortie en fonction des variations de la tension ou du courant programmé. Ceci, en association avec le réglage configurable de la vitesse, permet un compromis entre la vitesse de programmation et la tension de sortie ou le dépassement de courant. Par exemple, l'augmentation de la fréquence du filtre peut entraîner un dépassement plus important et la diminution de la fréquence réduira le dépassement, en fonction du réglage de compensation et de l'impédance de charge. Ce réglage de fréquence n'affecte pas la réponse transitoire de l'appareil à un changement de charge.

Le tableau suivant résume l'effet des réglages de compensation sur les caractéristiques de vitesse de programmation de CV.

Réglage	Conditions du palier	Fréquence	Modèles 20 V	Modèles 80 V
Comp 0	à vide, 10-100% de la valeur nominale pleine charge CC, 0-100% de la valeur nominale	100 kHz 2,3 kHz	80 µs/810 µs 140 µs/4,2 ms	71 µs/480 µs 145 µs/1,35 ms
Comp 1	pleine charge CC, 0-100% de la valeur nominale	1,4 kHz	190 µs/2,3 ms	205 µs/1,5 ms
Comp 2	pleine charge CC, 0-100% de la valeur nominale	900 Hz	350 µs/3,8 ms	360 µs/1,25 ms

Le tableau suivant décrit les caractéristiques de la bande passante du faible signal de CV

Bande passante de signal faible de la programmation de CV (-3dB) à vide		
Réglage	Modèles 20 V	Modèles 80 V
Comp 0	8,3 kHz	7,5 kHz
Comp 1	4,7 kHz	6,6 kHz
Comp 2	2 kHz	5,9 kHz

Aide-mémoire des menus du panneau avant	Commande SCPI
Sélectionnez Output\Advanced\Bandwidth\Voltage . Sélectionnez Comp 0, 1 ou 2. Si vous le souhaitez, saisissez la fréquence polaire dans le champ Frequency (Fréquence). Appuyez ensuite sur Select .	Pour régler la bande passante de compensation de tension : VOLT:BWID:RANG 0 1 2 Pour spécifier la fréquence polaire : VOLT:BWID:LEV 0 1 2, <fréquence>

Les modes de compensation de tension vous permettent d'optimiser le temps de réponse de la sortie avec des charges capacitives.

Comp 0 Convient mieux aux câbles de charge plus longs (inductance plus élevée) avec une réponse de programmation relativement rapide (voir graphique **Limite de charge d'inductance**).

Comp 1 Optimise la vitesse de programmation des appareils testés avec inductance limitée des fils. Ce réglage peut nécessiter la mise en parallèle d'ensembles de fils supplémentaires pour obtenir la longueur totale de fil souhaitée.

<fréquence> spécifie la fréquence d'angle passe-bas d'un filtre appliquée au signal de programmation. Reportez-vous à la description précédente sous les modes de compensation de tension.

Le tableau suivant résume l'effet des réglages de la compensation sur les caractéristiques de vitesse de programmation de CC.

Réglage	Conditions du palier	Fréquence	Modèles 20 V	Modèles 80 V
Comp 0	0-100% du palier de courant à Vout	100 kHz	300 µs/960 µs	180 µs/500 µs
Comp 1	> 10% de la tension nominale	100 kHz	150 µs/350 µs	60 µs/300 µs

Le tableau suivant décrit les caractéristiques de la bande passante de signal faible CC

Bande passante de signal faible de la programmation de CC (-3dB) à vide		
Réglage	Modèles 20 V	Modèles 80 V
Comp 0	2 kHz	2,7 kHz
Comp 1	2,7 kHz	3,5 kHz

Aide-mémoire des menus du panneau avant	Commande SCPI
Sélectionnez Output\Advanced\Bandwidth\Current . Sélectionnez Comp 0 ou Comp 1. Si vous le souhaitez, saisissez la fréquence polaire dans le champ Frequency (Fréquence). Appuyez ensuite sur Select .	Pour définir la bande passante de compensation de courant : CURR:BWID:RANG 0 1 2 Pour spécifier la fréquence polaire : CURR:BWID:LEV 0 1 2, <fréquence>

Régler le mode d'activation/désactivation de la sortie - RP793xA, RP794xA

REMARQUE Ces informations s'appliquent uniquement aux modèles RP793xA et RP794xA seulement. **RP793xA, RP794xA**

Le réglage de l'activation/désactivation ne s'applique que lorsque le RPS fonctionne en mode de priorité de tension. En mode priorité de courant, le comportement d'activation/désactivation est toujours l'impédance.

Le comportement d'activation et de désactivation de la priorité de tension peut être réglé en mode de faible ou de haute impédance.

Le mode **Low impedance (Faible impédance)** est destiné aux appareils tels que les convertisseurs de puissance. Lors des transitions de sortie, le courant est fourni ou déchargé pour une réponse rapide de la tension de sortie.

Le mode **High impedance (Haute impédance)** est destiné aux appareils tels que les batteries, où les transitions de sortie sont contrôlées pour réduire le courant de sortie.

Lorsque le couplage est activé, la modification du réglage d'activation change également le réglage de désactivation et vice-versa.

Aide-mémoire des menus du panneau avant	Commande SCPI
Sélectionnez Output\Advanced\Tmode .	Pour sélectionner l'activation à impédance élevée :
Sélectionnez la haute impédance ou la faible impédance pour les modes d'activation et de désactivation.	OUTP:TMOD:ON HIGHZ
Cochez Coupled (Couplage) pour coupler les modes d'activation et de désactivation. Appuyez ensuite sur Select .	Pour sélectionner la désactivation à faible impédance :
	OUTP:TMOD:OFF LOWZ
	Pour coupler les modes d'activation et de désactivation :
	OUTP:TMOD:COUP ON

Activation de la sortie

En raison des procédures de démarrage de circuit internes et de toutes les options de relais installées, l'activation de la sortie (OUTPut ON) peut durer plusieurs dizaines de millisecondes. Des délais de désactivation de la sortie (OUTPut OFF) peuvent également être observés. Pour plus d'informations sur les délais d'activation et de désactivation de la sortie, reportez-vous à la section **Délais d'activation/désactivation**.

Aide-mémoire des menus du panneau avant	Commande SCPI
Appuyez sur la touche On/Off .	OUTP ON OFF

En plus des commandes d'activation et de désactivation de la sortie du panneau avant et SCPI, vous pouvez utiliser les signaux OnCouple et OffCouple pour activer et désactiver la sortie. Pour plus

4 Utilisation du système d'alimentations régénératrices

d'informations, reportez-vous à la section **Commande de couplage des sorties**. Lorsque le couplage est activé, la modification du réglage d'activation change également le réglage de désactivation et vice-versa.

REMARQUE

Au cours d'une coupure de secteur sur 1 cycle, l'appareil peut redémarrer. La sortie restera désactivée après le redémarrage jusqu'à ce que l'opérateur rétablisse les réglages précédents, soit grâce aux commandes du panneau avant, soit en utilisant un programme informatique. Ce comportement est conforme aux procédures d'exploitation sécuritaires.

Fonctionnement en parallèle

Introduction

Fonctionnement principal/secondaire

Fonctionnement en parallèle indépendant - RP795xA, RP796xA

Introduction

AVERTISSEMENT

RISQUE D'ÉLECTROCUTION Tous les appareils en parallèle doivent être raccordés à la masse en permanence par un cordon d'alimentation mis à la terre. Toute interruption du conducteur de protection (mise à la terre) ou tout débranchement de la borne de terre de protection d'un appareil vous expose à un risque d'électrocution susceptible de provoquer des blessures ou la mort.

ATTENTION

Pour éviter d'éventuels dommages de l'équipement :

- Ne connectez pas plus de vingt appareils **de tensions nominales identiques**. Tous les appareils doivent avoir la même tension, mais les valeurs nominales de courant peuvent varier. Tous les appareils doivent disposer de la même version du micro-programme. Pour plus de détails, reportez-vous à la section **Identification de l'instrument**.
- Activez et désactivez toujours simultanément l'**alimentation CA**. Ne laissez jamais d'appareils sous tension lorsque les autres sont éteints.
- Dans le cas des modèles RP795xA et RP796xA, connectez toujours les bornes de sortie **négatives** de tous les appareils en parallèle ensemble afin d'éviter tout endommagement du bus de partage.

Le fonctionnement en parallèle vous permet de connecter plusieurs alimentations pour créer un système avec un courant et une puissance totale plus élevés. Ceci s'applique aussi bien à l'alimentation en courant qu'à l'opération d'absorption de courant. Reportez-vous à la section **Connexions de plusieurs appareils** pour obtenir des informations détaillées sur la connexion des sorties et les câbles principal/secondaire. N'oubliez pas de régler également les commutateurs de terminaison.

Des appareils de puissances différentes peuvent être connectés en parallèle, dès lors qu'ils présentent des tensions nominales identiques. Dans ce cas, les appareils se partagent le courant de manière proportionnelle en fonction de leur courant nominal. Par exemple, un appareil ayant une valeur nominale de 10 Kw à 40 A et un appareil ayant une valeur nominale de 5 kW à 20 A partageront leur courant de sortie selon un rapport de 2 à 1.

REMARQUE

Les modèles RP795xA ; RP796xA **RP795xA, RP796xA** nécessitent également la connexion du câble de partage comme décrit dans la section **Connexions de partage**.

Deux modes de fonctionnement en parallèle sont disponibles :

Fonctionnement principal/secondaire : dans ce mode, le groupe connecté en parallèle est contrôlé par l'appareil principal et apparaît sous forme d'alimentation supérieure unique. L'appareil principal offre l'ensemble de la plupart des fonctions source et de mesure. La fonction de **partage de courant** est automatiquement activée lors d'un fonctionnement en mode principal/secondaire. Il s'agit de la méthode recommandée pour les appareils connectés en parallèle.

Fonctionnement en parallèle indépendant pour les modèles RP795xA, RP796xA RP795xA, RP796xA : dans ce mode, tous les appareils connectés en parallèle sont programmés indépendamment. Connectez et programmez les signaux des ports numériques **Couplage activé** et **Couplage désactivé** de sortie pour permettre la mise en marche et l'arrêt synchronisés de l'instrument. Vous devez explicitement activer la fonction de **partage de courant** sur chaque appareil connecté en parallèle.

Fonctionnement principal/secondaire

Il est possible de connecter jusqu'à vingt instruments en parallèle dans une configuration principale/secondaire. Tous les appareils doivent avoir la même tension, mais les valeurs nominales de courant peuvent varier. Tous les appareils doivent disposer de la même version du microprogramme. Reportez-vous au chapitre **Identification de l'instrument** pour afficher la version du microprogramme. La procédure de configuration pour le fonctionnement en mode principal/secondaire est la suivante :

- Configurez un appareil en tant que principal
- Configurez les autres appareils en tant qu'appareils secondaires avec des adresses de bus uniques
- Sélectionnez le mode de connexion et le délai de connexion automatique
- Effectuez une découverte unique sur l'appareil principal, il enregistre la configuration principale/secondaire
- Lors de l'activation, l'appareil principal peut se connecter aux appareils secondaires automatiquement ou manuellement
- Si la configuration principale/secondaire a été modifiée ultérieurement, elle doit être retrouvée

Configuration principale/secondaire

Configurez chaque instrument en parallèle en tant que principal ou secondaire.

Aide-mémoire des menus du panneau avant	Commande SCPI
Sélectionnez System\Group\Function . Dans la boîte de dialogue, sélectionnez Principal, Secondaire ou None (Aucun). Appuyez ensuite sur Select.	Pour configurer l'appareil en parallèle : INST:GRO:FUNC PRIM SEC NON

Si l'appareil est le principal, un délai peut être programmé pour permettre aux appareils secondaires de démarrer avant que le principal ne se connecte automatiquement au secondaire. En cas de délai de la mise sous tension des appareils secondaires, la connexion automatique du principal peut échouer. « None » correspond à une opération non parallèle. Ne connectez pas les appareils

configurés comme None au bus principal/secondaire, cela risque de provoquer une erreur de partage de courant (CSF).

Aide-mémoire des menus du panneau avant	Commande SCPI
Sélectionnez System\Group\Delay . Dans la boîte de dialogue, définissez le délai de connexion automatique. Appuyez ensuite sur Select.	Pour régler le délai de connexion automatique sur 10 : INST:GRO:PRIM:DEL 10

Si l'appareil est un secondaire, chaque appareil secondaire doit recevoir une adresse de bus unique (comprise entre 1 et 19).

Aide-mémoire des menus du panneau avant	Commande SCPI
Sélectionnez System\Group\Secondary . Dans la boîte de dialogue, sélectionnez l'adresse de l'appareil secondaire. Les valeurs peuvent aller de 1 à 19. Appuyez ensuite sur Select.	Pour régler l'adresse secondaire sur 1 : INST:GRO:SEC:ADDR 1

Spécifiez le mode de connexion de l'appareil principal.

AUTO : l'appareil principal se connecte automatiquement aux appareils secondaires précédemment découverts lors de la mise sous tension.

MANual : l'appareil principal se connecte aux appareils secondaires précédemment découverts quand il reçoit une commande de connexion du panneau avant ou de **INST:GRO:PRIM:CONN:MODE MAN**.

Aide-mémoire des menus du panneau avant	Commande SCPI
Sélectionnez System\Group\Mode . Dans la boîte de dialogue, sélectionnez le mode de connexion. Appuyez ensuite sur Select.	Réglez le mode de connexion de l'appareil principal : INST:GRO:PRIM:CONN:MODE AUTO

Après la configuration de l'adresse de l'appareil secondaire, sélectionnez « Discover » (Découvrir) sur l'appareil principal pour initier la communication avec tous les appareils secondaires. Après la découverte initiale, le processus de découverte n'a pas besoin d'être relancé à moins que la configuration principale/secondaire ne change.

Aide-mémoire des menus du panneau avant	Commande SCPI
Sélectionnez System\Group\Discover . Dans la boîte de dialogue, sélectionnez Discover pour découvrir tous les appareils secondaires. Appuyez ensuite sur Select.	Pour découvrir les appareils secondaires : INST:GRO:PRIM:DISC

Pour connecter manuellement l'appareil principal à tous les appareils secondaires précédemment découverts.

Aide-mémoire des menus du panneau avant	Commande SCPI
---	---------------

Sélectionnez **System\Group\Connect**.

Dans la boîte de dialogue, sélectionnez **Connect** pour connecter tous les appareils secondaires au principal. Appuyez ensuite sur **Select**.

Pour connecter l'appareil principal aux appareils secondaires précédemment découverts :

INST:GRO:PRIM:CONN

Considérations relatives à la programmation principale/secondaire

Programmer les réglages de la tension et du courant de sortie de l'appareil principal de la même manière que vous le feriez pour un appareil individuel. Pour plus d'informations, reportez-vous aux sections **Réglage de la tension de sortie** et **Réglage du courant de sortie**. Les appareils secondaires sont verrouillés ; vous ne pouvez pas programmer les réglages des appareils.

Définissez les limites de courant positive et négative à un niveau élevé pour permettre des dynamiques transitoires de programmation amont/aval. Les dynamiques transitoires sont principalement le résultat des courants de charge de la capacité de l'appareil testé. Notez que la limite de courant et l'état actuel de l'appareil principal sont proportionnés automatiquement parmi le groupe connecté en parallèle selon le courant nominal de chaque appareil.

Réduisez les vitesses de balayage pour atténuer la synchronisation imparfaite de la programmation de la tension. Les vitesses de balayage par défaut sont définies à leurs valeurs maximales.

REMARQUE

En mode de priorité de courant, réglez le courant de sortie de l'appareil principal sur la valeur souhaitée. Réglez la limite de tension à une valeur supérieure à la tension de service attendue de l'appareil.

Écran du panneau avant principal/secondaire

La valeur du courant lue sur le panneau avant de l'appareil principal correspond à l'ensemble des valeurs des appareils principal et secondaire. Les appareils secondaires renvoient leurs valeurs de courant individuelles.

L'exemple suivant illustre les affichages du panneau avant pendant le fonctionnement principal/secondaire. Trois appareils sont connectés dans une configuration principale/secondaire. Les appareils fonctionnent en mode de priorité de tension.

Il s'agit de l'appareil principal de 10 kW.

- « P » indique l'appareil principal.
- Le courant affiché (100 A) est le courant de sortie total de tous les appareils connectés en parallèle. L'appareil ne contribue qu'à hauteur de 40 A au total.



Il s'agit de l'appareil secondaire de 10 kW.

- « S » indique un appareil secondaire.
- Le courant affiché (40 A) est le courant que cet appareil apporte au total.



Il s'agit de l'appareil secondaire de 5 kW.

- « S » indique un appareil secondaire.
- Le courant affiché (20 A) est le courant que cet appareil apporte au total. Cela représente la moitié du courant des appareils de 10 kW.



Communication principale/secondaire

Lorsqu'il est connecté, l'appareil principal interroge régulièrement les appareils secondaires concernant leur état. Si la communication avec un appareil secondaire échoue, par exemple si un appareil secondaire est activé ou désactivé, l'appareil principal et les autres appareils secondaires passent en protection principale/secondaire (PSP). Lorsque les autres appareils secondaires détectent que l'appareil principal s'est déconnecté, ils se connectent également au PSP. De plus, une erreur de partage de courant (CSF) peut se produire si les **commutateurs de terminaison** sont mal réglés.

Les appareils secondaires utilisent le sondage périodique d'état du principal comme un temporisateur pour déclencher la PSP. Si le secondaire ne reçoit pas de sondage d'état toutes les 10 secondes max., il passe en PSP.

Les appareils secondaires peuvent passer en PSP 10 secondes après l'activation. Une fois que ces appareils sont découverts, l'appareil principal établit une communication avec les appareils secondaires, effaçant ainsi la PSP.

Protection principale/secondaire

Si l'appareil principal entre en protection, il envoie une commande de protection aux appareils secondaires. L'appareil principal indique le type d'événement de protection qui s'est produit. Les appareils secondaires indiquent PROT. Une fois que la condition de protection est corrigée, l'effacement de la protection sur l'appareil principal effacera la protection sur tous les appareils (voir **Effacement de la protection**).

Si un appareil secondaire est protégé, l'appareil principal et l'appareil secondaire sur lequel l'événement de protection s'est produit indiquent le type d'événement de protection. Tous les autres appareils secondaires indiquent PROT. Une fois que la condition de protection est corrigée, l'effacement de la protection sur l'appareil principal effacera la protection sur tous les appareils.

En cas d'utilisation des fonctions **Fault** (Défaillance) ou **Inhibit** (Inhibition) sur le connecteur numérique du panneau arrière, connectez les broches Fault/Inhibit seulement sur l'appareil principal. Vous n'avez pas besoin de connecter les broches Fault/Inhibit (Défaillance/Inhibition) des appareils secondaires.

Détails sur la commande principale/secondaire

Une fois connecté, le groupe d'appareils est commandé par le principal et apparaît comme alimentation supérieure unique. Toutes les commandes de programmation doivent être envoyées à l'appareil principal.

Les commandes SCPI suivantes ne sont **pas prises en charge** en mode principal/secondaire :

4 Utilisation du système d'alimentations régénératrices

<code>CURRent:SHARing</code>	Le partage de courant est activé automatiquement
<code>ELOG:CURRent<:MAX :MIN></code>	Commandes <code>ELOG:CURR:MAX</code> et <code>:MIN</code>
<code>POWer:LIMit?</code>	Requête de limite de puissance
<code>SYSTem:REBoot</code>	Commande Reboot (Redémarrage)

Les commandes SCPI suivantes ne sont **pas prises en charge** en mode principal/secondaire sur les révisions de microprogramme préalables à B.04.04.809 :

<code>ARB</code>	Toutes les commandes du signal arbitraire (ARB)
<code>ELOG</code>	Toutes les commandes du signal arbitraire (ELOG)
<code>FETCh:CURRent<:HIGH :LOW :MAX :MIN></code>	Toutes les commandes <code>:HIGH :LOW :MAX</code> et <code>:MIN</code>
<code>FETCh:POWer<:MAX :MIN></code>	Toutes les commandes <code>:HIGH :MAX</code> et <code>:MIN</code>
<code>FETCh:VOLTag<:HIGH :LOW :MAX :MIN></code>	Toutes les commandes <code>:HIGH :LOW :MAX</code> et <code>:MIN</code>
<code>MEASure:CURRent<:HIGH :LOW :MAX :MIN></code>	Toutes les commandes <code>:HIGH :LOW :MAX</code> et <code>:MIN</code>
<code>MEASure:POWer<:MAX :MIN></code>	Toutes les commandes <code>:HIGH :MAX</code> et <code>:MIN</code>
<code>MEASure:VOLTag<:HIGH :LOW :MAX :MIN></code>	Toutes les commandes <code>:HIGH :LOW :MAX</code> et <code>:MIN</code>
<code>LIST</code>	Toutes les commandes du signal arbitraire (LIST)
<code>TRIGger:ARB:SOURce</code>	Commande source de signal arbitraire (ARB)
<code>TRIGger:ACQ<:CURR:LEV :VOLT:LEV></code>	Acquisitions à déclenchement par niveau

Les commandes SCPI suivantes peuvent être envoyées à l'appareil secondaire en mode principal/secondaire.

<code>FETCh<:VOLTag :CURRent :POWer></code>	Seulement les commandes <code>:VOLT :CURR :POW</code>
<code>MEASure<:VOLTag :CURRent :POWer></code>	Seulement les commandes <code>:VOLT :CURR :POW</code>
Toutes les commandes SYSTEMIO du panneau avant	seulement disponibles sur le menu du panneau avant

Fonctionnement en parallèle en courant maximal - RP793xA, RP794xA

En raison des tolérances de circuit individuelles entre les appareils connectés en parallèle dans une configuration principale/secondaire, le courant fourni par chaque appareil peut varier légèrement par rapport à la « quantité idéale », ce qui suppose que tous les appareils partagent le courant exactement de manière égale. Ces tolérances de circuit individuelles peuvent faire en sorte qu'une ou plusieurs des appareils passent du fonctionnement CV au fonctionnement CC lorsque le courant nominal maximal du groupe connecté en parallèle est atteint. Le courant nominal maximal du groupe restera disponible, mais la réponse transitoire dynamique peut changer en raison de la transition de l'un des appareils en mode CC.

Si un fonctionnement CV strict est requis dans toutes les conditions de fonctionnement, en particulier au courant nominal maximal du groupe connecté en parallèle, il est recommandé de régler la limite CC sur la valeur maximale programmable de l'appareil principal. Si cela n'est pas suffisant, réduisez le courant de charge total demandé ou envisagez l'ajout d'un appareil supplémentaire afin de laisser une marge libre supplémentaire pour que le groupe puisse maintenir le CV dans des conditions de charge maximale.

Dépannage

Si les indicateurs d'état suivants apparaissent sur le panneau avant :

PSP : protection principale/secondaire

Il y a eu une perte de communication entre les appareils principal et secondaire. Vérifiez que les **câbles CAT6A** sont installés dans les connecteurs principal/secondaire, et non dans le réseau local ou dans le Safety Disconnect.

CSF : erreur de partage de courant

Il y a eu un défaut de partage de courant dû au fait que la boucle principale/secondaire n'est pas conforme aux règles. Cela peut se produire si les **commutateurs de terminaison** sont mal réglés. Cela peut également se produire temporairement en cas de croisement de mode à partir d'un transitoire de charge ou en raison d'une programmation amont/aval rapide. Dans ce cas, réglez la limite de courant à une valeur supérieure. Un CSF peut également se produire si la boucle ne peut plus réguler le déséquilibre de courant entre les appareils. Un CSF peut également être une indication initiale de perte de communication avec l'appareil principal, qui passera en PSP.

Si les messages d'erreur suivants apparaissent :

Pas d'appareils secondaires découverts ou **1 appareil secondaire découvert** (si plusieurs appareils secondaires sont attendus)

Vérifiez l'absence d'adresses secondaires en double.

Erreur 332, erreur principale/secondaire

Ceci indique le plus souvent que l'appareil principal a perdu la communication avec un secondaire, et qu'elle est généralement accompagnée d'une PSP. Vérifiez que les **câbles CAT6A** principal/secondaire sont correctement installés. Ceci peut également se produire lors de la modification de la configuration principale/secondaire. Réglez toujours l'appareil principale sur Aucun lors du changement de configuration principale/secondaire.

Fonctionnement en parallèle indépendant - RP795xA, RP796xA

ATTENTION

Ne laissez jamais d'appareils sous tension lorsque les autres sont éteints. Si l'alimentation secteur est activée ou désactivée sur un seul appareil, les sorties des appareils qui sont sous tension seront activées et passeront à leurs réglages programmés. Pour éviter cela, programmez les sorties de tous les appareils à zéro avant de les éteindre, et allumez et éteignez toujours tous les appareils ensemble.

Activer le partage de courant

REMARQUE

La fonction de partage du courant est automatiquement activée pour les modèles

RP795xA, RP796xA.

Les appareils peuvent fonctionner en parallèle sans partage de courant. Cependant, le courant de sortie ne sera pas partagé de manière équitable et il se peut que le mode de tension constante ne soit pas maintenu sur tous les appareils.

Le partage de courant est une fonction de contrôle analogique qui ajuste la tension de sortie jusqu'à environ 0,5 % de la tension nominale de l'appareil. Cela améliore la précision de mesure du courant parmi les appareils connectés en parallèle. Cela s'applique si les appareils sont connectés pour un fonctionnement en mode principal/secondaire ou s'ils sont connectés pour un fonctionnement en parallèle indépendant.

Les appareils ayant des valeurs de courant nominales équivalentes partageront le courant de manière égale. Les appareils ayant des valeurs de courant différentielles partageront le courant selon le rapport de leur valeur de courant nominale. Par exemple, un appareil ayant une valeur nominale à 40 A et un appareil ayant une valeur nominale à 20 A partageront leur courant de sortie selon un rapport de 2 à 1.

En mode Parallèle indépendant uniquement, l'état du panneau avant affiche un « P », indiquant que le partage de courant est activé et que le relais de partage est fermé pour connecter l'appareil au bus de partage ; lorsque la sortie est désactivée, le relais de partage s'ouvre et déconnecte l'appareil du bus de partage.

Aide-mémoire des menus du panneau avant	Commande SCPI
Sélectionnez Output\Advanced\CurrSharing . Cochez la case Enable current sharing (Activer le partage de courant) pour activer la fonction.	Activer le partage de courant : CURR:SHAR ON

Utilisation de la fonction de partage de courant

En mode de priorité de tension :

- Programmez le réglage de tension de sortie de chaque appareil connecté en parallèle sur la même valeur.
- Réglez la limite de courant de chaque appareil sur les équations suivantes. Cela permettra à tous les appareils de partager le courant jusqu'à ce que le point limite de courant *total* soit atteint. Ce point correspond à la somme de chacune des limites de courant.

Pour chaque appareil 5 kW : $I_{CL_5kW} = I_{CL_TOTAL} / (N_T + N_{10kW})^*$

Pour chaque appareil 10 kW : $I_{CL_10kW} = 2(I_{CL_TOTAL}) / (N_T + N_{10kW})$

où :

I_{CL_5kW} correspond à la limite de courant de l'appareil 5 kW

I_{CL_10kW} correspond à la limite de courant de l'appareil 10 kW

I_{CL_TOTAL} correspond à la somme totale de toutes les limites de courant individuelles

N_T correspond au nombre total d'appareils connectés en parallèle d'une puissance nominale

quelconque

N_{10kW} correspond au nombre total d'appareils 10 kW connectés en parallèle

*Si aucun appareil de 10 kW n'est utilisé, alors $N_{10kW} = 0$.

Notez que dans une configuration de puissance mixte, vous devez régler la limite de courant des appareils 10 kW sur une valeur deux fois supérieure à celle des appareils 5 kW. En effet, dans ce type de configuration, chaque appareil 10 kW fournit deux fois plus de courant que chaque appareil 5 kW.

Lorsque la limite de courant d'un appareil connecté en parallèle est atteinte, le courant de sortie de cet appareil est limité à sa valeur spécifiée.

En mode de priorité de courant :

- Réglez la limite de tension de chaque appareil connecté en parallèle sur la même valeur.
- Programmez le réglage de courant de chaque appareil connecté en parallèle conformément aux équations ci-dessus si vous souhaitez partager le courant. Le courant de sortie total correspond à la somme de chacun des réglages de courant.

Notez qu'en mode de priorité de courant, la configuration de partage n'équilibre les courants que si tous les appareils fonctionnent en mode de limitation de tension, avec le voyant d'état CV allumé.

Effets parallèles sur la régulation de la charge

La conception du système RPS a été optimisée pour un fonctionnement en parallèle. L'impact des appareils connectés en parallèle sur les spécifications a donc été minimisé. Lorsque des appareils sont connectés en parallèle, aucune caractéristique, à l'exception de la régulation de charge, n'est altérée. Toutes les autres caractéristiques, notamment le bruit de sortie, la précision de programmation, la précision de relecture et la réponse transitoire, ne sont pas affectées par le fonctionnement en parallèle.

Lorsqu'au moins deux appareils sont connectés en parallèle et que le partage de courant est activé, un léger effet de régulation de tension supplémentaire est observé. L'effet de régulation de charge supplémentaire maximal se présente comme suit :

$$\Delta V_{OUT(VALEUR_DÉFAVORABLE)} = 0,003 \% (V_{VALEUR_NOMINALE})$$

Pour déterminer l'effet de régulation de tension de sortie total d'un appareil spécifique, vous devez ajouter la valeur la plus défavorable du tableau suivant à la **spécification de régulation de charge CV** de chaque appareil connecté en parallèle. Ces valeurs les plus défavorables sont calculées pour chaque appareil en fonction de sa valeur nominale.

$V_{NOMINALE}$	$\Delta V_{OUT(VALEUR_DÉFAVORABLE)}$	$V_{NOMINALE}$	$\Delta V_{OUT(VALEUR_DÉFAVORABLE)}$
500 V	15 mV	950 V	28,5 mV

Exemple : Vous avez connecté deux appareils de 500 V en parallèle. L'effet de régulation de charge dû au partage de courant est de 15 mV d'après le tableau ci-dessus. La spécification de régulation de charge CV est de 30 mV. Par conséquent, l'effet de régulation de tension de sortie total est de 30 mV + 15 mV ou de 45 mV.

Utilisation de la fonction d'absorption de courant

Absorption de courant

Fonctionnement régénératif

Absorption de courant

L'absorption de courant, également appelée programmation aval, est la capacité à injecter du courant dans la borne positive de l'alimentation CC. Par exemple, le bloc d'alimentation injecte ou dissipe du courant dans la borne positive chaque fois qu'une tension de sortie inférieure est programmée. Cette opération est nécessaire, car l'énergie stockée dans le condensateur de sortie du bloc d'alimentation et la capacité externe de la charge, notamment le câblage, doivent être déchargée pour réduire la tension aux bornes de sortie.

La capacité à passer rapidement d'un niveau de tension constante élevé à un niveau inférieur améliore considérablement le temps de réponse en sortie du bloc d'alimentation. Cette application est la plus couramment utilisée de la fonction régénératrice du RPS. Elle est automatique et entièrement transparente pour l'utilisateur.

L'alimentation CC peut absorber continuellement jusqu'à 100% de son courant nominal pendant une durée illimitée. Cette fonction d'alimentation et d'absorption à **deux quadrants** de l'alimentation CC permet d'opérer des transitions fluides entre l'alimentation et l'absorption de courant sans altérer les caractéristiques de sortie de l'alimentation ni engendrer des perturbations. Les commandes suivantes sont fournies pour exploiter pleinement la capacité de sortie à deux quadrants de l'alimentation.

Commande de limite de courant en mode de priorité de tension

En mode de priorité de tension, vous pouvez programmer une **limite de courant** négative et positive. Cela réduit le nombre de dépassements de courant susceptibles de se produire pendant une programmation amont ou aval rapide.

Commande de réglage de courant en mode de priorité de courant

En mode de priorité de courant, vous pouvez programmer le courant de sortie afin qu'il traverse en douceur le point zéro lors du passage d'une valeur positive à une valeur négative et vice versa. De plus, lors d'un fonctionnement dans le quadrant de courant négatif, vous pouvez programmer une **valeur de courant** négative qui maintienne le courant absorbé à la valeur spécifiée. Cela est utile, par exemple, lors de la décharge d'une batterie à un niveau de courant constant.

Si votre application exige un contrôle précis des courants source et absorbés, des **commandes de balayage** de courant sont disponibles. Ces dernières permettent de spécifier une vitesse de balayage de courant lors de l'alimentation et de l'absorption de courant.

Fonctionnement régénératif

Le fonctionnement régénératif est automatique et ne nécessite aucune programmation de la part de l'utilisateur. Chaque fois que l'appareil absorbe du courant, soit par programmation amont rapide de

la sortie, soit par déchargement d'une source d'énergie comme une batterie, l'appareil dirigera la puissance excessive vers la source de courant alternatif. Pour plus d'informations, veuillez consulter la section **Caractéristiques communes de l'alimentation secteur**.

Programmation de la protection des sorties

Définir la protection contre les surtensions

Définir la protection contre les surintensités

Temporisateur de surveillance de la sortie

Définir la protection contre les sous-tensions

Supprimer la protection de la sortie

Introduction

Les modèles RPS incluent de nombreuses fonctions de protection. Ces dernières désactivent la sortie afin de protéger l'appareil testé (DUT), ainsi que le bloc d'alimentation. Un voyant d'état situé sur le panneau avant s'allume lorsqu'une fonction de protection a été activée. La plupart des fonctions de protection sont de type à verrouillage. Autrement dit, elles doivent être désactivées une fois qu'elles ont été activées.

ATTENTION

Toutes les protections provoquent une déconnexion de la sortie à impédance élevée. La sortie est déconnectée sans absorption active de courant, de sorte que la décharge de tension de l'appareil testé dépend de ses caractéristiques. L'appareil testé et l'inductance des fils de charge doivent se situer dans les limites matérielles spécifiées pour absorber en toute sécurité l'énergie stockée. Reportez-vous aux limites d'inductance de charge maximale dans la section **Caractéristiques RP793xA, RP794xA**.

Parmi les fonctions de protection suivantes, les fonctions OV, OC, PROT, INH et UV peuvent être programmées par l'utilisateur.

OV La protection contre les surtensions est une protection matérielle dont le niveau de déclenchement est programmable par l'utilisateur. La protection OV est activée automatiquement si les fils de mesure à distance sont court-circuités. La protection OV est toujours activée.

OV- La protection contre les surtensions négatives se déclenche si les fils de mesure à distance sont inversés. Lors de l'activation, elle se déclenche également en cas de tensions plus négatives que -5 V pour les modèles **RP795xA, RP796xA** ou -1 % de la puissance nominale pour les modèles **RP793xA, RP794xA** présentes aux bornes de sortie. Après l'activation, le niveau passe à -20 % pour les modèles RP793xA et RP794xA. La protection OV- ne peut pas être programmée et est toujours activée.

OC La protection contre les surintensités est une fonction programmable par l'utilisateur qui peut être activée ou désactivée. Lorsqu'elle est activée, la sortie est désactivée si elle atteint la valeur limite de courant. Une OCP se déclenche également en cas de dépassement des limites de courant internes, quel que soit le réglage OCP.

CP+ La protection contre les surpuissances positives compare la puissance de sortie à un seuil intégré. Une protection CP+ se déclenche lorsque le seuil est dépassé. La protection CP+ est toujours activée.

CP- La protection contre les surpuissances négatives compare la puissance dissipée en interne à un seuil intégré. Une protection CP- se déclenche lorsque le seuil est dépassé. La protection CP- est toujours activée.

OT La protection contre les surchauffes surveille la température interne du bloc d'alimentation et désactive la sortie si la température dépasse la limite prédéfinie (voir **OUTPut:PROTection:TEMPerature:MARGin?**). La protection OT est toujours activée.

PF Indique qu'une panne de courant s'est produite sur le secteur et qu'elle a désactivé la sortie. La protection PF est toujours activée.

EDP Protection dynamique excessive

Pour les modèles **RP795xA, RP796xA**, l'EDP désactive la sortie dans l'éventualité de fluctuations de tension répétitives excessives provoquées par des variations de tension programmées, des listes, des signaux arbitraires ou des fluctuations de tension induites par une charge (voir **Réponse dynamique de la sortie**). Si elles ne sont pas vérifiées, ces fluctuations de tension peuvent endommager prématurément les composants de l'appareil. La protection EDP est toujours activée.

Pour les modèles **RP793xA, RP794xA**, l'EDP désactive la sortie en cas d'importants transferts dynamiques de puissance qui pourraient endommager l'appareil. Cela pourrait se produire, par exemple, en cas d'oscillations involontaires et soutenues provoquant d'importants transferts de puissance, de l'alimentation à pleine puissance à l'absorption de la pleine puissance. En supposant que l'appareil fonctionne dans les conditions de fonctionnement suggérées, l'EDP ne devrait pas s'enclencher dans des conditions normales. La protection EDP est toujours activée.

Prot Protection indique que la sortie est désactivée en raison d'une expiration du temporisateur de surveillance de sortie programmée. Cela indique également qu'une erreur PSP s'est produite sur un appareil secondaire.

INH L'entrée d'inhibition (broche 3) située sur le connecteur numérique du panneau arrière peut être programmée pour servir de signal d'arrêt externe. Pour plus de détails, reportez-vous à la section **Entrée d'inhibition**.

UV Pour les modèles **RP793xA, RP794xA**, la protection contre les surtensions permet d'éviter que la tension ne descende en dessous de la limite de sous-tension lors du déchargement d'une batterie. Elle évite également l'activation de la sortie si la tension de sortie est inférieure au niveau de protection contre les sous-tensions programmé.

PSP Une erreur de protection principale/secondaire s'est produite dans le groupe connecté en parallèle. Toutes les sorties de tous les appareils connectés en parallèle sont désactivées. La protection PSP est toujours activée. Pour plus de détails, reportez-vous à la section **Protection de la connexion en parallèle**.

SDP Une erreur de protection de déconnexion de sécurité s'est produite en raison d'une défaillance matérielle SDS ou de communication de Keysight SD1000A. L'appareil doit être redémarré pour effacer cet état de protection. Pour plus de détails, reportez-vous à la section **Protection SDP**.

DOV+ La surtension positive d'appareil testé est active lorsque la sortie est désactivée puis activée en mode HIGHZ. Si l'appareil testé applique une tension sur les bornes de sortie inférieure aux niveaux de tension suivants, la sortie ne se mettra pas en marche pour empêcher un courant excessif de circuler **dans** l'appareil.

Priorité à la tension : si la tension de l'appareil testé dépasse la tension programmée de + 1 % de la

4 Utilisation du système d'alimentations régénératrices

tension nominale de l'appareil.

Priorité de courant : Si la tension de l'appareil testé dépasse la limite de tension positive + 1 % de la tension nominale de l'appareil.

DOV- La surtension négative de l'appareil testé est active lorsque la sortie est désactivée puis activée. Si l'appareil testé applique une tension sur les bornes de sortie inférieure aux niveaux de tension suivants, la sortie ne sera pas activée pour empêcher un courant excessif de **sortir** de l'appareil.

Priorité à la tension : si la tension de l'appareil testé est inférieure à - 1 % de la tension nominale de l'appareil.

Priorité de courant : si la tension de l'appareil testé est inférieure à la limite de tension négative - 1 % de la tension nominale de l'appareil.

LOV+ La protection contre les surtensions positives locales se déclenche si les fils de mesure à distance sont raccourcis accidentellement. Cette protection minimise l'augmentation de la tension de sortie qui en résulte en comparant la tension aux bornes de sortie à un niveau de tension de 1 volt plus 10 % de la valeur nominale au-dessus du niveau OVP positif programmé par l'utilisateur. Si la tension de sortie dépasse ce niveau, l'appareil passe en état de protection verrouillé. La protection LOV est toujours activée.

LOV- La protection contre les surtensions locales négatives n'est pas disponible sur les modèles à deux quadrants.

OCF+ La protection contre les erreurs de surintensité positive est active lorsque l'appareil testé applique une tension inverse aux bornes de sortie. Elle minimise le courant de crête résultant aux bornes de sortie en comparant le courant de sortie réel à un niveau fixe de 105 % du courant nominal de l'appareil. Si le courant dépasse ce niveau, l'appareil passe en protection verrouillée.

OCF- La protection contre les erreurs de surintensité négative est active en mode de priorité du courant lorsque l'appareil testé applique une tension aux bornes de sortie qui est supérieure au paramètre à la limitation de courant positive. Elle minimise le courant de crête résultant aux bornes de sortie en comparant le courant de sortie réel à un niveau fixe de 105 % du courant nominal de l'appareil. Si le courant dépasse ce niveau, l'appareil passe en protection verrouillée.

REMARQUE DOV, LOV et OCF ne sont disponibles que sur les appareils disposant d'une révision de microprogramme B.04.04.809 et supérieure.

Définir la protection contre les surtensions

La fonction de protection contre les surtensions désactive la sortie si la tension de sortie atteint la limite de surtension programmée. Le circuit OVP contrôle la tension aux bornes de mesure + et -. Un arrêt de l'OVP se produit automatiquement si les fils de mesure + et - sont accidentellement court-circuités l'un avec l'autre.

Aide-mémoire des menus du panneau avant	Commande SCPI
Sélectionnez Protect\OVP .	Pour régler le niveau OVP sur 400 volts :
Saisissez une valeur dans la zone de niveau OVP. Appuyez ensuite sur Select .	VOLT:PROT 400

Définir la protection contre les surintensités

Enable OCP

Lorsque la fonction de protection contre les surintensités est activée, l'alimentation se désactive lorsque le courant de sortie atteint la valeur limite de courant et passe de la tension constante (CV) à la limite de courant (CL+ ou CL-).

Aide-mémoire des menus du panneau avant	Commande SCPI
Sélectionnez Protect\OCP .	Pour activer OCP :
Cochez la case Enable OCP . Appuyez ensuite sur Select .	CURR:PROT:STAT ON

Delay OCP

Vous pouvez spécifier un délai de l'OCP afin d'éviter le déclenchement de la protection contre les surintensités dus aux réglages de sortie momentanés, à la charge et aux changements d'état. Dans la plupart des cas, ces conditions temporaires ne sont pas considérées comme une défaillance de protection contre les surintensités : il serait gênant que de telles conditions désactivent la sortie. L'indication d'un délai OCP permet au circuit OCP d'ignorer ces modifications temporaires pendant le délai de temporisation spécifié. Une fois le délai OCP expiré, si la condition de surintensité persiste, la sortie est interrompue.

Les options suivantes permettent d'activer le temporisateur de protection contre les surintensités :

L'option **Settings Change (Modification des réglages)** permet d'activer le délai de protection contre les surintensités chaque fois qu'une commande modifie les réglages de sortie. Cela inclut les modifications apportées par le système de transitoire de sorte que le temporisateur est démarré à chaque palier de liste et modification de la sortie du signal arbitraire. Sont également incluses les variations de la vitesse de balayage de tension et de courant de sorte que le temporisateur est redémarré pendant toute la durée du balayage.

L'option **Current Limit (Limite de courant)** permet de déclencher le temporisateur de protection contre les surintensités à chaque basculement de la sortie sur la limite de courant.

Le délai peut être programmé entre 0 et 0,255 secondes. Vous pouvez indiquer si le temporisateur de l'OCP est déclenché par un basculement de la sortie en mode de limite de courant ou uniquement à la fin d'un changement de valeur dans l'état de la tension, du courant ou de la sortie.

Aide-mémoire des menus du panneau avant	Commande SCPI
Sélectionnez Protect\OCP .	Pour indiquer un délai de 10 millisecondes :
Saisissez une valeur de délai. Appuyez ensuite sur Select .	CURR:PROT:DEL 0.01
Par défaut, le temporisateur est activé par un « Settings Change » (Modification des réglages) de sortie.	Pour démarrer le temporisateur suite à une modification des réglages de sortie :
Cochez la case « CC Transition » (Transition CC) pour démarrer le temporisateur suite à un basculement de la sortie en mode CL.	CURR:PROT:DEL:STAR SCH
	Pour démarrer le temporisateur suite à un basculement de la sortie en mode CL :
	CURR:PROT:DEL:STAR CCTR

4 Utilisation du système d'alimentations régénératrices

Les facteurs qui influent sur la durée du changement des réglages de sortie ou de charge sont les suivants : la différence entre l'ancienne et la nouvelle valeur de sortie, la limite de courant ou de tension, la capacité de la charge en mode de priorité de tension ou l'inductance de la charge en mode de priorité de courant. Le délai nécessaire doit être déterminé de manière empirique ; les caractéristiques du temps de réponse de programmation de la sortie peuvent être utilisées à titre de référence.

Il convient également de souligner que le temps nécessaire à la sortie pour basculer en mode de limite de courant (CL) varie selon l'importance de la surintensité par rapport à la valeur limite de courant. Par exemple, si la surintensité est légèrement supérieure à la limite de courant, plusieurs dizaines de millisecondes peuvent être nécessaires à la sortie pour activer le bit d'état CC. En revanche, si elle dépasse considérablement limite de courant, il peut suffire de quelques centaines de microsecondes à la sortie pour activer le bit d'état CL. Pour déterminer à quel moment la sortie sera interrompue, vous devez ajouter le temps nécessaire à l'activation du bit d'état CL au délai de protection contre les surintensités. Si la surintensité persiste au-delà de la somme des deux intervalles de temps, la sortie est interrompue.

En fonctionnement principal/secondaire, le partage du courant pendant les transitions rapides du courant de charge pourrait entraîner un faux déclenchement de la protection si l'OCP est programmé indépendamment sur chaque appareil. Il est recommandé de programmer l'OCP uniquement pour l'appareil principal. L'OCP principale/secondaire est mis en œuvre par le microprogramme de l'appareil principal qui interroge l'état de chaque appareil secondaire. Notez cependant que cela peut entraîner un délai de 0,5 seconde.

Temporisateur de surveillance de la sortie

Lorsqu'il est activé, le temporisateur de surveillance fait basculer la sortie en mode de protection en l'absence d'activité d'E/S SCPI sur les interfaces de commande à distance (USB, LAN, GPIB) dans le délai spécifié par l'utilisateur. Notez que la fonction de temporisateur de surveillance n'est PAS réinitialisée par une activité sur le panneau avant : la sortie est interrompue une fois le délai écoulé.

À l'expiration du délai, la sortie est désactivée, mais l'état de sortie programmé ne change pas. Le bit Prot (Protection) du registre des événements d'état suspect ainsi que le voyant Prot (Protection) du panneau avant sont activés. Une protection de veille peut être désactivée, comme décrit dans la section Désactivation des fonctions de protection.

Vous pouvez programmer le délai de surveillance entre 1 et 3 600 secondes par incréments de 1 seconde. Pour activer le temporisateur de surveillance et spécifier une valeur de délai, procédez comme suit :

Aide-mémoire des menus du panneau avant	Commande SCPI
Sélectionnez Protect\WDog .	Pour activer le temporisateur de surveillance de la sortie :
Cochez la case Enable Watchdog (Activer la surveillance) pour activer le temporisateur de surveillance.	OUTP:PROT:WDOG ON
Saisissez une valeur dans la zone Watchdog Delay (Délai de surveillance). Appuyez ensuite sur Select .	Pour régler le temporisateur de surveillance de la sortie sur 120 secondes :
	OUTP:PROT:WDOG:DEL 120

Définir la protection contre les sous-tensions

REMARQUE Ces informations s'appliquent uniquement aux modèles RP793xA et RP794xA seulement. **RP793xA, RP794xA**

La fonction de protection contre les sous-tensions désactive la sortie si la tension de sortie passe sous le réglage de basse tension. Le circuit de tension contrôle la tension aux bornes de mesure + et –.

Cette fonction est utilisée lors de la décharge des batteries pour éviter que la tension des batteries ne passe en dessous du réglage de basse tension.

En mode de priorité de tension, la tension de sortie doit être à la valeur cible avant que la protection contre les sous-tensions ne soit activée pour éviter que l'appareil ne se déclenche pendant la programmation amont de la sortie. Il est possible de régler un délai plus long que le temps de programmation amont de la sortie pour éviter que la protection ne se déclenche pendant la transition de tension.

En mode de priorité de courant, si la sortie est activée avec la limite de tension réglée à une valeur inférieure au réglage de basse tension, la protection contre les sous-tensions se déclenche également.

Vous pouvez programmer le délai de protection contre les sous-tensions entre 20,48 et 2611 secondes par incréments de 20,48 secondes. Pour activer la protection contre les sous-tensions et spécifier une valeur de délai, procédez comme suit :

Aide-mémoire des menus du panneau avant	Commande SCPI
Sélectionnez Protect\UVP .	Pour régler le niveau UVP sur 2 volts :
Saisissez une valeur dans la zone de niveau UVP.	VOLT:PROT:LOW 2
Cochez ensuite Enable UVP	Pour activer la protection contre les sous-tensions :
Saisissez une valeur dans la zone UVP Delay (Délai d'UVP).	VOLT:PROT:LOW:STAT ON
Appuyez ensuite sur Select .	Pour spécifier un délai de protection de 5 secondes :
	VOLT:PROT:LOW:DEL 5

Supprimer la protection de la sortie

Si une condition de surtension, de surintensité, de surchauffe, de panne d'alimentation secteur, de limitation de puissance, de protection ou de signal d'inhibition est vérifiée, la sortie est désactivée. Le voyant d'état de fonctionnement approprié situé sur le panneau avant s'allume. Pour annuler la fonction de protection et retourner à un mode de fonctionnement normal, commencez par éliminer la condition à l'origine de la défaillance de protection. Ensuite, annulez la fonction de protection comme suit :

Aide-mémoire des menus du panneau avant	Commande SCPI
---	---------------

4 Utilisation du système d'alimentations régénératrices

Sélectionnez **Protect\Clear**.

Pour corriger une défaillance de protection :

Sélectionnez Clear.

OUTP:PROT:CLE

REMARQUE

La sortie est réactivée dès que la fonction de protection de sortie est effacée.

Programmation des transitoires de sortie

Actions communes à tous les transitoires

Programmation d'un transitoire de palier

Programmation d'un transitoire de liste

Programmation d'un signal arbitraire

Limitation des sorties sinusoïdales

Transitoires de sortie

Un transitoire de sortie se définit comme une action déclenchée qui provoque une variation de tension ou de courant en sortie. Les trois types de transitoires disponibles sont les suivants : palier, liste et signaux arbitraires.

Step : un palier de sortie est un événement ponctuel qui augmente ou réduit la tension ou le courant en réponse à un déclenchement.

List : une liste décrit une séquence complexe et parfaitement synchronisée des paliers ou variations de sortie.

Arbitrary Waveform : un générateur de signaux arbitraires (Arb) permet à la sortie de générer des signaux de tension ou de courant complexes définis par l'utilisateur et pouvant comporter jusqu'à 65 535 points de données.

Actions communes à tous les transitoires

- Activer la fonction de transitoire de sortie
- Programmer les paramètres de transitoire
- Sélectionner la source de déclenchement
- Démarrer le système de transitoire
- Déclencher le transitoire

Le processus de déclenchement du transitoire est illustré ci-dessous. Ce dernier vaut pour tous les types de transitoires. Les flèches situées à droite sont propres aux transitoires de liste. Pour une vue d'ensemble du système de déclenchement, reportez-vous à la section **Présentation des déclenchements**.

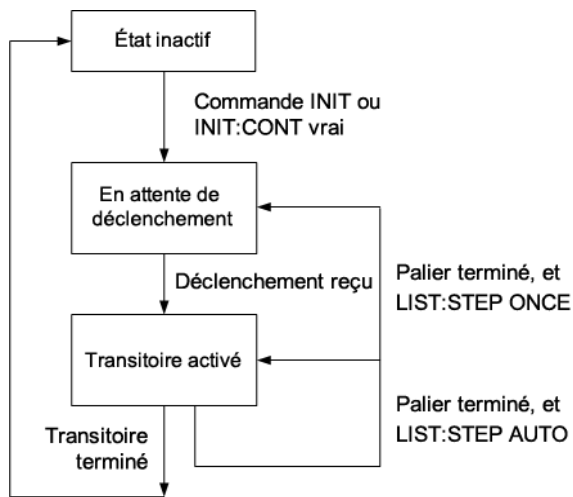

Activer la fonction de transitoire de sortie

Tout d'abord, vous devez activer la sortie pour répondre aux déclenchements de transitoires. Si une fonction de transitoire de sortie n'est pas activée, aucune action ne se produit, même si vous avez programmé les paramètres de transitoire et généré un déclenchement de transitoire.

Aide-mémoire des menus du panneau avant	Commande SCPI
<p>Sélectionnez Transient\Mode.</p> <p>Si vous opérez en mode de priorité de tension, sélectionnez le mode Voltage. Si vous êtes en mode de priorité de courant, sélectionnez le mode Current.</p> <p>Dans la liste déroulante, sélectionnez l'un des transitoires : Step (Palier), List (Liste) ou Arb transients (Transitoires arbitraires). Appuyez ensuite sur Select.</p>	<p>Pour activer la fonction de transitoire, utilisez la commande suivante :</p> <p>VOLT:MODE STEP VOLT:MODE LIST VOLT:MODE:ARB</p> <p>ou</p> <p>CURR:MODE STEP CURR:MODE:LIST CURR:MODE:ARB</p>

REMARQUE En mode Step, la valeur déclenchée devient la valeur immédiate à la réception du signal de déclenchement. En mode Fixed, les signaux de déclenchement sont ignorés ; les valeurs immédiates restent effectives à la réception d'un signal de déclenchement.

Programmer les paramètres de transitoire

Par exemple, réglez le niveau de tension déclenché si vous programmez un palier de tension :

Aide-mémoire des menus du panneau avant	Commande SCPI
<p>Sélectionnez Transient\Step.</p> <p>Sélectionnez la zone Trig Voltage pour régler la tension. Saisissez une valeur et appuyez sur Select.</p>	<p>Pour régler un niveau de palier de tension sur 15 V :</p> <p>VOLT:TRIG 15</p>

Sélectionner la source de déclenchement

REMARQUE L'exécution d'une commande TRIGger:TRANsient[:IMMediate] sur le bus génère toujours un déclenchement de transitoire immédiat, quelle que soit la source de déclenchement sélectionnée.

Si vous n'utilisez pas le menu du panneau avant ou une commande TRIGger:TRANsient[:IMMediate] pour déclencher le transitoire, sélectionnez une source de déclenchement à partir des options suivantes :

Source de déclenchement	Description
Bus	Sélectionne un déclenchement de périphérique GPIB, *TRG ou <GET> (Group Execute Trigger).
External	Sélectionne TOUTE broche configurée comme entrée de déclenchement sur le port de commande numérique.
Immediate	Déclenche le transitoire dès que la commande INITiated est exécutée.
Pin <1-7>	Sélectionne une broche <n> spécifique qui est configurée comme entrée de déclenchement sur le port de commande numérique.

Les commandes suivantes permettent de sélectionner une source de déclenchement :

Aide-mémoire des menus du panneau avant	Commande SCPI
Sélectionnez Transient\TrigSource .	Pour sélectionner des déclenchements par bus :
Pour sélectionner des déclenchements immédiats, sélectionnez l'option Imm.	TRIG:TRAN:SOUR BUS
Pour sélectionner des déclenchements par bus, sélectionnez l'option Bus.	Pour sélectionner la broche numérique 5 comme déclencheur :
Pour sélectionner la broche numérique 5 comme déclencheur, sélectionnez l'option Pin 5 (Broche 5) ou EXT (Externe).	TRIG:TRAN:SOUR PIN5

Démarrer le système de transitoire

Si l'appareil est sous tension, le système de déclenchement est à l'état inactif. Dans cet état, le système de déclenchement est désactivé, ignorant ainsi tous les déclenchements. Les commandes INITiate permettent au système de déclenchement de recevoir des signaux de déclenchement.

Aide-mémoire des menus du panneau avant	Commande SCPI
Sélectionnez Transient\Control .	Pour démarrer le système de déclenchement de transitoire :
Parcourez la liste jusqu'à l'option Initiate. Appuyez ensuite sur Select .	INIT:TRAN

4 Utilisation du système d'alimentations régénératrices

Il ne faut que quelques millisecondes à l'instrument pour être prêt à recevoir un signal de déclenchement une fois la commande INITiate:TRANSient reçue. Si un déclenchement se produit avant que le système de déclenchement soit prêt, le déclenchement est ignoré. Vous pouvez tester le bit WTG_tran du registre d'état de fonctionnement pour savoir quand l'instrument est prêt à recevoir un signal de déclenchement après avoir été initialisé.

Aide-mémoire des menus du panneau avant	Commande SCPI
Sélectionnez Transient\Control . Le champ Trig state indique "Initiated".	Pour connaître le bit WTG_tran (bit 4) : STAT:OPER:COND?

Si la valeur de bit 16 est renvoyée par la requête, le bit WTG_tran est vrai et l'instrument est prêt à recevoir le signal de déclenchement. Voir **Didacticiel d'état**.

REMARQUE À moins que la commande INITiate:CONTInuous:TRANSient ne soit programmée, l'instrument exécute un transitoire chaque fois qu'un signal de déclenchement est reçu. Ainsi, il sera nécessaire de démarrer le système de déclenchement chaque fois qu'un autre transitoire déclenché est souhaité.

Déclencher le transitoire

Le système de déclenchement attend un signal de déclenchement à l'état initialisé. Vous pouvez déclencher immédiatement le transitoire comme suit :

Aide-mémoire des menus du panneau avant	Commande SCPI
Sélectionnez Transient\Control . Sélectionnez Trigger pour générer un signal de déclenchement immédiat, quelle que soit la valeur source de déclenchement.	Pour générer un déclenchement de transitoire : TRIG:TRAN Autrement, si la source de déclenchement est BUS, vous pouvez également programmer une commande *TRG ou une commande IEEE-488 <get>.

Si une broche numérique est configurée comme source de déclenchement, l'instrument attend indéfiniment le signal de déclenchement. En l'absence de déclenchement, vous devez renvoyer manuellement le système de déclenchement à l'état inactif. Les commandes suivantes renvoient le système de déclenchement à l'état inactif :

Aide-mémoire des menus du panneau avant	Commande SCPI
Sélectionnez Transient\Control . Sélectionnez ensuite la commande Abort.	ABOR:TRAN

À la réception d'un signal de déclenchement, les fonctions déclenchées sont définies sur leurs valeurs de transitoire programmées. Une fois les actions déclenchées terminées, le système de déclenchement retourne à l'état inactif.

Vous pouvez tester le bit TRAN-actif dans le registre d'état de fonctionnement pour savoir quand le système de déclenchement de transitoire est retourné à l'état inactif.

Aide-mémoire des menus du panneau avant	Commande SCPI
Sélectionnez Transient\Control . Le champ Trig state indique "Idle".	Pour connaître le bit TRAN-actif (bit 6) : STAT:OPER:COND?

Si la valeur du bit renvoyée par la requête est 64, le bit TRAN-actif est vrai et l'action de transitoire n'est PAS terminée. Si le bit TRAN-actif est faux, l'action de transitoire est terminée. Pour plus d'informations, reportez-vous à la section **Didacticiel d'état**.

Programmation d'un transitoire de palier

Programmer les niveaux de palier

Les commandes suivantes permettent de programmer le niveau de palier de sortie déclenché. La sortie passe à ce niveau à la réception du signal de déclenchement. Dans le menu du panneau avant, vous pouvez uniquement programmer le niveau de palier selon le mode de priorité dans lequel vous vous trouvez : priorité de tension ou de courant.

Aide-mémoire des menus du panneau avant	Commande SCPI
Sélectionnez Transient\Step . Sélectionnez la zone Trig Voltage pour régler la tension. Sélectionnez la zone Trig Current pour régler le courant. Saisissez une valeur et appuyez sur Select.	Pour régler un niveau de palier de tension sur 15 V : VOLT:TRIG 15 Pour régler un niveau de palier de courant sur 1 A : CURR:TRIG 1

Générer un signal de sortie de déclenchement

Le palier de sortie peut générer un signal de déclenchement pouvant être acheminé vers une broche du port numérique qui a été configurée comme sortie de déclenchement (TOUT). Les commandes suivantes permettent de générer un signal de déclenchement lorsque le palier se produit :

Aide-mémoire des menus du panneau avant	Commande SCPI
Sélectionnez Transient\Step . Cochez la case Enable Trigger Output (Activer la sortie de déclenchement). Appuyez ensuite sur Select .	Pour programmer un signal de déclenchement de palier, utilisez : STEP:TOUT ON

Programmation d'un transitoire de liste

- **Programmer les niveaux de liste**
- **Programmer les durées de palier**
- **Spécifier la cadence de liste**
- **Spécifier tous les signaux de déclenchement que la liste doit générer**

4 Utilisation du système d'alimentations régénératrices

- **Indiquer le nombre de fois que la liste doit se répéter**
- **Indiquer comment la liste doit se terminer**

Les listes vous permettent de générer des séquences complexes de variations de sortie à l'aide d'une temporisation rapide et précise, qui peut être synchronisée avec des signaux internes ou externes. Contrairement à un palier de sortie, qui représente une variation de sortie ponctuelle, une liste de sortie est une séquence de variations de sortie. Les listes peuvent contenir jusqu'à 512 paliers programmés individuellement et peuvent être configurées pour se répéter. Seuls les paramètres associés à l'un des modes de priorité (priorité de tension ou priorité de courant) peuvent être contrôlés par une liste.

Les listes de tension et de courant sont cadencées par une liste de paliers distincte qui définit la durée ou pause de chaque palier. Chacun des 512 paliers peut être associé à une durée de palier unique, qui indique le temps en secondes durant lequel la liste demeure sur ce palier avant de passer au palier suivant. Reportez-vous à **LIST:DWEL** pour plus d'informations sur la plage et la résolution de temporisation.

Les listes peuvent également être à pas de déclenchement. Dans ce cas, la liste avance d'un palier à chaque déclenchement reçu. Cela est utile si vous souhaitez qu'une liste de sortie suive de près les événements déclenchés. Dans une liste à pas de déclenchement, les déclenchements reçus pendant la durée de palier sont ignorés. Vous pouvez régler le temps de palier de la liste sur zéro pour vous assurer qu'aucun déclenchement n'est perdu.

Les listes peuvent également générer des signaux de déclenchement sur des paliers spécifiques. Cette opération est effectuée par deux listes supplémentaires : une liste BOST (début de palier) et une liste EOST (fin de palier). Ces listes déterminent les paliers qui génèrent un signal de déclenchement et si ce dernier est généré au début ou à la fin du palier. Ces signaux de déclenchement permettent de synchroniser d'autres événements avec la liste.

Toutes les listes (tension, courant, palier, BOST, EOST) doivent être définies sur le même nombre de paliers. Sinon, une erreur se produit lorsque la liste est exécutée. Pour des raisons pratiques, une liste peut être programmée avec un palier ou une valeur unique. Dans ce cas, une liste à palier unique est traitée comme si elle contenait le même nombre de paliers que les autres listes, toutes les valeurs étant égales à une seule valeur.

Les données de la liste ne sont pas enregistrées avec l'état enregistré d'un instrument.

REMARQUE

Si vous utilisez des listes ou des signaux arbitraires pour générer des sinusoïdes proches de la fréquence du réseau, des courants de distorsion supplémentaires se produisent dans la ligne. Reportez-vous à la section **Limitation des sorties sinusoïdales**.

Programmer les niveaux de liste

Exemple 1 Si vous programmez une impulsion de tension ou un train d'impulsions, réglez l'amplitude de l'impulsion. Par exemple, pour générer une impulsion d'une amplitude de 15 V, programmez l'amplitude de l'impulsion (palier 0) et l'amplitude du temps de désactivation (palier 1).

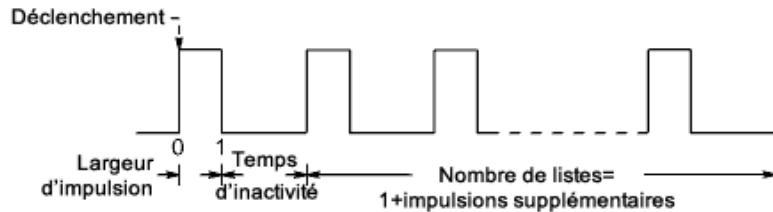

Aide-mémoire des menus du panneau avant	Commande SCPI
<p>Sélectionnez Transient>List\Config.</p> <p>Sélectionnez List Step 0 (Palier de liste 0) (l'impulsion) et saisissez une valeur de tension de 15. Appuyez sur Select .</p> <p>Sélectionnez List Step 1 (Palier de liste 1) (le temps de désactivation) et saisissez une valeur de tension de 0. Appuyez sur Select . Utilisez les flèches de direction haut/vers le bas pour sélectionner le palier suivant.</p>	<p>Pour programmer l'amplitude du palier 0 (l'impulsion) et le palier 1 (le temps de désactivation) :</p> <p>LIST:VOLT 15,0</p>

Exemple 2 Si vous programmez une liste de tension des signaux arbitraires, indiquez les amplitudes de la liste. L'ordre dans lequel les valeurs sont saisies détermine l'ordre dans lequel les valeurs seront générées. Pour générer la liste de tensions illustrée dans la figure, une liste peut inclure les valeurs suivantes : 9, 0, 6, 0, 3, 0 :

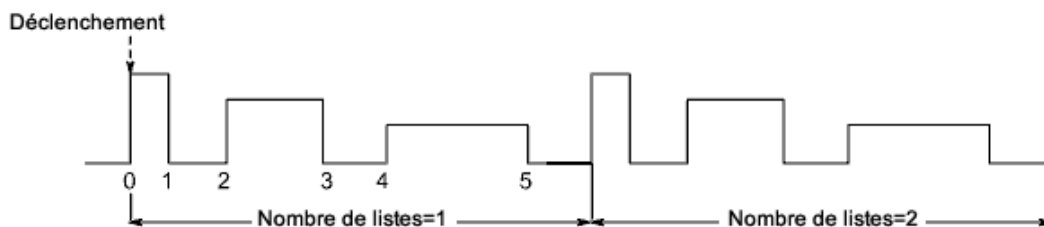

Aide-mémoire des menus du panneau avant	Commande SCPI
<p>Sélectionnez Transient>List\Config.</p> <p>Sélectionnez le numéro de palier de liste et saisissez une valeur de tension. Appuyez sur Select .</p> <p>Répétez cette opération pour chaque palier. Utilisez les flèches de direction haut/vers le bas pour sélectionner le palier suivant.</p>	<p>Pour programmer une liste de tensions de 5 paliers :</p> <p>LIST:VOLT 9,0,6,0,3,0</p>

Programmer les durées de palier

Exemple 1 Si vous programmez une impulsion de tension, réglez le temps de palier de la largeur d'impulsion. Indiquez également le palier du temps de désactivation. Cela est nécessaire si vous générez un train d'impulsions, car le temps de désactivation détermine l'intervalle entre les impulsions. Pour générer une impulsion dotée d'une largeur de 1 seconde et un temps de désactivation de 2 secondes, utilisez la commande suivante :

Aide-mémoire des menus du panneau avant	Commande SCPI
<p>Sélectionnez Transient>List\Config.</p> <p>Sélectionnez List Step 0 (Palier de liste 0) (l'impulsion) et saisissez une valeur de palier de 1. Appuyez sur Select .</p> <p>Sélectionnez List Step 1 (Palier de liste 1) (le temps de désactivation) et saisissez une valeur de palier de 2. Appuyez sur Select . Utilisez les flèches de direction haut/vers le bas pour sélectionner le palier suivant.</p>	<p>Pour programmer le temps du palier 0 (l'impulsion) et du palier 1 (le temps de désactivation) :</p> <p>LIST:DWEL 1,2</p>

Une impulsion unique est à présent configurée. Si vous souhaitez générer un train d'impulsions, indiquez simplement le nombre de répétitions d'impulsions comme décrit dans la section « Spécifier le nombre de répétitions de la liste ».

Exemple 2 Si vous programmez une liste de tension des signaux arbitraires, indiquez les amplitudes de la liste. Les valeurs de palier déterminent l'intervalle, en secondes, durant lequel la sortie demeure sur chaque palier dans la liste avant de passer au palier suivant. Pour spécifier les six intervalles de palier dans la figure, une liste peut inclure les valeurs suivantes : 2, 3, 5, 3, 7, 3 :

Aide-mémoire des menus du panneau avant	Commande SCPI
<p>Sélectionnez Transient>List\Config.</p> <p>Sélectionnez le numéro de palier de liste et saisissez une valeur de palier. Appuyez sur Select .</p> <p>Répétez cette opération pour chaque palier. Utilisez les flèches de direction haut/vers le bas pour sélectionner le palier suivant.</p>	<p>Pour programmer un temps de palier de 5 valeurs, utilisez la commande suivante :</p> <p>LIST:DWEL 2,3,5,3,7,3</p>

REMARQUE Le nombre de paliers de pause doit être égal au nombre de paliers de tension. Si une liste de paliers ne comporte qu'une seule valeur, cette dernière sera appliquée à tous les paliers de la liste.

Spécifier la cadence de liste

Vous pouvez déterminer si la liste doit être à temps de palier ou à pas de déclenchement. Par défaut, la liste est à temps de palier.

Dans une liste à temps de palier, chaque palier se voit affecté un temps spécifique. Le temps de palier détermine la durée pendant laquelle la sortie demeure sur le palier. À l'expiration de chaque durée de palier, le palier suivant est immédiatement généré.

Dans une liste à pas de déclenchement, la liste avance d'un palier à chaque déclenchement reçu. Vous pouvez également définir une durée de palier si vous souhaitez ignorer les déclenchements pendant ce temps ou garantir un temps de palier minimal entre les paliers de liste déclenchés.

Aide-mémoire des menus du panneau avant	Commande SCPI
Sélectionnez Transient>List\Pace .	Pour configurer la liste en fonction d'un temps de palier :
Sélectionnez Dwell paced (Temps de palier) ou Trigger paced (Pas de déclenchement). Appuyez ensuite sur Select .	LIST:STEP AUTO
	Pour configurer la liste en fonction d'un pas de déclenchement :
	LIST:STEP ONCE

Spécifier tous les signaux de déclenchement que la liste doit générer

Vous pouvez générer des signaux de déclenchement pouvant être acheminés vers d'autres destinations. Par exemple, vous pouvez utiliser des signaux de déclenchement pour déclencher des actions sur un équipement externe raccordé au port numérique. La figure suivante contient un exemple de génération de quatre signaux de déclenchement sur la liste de signaux arbitraires fournie dans l'exemple 2.

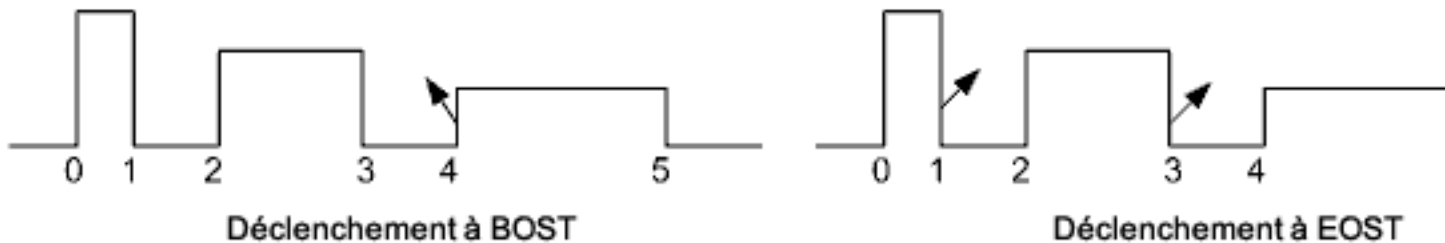

Aide-mémoire des menus du panneau avant	Commande SCPI
Sélectionnez Transient>List\Config .	Pour programmer un déclenchement au début du palier 4 :
Sélectionnez le numéro de palier de liste 4. Pour générer un déclenchement, entrez 1 dans le champ Tout Begin Step (Palier de début de tension de sortie).	LIST:TOUT:BOST 0,0,0,0,1,0
Sélectionnez les numéros de palier de liste 0, 2 et 4. Pour générer un déclenchement, entrez 1 dans le champ Tout End Step (Palier de fin de tension de sortie).	Pour programmer un déclenchement à la fin des paliers 0, 2 et 4 :
	LIST:TOUT:EOST 1,0,1,0,1,0
Si vous saisissez des zéros dans les champs, aucun déclenchement n'est généré pour le palier.	

Indiquer le nombre de fois que la liste doit se répéter

Vous pouvez déterminer le nombre de fois que vous souhaitez répéter la liste (ou l'impulsion). Lors de la réinitialisation, le nombre de répétitions de la liste est défini sur 1. L'envoi du paramètre INFINITY à la commande SCPI permet de répéter la liste indéfiniment.

Aide-mémoire des menus du panneau avant	Commande SCPI
Sélectionnez Transient\List\Repeat . Saisissez le nombre de répétitions de liste (2) et appuyez sur Select.	Pour programmer la liste afin qu'elle soit répétée deux fois : LIST:COUN 2

Indiquer comment la liste doit se terminer

Spécifiez l'état de sortie une fois la liste terminée. Deux options possibles : la sortie retourne à la valeur qui était appliquée avant le démarrage de la liste, ou la sortie demeure sur la valeur du dernier palier de liste.

Aide-mémoire des menus du panneau avant	Commande SCPI
Sélectionnez Transient\List\Terminate . Sélectionnez Return to Start (Retour pour commencer) ou Stop at Last Step (Arrêter au dernier palier), puis appuyez sur Select.	Pour renvoyer la sortie à l'état précédant la liste : LIST:TERM:LAST OFF Pour maintenir la sortie à l'état de fin de la liste : LIST:TERM:LAST ON

Programmation d'un signal arbitraire

- **Spécifier le type de signal arbitraire et le palier**
- **Configurer le signal arbitraire**
- **Indiquer le nombre de fois que le signal arbitraire doit se répéter**
- **Indiquer comment le signal arbitraire doit se terminer**

REMARQUE Si vous utilisez des listes ou des signaux arbitraires pour générer des sinusoïdes proches de la fréquence du réseau, des courants de distorsion supplémentaires se produisent dans la ligne. Reportez-vous à la section **Limitation des sorties sinusoïdales**.

La sortie des modèles Keysight RPS peut être modulée par le générateur de signaux arbitraires intégré à l'instrument. Cela permet à la sortie de générer des signaux de tension ou de courant complexes définis par l'utilisateur. Vous trouverez ci-dessous les principales caractéristiques du générateur de signaux arbitraires à palier constant :

- Génèrent des signaux arbitraires de tension ou de courant.
- Les signaux arbitraires peuvent contenir jusqu'à 65 535 points de données.

- Une valeur de temps d'attente unique s'applique à chaque point du signal arbitraire constant (voir **ARB:VOLT:CDW:DWEL** pour les informations sur le temps d'attente).
- Seul le signal arbitraire correspondant au mode de priorité actif (tension ou courant) peut être généré.

Spécifier le type de signal arbitraire et le palier

Pour spécifier le type de signal arbitraire et le temps de palier :

Aide-mémoire des menus du panneau avant	Commande SCPI
Sélectionnez Transient\Arb\Config . Dans la liste déroulante, sélectionnez un signal arbitraire de tension ou de courant. Appuyez ensuite sur Select . Saisissez une valeur de temps dans le champ Dwell (Temps de palier). Appuyez ensuite sur Select .	Pour spécifier un signal arbitraire de tension ou de courant : ARB:FUNC:TYPE VOLT ARB:FUNC:TYPE CURR Pour spécifier un temps d'attente de 1 milliseconde : ARB:VOLT:CDW:DWEL 0.001 ARB:CURR:CDW:DWEL 0.001

Configurer le signal arbitraire

Notez qu'il est uniquement possible d'afficher les points de données du signal arbitraire sur le panneau avant. Vous ne pouvez pas programmer de données de signal arbitraire à partir du panneau avant. Vous devez utiliser les commandes SCPI **ARB:CURREnt:CDWell** ou **ARB:VOLTage:CDWell** pour programmer les données de signal arbitraire.

Aide-mémoire des menus du panneau avant	Commande SCPI
Sélectionnez Transient\Arb\Config . Si les points du signal arbitraire ont été importés ou programmés à l'aide de la commande SCPI, le champ Points indique le nombre de points du signal arbitraire. Pour afficher l'amplitude d'un point de signal arbitraire, entrez le numéro de points dans le champ Point # (N° de point). Le champ Level (Niveau) indique l'amplitude.	Pour programmer 10 points dans un signal arbitraire de courant : ARB:CURR:CDW 1,2,2,3,4,4,3,2,2,1 Pour connaître le nombre de points du signal arbitraire : ARB:CURR:CDW:POIN? Pour connaître les valeurs de point du signal arbitraire : ARB:CURR:CDW?

Indiquer le nombre de fois que le signal arbitraire doit se répéter

Selon votre application, indiquez le nombre de fois que le signal arbitraire doit être répété. L'envoi du paramètre INFINITY à la commande SCPI permet de répéter le signal arbitraire indéfiniment. Lors de la réinitialisation, le nombre de répétitions du signal arbitraire est défini sur 1.

Aide-mémoire des menus du panneau avant	Commande SCPI
Sélectionnez Transient\Arb\Repeat . Saisissez le nombre de répétitions de liste (2) et appuyez sur Select .	Pour programmer le signal arbitraire afin qu'il soit répété deux fois : ARB:COUN 2

Indiquer comment le signal arbitraire doit se terminer

Spécifiez l'état de sortie une fois le signal arbitraire terminé. Deux options possibles : la sortie retourne à l'état dans lequel elle se trouvait avant le démarrage du signal arbitraire ou la sortie demeure sur les valeurs du dernier point de signal arbitraire.

Aide-mémoire des menus du panneau avant	Commande SCPI
Sélectionnez Transient\Arb\Terminate .	Pour renvoyer la sortie à l'état précédant le signal arbitraire : ARB:TERM:LAST OFF
Sélectionnez Return to Start (Retour pour commencer) ou Stop at Last Step (Arrêter au dernier palier), puis appuyez sur Select.	Pour maintenir la sortie sur le point final du signal arbitraire : ARB:TERM:LAST ON

Limitation des sorties sinusoïdales

Génération de sorties sinusoïdales

Les alimentations série RP7900 à tension unipolaire n'ont pas été conçues pour fonctionner comme une source ou une charge de courant alternatif sinusoïdal à la fréquence du réseau local. Dans ces conditions, l'appareil peut s'arrêter. Pour éviter ce problème lors de la génération de sorties sinusoïdales, vous devez éloigner la fréquence de sinusoïde de sortie de la fréquence du réseau local, comme indiqué dans les graphiques suivants.

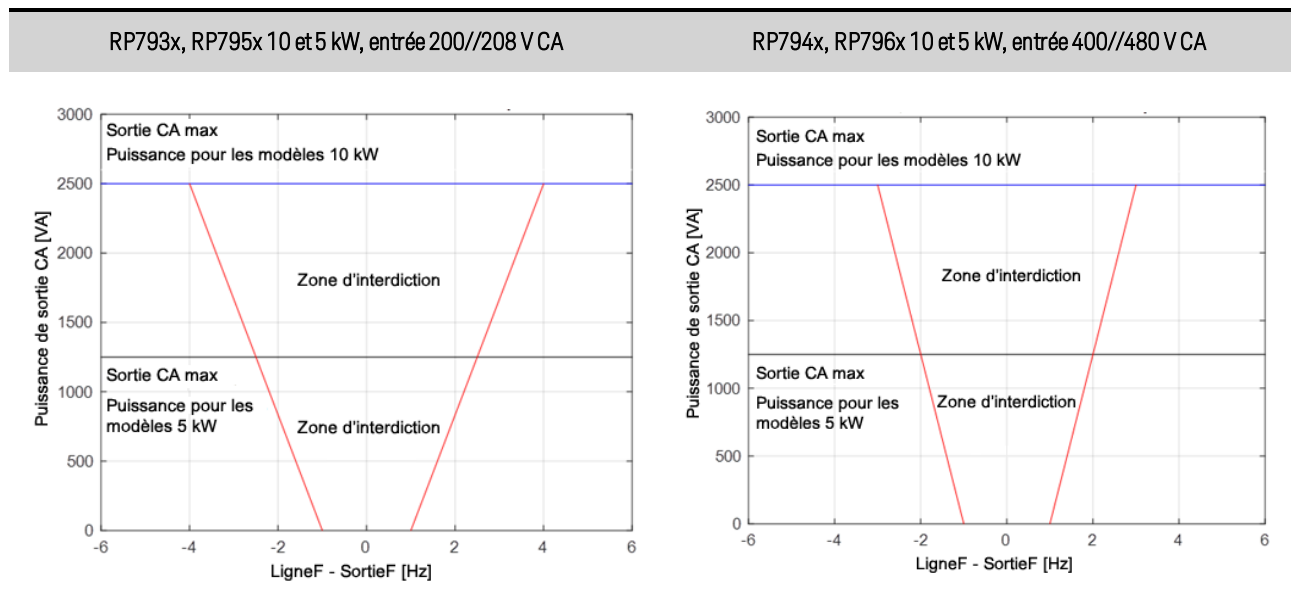

En supposant qu'une sinusoïde doit être imposée au-dessus d'une tension de décalage CC $(1/2) \cdot V_{\max}$, l'alimentation CA maximale possible est calculée ci-dessous. Notez que le fonctionnement de l'appareil à proximité de la fréquence du réseau local génère des harmoniques supplémentaires sur les lignes d'entrée CA.

$$V_{dc} = V_{\max}/2$$

$$V_{\text{sin_amplitude}} = V_{\text{max}}/2$$

$$V_{\text{ac_rms}} = V_{\text{max}}/(2*\sqrt{2})$$

$$I_{\text{sin_amplitude}} = I_{\text{max}}$$

$$I_{\text{ac_rms}} = I_{\text{max}}/\sqrt{2}$$

$$P_{\text{peak}} = (V_{\text{sin_amplitude}} + V_{\text{dc}})*I_{\text{max}}$$

$$P_{\text{ac}} = V_{\text{ac_rms}}*I_{\text{ac_rms}} = (V_{\text{max}}*I_{\text{max}})/4$$

Par exemple :

$$P_{\text{peak}} = (40 \text{ V} + 40 \text{ V}) * 125 \text{ A} = 10 \text{ kW}$$

$$P_{\text{ac}} = (80 \text{ V} * 125 \text{ A}) / 4 = 2,5 \text{ kW}$$

Notez que le P_{peak} instantané ne peut pas dépasser la puissance nominale CC de l'appareil.

Séquence de la sortie

Cette section décrit la procédure à suivre pour synchroniser les séquences d'activation et de désactivation des sorties sur un ou plusieurs appareils.

Délais d'activation/de désactivation

Couplage de la sortie

Séquence de plusieurs appareils

Comportement d'activation/de désactivation de la sortie

Délais d'activation/de désactivation

Tous les blocs d'alimentation présentent un décalage de délai interne qui s'applique entre le moment où une commande d'activation est reçue et le moment où la sortie est réellement activée. L'indication d'un décalage de délai commun sert de point de référence pour les délais d'activation des sorties programmés par l'utilisateur. Ce décalage défini par l'utilisateur permet également de connecter plusieurs blocs d'alimentation ensemble et de programmer des séquences d'activation précises sur plusieurs appareils. Le délai d'activation programmé par l'utilisateur est ensuite ajouté au point de référence commun défini par l'utilisateur.

Il n'est pas nécessaire d'indiquer un décalage de délai commun lorsque les sorties sont désactivées. Les sorties commencent à exécuter leurs délais de désactivation dès qu'une commande de désactivation de la sortie est reçue. Le décalage de délai interne est décrit dans le tableau suivant.

	Priorité de tension	Priorité de courant
Sans connecteur de l'appareil de déconnexion SD1000A	≤ 12 millisecondes	≤ 14 millisecondes
Avec connecteur de l'appareil de déconnexion SD1000A	≤ 158 millisecondes	≤ 167 millisecondes

Couplage de la sortie

En plus des commandes d'activation et de désactivation de la sortie du panneau avant et SCPI, vous pouvez utiliser les signaux OnCouple et OffCouple pour activer et désactiver la sortie. Ces signaux offrent un niveau de contrôle supplémentaire lors du séquençage de la sortie sur un ou plusieurs appareils.

La figure suivante illustre le chemin de programmation suivi lorsque les signaux OnCouple et OffCouple sont utilisés pour contrôler la sortie.

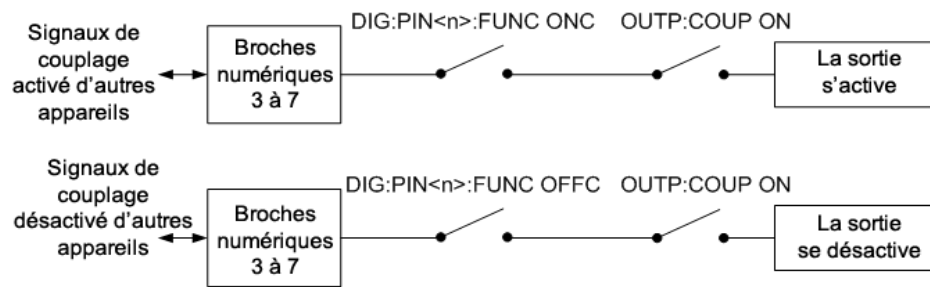

Comme indiqué dans la figure, vous pouvez configurer les broches 3 à 7 des ports numériques pour fournir les signaux OnCouple et OffCouple qui activent ou désactivent la sortie. La sortie est activée ou désactivée lorsque le signal correspondant est vrai. Pour plus d'informations sur la configuration des broches de ports numériques, reportez-vous à la section **Commande de couplage des sorties**.

Enfin, vous devez activer le séquençement de sortie afin qu'il utilise des signaux OnCouple et OffCouple pour activer ou désactiver la sortie. Voir Activer le séquençement de sortie ci-dessous.

Séquençement de plusieurs appareils

Pour définir l'activation de la sortie sur plusieurs appareils :

1. Connectez et configurez les broches du connecteur numérique de tous les appareils.
2. Activez la fonction de séquençement sur chaque appareil.
3. Spécifiez le délai d'activation programmé par l'utilisateur pour chaque appareil.
4. Cette étape est nécessaire si les blocs d'alimentation utilisés présentent **différents** décalages de délai minimaux (voir ci-dessous). Spécifiez un décalage de délai commun pour tous les appareils séquençés. Le décalage de délai commun doit être supérieur ou égal au décalage de délai maximal le plus grand. Une fois le décalage de délai commun terminé, les délais d'activation programmés par l'utilisateur sont appliqués.

Connecter et configurer les broches du connecteur numérique

Les broches du connecteur numérique des appareils séquençés doivent être connectées ensemble et configurées. Pour plus d'informations, reportez-vous à la section **Commande de couplage des sorties**.

Activer le séquençement de sortie

Le séquençement d'activation des sorties doit être activé sur chaque appareil qui participe à la synchronisation d'activation des sorties.

Aide-mémoire des menus du panneau avant	Commande SCPI
Sélectionnez Output\Sequence\Couple .	Pour activer le séquençement, envoyez la commande suivante :
Cochez la case Enable (Activer) pour activer le séquençement.	OUTP:COUP ON
Désélectionnez-la pour la désactiver.	Pour désactiver le séquençement, envoyez la commande suivante :
	OUTP:COUP OFF

Spécifier les délais d'activation et de désactivation pour chaque appareil

Les délais d'activation peuvent être spécifiés pour tous les appareils couplés. N'importe quelle séquence de délai peut être mise en œuvre. Il n'existe aucune restriction quant à la séquence ou à l'appareil qui est activé en premier.

Aide-mémoire des menus du panneau avant	Commande SCPI
Sélectionnez Output\Sequence\Couple .	Pour programmer un délai d'activation :
Spécifiez le délai d'activation en secondes.	OUTP:DEL:RISE 02
Répétez cette opération pour chaque appareil supplémentaire.	Répétez cette opération pour chaque instrument.

Des délais de désactivation peuvent également être spécifiés pour tous les appareils couplés. N'importe quelle séquence de délai peut être mise en œuvre. Il n'existe aucune restriction quant à la séquence ou à l'appareil qui est désactivé en premier.

Aide-mémoire des menus du panneau avant	Commande SCPI
Sélectionnez Output\Sequence\Delay .	Pour programmer un délai de désactivation :
Spécifiez le délai de désactivation en secondes.	OUTP:DEL:FALL .01
Répétez cette opération pour chaque appareil supplémentaire.	Répétez cette opération pour chaque instrument.

Spécifier le décalage de délai commun

REMARQUE Il n'est pas nécessaire d'indiquer un décalage de délai commun lorsque les sorties sont désactivées. Les sorties commencent à exécuter leurs délais de désactivation dès qu'une commande Output Off (Désactivation de sortie) est reçue (et que tout délai de désactivation programmé par l'utilisateur a expiré).

Spécifier un décalage de délai commun vous permet de synchroniser précisément les délais d'activation programmés par l'utilisateur lors du séquençage des alimentations avec différents décalages de délai internes.

Dans la figure suivante, vous pouvez voir comment les décalages de délais internes sont ajoutés aux délais programmés par l'utilisateur. Les décalages de délais internes varient en fonction du mode prioritaire et si un appareil SD1000A est connecté à l'alimentation électrique.

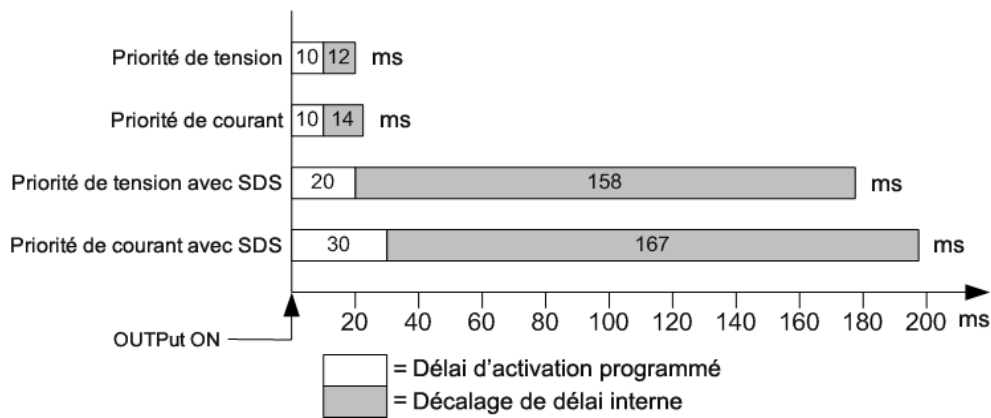

Même s'il n'est pas possible de supprimer les temps de décalage de délai interne, vous pouvez spécifier un décalage de délai commun afin de synchroniser avec précision les délais d'activation programmés par l'utilisateur. Si dans l'exemple ci-dessus, vous deviez programmer un décalage de délai commun de 170 ms, ce décalage de délai commun remplacerait alors les différents délais internes des appareils couplés. Le décalage commun de 170 ms synchroniserait effectivement le délai interne des appareils couplés.

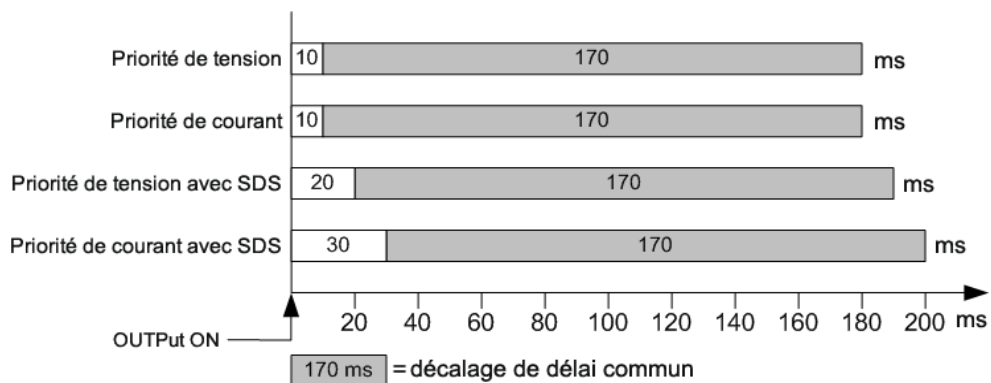

Le décalage de délai commun veille à ce que la synchronisation des délais d'activation programmés par l'utilisateur démarre à la fin du décalage de délai commun. Recherchez le décalage de délai de chaque appareil et utilisez le délai le plus lent comme décalage de délai commun.

Aide-mémoire des menus du panneau avant	Commande SCPI
<p>Sélectionnez Output\Sequence\Couple.</p> <p>Le champ Max delay offset (Décalage de délai max.) pour cette trame indique le décalage de délai de l'appareil.</p> <p>Saisissez la valeur de décalage de délai de l'appareil le plus lent dans le champ Delay offset (Décalage de délai) en millisecondes. Appuyez ensuite sur Select.</p>	<p>Pour rechercher le décalage de délai de l'appareil le plus lent :</p> <p>OUTP:COUP:MAX:DOFF?</p> <p>Pour spécifier le décalage de délai commun à l'aide du décalage de délai de l'appareil le plus lent :</p> <p>OUTP:COUP:DOFF 0.170</p>

REMARQUE Pour contourner les temps d'activation de relai supplémentaires du SD1000A, une commande **OUTPut:RElay:LOCK** non volatile peut être envoyée, après quoi le décalage de délai interne correspondra à celui des modèles sans appareils SD1000A connectés.

Comportement d'activation/de désactivation de la sortie

Les séquences d'activation/de désactivation sont principalement contrôlées par trois facteurs : les délais d'activation/de désactivation programmés par l'utilisateur, les réglages des modes de priorité de tension et de courant et le fonctionnement de l'appareil Keysight SD1000A (si installé).

Le tableau suivant décrit le réglage de l'impédance de sortie pour les séquences d'activation/de désactivation. Pour les modèles RP793xA et RP794xA uniquement, vous pouvez spécifier une impédance de sortie faible ou élevée lorsque vous travaillez en mode priorité tension.

Impédance d'activation/de désactivation de sortie pour	Priorité de tension	Priorité de courant
Modèles RP793xA; RP794xA	L'impédance peut être sélectionnée par l'utilisateur via Commande OUTPut:TMODE	Activation de l'impédance élevée Désactivation de l'impédance élevée
Modèles RP795xA; RP796xA	Activation de la faible impédance Désactivation de l'impédance élevée	Activation de l'impédance élevée Désactivation de l'impédance élevée

Les diagrammes suivants illustrent les séquences d'activation et de désactivation des sorties, suivis d'une description de chacune des actions. Notez que les sections sous « Avec SD1000A » ne s'appliquent que lorsque l'appareil Keysight SD1000A est installé.

Activation/désactivation - RP793xA et RP794xA

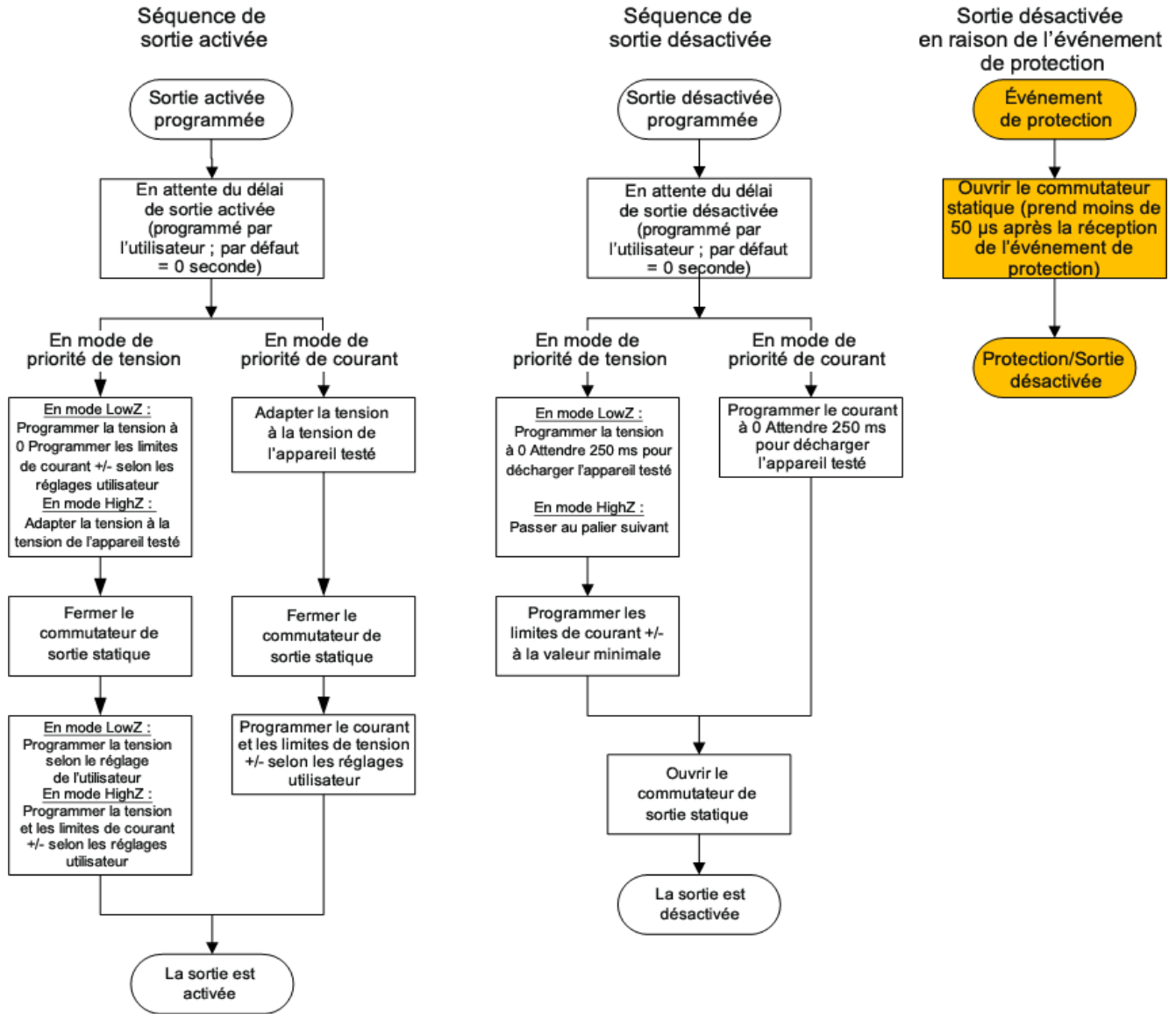

Activation/désactivation - RP795xA et RP796xA

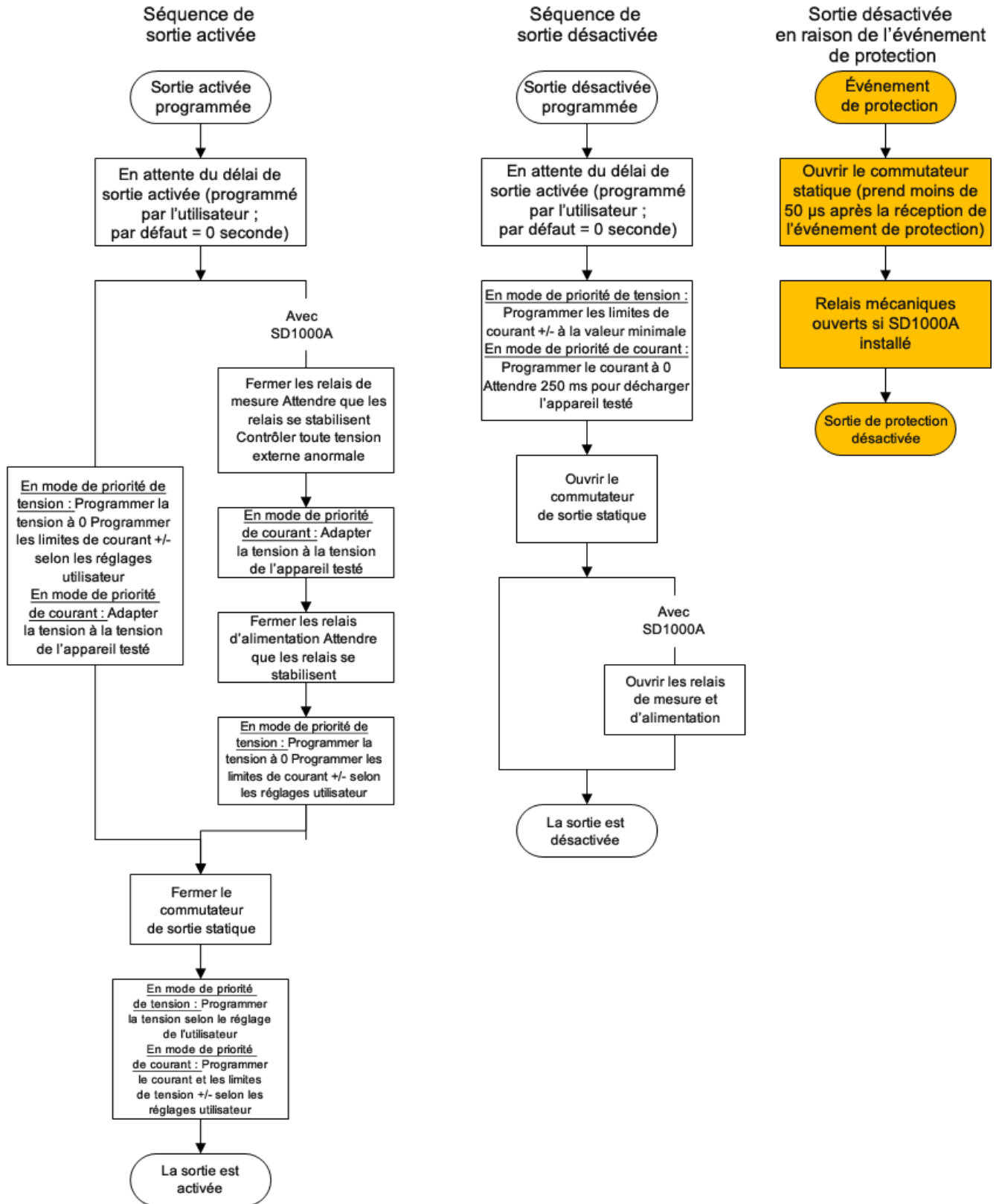

Séquence de sortie activée

À réception d'une commande de sortie activée, l'alimentation patiente pendant toute la durée du délai d'activation programmé par l'utilisateur.

En mode de priorité de tension avec LowZ, l'alimentation programme ses circuits internes sur une tension de zéro et définit les limites de courant sur leurs valeurs programmées par l'utilisateur. En mode de priorité de tension avec HighZ, l'alimentation correspond à la tension de l'appareil testé.

En mode de priorité de courant, l'alimentation correspond également à la tension de l'appareil testé. Ceci garantit que lorsqu'une source telle qu'une batterie est connectée à la sortie, il n'y a pas de surtension dans l'alimentation de l'appareil testé lorsque la sortie est activée.

Si un appareil SD1000A est connecté, le décalage du délai interne de l'appareil est nettement plus long. Ceci est dû aux temps de fermeture et de réglage des relais de mesure et de puissance du SDS. Si une tension anormale est détectée, les relais restent ouverts et une erreur est générée.

Le commutateur de sortie statique de l'alimentation est ensuite fermé, connectant ainsi la sortie aux circuits d'alimentation internes. La tension et le courant de sortie sont programmés selon les réglages de l'utilisateur. La sortie suit le réglage de la vitesse de balayage.

Séquence de sortie désactivée

À réception d'une commande de sortie désactivée, le bloc d'alimentation patiente pendant toute la durée du délai de désactivation programmé par l'utilisateur.

En priorité tension avec LowZ, l'alimentation programme la tension à zéro. Elle attend ensuite jusqu'à 250 ms pour décharger le courant de l'appareil testé. Elle programme ensuite les limites de courant sur leurs réglages minimums. En mode de priorité de tension avec HighZ, l'alimentation programme les limites de courant sur leurs réglages minimum.

En mode de priorité de courant, l'alimentation programme le courant sur zéro. Elle attend ensuite jusqu'à 250 ms pour décharger le courant de l'appareil testé.

Le commutateur de sortie statique de l'alimentation est ensuite ouvert, déconnectant ainsi la sortie des circuits d'alimentation internes. Si un appareil SD1000A est connecté, ses relais de mesure et de puissance sont ouverts.

REMARQUE Si vous souhaitez programmer une vitesse de balayage de désactivation de tension, vous devez régler la vitesse de balayage et programmer la tension de sortie à zéro *avant* d'envoyer la commande de désactivation de sortie.

De plus, les modèles RP795xA et RP796xA utilisent une résistance de 1 M Ω , et l'appareil SD1000A utilise une résistance de 25 k Ω pour l'option 500 et une résistance de 97,5 k Ω pour l'option 950 afin de programmer la tension de l'appareil testé.

Séquence de protection de la sortie désactivée

La séquence de protection de désactivation diffère de la séquence de désactivation normale en ce qu'elle désactive la sortie le plus rapidement possible. Lorsqu'un événement de protection est

4 Utilisation du système d'alimentations régénératrices

détecté, l'alimentation ouvre immédiatement le commutateur de sortie statique. Cela prend généralement moins de 50 µs après la détection initiale.

Si un appareil SD1000A est connecté, ses relais de sortie et de mesure sont ouverts à chaud.

Enregistrement de données externe

Sélection de la fonction et de la gamme de mesure

Spécifier la période d'intégration

Sélectionner la source de déclenchement des données externes (Elog)

Démarrer et déclencher l'enregistrement de données externe

Récupérer régulièrement les données

Interrompre l'enregistrement de données externe (Elog)

Enregistrement de données externe

REMARQUE

La fonction d'enregistrement de données externe peut être uniquement programmée à l'aide de commandes SCPI.

Les modèles Keysight RPS incluent une fonction d'enregistrement de données « externe » (Elog) qui vous permet d'enregistrer continuellement les mesures de tension et de courant. L'enregistrement des données s'effectue de façon externe à l'instrument, car il ne peut être mis en œuvre qu'à l'aide de commandes SCPI. Les données de mesure de la tension et du courant sont temporairement enregistrées dans une mémoire tampon FIFO (premier entré/premier sorti) située dans l'instrument. Cependant, cette mémoire est suffisamment volumineuse pour conserver environ 20 secondes de mesures cumulées. Autrement dit, vous devez vider régulièrement la mémoire tampon interne sur un périphérique de stockage externe, sous peine de remplacer les données de la mémoire.

Le tableau suivant décrit en détail les diverses fonctions d'enregistrement de données.

Fonction	Description
Data Storage (Stockage des données)	Met en mémoire tampon des mesures pendant environ 20 secondes et demande à l'ordinateur de lire régulièrement les mesures pour éviter tout dépassement de la mémoire tampon interne. L'ordinateur doit assurer le stockage de données externe.
Measurement Functions (Fonctions de mesure)	Le courant et la tension de sortie peuvent être enregistrés.
Integration Period (Période d'intégration)	Pendant la période d'intégration spécifiée, la moyenne des échantillons est calculée, et les valeurs minimale et maximale sont suivies.
Data viewing (Affichage des données)	Aucun affichage ou commande de panneau avant. Les données sont collectées et affichées en externe.

Notez que la fonction Elog utilise le **processus de déclenchement d'acquisition** pour effectuer les mesures.

Sélection de la fonction et de la gamme de mesure

Les commandes suivantes permettent de sélectionner une fonction de mesure :

Aide-mémoire des menus du panneau avant	Commande SCPI
Non disponible	Pour activer les mesures de la tension ou du courant : SENS:ELOG:FUNC:VOLT ON SENS:ELOG:FUNC:CURR ON
	Pour activer les mesures des valeurs min./max. : SENS:ELOG:FUNC:VOLT:MINM ON SENS:ELOG:FUNC:CURR:MINM ON

Spécifier la période d'intégration

La période d'intégration peut être comprise entre une valeur minimale de 102,4 microsecondes et une valeur maximale de 60 secondes.

Aide-mémoire des menus du panneau avant	Commande SCPI
Non disponible	Pour définir une période d'intégration de 600 microsecondes : SENS:ELOG:PER 0.0006

Pendant la période d'intégration, la moyenne des échantillons Elog est calculée, et les valeurs minimale et maximale sont suivies. À la fin de chaque période d'intégration, les valeurs moyenne, minimale et maximale sont ajoutées à la mémoire tampon FIFO interne.

Bien que la période d'intégration minimale absolue soit de 102,4 microsecondes, la valeur minimale réelle varie selon le nombre de mesures enregistrées. La formule se présente comme suit : 102,4_ microsecondes X nombre_de_mesures. Par exemple :

102,4 microsecondes : 1 mesure (tension ou courant)

204,8 microsecondes : 2 mesures (tension et courant)

409,6 microsecondes : 4 mesures (tension + valeur min. + valeur max. + courant)

Si la période d'intégration spécifiée coïncide avec les intervalles d'enregistrement minimum ou est proche de ces derniers, le format de données binaire doit être spécifié. Si le format REAL n'est pas spécifié, les données adoptent le format ASCII et les intervalles d'enregistrement minimum sont généralement jusqu'à cinq fois plus longs que ceux obtenus avec le format binaire.

Aide-mémoire des menus du panneau avant	Commande SCPI
Non disponible	Pour définir le format de données sur REAL : FORM[:DATA] REAL

Sélectionner la source de déclenchement des données externes (Elog)

La commande TRIGger:ELOG génère un déclenchement immédiat, quelle que soit la source de déclenchement. À moins d'utiliser cette commande, sélectionnez une source de déclenchement à partir des options suivantes :

Source de déclenchement	Description
Bus	Sélectionne un déclenchement de périphérique GPIB, *TRG ou <GET> (Group Execute Trigger).
External	Sélectionne TOUTE broche configurée comme entrée de déclenchement sur le port de commande numérique.
Immediate	Déclenche le transitoire dès que la commande INITiated est exécutée.
Pin<1-7>	Sélectionne une broche <n> spécifique qui est configurée comme entrée de déclenchement sur le port de commande numérique.

Les commandes suivantes permettent de sélectionner l'une des sources de déclenchement disponibles :

Aide-mémoire des menus du panneau avant	Commande SCPI
Non disponible	Pour sélectionner des déclenchements par bus : TRIG:ELOG:SOUR BUS Pour sélectionner la broche numérique 5 comme déclencheur : TRIG:ELOG:SOUR PIN5

Démarrer et déclencher l'enregistrement de données externe

Si l'alimentation est sous tension, le système de déclenchement est à l'état inactif. Dans cet état, le système de déclenchement est désactivé, ignorant ainsi tous les déclenchements. La commande INITiate permet au système de mesure de recevoir les signaux de déclenchements. Pour démarrer et déclencher l'enregistrement de données externe :

Aide-mémoire des menus du panneau avant	Commande SCPI
Non disponible	Pour démarrer l'enregistrement de données externe : INIT:ELOG Pour déclencher l'enregistrement de données externe : TRIG:ELOG Autrement, si la source de déclenchement est BUS, vous pouvez également programmer une commande *TRG ou une commande IEEE-488 <get>.

Une fois déclenchée, la fonction d'enregistrement de données externe commence à placer les données dans la mémoire tampon de mesure interne. La mémoire tampon étant suffisamment

volumineuse pour contenir 20 secondes de mesures cumulées, votre application logicielle doit régulièrement récupérer (ou rechercher) les données de cette mémoire.

Récupérer régulièrement les données

Chaque commande FETCh renvoie le nombre d'enregistrements demandés des données contenues dans la mémoire tampon et les supprime, libérant ainsi de la place pour des données supplémentaires. L'exécution de la fonction Elog se poursuit jusqu'à son interruption par l'utilisateur.

Un enregistrement Elog comprend un jeu de lectures de tension et de courant pour un seul intervalle de temps. Le format exact d'un enregistrement dépend des fonctions qui ont été activées pour la mesure Elog. Si toutes les fonctions sont activées, alors un enregistrement contiendra les données suivantes dans l'ordre spécifié :

Courant moyen
 Courant minimal
 Courant maximal
 Tension moyenne
 Tension minimale
 Tension maximale

Aide-mémoire des menus du panneau avant	Commande SCPI
Non disponible	Pour récupérer jusqu'à 1 000 enregistrements : FETC:ELOG? 1000

Les données ASCII (format par défaut) sont renvoyées sous forme d'ensembles de données numériques ASCII séparées par des virgules des valeurs moyennes/min/max et terminées par une nouvelle ligne. Les données REAL sont renvoyées sous forme de bloc de longueur définie, l'ordre des octets étant spécifié par la commande FORMat:BORDER.

Interrompre l'enregistrement de données externe (Elog)

Aide-mémoire des menus du panneau avant	Commande SCPI
Non disponible	Pour interrompre l'enregistrement de données externe : ABOR:ELOG

Réalisation de mesures

Mesures moyennes

Balayage de mesure

Fenêtrage de la mesure

Mesures A-heures et W-heures

Mesures numérisées

Déclenchement de la mesure

Mesures moyennes

Les modèles Keysight RPS sont équipés d'un voltmètre et d'un ampèremètre entièrement intégrés qui permettent de mesurer la tension et le courant fournis à la charge.

Chaque fois que l'alimentation est activée, le panneau avant mesure automatiquement la tension et le courant de sortie en acquérant un certain nombre de mesures durant le nombre spécifié de cycles de tension d'alimentation et en calculant la moyenne des échantillons. Le nombre par défaut de cycles de tension d'alimentation est de 1 cycle. Dans 1 cycle, le nombre d'échantillons (ou points) est de 3 255 à 60 Hz et de 3 906 à 50 Hz. L'intervalle d'échantillonnage par défaut est de 5,12 microsecondes.

Les commandes suivantes permettent d'effectuer une mesure :

Aide-mémoire des menus du panneau avant	Commande SCPI
<p>Sélectionnez la touche Meter.</p> <p>Appuyez continuellement sur la touche pour parcourir les fonctions de mesure suivantes :</p> <p>Voltage, Current (Tension, Courant)</p> <p>Voltage, Power (Tension, Puissance)</p> <p>Voltage, Current, Power (Tension, Courant, Puissance)</p> <p>Si des tirets s'affichent, la mesure sur le panneau avant est interrompue, car une mesure est en cours sur l'interface de commande à distance.</p>	<p>Pour mesurer la tension, le courant ou la puissance moyenne de sortie (CC) :</p> <p>MEAS:VOLT?</p> <p>MEAS:CURR?</p> <p>MEAS:POW?</p> <p>Pour renvoyer les données de mesure du tableau précédemment acquis :</p> <p>FETC:VOLT?</p> <p>FETC:CURR?</p> <p>FETC:POW?</p>

Balayage de mesure

Vous pouvez définir le temps de mesure en nombre de cycles de tension d'alimentation (NPLC). L'utilisation d'un nombre entier de cycles de tension d'alimentation peut réduire le bruit de mesure provenant des sources de fréquence réseau.

Aide-mémoire des menus du panneau avant	Commande SCPI
---	---------------

Sélectionnez **Measure\Sweep**.

Saisissez le nombre de cycles de tension d'alimentation dans le champ NPLC.

Appuyez ensuite sur **Select**.

Pour définir le nombre de cycles de tension d'alimentation à 10 :

SENS:SWE:NPLC 10

REMARQUE

La fréquence de secteur CA est détectée automatiquement pour la commande SENSE:SWEep:NPLC.

Fenêtrage de la mesure

Le fenêtrage est un processus de conditionnement des signaux qui réduit les erreurs dans les mesures de moyennes effectuées en présence de signaux périodiques et de bruit. Deux fonctions de fenêtre sont disponibles : Rectangulaire et de Hanning. À la mise sous tension, la fenêtre de mesure est rectangulaire.

La fenêtre rectangulaire calcule les mesures de moyennes sans aucun conditionnement de signal. Cependant, en présence de signaux périodiques, tels qu'une ondulation de ligne CA, une fenêtre rectangulaire peut introduire des erreurs lors du calcul des mesures de moyennes. Ce problème peut survenir lorsqu'un nombre non entier de cycles de données a été acquis en raison du dernier cycle partiel de données acquises.

L'une des manières de remédier à l'ondulation de la ligne CA consiste à utiliser une fenêtre de Hanning. La fenêtre Hanning applique une fonction de pondération \cos^4 aux données pour calculer les mesures moyennes. De cette manière, le bruit CA est atténué dans la fenêtre de mesure. Une atténuation optimale est possible lorsque la mesure inclut au moins trois cycles de signaux.

Aide-mémoire des menus du panneau avant	Commande SCPI
Sélectionnez Measure\Window . Sélectionnez Rectangular (Rectangulaire) ou Hanning. Appuyez ensuite sur Select .	Pour définir la fenêtre de mesure en mode Hanning : SENS:WIND HANN

Mesures A-heures et W-heures

Les mesures en ampères-heures et en watts-heures sont disponibles sur tous les modèles RPS. Ces mesures sont indépendantes des autres.

Les mesures en ampères-heures et en watts-heures sont créées en cumulant les mesures de courant et de puissance de toute la plage à une vitesse moyenne de 200 000 échantillons/seconde. Les accumulateurs peuvent contenir une quantité suffisante de données pendant au moins 100 000 heures.

La limite approximative de charge cumulée est $\pm(900\,000\,000 \cdot I_{\text{NOMINALE}})$ en coulombs ou $\pm(250\,000 \cdot I_{\text{NOMINALE}})$ en ampères-heures.

La limite approximative d'énergie cumulée est $\pm(1,100,000,000 \cdot P_{\text{NOMINALE}})$ en joules ou $\pm(310\,000 \cdot I_{\text{NOMINALE}})$ en watts-heures.

4 Utilisation du système d'alimentations régénératrices

I_{NOMINALE} correspond au courant NOMINAL de l'appareil. P_{NOMINALE} correspond à la puissance NOMINALE de l'appareil.

Renvoyer des mesures d'ampères-heures et watts-heures :

Aide-mémoire des menus du panneau avant	Commande SCPI
Sélectionnez Measure VAHWH. Affiche les ampères-heures et les watts-heures cumulées.	Renvoyer des ampères-heures et watts-heures : FETC:AHO? FETC:WHO?

Réinitialiser les mesures d'ampères-heures et watts-heures :

Aide-mémoire des menus du panneau avant	Commande SCPI
Sélectionnez Measure VAHWH. Sélectionnez Reset pour remettre les mesures à zéro.	Pour réinitialiser les ampères-heures et watts-heures : SENS:AHO:RES SENS:WHO:RES

Mesures numérisées

En plus des mesures de tension, de courant et de puissance moyennes, qui sont disponibles depuis le panneau avant et via les commandes SCPI, des mesures numérisées peuvent être renvoyées. Les mesures numérisées diffèrent des mesures moyennes, car vous pouvez sélectionner le type de mesure renvoyé et régler avec précision la qualité de la mesure.

Types de mesure

Les mesures numérisées suivantes sont disponibles. Ces dernières ne peuvent être mesurées qu'à l'aide de la commande SCPI correspondante.

ACDC est un calcul qui renvoie la mesure de valeur efficace vraie totale (CA + CC).

Le niveau **HIGH (ÉLEVÉ)** est un calcul qui génère un histogramme du signal en utilisant 16 cases entre les points de données maximal et minimal. La case contenant la plupart des points de données au-delà du point de 50 % est la case élevée. La moyenne de tous les points de données dans la case élevée est indiquée comme niveau High (Élevé). Si aucune case élevée ne contient plus de 1,25 % du nombre total de points acquis, le point de données maximal est renvoyé.

Le niveau **LOW (FAIBLE)** est un calcul qui génère un histogramme du signal en utilisant 16 cases entre les points de données maximal et minimal. La case contenant la plupart des points de données en dessous du point de 50 % est la case faible. La moyenne de tous les points de données dans la case faible est indiquée comme niveau Low (Faible). Si aucune case faible ne contient plus de 1,25 % du nombre total de points acquis, le point de données minimal est renvoyé.

MAX est la valeur maximale de la mesure numérisée.

MIN est la valeur minimale de la mesure numérisée.

Des requêtes de tableau permettant de renvoyer TOUTES les valeurs dans le tampon de mesure de tension et de courant sont également disponibles. Aucune moyenne n'est appliquée, seules les données brutes sont renvoyées par la mémoire tampon.

Aide-mémoire des menus du panneau avant	Commande SCPI
Non disponible	Pour mesurer la tension et le courant efficaces : MEAS:VOLT:ACDC? MEAS:CURR:ACDC?
	Pour mesurer le niveau élevé d'une impulsion : MEAS:VOLT:HIGH? MEAS:CURR:HIGH?
	Pour mesurer le niveau faible d'une impulsion : MEAS:VOLT:LOW? MEAS:CURR:LOW?
	Pour mesurer la valeur maximale : MEAS:VOLT:MAX? MEAS:CURR:MAX?
	Pour mesurer la valeur minimale : MEAS:VOLT:MIN? MEAS:CURR:MIN?
	Pour effectuer une mesure et renvoyer les données de tableau : MEAS:ARR:VOLT? MEAS:ARR:CURR? MEAS:ARR:POW?

Qualité de mesure

La figure suivante illustre la relation entre les échantillons (ou points) de mesure et l'intervalle qui sépare les échantillons dans une mesure type. Vous pouvez régler la mesure avec précision en indiquant le nombre de points dans l'acquisition de la mesure ainsi que l'intervalle entre les points.

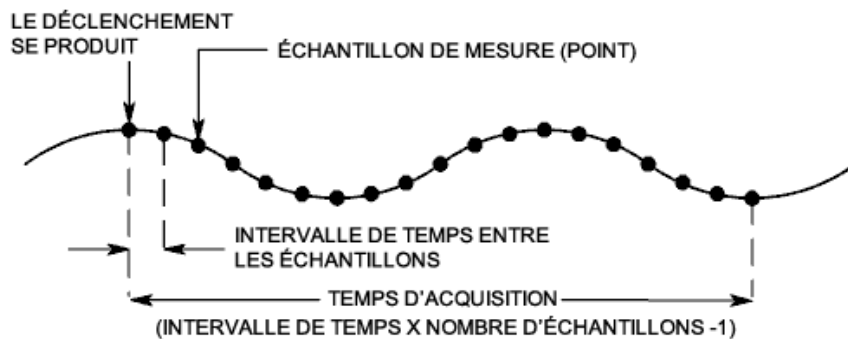

Vous pouvez configurer l'acquisition de la mesure comme suit :

Aide-mémoire des menus du panneau avant	Commande SCPI
Sélectionnez Measure\Sweep .	Pour définir l'intervalle à 60 µs avec 4 096 échantillons :
Entrez le nombre de points. Appuyez ensuite sur Select .	SENS:SWE:TINT 60E-6
Entrez l'intervalle. Appuyez ensuite sur Select .	SENS:SWE:POIN 4096

4 Utilisation du système d'alimentations régénératrices

Le nombre maximal de points d'échantillonnage disponibles est de 512 K points ($K = 1024$).

Les valeurs d'intervalle peuvent être comprises entre 5,12 microsecondes et 40 000 secondes pour les mesures de tension et de courant. Les valeurs supérieures à 5,12 microsecondes sont arrondies à l'incrément de 5,12 microsecondes le plus proche. Les valeurs supérieures à 10,24 microsecondes sont arrondies à l'incrément de 10,24 microsecondes le plus proche. Les valeurs supérieures à 20,48 microsecondes sont arrondies à l'incrément de 20,48 microsecondes le plus proche.

Notez que les modèles Keysight RP7900 prennent également en charge la commande **NPLC** (nombre de cycles de tension d'alimentation) pour configurer les nuances et les points de mesure comme précédemment décrit. La commande NPLC augmente automatiquement le nombre de points pour conserver l'intervalle le plus court possible. Si le nombre maximal de points pour cet intervalle est atteint, la commande augmente l'intervalle.

Déclenchement de la mesure

- Capturer au besoin les données de pré-déclenchement
- Sélectionner la source de déclenchement
- Démarrer le système d'acquisition
- Déclencher la mesure
- Récupérer la mesure
- Événements de déclenchement multiples par mesure

Le système de déclenchement d'acquisition permet de synchroniser les mesures numérisées à l'aide d'un signal de déclenchement provenant d'un certain nombre de sources de déclenchement. Utilisez ensuite les commandes **FETCH** pour renvoyer les informations de tension ou de courant à partir des données acquises.

La figure suivante illustre le processus d'acquisition des mesures. Ce processus s'applique aux déclencheurs de mesure et à l'enregistrement de données externe. Pour une vue d'ensemble du système de déclenchement, reportez-vous à la section **Présentation des déclenchements**.

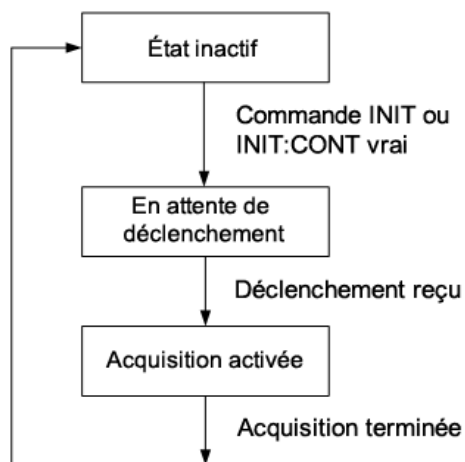

Capter au besoin les données de pré-déclenchement

Le système de mesure vous permet de capturer des données avant, après ou sur le signal de déclenchement. Comme l'illustre la figure suivante, vous pouvez déplacer le bloc de données lue dans le tampon d'acquisition en faisant référence au déclenchement. Cela permet d'échantillonner les données avant ou après le déclenchement.

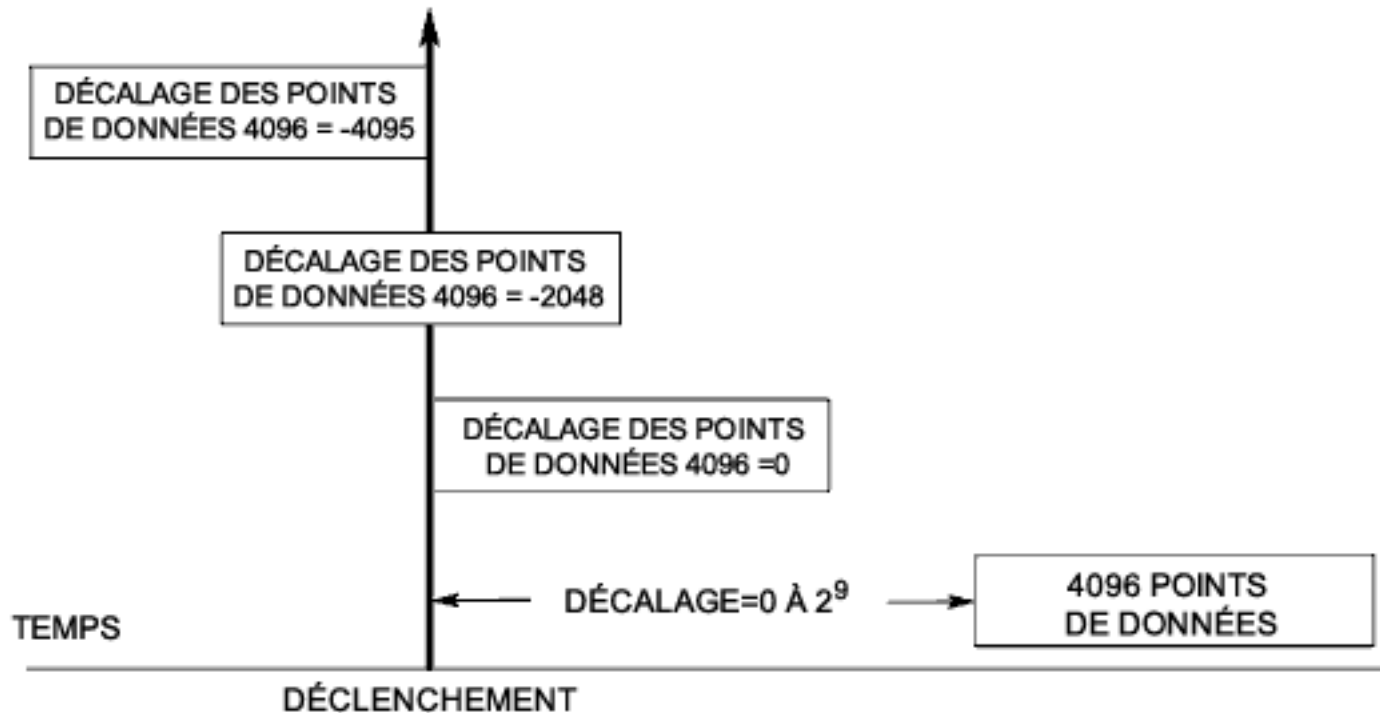

Pour décaler le début du tampon d'acquisition par rapport au déclenchement de l'acquisition :

Aide-mémoire des menus du panneau avant	Commande SCPI
Sélectionnez Measure\Sweep .	Pour décaler la mesure de 100 points :
Entrez une valeur de décalage. Appuyez ensuite sur Select .	SENS:SWE:OFFS:POIN 100

Si la valeur est égale à 0, tous les échantillons de mesure sont prélevés après le déclenchement. Les valeurs positives représentent le délai au-delà duquel le déclenchement se produit avant l'acquisition des échantillons. Cette option permet d'exclure les échantillons de mesure qui sont prélevés pendant le délai de temporisation. (Délai = décalage x période d'échantillonnage). Les valeurs négatives représentent les échantillons de données prélevés avant le déclenchement. Cette option vous permet d'acquérir des échantillons de mesure avant le déclenchement.

Sélectionner la source de déclenchement

REMARQUE L'exécution de la commande TRIGger:ACQuire[:IMMEdiate] sur le bus génère toujours un déclenchement de mesure immédiat, quelle que soit la source de déclenchement sélectionnée.

4 Utilisation du système d'alimentations régénératrices

Si vous n'utilisez pas la commande TRIGger:ACQuire[:IMMEDIATE], sélectionnez une source de déclenchement à partir des options suivantes :

Source de déclenchement	Description
Bus	Sélectionne un déclenchement de périphérique GPIB, *TRG ou <GET> (Group Execute Trigger).
Current	Sélectionne un niveau de courant de sortie.
External	Sélectionne TOUTE broche configurée comme entrée de déclenchement sur le port de commande numérique.
Pin <1-7>	Sélectionne une broche <n> spécifique qui est configurée comme entrée de déclenchement sur le port de commande numérique.
Transient	Sélectionne le système de transitoire de l'appareil. Vous devez également configurer le système de transitoire pour générer un signal de sortie de déclenchement. Voir Programmation des transitoires de sortie .
Voltage	Sélectionne un niveau de tension de sortie.

Les commandes suivantes permettent de sélectionner une source de déclenchement :

Aide-mémoire des menus du panneau avant	Commande SCPI
Non disponible	Pour sélectionner des déclenchements par bus : TRIG:TRAN:SOUR BUS Pour sélectionner la broche numérique 5 comme déclencheur : TRIG:ACQ:SOUR PIN5 Pour sélectionner un niveau de tension ou de courant : TRIG:ACQ:SOUR VOLT TRIG:ACQ:SOUR CURR Pour sélectionner un transitoire de sortie comme déclencheur : TRIG:ACQ:SOUR TRAN

Démarrer le système d'acquisition

Si l'appareil est sous tension, le système de déclenchement est à l'état inactif. Dans cet état, le système de déclenchement est désactivé, ignorant ainsi tous les déclenchements. Les commandes INITiate permettent au système de déclenchement de recevoir des signaux de déclenchement.

Aide-mémoire des menus du panneau avant	Commande SCPI
Non disponible	Pour démarrer le système de déclenchement de mesure : INIT:ACQ

Il ne faut que quelques millisecondes à l'instrument pour être prêt à recevoir un signal de déclenchement une fois la commande INITiate:ACQuire reçue. Si un déclenchement se produit avant

que le système de déclenchement soit prêt, le déclenchement est ignoré. Vous pouvez tester le bit WTG_mes du registre d'état de fonctionnement pour savoir quand l'instrument est prêt à recevoir un signal de déclenchement après avoir été initialisé.

Aide-mémoire des menus du panneau avant	Commande SCPI
Sélectionnez Measure\Control . Le champ Trig state indique "Initiated".	Pour connaître le bit TRAN_meas (bit 3) : STAT:OPER:COND?

Si la valeur de bit 3 est renvoyée dans la réponse à la requête, le bit WTG_mes est vrai et l'instrument est prêt à recevoir le signal de déclenchement. Pour plus d'informations, reportez-vous à la section **Didacticiel d'état**.

REMARQUE

L'instrument effectue une acquisition de mesure chaque fois qu'une commande de déclenchement de bus, de broche, de transitoire ou de niveau est reçue. Ainsi, il est nécessaire de démarrer le système de déclenchement chaque fois qu'une mesure déclenchée est souhaitée.

Déclencher la mesure

Le système de déclenchement attend un signal de déclenchement à l'état initialisé. Vous pouvez déclencher immédiatement la mesure comme suit :

Aide-mémoire des menus du panneau avant	Commande SCPI
Non disponible	Pour générer un signal de déclenchement de mesure : TRIG:ACQ Autrement, si la source de déclenchement est BUS, vous pouvez également programmer une commande *TRG ou une commande IEEE-488 <get>.

Comme précédemment indiqué, un signal de déclenchement peut également être généré par une broche numérique, un transitoire de sortie et un niveau de tension ou de courant de sortie. Si une broche numérique est configurée comme source de déclenchement, l'instrument attend indéfiniment le signal de déclenchement. En l'absence de déclenchement, vous devez renvoyer manuellement le système de déclenchement à l'état inactif. Les commandes suivantes renvoient le système de déclenchement à l'état inactif :

Aide-mémoire des menus du panneau avant	Commande SCPI
Sélectionnez Measure\Control . Sélectionnez ensuite la commande Abort.	ABOR:ACQ

Récupérer la mesure

Une fois un signal de déclenchement reçu et la mesure terminée, le système de déclenchement retourne à l'état inactif.

4 Utilisation du système d'alimentations régénératrices

Une fois la mesure terminée, les requêtes FETCh peuvent récupérer les données de mesure les plus récentes sans démarrer de nouvelle mesure ni altérer les données présentes dans le tampon de mesure.

Aide-mémoire des menus du panneau avant	Commande SCPI
Non disponible	<p>Pour renvoyer la tension et le courant efficaces :</p> <p>FETC:VOLT:ACDC? FETC:CURR:ACDC?</p> <p>Pour renvoyer le niveau élevé d'une impulsion :</p> <p>FETC:VOLT:HIGh? FETC:CURR:HIGh?</p> <p>Pour renvoyer le niveau faible d'une impulsion :</p> <p>FETC:VOLT:LOW? FETC:CURR:LOW?</p> <p>Pour renvoyer la valeur maximale :</p> <p>FETC:VOLT:MAX? FETC:CURR:MAX?</p> <p>Pour renvoyer la valeur minimale :</p> <p>FETC:VOLT:MIN? FETC:CURR:MIN?</p> <p>Pour renvoyer les données en tableau :</p> <p>FETC:ARR:VOLT? FETC:ARR:CURR? FETC:ARR:POW?</p>

Si une requête FETCh est envoyée avant que la mesure ne soit terminée, la réponse est reportée jusqu'à ce que le déclenchement de mesure se produise et que l'acquisition soit terminée. Vous pouvez tester le bit MEAS_active dans le registre d'état de fonctionnement pour savoir à quel moment le système de déclenchement des mesures est revenu à l'état inactif.

Aide-mémoire des menus du panneau avant	Commande SCPI
Sélectionnez Measure\Control . Le champ Trig state indique "Idle".	Pour connaître le bit MEAS_active (bit 5) : STAT:OPER:COND?

Si le bit 5 est défini dans la réponse à la requête, le bit MEAS_active est vrai et la mesure n'est PAS terminée. Si le bit MEAS_active est false (faux), vous pouvez extraire la mesure. Pour plus d'informations, reportez-vous à la section **Didacticiel d'état**.

Événements de déclenchement multiples par mesure

Les modèles Keysight RPS peuvent enregistrer d'autres déclenchements qui se produisent pendant l'acquisition, renvoyer le nombre et la position de ces déclenchements, et calculer les valeurs CC selon un sous-ensemble de données autour de ces déclenchements. Le concept de base est qu'une acquisition unique de longue durée peut contenir plusieurs événements d'intérêt et que ces événements sont marqués par les emplacements où les déclenchements supplémentaires se sont produits. Les emplacements de ces événements sont décrits dans un index situé dans la banque de

données de l'acquisition. Les indices sont compris entre 0 et 1 moins le nombre de lectures acquises (voir **SENse:SWEp:POINTs**).

Vous pouvez rechercher et renvoyer les indices dans lesquels des déclenchements supplémentaires se sont produits pendant la mesure. Le nombre d'indices renvoyés correspond au nombre de déclenchements survenus.

Aide-mémoire des menus du panneau avant	Commande SCPI
Non disponible	<p>Pour savoir combien (le cas échéant) de déclenchements supplémentaires se sont produits :</p> <p>TRIG:ACQ:IND:COUN?</p> <p>Pour renvoyer les indices dans lesquels les déclenchements se sont produits :</p> <p>TRIG:ACQ:IND?</p>

Vous pouvez également renvoyer les données de mesure réelles qui ont été capturées après l'un des indices de déclenchement ci-dessus mentionnés.

Aide-mémoire des menus du panneau avant	Commande SCPI
Non disponible	<p>Pour renvoyer la tension ou le courant CC calculé après les indices de déclenchement :</p> <p>FETC:VOLT? [<start_index>, <points>]</p> <p>FETC:CURR? [<start_index>, <points>]</p> <p>Pour renvoyer les données de tension ou de courant instantanées après les indices de déclenchement :</p> <p>FETC:ARR:VOLT? [<start_index>, <points>]</p> <p>FETC:ARR:CURR? [<start_index>, <points>]</p>

Programmation du port numérique

Entrées/sorties numériques bidirectionnelles

Entrée numérique seulement

E/S de déclenchement externe

Sortie de défaillance

Entrée d'inhibition

Protection du système de défaillance/inhibition

Output Couple

Port de commande numérique

Un port de commande numérique comportant sept broches d'E/S est fourni pour permettre l'accès à plusieurs fonctions de contrôle. Chaque broche peut être configurée par l'utilisateur. Les fonctions de commande suivantes sont disponibles pour les broches d'E/S. Pour plus d'informations sur les commandes SCPI permettant de programmer le port numérique, reportez-vous à la section [Référence de programmation SCPI](#).

Le tableau suivant décrit les configurations possibles des broches pour les fonctions du port numérique. Pour une description complète des caractéristiques électriques du port de commande numérique, reportez-vous à la section [Spécifications](#).

Fonction	Description
DIO	Fonction d'entrée/sortie numérique polyvalente référencée à la masse. La sortie peut être réglée avec [SOURCE:]DIGital:OUTPut:DATA .
DINPut	Mode d'entrée numérique uniquement. Les données de sortie numériques de la broche sont ignorées.
FAULt	S'applique uniquement à la broche 1. La broche 1 fonctionne comme une sortie d'erreur isolée. Le signal de défaillance est vrai si une sortie est à l'état protégé. La broche 2 sert de commun isolé pour la broche 1. Lorsque la broche 1 est réglée sur la fonction FAULt, l'instrument ignore toutes les commandes de programmation de la broche 2. Les requêtes de la broche 2 renverront FAULt. Si la broche 1 passe de FAULt à une autre fonction, la broche 2 est réglée sur DINPut.
INHibit	S'applique uniquement à la broche 3. Si la broche 3 est configurée comme une entrée d'inhibition, un signal vrai au niveau de la broche désactive la sortie.
ONCOuple	S'applique uniquement aux broches 4-7. La broche ONCOuple synchronise l'état d'activation de la sortie entre les instruments. Vous ne pouvez configurer qu'une seule broche comme ONCOuple. La broche fonctionne comme une entrée et une sortie.
OFFCOuple	S'applique uniquement aux broches 4-7. La broche OFFCOuple synchronise l'état de désactivation de la sortie entre les instruments. Vous ne pouvez configurer qu'une seule broche comme OFFCOuple. La broche fonctionne comme une entrée et une sortie.

TINPut	Une broche d'entrée de déclenchement peut être sélectionnée comme source des signaux de déclenchement de mesure et de transitoire. Voir TRIGger:ACQuire:SOURce et TRIGger:TRANSient:SOURce
TOUTput	Une broche de sortie de déclenchement génère des déclenchements de sortie à partir de tout sous-système ayant été configuré pour générer des signaux de déclenchement.
Common	S'applique uniquement à la broche 8. Connecté à la masse.

Outre les fonctions de broche configurables, la polarité du signal (positive ou négative) de chaque broche peut également être configurée. Pour les signaux de niveau, POSitive indique une tension élevée au niveau de la broche. NEGative indique une tension faible sur la broche. Pour les signaux de front, POSitive signifie un front montant et NEGative un front descendant.

Entrées/sorties numériques bidirectionnelles

Chacune des sept broches peut être configurée comme une entrée et sortie numériques bidirectionnelles universelles. La polarité des broches peut également être configurée. La broche 8 est le commun du signal pour les broches d'E/S numériques. Les données sont programmées conformément aux affectations de bits suivantes :

Broche	7	6	5	4	3	2	1
Poids du bit	6 (MSB)	5	4	3	2	1	0 (LSB)

Les broches d'E/S numériques permettent de contrôler les circuits de relais ainsi que les circuits d'interface numériques. La figure suivante illustre les circuits de relais types ainsi que les connexions de circuit d'interface numérique à l'aide des fonctions d'E/S numériques.

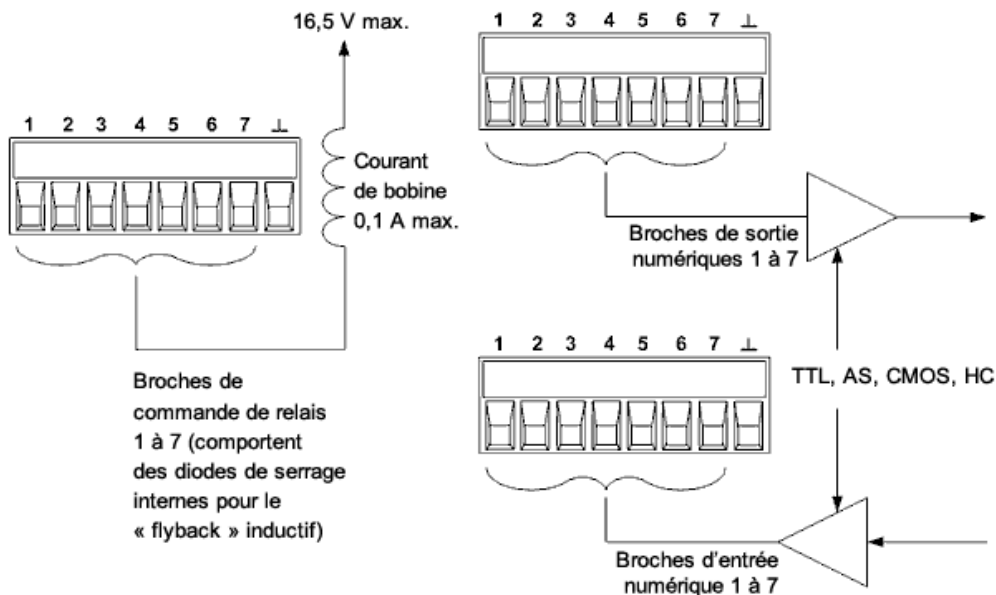

Pour configurer les broches d'E/S numériques :

Aide-mémoire des menus du panneau avant

Commande SCPI

Sélectionnez System\IO\DigPort\Pins .	Pour sélectionner la fonction de la broche :
Sélectionnez une broche dans le champ Pin (Broche).	DIG:PIN<1-7>:FUNC DIO
Dans le champ Function (Fonction), sélectionnez Dig IO (E/S num.)	Pour sélectionner la polarité de la broche :
Dans le champ Polarity (Polarité), sélectionnez Positive (Positif) ou Negative (Négatif).	DIG:PIN<1-7>:POL POS
Pour envoyer les données aux broches, sélectionnez System\IO\DigPort\Data .	Pour configurer les broches 1 à 7 avec « 0000111 » :
Sélectionnez le champ Data Out (Sortie des données) et saisissez le mot binaire.	DIG:OUTP:DATA 7

Entrée numérique

Chacune des sept broches peut être configurée uniquement comme entrée numérique. La polarité des broches peut également être configurée. La broche 8 est le commun du signal pour les broches d'entrée numériques. L'état de la broche reflète la condition du signal externe appliqué sur cette broche. Il n'est pas affecté par la valeur de la commande DIGital:OUTPut:DATA. Pour configurer les broches de l'entrée numérique uniquement :

Aide-mémoire des menus du panneau avant	Commande SCPI
Sélectionnez System\IO\DigPort\Pins .	Pour sélectionner la fonction de la broche :
Sélectionnez une broche dans le champ Pin (Broche).	DIG:PIN<1-7>:FUNC DINP
Dans le champ Function (Fonction), sélectionnez Dig In (Entrée num) .	Pour sélectionner la polarité de la broche :
Dans le champ Polarity (Polarité), sélectionnez Positive (Positif) ou Negative (Négatif).	DIG:PIN<1-7>:POL POS
Pour lire les données à partir des broches, sélectionnez System\IO\DigPort\Data .	Pour lire les données sur les broches :
Les données d'entrée sont affichées au format binaire dans le champ Data In (Entrée de données).	DIG:INP:DATA?

E/S de déclenchement externe

Chacune des sept broches peut être configurée comme une entrée ou sortie de déclenchement. La polarité des broches peut également être configurée. Lorsque vous programmez une polarité de déclenchement, POSitive signifie un front montant et NEGative signifie un front descendant. La broche 8 est le commun du signal pour les broches de déclenchement. Pour une vue d'ensemble du système de déclenchement, reportez-vous à la section **Présentation des déclenchements**.

Lorsque la broche de déclenchement désignée est configurée comme une entrée de déclenchement, vous pouvez lui appliquer une impulsion à front négatif ou à front positif. Le temps de latence du déclenchement est de 5 microsecondes. La largeur d'impulsion minimale est de 4 microsecondes pour les signaux à front positif et de 10 microsecondes pour les signaux à front négatif. Le réglage de la polarité de la broche détermine le front qui produira un événement de déclenchement.

Configurée comme une sortie de déclenchement, la broche désignée délivre une impulsion de 10 microsecondes lorsqu'une sortie de déclenchement se produit. Selon le réglage de la polarité, ce peut être une impulsion à front positif ou négatif par rapport au commun.

Aide-mémoire des menus du panneau avant	Commande SCPI
Sélectionnez System\IO\DigPort\Pins .	Pour sélectionner la fonction de sortie de déclenchement de la broche 1 :
Sélectionnez une broche dans le champ Pin (Broche).	DIG:PIN1:FUNC TOUT
Dans le champ Function (Fonction) sélectionnez la fonction Trig In (Entrée de déclenchement) ou Trig Out (Sortie de déclenchement).	Pour sélectionner la fonction d'entrée de déclenchement de la broche 2 :
Dans le champ Polarity (Polarité), sélectionnez Positive (Positif) ou Negative (Négatif).	DIG:PIN2:FUNC TINP
	Pour sélectionner la polarité de la broche :
	DIG:PIN1:POL POS
	DIG:PIN2:POL POS

Sortie de défaillance

Les broches 1 et 2 peuvent être configurées comme une paire de sortie de défaillance. La fonction de sortie de défaillance permet à une condition de défaillance de générer un signal de défaillance de protection sur le port numérique. Pour une liste des signaux de protection, reportez-vous à la section **Programmation de la protection des sorties**.

Les broches 1 et 2 sont dédiées à cette fonction. La broche 1 est la sortie de défaillance ; la broche 2 est le commun de la broche 1. Cela fournit une sortie optiquement isolée. La polarité de la broche 1 peut également être configurée. Si la polarité de la broche est POSitive, une condition de défaillance déclenche la sortie isolée. Notez que le signal de sortie de défaillance demeure verrouillé tant que l'anomalie n'a pas été résolue et que le circuit de protection n'a pas été désactivé, comme expliqué dans la section **Désactivation des fonctions de protection de sortie**.

REMARQUE La fonction sélectionnée pour la broche 2 est ignorée. La broche 2 doit être reliée à la masse du circuit externe.

Aide-mémoire des menus du panneau avant	Commande SCPI
Sélectionnez System\IO\DigPort\Pins .	Pour configurer la fonction Fault (Défaillance) :
Sélectionnez pin 1 (broche 1), Function (Fonction), puis Fault Out (Sortie de défaillance).	DIG:PIN1:FUNC FAUL
Dans le champ Polarity (Polarité), sélectionnez Positive (Positif) ou Negative (Négatif).	Pour sélectionner la polarité de la broche :
	DIG:PIN1:POL POS

Entrée d'inhibition

La broche 3 peut être configurée comme entrée d'inhibition à distance. La fonction d'entrée d'inhibition permet à un signal d'entrée externe de contrôler l'état de sortie de l'instrument. Cette entrée est déclenchée par niveau. Le temps de latence du signal est de 5 microsecondes. La broche 8 est le

4 Utilisation du système d'alimentations régénératrices

commun de la broche 3. Les modes d'entrée d'inhibition non volatiles suivants peuvent être programmés :

LATChing - une transition vers l'état logique vrai sur l'entrée d'inhibition désactivera la sortie. La sortie demeure désactivée une fois le signal d'inhibition reçu.

LIVE : permet à la sortie activée de suivre l'état de l'entrée d'inhibition. Lorsque l'entrée d'inhibition est à l'état vrai, la sortie est désactivée. Lorsque l'entrée d'inhibition est à l'état faux, la sortie est réactivée.

OFF : l'entrée d'inhibition est ignorée.

Pour configurer la fonction d'entrée d'inhibition :

Aide-mémoire des menus du panneau avant	Commande SCPI
Sélectionnez System\IO\DigPort\Pins .	Pour sélectionner la fonction Inhibit (Inhibition) :
Sélectionnez pin 3 (broche 3), Fonction (Fonction), puis Inhibit In (Entrée d'inhibition).	DIG:PIN3:FUNC INH
Dans le champ Polarity (Polarité), sélectionnez Positive (Positif) ou Negative (Négatif).	Pour sélectionner la polarité de la broche :
Sélectionnez Protect\Inhibit .	DIG:PIN3:POL POS
Sélectionnez Latching (Verrouillage) ou Live (Actif).	Indiquer le mode Inhibit (Inhibition) :
Pour désactiver le signal d'inhibition, sélectionnez Off (Désactivé).	OUTP:INH:MODE LATC OUTP:INH:MODE LIVE OUTP:INH:MODE OFF

Protection du système de défaillance/inhibition

Comme le montre la figure suivante, lorsque les sorties de défaillance et les entrées d'inhibition de plusieurs instruments sont connectées en série, une condition de défaillance interne sur un appareil désactive toutes les sorties sans intervention du contrôleur ou des circuits externes. Sachez que pour utiliser les signaux Fault/Inhibit de cette façon, vous devez régler les deux signaux sur la même polarité.

Aussi, comme l'illustre la figure, vous pouvez également connecter l'entrée d'inhibition à un commutateur manuel ou à un signal de contrôle externe : celui-ci court-circuite la broche Inhibit (Inhibition) en commun chaque fois que cela est nécessaire afin de désactiver toutes les sorties. Dans ce cas, vous devez programmer la polarité **Negative (Négative)** pour toutes les broches. Vous pouvez également utiliser la sortie de défaillance pour diriger un circuit ou un signal de relais externe vers d'autres appareils chaque fois qu'une protection se déclenche.

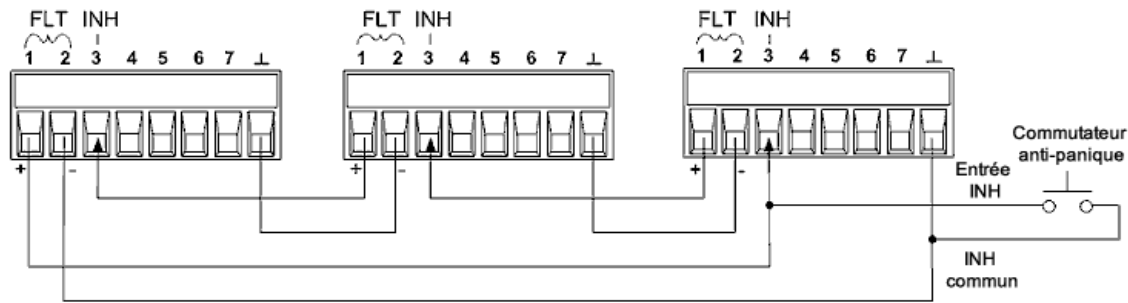

Correction d'une défaillance de protection du système

Pour restaurer le fonctionnement normal de tous les instruments lorsqu'une condition de défaillance se produit dans une configuration de protection de systèmes connectés en série, vous devez supprimer les deux conditions de défaillance suivantes :

1. La défaillance de protection initiale ou le signal d'inhibition externe initial.
2. Le signal de défaillance en chaîne qui suit, délivré par le signal d'inhibition.

REMARQUE Même lorsque la condition de défaillance initiale ou le signal externe initial sont supprimés, le signal de défaillance demeure actif et continue de désactiver toutes les sorties de l'ensemble des appareils.

Pour corriger le signal de défaillance en série lorsque le mode de fonctionnement de l'entrée d'inhibition est activé, annulez la protection de sortie de n'importe quel appareil tel qu'expliqué dans le chapitre **Désactivation des fonctions de protection**. Si le mode de fonctionnement de l'entrée d'inhibition est verrouillé, désactivez l'entrée d'inhibition sur CHACUN des appareils. Pour réactiver la connexion en série, reprogrammez l'entrée d'inhibition sur chaque appareil sur le mode verrouillé.

Commande de couplage des sorties

Cette fonction permet de connecter ensemble plusieurs instruments et de synchroniser la séquence d'activation ou de désactivation des sorties sur tous les appareils. Chaque appareil à séquencer doit également être « couplé » aux autres appareils.

1. Coupez la sortie sur chaque appareil, comme décrit dans la section **Séquencement de la sortie**.
2. Réglez le décalage de délai de chaque appareil afin qu'il corresponde à la valeur de décalage de délai la plus grande du groupe.
3. Connectez et configurez les broches du connecteur numérique des appareils séquencés comme indiqué ci-dessous.

Seules les broches 4 à 7 peuvent être configurées comme des broches « couplées ». Les broches désignées fonctionnent à la fois comme entrée et comme sortie, avec une transition négative sur une broche afin de fournir le signal de séquence aux autres broches. La polarité des broches n'est pas programmable ; elle est réglée sur NEGative.

4 Utilisation du système d'alimentations régénératrices

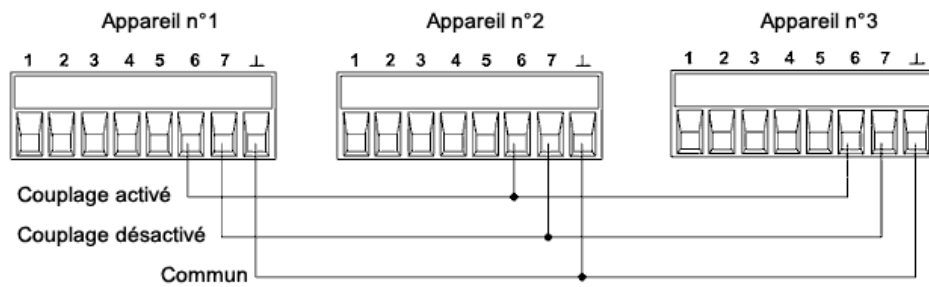

Dans cet exemple, la broche 6 est configurée comme commande d'activation de la sortie. La broche 7 est configurée comme commande de désactivation de la sortie. Les broches de masse ou Common sont reliées ensemble.

Aide-mémoire des menus du panneau avant	Commande SCPI
Sélectionnez System\IO\DigPort\Pins .	Pour régler la broche 6 de l'appareil 1 comme commande d'activation :
Sélectionnez pin 6 (broche 6), Fonction (Fonction), puis On Couple (Couplage activé).	DIG:PIN6:FUNC ONC
Sélectionnez Pins (Broches) , pin7 (broche7), Fonction (Fonction), puis Off Couple (Couplage désactivé).	Pour configurer la broche 7 de l'appareil 1 comme commande de désactivation :
Répétez ces étapes pour les appareils n°2 et n°3.	DIG:PIN7:FUNC OFFC
	Répétez ces commandes pour les appareils n°2 et n°3.

Une fois la sortie configurée et activée, l'activation ou la désactivation de n'importe quelle sortie couplée provoque l'activation ou la désactivation de toutes les sorties couplées, selon leurs délais programmés par l'utilisateur.

Opérations système

Même si elles ne sont pas directement liées à la programmation des sorties, les fonctions suivantes contrôlent également le fonctionnement de l'appareil.

Identification de l'instrument

Stockage des configurations de l'instrument

Affichage du panneau avant

Verrouillage du panneau avant

Protection par mot de passe

Identification de l'instrument

Vous pouvez rechercher le numéro du modèle, le numéro de série, les options et la version du microprogramme. Les commandes SCPI renvoient des informations à l'aide des requêtes ***IDN?** et ***OPT?**.

Aide-mémoire des menus du panneau avant	Commande SCPI
Sélectionnez System\About\Frame .	Pour renvoyer le nom du fabricant, le numéro du modèle, le numéro de série et la version du microprogramme : *IDN? Pour renvoyer les options installées : *OPT?

Stockage des configurations de l'instrument

Le bloc d'alimentation comporte dix registres dans la mémoire non volatile pour y enregistrer des configurations. Les emplacements sont numérotés de 0 à 9. Toute configuration précédemment enregistrée au même emplacement est remplacée.

Aide-mémoire des menus du panneau avant	Commande SCPI
Sélectionnez States\SaveRecall . Dans le champ SaveRecall , saisissez un emplacement compris entre 0 et 9. Appuyez ensuite sur Select . Sélectionnez Save (Enregistrer) pour enregistrer la configuration à l'état Recall (Rappeler) afin de rappeler une configuration.	Pour enregistrer une configuration à l'emplacement 1 : *SAV 1 Pour rappeler une configuration à l'emplacement 1 : *RCL 1

Indication d'une configuration de mise sous tension

Le bloc d'alimentation est configuré en usine pour rappeler automatiquement les paramètres de réinitialisation (***RST**) à la mise sous tension. Toutefois, vous pouvez configurer le bloc d'alimentation

4 Utilisation du système d'alimentations régénératrices

afin qu'il utilise les paramètres que vous avez enregistrés à l'emplacement mémoire 0 lors de la mise sous tension.

Aide-mémoire des menus du panneau avant	Commande SCPI
Sélectionnez States\PowerOn .	OUTP:PON:STAT RCL0
Sélectionnez Rappeler la configuration 0 . Appuyez ensuite sur Select .	

Affichage du panneau avant

Le panneau avant du bloc d'alimentation est doté d'un écran de veille : celui-ci augmente considérablement la durée de vie de l'écran LCD en atténuant sa luminosité pendant les périodes d'inactivité. Le délai peut être réglé entre 30 et 999 minutes par incréments de 1 minute. L'écran de veille est réglé en usine pour se déclencher après une heure d'inactivité sur le panneau avant ou de l'interface.

Lorsque l'écran de veille est actif, la luminosité de l'écran du panneau avant s'atténue et le voyant situé en regard de l'interrupteur passe du vert à l'orange. Pour restaurer l'écran du panneau avant, appuyez sur une touche du panneau avant. La sélection de la touche a pour effet d'augmenter la luminosité. Ensuite, la touche retourne à son mode de fonctionnement normal.

Si la fonction Wake on I/O (Réveil par l'E/S) est sélectionnée, l'écran est restauré en cas d'activité sur l'interface de commande à distance. Cela réinitialise également le temporisateur de l'écran de veille. Par défaut, la fonction de réveil par l'E/S est activée.

Aide-mémoire des menus du panneau avant	Commande SCPI
Sélectionnez System\Preferences\Display\Saver .	Pour activer ou désactiver l'écran de veille du panneau avant :
Activez ou désactivez l'écran de veille en cochant ou en désélectionnant la case Screen Saver (Écran de veille). Appuyez ensuite sur Select .	DISP:SAV ON OFF
Saisissez une valeur en minutes dans le champ Saver Delay (Délai d'activation) de l'écran de veille pour spécifier le temps d'inactivité au bout duquel l'écran de veille doit s'activer.	
Cochez la case Wake on I/O (Réveil par l'E/S) pour activer l'écran avec le réveil par l'E/S.	

Indication de l'affichage à la mise sous tension

Notez qu'il est possible de déterminer les fonctions de mesure qui doivent s'afficher à la mise sous tension.

Aide-mémoire des menus du panneau avant	Commande SCPI
---	---------------

Sélectionnez System\Preferences\Display\View .	Pour sélectionner une vue multimètre à la mise sous tension :
Dans le menu déroulant, sélectionnez : Voltage,Current; Voltage,Power; ou Volt,Curr,Power. Appuyez ensuite sur Select .	DISP:VIEW METER_VI DISP:VIEW METER_VP DISP:VIEW METER_VIP

Verrouillage du panneau avant

Vous pouvez verrouiller les touches du panneau avant afin d'empêcher tout contrôle indésirable de l'instrument par le biais du panneau avant. Cette méthode de verrouillage des touches du panneau avant est la plus sûre, car vous avez besoin d'un mot de passe pour déverrouiller le panneau avant. Ces paramètres sont enregistrés dans la mémoire non volatile. Par conséquent, le panneau avant demeure verrouillé, même après la remise sous tension de l'alimentation secteur.

Aide-mémoire des menus du panneau avant	Commande SCPI
Sélectionnez System\Preferences\Lock .	Non disponible
Dans la boîte de dialogue, saisissez le mot de passe pour déverrouiller le panneau avant. Sélectionnez ensuite l'option Lock (Verrouiller).	

Le menu permettant de déverrouiller le panneau avant s'affiche chaque fois qu'une touche est enfoncée. Saisissez le mot de passe pour déverrouiller le panneau avant.

REMARQUE En cas de perte du mot de passe, la commande **SYSTEM:PASSWORD:FPANEL:RESet** peut réinitialiser le mot de passe de verrouillage du panneau avant. Pour plus d'informations, reportez-vous à la section **Commutateurs d'étalonnage**.

La commande **SYSTEM:COMMunicate:RLState RWLock** permet également de verrouiller et de déverrouiller le panneau avant. Cette commande est entièrement indépendante de la fonction de verrouillage du panneau avant. Si vous utilisez cette commande pour verrouiller le panneau avant, celui-ci est déverrouillé, même après la remise sous tension de l'alimentation secteur.

Protection par mot de passe

Vous pouvez protéger toutes les fonctions situées dans le menu Admin à l'aide d'un mot de passe. Parmi ces fonctions figurent l'étalonnage de l'instrument, l'accès à l'interface, la réinitialisation de mémoire non volatile, la mise à jour de microprogramme et les mises à jour de mot de passe.

Par défaut, le mot de passe du menu Admin est 0 (zéro). Autrement dit, il n'est pas nécessaire de saisir un mot de passe pour accéder au menu Admin. Sélectionnez simplement **System\Admin>Login** et appuyez sur Enter. Pour protéger le menu Admin par mot de passe :

Aide-mémoire des menus du panneau avant	Commande SCPI
---	---------------

Sélectionnez System\Admin>Password	Accédez au mode d'étalonnage à l'aide du mot de passe initial.
Saisissez un mot de passe numérique d'une longueur maximale de 15 chiffres. Appuyez ensuite sur Select.	CAL:STAT ON, < motdepasse >
Connectez-vous au menu Admin pour activer le mot de passe. Vous ne pouvez maintenant accéder au menu Admin qu'en saisissant le mot de passe approprié dans le champ Password (Mot de passe).	Pour modifier le mot de passe : CAL:PASS < motdepasse >
	Pour quitter le mode d'étalonnage et activer le mot de passe : CAL:STAT OFF

En cas de perte du mot de passe, l'accès reste possible en réglant un commutateur interne permettant de réinitialiser le mot de passe sur 0. Si le message « Locked out by internal switch setting » ou « Calibration is inhibited by switch setting » apparaît, le commutateur interne est défini pour empêcher la modification du mot de passe. Pour plus d'informations, reportez-vous à la section **Commutateurs d'étalonnage**.

Clock Setup (Réglage de l'horloge)

L'horloge en temps réel permet de fournir des informations d'horodatage pour le logiciel de contrôle et d'analyse Keysight 14585A ; il s'agit de sa seule fonction. Par défaut, l'horloge en temps réel est réglée sur l'heure de Greenwich. Pour régler l'horloge :

Aide-mémoire des menus du panneau avant	Commande SCPI
Sélectionnez System\Preferences\Display\Clock .	Pour régler la date :
Entrez la date dans les champs Month, Day et Year (Mois, Jour et Année).	SYSTem:DATE 2018,06,30
Entrez l'heure dans les champs Hour, Minute et Second (Heure, Minute et Seconde).	Pour régler l'heure :
Appuyez sur Select pour régler la date et l'heure.	SYSTem:TIME 20,30,0

Didacticiel du mode de priorité

Priorité de tension

Priorité de courant

Priorité de tension

En mode de priorité de tension, la sortie est contrôlée par une boucle de rétroaction à tension constante, qui maintient la tension de sortie à sa valeur programmée dès lors que le courant de charge demeure inférieur aux limites de courant positives ou négatives. Le mode de priorité de tension convient davantage à une utilisation avec des charges d'impédance résistives ou élevées, et des charges sensibles aux dépassements de tension. N'utilisez pas le mode de priorité de tension avec des sources de faible impédance, telles que les batteries, les blocs d'alimentation ou les condensateurs à forte charge.

En mode de priorité de tension, la tension de sortie doit être programmée sur la valeur souhaitée. Une valeur limite de courant positive ou négative doit également être définie. La limite de courant doit toujours être définie à une valeur supérieure au courant de sortie réel requis de la charge externe. La figure suivante illustre le principe de fonctionnement de la priorité de tension de la sortie. La zone dans les quadrants blancs présente la sortie comme une source (puissance d'alimentation). La zone dans les quadrants grisés présente la sortie comme une charge (puissance d'absorption).

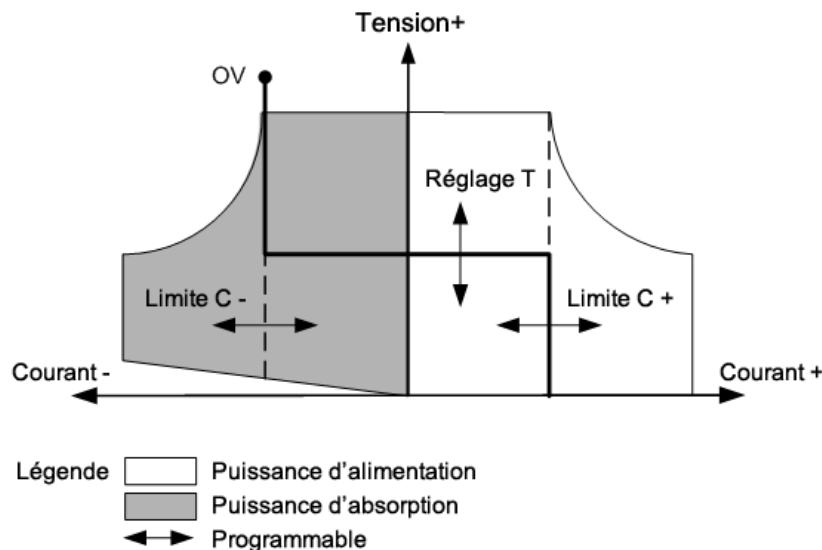

La grosse ligne pleine illustre l'espace des points de fonctionnement possibles comme une fonction de la charge de sortie. Comme l'indique la partie horizontale de la ligne, la tension de sortie demeure réglée sur sa valeur programmée dès lors que le courant de charge est inférieur aux limites de courant positives ou négatives. L'indicateur d'état CV (tension constante) signale que la tension de sortie est en cours de réglage et que le courant de sortie est inférieur à ses valeurs limites.

4 Utilisation du système d'alimentations régénératrices

Notez que lorsque le courant de sortie atteint la limite de courant positif ou négatif, l'appareil cesse de fonctionner en mode de tension constante et la tension de sortie n'est plus maintenue à un niveau constant. À la place, l'alimentation régule maintenant le courant de sortie à sa valeur limite de courant. L'indicateur d'état LIM+ (Limite de courant positive) ou LIM- (Limite de courant négative) est activé pour indiquer qu'une limite de courant a été atteinte. Ces conditions sont indiquées par l'état CL+ ou CL- sur le panneau avant.

Comme l'indiquent les parties verticales de la ligne de charge, la tension de sortie peut continuer d'augmenter dans le sens positif ou diminuer dans le sens négatif lorsque le courant est injecté ou évacué de l'appareil. Si la tension de sortie dépasse la valeur de protection contre les surtensions, la sortie est fermée, les relais de sortie s'ouvrent et l'octet d'état OV est activé.

Priorité de courant

En mode de priorité de courant, la sortie est contrôlée par une boucle de rétroaction à courant constant bipolaire, qui maintient la source de sortie ou le courant absorbé à sa valeur programmée. Le courant de sortie conserve sa valeur programmée à condition que le courant de charge soit inférieur au réglage de la limite de courant. Le mode de priorité de courant est mieux adapté à une utilisation avec des batteries, des blocs d'alimentation, des condensateurs à forte charge et des charges sensibles aux dépassements de courant. Il minimise les dépassements de courant durant les transitions entre la programmation, la mise sous tension et la mise hors tension, et assure des transitions fluides entre les courants positifs et négatifs.

En mode Priorité de courant, le courant de sortie doit être programmé en fonction de la valeur positive ou négative souhaitée. Une valeur limite de tension positive doit également être définie. La limite de tension doit toujours être définie à une valeur supérieure à la tension de sortie réelle requise de la charge externe. La figure suivante illustre le principe de fonctionnement de la priorité de courant de sortie. La zone dans les quadrants blancs présente la sortie comme une source (puissance d'alimentation). La zone dans les quadrants grisés présente la sortie comme une charge (puissance d'absorption).

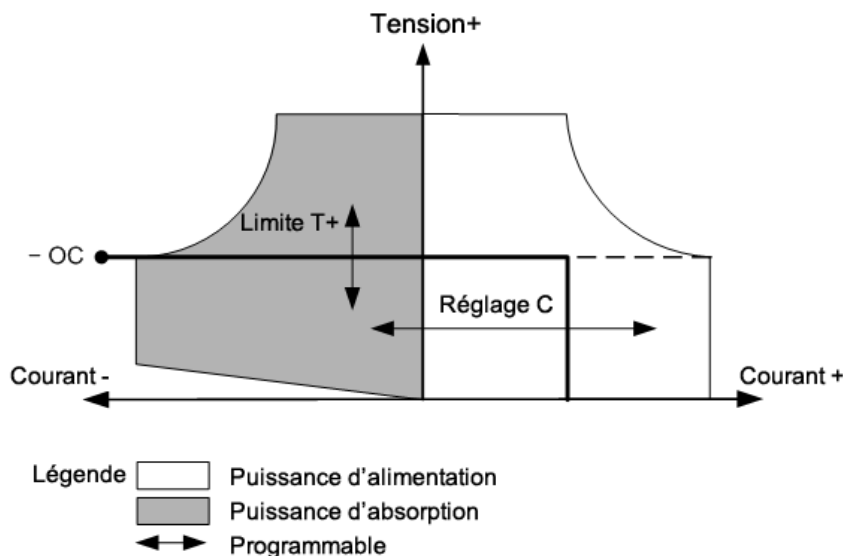

La grosse ligne pleine illustre l'espace des points de fonctionnement possibles comme une fonction de la charge de sortie. Comme l'indique la partie verticale de la ligne, le courant de sortie demeure réglé sur sa valeur programmée dès lors que la tension de sortie est inférieure à sa valeur limite.

L'indicateur d'état CC (courant constant) signale que le courant de sortie est en cours de régulation et que la tension de sortie est inférieure à ses valeurs limites.

Notez que lorsque la tension de sortie atteint la limite de tension positive ou négative, l'appareil cesse de fonctionner en mode de courant constant et le courant de sortie n'est plus maintenu à un niveau constant. À la place, l'alimentation régule maintenant la tension de sortie à sa valeur limite de tension. L'indicateur d'état LIM+ (limite de tension positive) est activé pour indiquer que la limite de tension a été atteinte. Cette condition est signalée par l'état VL+ sur le panneau avant.

Comme l'indique la partie horizontale de la ligne de charge, lorsque l'appareil absorbe la puissance, le courant de sortie peut continuer d'augmenter dans le sens négatif à mesure qu'une plus grande quantité de courant est injectée dans l'appareil. Cette situation peut se produire lorsque la charge est une source d'alimentation comme une batterie et que sa tension de sortie est supérieure à la limite de tension du bloc d'alimentation. Lorsque le courant dépasse la limite de surintensité négative intégrée, la sortie est fermée, les relais de sortie s'ouvrent et les bits d'état OC sont activés. Dans ce cas, il est important de régler correctement la limite de tension afin d'empêcher l'arrêt de cette protection.

REMARQUE

Pour plus d'informations sur le fonctionnement en mode prioritaire lors de l'activation/désactivation de la sortie, reportez-vous au chapitre **Comportement d'activation/désactivation**.

5

Aide-mémoire de la programmation SCPI

Informations connexes

Présentation du SCPI

Commandes par sous-système

Didacticiel d'état

Didacticiel de déclenchement

État de réinitialisation

Messages d'erreur SCPI

Commandes de compatibilité

Logiciels associés

Logiciel avancé de contrôle et d'analyse d'alimentation BV9200B et BV9201B PathWave BenchVue

Le logiciel BV9200 permet d'accéder rapidement et facilement aux fonctionnalités avancées d'alimentation et de mesure de votre système d'alimentation régénérative Série RP7900, sans aucune programmation. Le logiciel BV9200B vous permettra de contrôler jusqu'à quatre instruments à la fois, tandis que le logiciel BV9201B vous permettra de contrôler un seul instrument. Ce sont des outils flexibles pour toute application, qui vous permettent de contrôler n'importe lequel des 20 modèles de la Série RP7900. Notez que ce logiciel ne prend pas en charge le fonctionnement principal/secondaire. Pour en savoir plus et pour télécharger un essai gratuit, rendez-vous sur le site : www.keysight.com/find/BV9200.

Bibliothèques d'E/S et pilotes de l'instrument

Vous pouvez télécharger le logiciel Keysight IO Libraries Suite, ainsi que les pilotes IVI-COM et LabVIEW à partir du Réseau de développeurs Keysight à l'adresse www.keysight.com/find/adn.

Documentation de l'interface

Pour plus d'informations sur les connexions des interfaces, reportez-vous au document Keysight Technologies USB/LAN/GPIB Interfaces Connectivity Guide (en anglais), fourni avec la suite Keysight IO Libraries. Vous pouvez également télécharger le guide sur Internet à l'adresse www.keysight.com/find/connectivity.

Interface Web

Le système RPS fournit une interface Web intégrée à l'instrument. Vous pouvez utiliser cette interface sur le réseau local pour accéder à distance à l'instrument et le contrôler à l'aide d'un navigateur Web. Pour plus d'informations, reportez-vous à la section [Utilisation de l'interface Web](#).

Présentation du SCPI

Mots-clés

Requêtes

Séparateurs et caractères de fin de commande

Conventions syntaxiques

Types de paramètres

Device Clear

Temps de traitement de commande type

Introduction

Cet instrument est conforme aux règles et aux conventions de la version SCPI actuelle (voir [SYSTem:VERSion?](#)).

SCPI (Standard Commands for Programmable Instruments) est un langage de commande d'instrument ASCII conçu pour les instruments de test et de mesure. SCPI inclut deux types de commandes : courantes et de sous-système.

Commandes courantes IEEE-488,2

La norme IEEE-488.2 définit un ensemble de commandes courantes qui exécutent des fonctions, telles que des opérations de réinitialisation, d'autotest et de configuration. Les commandes courantes commencent toujours par un astérisque (*), sont composées de trois caractères et peuvent inclure un ou plusieurs paramètres. Le mot-clé d'une commande est séparé du premier paramètre par un espace blanc. Utilisez un point-virgule (;) pour séparer plusieurs commandes, comme indiqué ci-dessous :

Commandes de sous-système

Les commandes de sous-système exécutent des fonctions spécifiques à l'instrument. Elles sont constituées de commandes organisées par ordre alphabétique qui s'étendent sous la racine sur un ou plusieurs niveaux dans une structure hiérarchique également appelée *arborescence*. Dans cette structure, les commandes associées sont regroupées dans un nœud (ou une racine) commun(e) pour former des *sous-systèmes*. Une partie du sous-système OUTPut est représentée ci-dessous pour illustrer l'arborescence. Notez que certaines commandes [facultatives] ont été ajoutées à des fins de clarté.

```
OUTPut
  [:STATe] OFF|0|ON|1
  :DELay
    :FALL <valeur>|MIN|MAX
    :RISE <valeur>|MIN|MAX
  :INHibit
    :MODE LATChing|LIVE|OFF
```

Mots-clés

Les mots-clés, également appelés en-têtes, sont des instructions reconnues par l'instrument. Les commandes courantes sont également des mots-clés.

OUTPut est le mot-clé racine, DELay est un mot-clé de deuxième niveau, FALL et RISE sont des mots-clés de troisième niveau. Le signe des deux points (:) sépare les niveaux de mots-clés.

Cette syntaxe présente la plupart des commandes (et certains paramètres) sous la forme d'un mélange de lettres minuscules et majuscules. Les majuscules indiquent l'abréviation des commandes. Pour réduire la taille des lignes de programme, vous pouvez utiliser la forme abrégée. Pour une meilleure lisibilité des programmes, vous pouvez utiliser la forme complète.

Dans les exemples ci-dessus, OUPt et OUTPUT sont deux formes acceptables. Vous pouvez utiliser des majuscules ou minuscules. Par conséquent, les formes OUTPUT, outp et Outp sont toutes acceptables. D'autres formes, telles que OUT, ne sont pas valides et génèrent une erreur.

Requêtes

Le fait d'ajouter un point d'interrogation (?) à la fin d'un mot-clé transforme ce dernier en requête (exemple : VOLTage?, VOLTage:TRIGgered?). Si une requête contient des paramètres, placez l'indicateur correspondant à la fin du dernier mot-clé, avant les paramètres. Insérez un espace entre l'indicateur de requête et le premier paramètre.

Vous pouvez rechercher la valeur programmée de la plupart des paramètres. Par exemple, vous pouvez obtenir le temps OUTPut:DELay:FALL précédemment réglé en envoyant la commande suivante :

```
OUTPut:DELay:FALL?
```

Vous pouvez également rechercher le temps de descente minimal ou maximal comme suit :

```
OUTPut:DELay:FALL? MIN  
OUTPut:DELay:FALL? MAX
```

Vous devez relire tous les résultats d'une requête avant d'envoyer une autre commande à l'instrument. Sinon, l'erreur *Query Interrupted* s'affiche et les données non renvoyées sont perdues.

Séparateurs et caractères de fin de commande

Séparateurs

Le signe des deux points (:) sépare les niveaux de mots-clés. Des espaces blancs doivent être utilisés pour séparer les paramètres de commande de leur mot-clé correspondant. Si une commande requiert plusieurs paramètres, utilisez une virgule pour séparer les paramètres adjacents. Dans l'exemple suivant, les paramètres *startindex* et *points* facultatifs doivent être séparés par une virgule. Notez l'espace entre CURRent? et le premier paramètre.

```
FETCh:CURRent? [<start_index>, <points>]
```

Les points-virgules (;) séparent les commandes dans un même sous-système. Vous pouvez ainsi envoyer plusieurs commandes de sous-système dans la même chaîne de message. Par exemple, envoyer la chaîne de commande suivante :

```
OUTPut:STATe ON;DELay:RISE 1;FALL 2
```

revient à envoyer les commandes suivantes :

```
OUTPut ON
OUTPut:DELay:RISE 1
OUTPut:DELay:FALL 2
```

Notez que le point-virgule suit le chemin implicite de la structure arborescente hiérarchique. Dans l'exemple ci-dessus, le mot-clé :STATe facultatif doit suivre le mot-clé OUTput pour placer l'analyseur de commande au deuxième niveau de la hiérarchie. Cela permet d'utiliser le mot-clé DELay après le point-virgule, car DELay est un mot-clé de deuxième niveau. Ensuite, l'analyseur de commande est placé au troisième niveau de la hiérarchie par le mot-clé :RISE. Cela permet d'utiliser le mot-clé FALL après le deuxième point-virgule, car FALL est un mot-clé de troisième niveau.

Vous pouvez également combiner des commandes de différents sous-systèmes dans la même chaîne de message. Dans ce cas, vous devez utiliser deux points pour renvoyer l'analyseur de commande au niveau de la racine afin d'accéder à un autre sous-système. Par exemple, vous pouvez annuler la fonction de protection et vérifier l'état du registre des conditions de fonctionnement dans un message à l'aide d'un spécificateur de racine comme suit :

```
OUTPut:PROTEction:CLEar;;STATus:OPERation :CONDition?
```

Notez l'utilisation des deux points *après* le point-virgule afin de renvoyer l'analyseur de commande vers la racine.

Caractères de fin

Une chaîne de commande envoyée à l'instrument doit se terminer par un caractère de nouvelle ligne (<NL>). Le message IEEE-488 EOI (End-Or-Identify) est interprété comme un caractère <NL> et peut être utilisé à la place d'un <NL> pour terminer une chaîne de commande. Un retour chariot suivi d'une nouvelle ligne (<CR><NL>) est également accepté. Le caractère de fin de commande réinitialise toujours le chemin de la commande SCPI au niveau racine.

Conventions syntaxiques

- Les crochets angulaires (< >) indiquent que vous devez indiquer une valeur pour le paramètre délimité. Par exemple, dans les instructions syntaxiques OUTPut:DELay ci-dessus, le paramètre <valeur> est entouré de crochets angulaires. Les crochets ne sont pas envoyés avec la chaîne de commande. Vous devez spécifier une valeur pour le paramètre (exemple : "OUTP:DEL:FALL 0.1"), sauf si vous sélectionnez une autre option indiquée dans la syntaxe (exemple : "OUTP:DEL:FALL MIN").

- Une barre verticale (|) sépare plusieurs paramètres dans une chaîne de commande donnée. Par exemple, la chaîne LATCHing|LIVE|OFF dans la commande OUTPut:INHibit indique que vous pouvez spécifier « LATCHing », « LIVE » ou « OFF ». La barre n'est pas envoyée avec la chaîne de commande.
- Les crochets ([]) entourent certains éléments syntaxiques, par exemple des nœuds et des paramètres. Cela indique que cet élément est facultatif. Les crochets ne sont pas envoyés avec la chaîne de commande. Dans le cas d'un paramètre facultatif, si vous ne spécifiez aucune valeur, l'instrument ignore ce paramètre. Dans l'exemple FETCh:CURRent? ci-dessus, les paramètres <startindex> et <points> vous permettent de renvoyer les données de tableau commençant à startindex et contenant le nombre de points de données spécifiés. Si ces paramètres ne sont pas spécifiés, la requête renvoie toutes les données de tableau.
- Les accolades ({ }) indiquent les paramètres pouvant être répétés zéro fois ou plus. On les utilise plus particulièrement pour l'affichage de listes. La notation <valeur>{,<valeur>} indique que la première valeur doit être saisie, alors que les valeurs supplémentaires peuvent être omises ou saisies une ou plusieurs fois.

Types de paramètres

Le langage SCPI définit plusieurs formats de données à utiliser dans les commandes et les requêtes.

Paramètres numériques

Les commandes qui nécessitent des paramètres numériques acceptent toutes les notations décimales courantes des nombres, y compris les signes facultatifs, les points décimaux et la notation scientifique. Si une commande accepte uniquement certaines valeurs, l'instrument arrondit automatiquement les paramètres numériques d'entrée aux valeurs admises. La commande suivante requiert un paramètre numérique pour la valeur de tension :

```
[SOURce:]VOLTage 50V|MIN|MAX
```

Notez que des valeurs spéciales, telles que MINimum, MAXimum et INFinity, sont également admises pour les paramètres numériques. Au lieu de sélectionner une valeur donnée pour le paramètre de tension, vous pouvez utiliser MIN pour régler la tension à sa valeur minimale autorisée et MAX pour la définir à sa valeur maximale autorisée.

Vous pouvez également envoyer des suffixes d'unités techniques (par ex., V pour volts, A pour ampères, W pour watts). Toutes les valeurs de paramètre sont exprimées en unités de base.

Paramètres discrets

Les paramètres discrets permettent de programmer des réglages ayant un nombre limité de valeurs (par ex., IMMEDIATE, EXTERNAL ou BUS). Ils peuvent avoir une forme abrégée et une forme complète tout comme les mots-clés de commandes. Vous pouvez utiliser des majuscules ou minuscules. Les réponses aux requêtes renvoient toujours la forme abrégée en lettres majuscules. La commande suivante requiert un paramètre discret pour les paramètres d'affichage :

```
DISPlay:VIEW METER_VI|METER_VP|METER VIP
```

Paramètres booléens

Les paramètres booléens représentent une condition binaire exclusivement vraie ou fausse. Pour une condition fausse, l'instrument accepte "OFF" ou "0". Pour une condition vraie, l'instrument accepte "ON" ou "1". Lorsque vous effectuez une requête sur un paramètre logique, l'appareil renvoie toujours "0" ou "1". La commande suivante nécessite un paramètre booléen :

```
DISPlay OFF|0|ON|1
```

Paramètres de chaînes ASCII

Les paramètres de chaînes peuvent pratiquement contenir n'importe quelle combinaison de paramètres ASCII. Une chaîne de caractères doit commencer et se terminer par des guillemets simples ou doubles. Vous pouvez inclure le délimiteur de guillemets dans la chaîne de caractères en le tapant deux fois sans caractères entre eux. La commande suivante utilise un paramètre de chaîne de caractères :

```
CALibrate:DATE "12/12/12"
```

Programme ou données de réponse de bloc arbitraire

Les données en bloc <Bloc> de longueur définie permettent de programmer ou de renvoyer les données dépendant d'un appareil sous forme d'un ensemble de données binaires sur 8 bits. Cela est particulièrement utile pour transférer de grandes quantités de données ou des codes ASCII étendus sur 8 bits.

Device Clear

Device Clear est un message de bas niveau du bus IEEE-488 que vous pouvez utiliser pour ramener l'instrument à l'état réactif. Différents langages de programmation et cartes d'interface IEEE-488 permettent d'accéder à cette fonction au moyen de commandes uniques propres. Les registres d'état, la file d'erreurs et tous les états de configuration restent inchangés quand un message Device Clear message est reçu.

Device Clear effectue les actions suivantes :

- Si une mesure est en cours, elle est annulée.
- L'instrument revient à l'état de déclenchement inactif.
- Les tampons d'entrée et de sortie de l'instrument sont effacés.
- L'instrument est prêt à recevoir une nouvelle chaîne de commande.

REMARQUE La commande ABORt est la méthode recommandée pour interrompre une opération de l'instrument.

Temps de traitement de commande type

Le tableau suivant décrit quelques-uns des temps moyens de traitement de commande type pour plusieurs types de commandes de réglage et requêtes de réponse. Vous pourrez ainsi déterminer l'impact de certaines commandes SCPI couramment utilisées sur la durée de test totale. Tous les temps sont exprimés en millisecondes.

Les commandes de réglage, telles que VOLT <n> prennent uniquement en compte la latence des E/S + le traitement de la commande, et non le temps nécessaire pour terminer l'action (comme le temps nécessaire à la modification effective de la tension de sortie ou l'activation de l'état de sortie).

Les temps de commande de requête s'appliquent entre le moment où la commande est envoyée à l'instrument et celui où la réponse est reçue.

Commandes	GPIB	VXI-11
Régler la tension de sortie : VOLT <n>	0,24 ms	0,65 ms
Renvoyer le réglage de sortie : OUPP?	0,30 ms	1,35 ms
Définir l'appareil à l'état de réinitialisation : *RST	5,01 ms	5,26 ms
Mesure de 10 points		
Renvoyer la mesure de 10 points : MEAS:VOLT?	3,00 ms	3,30 ms
Renvoyer la récupération de 10 points : FETC:VOLT?	0,49	1,49 ms
Mesure de 1 NPLC		
Renvoyer la mesure de 1 NPLC : MEAS:VOLT?	21,03 ms	20,96 ms
Renvoyer la récupération de 1 NPLC : FETC:VOLT?	0,63 ms	1,41 ms
Mesure de 25 000 points		
Renvoyer la mesure de 25 000 points : MEAS:VOLT?	521,0 ms	521,1 ms
Renvoyer la récupération de 25 000 points : FETC:VOLT?	5,07 ms	7,01 ms
Renvoyer la récupération du tableau ASCII de 25 000 points : FETC:ARR:VOLT?	4009,5 ms	1010,8 ms
Renvoyer la récupération du tableau binaire de 25 000 points : FETC:ARR:VOLT?	694,25 ms	30,39

Commandes par sous-système

ABORt

CALibrate

DISPlay

FETCh

FORMat

HCOPy

IEEE-488 Common

INITiate

INSTrument

LXI

MEASure

OUTPut

SENSe

[SOURce:]

ARB

CURRent

DIGital

FUNction

LIST

POWer

STEP

VOLTage

STATus

SYSTem

TRIGger

Sous-système ABORt

Les commandes Abort permettent d'annuler toutes les actions déclenchées et de renvoyer le système de déclenchement à l'état inactif. Elles sont également exécutées avec la commande *RST.

ABORt:ACQuire

ABORt:ELOG

ABORt:TRANsient

ABORt:ACQuire : Annule toutes les mesures déclenchées. Cette commande réinitialise également les bits WTG-meas et MEAS-active dans les registres d'état de fonctionnement.

ABORt:ELOG : Arrête l'enregistrement de données externe. Cette commande réinitialise également les bits WTG-meas et MEAS-active dans les registres d'état de fonctionnement.

ABORt:TRAN Annule toutes les actions déclenchées. Cette commande réinitialise également les bits WTG-tran et TRAN-actif dans les registres d'état de fonctionnement. Notez que cette commande ne désactive pas les déclenchements continus si la commande INITiate:CONTinuous:TRANsient ON a été programmée. Dans ce cas, le système de déclenchement est automatiquement réinitialisé.

Paramètre	Renvoi type
(aucun)	(aucun)
Interrompt la mesure déclenchée : ABOR:ACQ	

Sous-système ARB

Les commandes ARB permettent de programmer des signaux arbitraires à palier constant. Les signaux à palier constant peuvent se voir attribués jusqu'à 65 535 points, le même temps de palier étant appliqué à chaque point.

[SOURce:]ARB:COUNT <valeur>|MIN|MAX|INFinity
[SOURce:]ARB:COUNT? [{MIN|MAX}]

Indique le nombre de répétitions du signal arbitraire. Utilisez le paramètre INFinity pour répéter continuellement le signal arbitraire.

Paramètre	Renvoi type
1 - 256, *RST 1	<nombre>
Programme 10 répétitions : ARB:COUN 10	

[SOURce:]ARB:CURRent:CDWell[:LEVel] <valeur>{,<valeur>}<Bloc>
[SOURce:]ARB:CURRent:CDWell[:LEVel]?
[SOURce:]ARB:VOLTage:CDWell[:LEVel] <valeur>{,<valeur>}<Bloc>
[SOURce:]ARB:VOLTage:CDWell[:LEVel]?

Indique le temps de chaque point dans le signal arbitraire. Les valeurs sont exprimées en ampères ou en volts. Les valeurs minimale et maximale varient selon les valeurs nominales de l'appareil.

Les signaux arbitraires de courant et de tension partagent les mêmes réglages. Le réglage du signal arbitraire de courant entraîne donc la réinitialisation du niveau du signal arbitraire de tension à sa valeur par défaut et vice versa. Pour des performances optimales, vous pouvez envoyer la liste sous forme de valeurs à virgule flottante simple précision au format de bloc arbitraire de taille définie à la place d'une liste ASCII. Le format de la réponse dépend du format de retour ASCII ou REAL.

Paramètre	Renvoi type
-102 à 102 % du courant nominal ou 0 à 102 % de la tension nominale	<valeur> [,<valeur>] ou <Bloc>
Programme un signal arbitraire à palier constant de 5 points de tension : ARB:VOLT:CDW 5,4,3,2,1	

[SOURce:]ARB:CURRent:CDWell:DWELL <valeur>
[SOURce:]ARB:CURRent:CDWell:DWELL?
[SOURce:]ARB:VOLTage:CDWell:DWELL <valeur>
[SOURce:]ARB:VOLTage:CDWell:DWELL?

Indique le temps de palier de chaque point dans le signal arbitraire. Les valeurs sont exprimées en secondes et sont arrondies à l'incrément de 10,24 microsecondes le plus proche.

5 Aide-mémoire de la programmation SCPI

Les signaux arbitraires de courant et de tension partagent les mêmes paramètres. La définition de ce paramètre pour un signal arbitraire de courant entraîne donc la modification de la valeur du palier de tension et vice versa.

Paramètre	Renvoi type
0.00001024 – 0.30, *RST 0.001	<valeur de palier>
Programme un temps de palier constant de 0,2 seconde : <code>ARB:CURR:CDW:DWEL 0.2</code>	

- Vous pouvez programmer des durées de palier beaucoup plus courtes que le temps de réponse de l'instrument. Les points « supplémentaires » et les durées de palier peuvent servir à lisser le signal obtenu.

[SOURce:]ARB:CURRent:CDWWell:POINts?

[SOURce:]ARB:VOLTage:CDWWell:POINts?

Renvoie le nombre de points dans le signal arbitraire.

Paramètre	Renvoi type
(aucun)	<points>
Renvoie le nombre de points de courant dans le signal arbitraire : <code>ARB:CURR:CDW:POIN?</code>	

[SOURce:]ARB:FUNCtion:TYPE CURRent|VOLTage

[SOURce:]ARB:FUNCtion:TYPE?

Indique un signal arbitraire de tension ou de courant. Un seul type de signal arbitraire peut être généré à la fois. La sélection doit correspondre au mode de priorité.

Paramètre	Renvoi type
CURRent VOLTage, *RST VOLTage	VOLT ou CURR
Indique un signal arbitraire de tension : <code>ARB:FUNC:TYPE VOLT</code>	

[SOURce:]ARB:TERMinate:LAST 0|OFF|1|ON

[SOURce:]ARB:TERMinate:LAST?

Sélectionne le réglage de sortie à la fin du signal arbitraire. Si cette commande est activée (1), la tension ou le courant de sortie sont maintenus à la dernière valeur du signal arbitraire. La dernière valeur de tension ou de courant du signal arbitraire devient la valeur IMMEDIATE une fois le signal arbitraire terminé. Si elle est désactivée (0) et que le signal arbitraire est interrompu, la sortie retourne aux paramètres qui étaient appliqués avant le début du signal arbitraire.

Paramètre	Renvoi type
0 OFF 1 ON, *RST OFF	0 ou 1
Interrompt avec la sortie définie à la dernière valeur du signal arbitraire : <code>ARB:TERM:LAST ON</code>	

Sous-système CALibrate

Les commandes Calibrate permettent d'étalonner l'instrument.

REMARQUE Lisez la **section d'étalonnage** avant d'effectuer un étalonnage. Un étalonnage incorrect réduit la précision et la fiabilité de l'instrument.

CALibrate:COUNT?

Renvoie le nombre de fois que l'appareil a été étalonné. Le nombre est incrémenté chaque fois que l'étalonnage (et la date) est enregistré, le mot de passe d'administration modifié ou réinitialisé, ou le microprogramme mis à jour.

Paramètre	Renvoi type
(aucun)	<nombre>
Renvoyer le nombre d'étalonnages : CAL:COUN?	

CALibrate:CURRent[:LEVel] <valeur>

Étalonne la programmation et la mesure du courant. La valeur sélectionne la plage à étalonner.

Paramètre	Renvoi type
Courant maximal de la plage de sortie.	(aucun)
Étalonne le courant de la plage de 10 A : CAL:CURR 10	

CALibrate:CURRent:SHARing RP795xA, RP796xA

Étalonne le signal Imon des appareils connectés en parallèle.

Paramètre	Renvoi type
(aucun)	(aucun)
Étalonne le partage de courant : CAL:CURR:SHAR	

CALibrate:CURRent:TC RP793xA, RP794xA

Étalonne le coefficient de température.

Paramètre	Renvoi type
(aucun)	(aucun)
Étalonne le coefficient de température : CAL:CURR:TC	

CALibrate:DATA < valeur >

Saisit la valeur d'étalonnage relevée sur le multimètre externe. Vous devez d'abord sélectionner un niveau d'étalonnage pour la valeur saisie. Les valeurs de données sont exprimées en unités de base (volts ou ampères), selon la fonction en cours d'étalonnage.

Paramètre	Renvoi type
Valeur numérique	(aucun)
Spécifier la valeur d'étalonnage 0,0237 : <code>CAL:DATA 2.37E-2</code>	

CALibrate:DATE < "date" >**CALibrate:DATE?**

Enregistre la date d'étalonnage dans la mémoire non volatile. Saisissez une chaîne ASCII d'une longueur maximale de 15 caractères. La requête renvoie la date.

Paramètre	Renvoi type
< "date" > Données du programme de chaîne. Entourez les paramètres de chaînes de guillemets simples ou doubles.	< date du dernier étalonnage >
Saisit la date d'étalonnage : <code>CAL:DATE "12/12/12"</code>	

CALibrate:LEVel P1|P2|P3**CALibrate:LEVel?**

Passer au niveau d'étalonnage suivant. P1 est le premier niveau, P2 le deuxième et P3 le troisième.

Paramètre	Renvoi type
P1 P2 P3	(aucun)
Sélectionne le premier point d'étalonnage : <code>CAL:LEV P1</code>	

- Certaines séquences d'étalonnage peuvent nécessiter un certain temps de stabilisation après l'envoi de la commande `CAL:LEV`, mais avant de lire les données sur le multimètre numérique et d'envoyer la commande `CAL:DATA`.

CALibrate:PASSword < motdepasse >

Définit un mot de passe numérique pour empêcher tout étalonnage non autorisé. Identique au mot de passe **Admin**.

Paramètre	Renvoi type
<motdepasse> Valeur numérique pouvant contenir jusqu'à 15 chiffres	(aucun)
Définir un nouveau mot de passe à la valeur 1234 : CAL:PASS 1234	

- Si le mot de passe est défini sur 0, la protection par mot de passe est supprimée et la possibilité de passer en mode d'étalonnage est illimitée. Le paramètre configuré en usine est égal à 0 (zéro).
- Modifier le mot de passe : libérez la mémoire d'étalonnage avec l'ancien code, puis configurez le nouveau code.
- Si vous avez oublié votre mot de passe, reportez-vous à la section **Commutateurs d'étalonnage**.
- Ce paramètre est non volatile ; une coupure/rétablissement de l'alimentation ou la commande *RST ne le modifie pas.

CALibrate:RESistance:BOUT RP795xA, RP796xA

Étalonne la résistance de sortie inférieure.

Paramètre	Renvoi type
(aucun)	(aucun)
Étalonne la résistance de sortie inférieure : CAL:RES:BOUT	

CALibrate:SAVE

Enregistre les constantes d'étalonnage dans la mémoire non volatile. Effectuez cette opération à la fin de l'étalonnage pour éviter de perdre vos modifications.

Paramètre	Renvoi type
(aucun)	(aucun)
Enregistrer les constantes d'étalonnage en mémoire non volatile : CAL:SAVE	

CALibrate:STATe 0|OFF|1|ON [, <mot de passe>] CALibrate:STATe?

Active ou désactive le mode d'étalonnage. Le mode d'étalonnage doit être activé pour que l'instrument accepte des commandes d'étalonnage. Le premier paramètre indique l'état. Le deuxième paramètre facultatif est le mot de passe.

Paramètre	Renvoi type
0 OFF 1 ON, *RST OFF	0 ou 1
<motdepasse> : valeur numérique d'une longueur maximale de 15 chiffres.	(aucun)

5 Aide-mémoire de la programmation SCPI

Paramètre	Renvoi type
Désactiver l'étalonnage : CAL:STAT OFF	
Activer l'étalonnage : CAL:STAT ON [,valeur]	

Un mot de passe est nécessaire si <motdepasse> a été défini à une valeur différente de zéro.

CALibrate:VOLTage[:LEVel] <valeur>

Étalonne la programmation et la mesure de la tension locale. La valeur sélectionne la plage à étalonner.

Paramètre	Renvoi type
Courant maximal de la plage de sortie en cours d'étalonnage.	(aucun)
Étalonne la tension de la plage de 20 V : CAL:VOLT 20	

Sous-système CURRent

Les commandes Current permettent de programmer le courant de sortie de l'instrument.

[SOURce:]CURRent[:LEVel][:IMMediate][:AMPLitude] <valeur>|MIN|MAX
[SOURce:]CURRent[:LEVel][:IMMediate][:AMPLitude]? [{MIN|MAX}]
[SOURce:]CURRent[:LEVel]:TRIGgered[:AMPLitude] <valeur>|MIN|MAX
[SOURce:]CURRent[:LEVel]:TRIGgered[:AMPLitude]? [{MIN|MAX}]

Définit le niveau de courant immédiat ou déclenché lorsque la sortie fonctionne en mode de priorité de courant. Le niveau déclenché est une valeur enregistrée qui est transférée vers la sortie lors du déclenchement d'un palier de sortie. Les unités sont exprimées en ampères. La valeur maximale varie selon le courant nominal de l'appareil. La valeur minimale est la valeur la plus négative.

Paramètre	Renvoi type
-102 à 102 % de la valeur nominale, *RST0	<niveau du courant>
Règle la limite de courant positive sur 2 A : CURR:LIM 2	

[SOURce:]CURRent:BWIDth:LEVel 0 | 1, <valeur>|MIN|MAX RP793xA, RP794xA
[SOURce:]CURRent:BWIDth:LEVel? [{MIN|MAX}]

Indique la fréquence d'angle du filtre passe-bas appliquée au signal du point de consigne de programmation avec la plage indiquée des points de consigne configurables par l'utilisateur. La valeur est en Hertz. La fréquence par défaut est optimisée pour une vitesse de programmation amont maximale, ainsi que pour le temps de réponse transitoire le plus rapide. Il est possible de la réduire pour compenser les dépassements de sortie.

Paramètre	Renvoi type
0 1	0 ou 1
10 à 5 000 toutes les plages	<fréquence polaire>
Définit la bande passante de courant à 1, fréquence 60 Hz : CURR:BWID:LEV 1, 60	

[SOURce:]CURRent:BWIDth:RANGe 0 | 1 RP793xA, RP794xA
[SOURce:]CURRent:BWIDth[:RANGe]?

Définit la compensation du courant. Cette commande vous permet d'optimiser le temps de réponse de la sortie avec des charges inductives. Ces modes de compensation ne s'appliquent que lorsque l'appareil fonctionne en courant constant (CC), à la fois en mode de priorité de courant et en mode de priorité de tension (lorsqu'il se trouve en limite de courant).

Paramètre	Description
-----------	-------------

0	Optimisé pour la stabilité avec une vaste plage d'inductances de sortie. Pour des limites de charge inductives spécifiques, reportez-vous à la section Configurer la bande passante de sortie .
1	Assure une vitesse de programmation amont maximale et un temps de réponse transitoire extrêmement court lorsque l'inductance de sortie est limitée à des valeurs faibles.

Paramètre	Renvoi type
0 1, *RST 0	0 ou 1
Définit la bande passante de courant à 1 : <code>CURR:BWID 1</code>	

[SOURce:]CURRent:LIMit[:POSitive][:IMMEDIATE][:AMPLitude] <valeur>|MIN|MAX [SOURce:]CURRent:LIMit[:POSitive][:IMMEDIATE][:AMPLitude]? [{MIN|MAX}][SOURce:]CURRent:LIMit:NEGative[:IMMEDIATE][:AMPLitude] <valeur>|MIN|MAX [SOURce:]CURRent:LIMit:NEGative[:IMMEDIATE][:AMPLitude]? [{MIN|MAX}]

Définit la limite de courant en mode de priorité de tension. Les unités sont exprimées en ampères. La valeur maximale varie selon le courant nominal de l'appareil. La valeur minimale est la valeur la plus négative.

Paramètre	Renvoi type
Positive : 0 à 102 % de la valeur nominale, *RST 1,02 % de la valeur nominale	<limite de courant +> <limite de courant ->
Negative : -102 % de la valeur nominale à 0, *RST -102 % de la valeur nominale	
Règle la limite de courant positive sur 2 A : <code>CURR:LIM 2</code>	
Règle la limite de courant négative sur -2 A : <code>CURR:LIM:NEG -2</code>	

[SOURce:]CURRent:MODE FIXed|STEP|LIST|ARB [SOURce:]CURRent:MODE?

Définit le mode de transitoire. Cette commande détermine ce qu'il advient du courant de sortie lorsque le système de transitoire est démarré et déclenché.

FIXed maintient le courant de sortie à sa valeur immédiate.

STEP (palier) fait passer la sortie au niveau déclenché lorsqu'un déclenchement se produit.

ARB entraîne la mise en conformité de la sortie aux valeurs de liste lorsqu'un déclenchement se produit.

ARB provoque la conformité de la sortie aux valeurs du signal arbitraire lorsqu'un déclenchement se produit.

Paramètre	Renvoi type
FIXed STEP LIST ARB, *RST FIXed	FIX, STEP, LIST ou ARB

Paramètre	Renvoi type
Définit le mode de courant sur Step : <code>CURR:MODE STEP</code>	

[SOURce:]CURRent:PROTection:DELAy[:TIME] <valeur>|MIN|MAX
[SOURce:]CURRent:PROTection:DELAy[:TIME]? [{MIN|MAX}]

Définit le délai de protection contre les surintensités. La fonction de protection contre les surintensités n'est pas déclenchée pendant le délai de temporisation. Une fois le délai expiré, la fonction de protection contre les surintensités est activée. Cela permet d'éviter que les variations momentanées de l'état de sortie ne déclenchent la fonction de protection contre les surintensités. Les valeurs allant jusqu'à 255 millisecondes peuvent être programmées avec une résolution de 1 milliseconde.

Paramètre	Renvoi type
0 – 0.255, *RST 0.020 s	<valeur de délai>
Définit le délai de protection à 0,2 seconde : <code>CURR:PROT:DEL 0.2</code>	

- La fonction de protection contre les surintensités est affectée par le réglage de l'événement de démarrage du délai de protection contre les surintensités, qui est spécifié par la commande `CURRent:PROTection:DELAy:STARt`.

[SOURce:]CURRent:PROTection:DELAy:STARt SCHange|CCTRans
[SOURce:]CURRent:PROTection:DELAy:STARt?

Indique l'événement déclencheur du temporisateur de protection contre les surintensités. `SCHange` déclenche le délai de protection contre les surintensités chaque fois qu'une commande modifie les réglages de sortie. `CCTRans` déclenche le temporisateur de protection contre les surintensités chaque fois que la sortie passe en mode de limite de courant.

Paramètre	Renvoi type
<code>SCHange CCTRans</code> , *RST <code>SCHange</code>	SCH ou CCTR
Sélectionne le mode de délai <code>CCTRans</code> : <code>CURR:PROT:DEL:STAR CCTR</code>	

[SOURce:]CURRent:PROTection:STATe 0|OFF|1|ON
[SOURce:]CURRent:PROTection:STATe?

Active ou désactive la fonction de protection contre les surintensités. Si la fonction de protection contre les surintensités est activée et que la sortie passe en mode de limite de courant, la sortie est désactivée et le bit d'état OCP du registre d'état des conditions suspectes est activé.

Paramètre	Renvoi type
0 OFF 1 ON, *RST OFF	0 ou 1
Activer l'état de protection contre les surintensités : <code>CURR:PROT:STAT ON</code>	

- Une condition de surintensité peut être annulée à l'aide de la commande OUTPUT:PROTECTION:CLEAR une fois la cause du problème isolée.

[SOURCE:]CURRENT:SHARING[:STATE] 0|OFF|1|ON RP795xA, RP796xA
[SOURCE:]CURRENT:SHARING[:STATE]?

Active ou désactive la fonction de partage de courant sur les appareils connectés en parallèle. Cette commande doit être envoyée à chaque appareil non connecté en parallèle. Si elle est activée, le courant de charge est partagé de façon équitable entre les sorties connectées en parallèle. Les bornes **Share (Partage)** du panneau arrière doivent être connectées. Sinon, une erreur se produit.

Paramètre	Renvoi type
0 OFF 1 ON, *RST OFF	0 ou 1
Activer le partage de courant : <code>CURRENT:SHARING ON</code>	

[SOURCE:]CURRENT:SLEW[:IMMEDIATE] <valeur>|MIN|MAX|INFINITY
[SOURCE:]CURRENT:SLEW[:IMMEDIATE]? [{MIN|MAX}]

Définit la vitesse de balayage du courant. La vitesse de balayage est définie en ampères par seconde et concerne toutes les variations de courant programmées, notamment celles dues à l'activation ou la désactivation de l'état de sortie. La vitesse de balayage peut être réglée sur n'importe quelle valeur comprise entre 0 et $9,9E+37$. Pour les valeurs très élevées, la vitesse de balayage est limitée par la vitesse de programmation et la bande passante indiquées de l'appareil. Les mots-clés MAX ou INFINITY définissent la vitesse de balayage à la valeur maximale.

Paramètre	Renvoi type
0 – $9,9E+37$, *RST MAX	<valeur max.>
Définit la vitesse de balayage de sortie à 1 A par seconde : <code>CURRENT:SLEW 1</code>	

- La requête renvoie la valeur qui a été envoyée. Si la valeur est inférieure à la vitesse de balayage minimale, la valeur minimale est renvoyée. La résolution du paramètre de balayage est également la valeur minimale, qui peut être recherchée à l'aide de la commande CURRENT:SLEW? MIN. La valeur exacte varie sensiblement en fonction de l'étalonnage.

[SOURCE:]CURRENT:SLEW:MAXIMUM 0|OFF|1|ON
[SOURCE:]CURRENT:SLEW:MAXIMUM?

Active ou désactive le remplacement de la vitesse de balayage maximale. Lorsqu'elle est activée, la vitesse de balayage est définie à sa valeur maximale. Lorsqu'elle est désactivée, la vitesse de balayage est définie à la valeur immédiate par la commande CURRENT:SLEW. Utilisez CURRENT:SLEW? MAX pour rechercher la vitesse de balayage maximale qui a été définie.

Paramètre	Renvoi type
0 OFF 1 ON, *RST ON	0 ou 1

Paramètre	Renvoitype
Activer la vitesse de balayage maximale : <code>CURR:SLEW:MAX ON</code>	

- La commande `CURRent:SLEW:MAX` est associée à la commande `CURRent:SLEW`. Si `CURRent:SLEW` définit la vitesse sur `MAX` ou `INFINITY`, la commande `CURRent:SLEW:MAX` est activée. Si la vitesse de balayage est définie sur une autre valeur, la commande `CURRent:SLEW:MAX` est désactivée.

Sous-système DIGital

Les commandes Digital permettent de programmer le port de commande numérique situé sur le panneau arrière de l'instrument.

[SOURCE:]DIGital:INPut:DATA?

Lit l'état du port de commande numérique. Renvoie la valeur binaire pondérée de l'état des broches 1 à 7 des bits 0 à 6, respectivement.

Paramètre	Renvoi type
(aucun)	<valeur de bit>
Lit l'état du port de commande numérique : DIG:INP:DATA?	

[SOURCE:]DIGital:OUTPut:DATA <valeur>

[SOURCE:]DIGital:OUTPut:DATA?

Définit l'état du port de commande numérique. Cette commande ne concerne que les broches dont la fonction a été définie pour une utilisation de la fonction E/S numérique. Le port comporte sept broches de signal et une broche de terre numérique. Dans la valeur binaire pondérée qui est écrite dans le port, les broches sont contrôlées conformément aux affectations de bit suivantes :

Broche	1	2	3	4	5	6	7
Numéro de bit	0	1	2	3	4	5	6
Valeur décimale	1	2	4	8	16	32	64

Les valeurs de bit correspondant aux broches du port numérique qui ne sont pas configurées comme E/S num. sont ignorées.

Paramètre	Renvoi type
0 - 127, *RST 0	<valeur de bit>
Programme les broches 1, 3 et 5 : DIG:OUTP:DATA?	

[SOURCE:]DIGital:PIN<1-7>:FUNction <fonction>

[SOURCE:]DIGital:PIN<1-7>:FUNction?

Définit la fonction de la broche. Les fonctions sont enregistrées dans la mémoire non volatile.

DIO	Fonction d'entrée/sortie numérique polyvalente référencée à la masse.
DINPut	Mode d'entrée numérique uniquement.
FAULt	La broche 1 fonctionne comme une sortie d'erreur isolée. La broche 2 est commune à la broche 1.
INHibit	La broche 3 fonctionne comme une entrée d'inhibition.
ONCouple	Les broches 4 -7 synchronisent l'état d'activation de la sortie.

OFFCouple	Les broches 4 -7 synchronisent l'état de désactivation de la sortie.
TINPut	Fonction d'entrée de déclenchement.
TOUTput	Fonction de sortie de déclenchement.

Paramètre	Renvoi type
DIO DINPut FAULt INHibit ONCouple OFFCouple TINPut TOUTput	DIO, DINP, FAUL, INH, ONC, OFFC, TINP, ou TOUT
Définit la broche 1 en mode FAULt : DIG:PIN1:FUNC FAUL	

[SOURce:]DIGital:PIN<1-7>:POLarity POSitive|NEGative **[SOURce:]DIGital:PIN<1-7>:POLarity?**

Définit la polarité de la broche. **POSitive** signifie qu'un signal vrai logique est une tension élevée sur la broche. Pour les entrées et les sorties de déclenchement, POSitive équivaut à un front montant. Définir la polarité d'une broche sur **NEGative** signifie qu'un signal vrai logique est une tension faible sur la broche. Pour les entrées et les sorties de déclenchement, NEGative équivaut à un front descendant. Les polarités de la broche sont enregistrées dans la mémoire non volatile.

Paramètre	Renvoi type
POSitive NEGative	POS ou NEG
Définit la broche 1 sur la polarité POSitive : DIG:PIN1:POL POS	

[SOURce:]DIGital:TOUTput:BUS[:ENABLE] 0|OFF|1|ON **[SOURce:]DIGital:TOUTput:BUS[:ENABLE]?**

Active ou désactive les déclencheurs BUS sur les broches du port numérique. Cette commande permet d'envoyer un signal de déclenchement par BUS à une broche de port numérique qui a été configurée comme sortie de déclenchement. Une impulsion de sortie de déclenchement est générée lorsque l'état est activé et qu'une commande de déclenchement de bus est reçue. Un signal de déclenchement par BUS est généré à l'aide de la commande *TRG.

Paramètre	Renvoi type
0 OFF 1 ON, *RST OFF	0 ou 1
Activer des signaux déclenchés par BUS sur les broches numériques : CURR:TOUT:BUS ON	

- La requête renvoie la valeur 0 (OFF) si le signal de déclenchement NE sera PAS généré à l'aide d'une commande de déclenchement BUS et la valeur 1 (ON) si un signal de déclenchement sera généré à l'aide d'une commande de déclenchement BUS.

Sous-système DISPlay

Les commandes Display permettent de contrôler l'écran du panneau avant.

DISPlay[:WINDow][:STATe] 0|OFF|1|ON
DISPlay[:WINDow][:STATe]?

Allume ou éteint l'écran du panneau avant.

Paramètre	Renvoi type
0 OFF 1 ON, *RST ON	0 ou 1
Éteint l'écran du panneau avant : DISP OFF	

DISPlay[:WINDow]:VIEW METER_VI|METER_VP|METER_VIP
DISPlay[:WINDow]:VIEW?

Sélectionne les paramètres à afficher sur le panneau avant. **METER_VI** affiche la tension et le courant de sortie. **METER_VP** affiche la tension et la puissance de sortie. **METER_VIP** affiche la tension, le courant et la puissance de sortie.

Paramètre	Renvoi type
METER_VI METER_VP METER_VIP, *RST METER_VI	METER_VI, METER_VP, ou METER_VIP
Afficher la tension et la puissance : DISP:VIEW METER_VP	

DISPlay:SAVer[:STATe] 0|OFF|1|ON
DISPlay:SAVer[:STATe]?

Allume ou éteint l'écran de veille du panneau avant.

Paramètre	Renvoi type
0 OFF 1 ON, *RST OFF	0 ou 1
Allume l'écran de veille du panneau avant : DISP:SAV ON	

Sous-système FETCh

Les commandes Fetch permettent de renvoyer les données de mesure qui ont été précédemment acquises. Les requêtes FETCh ne génèrent pas de nouvelles mesures. Cependant, elles permettent de réaliser des calculs de mesure supplémentaires à partir des mêmes données acquises. Les données sont valides jusqu'au déclenchement de la commande MEASure ou INITiate suivante.

FETCh[:SCALar]:CURRent[:DC]? [<start_index>, <points>]

FETCh[:SCALar]:VOLTage[:DC]? [<start_index>, <points>]

FETCh[:SCALar]:POWer[:DC]?

Renvoie la mesure moyenne. Les valeurs renvoyées sont exprimées en volts ou en watts.

Les paramètres facultatifs indiquent un sous-ensemble commençant à <startindex> et la longueur de <points>.

Paramètre	Renvoitype
[<startindex>] l'index de départ [<points>] le nombre de points	<valeur CC>
Renvoie le courant CC mesuré : FETC:CURR?	

FETCh[:SCALar]:CURRent:ACDC?

FETCh[:SCALar]:VOLTage:ACDC?

Renvoie la mesure de valeur efficace vraie (CA + CC). Les valeurs renvoyées sont exprimées en ampères ou en volts.

Paramètre	Renvoitype
(aucun)	<valeur CACC>
Renvoie la tension efficace mesurée : FETC:VOLT:ACDC?	

FETCh[:SCALar]:CURRent:HIGH?

FETCh[:SCALar]:VOLTage:HIGH?

Renvoie le niveau élevé d'un signal d'impulsion. Les valeurs renvoyées sont exprimées en ampères ou en volts. Voir **Types de mesure**.

Paramètre	Renvoitype
(aucun)	<valeur HIGH>
Renvoie le courant de haut niveau mesuré : FETC:CURR:HIGH?	

FETCh[:SCALar]:CURRent:LOW?
FETCh[:SCALar]:VOLTage:LOW?

Renvoie le niveau faible d'un signal d'impulsion. Les valeurs renvoyées sont exprimées en ampères ou en volts. Voir **Types de mesure**.

Paramètre	Renvoi type
(aucun)	<valeur LOW>
Renvoie la tension de niveau faible mesurée : FETC:VOLT:LOW?	

FETCh[:SCALar]:CURRent:MAXimum?
FETCh[:SCALar]:VOLTage:MAXimum?
FETCh[:SCALar]:POWer:MAXimum]?
FETCh[:SCALar]:CURRent:MINimum?
FETCh[:SCALar]:VOLTage:MINimum?
FETCh[:SCALar]:POWer:MINimum]?

Renvoie la valeur maximale ou minimale. Les valeurs renvoyées sont exprimées en volts ou en watts.

Paramètre	Renvoi type
(aucun)	<valeur MIN> <valeur MAX>
Renvoie le courant maximal mesuré : FETC:CURR:MAX?	
Renvoie la tension minimale mesurée : FETC:VOLT:MIN?	
Renvoie la puissance maximale mesurée : FETC:POW:MAX?	

FETCh:AHOuR? [IGNORE_OVLD]
FETCh:WHOUr? [IGNORE_OVLD]

FETCh:AHOuR? - Renvoie les ampères-heures cumulés.

FETCh:WHOUr? - Renvoie les watts-heures cumulés.

Pour plus d'informations, reportez-vous à la section **Mesures en ampères-heures et en watts-heures**.

Si un échantillon de mesure est supérieur à la plage, la requête renvoie le message « SCPI Not a Number (9.91E37) » (SCPI - N'est pas un nombre (9,91E37)). Si le paramètre facultatif IGNORE_OVLD est envoyé, la mesure cumulée est renvoyée, même si certains échantillons étaient hors de la plage de mesure.

Paramètre	Renvoi type
IGNORE_OVLD ignore les mesures de surcharge	<amp-heures> <watts-heures>
Renvoie la mesure en ampères-heures : FETC:AHO?	
Renvoie la mesure en watts-heures : FETC:WHO?	

FETCh:ARRay:CURRent[:DC]? [<start_index>, <points>]

FETCh:ARRay:VOLTage[:DC]? [<start_index>, <points>]

FETCh:ARRay:POWer[:DC]?

Renvoie la mesure instantanée. Les valeurs renvoyées sont exprimées en volts ou en watts.

Les paramètres facultatifs indiquent un sous-ensemble commençant à <startindex> et la longueur de <points>.

Le format de retour varie selon les paramètres des commandes FORMat:BORDER et FORMat[:DATA]. Si le format de données est défini sur ASCII, les valeurs renvoyées sont séparées par des virgules. Si le format de données est défini sur REAL, les données sont renvoyées sous forme de valeurs à virgule flottante simple précision au format de réponse de bloc arbitraire de taille définie.

Paramètre	Renvoitype
[<startindex>] l'index de départ	<valeur> [, <valeur>]
[<points>] le nombre de points	ou <Bloc>

Renvoie le tableau du courant mesuré : **FETC:ARR:CURR?**

FETCh:ELOG? <nbre max d'enregistrements>

Renvoie les enregistrements de données externes les plus récents. Les données doivent être lues régulièrement à partir de la mémoire tampon pour éviter toute saturation de la mémoire tampon. Chaque fois que les données sont lues à l'aide de la commande FETCh:ELOG?, cet espace tampon est mis à la disposition de l'instrument pour stocker une plus grande quantité de données acquises.

Nbre max d'enregistrements correspond au nombre maximal d'enregistrements de données d'enregistrement renvoyés par le contrôleur.

Le format de retour varie selon les paramètres des commandes FORMat:BORDER et FORMat[:DATA]. Si le format de données est défini sur ASCII, les valeurs renvoyées sont séparées par des virgules. Si le format de données est défini sur REAL, les données sont renvoyées sous forme de valeurs à virgule flottante simple précision au format de réponse de bloc arbitraire de taille définie.

Paramètre	Renvoitype
[<nbre max d'enregistrements>] nombre d'enregistrements renvoyés (1 à 16 384)	<valeur> [, <valeur>] ou <Bloc>

Renvoie 100 enregistrements de données **FETC:ELOG? 100**

Sous-système FORMat

Les commandes FORMat permettent de spécifier le format de transfert des données de mesure.

FORMat[:DATA] ASCII|REAL FORMat[:DATA]?

Indique le format des données renvoyées. Ces commandes sont utilisées par des requêtes capables de renvoyer un bloc de données. **ASCII** renvoie des données sous forme d'octets ASCII dans un format numérique, le cas échéant. Les nombres sont séparés par des virgules. **REAL** renvoie les données dans un bloc de longueur définie sous forme de valeurs à virgule flottante simple précision IEEE. Dans ce cas, les 4 octets de chaque valeur peuvent être renvoyés avec un ordre d'octets de poids fort (Big Endian) ou de poids faible (Little Endian), déterminé par le paramètre FORMat:BORDER.

Paramètre	Renvoi type
ASCII REAL, *RST ASCII	ASCII ou REAL
Définit le format de données sur ASCII : FORMat ASCII	

- Le format de données est utilisé par un petit sous-ensemble de requêtes pouvant renvoyer des quantités importantes de données.

FORMat:BORDER NORMal|SWAPped FORMat:BORDER?

Indique comment les données binaires sont transférées. Cette commande ne s'applique que si FORMat:DATA est défini sur REAL. **NORMal** transfère les données dans un ordre normal. L'octet le plus significatif est renvoyé en premier, et l'octet le moins significatif en dernier (gros-boutiste). **SWAPped** transfère les données dans un ordre d'octets inversés. L'octet le moins significatif est renvoyé en premier, et l'octet le plus significatif en dernier (petit-boutiste).

Paramètre	Renvoi type
NORMal SWAPped, *RST NORMal	NORM ou SWAP
Définit le transfert de données sur Swapped (Inversé) : FORM:BORDER SWAP	

- L'ordre des octets est utilisé lors de la récupération des données réelles à partir des mesures SCPI.

Commande FUNCTION

[SOURce:]FUNCTION CURRent|VOLTage
[SOURce:]FUNCTION?

Définit la régulation de sortie : priorité de tension ou priorité de courant. En mode de priorité de tension, la sortie est contrôlée par une boucle de rétroaction à tension constante, qui maintient la tension de sortie à sa valeur programmée. En mode de priorité de courant, la sortie est contrôlée par une boucle de rétroaction à courant constant, qui maintient le courant de sortie à sa valeur programmée positive ou négative.

Pour plus d'informations, reportez-vous à la section [Didacticiel du mode de priorité](#).

Paramètre	Renvoi type
CURRent VOLTage, *RST VOLTage	CURR ou VOLT
Définit la régulation de sortie en mode de priorité de courant: <code>FUNC CURR</code>	

Sous-système HCOPy

Les commandes HCOPy permettent de renvoyer une image de l'écran.

HCOPy:SDUMp:DATA? [BMP|GIF|PNG]

Renvoie une image de l'écran du panneau avant. Le format peut être spécifié par le paramètre facultatif. Si aucun format n'est spécifié, le format est déterminé par la commande HCOPy:SDUMp:DATA:FORMat.

La réponse est un bloc binaire de taille définie SCPI 488.2 au format suivant : #<chiffre différent de zéro><chiffres><octets de données 8 bits>, où :

<chiffre différent de zéro> indique le nombre de chiffres à suivre,
<chiffres> indiquent le nombre d'octets de données 8 bits à suivre et
<octets de données 8 bits> contient les données à transférer.

Paramètre	Renvoitype
[BMP GIF PNG]	<Bloc>

Renvoie l'image au format GIF : HCOP:SDUM:DATA? GIF

HCOPy:SDUMp:DATA:FORMat BMP|GIF|PNG

HCOPy:SDUMp:DATA:FORMat?

Spécifie le format des images du panneau avant renvoyées.

Paramètre	Renvoitype
BMP GIF PNG, *RST PNG	BMP, GIF ou PNG

Indique le format d'image GIF : HCOP:SDUM:DATA:FORM GIF

Commandes courantes IEEE-488

Les commandes courantes IEEE-488 contrôlent généralement les fonctions globales de l'instrument, telles que la réinitialisation, l'état et la synchronisation. Toutes les commandes courantes comprennent un code mnémonique composé de trois lettres et précédé d'un astérisque : *RST *IDN? *SRE 8.

*CLS

Commande d'effacement de l'état. Commande d'effacement de l'état. Efface les **registres d'événements** de tous les groupes de registres. Efface également l'octet d'état et la file d'attente d'erreurs. Si la commande *CLS suit immédiatement un caractère de fin de message de programme (<NL>), la file de sortie et le bit MAV sont également effacés. Pour plus d'informations, reportez-vous à la section **Didacticiel d'état**.

Paramètre	Renvoi type
(aucun)	(aucun)
Effacer les registres d'événements, l'octet d'état et la file d'attente d'erreurs : *CLS	

*ESE <valeur>

*ESE?

Commande et requête d'activation de l'état des événements. Définit la valeur du **registre d'activation** pour le groupe **État des événements standard**. Chaque bit activé du registre active un événement correspondant. Tous les événements activés sont conditionnés par l'opérateur OR (OU) de façon logique dans le bit ESB de l'octet d'état. La requête lit le registre d'activation. Pour plus d'informations, reportez-vous à la section **Didacticiel d'état**.

Paramètre	Renvoi type
Valeur décimale correspondant à la somme binaire pondérée des bits du registre.	<valeur de bit>
Activer les bits 3 et 4 dans le registre d'activation : *ESE 24	

- La valeur renvoyée correspond à la somme binaire pondérée de tous les bits activés du registre. Par exemple, lorsque le bit 2 (valeur 4) et le bit 4 (valeur 16) sont définis, la requête renvoie +20.
- Une ou toutes les conditions peuvent être reportées dans le bit ESB au moyen du registre d'activation. Pour activer le masque du registre d'activation, écrivez une valeur décimale dans le registre avec la commande *ESE.
- La commande *CLS n'efface que le **registre des événements**, pas le registre d'activation.

*ESR?

Requête d'événement de l'état des événements. Lit et efface le **registre des événements** du groupe **État des événements standard**. Le registre des événements est un registre en lecture seule qui

verrouille tous les événements standard. Pour plus d'informations, reportez-vous à la section **Didacticiel d'état**.

Paramètre	Renvoi type
(aucun)	<valeur de bit>

Lire le registre d'activation de l'état des événements : ***ESR?**

- La valeur renvoyée correspond à la somme binaire pondérée de tous les bits activés du registre.
- Une ou toutes les conditions peuvent être reportées dans le bit ESB au moyen du registre d'activation. Pour activer le masque du registre d'activation, écrivez une valeur décimale dans le registre avec la commande *ESE.
- Lorsqu'un bit est activé, il ne change pas jusqu'à son effacement par cette requête ou la commande *CLS.

*IDN?

Requête d'identification. Renvoie la chaîne d'identification de l'instrument, qui contient quatre champs séparés par des virgules. Le premier champ est le nom du fabricant, le deuxième champ est le numéro de modèle de l'instrument, le troisième champ est le numéro de série et le quatrième champ est la version du microprogramme.

Paramètre	Renvoi type
(aucun)	Keysight Technologies,RP7951A,MY12345678,A.01.01

Renvoyer la chaîne d'identification de l'instrument : ***IDN?**

*OPC

Active le bit OPC (opération terminée) dans le registre des événements standard. Cela se produit à la fin de l'opération en attente. Pour plus d'informations, reportez-vous à la section **Didacticiel d'état**.

Paramètre	Renvoi type
(aucun)	(aucun)

Régler le bit d'opération terminée : ***OPC**

- Cette commande vise à synchroniser votre application avec l'appareil.
- Utilisée en combinaison avec les acquisitions initialisées, les transitoires, les modifications de l'état de sortie et le temps de stabilisation de la sortie pour fournir un moyen d'interroger ou d'interrompre l'ordinateur une fois ces opérations en attente terminées.
- Les autres commandes peuvent être exécutées avant que le bit d'opération terminée ne soit positionné.
- La différence entre les commandes *OPC et *OPC? est que *OPC? renvoie « 1 » dans la mémoire tampon de sortie lorsque l'opération est terminée.

***OPC?**

Renvoie la valeur 1 dans le tampon de sortie une fois toutes les opérations en attente terminées. La réponse est différée jusqu'à ce que toutes les opérations en attente soient terminées.

Paramètre	Renvoi type
(aucun)	1
Renvoyer la valeur 1 une fois les commandes terminées : *OPC?	

- Cette commande vise à synchroniser votre application avec l'appareil.
- Les autres commandes ne peuvent être exécutées tant que cette commande n'est pas terminée.

***OPT?**

Renvoie une chaîne identifiant toutes les options installées. La valeur 0 (zéro) indique qu'aucune option n'est installée.

Paramètre	Renvoi type
(aucun)	OPT 760
Renvoie les options installées : *OPT?	

***RCL <0-9>**

Rappelle un état d'instrument enregistré. Cette commande permet de réinitialiser l'instrument à un état qui a été précédemment enregistré aux emplacements 0 à 9 à l'aide de la commande *SAV. Tous les états de l'instrument sont rappelés à l'exception des états suivants : (1) l'état de la sortie est réglé sur OFF (DÉSACTIVÉ), (2) les systèmes de déclenchement sont définis à l'état Idle (Inactif), (3) l'étalonnage est désactivé, (4) toutes les listes sont définies à leurs valeurs *RST et (5) les réglages non volatiles ne sont pas affectés.

Paramètre	Renvoi type
0 - 9	(aucun)
Rappeler l'état à partir de l'emplacement 1 : *RCL 1	

- L'emplacement 0 est automatiquement rappelé à la mise sous tension lorsque l'état d'activation de la sortie est défini sur RCL 0.
- Les états de l'instrument enregistrés ne sont pas affectés par la commande *RST.

***RST**

Rétablit les valeurs prédéfinies de l'instrument qui sont des valeurs types ou sûres. Ces réglages sont décrits dans la section **État de réinitialisation**.

Paramètre	Renvoi type
(aucun)	(aucun)
Réinitialiser l'instrument : *RST	

- *RST force l'exécution des commandes ABORt. Toute action de mesure ou de transitoire actuellement en cours est alors annulée. Elle réinitialise les bits WTG-mes, MES-active, WTG-tran et TRAN-actif dans les registres d'état de fonctionnement.

*SAV <0-9>

Enregistre l'état de l'instrument à l'un des dix emplacements de mémoire non volatile. Pour des raisons de sécurité, lorsqu'un état enregistré est rappelé, l'état de sortie sera réglé sur OFF (DÉSACTIVÉ).

Paramètre	Renvoi type
0 - 9	(aucun)
Enregistrer l'état à l'emplacement 1 : *SAV 1	

- Si un état particulier est souhaité lors de la mise sous tension, il doit être stocké à l'emplacement 0. L'emplacement 0 est automatiquement rappelé à la mise sous tension lorsque l'état d'activation de la sortie est défini sur RCL 0.
- L'état de sortie, les données de liste et l'état d'étalonnage ne sont PAS enregistrés dans le cadre de l'opération *SAV.
- Les données enregistrées dans la mémoire non volatile, décrites dans la section **Réglages non volatiles**, ne sont pas affectées par la commande *SAV.
- Par défaut, les emplacements 0 à 9 sont vides.

*SRE <valeur>

*SRE?

Commande et requête d'activation des demandes de service. Cette commande permet de définir la valeur du registre d'activation de demande de service. Elle détermine les bits du **registre de l'octet d'état** qui sont récapitulés pour activer le bit récapitulatif MMS (Master Status Summary, récapitulatif d'état général) et RQS (Request for Service, demande de service). La position 1 dans un bit du registre d'activation de demande de service permet d'activer le bit de registre d'octet d'état correspondant. Tous les bits activés sont ensuite conditionnés par l'opérateur OR de façon logique pour provoquer l'activation du bit MSS du registre de l'octet d'état. Pour plus d'informations, reportez-vous à la section **Didacticiel d'état**.

Paramètre	Renvoi type
Valeur décimale correspondant à la somme binaire pondérée des bits du registre.	<valeur de bit>
Activer les bits 3 et 4 dans le registre d'activation : *SRE 24	

- Si une interrogation série est effectuée en réponse à SRQ, le bit RQS est effacé, mais le bit MSS est conservé. Si la commande *SRE est effacée (en la programmant avec la valeur 0), l'alimentation ne peut pas générer de SQR.

*STB?

Requête de l'octet d'état. Lit le **registre de l'octet d'état**, qui contient les bits récapitulatifs d'état et le bit MAV de la file de sortie. L'octet d'état est un registre en lecture seule et les bits ne sont pas effacés lorsqu'ils sont lus. Pour plus d'informations, reportez-vous à la section **Didacticiel d'état**.

Paramètre	Renvoi type
(aucun)	<valeur de bit>
Lire l'octet d'état : *STB?	

*TRG

Commande de déclenchement. Génère un événement de déclenchement lorsque le sous-système de déclenchement a sélectionné la source BUS. La commande produit le même résultat que la commande <GET> (Group Execute Trigger) de déclenchement d'exécution de groupe.

Paramètre	Renvoi type
(aucun)	(aucun)
Génère un déclenchement immédiat : *TRG	

*TST?

Requête d'autotest. Effectue un autotest de l'instrument. Si l'autotest échoue, un ou plusieurs messages d'erreur fournissent des informations complémentaires. Utilisez SYSTem:ERRor? pour lire la file d'erreurs. Pour plus d'informations, reportez-vous à la section **Messages d'erreur SCPI**.

Paramètre	Renvoi type
(aucun)	0 (réussi) ou +1 (échoué)
Effectuer un autotest : *TST?	

- L'autotest de mise sous tension est le même autotest exécuté par la commande *TST.
- *TST? force également l'exécution d'une commande *RST.

*WAI

Interrompt momentanément le traitement des commandes supplémentaires jusqu'à ce que toutes les opérations en attente soient terminées. Pour plus d'informations, voir **OPC**.

5 Aide-mémoire de la programmation SCPI

Paramètre	Renvoitype
(aucun)	(aucun)
Patienter jusqu'à la fin de toutes les opérations en attente. *WAI	

- La commande *WAI ne peut être annulée qu'en envoyant une commande Device Clear à l'instrument.

Sous-système INITiate

Les commandes Initiate permettent d'initialiser le système de déclenchement. Elles font basculer le système de déclenchement de l'état « idle » à l'état « wait-for-trigger », permettant ainsi à l'instrument de recevoir des signaux de déclenchement. Un événement sur la source de déclenchement sélectionnée provoque un déclenchement.

INITiate[:IMMEDIATE]:ACQUIRE

INITiate[:IMMEDIATE]:ELOG

INITiate[:IMMEDIATE]:TRANSIENT

INITiate:ACQUIRE - Démarre le système de déclenchement de mesure.

INITiate:ELOG - Démarre l'enregistrement de données externe.

INITiate:TRANSIENT - Démarre le système de déclenchement de transitoire.

Paramètre	Renvoi type
(aucun)	(aucun)
Démarrer le système de déclenchement de mesure : <code>INIT:ACQ</code>	

- Il suffit de quelques secondes à l'instrument pour se préparer à recevoir un signal de déclenchement après avoir reçu la commande INITiate.
- Si un déclenchement se produit avant que le système de déclenchement soit prêt, le déclenchement est ignoré. Vérifiez l'octet WTG_mes dans le registre d'état de fonctionnement pour savoir quand l'instrument est prêt.
- Les commandes ABORT permettent de renvoyer l'instrument à l'état inactif.

INITiate:CONTInuous:TRANSient 0|OFF|1|ON

INITiate:CONTInuous:TRANSient?

Démarré continuellement le système de déclenchement de transitoire. Cette commande permet à plusieurs déclenchements de générer plusieurs transitoires de sortie.

Paramètre	Renvoi type
0 OFF 1 ON, *RST ON	0 ou 1
Démarré continuellement le système de déclenchement de sortie : <code>INIT:CONT:TRAN ON</code>	

- Lorsque la fonction de démarrage continu est désactivée, le système de déclenchement de sortie doit être démarré pour chaque déclenchement à l'aide de la commande INITiate:TRANSient.
- ABORT:TRANSient ne désactive pas les déclenchements continus si la commande INITiate:CONTInuous:TRANSient ON a été programmée. Dans ce cas, le système de déclenchement est automatiquement réinitialisé.

Sous-système INSTRument

Les commandes de l'instrument programment la fonction principale/secondaire de l'instrument. Le fonctionnement en mode principal/secondaire est utilisé lors de la connexion d'un certain nombre d'instruments en parallèle pour créer un système avec un courant total plus élevé et, par conséquent, une puissance supérieure.

REMARQUE Dans ce document, les termes « maître » et « esclave » ont été remplacés par les termes « principal » et « secondaire ». La syntaxe de commande du sous-système INSTRument de la version précédente du microprogramme est toujours prise en charge dans cette version et dans les versions ultérieures.

INSTRument:GROup:FUNCTion PRIMary|SECondary|NONE INSTRument:GROup:FUNCTion?

Définissez la fonction d'un instrument dans une configuration principale/secondaire. Ce réglage est enregistré dans la mémoire non volatile.

PRIMary : configure l'instrument comme appareil principal dans un groupe principal/secondaire.

SECondary : configure l'instrument comme appareil secondaire dans un groupe principal/secondaire.

NONE : désactive la fonction principale/secondaire. L'appareil fonctionne de manière indépendante.

Paramètre	Renvoi type
PRIMary SECondary NONE	PRIM, SEC ou NONE
Configure l'instrument en tant que principal INST:GRO:FUNC:PRIM	

INSTRument:GROup:PRIMary:CONNect[:STATe] [,0|OFF|1|ON]

Indique à l'appareil principal de se connecter à tous les appareils secondaires précédemment découverts. Si la configuration du secondaire sur le bus correspond à celle qui est découverte, le principal démarrera en fonctionnement normal. Sinon, la commande échouera avec une erreur, et tous les appareils fonctionneront de manière indépendante.

Paramètre	Renvoi type
0 OFF 1 ON en option	0 ou 1
Connectez le principal aux appareils secondaires INST:GRO:PRIM:CONN	

INSTRument:GROup:PRIMary:CONNect:DELay <valeur>|MIN|MAX INSTRument:GROup:PRIMary:CONNect:DELay? [{MIN|MAX}]

Réglez le délai après la mise sous tension avant que les appareils principaux ne tentent de se connecter aux appareils secondaires. Cette opération ne s'applique que si le mode de connexion est réglé sur AUTO. Ce réglage est enregistré dans la mémoire volatile.

Paramètre	Renvoi type
0 à 120 secondes	0
Configure le délai de connexion pendant 10 secondes <code>INST:GRO:PRIM:CONN:DEL 10</code>	

INSTrument:GROup:PRIMary:CONNect:MODE AUTO|MANual INSTrument:GROup:PRIMary:CONNect:MODE?

Spécifie le mode de connexion de l'appareil principal. Ce réglage est enregistré dans la mémoire non volatile.

AUTO : l'appareil principal essaie de se connecter aux appareils précédemment découverts lors de la mise sous tension.

MANual : le principal se connecte aux esclaves précédemment découverts quand il reçoit une commande de connexion du panneau avant ou de `INST:GROUP:PRIM:CONN`.

Paramètre	Renvoi type
AUTO MANual	AUTO ou MAN
Spécifie le mode de connexion automatique <code>INST:GRO:PRIM:CONN:MODE AUTO</code>	

INSTrument:GROup:PRIMary:DISCover

Indique à l'appareil principal de découvrir tous les appareils secondaires connectés au bus principal/secondaire.

Paramètre	Renvoi type
(aucun)	(aucun)
Découvrez tous les appareils secondaires <code>INST:GRO:PRIM:DISC</code>	

INSTrument:GROup:PRIMary:RESet

Réinitialise la configuration du secondaire découvert par le principal. Cela déconnecte les appareils connectés par le secondaire et les remet en fonctionnement indépendant.

Paramètre	Renvoi type
(aucun)	(aucun)
Réinitialise tous les appareils secondaires <code>INST:GRO:PRIM:RES</code>	

INSTrument:GROup:SECondary:ADDRess <valeur>

Définit l'adresse du bus de l'appareil secondaire. Chaque appareil secondaire un groupe principal/secondaire doit avoir une adresse de bus unique ou la communication du bus échoue. Ce réglage est enregistré dans la mémoire non volatile.

5 Aide-mémoire de la programmation SCPI

Paramètre	Renvoitype
1 - 19	1
Définit l'adresse de l'appareil secondaire sur 1 INST:GRO:SEC:ADDR 1	

Sous-système LIST

Les commandes List permettent de programmer une séquence de plusieurs réglages de tension ou de courant en sortie. Vous pouvez programmer une liste délimitée par des virgules et contenant jusqu'à 512 paliers. Notez que ces commandes s'appliquent uniquement au mode de priorité actuellement actif, priorité de tension ou priorité de courant.

[SOURCE:]LIST:COUNT <valeur>|MIN|MAX|INFinity
[SOURCE:]LIST:COUNT? [{MIN|MAX}]

Définit le nombre de répétitions de la liste. Cette commande permet de définir le nombre de fois qu'une liste est exécutée avant de se terminer. La plage de nombres est comprise entre 1 et 4096. Infinity exécute la liste en permanence.

Paramètre	Renvoi type
1 - 4096, *RST 1	<nombre>
Définit le comptage de liste à 10 : LIST:COUN 10	

[SOURCE:]LIST:CURRENT[:LEVEL] <valeur>{,<valeur>}
[SOURCE:]LIST:CURRENT[:LEVEL]?
[SOURCE:]LIST:VOLTage[:LEVEL] <valeur>{,<valeur>}
[SOURCE:]LIST:VOLTage[:LEVEL]?

Indique le réglage de chaque palier de liste. Les valeurs sont exprimées en ampères ou en volts.

Paramètre	Renvoi type
Tension : 0 à 102 % de la valeur nominale	<valeur de liste 1>,<valeur de liste
Courant : -102 à 102 % de la valeur nominale	2>,<valeur de liste 3>
Programme une liste de courant. Cette liste contient 3 paliers : LIST:CURR 3,2,1	
Programme une liste de tension. Cette liste contient 3 paliers : LIST:VOLT 20,10,5	

[SOURCE:]LIST:DWELL <valeur>{,<valeur>}
[SOURCE:]LIST:DWELL?

Indique la durée de chaque palier de liste. La durée de palier correspond à la durée pendant laquelle la sortie demeure sur un palier spécifique. Les durées de palier peuvent être programmées entre 0 et 262,144 secondes avec la résolution suivante :

Plage en secondes	Résolution
0 - 0,262144	1 microseconde
0,262144 - 2,62144	10 microsecondes
2,62144 - 26,2144	100 microsecondes

5 Aide-mémoire de la programmation SCPI

Plage en secondes	Résolution
26,2144 - 262,144	1 milliseconde

Paramètre	Renvoi type
0 à 262.144, *RST 1 ms	<valeur de liste 1>, <valeur de liste 2>, <valeur de liste 3>

Programme une liste de paliers. Cette liste contient 3 paliers : `LIST:DWEL 0.2,0.8,1.6`

[SOURCE:]LIST:CURRENT:POINTS?
[SOURCE:]LIST:DWEL:POINTS?
[SOURCE:]LIST:VOLTAGE:POINTS?
[SOURCE:]LIST:TOUTput:BOSTep:POINTS?
[SOURCE:]LIST:TOUTput:EOSTep:POINTS?

Renvoie le nombre de points de liste. Les points sont identiques à des paliers. Les requêtes ne renvoient pas les valeurs de point.

Paramètre	Renvoi type
(aucun)	<points>

Renvoie le nombre de points dans la liste de paliers : `LIST:DWEL:POIN?`

[SOURCE:]LIST:STEP ONCE|AUTO
[SOURCE:]LIST:STEP?

Indique comment la liste répond aux déclenchements. **ONCE** permet de maintenir la sortie sur le palier actuel jusqu'à ce qu'un événement de déclenchement passe au palier suivant. Les déclenchements qui surviennent pendant la durée de palier sont ignorés. **AUTO** permet de faire passer automatiquement la sortie à chaque palier, une fois l'événement de déclenchement de démarrage initial reçu. Les paliers sont cadencés par la liste de paliers. À l'expiration de chaque durée de palier, le palier suivant est immédiatement généré.

Paramètre	Renvoi type
ONCE AUTO, *RST AUTO	ONCE ou AUTO

Indique que les paliers de liste doivent être cadencés par des signaux de déclenchement : `LIST:STEP ONCE`

[SOURCE:]LIST:TERMinate:LAST 0|OFF|1|ON
[SOURCE:]LIST:TERMinate:LAST?

Détermine la valeur de sortie lorsque la liste s'arrête. Si cette commande est activée (1), la tension ou le courant de sortie est maintenu sur le dernier palier de liste. La valeur du dernier palier de liste de tension ou de courant devient la valeur IMMEDIATE une fois la liste terminée. Si elle est désactivée (0)

ou que la liste est interrompue, les réglages de la sortie qui étaient appliqués avant le démarrage de la liste sortie sont rétablis.

Paramètre	Renvoi type
0 OFF 1 ON, *RST OFF	0 ou 1
Interrompre avec la sortie sur la dernière valeur de palier : LIST:TERM:LAST ON	

[SOURce:]LIST:TOUTput:BOSTep[:DATA] 0|OFF|1|ON {,0|OFF|1|ON}

[SOURce:]LIST:TOUTput:BOSTep[:DATA]?

[SOURce:]LIST:TOUTput:EOSTep[:DATA] 0|OFF|1|ON {,0|OFF|1|ON}

[SOURce:]LIST:TOUTput:EOSTep[:DATA]?

Spécifie les paliers de liste qui génèrent un signal de déclenchement au début du palier (BOSTep) ou à la fin du palier (EOSTep). Un événement de déclenchement n'est généré que si l'état est défini sur ON. Le signal de déclenchement peut être utilisé comme source de déclenchement pour les mesures et les transitoires d'autres appareils et pour les broches de port numérique configurées comme sorties de déclenchement.

Paramètre	Renvoi type
0 OFF 1 ON	0 ou 1
Générer des événements de déclenchement au début du deuxième palier d'une liste à 3 paliers :	
LIST:TOUT:BOST OFF,ON,OFF	

Sous-système LXI**LXI:IDENTify[:STATe] 0|OFF|1|ON****LXI:IDENTify[:STATe]?**

Allume ou éteint le voyant d'identification LXI du panneau avant. Lorsque cette commande est activée, le voyant d'état "LAN" situé sur le panneau avant clignote pour identifier l'instrument en cours de traitement.

Paramètre	Renvoitype
0 OFF 1 ON, *RST OFF	0 ou 1
Pour faire clignoter le voyant LXI du panneau avant : LXI:IDENT ON	

LXI:MDNS[:STATe] 0|OFF|1|ON**LXI:MDNS[:STATe]?**

Définit l'état activé ou désactivé MDNS.

Paramètre	Renvoitype
0 OFF 1 ON, *RST OFF	0 ou 1
Définit l'état activé MDNS : LXI:MDNS ON	

Sous-système MEASure

Les commandes Measure permettent de mesurer la tension ou le courant de sortie. Elles déclenchent l'acquisition de nouvelles données avant de renvoyer la lecture. Les mesures sont effectuées en numérisant la tension ou le courant de sortie instantané pendant une période de mesure spécifiée, en enregistrant les résultats dans une mémoire tampon et en calculant la valeur du type de mesure spécifié.

MEASure[:SCALar]:CURRent[:DC]?

MEASure[:SCALar]:POWer[:DC]?

MEASure[:SCALar]:VOLTage[:DC]?

Initialise, déclenche et renvoie la moyenne de la mesure de sortie. Les valeurs renvoyées sont exprimées en volts ou en watts.

Paramètre	Renvoi type
(aucun)	<valeur CC>
Renvoie le courant CC mesuré : MEAS:CURR?	

MEASure[:SCALar]:CURRent:ACDC?

MEASure[:SCALar]:VOLTage:ACDC?

Initialise, déclenche et renvoie la mesure de valeur efficace vraie totale (CA + CC). Les valeurs renvoyées sont exprimées en ampères ou en volts.

Paramètre	Renvoi type
(aucun)	<valeur CACC>
Renvoie la tension efficace mesurée : MEAS:VOLT:ACDC?	

MEASure[:SCALar]:CURRent:HIGH?

MEASure[:SCALar]:VOLTage:HIGH?

Initialise, déclenche et renvoie le niveau High (Élevé) d'un signal d'impulsion. Les valeurs renvoyées sont exprimées en ampères ou en volts. Voir [Types de mesure](#).

Paramètre	Renvoi type
(aucun)	<valeur HIGH>
Renvoie le courant de niveau élevé mesuré : MEAS:CURR:HIGH?	

MEASure[:SCALar]:CURRent:LOW?
MEASure[:SCALar]:VOLTage:LOW?

Initialise, déclenche et renvoie le niveau Low (Faible) d'un signal d'impulsion. Les valeurs renvoyées sont exprimées en ampères ou en volts. Voir **Types de mesure**.

Paramètre	Renvoi type
(aucun)	<valeur LOW>
Renvoie la tension de niveau faible mesurée : MEAS:VOLT:LOW?	

MEASure[:SCALar]:CURRent:MAXimum?
MEASure[:SCALar]:VOLTage:MAXimum?
MEASure[:SCALar]:POWer:MAXimum?
MEASure[:SCALar]:CURRent:MINimum?
MEASure[:SCALar]:VOLTage:MINimum?
MEASure[:SCALar]:POWer:MINimum?

Initialise, déclenche et renvoie les valeurs maximale ou minimale d'une mesure. Les valeurs renvoyées sont exprimées en volts ou en watts.

Paramètre	Renvoi type
(aucun)	<valeur MIN>, <valeur MAX>
Renvoie le courant maximal mesuré : MEAS:CURR:MAX?	
Renvoie la tension minimale mesurée : MEAS:VOLT:MIN?	
Renvoie la puissance maximale mesurée : MEAS:POW:MAX?	

MEASure:ARRay:CURRent[:DC]?
MEASure:ARRay:VOLTage[:DC]?
MEASure:ARRay:POWer[:DC]?

Initialise et déclenche une mesure ; renvoie une liste des échantillons de mesure de sortie numérisés. Les valeurs renvoyées sont exprimées en volts ou en watts.

Le format de retour varie selon les paramètres des commandes FORMat:BORDER et FORMat[:DATA]. Si le format de données est défini sur ASCII, les valeurs renvoyées sont séparées par des virgules. Si le format de données est défini sur REAL, les données sont renvoyées sous forme de valeurs à virgule flottante simple précision au format de réponse de bloc arbitraire de taille définie.

Paramètre	Renvoi type
(aucun)	<valeur> [, <valeur>] ou <Bloc>
Renvoie le tableau de courant mesuré : MEAS:ARR:CURR?	

Sous-système OUTPut

Le sous-système Output contrôle l'état, la mise sous tension, la protection et les fonctions de relais des sorties.

OUTPut [:STATe] 0|OFF|1|ON OUTPut[STATe]?

Active ou désactive la sortie. L'état d'une sortie désactivée est une condition de tension de sortie et de courant source zéro. Si un appareil SDS Keysight SD1000A est connecté, les relais du SDS s'ouvrent à la désactivation de la sortie et se ferment à son activation.

Paramètre	Renvoi type
0 OFF 1 ON, *RST OFF	0 ou 1
Désactive la sortie : <code>OUTP OFF</code>	

- Lorsque la sortie est activée, le voyant d'état du panneau avant quitte l'état **OFF** pour indiquer l'état de fonctionnement de l'instrument (**CV**, **CC**, etc.).
- Des délais séparés peuvent être programmés pour la transition désactivé-activé et activé-désactivé à l'aide des commandes `OUTPut:DElay:RISE` et `OUTPut:DElay:FALL`.
- En raison des procédures de démarrage de circuit internes, la commande `OUTPut ON` peut mettre 12 millisecondes à s'exécuter en mode de priorité de tension, et 14 millisecondes en mode de priorité de courant. Si un appareil SDS Keysight SD1000A est connecté, le démarrage sera plus long (voir [Délais d'activation/désactivation](#)).

OUTPut[:STATe]:COUPle[:STATe] 0|OFF|1|ON OUTPut[:STATe]:COUPle[:STATe]?

Active ou désactive la fonction de couplage des sorties. La fonction de couplage des sorties permet d'activer et de désactiver de façon séquentielle les sorties de plusieurs instruments sur leurs relais de programmation `OUTPut:DElay:RISE` et `OUTPut:DElay:FALL` spécifiés. Ces paramètres sont enregistrés dans la mémoire non volatile.

Paramètre	Renvoi type
0 OFF 1 ON	0 ou 1
Active l'état de couplage des sorties : <code>OUTP:COUP ON</code>	

- Vous devez connecter et configurer les broches du connecteur numérique `ONCouple` et `OFFCouple` de tous les instruments synchronisés comme décrit à la section [Commande de couplage des sorties](#).

- En raison des différents décalages de délai minimum de certains modules d'alimentation, vous devez également spécifier un décalage de délai commun pour tous les appareils synchronisés. Cette valeur doit être le décalage de délai le plus important du groupe synchronisé. Utilisez la commande `OUTPut:COUPle:MAX:DOFFset?` pour obtenir le décalage de délai de chaque appareil. La valeur la plus élevée renvoyée doit être spécifiée comme décalage de délai commun pour chaque appareil.

OUTPut[:STATe]:COUPle:DOFFset <valeur>|MIN|MAX **OUTPut[:STATe]:COUPle:DOFFset? [{MIN|MAX}]**

Définit un décalage de délai pour synchroniser les modifications de l'état de sortie couplé. Les unités sont exprimées en secondes. Le réglage de ce temps sur le décalage de délai maximum spécifié pour un instrument couplé provoque la synchronisation de toutes les sorties couplées avec les délais d'activation spécifiés par la commande `OUTPut:DElay:RISE`. Ces paramètres sont enregistrés dans la mémoire non volatile.

Paramètre	Renvoi type
0 à 1.023	<valeur de délai>
Indique un délai de 60 millisecondes : <code>OUTP:COUP:DOFF 0.06</code>	

OUTPut[:STATe]:COUPle:MAX:DOFFset?

Renvoie le décalage de délai requis pour cet instrument. La valeur de `OUTPut:COUPle:DElay:OFFSet` doit au moins être définie sur le décalage de délai maximal renvoyé pour une sortie couplée.

Paramètre	Renvoi type
(aucun)	<valeur de décalage>
Renvoie le décalage de délai maximal : <code>OUTP:COUP:MAX:DOFF?</code>	

OUTPut[:STATe]:DElay:FALL <valeur>|MIN|MAX **OUTPut[:STATe]:DElay:FALL? [{MIN|MAX}]** **OUTPut[:STATe]:DElay:RISE <valeur>|MIN|MAX** **OUTPut[:STATe]:DElay:RISE? [{MIN|MAX}]**

Indique le temps d'attente, en secondes, avant que l'instrument n'active (montée) ou ne désactive (descente) la sortie. Cela permet d'activer ou de désactiver de façon séquentielle plusieurs instruments. La sortie n'est activée ou désactivée qu'une fois son délai écoulé. Cette commande concerne les transitions d'état activé-désactivé, et NON les transitions vers l'état désactivé provoquées par les fonctions de protection. Les délais peuvent être programmés avec la résolution suivante :

Plage en secondes	Résolution	Plage en secondes	Résolution
0 à 1,023E-4	100 nanosecondes	1,03E-1 à 1,023E+0	1 milliseconde
1,03E-4 à 1,023E-3	1 microseconde	1,03E+0 à 1,023E+1	10 millisecondes

Plage en secondes	Résolution	Plage en secondes	Résolution
1,03E-3 à 1,023E-2	10 microsecondes	1,03E+1 à 1,023E+2	100 millisecondes
1,03E-2 à 1,023E-1	100 microsecondes	1,03E+2 à 1,023E+3	1 seconde

Notez que les commandes de montée et de descente utilisent la même résolution, déterminée par le délai (montée ou descente) le plus long.

Paramètre	Renvoi type
0 - 1023, *RST0	<valeur de délai>
Définit un délai de 0,5 s avant l'activation de la sortie : <code>OUTP:DEL:RISE 0.5</code>	

- Chaque modèle du système RPS présente un décalage de délai minimal qui s'applique entre le moment où la commande d'activation de la sortie est reçue et celui où elle est réellement activée. Si vous indiquez un délai d'activation, ce dernier est ajouté au décalage de délai minimal, ce qui engendre un délai d'activation plus long que celui que vous avez programmé.
- Utilisez la commande `OUTput:COUple:MAX:DOFFset?` pour obtenir le décalage de délai requis pour chaque instrument.

OUTPut[:STATe]:TMODe:COUple 0|OFF|1|ON RP793xA, RP794xA **OUTPut[:STATe]TMODe:COUple?**

Lorsque le couplage est activé, la modification du réglage d'activation change également le réglage de désactivation et vice-versa. Si les réglages d'activation et de désactivation ne sont pas les mêmes et que le couplage est activé, le réglage de désactivation sera modifié afin de correspondre au réglage d'activation.

Paramètre	Renvoi type
0 OFF 1 ON	0 ou 1
Associe les modes d'activation et de désactivation : <code>OUTP:REL:LOCK ON</code>	

OUTPut[:STATe]:TMODe[:OFF] HIGHZ | LOWZ RP793xA, RP794xA **OUTPut:TMODe:OFF?** **OUTPut[:STATe]:TMODe:ON HIGHZ | LOWZ** RP793xA, RP794xA **OUTPut:TMODe:ON?**

Ces commandes définissent le comportement d'activation et de désactivation de la sortie sur Faible impédance ou Impédance élevée.

Low Impedance (Faible impédance) : permet de programmer la tension de sortie à zéro, puis de déconnecter la sortie. L'absorption maximale de courant négatif se produit durant 250 ms lors de la transition de désactivation.

High Impedance (Impédance élevée) : permet de déconnecter la sortie sans absorption active de courant.

Paramètre	Renvoi type
HIGHZ LOWZ	HIGHZ ou LOWZ
Définit l'état d'activation sur une impédance élevée : <code>OUTP:TMOD:ON HIGHZ</code> Règle l'état de désactivation sur une faible impédance : <code>OUTP:TMOD:OFF LOWZ</code>	

- Le réglage de l'activation/désactivation ne s'applique que lorsque le RPS fonctionne en mode de priorité de tension. En mode de priorité de courant, le comportement d'activation/désactivation est toujours l'impédance.

OUTPut:INHibit:MODE LATChing|LIVE|OFF **OUTPut:INHibit:MODE?**

Définit le mode de fonctionnement de la broche numérique d'inhibition à distance. La fonction d'inhibition permet d'interrompre la sortie en réponse à un signal de déclenchement sur la broche d'entrée d'inhibition. Le mode Inhibition est enregistré dans la mémoire non volatile. Voir [Programmation du port numérique](#).

LATChing : un signal vrai logique sur l'entrée d'inhibition entraîne le déverrouillage de l'état de sortie. La sortie demeure désactivée jusqu'à ce que l'entrée d'inhibition soit renvoyée à l'état faux logique et que le bit d'état INH verrouillé soit effacé en envoyant la commande `OUTPut:PROTection:CLear` ou une commande de désactivation de la protection depuis le panneau avant.

LIVE : permet à la sortie activée de suivre l'état de l'entrée d'inhibition. Lorsque l'entrée d'inhibition est à l'état vrai, la sortie est désactivée. Lorsque l'entrée d'inhibition est à l'état faux, la sortie est réactivée.

OFF : l'entrée d'inhibition est ignorée.

Paramètre	Renvoi type
LATChing LIVE OFF	LATC, LIVE, or OFF
Définit l'entrée d'inhibition en mode Live (Actif) : <code>OUTP:INH:MODE LIVE</code>	

OUTPut:PON:STATe RST|RCL0 **OUTPut:PON:STATe?**

Définit la configuration de mise sous tension de la sortie. Cette commande détermine si l'état de mise sous tension est défini à l'état *RST (RST) ou l'état stocké à l'emplacement de mémoire 0 (RCL0). Les configurations de l'instrument peuvent être enregistrées à l'aide de la commande *SAV. Ces paramètres sont enregistrés dans la mémoire non volatile.

Paramètre	Renvoi type
RST RCL0	RST ou RCL0
Définit l'état de mise sous tension sur l'état *RST : <code>OUTP:PON:STAT RST</code>	

- Si l'état de mise sous tension est défini à zéro sans aucun état enregistré, l'erreur d'autotest "file not found; 0 state" (fichier introuvable ; 0 état) est générée et l'instrument passe à l'état *RST.
- En cas d'échec d'une commande principale **connexion automatique**, l'état de la mise sous tension est réglé sur *RST.

OUTPut:PROTection:CLEar

Réinitialise la protection verrouillée. Cette commande efface l'état de protection verrouillé qui désactive la sortie lorsqu'une condition de protection se produit (voir **Programmation de la protection des sorties**).

Paramètre	Renvoi type
(aucun)	(aucun)
Efface l'état de protection verrouillé : <code>OUTP:PROT:CLE</code>	

- Toutes les conditions qui génèrent l'erreur doivent être supprimées avant de pouvoir effacer l'état verrouillé. La sortie revient à son état précédant la condition d'erreur.
- Si un arrêt de la protection se produit pendant une liste de sortie, la liste continue de s'exécuter, même si la sortie est désactivée. Lorsque l'état de protection est effacé et la sortie réactivée, cette dernière est réglée sur les valeurs du palier auquel la liste se trouve actuellement.

OUTPut:PROTection:TEMPerature:MARGin?

Renvoie la différence minimale entre les capteurs de température interne et le niveau de déclenchement en surchauffe. La marge est indiquée en degrés Celsius.

Paramètre	Renvoi type
(aucun)	<valeur de marge>
Renvoie la marge de température : <code>OUTP:PROT:TEMP:MARG?</code>	

OUTPut:PROTection:WDOG[:STATe] 0|OFF|1|ON OUTPut:PROTection:WDOG[:STATe]?

Active ou désactive le temporisateur de surveillance des E/S. Lorsqu'elle est activée, la sortie est désactivée en l'absence d'activité d'E/S sur une interface de commande à distance durant la période spécifiée par la commande `OUTPut:PROTection:WDOG:DElay`. La sortie est déverrouillée, mais l'état de sortie programmé ne change pas.

Paramètre	Renvoi type
0 OFF 1 ON, *RST OFF	0 ou 1
Active la protection du temporisateur de surveillance : <code>OUTP:PROT:WDOG ON</code>	

OUTPut:PROTection:WDOG:DELay <valeur>|MIN|MAX
OUTPut:PROTection:WDOG:DELay? [{MIN|MAX}]

Définit le délai de surveillance. Lorsque le temporisateur de surveillance est activé, la sortie est désactivée en l'absence d'activité d'E/S sur une interface de commande à distance (USB, LAN, GPIB) durant le délai de temporisation. La fonction de temporisateur de surveillance n'est PAS réinitialisée par une activité sur le panneau avant : la sortie est interrompue une fois le délai écoulé. Les valeurs programmées peuvent être comprises entre 1 et 3 600 secondes par incréments de 1 seconde.

Paramètre	Renvoi type
0 - 3 600, *RST 60 secondes	<valeur de délai>
Définit un délai de surveillance de 600 secondes : <code>OUTP:PROT:WDOG:DEL 600</code>	

OUTPut:RELAy:LOCK[:STATe] 0|OFF|1|ON
OUTPut:RELAy:LOCK[:STATe]?

Active ou désactive l'état du relai verrouillé du système de déconnexion de sécurité Keysight SD1000A. En cas de verrouillage, les relais de sortie du SDS restent fermés et ne changent pas en même temps que l'état de sortie de l'alimentation. Cela améliore le temps de réponse en sortie des applications qui ne requièrent pas de déconnexion physique de la sortie lors de l'activation/désactivation normale. Ces paramètres sont enregistrés dans la mémoire non volatile.

Paramètre	Renvoi type
0 OFF 1 ON	0 ou 1
Verrouille les relais SDS fermés : <code>OUTP:REL:LOCK ON</code>	

Requête POWer**[SOURce:]POWer:LIMit?**

Renvoie la limite de puissance de l'instrument en watts, 5 kW, ou 10 kW.

Paramètre	Renvoitype
Aucun	5 000 ou 10 000

Renvoyer la limite de puissance : **POWer:LIMit?**

Sous-système SENSE

Les commandes Sense contrôlent les plages et la fenêtre de mesure du courant ainsi que la séquence d'acquisition des données.

SENSE:AHO:RESet SENSE:WHO:RESet

Réinitialise la mesure en ampères-heures ou en watts-heures à zéro.

Paramètre	Renvoi type
(aucun)	(aucun)
Réinitialise la mesure en ampères-heures : SENS:AHO:RES	
Réinitialise la mesure en watts-heures : SENS:WHO:RES	

SENSE:ELOG:FUNCTION:CURRENT 0|OFF|1|ON SENSE:ELOG:FUNCTION:CURRENT? SENSE:ELOG:FUNCTION:VOLTage 0|OFF|1|ON SENSE:ELOG:FUNCTION:VOLTage?

Active ou désactive la fonction de mesure de courant ou de tension Elog.

Paramètre	Renvoi type
0 OFF 1 ON, *RST OFF	0 ou 1
Active les mesures de courant de l'enregistrement : SENS:ELOG:FUNC:CURR ON	

SENSE:ELOG:FUNCTION:CURRENT:MINMax 0|OFF|1|ON SENSE:ELOG:FUNCTION:CURRENT:MINMax? SENSE:ELOG:FUNCTION:VOLTage:MINMax 0|OFF|1|ON SENSE:ELOG:FUNCTION:VOLTage:MINMax?

Active ou désactive l'enregistrement des valeurs de courant ou de tension minimales et maximales.

Paramètre	Renvoi type
0 OFF 1 ON, *RST OFF	0 ou 1
Active les valeurs d'enregistrement MIN/MAX : SENS:ELOG:FUNC:VOLT:MINM ON	

SENSE:ELOG:PERiod <valeur>|MIN|MAX SENSE:ELOG:PERiod? [{MIN|MAX}]

Définit le temps d'intégration d'une mesure de données externes (Elog).

Même si la période d'enregistrement minimale absolue est de 102,4 microsecondes, la valeur minimale réelle varie en fonction du nombre de lectures qui sont actuellement enregistrées (voir **Période d'intégration**).

Paramètre	Renvoi type
0,0001024 à 60, *RST MAX	<période>
Indique une période d'enregistrement de 0,01 seconde : <code>SENS:ELOG:PER 0.01</code>	

SENSe:FUNCTion:CURRent 0|OFF|1|ON

SENSe:FUNCTion:CURRent?

SENSe:FUNCTion:VOLTage 0|OFF|1|ON

SENSe:FUNCTion:VOLTage?

Active ou désactive les mesures de courant ou de tension.

Paramètre	Renvoi type
0 OFF 1 ON, *RST ON	0 ou 1
Active les mesures de courant : <code>SENS:FUNC:CURR ON</code> Désactive les mesures de tension : <code>SENS:FUNC:VOLT OFF</code>	

SENSe:SWEep:NPLCycles <valeur>|MIN|MAX

SENSe:SWEep:NPLCycles? [{MIN|MAX}]

Définit le temps de mesure en nombre de cycles de tension d'alimentation. L'augmentation du nombre de cycles de tension d'alimentation entraîne la réduction du bruit de mesure sur les mesures de courant et de tension. La modification du NPLC entraîne celle du nombre de points et le paramètre d'intervalle. Le nombre de points de 1 NPLC varie en fonction du réglage de la fréquence réseau (voir **SYSTem:LFR:MODE**).

Paramètre	Renvoi type
0.0003072 à 1,258,290,000,000, *RST 1	<valeur NPLC>
Indique 100 cycles de tension d'alimentation : <code>SENS:SWE:NPLC 100</code>	

SENSe:SWEep:OFFSet:POINts <valeur>|MIN|MAX

SENSe:SWEep:OFFSet:POINts? [{MIN|MAX}]

Définit le décalage d'un balayage de données pour les mesures déclenchées. Les valeurs positives représentent le délai au-delà duquel le déclenchement se produit avant l'acquisition des échantillons. Les valeurs négatives représentent les échantillons de données prélevés avant le déclenchement.

Paramètre	Renvoi type
-524,287 à 2,000,000,000, *RST 0	<points de décalage>
Indique -2048 points de décalage : SENS:SWE:OFFS:POIN -2048	

SENSe:SWEep:POINTs <valeur>|MIN|MAX **SENSe:SWEep:POINTs? [{MIN|MAX}]**

Définit le nombre de points d'une mesure. Le nombre de points varie en fonction de la fréquence réseau (50 ou 60 Hz). Le nombre de points par défaut engendre une mesure de 1 NPLC.

Paramètre	Renvoi type
1 à 524,288 MIN MAX, *RST 3255 (60 Hz) ; 3906 (50 Hz)	<points>
Indique 2048 points : SENS:SWE:POIN 2048	

SENSe:SWEep:TINTerval <valeur>|MIN|MAX **SENSe:SWEep:TINTerval? [{MIN|MAX}]**

Définit la période qui s'écoule entre les échantillons de mesure. Les unités sont exprimées en secondes. Les valeurs sont arrondies à l'incrément de 20,48 microsecondes le plus proche. En dessous de 20,48 microsecondes, les valeurs sont arrondies à l'incrément de 10,24 ou de 5,12 microsecondes le plus proche, respectivement.

Paramètre	Renvoi type
0.00000512 à 40,000, *RST 0.00000512	<intervalle>
Indique un intervalle de 1 ms entre les points : SENS:SWE:TINT 0.001	

SENSe:WINDow[:TYPE] HANNing|RECTangular **SENSe:WINDow[:TYPE]?**

Sélectionne la fenêtre de mesure. Cette commande permet de configurer une fonction de conditionnement de signal utilisée dans les calculs de mesure CC scalaires. Aucune des fonctions de fenêtrage n'altère les données de tension ou de courant instantanées renvoyées dans le tableau de mesure.

La fenêtre **Hanning** est une fonction de « cosinus surélevé ». Il s'agit d'une fonction de conditionnement de signal qui réduit les erreurs dans les calculs de mesure CC en présence de signaux périodiques, tels qu'une ondulation de la tension secteur. Cette fenêtre ne traite que jusqu'à 4 883 points de mesure. L'instrument retourne à une fenêtre rectangulaire lorsque le nombre de points dépasse 4883.

La fenêtre **Rectangular (Rectangulaire)** renvoie des calculs de mesure sans aucun conditionnement de signal.

Paramètre	Renvoitype
HANNing RECTangular, *RST RECTangular	RECT ou HANN
Indique une fonction de fenêtre Hanning : SENS:WIND HANN	

Sous-système [SOURce]

Le mot-clé SOURce est facultatif dans de nombreuses commandes qui définissent des paramètres d'une source ou sortie, telles que [SOURce:]CURRent <valeur>.

Parce que les commandes du sous-système SOURce sont souvent utilisées sans le mot-clé SOURce facultatif, ces commandes sont répertoriées ci-dessous par leurs sous-systèmes :

Sous-systèmes et commandes utilisant le mot-clé [SOURce:] facultatif

ARB

CURRent

DIGital

FUNcTion

LIST

POWer:LIMit

STEP:TOUTput

VOLTage

Sous-système STATus

La programmation du registre d'état vous permet de déterminer à tout moment les conditions de fonctionnement de l'instrument. L'instrument comporte trois groupes de registres d'état : Fonctionnement, Suspect et Événement standard. Les groupes d'état Fonctionnement et Suspect sont chacun composés des registres de conditions, d'activation et d'événements, ainsi que des filtres NTR et PTR.

Le sous-système d'état est également programmé à l'aide de commandes courantes. Les commandes courantes contrôlent des fonctions d'état supplémentaires, telles que les registres d'activation de demande de service et d'octet d'état. Pour plus d'informations, reportez-vous à la section [Didacticiel d'état](#).

STATus:OPERation[:EVENT]

Effectue une requête dans le [registre des événements](#) du groupe [États de fonctionnement](#). C'est un registre en lecture seule qui enregistre (verrouille) tous les événements qui sont transmis par le filtre NTR et/ou PTR de fonctionnement. Une fois lu, le registre des événements d'état de fonctionnement est effacé.

Paramètre	Renvoitype
(aucun)	<valeur de bit>

Lire le registre des événements d'état de fonctionnement : STAT:OPER?

- La valeur renvoyée correspond à la somme binaire pondérée de tous les bits activés du registre. Par exemple, lorsque le bit 3 (valeur 8) et le bit 5 (valeur 32) sont définis et activés, la requête renvoie +40.
- La commande *RST n'a pas d'effet sur ce registre.

STATus:OPERation:CONDition?

Effectue une requête dans le [registre de conditions](#) du groupe [États de fonctionnement](#). Il s'agit d'un registre en lecture seule qui contient l'état opérationnel (non verrouillé) actif de l'instrument. La lecture du registre des événements d'état d'activation n'entraîne pas son effacement.

Paramètre	Renvoitype
(aucun)	<valeur de bit>

Lire le registre des conditions d'état de fonctionnement : STAT:OPER:COND?

- La valeur renvoyée correspond à la somme binaire pondérée de tous les bits activés du registre. Par exemple, lorsque le bit 3 (valeur 8) et le bit 5 (valeur 32) sont définis et activés, la requête renvoie +40.
- Les bits du registre de conditions reflètent l'état actuel. Si une condition n'est pas remplie, le bit correspondant est effacé.

- La commande *RST efface ce registre, sauf les bits où la condition existe toujours après la commande *RST.

STATus:OPERation:ENABLE <valeur>

STATus:OPERation:ENABLE?

Définit la valeur du **registre d'activation** du groupe **États de fonctionnement**. Le registre d'activation est un masque qui permet d'activer des bits spécifiques du registre des événements de fonctionnement pour activer le bit OPER (récapitulatif de l'exécution) du registre d'octet d'état. STATus:PRESet efface tous les bits du registre d'activation.

Paramètre	Renvoi type
Valeur décimale correspondant à la somme binaire pondérée des bits du registre.	<valeur de bit>
Activer les bits 3 et 4 dans le registre d'activation : STAT:OPER:ENAB 24	

- Par exemple, lorsque le bit 3 (valeur 8) et le bit 5 (valeur 32) sont définis et activés, la requête renvoie +40.
- La commande *CLS n'efface que le **registre des événements**, pas le registre d'activation.

STATus:OPERation:NTRansition <valeur>

STATus:OPERation:NTRansition?

STATus:OPERation:PTRansition <valeur>

STATus:OPERation:PTRansition?

Définit et recherche la valeur des registres **NTR** (Transition négative) et **PTR** (Transition positive). Ces registres servent de filtre de polarité entre les registres des conditions de fonctionnement et des événements de fonctionnement.

Lorsqu'un bit du registre NTR est défini sur 1, une transition de 1 vers 0 du bit correspondant dans le registre des conditions de fonctionnement entraîne l'activation du bit du registre des événements de fonctionnement.

Lorsqu'un bit du registre PTR est défini sur 1, une transition de 0 vers 1 du bit correspondant dans le registre des conditions de fonctionnement entraîne l'activation du bit dans le registre des événements de fonctionnement.

STATus:PRESet active tous les bits des registres PTR et efface tous les bits des registres NTR.

Paramètre	Renvoi type
Valeur décimale correspondant à la somme binaire pondérée des bits du registre.	<valeur de bit>
Activer les bits 3 et 4 dans le registre NTR : STAT:OPER:NTR 24	
Activer les bits 3 et 4 dans le registre PTR : STAT:OPER:PTR 24	

- Si les mêmes bits des registres NTR et PTR sont définis sur 1, toute transition de ce bit dans le registre des conditions de fonctionnement provoque l'activation du bit correspondant dans le registre des événements de fonctionnement.
- Si les mêmes bits des registres NTR et PTR sont définis à 0, aucune transition de ce bit dans le registre des conditions de fonctionnement ne peut aboutir à l'activation du bit correspondant dans le registre des événements de fonctionnement.
- La valeur renvoyée correspond à la somme binaire pondérée de tous les bits activés du registre.

STATus:PRESet

Prédéfini tous les registres d'activation, PTR et NTR.

Registre de fonctionnement	Registre suspect	Réglage prédéfini
STAT:OPER:ENAB	STAT:QUES<1 2>:ENAB	tous les bits définis sont désactivés
STAT:OPER:NTR	STAT:QUES<1 2>:NTR	tous les bits définis sont désactivés
STAT:OPER:PTR	STAT:QUES<1 2>:PTR	tous les bits définis sont activés

Paramètre	Renvoitype
(aucun)	(aucun)

Prédéfinir les registres de fonctionnement et d'état suspect : STAT:PRES

STATus:QUESTionable<1|2>[:EVENT]?

Effectue une requête dans le **registre des événements** du groupe **État suspect**. C'est un registre en lecture seule qui enregistre (verrouille) tous les événements qui sont transmis par le filtre NTR et/ou PTR de fonctionnement. Une fois lu, le registre des événements d'état suspect est effacé.

Paramètre	Renvoitype
(aucun)	<valeur de bit>

Lire le registre des événements d'état suspect n° 1 : STAT:QUES1?

- La valeur renvoyée correspond à la somme binaire pondérée de tous les bits activés du registre. Par exemple, lorsque le bit 2 (valeur 4) et le bit 4 (valeur 16) sont définis, la requête renvoie +20.
- La commande *RST n'a pas d'effet sur ce registre.

STATus:QUESTionable<1|2>:CONDition?

Effectue une requête dans le **registre des conditions** du groupe **État suspect**. Il s'agit d'un registre en lecture seule qui contient l'état opérationnel (non verrouillé) actif de l'instrument. La lecture du registre des événements d'état suspect n'entraîne pas son effacement.

Paramètre	Renvoi type
(aucun)	<valeur de bit>
Lire le registre de conditions d'état suspect n° 1 : STAT:QUES1:COND?	

- La valeur renvoyée correspond à la somme binaire pondérée de tous les bits activés du registre. Par exemple, lorsque le bit 2 (valeur 4) et le bit 4 (valeur 16) sont définis, la requête renvoie +20.
- Les bits du registre de conditions reflètent l'état actuel. Si une condition n'est pas remplie, le bit correspondant est effacé.
- La commande *RST efface ce registre, sauf les bits où la condition existe toujours après la commande *RST.

STATus:QUESTionable<1|2>:ENABLE <valeur>

STATus:QUESTionable<1|2>:ENABLE?

Définit la valeur du **registre d'activation** du groupe **État suspect**. Le registre d'activation est un masque qui permet d'activer des bits spécifiques du registre des événements de fonctionnement pour activer le bit QUES (récapitulatif d'état suspect) du registre d'octet d'état. STATus:PRESet efface tous les bits du registre d'activation.

Paramètre	Renvoi type
Valeur décimale correspondant à la somme binaire pondérée des bits du registre.	<valeur de bit>
Activer les bits 2 et 4 dans le registre d'activation suspect n°1 : STAT:QUES1:ENAB 24	

- Par exemple, lorsque le bit 2 (valeur 4) et le bit 4 (valeur 16) sont définis, la requête renvoie +20.
- La commande *CLS n'efface que le **registre des événements**, pas le registre d'activation.

STATus:QUESTionable<1|2>:NTRansition <valeur>

STATus:QUESTionable<1|2>:NTRansition?

STATus:QUESTionable<1|2>:PTRansition <valeur>

STATus:QUESTionable<1|2>:PTRansition?

Définit et recherche la valeur des registres **NTR** (Transition négative) et **PTR** (Transition positive). Ces registres servent de filtre de polarité entre les registres des conditions suspectes et des événements suspects.

Lorsqu'un bit du registre NTR est défini sur 1, une transition de 1 vers 0 du bit correspondant dans le registre des conditions suspectes entraîne l'activation du bit du registre des événements suspects.

Lorsqu'un bit du registre PTR est défini sur 1, une transition de 0 vers 1 du bit correspondant dans le registre des conditions suspectes entraîne l'activation du bit du registre des événements suspects.

STATus:PRESet active tous les bits des registres PTR et efface tous les bits des registres NTR.

Paramètre	Renvoitype
Valeur décimale correspondant à la somme binaire pondérée des bits du registre.	<valeur de bit>
Activer les bits 3 et 4 dans le registre NTR suspect n°1 : STAT:QUES:NTR 24	
Activer les bits 3 et 4 dans le registre PTR suspect n°1 : STAT:QUES:PTR 24	

- Si les mêmes bits des registres NTR et PTR sont définis sur 1, toute transition de ce bit dans le registre des conditions suspectes provoque l'activation du bit correspondant dans le registre des événements suspects.
- Si les mêmes bits des registres NTR et PTR sont définis à 0, aucune transition de ce bit dans le registre des conditions suspectes ne peut aboutir à l'activation du bit correspondant dans le registre des événements suspects.
- La valeur renvoyée correspond à la somme binaire pondérée de tous les bits activés du registre.

Commande STEP**[SOURce:]STEP:TOUTput 0|OFF|1|ON****[SOURce:]STEP:TOUTput?**

Indique si une sortie de déclenchement est générée lorsqu'un palier de transitoire se produit. Un signal de déclenchement est généré lorsque l'état est activé (vrai).

Paramètre	Renvoitype
0 OFF 1 ON, *RST OFF	0 ou 1
Définit le signal de déclenchement du palier sur ON (ACTIVÉ) : STEP:TOUT ON	

Sous-système SYSTEM

Les commandes System permettent de contrôler les fonctions du système qui ne sont pas directement liées aux fonctions de contrôle, de mesure ou d'état de la sortie. Notez que les commandes courantes IEEE-488 permettent également de contrôler des fonctions système, telles que l'autotest, l'enregistrement et le rappel des configurations, et bien d'autres. SYSTEM:SDS permettent de programmer le système de déconnexion de sécurité Keysight SD1000A.

SYSTEM:COMMunicate:LAN:CONTrol?

SYSTEM:COMMunicate:TCPIP:CONTrol?

Renvoie le numéro de port de connexion par socket de contrôle initial. Cette connexion permet d'envoyer et de recevoir des commandes et des requêtes. Contrairement au socket de données, qui utilise un numéro de port fixe, le numéro de port du socket de contrôle varie et doit être obtenu à l'aide de ces requêtes.

Paramètre	Renvoi type
(aucun)	<n° de port> (0 si les sockets ne sont pas pris en charge)

Connaître le numéro de port de connexion de contrôle :
 SYST:COMM:LAN:CONT? ou SYST:COMM:TCP:CONT?

SYSTEM:COMMunicate:RLState LOCAL|REMOte|RWLock

SYSTEM:COMMunicate:RLState?

Configure la configuration distante/locale de l'instrument. Les commandes à distance ou locale produisent le même résultat et sont incluses pour assurer la compatibilité avec d'autres produits. **LOCAL** configure l'instrument pour un contrôle sur le panneau avant. **REMOte** configure l'instrument pour un contrôle sur le panneau avant. **RWLock** désactive les touches du panneau avant. L'instrument peut être uniquement contrôlé via l'interface de commande à distance. Ce paramètre programmable est entièrement indépendant de la fonction de verrouillage/déverrouillage du panneau avant.

Paramètre	Renvoi type
LOCAL REMOte RWLock, *RST LOCAL	LOC, REM ou RWL

Définit la configuration distante/locale sur Remote (distante) : SYST:COMM:RLST REM

- La configuration distante/locale n'est pas affectée par la commande *RST ni par aucune commande SCPI autre que SYSTEM:COMMunicate:RLState.
- La configuration distante/locale de l'instrument peut également être définie par d'autres commandes d'interface sur l'interface GPIB et quelques autres interfaces d'E/S.
- Si plusieurs interfaces de programmation à distance sont activées, l'interface dont la configuration distante/locale a le plus récemment changé détermine la configuration distante/locale de l'instrument.

SYSTem:DATE <aaaa>, <mm>, <jj>**SYSTem:DATE?**

Règle la date de l'horloge système. Spécifier l'année (2000 à 2099), le mois (1 à 12) et le jour (1 à 31). L'horloge en temps réel n'est utilisée qu'avec le logiciel de contrôle et d'analyse Keysight 14585A.

Paramètre	Renvoi type
<aaaa>, <mm>, <jj>	+2018,+04,+30
Régler la date au samedi 30 juin 2018 : SYST:DATE 2018,06,30	

- L'horloge en temps réel ne se règle pas d'elle-même pour les modifications du fuseau horaire ou l'heure d'été/hiver.

SYSTem:ERRor?

Lit et efface une erreur dans la file d'erreurs.

Paramètre	Renvoi type
(aucun)	<+0,"No error">
Lit et efface la première erreur de la file d'erreurs : SYST:ERR?	

- Le voyant ERR du panneau avant s'allume lorsqu'au moins une erreur est en cours d'enregistrement dans la file d'erreurs. Erreur de récupération « premier entré/premier sorti » (FIFO) ; ces erreurs sont effacées à la lecture. Après avoir lu toutes les erreurs de la file d'erreurs, le voyant ERR s'éteint.
- Si plus de 20 erreurs se produisent, la dernière erreur enregistrée (la plus récente) est remplacée par -350, « Error queue overflow » (Dépassement de la capacité de la file d'erreurs). Aucune erreur supplémentaire n'est enregistrée tant que vous ne supprimez pas des erreurs de la file. Si aucune erreur ne s'est produite depuis la dernière consultation de la file d'erreurs, l'instrument indique +0, "No error" (Aucune erreur).
- La file d'erreurs est effacée par la commande *CLS et lorsque l'alimentation est coupée puis rétablie. Elle n'est pas effacée par la commande *RST.
- Les erreurs présentent le format suivant (la chaîne d'erreur peut contenir jusqu'à 255 caractères) : <code d'erreur>, <chaîne d'erreur>
Pour une liste des codes d'erreur et des chaînes de messages, reportez-vous à la section **Messages d'erreur SCPI**.

SYSTem:LFRequency?

Renvoie la fréquence de référence de la tension d'alimentation. Cette commande détermine le temps d'intégration utilisé par la commande **SENSe:SWEp:NPLC**.

À la mise sous tension, si le mode de fréquence réseau est défini sur Auto, le bloc d'alimentation détecte automatiquement la fréquence réseau (50 Hz ou 60 Hz) et détermine, à partir de cette valeur, le temps d'intégration utilisé.

Si la détection automatique de la fréquence réseau échoue en raison du bruit ou de la fréquence hors tolérance du réseau, elle utilise un réglage de 60 Hz.

Paramètre	Renvoi type
(aucun)	50 ou 60
Connaître la fréquence réseau : SYST:LFR?	

SYSTem:LFRequency:MODE AUTO|MAN50|MAN60 **SYSTem:LFRequency:MODE?**

Indique une détection automatique ou manuelle de la fréquence réseau.

AUTO indique une détection automatique.

MAN50 indique un réglage de 50 Hz.

MAN60 indique un réglage de 60 Hz.

Ces paramètres sont enregistrés dans la mémoire non volatile.

Paramètre	Renvoi type
AUTO MAN50 MAN60	AUTO, MAN50 ou MAN60
Définit le mode de fréquence réseau à 60 Hz : SYST:LFR:MODE MAN60	

SYSTem:PASSword:FPANel:RESet

Réinitialise le mot de passe de verrouillage du panneau avant à zéro. Cette commande ne permet pas de réinitialiser le mot de passe d'étalonnage.

Paramètre	Renvoi type
(aucun)	<+0,"No error">
Réinitialise le mot de passe du panneau avant : SYST:PASS:FPAN:RES	

SYSTem:REBoot

Redémarre l'instrument à son état de mise sous tension.

Paramètre	Renvoi type
(aucun)	(aucun)
Redémarre l'instrument : SYST:REB	

SYSTem:SDS:CONNect RP795xA, RP796xA

Connecte l'alimentation à l'appareil SDS Keysight SD1000A. Cette commande est utilisée lorsque le mode de connexion du SDS est réglé sur MANual.

Paramètre	Renvoi type
(aucun)	(aucun)
Se connecter à l'appareil SDS : SYST:SDS:CONN	

SYSTem:SDS:CONNect:MODE AUTO|MANual RP795xA, RP796xA**SYSTem:SDS:CONNect:MODE?**

Spécifie la méthode de connexion à l'appareil SDS lors de la mise sous tension. Ce paramètre n'est pas volatil.

AUTO - connecte automatiquement l'appareil SDS à l'alimentation lors de la mise sous tension.

MANual - attend qu'une commande de panneau avant ou SCPI connecte le SDS à l'alimentation.

Paramètre	Renvoi type
AUTO MANual	AUTO ou MAN
Définit le mode de connexion sur manuel : SYST:SDS:CONN:MODE MAN	

SYSTem:SDS:DIGital:DATA:INPut? RP795xA, RP796xA

Renvoie l'état de l'entrée du SDS. Les bits indiquent l'état des signaux d'entrée externes du SDS.

Bit	Description	Bit	Description
0	L'Estop est activé, l'alimentation est inhibée	2	Le démarrage à distance est actif
1	Le capot est ouvert, l'alimentation est inhibée	3	Le mode de commande du relais est réglé sur externe

Paramètre	Renvoi type
(aucun)	<entier>
Renvoyer l'état des entrées du SDS : SYST:SDS:DIG:DATA:INP?	

SYSTem:SDS:DIGital:DATA:OUTPut 0|1 RP795xA, RP796xA**SYSTem:SDS:DIGital:DATA:OUTPut?**

Envoyer un nombre entier dont les bits définissent l'état des signaux de sortie externes du SDS, activé ou désactivé. À ce moment, il n'y a qu'un seul signal de sortie numérique disponible, sur le connecteur **DI/DO**. Ce paramètre est volatil et ne fait pas partie de l'état enregistré de l'instrument.

Paramètre	Renvoi type
0 1, *RST0	0 ou 1
Active l'état des signaux externes : SYST:SDS:DIG:DATA:OUTP 1	

SYSTem:SDS:ENABLE 0|OFF|1|ON RP795xA, RP796xA

SYSTem:SDS:ENABLE?

Le SDS doit être activé pour permettre à l'alimentation de communiquer avec lui. Il s'agit d'un paramètre non volatil.

Paramètre	Renvoi type
0 OFF 1 ON	0 ou 1
Active l'appareil SDS : SYST:SDS:ENAB ON	

SYSTem:SDS:STATus? RP795xA, RP796xA

Renvoie l'état de protection de l'appareil SDS. Les bits entiers indiquent le motif de la protection SDS.

Bit	Description
0	Un échec de la communication de l'alimentation du SDS
1	Défaillance du contact CA - l'entrée du contact CA n'est pas active
2	Une défaillance matérielle interne du SDS

Ces défaillances ne peuvent être éliminées qu'en éteignant l'alimentation, en corrigeant le problème et en redémarrant l'alimentation.

Paramètre	Renvoi type
(aucun)	<entier>
Renvoyer l'état de l'appareil SDS : SYST:SDS:STAT?	

SYSTem:SECurity:IMMediate

Efface toute la mémoire utilisateur et redémarre l'instrument. Cette commande sert généralement à préparer l'instrument pour son retrait d'une zone sécurisée. Cela nettoie toutes les données utilisateur. Elle écrit tous les zéros dans la mémoire Flash et procède à un effacement de la mémoire du processeur conformément à la fiche technique du fabricant. Les données d'identification (microprogramme de l'instrument, numéro du modèle, numéro de série, adresse MAC et données d'étalonnage) ne sont pas effacées. Une fois les données effacées, l'instrument est redémarré.

Cette procédure est déconseillée dans les applications de routine en raison des risques de perte involontaire de données.

Paramètre	Renvoi type
(aucun)	(aucun)
Nettoie la mémoire de l'instrument : SYST:SEC:IMM	

SYSTem:SET <données de bloc>**SYSTem:SET?**

Obtenir et définir l'état de l'instrument. Le formulaire de requête de la commande renvoie un bloc de longueur définie qui contient l'état de l'instrument. Ces données de bloc peuvent être renvoyées à l'instrument pour le restaurer à l'état du bloc.

Paramètre	Renvoi type
<données de bloc>	<données de bloc>
Renvoie l'état du bloc à l'instrument : SYST:SET <données de bloc>	

SYSTem:TIME <hh>, <mm>, <ss>**SYSTem:TIME?**

Règle l'heure de l'horloge système. Spécifier les heures (0 à 23), les minutes (0 à 59) et les secondes (0 à 59). L'horloge en temps réel n'est utilisée qu'avec le logiciel de contrôle et d'analyse Keysight 14585A.

Paramètre	Renvoi type
<hh>,<mm>,<ss>	<hh,mm,ss>
Régler l'horloge sur 20h30 : SYST:TIME20,30,00	

SYSTem:VERSion?

Renvoie la version SCPI à laquelle l'instrument est conforme. Impossible à déterminer à partir du panneau avant.

Paramètre	Renvoi type
(aucun)	<"version">
Renvoyer la version SCPI : SYST:VERS?	

- La commande renvoie une chaîne de caractères sous la forme "AAAA.V", où AAAA représente l'année de la version et V une version pour cette année.

Sous-système TRIGger

Les commandes de déclenchement permettent de contrôler les sous-systèmes de transitoire et d'acquisition. Pour plus d'informations, reportez-vous à la section [Présentation des déclenchements](#).

TRIGger:ACQuire[:IMMEDIATE]

TRIGger:ELOG[:IMMEDIATE]

TRIGger:TRANSient[:IMMEDIATE]

Génère un événement de déclenchement immédiat. Cette commande permet de remplacer toute source de déclenchement sélectionnée.

La commande TRIGger:ACQuire déclenche le système d'acquisition.

TRIGger:ELOG déclenche l'enregistreur de données externe.

TRIGger:TRANSient déclenche le système de transitoire.

Paramètre	Renvoi type
(aucun)	(aucun)
Générer un déclenchement de mesure : TRIG:ACQ	

TRIGger:ACQuire:CURREnt[:LEVel] <valeur>|MIN|MAX

TRIGger:ACQuire:CURREnt[:LEVel]? [{MIN|MAX}]

TRIGger:ACQuire:VOLTage[:LEVel] <valeur>|MIN|MAX

TRIGger:ACQuire:VOLTage[:LEVel]? [{MIN|MAX}]

Définit le niveau déclenché de la sortie. S'applique lorsque la source de déclenchement de la mesure est définie sur un niveau. Les valeurs sont exprimées en ampères ou en volts. Les valeurs minimale et maximale varient selon les valeurs nominales de l'appareil.

Paramètre	Renvoi type
Tension : 0 à 102 % de la valeur nominale, *RST0 Courant : -102 à 102 % de la valeur nominale	<valeur de niveau>
Régler le niveau de courant déclenché sur 3 A : TRIG:ACQ:CURREnt 3	
Régler le niveau de tension déclenché sur 50 V : TRIG:ACQ:VOLTage 50	

TRIGger:ACQuire:CURREnt:SLOPe POSitive|NEGative

TRIGger:ACQuire:CURREnt:SLOPe?

TRIGger:ACQuire:VOLTage:SLOPe POSitive|NEGative

TRIGger:ACQuire:VOLTage:SLOPe?

Définit la pente du signal. S'applique lorsque la source de déclenchement de la mesure est définie sur un niveau. **POSitive** indique une pente ascendante du signal de sortie. **NEGative** indique une pente descendante du signal de sortie.

5 Aide-mémoire de la programmation SCPI

Paramètre	Renvoi type
POSitive NEGative, *RST POSitive	POS ou NEG
Définir une pente de courant négative (front descendant) : TRIG:ACQ:CURR:SLOP NEG	
Définir une pente de tension négative (front descendant) : TRIG:ACQ:VOLT:SLOP NEG	

TRIGger:ACQuire:INDices[:DATA]?

Renvoie les indices dans les données acquises où les déclenchements ont été capturés pendant l'acquisition. Le nombre d'indices renvoyés est identique à la valeur renvoyée par la commande TRIGger:ACQuire:INDices:COUNT?

Paramètre	Renvoi type
(aucun)	<temps>
Renvoie le nombre d'indices : TRIG:ACQ:IND?	

TRIGger:ACQuire:INDices:COUNT?

Renvoie le nombre de déclenchements capturés pendant l'acquisition.

Paramètre	Renvoi type
(aucun)	<temps>
Renvoyer le nombre de déclenchements : TRIG:ACQ:IND:COUN?	

TRIGger:ACQuire:TOUTput[:ENABLE] 0|OFF|1|ON TRIGger:ACQuire:TOUTput[:ENABLE]?

Active les déclencheurs de mesure à envoyer à une broche de port numérique. La broche du port numérique doit être configurée comme sortie de déclenchement avant de pouvoir être utilisée comme source de déclenchement (voir **E/S de déclenchement externe**).

Paramètre	Renvoi type
0 OFF 1 ON, *RST OFF	0 ou 1
Activer l'envoi de déclencheurs de mesure aux broches numériques : TRIG:ACQ:TOUT ON	

TRIGger:ACQuire:SOURce <source> TRIGger:ACQuire:SOURce?

Sélectionne la source de déclenchement du système d'acquisition :

BUS	Sélectionne une commande de déclenchement de l'interface de commande à distance.
CURRent1	Sélectionne un niveau de courant de sortie.
EXTErnal	Sélectionne TOUTES les broches du port numérique qui ont été configurées comme sources de déclenchement.

PIN<1-7>	Sélectionne une broche de port numérique configurée comme entrée de déclenchement.
TRANSient1	Sélectionne le système de transitoire comme source de déclenchement.
VOLTage1	Sélectionne un niveau de tension de sortie.

Paramètre	Renvoi type
BUS CURRent1 EXTErnal PIN<1-7> TRANSient1 VOLTage1,*RST BUS	BUS, CURR1, EXT, PIN<n>, TRAN1 ou VOLT1
Sélectionner la broche 1 du port numérique comme source de déclenchement de mesure : TRIG:ACQ:SOUR PIN1	

TRIGger:ARB:SOURce <source>

TRIGger:ARB:SOURce?

TRIGger:ELOG:SOURce <source>

TRIGger:ARB:SOURce?

TRIGger:TRANSient:SOURce <source>

TRIGger:TRANSient:SOURce?

TRIG:ARB:SOURce - Sélectionne la source de déclenchement des signaux arbitraires :

TRIG:ELOG:SOURce - Sélectionne la source de déclenchement de l'enregistrement de données externe :

TRIG:TRANSient:SOURce - Sélectionne la source de déclenchement du système de transitoire :

BUS	Sélectionne une commande de déclenchement de l'interface de commande à distance.
EXTErnal	Sélectionne TOUTES les broches du port numérique qui ont été configurées comme sources de déclenchement.
IMMediate	Déclenche le transitoire dès que la commande INITiated est exécutée.
PIN<1-7>	Sélectionne une broche de port numérique configurée comme entrée de déclenchement.

Paramètre	Renvoi type
BUS EXTErnal IMMediate PIN<1-7>*RST BUS	BUS, EXT, IMM, PIN<n>
Sélectionner la broche 1 du port numérique comme source de déclenchement du signal arbitraire : TRIG:ARB:SOUR PIN1	
Sélectionner la broche 1 du port numérique comme source de déclenchement du transitoire : TRIG:TRAN:SOUR PIN1	

Sous-système VOLTage

Les commandes Voltage permettent de programmer la tension de sortie de l'instrument.

[SOURce:]VOLTage[:LEVel][:IMMediate][:AMPLitude] <valeur>|MIN|MAX
[SOURce:]VOLTage[:LEVel][:IMMediate][:AMPLitude]? [{MIN|MAX}]
[SOURce:]VOLTage[:LEVel]:TRIGgered[:AMPLitude] <valeur>|MIN|MAX
[SOURce:]VOLTage[:LEVel]:TRIGgered[:AMPLitude]? [{MIN|MAX}]

Définit le niveau de tension immédiat ou déclenché lorsque la sortie fonctionne en mode de priorité de tension. Le niveau déclenché est la valeur qui est transférée vers la sortie lors du déclenchement d'un palier de sortie. Les unités sont exprimées en volts. La valeur maximale varie selon la tension nominale de l'appareil.

Paramètre	Renvoi type
0.1 à 102 % de la valeur nominale, *RST 0.1 % de la valeur nominale	<niveau de tension>
Définit la tension de sortie à 20 V : VOLT 20 Définit la tension déclenchée à 10 V : VOLT:TRIG 10	

[SOURce:]VOLTage:BWIDth LOW|HIGH1 RP795xA, RP796xA
[SOURce:]VOLTage:BWIDth?

REMARQUE Cette commande est fournie pour assurer la rétrocompatibilité avec les appareils RP795xA et RP796xA antérieurs. Les appareils plus récents doivent utiliser la commande VOLT:BWID:RANG.

Définit la compensation de tension. Cette commande vous permet d'optimiser le temps de réponse de la sortie avec des charges capacitives. Ces modes de compensation ne s'appliquent que lorsque l'appareil fonctionne en tension constante (CV), à la fois en priorité de tension et en priorité de courant (lorsqu'elle est en limite de tension).

Paramètre	Description
LOW(0)	Optimisé pour la stabilité avec une vaste gamme de condensateurs de sortie.
HIGH1 (1)	Assure une vitesse de programmation amont maximale ainsi qu'un temps de réponse transitoire extrêmement court lorsque la capacité de sortie est limitée à des valeurs faibles. Pour des limites de charge capacitives spécifiques, reportez-vous à la section Configurer la bande passante de sortie .

Paramètre	Renvoi type
LOW HIGH1, *RST HIGH1	LOW ou HIGH1
Définit la bande passante de tension au niveau Low (Faible) : VOLT:BWID LOW	

[SOURce:]VOLTage:BWIDth:LEVel 0 | 1 | 2, <valeur>|MIN|MAX
[SOURce:]VOLTage:BWIDth:LEVel? 0 | 1 | 2, [{MIN|MAX}]

Définit la fréquence polaire de programmation associée à chaque plage de compensation de priorité de tension. La valeur est en Hertz. La fréquence par défaut est optimisée pour une vitesse de programmation amont maximale, ainsi que pour le temps de réponse transitoire le plus rapide. Il est possible de la réduire pour compenser les dépassements de sortie.

Paramètre	Renvoi type
0 1 2	0, 1 ou 2
200 à 500 000 pour RP795xA et plage 0 (Low) RP796xA, *RST 200 17 000 à 500 000 pour RP795xA et plage 1 (High1) RP796xA, #RST 17 000 10 à 100 000 pour RP795xA et plage 0 (Low) RP796xA, *RST 1 400 10 à 100 000 pour RP795xA et plage 1 (High1) RP796xA, *RST 460 10 à 100 000 pour RP795xA et plage 2 (Low) RP796xA, *RST 55	<fréquence polaire>
Définit la bande passante de tension à 1, fréquence 10 kHz : VOLT:BWID:LEV 1, 10,000	

[SOURce:]VOLTage:BWIDth:RANGe 0 | 1 | 2
[SOURce:]VOLTage:BWIDth:RANGe?

Définit la compensation de tension. Cette commande vous permet d'optimiser le temps de réponse de la sortie avec des charges capacitives. Ces modes de compensation ne s'appliquent que lorsque l'appareil fonctionne en tension constante (CV), à la fois en priorité de tension et en priorité de courant (lorsqu'elle est en limite de tension). Reportez-vous à la section **Configurer la bande passante de sortie** pour plus d'informations sur l'effet des réglages de la compensation sur les caractéristiques de la vitesse de programmation.

Paramètre RP795xA/ RP796xA	Description
0 (basse vitesse)	Optimisé pour la stabilité avec une vaste gamme de condensateurs de sortie.
1 (haute vitesse)	Assure une vitesse de programmation amont maximale ainsi qu'un temps de réponse transitoire extrêmement court lorsque la capacité de sortie est limitée à des valeurs faibles. Pour des limites de charge capacitives spécifiques, reportez-vous à la section Configurer la bande passante de sortie .

Paramètre RP793xA/ RP794xA	Description
0 (haute vitesse/faible charge capacitive)	Indique la vitesse de programmation la plus rapide et le temps de réponse transitoire le plus court
1 (vitesse moyenne/charge capacitive moyenne)	Indique une vitesse de programmation intermédiaire et un temps de réponse transitoire. Le réglage est optimisé pour la stabilité avec une large gamme de condensateurs de sortie.
2 (vitesse faible/charge capacitive élevée)	Convient mieux aux appareils testés à haute capacité/faible ESR avec compromis entre la vitesse de programmation plus lente et la réponse transitoire.

Paramètre	Renvoi type
0 1 2, *RST 0	0, 1 ou 2

Paramètre	Renvoi type
Définit la bande passante de tension sur comp 1 : <code>VOLT:BWID:RANG 1</code>	

[SOURce:]VOLTage:LIMit[:POSitive][:IMMEDIATE][:AMPLitude] <valeur>|MIN|MAX[SOURce:]VOLTage:LIMit[:POSitive][:IMMEDIATE][:AMPLitude]? [{MIN|MAX}]

Définit la limite de tension en mode de priorité de courant. Les unités sont exprimées en volts.

Paramètre	Renvoi type
0.1 à 102 % de la valeur nominale, *RST 1 % de la valeur nominale	<limite de tension>
Définit la limite de tension à 20 V : <code>VOLT:LIM 20</code>	

**[SOURce:]VOLTage:LIMit:LOW <valeur>|MIN|MAX
[SOURce:]VOLTage:LIMit:LOW? [{MIN|MAX}]**

Définit la limite de sous-tension en mode de priorité de courant. Ceci permet d'éviter que la tension ne descende en dessous de la limite de sous-tension lors du déchargement d'une batterie. Lorsque la tension chute à la valeur limite inférieure spécifiée, la sortie passe de la priorité de courant à la limite de tension négative et le déchargement s'arrête. Ceci active le bit LIM- dans le registre d'état suspect.

Paramètre	Renvoi type
0 à 102 % de la valeur nominale, *RST 0	<limite de sous-tension>
Définit la limite de sous-tension à 2 V : <code>VOLT:LIM:LOW 2</code>	

- Cette commande est couplée à la commande `VOLTage:LIMit`. La limite de tension doit toujours être programmée à une valeur supérieure à la limite de sous-tension.
- La limite de sous-tension empêche également la sortie de se mettre en marche lorsque la tension de sortie est inférieure à la limite de sous-tension programmée.

**[SOURce:]VOLTage:MODE FIXed|STEP|LIST|ARB
[SOURce:]VOLTage:MODE?**

Définit le mode de transitoire. Cette commande détermine ce qu'il advient de la tension de sortie lorsque le système de transitoire est démarré et déclenché.

FIXed maintient la tension de sortie définie à sa valeur immédiate.

STEP (palier) fait passer la sortie au niveau déclenché lorsqu'un déclenchement se produit.

ARB entraîne la mise en conformité de la sortie aux valeurs de liste lorsqu'un déclenchement se produit.

ARB provoque la conformité de la sortie aux valeurs du signal arbitraire lorsqu'un déclenchement se produit.

Paramètre	Renvoi type
FIXed STEP LIST ARB, *RST FIXed	FIX, STEP, LIST ou ARB
Définit le mode de tension sur Step : VOLT:MODE STEP	

[SOURce:]VOLTage:PROTection[:LEVel] <valeur>|MIN|MAX
[SOURce:]VOLTage:PROTection[:LEVel]? [{MIN|MAX}]

Règle le niveau de protection contre les surtensions. Les unités sont exprimées en volts. Si la tension de sortie dépasse le niveau OVP, la sortie est désactivée et le bit OV du registre d'état des conditions suspectes est activé.

Paramètre	Renvoi type
0 à 120% de la valeur nominale, *RST 120% de la valeur nominale	<niveau de protection>
Règle la protection contre les surtensions à 24 V : VOLT:PROT 24	

- Une condition de surtension peut être annulée à l'aide de la commande OUTPUT:PROTection:CLEar une fois la cause du problème isolée.

[SOURce:]VOLTage:PROTection:LOW[:LEVel] <valeur>|MIN|MAX RP793xA, RP794xA
[SOURce:]VOLTage:PROTection:LOW[:LEVel] ? [{MIN|MAX}]

Évite l'activation de la sortie si la tension de sortie est inférieure au niveau de protection contre les sous-tensions programmé. Lorsque la condition de sous-tension est vraie, le bit UV du registre d'état suspect est défini.

Paramètre	Renvoi type
0 à 102 % de la valeur nominale, *RST 0	<règlage de la protection contre les sous-tensions>
Règle le niveau de protection à 2 V : VOLT:PROT:LOW 2	

[SOURce:]VOLTage:PROTection:LOW:DELay <valeur>|MIN|MAX RP793xA, RP794xA
[SOURce:]VOLTage:PROTection:LOW:DELay? [{MIN|MAX}]

Définit le délai de protection contre les sous-tensions en secondes. La fonction de protection contre les sous-tensions n'est pas déclenchée pendant le délai de temporisation. Une fois le délai expiré, la fonction de protection contre les sous-tensions est activée. Ceci permet d'éviter les déclenchements intempestifs lorsque la protection est activée, ainsi que les variations momentanées de l'état de la sortie qui pourraient déclencher la fonction de protection contre les surintensités. Le délai minimum est de 20,48 microsecondes et le délai maximum de 2611 secondes.

Paramètre	Renvoi type
0.00002048 - 2611 secondes *RST 20.48 µs	<valeur de délai>
Définit le délai de protection à 0,2 seconde : VOLT:PROT:LOW:DEL 0.2	

[SOURce:]VOLTage:PROTection:LOW:STATe 0|OFF|1|ON RP793xA, RP794xA
[SOURce:]VOLTage:PROTection:LOW:STATe?

Active ou désactive la protection contre les surtensions.

Paramètre	Renvoi type
0 OFF 1 ON, *RST OFF	0 ou 1
Activer l'état de protection contre les sous-tensions : <code>VOLT:PROT:LOW:STAT ON</code>	

- Une condition de sous-tension peut être annulée à l'aide de la commande `OUTPut:PROTection:CLEar`, une fois la cause du problème éliminée.

[SOURce:]VOLTage:RESistance[:LEVel][:IMMediate][:AMPLitude] <valeur>|MIN|MAX
[SOURce:]VOLTage:RESistance[:LEVel][:IMMediate][:AMPLitude]? [{MIN|MAX}]

Définit le niveau de résistance de sortie. Ne s'applique qu'en mode de priorité de tension. Les unités sont exprimées en ohms. Reportez-vous aux caractéristiques des modèles **RP793xA, RP794xA** et **RP795xA, RP796xA** pour les plages de programmation de résistance.

Paramètre	Renvoi type
0 à maximum (selon le modèle) MIN MAX, *RST 0	0
Indiquer une résistance de sortie de 0,5 ohm : <code>VOLT:RES 0.5</code>	

- Nécessite la version du microprogramme B.03.02.1232 et supérieure pour les modèles RP793xA et RP794xA.
- Lorsque les appareils sont connectés en parallèle, la résistance de sortie programmable est réduite. La résistance de sortie programmable pour un seul appareil doit être divisée par le nombre total d'appareils connectés en parallèle.

[SOURce:]VOLTage:RESistance:STATe 0|OFF|1|ON
[SOURce:]VOLTage:RESistance:STATe?

Active ou désactive la programmation de résistance de sortie. Ne s'applique qu'en mode de priorité de tension.

Paramètre	Renvoi type
0 OFF 1 ON, *RST OFF	0 ou 1
Activer la programmation de la résistance : <code>VOLT:RES:STAT ON</code>	

- Nécessite la version du microprogramme B.03.02.1232 et supérieure pour les modèles RP793xA et RP794xA.

**[SOURce:]VOLTage:SLEW[:IMMEDIATE] <valeur>|MIN|MAX|INFINITY
[SOURce:]VOLTage:SLEW[:IMMEDIATE]? [{MIN|MAX}]**

Définit la vitesse de balayage de tension. La vitesse de balayage est définie en volts par seconde et concerne toutes les variations de tension programmées, notamment celles dues à l'activation ou la désactivation de l'état de sortie. La vitesse de balayage peut être réglée sur n'importe quelle valeur comprise entre 0 et 9,9E + 37. Pour les valeurs très élevées, la vitesse de balayage est limitée par la vitesse de programmation et la bande passante indiquées de l'appareil. Les mots-clés MAX ou INFINITY définissent la vitesse de balayage à la valeur maximale.

Paramètre	Renvoi type
0 – 9.9E+37, *RST MAX	<valeur max.>
Définit la vitesse de balayage de sortie à 5 V par seconde : <code>VOLT:SLEW 5</code>	

- La requête renvoie la valeur qui a été envoyée. Si la valeur est inférieure à la vitesse de balayage minimale, la valeur minimale est renvoyée. La résolution du réglage de balayage est identique à la valeur minimale, qui peut être recherchée à l'aide de la commande `VOLTage:SLEW? MIN`. La valeur exacte varie sensiblement en fonction de l'étalonnage.

**[SOURce:]VOLTage:SLEW:MAXimum 0|OFF|1|ON
[SOURce:]VOLTage:SLEW:MAXimum?**

Active ou désactive le remplacement de la vitesse de balayage maximale. Lorsqu'elle est activée, la vitesse de balayage est définie à sa valeur maximale. Lorsqu'elle est désactivée, la vitesse de balayage est définie à la valeur immédiate par la commande `VOLTage:SLEW`. Utilisez `VOLTage:SLEW? MAX` pour rechercher la vitesse de balayage maximale qui a été définie.

Paramètre	Renvoi type
0 OFF 1 ON, *RST ON	0 ou 1
Activer le remplacement de la vitesse de balayage maximale : <code>VOLT:SLEW:MAX ON</code>	

- La commande `VOLTage:SLEW:MAX` est associée à la commande `VOLTage:SLEW`. Si `VOLTage:SLEW` définit la vitesse sur MAX ou INFINITY, la commande `VOLTage:SLEW:MAX` est activée. Si la vitesse de balayage est définie sur une autre valeur, la commande `VOLTage:SLEW:MAX` est désactivée.

Didacticiel d'état

Cette section contient une description détaillée des registres et des groupes de registres. Le schéma d'état fournit une représentation graphique de la manière dont les registres d'état et les groupes sont interconnectés.

Registres d'état

Groupe d'états de fonctionnement

Groupes d'état suspects

Groupe d'états d'événement standard

Registre d'octet d'état

Files d'erreurs et de sortie

Schéma d'état

Registres d'état

Les groupes d'état de fonctionnement et suspect utilisent quatre types de registres différents pour suivre les événements de qualification, de repérage et d'activation de l'instrument. Le groupe d'événements standard n'utilise que les registres des événements et d'activation.

- Un registre de conditions surveille continuellement l'état de l'instrument. Les bits du registre de conditions sont mis à jour en temps réel et ne sont pas verrouillés.
- Un registre PTR/NTR qualifie le signal qui est transmis au registre des événements. Lorsqu'un bit PTR est activé, les signaux à transition de front positive sont transmis au registre des événements. Lorsqu'un bit NTR est activé, les signaux à transition de front négative sont transmis au registre des événements. Lorsque les deux bits sont activés, tous les signaux sont transmis. Si aucun bit n'est activé, aucun signal n'est transmis.
- Un registre d'événements verrouille les transitions qui traversent les registres PTR et NTR. Lorsqu'un bit d'événement est activé, il maintient cet état jusqu'à ce la lecture du registre des événements. Une fois lu, le registre des événements est effacé.
- Un registre d'activation définit les bits du registre des événements qui seront signalés au registre de l'octet d'état. Vous pouvez écrire ou lire à partir d'un registre d'activation.

Groupe d'états de fonctionnement

Ces registres enregistrent les signaux qui se produisent dans des conditions de fonctionnement normales. Les groupes comprennent un registre des conditions, PTR/NTR, des événements et d'activation. Les sorties de groupe de registres d'état de fonctionnement sont conditionnées par

l'opérateur OU de façon logique dans le bit récapitulatif OPERation (7) du registre de l'octet d'état. Voir [Schéma d'état](#).

Le tableau suivant décrit les affectations de bits du registre d'état de fonctionnement.

Bit	Nom du bit	Valeur décimale	Définition
0	CV	1	La sortie est en mode de tension constante
1	CC	2	La sortie est en mode de courant constant
2	OFF	4	La sortie est programmée pour être désactivée
3	WTG-meas	8	Le système de mesure attend un événement de déclenchement
4	WTG-tran	16	Le système de transitoire attend un événement de déclenchement
5	MEAS-active	32	Le système de mesure est initialisé ou en cours
6	TRAN-active	64	Le système de transitoire est initialisé ou en cours
7-15	non utilisé	non utilisé	La valeur 0 est renvoyée

Groupes d'état suspects

Ces registres enregistrent des signaux qui indiquent un fonctionnement anormal. Les groupes comprennent un registre des conditions, PTR/NTR, des événements et d'activation. Les sorties des groupes d'état suspect sont conditionnées par l'opérateur OU de façon logique dans le bit récapitulatif QUEStionable (3) du registre de l'octet d'état. Voir [Schéma d'état](#).

Le tableau suivant décrit les affectations de bits du registre d'état suspect 1.

Bit	Nom du bit	Valeur décimale	Définition
0	OV	1	La sortie est désactivée par la protection contre les surtensions
1	OC	2	La sortie est désactivée par la protection contre les surintensités
2	PF	4	La sortie est désactivée par une panne d'alimentation secteur (alimentation secteur faible ou coupure de courant de l'alimentation secteur)
3	CP+	8	La sortie est désactivée par la limite de surpuissance positive
4	OT	16	La sortie est désactivée par la protection contre les surchauffes
5	CP-	32	La sortie est désactivée par la limite de surpuissance négative
6	OV-	64	La sortie est désactivée par une erreur de surtension négative en raison de fils de mesure inversés

5 Aide-mémoire de la programmation SCPI

7	LIM+	128	La sortie est en mode de limitation de tension ou de courant positive
8	LIM-	256	La sortie est en mode de limitation de tension positive ou de courant négatif
9	INH	512	La sortie est désactivée par un signal INHibit externe
10	UNR	1024	La sortie n'est pas régulée
11	PROT	2048	La sortie est désactivée par une protection du temporisateur de surveillance
12	EDP	4096	La sortie est désactivée par une protection contre les dynamiques de sortie excessives
13-15	non utilisé	non utilisé	La valeur 0 est renvoyée

Le tableau suivant décrit les affectations de bits du registre d'état suspect 2.

Bit	Nom du bit	Valeur décimale	Définition
0	non utilisé	non utilisé	La valeur 0 est renvoyée
1	IPK+	2	La sortie est en mode de limitation de courant de crête positive
2	IPK-	4	La sortie est en mode de limitation de courant de crête négative
3	CSF	8	Une erreur de partage de courant s'est produite
4	PSP	16	La sortie est désactivée par une protection principale/secondaire
5	SDP	32	La sortie est désactivée par une protection de système de déconnexion de sécurité
6	UV	64	Une protection contre les sous-tensions a eu lieu.
7	OCF	128	Une protection contre les erreurs de surintensité interne s'est déclenchée
8	LOV	256	Une protection contre les erreurs de surtension interne s'est déclenchée
9	DOV	512	Une protection contre les erreurs de surtension appliquée par le DUT s'est déclenchée
10-15	non utilisé	non utilisé	La valeur 0 est renvoyée

REMARQUE DOV, LOV et OCF ne sont disponibles que sur les appareils disposant une révision de microprogramme B.04.04.809 et supérieure.

Groupe d'états d'événement standard

Ces registres sont programmés par les commandes courantes. Le groupe comprend un registre des événements et d'activation. Le registre des événements standard verrouille les événements relatifs à l'état de communication. Il s'agit d'un registre en lecture seule qui est effacé après lecture. Le registre d'activation des événements standard fonctionne de la même manière que les registres d'activation des groupes d'état de fonctionnement et suspect. Voir [Schéma d'état](#).

Le tableau suivant décrit les affectations de bits du registre d'état des événements standard.

Bit	Nom du bit	Valeur décimale	Définition
0	Opération terminée	1	Toutes les commandes précédant et incluant *OPC ont été exécutées.
1	non utilisé	non utilisé	La valeur 0 est renvoyée
2	Erreur de requête	4	L'appareil a tenté de lire le tampon de sortie, mais celui-ci était vide, une nouvelle commande a été passée avant de lire une requête précédente ou les deux tampons d'entrée et de sortie sont saturés.
3	Erreur spécifique à l'appareil	8	Une erreur de l'appareil, notamment une erreur d'autotest, une erreur d'étalonnage ou une autre erreur spécifique à l'appareil, s'est produite. Messages d'erreur
4	Erreur d'exécution	16	Une erreur d'exécution s'est produite. Messages d'erreur
5	Commande	32	Une erreur de syntaxe de commande s'est produite. Messages d'erreur
6	non utilisé	non utilisé	La valeur 0 est renvoyée
7	Mise sous tension	128	L'alimentation a été coupée et rétablie depuis la dernière lecture ou le dernier effacement du registre des événements.

Registre d'octet d'état

Ce registre récapitule les informations provenant de tous les autres groupes d'état définis dans l'interface numérique standard IEEE 488.2 pour l'instrumentation programmable. Voir **Schéma d'état**.

Le tableau suivant décrit les affectations de bits du registre de l'octet d'état.

Bit	Nom du bit	Valeur décimale	Définition
0	non utilisé	non utilisé	La valeur 0 est renvoyée
1	non utilisé	non utilisé	La valeur 0 est renvoyée
2	File d'erreurs	4	Une ou plusieurs erreurs dans la file des erreurs. Utilisez la commande SYSTem:ERRor? pour lire et supprimer les erreurs.
3	Récapitulatif d'état suspect	8	Un ou plusieurs bits sont activés dans le registre de données suspectes. Les bits doivent être activés. Voir STATus:QUESTIONable:ENABLE.
4	Message disponible	16	Des données sont disponibles dans la mémoire tampon de sortie de l'instrument.
5	Récapitulatif de l'état des événements	32	Un ou plusieurs bits sont activés dans le registre des événements standard. Les bits doivent être activés. Voir *ESE .
6	Récapitulatif d'état général	64	Un ou plusieurs bits sont définis dans le registre d'octet d'état et peuvent générer une demande de service. Les bits doivent être activés. Voir *SRE .

7	Récapitulatif d'état de fonctionnement	128	Un ou plusieurs bits sont activés dans le registre d'état de fonctionnement. Les bits doivent être activés. Voir STATus:OPERation:ENABLE .
---	--	-----	---

Bits du récapitulatif d'état général et de demande de service

MSS est un récapitulatif (verrouillé) en temps réel de tous les bits du registre de l'octet d'état qui sont activés par le registre d'activation de demande de service. MSS est activé chaque fois que l'instrument a une ou plusieurs raisons de demander un service. *STB? lit le MSS dans la position de bit 6 de la réponse, mais n'efface aucun bit du registre de l'octet d'état.

Le bit RQS est une version verrouillée du bit MSS. Chaque fois que l'instrument demande un service, il définit la ligne d'interruption sur SRQ comme vraie et verrouille RQS dans le bit 6 du registre de l'octet d'état. Lorsque le contrôleur effectue une interrogation série, RQS est effacé dans le registre et revient à la position de bit 6 de la réponse. Les autres bits du registre de l'octet d'état ne sont pas perturbés.

Files d'erreurs et de sortie

La file d'erreurs est un registre de données FIFO (premier entré/premier sorti) qui enregistre une description numérique et textuelle d'une erreur ou d'un événement. Les messages d'erreur sont stockés jusqu'à leur lecture avec la commande **SYSTem:ERRor?** En cas de dépassement de la file, la dernière erreur ou le dernier événement de la file est remplacé par l'erreur -350, "Queue overflow" (Dépassement de la capacité de la file d'attente).

La file de sortie est un registre de données FIFO (premier entré/premier sorti) qui enregistre les messages jusqu'à leur lecture par le contrôleur. Chaque fois que la file contient des messages, elle active le bit MAV (4) du registre de l'octet d'état.

Schéma d'état

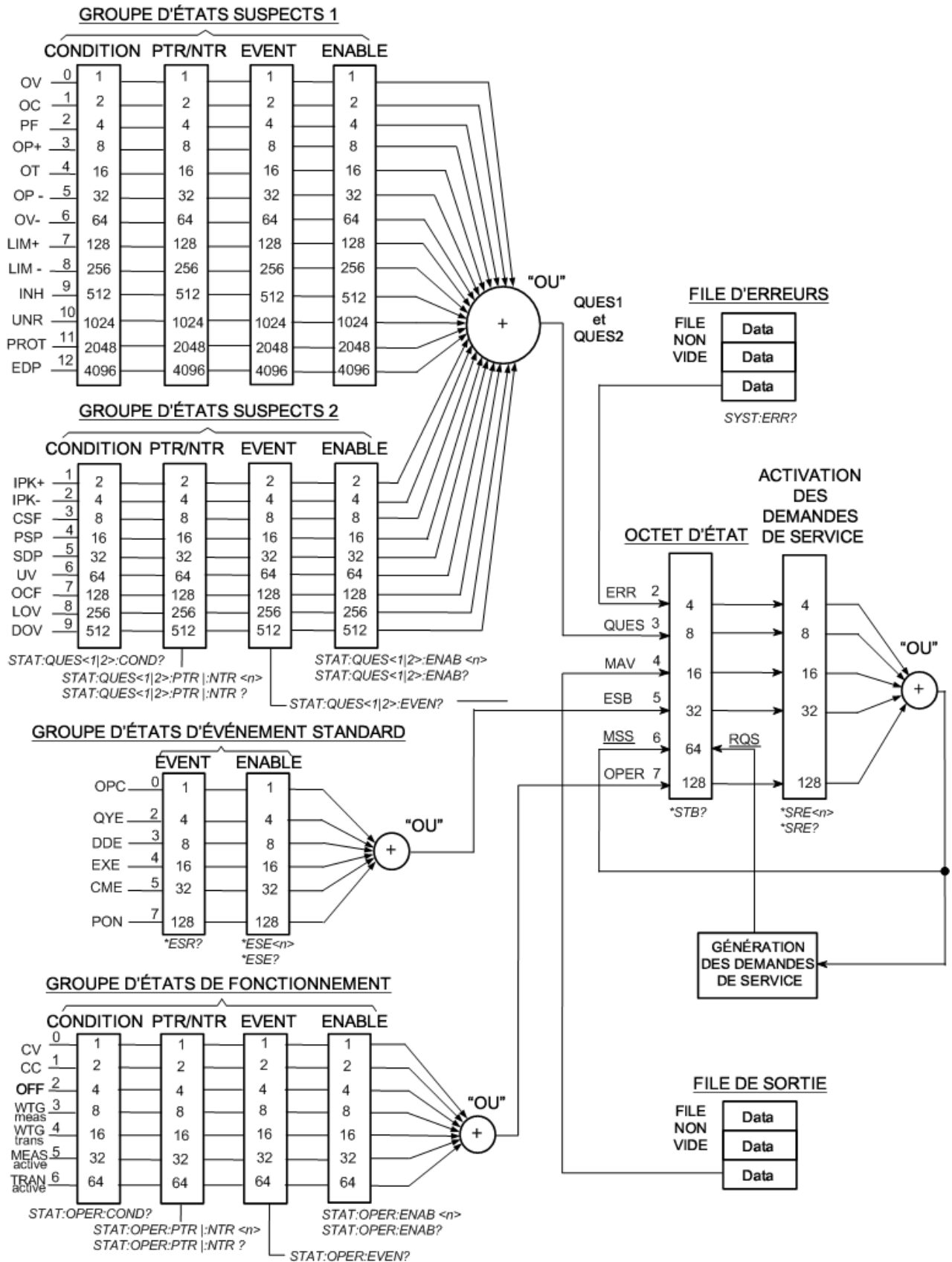

Didacticiel de déclenchement

Le système de déclenchement RPS est un système à usage universel et flexible qui contrôle l'utilisation de l'instrument afin de l'adapter à un large éventail d'applications définies par l'utilisateur. Le schéma de déclenchement ci-dessous fournit une représentation graphique de la façon dont les sources et les destinations de déclenchement sont interconnectées.

Sources de déclenchement

Destinations de déclenchement

Schéma de déclenchement

Sources de déclenchement

Le tableau suivant décrit les sources de déclenchement disponibles, indiquées sur la gauche du schéma de déclenchement. Toutes les sources de déclenchement ne peuvent pas être appliquées à chaque sous-système de déclenchement.

Source	Description
BUS	Active les déclenchements du périphérique GPIB, *TRG ou <GET> (Group Execute Trigger).
CURR1	Sélectionne un niveau de courant de sortie.
IMMediate	Déclenche le transitoire dès que la commande INITiated est exécutée.
PIN<n> EXternal	Sélectionne une broche de port numérique configurée comme entrée de déclenchement. <n> indique le numéro de la broche. EXternal permet de sélectionner TOUTES les broches du connecteur qui ont été configurées comme entrées de déclenchement.
TRAN1	Sélectionne le système de transitoire comme source de déclenchement.
TRIG:ACQ:IMM	Déclenche immédiatement l'acquisition.
TRIG:TRAN:IMM	Déclenche immédiatement le transitoire.
VOLT1	Sélectionne un niveau de tension de sortie.

Destinations de déclenchement

Le tableau suivant décrit les destinations du système de déclenchement.

Destination	Description
Broche numérique	Envoie le déclenchement à la broche numérique désignée. Voir Programmation du port numérique .
Système transitoire	Envoie le déclenchement au transitoire désigné (STEP, BOST, EOST)
Système d'acquisition	Envoie le déclenchement au système d'acquisition (TOUT)
Arb	Démarre le signal arbitraire. Notez que le signal doit d'abord être activé et initialisé. Voir Programmation des transitoires de sortie .

Schéma de déclenchement

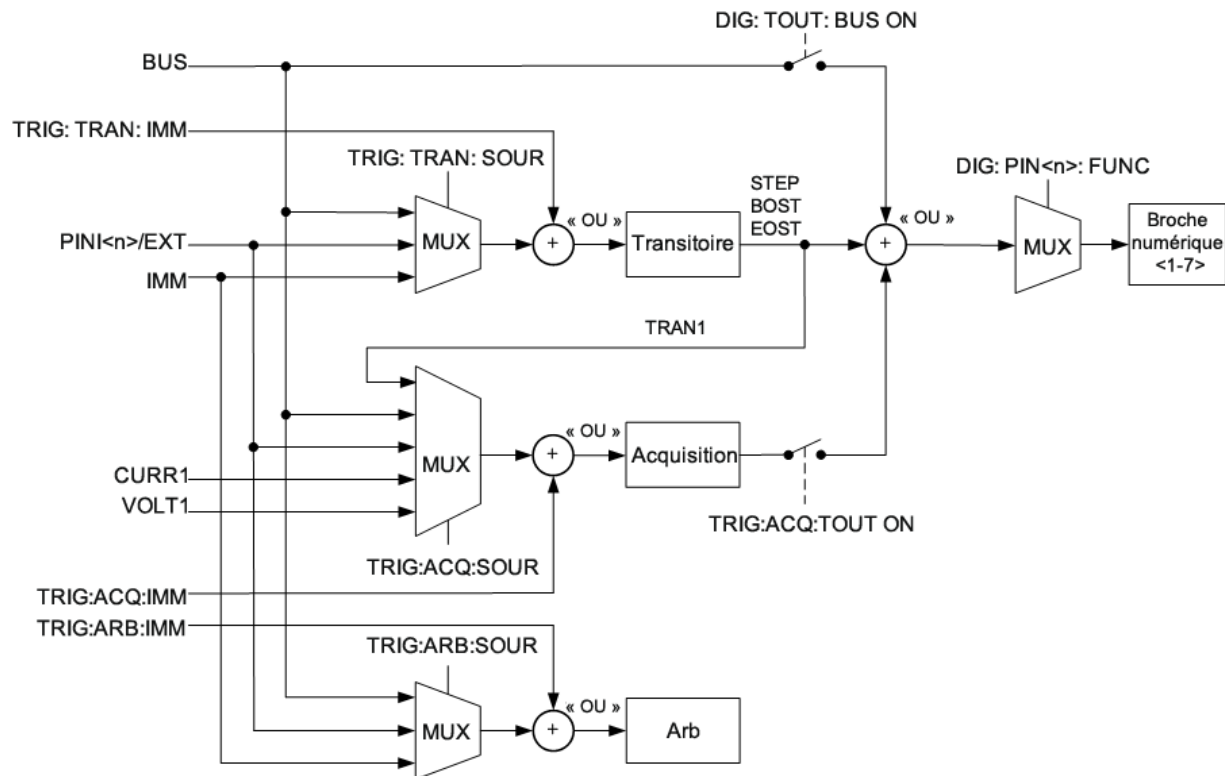

État de réinitialisation (*RST)

REMARQUE

La configuration à la mise sous tension ou après une réinitialisation peut être différente de celle indiquée ci-dessous si vous avez activé le mode de rappel de la configuration à la mise sous tension dans le menu **States** (voir **Enregistrement des configurations de l'instrument**).

Paramètres de réinitialisation

Le tableau suivant illustre l'état de réinitialisation. Ces paramètres sont réinitialisés avec les valeurs indiquées à la mise sous tension ou après la commande *RST.

Paramètres *RST des commandes SCPI	
ARB:COUNT	1
ARB:CURRent:CDWell:DWELL	0,001
ARB:FUNCTion:SHAPE	CDW
ARB:FUNCTion:TYPE	VOLTage
ARB:TERMinate:LAST	OFF
ARB:VOLTage:CDWell:DWELL	0,001
CALibrate:STATE	OFF
CURRent	0
CURRent:LIMit	1,02% de la valeur nominale
CURRent:LIMit:NEGative	-10,2% de la valeur nominale
CURRent:MODE	FIXed
CURRent:PROTection:DELay	20 ms
CURRent:PROTection:DELay:START	SCHange
CURRent:PROTection:STATE	OFF
CURRent:SHARing	OFF
CURRent:SLEW	MAX
CURRent:SLEW:MAXimum	ON
CURRent:TRIGgered	0
DIGital:OUTPut:DATA	0
DIGital:TOUTput:BUS	OFF

Paramètres *RST des commandes SCPI	
DISPlay	ON
DIGital:OUTPut:DATA	0
DIGital:TOUTPut:BUS	OFF
FORMat:DATA	ASCII
FORMat:BORDER	NORMAL
FUNcTion	VOLTage
INITialize:CONTInuous:TRANSient	OFF
LIST:COUNT	1
LIST:CURREnt	1 palier réglé sur 0
LIST:DWELL	1 palier réglé sur 0,001
LIST:STEP	AUTO
LIST:TERMinate:LAST	OFF
LIST:TOUTput:BOStep	1 palier réglé sur OFF (DÉSACTIVÉ)
LIST:TOUTput:EOStep	1 palier réglé sur OFF (DÉSACTIVÉ)
LIST:VOLTage	1 palier réglé sur 0,1 % de la valeur nominale
LXI:IDENTify	OFF
LXI:MDNS	OFF
OUTPut	OFF
OUTPut:DElay:FALL	0
OUTPut:DElay:RISE	0
OUTPut:PROTection:WDOG	OFF
OUTPut:PROTection:WDOG:DElay	60
RESistance	0
RESistance:STATe	0
SENSe:CURREnt:RANGe:AUTO	102,5% de la valeur nominale
SENSe:FUNcTion:CURREnt	1
SENSe:FUNcTion:VOLTage	1
SENSe:SWEep:NPLCycles	1
SENSe:SWEep:OFFSet:POINts	0

5 Aide-mémoire de la programmation SCPI

Paramètres *RST des commandes SCPI	
SENSe:SWEEp:POINts	3255 (60 Hz) ; 3906 (50 Hz)
SENSe:SWEEp:TINterval	5.12E-6
SENSe:WINDow	RECTangular
STEP:TOUTput	OFF
TRIGger:ACQuire:CURRent	0
TRIGger:ACQuire:CURRent:SLOPe	POSitive
TRIGger:ACQuire:SOURce	BUS
TRIGger:ACQuire:TOUTput	OFF
TRIGger:ACQuire:VOLTage	0
TRIGger:ACQuire:VOLTage:SLOPe	POSitive
TRIGger:ARB:SOURce	BUS
TRIGger:TRANSient:SOURce	BUS
VOLTage	0,1% de la valeur nominale
VOLTage:LIMit	1% de la valeur nominale
VOLTage:MODE	FIXed
VOLTage:PROTection	120 % de la valeur nominale
VOLTage:RESistance	0
VOLTage:RESistance:STATE	OFF
VOLTage:SLEW	MAX
VOLTage:SLEW:MAXimum	ON
VOLTage:TRIGgered	0,1% de la valeur nominale

Paramètres non volatiles

Le tableau suivant décrit les réglages d'usine des paramètres **non volatiles**. Ces derniers ne sont pas affectés par une remise sous tension ou la commande *RST.

Paramètres d'usine de SCPI	
CALibrate:DATE	chaîne vide
CALibrate:PASSword	0
DIGital:PIN<toutes>:FUNCtion	DINput

Paramètres d'usine de SCPI	
DIGital:PIN<toutes>:POLarity	POSitive
DISPlay:VIEW	METER_VI
INSTrument:GROup:FUNctIon	NONE
INSTrument:GROup:SECOndary:ADDReSS	1
OUTPut:COUPle	OFF
OUTPut:COUPle:DOFFset	0
OUTPut:INHibit:MODE	OFF
OUTPut:PON:STATe	RST
OUTPut:RELay:LOCK	OFF
SYSTem:LFRequency:MODE	AUTO
SYSTem:SDS:DIGital:DATA:OUTPut	0
SYSTem:SDS:ENABle	OFF
Paramètres d'usine du panneau avant	
Mot de passe de verrouillage du panneau avant	Désactivé
Mise à jour du microprogramme protégée par mot de passe	Désactivé
Adresse GPIB	5
Interface GPIB	Activé
Interface LAN	Activé
Interface USB	Activé
Écran de veille	Activé
Délai d'activation de l'écran de veille	60 minutes
Réveil par l'E/S	Activé
Paramètres d'usine de l'interface	
Obtenir l'adresse GPIB	Automatique
Masque de sous-réseau	255.255.0.0
Passerelle par défaut	0.0.0.0
Nom d'hôte	K-<n° de série>
Nom du service mDNS	Système d'alimentations régénératrices Keysight RP79xxx <n° de série>
Service LAN - VXI-11	Activé

5 Aide-mémoire de la programmation SCPI

Paramètres d'usine de SCPI	
Service LAN - Telnet	Activé
Service LAN - mDNS	Activé
Service LAN - serveur Web	Activé
Service LAN - sockets	Activé
Mot de passe Web	Vide

Messages d'erreur SCPI

L'instrument Keysight renvoie des messages d'erreur conformes à la norme SCPI.

- Il est possible d'enregistrer jusqu'à 20 erreurs dans chaque liste des erreurs des interfaces (une pour chaque erreur GPIB, USB, VXI-11 et Telnet/Sockets). Les erreurs sont affichées dans la file d'erreurs de la session d'E/S ayant provoqué l'erreur.
- Le voyant d'erreur ERR du panneau avant s'allume lorsqu'une ou plusieurs erreurs se trouvent dans la file d'erreurs.
- Une liste globale spéciale des erreurs contient toutes les erreurs matérielles et à la mise sous tension (ex. température excessive).
- Erreur de récupération « premier entré/premier sorti » (FIFO) ; ces erreurs sont effacées à la lecture. Après la lecture de toutes les erreurs spécifiques à l'interface, les erreurs dans liste globale sont récupérées. Après avoir lu toutes les erreurs de la file d'erreurs, le voyant ERR s'éteint.
- Si plus de 20 erreurs se produisent, la dernière erreur enregistrée (la plus récente) est remplacée par -350, « Error queue overflow » (Dépassement de la capacité de la file d'erreurs). Aucune erreur supplémentaire n'est enregistrée tant que vous ne supprimez pas des erreurs de la file. Si aucune erreur ne s'est produite depuis la dernière consultation de la file d'erreurs, l'instrument indique +0, "No error" (Aucune erreur).
- Le panneau avant signale les erreurs de toutes les sessions d'E/S et de la file d'erreurs globales. Pour consulter la file d'erreurs sur le panneau avant, appuyez sur la touche ERROR.
- Les conditions d'erreur sont également récapitulées dans le registre de l'octet d'état. Pour plus d'informations, reportez-vous à la section **Présentation du sous-système Status**
- Les listes des erreurs des interfaces sont effacées lorsque l'alimentation est coupée puis rétablie et par la commande *CLS. La commande *RST n'efface pas la file d'erreurs.
- SCPI :

SYSTem:ERRor? *Lire et effacer une erreur de la file*

Les erreurs présentent le format suivant (la chaîne d'erreur peut contenir jusqu'à 255 caractères) :

Erreurs dépendantes de l'appareil (activent le bit 3 du registre d'état des événements standard)

0 No error

Réponse à la requête ERR? en l'absence d'erreur.

101 Calibration state is off

L'étalonnage n'est pas activé. L'instrument n'accepte pas les commandes d'étalonnage.

102 Calibration password is incorrect

5 Aide-mémoire de la programmation SCPI

Le mot de passe d'étalonnage est incorrect.

103 Calibration is inhibited by switch setting

Le mode d'étalonnage est verrouillé par le commutateur d'étalonnage.

104 Bad sequence of calibration commands

Les commandes d'étalonnage n'ont pas été saisies dans l'ordre approprié.

105 Unexpected output current

Le courant de sortie mesuré se trouve en dehors de la plage admissible.

106 Zero measurement out of range error

La valeur de mesure "zéro" se trouve en dehors de la plage admissible.

107 Programming cal constants out of range

Les constantes d'étalonnage programmées se trouvent en dehors de la plage admissible.

108 Measurement cal constants out of range

La constante d'étalonnage de mesure se trouve en dehors de la plage admissible.

109 Over voltage cal constants out of range

La constante d'étalonnage de surtension se trouve en dehors de la plage admissible.

110 Wrong V+I

L'instrument n'a pas pu régler la valeur de tension ou de courant appropriée.

114 Wrong status

Une fonction d'état incorrecte a été signalée.

116 Locked out by internal switch setting

Cette fonction a été verrouillée par un commutateur interne.

117 Calibration error

Une erreur d'étalonnage s'est produite. N'enregistrez pas les constantes d'étalonnage. Essayez de réétalonner l'appareil.

200 Hardware error channel <1>

Une erreur matérielle s'est produite sur la sortie.

201 Invalid configuration

Une configuration en parallèle ou SDS non valide n'est pas autorisée.

202 Selftest Fail

Un échec d'autotest s'est produit. Consultez la liste des échecs d'autotest pour plus de détails.

203 Compatibility function not implemented

La fonction de compatibilité demandée n'est pas disponible.

204 NVRAM checksum error

Une erreur de somme de contrôle s'est produite dans la RAM non volatile de l'instrument.

205 NVRAM full

La mémoire RAM non volatile de l'instrument est pleine.

206 File not found

Le fichier d'étalonnage interne ou le fichier d'attribut de voie interne est introuvable dans la NVRAM.

207 Cal file version error

Le fichier d'étalonnage a été écrit ou lu à l'aide d'une ancienne version du microprogramme. Le microprogramme doit être mis à jour.

208 Running backup firmware

L'instrument exécute actuellement la version (précédente) de sauvegarde du microprogramme.

210 Frame NVRAM error

Une erreur de mémoire non volatile s'est produite dans l'instrument.

212 State file not loaded

Le chargement d'un fichier de configuration de sortie précédemment enregistré a échoué.

214 Line frequency error

Une incohérence a été détectée entre la fréquence réseau et le réglage correspondant.

215 Hardware failure

Une défaillance matérielle s'est produite sur le bloc d'alimentation

302 Option not installed

L'option qui est programmée par cette commande n'est pas installée.

303 There is not a valid acquisition to fetch from

Le tampon de mesure ne contient aucune donnée valide.

304 Volt and curr in incompatible transient modes

La tension et le courant ne peuvent pas être simultanément en mode Palier et Liste.

305 A triggered value is on a different range

Une valeur déclenchée se situe dans une plage différente de celle actuellement définie.

306 Too many list points

5 Aide-mémoire de la programmation SCPI

Vous avez saisi un nombre excessif de points de liste.

307 List lengths are not equivalent

Une ou plusieurs listes n'ont pas la même longueur.

308 This setting cannot be changed while transient trigger is initiated

Vous ne pouvez pas modifier ce paramètre lorsque l'instrument attend ou exécute une séquence de déclenchement.

309 Cannot initiate, voltage and current in fixed mode

Impossible de démarrer le générateur de transitoire. La fonction de tension ou de courant est définie en mode fixe.

310 The command is not supported by this model

Cet instrument n'inclut pas de fonctionnalités matérielles ni les options nécessaires pour prendre en charge cette commande.

315 Settings conflict error

Un élément de donnée n'a pas pu être programmé en raison de la configuration actuelle de l'instrument.

316 Mass storage error

La mémoire de stockage de masse a été dépassée.

317 Invalid format

Un format de données non valide a été trouvé dans la chaîne de commande.

320 Firmware update error

Cela peut être dû à l'incapacité du matériel de l'instrument à prendre en charge la version du microprogramme.

324 Inconsistent arb settings

Les paramètres du signal arbitraire sont incohérents ; très probablement une différence dans les longueurs de signal arbitraire.

327 Initiated with no sense function enabled

Une mesure a été lancée sans spécifier la fonction de mesure (sense).

328 Too many measurement points

Vous avez saisi un nombre excessif de points de mesure.

331 Illegal parameter value

La valeur du paramètre est en dehors de la plage ou n'existe pas.

332 Erreur principale/secondaire

Une erreur s'est produite dans la configuration principale/secondaire

333 Safety Disconnect error

Une erreur s'est produite sur l'appareil SDS.

Erreurs de commande (activent le bit 5 du registre d'état des événements standard)

-100 Command error

Erreur de syntaxe générique.

-101 Invalid character

Un caractère non valide a été trouvé dans la chaîne de commande.

-102 Syntax error

Une syntaxe non valide a été trouvée dans la chaîne de commande. Vérifiez la présence éventuelle d'espaces blancs.

-103 Invalid separator

Un séparateur non valide a été trouvé dans la chaîne de commande. Vérifiez si , ; : sont correctement utilisés.

-104 Data type error

La chaîne de commande comporte un type de donnée différent de celui qui est autorisé.

-105 GET not allowed

Les déclencheurs d'exécution de groupe ne sont pas autorisés dans les chaînes de commande.

-108 Parameter not allowed

Le nombre de paramètres reçus est plus élevé que le nombre prévu.

-109 Missing parameter

Le nombre de paramètres reçus est moins élevé que le nombre prévu.

-110 Command header error

Une erreur a été détectée dans l'en-tête.

-111 Header separator error

La chaîne de commande comporte un caractère qui n'est pas un séparateur d'en-tête valide.

-112 Program mnemonic too long

L'en-tête contient plus de 12 caractères.

-113 Undefined header

Une commande qui n'était pas valide pour cet instrument a été reçue.

5 Aide-mémoire de la programmation SCPI

-114 Header suffix out of range

La valeur du suffixe numérique n'est pas valide.

-120 Numeric data error

Erreur de donnée numérique générique.

-121 Invalid character in number

La chaîne de commande comporte un caractère non valide pour le type de donnée.

-123 Exponent too large

La puissance de l'exposant était supérieure à 32 000.

-124 Too many digits

La mantisse d'un paramètre numérique contenait plus de 255 chiffres, exception faite des zéros non significatifs.

-128 Numeric data not allowed

Un paramètre numérique a été reçu alors qu'une chaîne de caractères était attendue.

-130 Suffix error

Erreur de suffixe générique.

-131 Invalid suffix

Un suffixe a été mentionné incorrectement pour un paramètre numérique.

-134 Suffix too long

Le suffixe contient plus de 12 caractères.

-138 Suffix not allowed

Cette commande ne prend pas en charge les suffixes.

-140 Character data error

Erreur de donnée de caractère générique.

-141 Invalid character data

L'élément des données de caractère contient un caractère non valide ou l'élément n'est pas valide.

-144 Character data too long

L'élément de donnée de caractère contient plus de 12 caractères.

-148 Character data not allowed

Un paramètre discret a été reçu alors qu'une chaîne ou un paramètre numérique était attendu(e).

-150 String data error

Erreur de donnée de chaîne générique.

-151 Invalid string data

Une chaîne de caractères non valide a été reçue. Vérifiez que cette chaîne se trouve entre guillemets.

-158 String data not allowed

Une chaîne de caractères a été reçue alors qu'elle n'est pas autorisée pour cette commande.

-160 Block data error

Erreur de donnée de bloc générique

-161 Invalid block data

Le nombre d'octets de données envoyé ne correspond pas au nombre d'octets indiqués dans l'en-tête.

-168 Block data not allowed

Des données ont été envoyées dans un format de bloc arbitraire mais cette commande ne l'autorise pas.

Erreurs d'exécution (activent le bit 4 du registre d'état des événements standard)

-200 Execution error

Erreur de syntaxe générique

-220 Parameter error

Une erreur associée à l'élément de donnée s'est produite.

-221 Settings conflict

Un élément de donnée n'a pas pu être exécuté en raison de la configuration actuelle de l'instrument.

-222 Data out of range

Un élément de donnée n'a pas pu être exécuté, car la valeur se trouvait en dehors de la plage valide.

-223 Too much data

Un élément de donnée reçu contient plus de données que l'instrument ne peut en gérer.

-224 Illegal parameter value

Une valeur exacte était attendue, mais n'a pas été reçue.

-225 Out of memory

La mémoire de l'appareil ne suffit pas pour effectuer l'opération demandée.

-226 Lists not same length (Listes de longueur différente)

Une ou plusieurs listes n'ont pas la même longueur.

5 Aide-mémoire de la programmation SCPI

-230 Data corrupt or stale

Il est possible que des données ne soient pas valides. Une nouvelle mesure a commencé, mais n'a pas été terminée.

-231 Data questionable

L'exactitude de la mesure est suspecte.

-232 Invalid format

Le format ou la structure des données est inapproprié(e).

-233 Invalid version

La version du format de données est incorrecte pour l'instrument.

-240 Hardware error

La commande n'a pas pu être exécutée en raison d'un problème matériel de l'instrument.

-241 Hardware missing

La commande n'a pas pu être exécutée en raison d'un matériel manquant (par exemple, une option).

Erreurs de requête (activent le bit 2 du registre d'état des événements standard)

-400 Query Error

Erreur de requête générique.

-410 Query INTERRUPTED

Une condition provoquant une erreur de requête interrompue s'est produite.

-420 Query UNTERMINATED

Une condition provoquant une erreur de requête non terminée s'est produite.

-430 Query DEADLOCKED

Une condition provoquant une erreur d'impasse de la requête s'est produite.

-440 Query UNTERMINATED after indefinite response

Une requête a été reçue dans le même message de programme à la suite d'une requête indiquant une réponse indéfinie.

Commandes de compatibilité

Cette section décrit la compatibilité de la série Keysight RPS7900 avec les systèmes d'alimentation avancés (APS) Keysight N7900 existants. En raison de leurs ensembles de fonctionnalités, seuls les programmes écrits pour les systèmes d'alimentation avancés N7900 sont compatibles avec les modèles de système d'alimentations régénératrices (RPS). Notez que toutes les fonctionnalités ne sont pas communes aux deux familles.

Commandes compatibles avec le code APS avec des modèles RPS

Ces commandes APS du Keysight N7900 sont compatibles avec les modèles RPS.

Commandes APS de la série N7900	Action ou équivalence sur les modèles RPS
[SOURce] :RESistance <valeur> :STATE <Booléen>	[SOURce] :VOLTage :RESistance <valeur> :STATE <Booléen>

Comparaison des ensembles de fonctionnalités APS avec les modèles RPS

Le tableau suivant compare l'ensemble de fonctionnalités des modèles APS Keysight N7900 avec l'ensemble de fonctionnalités des modèles RPS

Fonctionnalité	Dans les modèles APS N7900 ?
Fonctionnement sur deux quadrants	Oui
Fonctionnement en mode de priorité de tension ou de courant	Oui
Vitesses de balayage de tension et de courant	Oui
Programmation de la résistance (en mode de priorité de tension)	Oui
Sélection de bande passante de sortie (en mode de priorité de tension)	Oui
Déclenchement de la sortie	
Changement de sortie en une seule étape	Oui
Liste des sorties jusqu'à 512 points	Oui
Signal arbitraire constant - jusqu'à 64 000 points	Oui
Mesures scalaires	
Mesures scalaires de la tension CC, RMS, élevée/faible, min/max	Oui
Mesures scalaires du courant CC, RMS, élevé/faible, min/max	Oui
Puissance moyenne	Oui
Ampères-heures et watts-heures	Oui
Mesures numérisées	
Mesures simultanées de tension et de courant	Oui
Données de courant, de tension et d'alimentation	Oui
Enregistrement de données externe	Oui

5 Aide-mémoire de la programmation SCPI

Fonctionnalité	Dans les modèles APS N7900 ?
Systèmes de déclenchement	
Mesures	Oui
Transitoires	Oui
Broches du port numérique	Oui
État de sortie	Oui
Protection définie par l'utilisateur	Oui
Événements Black Box	Oui
Acheminement de déclenchement	Oui
Fonctions de protection	
Surtension à distance et locale	Oui
Surintensité	Oui
Surchauffe	Oui
Dynamique de sortie excessive	Oui
Impédance élevée/Faible impédance (High Z/Low Z)	Oui
Protection de l'utilisateur	Oui
Système de déconnexion de sécurité auxiliaire disponible	Non
Caractéristiques du système	
Broches du port numérique	Oui
Sortie distant d'inhibition/par défaut	Oui
Contrôle de la vitesse des ventilateurs	Oui
Activation/désactivation de la sortie couplée	Oui
Partage de courant avec deux fils	Oui
Relais de sortie	Oui
Enregistreurs Black Box (BBR)	Oui
Détection par défaut des mesures	Oui
Capacité du mode principal/secondaire	Non

6

Vérification et étalonnage

Équipement et configurations de test

Vérification du fonctionnement

Étalonnage de l'instrument

Formulaires de relevé de test

Équipement et configurations de test

Équipement de test

Configurations de mesure

Équipement de test

L'équipement nécessaire aux tests de fonctionnement et aux procédures de réglage est répertorié ci-dessous. Si l'appareil recommandé est indisponible, vous pouvez le remplacer par un autre de précision équivalente.

Instrument	Conditions requises	Modèle recommandé	Usage ¹
Multimètre numérique	Résolution : 10 nV à 1 V ; Résultat : 8 1/2 chiffres Précision : 20 ppm	Keysight 3458A	V, E
Shunt de courant ²	100 A (0,01 Ω) 0,01 %, TC = 4 ppm/ Ω C 300 A (0,001 Ω) 0,01 %, TC = 4 ppm/ Ω C 1000 A 0,1 m Ω 0,02%, TC = 25 ppm/ Ω C	Guildline 9230A/100 Guildline 9230A/300 Guildline 9230A/1000 ou équivalent	V, E
Charge électronique et source ²	20 V, 800 A, 10 kW 80 V, 250 A, 10 kW 160 V, 125 A, 10 kW 500 V, 40 A, 10 kW 950 V, 20 A, 10 kW	Keysight RP7933A ou RP7943A ³ Keysight RP7935A ou RP7945A ³ Keysight RP7936A ou RP7946A ³ Keysight RP7952A ou RP7962A ³ Keysight RP7953A ou RP7963A ³	V
Alimentation CC ⁴	80 V, 40 A	Keysight RP7935A/RP7945A ³ ou équivalent	E
Contrôleur GPIB	Fonctionnalités GPIB complètes	Keysight 82350B ou équivalent	V, E
Oscilloscope	Sensibilité : 1 mV Bande passante : 20 MHz Sonde : 10:1 avec pointe RF Sonde : 100:1 avec pointe RF	Keysight DSO6054A ou équivalent 10073D Keysight Keysight 10076C	V
Voltmètre efficace	Valeur efficace vraie Bande passante : 20 MHz Sensibilité : 100 μ V	Modèle Rhode et Schwartz URE3 ou équivalent	V
Amplificateur différentiel	Bande passante : 20 MHz	LeCroy 1855A, DA1850A, ou équivalent	V
Sonde différentielle	10:1/100:1 au choix	LeCroy DXC100A, ou équivalent	V
Terminaisons	Terminaison de 50 Ω BNC		V

¹V=Vérification ; E=Étalonnage

²En fonction de la tension de sortie nominale du modèle testé

³En fonction de l'alimentation secteur disponible dans l'installation de test (208 V CA 3 ϕ ou 480 V CA 3 ϕ)

⁴Nécessaire pour l'étalonnage sur les modèles RP795xA/RP796xA uniquement

Configurations de mesure

Voltmètre

Pour vous assurer que les valeurs relevées par le voltmètre pendant les procédures de vérification et d'étalonnage ne sont pas affectées par la mesure instantanée des crêtes CA de l'ondulation de courant de sortie, effectuez plusieurs mesures CC et calculez leur moyenne.

Si vous utilisez un multimètre numérique Keysight 3458A, vous pouvez configurer le voltmètre pour effectuer cette opération automatiquement. À partir du panneau avant de l'instrument, programmez 100 cycles de tension d'alimentation par mesure. Appuyez sur NPLC 100 ENTER. En outre, activez la fonction d'étalonnage automatique (ACAL) et de commutation automatique de plage (ARANGE).

Shunt de courant

Le shunt de courant de 4 bornes permet d'éliminer les erreurs de mesure du courant de sortie provoquées par les chutes de tension dans les fils et les connexions de charge. Il inclut des bornes de contrôle de courant spéciales dans les bornes de connexion de charge. Branchez le voltmètre directement à ces bornes de contrôle du courant.

Charge électronique

La plupart des procédures de test exigent que vous utilisiez une charge variable capable de dissiper la puissance requise. Pour tous les tests, un appareil Keysight RP79xxA peut être utilisé comme charge, à condition que sa tension nominale soit équivalente à celle de l'appareil testé. L'appareil de charge RP79xxA est bien plus facile à utiliser que les résistances de charge.

Les résistances de charge fixes peuvent être utilisées à la place d'une charge variable, en adaptant sensiblement les procédures de test. Pour éviter tout contact avec des tensions élevées au cours du fonctionnement, utilisez des commutateurs pour connecter, déconnecter ou court-circuiter les résistances de charge.

Aussi, si vous utilisez des configurations de test assistées par ordinateur, les temps de stabilisation relativement courts (par rapport aux voltmètres des ordinateurs et du système) et les vitesses de balayage du RPS devront éventuellement être pris en compte. Vous pouvez utiliser des instructions d'attente dans le programme de test si le système de test est plus rapide que le RPS.

Vérification du fonctionnement

Introduction

Configurations de vérification

Considérations relatives aux tests

Précision de programmation et de relecture de la tension

Effet de charge de tension constante

Ondulation et bruit de tension constante

Temps de récupération au transitoire

Précision de programmation et de relecture du courant

Effet de charge de courant constant

Vérification de la capacité d'absorption de courant

Formulaires de relevé de test

Introduction

AVERTISSEMENT

RISQUE D'ÉLECTROCUTION, TENSION LÉTALES De nombreux modèles génèrent des tensions supérieures à 60 V CC, certains modèles ayant une tension nominale de 950 V CC ! Assurez-vous que toutes les connexions des instruments, le câblage de charge et les connexions de charge sont isolés ou recouverts à l'aide des capots de sécurité fournis, de sorte qu'aucun contact accidentel avec des tensions létales ne peut se produire.

Les tests de vérification du fonctionnement permettent de vérifier que l'appareil testé (UUT) fonctionne normalement et qu'il est conforme aux spécifications publiées. Il existe deux niveaux différents de tests de vérification du fonctionnement :

- **Tests de vérification du fonctionnement** Un ensemble complet de tests recommandés comme tests de recette technique lorsque vous recevez l'instrument ou après des réglages.
- **Tests d'étalonnage** Ces tests vérifient que l'instrument fonctionne dans ses limites d'étalonnage.

Les tests de vérification du fonctionnement sont recommandés comme tests de recette lorsque vous recevez l'instrument. Les résultats des tests de recette doivent être comparés aux spécifications de l'instrument.

Keysight Technologies vous conseille de refaire les tests de vérification du fonctionnement à chaque intervention d'étalonnage. Cela garantit que l'instrument conservera ses caractéristiques jusqu'à l'étalonnage suivant ainsi que sa stabilité à long terme. Les caractéristiques fonctionnelles mesurées avec cette méthode sont utilisables pour prolonger la fréquence d'étalonnage.

Effectuez les tests de vérification avant d'étalonner votre système d'alimentation. Si l'instrument réussit les tests de vérification, l'appareil fonctionne dans ses limites d'étalonnage et n'a pas besoin d'être réétalonné.

Si l'instrument échoue à l'un des tests ou si les résultats de test sont anormaux, essayez d'étalonner l'appareil. En cas d'échec de l'étalonnage, retournez l'appareil à un centre de service après-vente Keysight Technologies.

Pour obtenir une liste des configurations d'équipement et de test nécessaires à la vérification, reportez-vous à la section **Équipement et configurations de test recommandés**. Pour plus d'informations sur la connexion du voltmètre, le shunt de courant et la charge, reportez-vous également à la section **Configurations de mesure**.

AVERTISSEMENT

RISQUE D'ÉLECTROCUTION, TENSION LÉTALES De nombreux modèles génèrent des tensions supérieures à 60 V CC, certains modèles ayant une tension nominale de 950 V CC ! Assurez-vous que toutes les connexions des instruments, le câblage de charge et les connexions de charge sont isolés ou recouverts à l'aide des capots de sécurité fournis, de sorte qu'aucun contact accidentel avec des tensions létales ne peut se produire.

Désactivez toujours la sortie lors de la connexion ou de la déconnexion d'un équipement sur les bornes de mesure ou de sortie de l'appareil.

ATTENTION

Endommagement de l'équipement Il est conseillé de régler la fonction de protection contre les surtensions de l'instrument de manière à ce qu'elle soit légèrement plus élevée que son point de fonctionnement pendant la procédure de vérification. Vous éviterez ainsi d'endommager des équipements externes (charge électronique, amplificateur différentiel) en cas de programmation de la tension de sortie accidentellement supérieure au réglage de tension prescrit.

REMARQUE

Mettez l'appareil hors tension ou envoyez une demande de réinitialisation (Reset) après avoir terminé la procédure de vérification pour rétablir les réglages par défaut de l'instrument.

Configurations de vérification

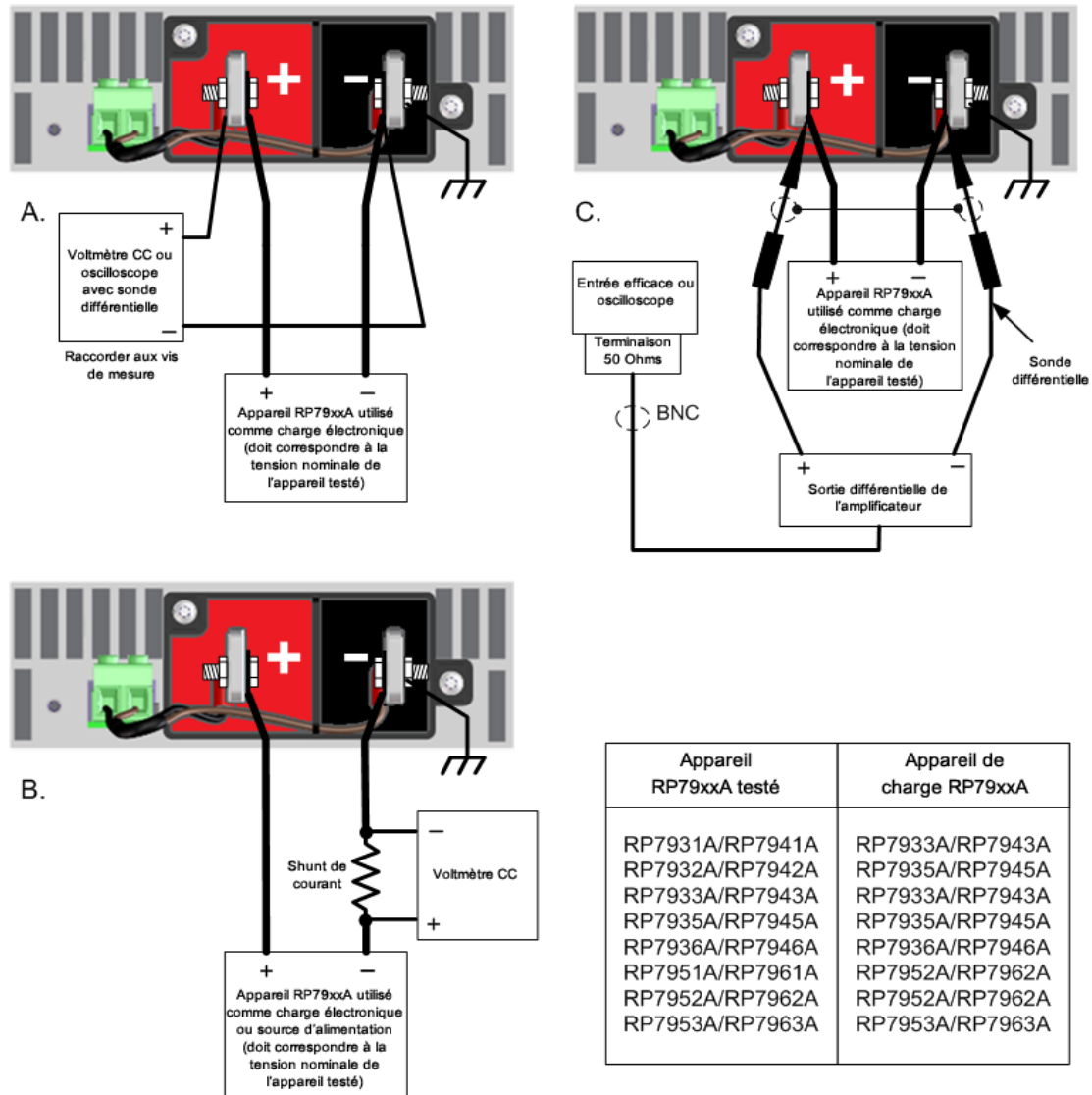

Considérations relatives aux tests

Pour des performances optimales, toutes les procédures de vérification et d'étalonnage doivent respecter ce qui suit :

- La température ambiante est stable (comprise entre 18 et 28 °C).
- L'humidité relative ambiante est inférieure à 80 %.
- Période de préchauffage de 30 minutes avant la vérification ou le réglage.
- Câbles aussi courts que possible, torsadés ou blindés pour réduire le bruit.

Procédure de vérification

Précision de programmation et de relecture de la tension

Ce test vérifie que les fonctions de programmation et de mesure de la tension sont conformes aux spécifications.

Étape 1. Éteignez l'appareil testé. Connectez uniquement le multimètre numérique aux vis de mesure (voir **Configuration de test A**). Ne connectez **PAS** l'appareil de charge RP79xxA.

Étape 2. Mettez l'appareil testé sous tension et programmez les réglages de l'instrument comme décrit dans le formulaire de relevé de test, sous « Programmation et relecture de la tension, tension minimale ». Activez la sortie. L'état de la sortie doit être « CV » (tension constante) et le courant de sortie proche de zéro.

Étape 3. Enregistrez la tension de sortie relevée sur le multimètre numérique (Vout) et la tension mesurée par l'instrument sur l'interface. Les mesures doivent être comprises dans les limites spécifiées dans le formulaire de relevé de test pour le modèle souhaité, sous « Programmation et relecture de la tension, tension minimale ».

AVERTISSEMENT

Le prochain palier applique la tension de sortie totale de l'appareil testé à la sortie.

Étape 4. Programmez les réglages de l'instrument comme décrit dans le formulaire de relevé de test, sous « Programmation et relecture de la tension, haute tension ».

Étape 5. Enregistrez la tension de sortie relevée sur le multimètre numérique (Vout) et la tension mesurée par l'instrument sur l'interface. Les mesures doivent être comprises dans les limites spécifiées dans le formulaire de relevé de test pour le modèle souhaité, sous « Programmation et relecture de la tension, haute tension ».

Effet de charge de tension constante

Ce test mesure la variation de la tension résultant d'une modification du courant d'une charge pleine à une charge nulle.

Étape 1. Éteignez l'appareil testé. Connectez le multimètre numérique aux vis de mesure et branchez l'appareil de charge RP79xxA. Assurez-vous que la tension nominale de la charge RP79xxA correspond à la tension nominale de l'appareil testé. (Voir **Configuration de test A**).

Étape 2. Mettez l'appareil testé sous tension et programmez les réglages de l'instrument comme décrit dans le formulaire de relevé de test, sous « Effet de charge de tension constante ». Activez la sortie.

Étape 3. Réglez la charge RP79xxA du courant de sortie comme décrit dans le formulaire de relevé de test, sous « Effet de charge de tension constante ». Activez la sortie. L'état de sortie de l'appareil testé doit être « CV » (tension constante). Si tel n'est pas le cas, réglez la charge afin que le courant de sortie diminue sensiblement.

Étape 4. Relevez la mesure de tension de sortie sur le multimètre numérique.

6 Vérification et étalonnage

Étape 5. Désactivez la sortie de la charge RP79xxA. Relevez à nouveau la valeur de tension sur le multimètre numérique. La différence entre les mesures du multimètre aux étapes 4 et 5 est l'effet de charge, qui ne doit pas dépasser la valeur indiquée dans le formulaire de relevé de test du modèle souhaité, sous « Effet de charge de tension constante ».

Ondulation et bruit de tension constante

Les variations périodiques et aléatoires de la sortie sont combinées pour produire une tension CA résiduelle superposée à la tension de sortie CC. Cette tension résiduelle est spécifiée en tant que bruit efficace vrai ou crête à crête dans la plage de fréquence indiquée (voir les spécifications de **RP793xA**, **RP794xA** et de **RP795xA**, **RP796xA**).

Étape 1. Éteignez l'appareil testé. Connectez l'appareil de charge RP79xx, l'amplificateur différentiel et un oscilloscope (couplé en courant alternatif) à la sortie (voir **Configuration de test C**). Assurez-vous que la tension nominale de la charge RP79xxA correspond à la tension nominale de l'appareil testé.

Étape 2. Comme illustré dans le schéma, utilisez les sondes différentielles pour brancher l'amplificateur différentiel aux bornes de sortie + et -. Les blindages des deux sondes doivent être reliés ensemble. Branchez la sortie à l'amplificateur différentiel à l'oscilloscope à l'aide d'une terminaison de 50 Ω à l'entrée de l'oscilloscope.

Étape 3. Pour les modèles RP795xA, RP796xA, réglez la sonde sur 1:100 et réglez les entrées de l'amplificateur différentiel en fonction du réglage de la sonde. Pour les modèles RP794xA, RP795xA, réglez la sonde sur 1:10 et réglez les entrées de l'amplificateur différentiel en fonction du réglage de la sonde. Réglez les entrées sur le couplage CA. Réglez la résistance d'entrée sur 1 M Ω . Réglez la base de temps de l'oscilloscope à 5 ms/div, et l'échelle verticale à la sensibilité maximale sans couper le signal. Activez la limite de bande passante (habituellement 20 MHz) et réglez le mode d'échantillonnage sur la détection de crête.

Étape 4. Mettez le système d'alimentation sous tension et programmez les réglages de l'instrument comme décrit dans le formulaire de relevé de test, sous « Ondulation et bruit de tension constante ». Activez la sortie. Programmez la charge RP79xxA comme indiquée sur la carte de relevé de test et activez la sortie. Laissez l'oscilloscope fonctionner pendant quelques secondes pour générer une quantité suffisante de points de mesure. Sur l'oscilloscope Keysight Infiniium, la mesure de tension crête à crête maximale est indiquée dans la partie inférieure droite de l'écran. Le résultat ne doit pas dépasser les limites crête à crête dans le formulaire de relevé de test, sous « Ondulation et bruit de tension constante, crête à crête ».

REMARQUE Si la mesure contient des points d'interrogation, effacez-la et réessayez. Cela signifie que certaines données d'oscilloscope reçues étaient suspectes.

Étape 5. Débranchez l'oscilloscope et branchez à la place un voltmètre efficace. Ne déconnectez pas la terminaison de 50 ohms. Divisez la mesure du voltmètre efficace en fonction du réglage de l'amplificateur différentiel. Le résultat ne devrait pas dépasser les limites efficaces dans le formulaire de relevé de test du modèle souhaité, sous « Ondulation et bruit de tension constante, valeur efficace vraie ».

Temps de récupération au transitoire

Ce test mesure le temps nécessaire à la récupération de la tension de sortie conformément à la valeur spécifiée suite à une variation de 50 % du courant de charge nominal de l'instrument.

Étape 1. Éteignez l'appareil testé. Branchez un oscilloscope équipé de la sonde indiquée aux bornes de mesure (voir **Configuration de test A**). Branchez un appareil de charge RP79xxA aux bornes de sortie. Assurez-vous que la tension nominale de la charge RP79xxA correspond à la tension nominale de l'appareil testé.

Étape 2. Mettez le système d'alimentation sous tension et programmez les réglages de l'instrument comme décrit dans le formulaire de relevé de test, sous « Réponse transitoire ».

Étape 3. Réglez le générateur de liste des charges RP79xxA pour générer un signal de courant de 100 Hz avec un rapport cyclique de 50%. Les commandes suivantes permettent de programmer la liste :

FUNC:CURR : indique la priorité de courant

VOLT:LIM MAX : indique la limite de tension

CURR:MODE LIST : indique la priorité de courant

LIST:CURR, <valeur_faible>, <valeur_élevée> : se rapporte à la carte de relevé de test pour les valeurs de courant faible et élevée.

LIST:DWEL 0.005, 0.005 : indique un signal de courant de 100 Hz avec un rapport cyclique de 50%.

LIST:COUN INF : règle le nombre de listes sur infini.

INIT:TRAN : initie le système transitoire

TRIG:TRAN : déclenche le système transitoire

OUTP:ON : active la charge

Étape 4. Réglez l'oscilloscope pour un signal similaire à celui qui est illustré dans la figure suivante.

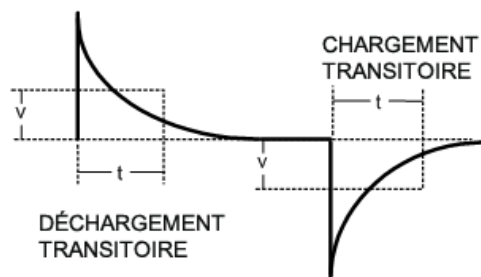

Étape 5. La tension de sortie doit retourner aux limites de tension spécifiées au moment indiqué après la variation de charge. Vérifiez le chargement et le déchargement des transitoires en les déclenchant sur la pente positive et négative. Enregistrez la tension au temps « t » dans le formulaire de relevé de test des performances, sous « Réponse transitoire ».

Précision de programmation et de relecture du courant

Ce test vérifie que les fonctions de programmation et de mesure du courant sont conformes aux spécifications.

Étape 1. Éteignez l'appareil testé. Connectez le shunt de courant directement aux bornes de sortie. Branchez le multimètre numérique directement au shunt de courant (voir **Configuration de test B**). Notez que la charge RP79xxA n'est pas utilisée dans cette partie du test.

6 Vérification et étalonnage

Étape 2. Mettez le système d'alimentation sous tension et programmez les réglages de l'instrument comme décrit dans le formulaire de relevé de test, sous « Programmation et relecture du courant, courant minimal ». L'état de la sortie doit être « CC » et la tension de sortie doit être proche de zéro. Patientez 5 minutes jusqu'à la stabilisation de la température.

Étape 3. Divisez la chute de tension (mesure du multimètre numérique) au shunt de courant par la résistance de shunt pour convertir la mesure en ampères et enregistrez cette valeur. (Iout). Enregistrez également le courant mesuré par l'instrument sur l'interface. Les mesures doivent être comprises dans les limites spécifiées dans le formulaire de relevé de test, sous « Programmation et relecture du courant, courant minimal ».

Étape 4. Programmez les réglages de l'instrument comme décrit dans le formulaire de relevé de test, sous « Programmation et relecture du courant, courant élevé ». Patientez 5 minutes jusqu'à la stabilisation de la température.

Étape 5. Divisez la chute de tension (mesure du multimètre numérique) au shunt de courant par la résistance de shunt pour convertir la mesure en ampères et enregistrez cette valeur. (Iout). Enregistrez également la valeur de courant mesurée par l'instrument sur l'interface. Les mesures doivent être comprises dans les limites spécifiées dans le formulaire de relevé de test, sous « Programmation et relecture du courant, courant élevé ».

Effet de charge de courant constant

Ce test mesure la variation du courant résultant d'une modification de la tension d'un court-circuit à une pleine échelle.

Étape 1. Éteignez l'appareil testé. Connectez le shunt de courant directement aux bornes de sortie. Branchez le multimètre numérique directement au shunt de courant (voir [Configuration de test B](#)).

Étape 2. Mettez l'appareil testé sous tension et programmez les réglages de l'instrument comme décrit dans le relevé de test, sous « Effet de charge de courant constant ». L'état de la sortie doit être « CC » (courant constant) et la tension de sortie doit être proche de zéro. Patientez 5 minutes jusqu'à la stabilisation de la température.

Étape 3. Divisez la chute de tension (mesure du multimètre numérique) au shunt de courant par la résistance de shunt pour convertir la mesure en ampères et enregistrez cette valeur.

Étape 4. Éteignez l'appareil testé et connectez l'appareil de charge RP79xxA entre le shunt de courant et les bornes de sortie (voir [Configuration de test B](#)). Assurez-vous que la tension nominale de la charge RP79xxA correspond à la tension nominale de l'appareil testé.

Étape 5. Réglez la charge RP79xxA en mode de priorité de tension et programmez-la sur la tension comme décrit dans le formulaire de relevé de test, sous « Effet de charge de courant constant ». Activez la sortie de la charge.

Étape 6. Programmez l'appareil testé avec les réglages comme décrit dans le relevé de test, sous « Effet de charge de courant constant ». Activez la sortie de l'appareil testé. L'état de la sortie doit être « CC » (courant constant). Si tel n'est pas le cas, réglez la charge afin que la tension de sortie diminue sensiblement.

Étape 7. Divisez la chute de tension (mesure du multimètre numérique) au shunt de courant par la résistance de shunt pour convertir la mesure en ampères et enregistrez cette valeur. La différence entre la mesure de courant à l'étape 3 est l'effet de charge, qui ne doit pas dépasser la valeur indiquée dans le formulaire de relevé de test du modèle souhaité, sous « Effet de charge de courant constant ».

Vérification de la capacité d'absorption de courant

Ce test vérifie la capacité d'absorption de l'alimentation jusqu'à 100% de son courant de sortie nominal.

Étape 1. Éteignez l'appareil testé et connectez le RP79xxA comme source externe aux bornes de sortie + et - (voir **Configuration de test C**). Assurez-vous que la tension nominale de la source RP79xxA correspond à la tension nominale de l'appareil testé.

Étape 2. Réglez la source externe RP79xxA comme suit : Réglage de tension = 50 % de la tension de sortie nominale de l'appareil testé. Valeur limite de courant = 110% du courant de sortie nominal de l'appareil testé.

Étape 3. Mettez l'appareil testé sous tension. Réglez le mode de fonctionnement sur la priorité de courant. Programmez les réglages de l'instrument comme décrit dans le formulaire de relevé de test, sous « Vérification de l'absorption de courant ».

Étape 4. Vérifiez sur l'affichage du panneau avant de la source RP79xxA et que l'alimentation est absorbée à 100% de son courant nominal. Divisez la chute de tension (mesure du multimètre numérique) au shunt de courant par la résistance de shunt pour convertir la mesure en ampères et enregistrez cette valeur. Les mesures doivent être comprises dans les limites spécifiées dans le formulaire de relevé de test, sous « Tests d'absorption du courant ».

Étalonnage de l'instrument

Introduction

Fréquence de l'étalonnage

Configurations d'étalonnage

Considérations relatives aux tests

Accéder au mode d'étalonnage

Étalonnage de la tension

Étalonnage du coefficient de température de courant - RP793xA, RP794xA

Étalonnage du courant

Étalonnage du partage de courant - RP795xA, RP796xA

Étalonnage de sortie inférieure de la résistance - RP795xA, RP796xA

Saisir une date d'étalonnage

Enregistrer l'étalonnage et se déconnecter

Introduction

AVERTISSEMENT

RISQUE D'ÉLECTROCUTION, TENSION LÉTALES De nombreux modèles génèrent des tensions supérieures à 60 V CC, certains modèles ayant une tension nominale de 950 V CC ! Assurez-vous que toutes les connexions des instruments, le câblage de charge et les connexions de charge sont isolés ou recouverts à l'aide des capots de sécurité fournis, de sorte qu'aucun contact accidentel avec des tensions létales ne peut se produire.

L'instrument utilise une méthode d'étalonnage électronique en boîtier fermé ; aucun réglage mécanique interne n'est nécessaire. L'instrument calcule les facteurs de correction selon les valeurs de référence en entrée que vous configurez et enregistre ces facteurs en mémoire non volatile jusqu'à l'étalonnage suivant. L'extinction de l'instrument ou la fonction *RST ne modifie pas cette mémoire d'étalonnage EEPROM.

Pour une liste des configurations d'équipement et de test nécessaires à l'étalonnage, reportez-vous à la section **Équipement et configurations de test recommandés**. Pour plus d'informations sur la connexion du voltmètre, le shunt de courant et la charge, reportez-vous également à la section **Configurations de mesure**. Vous trouverez ci-dessous plus d'informations sur la procédure d'étalonnage.

- Le mot de passe approprié est nécessaire pour accéder au menu Admin, qui contient la fonction d'étalonnage. Ce mot de passe est prédéfini à 0 (zéro). Vous pouvez modifier le mot de passe une fois le mode d'étalonnage activé pour empêcher tout accès non autorisé au mode d'étalonnage.

Pour plus d'informations, reportez-vous à la section **Protection par mot de passe**.

- Lors de l'étalonnage de l'appareil à l'aide des commandes SCPI, la plupart des étapes impliquent l'envoi d'une requête *OPC? afin de le synchroniser avec l'exécution de la commande du bloc d'alimentation avant de continuer. La réponse de l'instrument doit être lue chaque fois que la commande *OPC? est donnée. À certaines étapes, la commande *OPC? peut mettre jusqu'à 30 secondes à répondre.
- Une fois la procédure d'étalonnage lancée, vous devez effectuer l'étalonnage dans son intégralité. Lorsqu'une section d'étalonnage est terminée, l'instrument calcule les nouvelles constantes d'étalonnage et commence à les utiliser. Cependant, ces constantes ne sont pas enregistrées dans la mémoire non volatile tant qu'une commande SAVE n'est pas explicitement donnée.
- Quittez le mode d'étalonnage en vous déconnectant du menu Admin ou en envoyant la commande CAL:STAT OFF. Notez que toute section d'étalonnage ayant été étalonnée sans avoir été enregistrée retourne à ses constantes d'étalonnage précédentes.

Fréquence de l'étalonnage

Intervalle d'étalonnage d'un an

L'instrument doit être étalonné à intervalles réguliers, qui varient selon la précision nécessaire à votre application. Un intervalle d'**un an** convient à la plupart des applications. Les spécifications de précision sont garanties uniquement si l'étalonnage est effectué régulièrement. Au-delà d'un an, les spécifications de précision publiées ne sont plus garanties.

Intervalle d'étalonnage de trois ans

Les spécifications de précision de programmation et de mesure de la tension et du courant peuvent être étendues à un intervalle d'étalonnage d'une période de trois ans en multipliant (ou en augmentant) par trois les spécifications de précision d'étalonnage d'un an présentées dans les **Formulaires de relevé de test** de vérification.

Configurations d'étalonnage

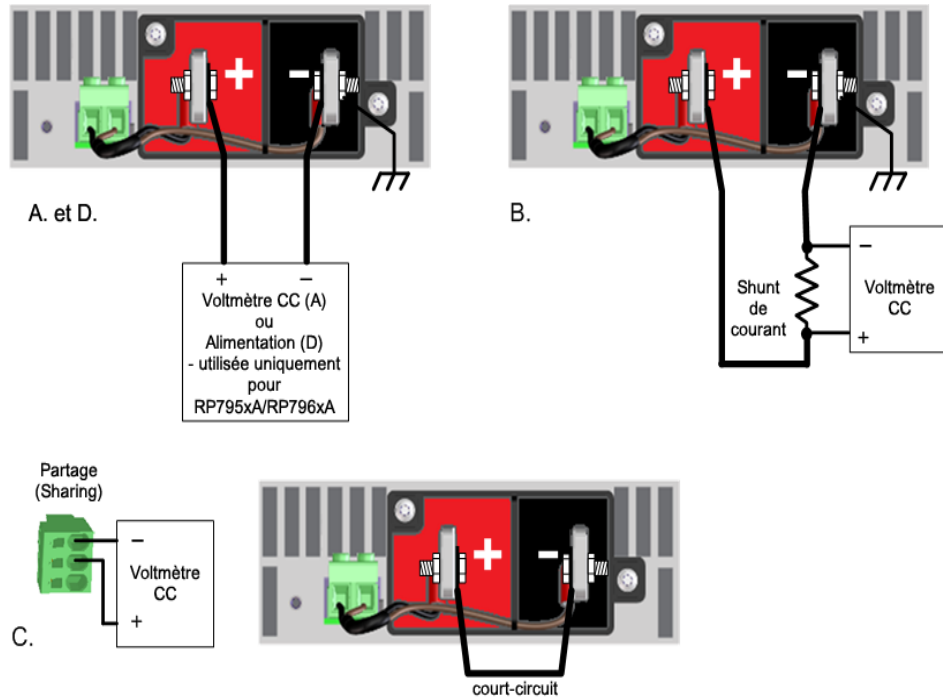

Considérations relatives aux tests

Pour des performances optimales, toutes les procédures de vérification et d'étalonnage doivent respecter ce qui suit :

- La température ambiante est stable (comprise entre 18 et 28 °C).
- L'humidité relative ambiante est inférieure à 80 %.
- Période de préchauffage de 30 minutes avant la vérification ou le réglage.
- Câbles aussi courts que possible, torsadés ou blindés pour réduire le bruit.

Procédure d'étalonnage

Accéder au mode d'étalonnage

Aide-mémoire des menus du panneau avant	Commande SCPI
Sélectionnez System\Admin>Login . Saisissez votre mot de passe dans le champ Password (Mot de passe). Appuyez ensuite sur Select .	CAL:STAT ON < motdepasse >

Étalonnage de la tension

Programmation et mesure de la tension

Étape 1. Connectez l'entrée de tension du multimètre numérique Keysight 3458A à la sortie (voir [Configuration d'étalonnage A](#)).

Étape 2. Sélectionnez l'étalonnage de programmation et de mesure de la tension.

Aide-mémoire des menus du panneau avant	Commande SCPI
Sélectionnez System\Admin\CAL\Vprog . Vérifiez que le voltmètre est branché, puis sélectionnez Next.	Spécifiez la plage de tension à pleine échelle. Les plages de pleine échelle varient en fonction du modèle. La plage de 500 V est alors sélectionnée : CAL:VOLT 500

Étape 3. Sélectionnez le premier point d'étalonnage de tension. Mesurez la tension de sortie à l'aide du multimètre numérique et saisissez les données.

Aide-mémoire des menus du panneau avant	Commande SCPI
Le message suivant s'affiche à l'écran : "Enter P1 measured data" (« Saisir les données mesurées P1 »). Saisissez les données du multimètre numérique externe. Appuyez sur Enter une fois l'opération terminée.	CAL:LEV P1 *OPC? CAL:DATA <données>

AVERTISSEMENT

Le prochain palier applique la tension de sortie totale de l'appareil testé à la sortie.

Étape 4. Sélectionnez le deuxième point d'étalonnage de tension. Mesurez la tension de sortie à l'aide du multimètre numérique et saisissez les données.

Aide-mémoire des menus du panneau avant	Commande SCPI
Le message suivant s'affiche à l'écran : "Enter P2 measured data" (« Saisir les données mesurées P2 »). Saisissez les données du multimètre numérique externe. Appuyez sur Enter une fois l'opération terminée. Appuyez sur Back pour terminer.	CAL:LEV P2 *OPC? CAL:DATA <données>

Étalonnage du coefficient de température de courant RP793xA, RP794xA

REMARQUE

La procédure d'étalonnage du coefficient de température doit être effectuée **avant** toute autre procédure d'étalonnage du courant.

Étape 1. Branchez une résistance de shunt de précision à la sortie. La résistance de shunt doit pouvoir mesurer le courant à **pleine échelle** (voir [Configuration d'étalonnage B](#)). Branchez le multimètre numérique Keysight 3458A à la résistance de shunt.

Étape 2. Sélectionnez l'étalonnage du coefficient de température.

6 Vérification et étalonnage

Aide-mémoire des menus du panneau avant	Commande SCPI
Sélectionnez System\Admin\Cal\Misc\CurrTC .	CAL:CURR:TC
Vérifiez que le shunt est raccordé, puis sélectionnez Next.	

Étape 3. Sélectionnez le premier point d'étalonnage de courant. Patientez 5 minutes jusqu'à la stabilisation de la température. Calculez le courant de shunt ($I=V/R$) et saisissez les données.

Aide-mémoire des menus du panneau avant	Commande SCPI
Le message suivant s'affiche à l'écran : "Enter P1 measured data" (« Saisir les données mesurées P1 »). Ce dernier doit correspondre à environ 50 % du courant nominal à pleine échelle. Appuyez sur Enter une fois l'opération terminée.	CAL:LEV P1 *OPC? CAL:DATA < données >

Étape 4. Sélectionnez le deuxième point d'étalonnage de courant. Patientez 5 minutes jusqu'à la stabilisation de la température. Calculez le courant de shunt ($I=V/R$) et saisissez les données.

Aide-mémoire des menus du panneau avant	Commande SCPI
Le message suivant s'affiche à l'écran : "Enter P2 measured data" (« Saisir les données mesurées P2 »). Saisissez les données du multimètre numérique externe. Ce dernier doit correspondre à environ 80 % du courant nominal à pleine échelle. Appuyez sur Enter une fois l'opération terminée.	CAL:LEV P2 *OPC? CAL:DATA < données >

Étape 5. Sélectionnez le troisième point d'étalonnage du courant. Patientez 5 minutes jusqu'à la stabilisation de la température. Calculez le courant de shunt ($I=V/R$) et saisissez les données.

Aide-mémoire des menus du panneau avant	Commande SCPI
Le message suivant s'affiche à l'écran : « Enter P3 measured data » (« Saisir les données mesurées P3 »). Saisissez les données du multimètre numérique externe. Ce dernier doit correspondre à environ 100 % du courant nominal à pleine échelle. Appuyez sur Enter une fois l'opération terminée. Appuyez sur Back pour terminer.	CAL:LEV P3 *OPC? CAL:DATA < données >

Étalonnage du courant

Programmation et mesure du courant

Étape 1. Débranchez tous les équipements des bornes de sortie.

Étape 2. Sélectionnez l'étalonnage de programmation et de mesure du courant.

Aide-mémoire des menus du panneau avant	Commande SCPI
Sélectionnez System\Admin\Cal\Curr\Iprog .	Spécifiez la plage de courant à pleine échelle. Les plages de pleine échelle varient en fonction du modèle. La plage de 20 A est alors sélectionnée :
Vérifiez qu'aucun élément n'est connecté à la sortie, puis sélectionnez Next.	CAL:CURR 20

Étape 3. Patientez 5 minutes jusqu'à la stabilisation de la température. Sélectionnez le premier point d'étalonnage de courant.

Aide-mémoire des menus du panneau avant	Commande SCPI
---	---------------

Patientez 5 minutes, puis sélectionnez à nouveau sur Next. **CAL:LEV P1**
***OPC?**

Étape 4. Branchez une résistance de shunt de précision à la sortie. La résistance de shunt doit pouvoir mesurer au moins 70 % du courant à pleine échelle de la sortie (voir **Configuration d'étalonnage B**). Branchez le multimètre numérique Keysight 3458A à la résistance de shunt.

Aide-mémoire des menus du panneau avant	Commande SCPI
---	---------------

Vérifiez que le shunt est raccordé, puis sélectionnez Next. **Sans objet**

Étape 5. Sélectionnez le deuxième point d'étalonnage de courant. Patientez 5 minutes jusqu'à la stabilisation de la température. Calculez le courant de shunt ($I=V/R$) et saisissez les données.

Aide-mémoire des menus du panneau avant	Commande SCPI
---	---------------

Le message suivant s'affiche à l'écran : "Enter P2 measured data" (« Saisir les données mesurées P2 »). Saisissez les données du multimètre numérique externe. Ce dernier doit correspondre à environ 70 % du courant nominal à pleine échelle. Appuyez sur Enter une fois l'opération terminée. Appuyez sur Back pour terminer.

CAL:LEV P2
***OPC?**
CAL:DATA <données>

Étalonnage du partage de courant RP795xA, RP796xA

Cette procédure permet d'étalonner le signal Imon qui est utilisé lorsque les appareils sont connectés en parallèle.

Étape 1. Branchez un fil aux bornes de sortie + et -. Connectez les broches 2 et 3 du multimètre numérique Keysight 3458A du connecteur de partage (voir **Configuration d'étalonnage C**).

Étape 2. Sélectionnez l'étalonnage de partage du courant.

Aide-mémoire des menus du panneau avant	Commande SCPI
---	---------------

Sélectionnez **System\Admin\CAL\Misc\CurrShar**. **CAL:CURR:SHAR**

Vérifiez que le fil est branché, puis sélectionnez Next.

Étape 3. Sélectionnez le premier point d'étalonnage. Mesurez la tension sur le connecteur de partage et saisissez les données.

Aide-mémoire des menus du panneau avant	Commande SCPI
---	---------------

Le message suivant s'affiche à l'écran : "Enter P1 measured data" (« Saisir les données mesurées P1 »). Saisissez les données du voltmètre numérique externe. Ces dernières doivent correspondre à environ 1 volt. Appuyez sur Enter une fois l'opération terminée. Appuyez sur Back pour terminer.

CAL:LEV P1
*OPC?
CAL:DATA <données>

Étape 4. Une fois l'étalonnage terminé, débranchez le voltmètre et le fil.

Étalonnage de sortie inférieure de la résistance RP795xA, RP796xA

Cette procédure permet d'étalonner la tension minimale pouvant être atteinte pendant l'absorption du courant.

Étape 1. Branchez un bloc d'alimentation externe aux bornes de sortie + et - (voir [Configuration d'étalonnage D](#)).

Étape 2. Réglez l'alimentation externe comme suit : Réglage de la tension = $(0,9\text{ V} + 0,08 * \text{tension de sortie maximale de l'appareil testé})$. La tension doit se trouver dans la limite de 10 % de cette valeur. Limite de courant = $(0,95 * \text{courant de sortie nominal de l'appareil testé})$. La limite de courant doit se situer dans la limite de 2 % de cette valeur.

Étape 3. Sélectionnez l'étalonnage de sortie inférieur de la résistance. L'étalonnage dure environ 5 secondes.

Aide-mémoire des menus du panneau avant	Commande SCPI
Sélectionnez System\Admin\CAL\Misc\ResBout . Vérifiez que le bloc d'alimentation est branché, puis sélectionnez Next.	CAL:RES:BOUT *OPC?

Étape 4. Une fois l'étalonnage terminé, débranchez le bloc d'alimentation.

Saisir une date d'étalonnage

Aide-mémoire des menus du panneau avant	Commande SCPI
Sélectionnez System\Admin\CAL\DATE . Saisissez la date d'étalonnage dans le champ Date. Si vous le souhaitez, vous pouvez saisir des données alphanumériques dans ce champ.	CAL:DATE "<date>"

Enregistrer l'étalonnage et se déconnecter

Aide-mémoire des menus du panneau avant	Commande SCPI
Sélectionnez System\Admin\Cal\Save . Sélectionnez Save pour enregistrer toutes les données d'étalonnage.	Pour enregistrer les données d'étalonnage : CAL:SAVE
Sélectionnez System\Admin\Logout pour quitter le mode d'étalonnage.	Pour quitter le mode d'étalonnage : CAL:STAT OFF

Formulaires de relevé de test

Keysight RP7951A/RP7961A

RP7951A/RP7961A Relevé de test des performances		Numéro de rapport _____		Date _____	
Description du test	Modèle	Valeurs min. spécifiées	Résultats	Valeurs max. spécifiées	
Programmation et relecture de la tension					
Tension minimale (Vout) :	Les deux	0,43985	_____	0,56015	
Tension mesurée sur l'interface :	Les deux	Vout - 0,08015	_____	Vout + 0,08015	
Haute tension (Vout) :	Les deux	499,79	_____	500,21	
Tension mesurée sur l'interface :	Les deux	Vout - 0,230	_____	Vout + 0,230	
Effet de charge de tension constante :					
	Les deux	- 0,030	_____	+ 0,030	
Ondulation et bruit de tension constante					
Crête à crête :	Les deux	S.O.	_____	0,500	
Valeur efficace vraie :	Les deux	S.O.	_____	0,100	
Réponse transitoire à 500 µs :					
	Les deux	- 1,25	_____	+ 1,25	
Programmation et relecture du courant					
Courant minimal (Iout) :	Les deux	- 0,012	_____	0,012	
Courant mesuré sur l'interface :	Les deux	Iout - 0,012	_____	Iout + 0,012	
Courant élevé (Iout) :	Les deux	19,968	_____	20,032	
Courant mesuré sur l'interface :	Les deux	Iout - 0,032	_____	Iout + 0,032	
Effet de charge de courant constant :					
	Les deux	- 0,009	_____	+ 0,009	
Tests d'absorption de courant					
100 % du courant nominal :	Les deux	- 20,032	_____	- 19,968	
		Réglages de l'appareil testé RP7951A/RP7961A	Réglages de la charge RP7952A/RP7962A		
Programmation et relecture de la tension min. :		Priorité de tension : 0,5 V, 10,25 A	non utilisé		
Programmation et relecture de la tension élevée :		Priorité de tension : 500 V, 10,25 A	non utilisé		
Effet de charge de tension constante, ondulation et bruit de tension constante :		Priorité de tension : 250 V, 20,5 A	Priorité de courant : 255 V, -20 A		
Réponse transitoire :		Priorité de tension : 250 V, 20,5 A	Priorité de courant : 285 V, -10 à -20 A, vitesse de balayage=max		
Programmation et relecture du courant min. :		Priorité de courant : 255 V, 0 A	Priorité de tension : 250 V, 0 A		
Programmation et relecture du courant élevé :		Priorité de courant : 255 V, 20 A	Priorité de tension : 250 V, -20,5 A		
Effet de charge de courant constant :		Priorité de courant : 510 V, 10 A	Priorité de tension : 500 V, -10,25 A		
100 % du courant nominal (Isink) :		Priorité de courant : 255 V, -20 A	Priorité de tension : 250 V, -20,5 A		

Keysight RP7952A/RP7962A

RP7952A/RP7962A Relevé de test des performances		Numéro de rapport _____		Date _____	
Description du test	Modèle	Valeurs min. spécifiées	Résultats	Valeurs max. spécifiées	
Programmation et relecture de la tension					
Tension minimale (Vout) :	Les deux	0,43985	_____	0,56015	
Tension mesurée sur l'interface :	Les deux	Vout - 0,08015	_____	Vout + 0,08015	
Haute tension (Vout) :	Les deux	499,78	_____	500,21	
Tension mesurée sur l'interface :	Les deux	Vout - 0,230	_____	Vout + 0,230	
Effet de charge de tension constante :					
	Les deux	- 0,030	_____	+ 0,030	
Ondulation et bruit de tension constante					
Crête à crête :	Les deux	S.O.	_____	0,500	
Valeur efficace vraie :	Les deux	S.O.	_____	0,100	
Réponse transitoire à 500 µs :					
	Les deux	- 1,25	_____	+ 1,25	
Programmation et relecture du courant					
Courant minimal (Iout) :	Les deux	- 0,024	_____	0,024	
Courant mesuré sur l'interface :	Les deux	Iout - 0,024	_____	Iout + 0,024	
Courant élevé (Iout) :	Les deux	39,936	_____	40,064	
Courant mesuré sur l'interface :	Les deux	Iout - 0,064	_____	Iout + 0,064	
Effet de charge de courant constant :					
	Les deux	- 0,017	_____	+ 0,017	
Tests d'absorption de courant					
100 % du courant nominal :	Les deux	- 40,064	_____	- 39,936	
Réglages de l'appareil testé RP7952A/RP7962A			Réglages de la charge RP7952A/RP7962A		
Programmation et relecture de la tension min. :	Priorité de tension : 0,5 V, 20,5 A		non utilisé		
Programmation et relecture de la tension élevée :	Priorité de tension : 500 V, 20,5 A		non utilisé		
Effet de charge de tension constante, ondulation et bruit de tension constante :	Priorité de tension : 250 V, 41 A		Priorité de courant : 255 V, -40 A		
Réponse transitoire :	Priorité de tension : 250 V, 41 A		Priorité de courant : 285 V, -20 A à -40 A, vitesse de balayage=max		
Programmation et relecture du courant min. :	Priorité de courant : 255 V, 0 A		Priorité de tension : 250 V, 0 A		
Programmation et relecture du courant élevé :	Priorité de courant : 255 V, 40 A		Priorité de tension : 250 V, -41 A		
Effet de charge de courant constant :	Priorité de courant : 510 V, 20 A		Priorité de tension : 500 V, -20,5 A		
100 % du courant nominal (Isink) :	Priorité de courant : 255 V, - 40 A		Priorité de tension : 250 V, -41 A		

Keysight RP7953A/RP7963A

RP7953A/RP7963A Relevé de test des performances		Numéro de rapport _____		Date _____	
Description du test	Modèle	Valeurs min. spécifiées	Résultats	Valeurs max. spécifiées	
Programmation et relecture de la tension					
Tension minimale (Vout) :	Les deux	0,8797	_____	1,1203	
Tension mesurée sur l'interface :	Les deux	Vout - 0,1603	_____	Vout + 0,1603	
Haute tension (Vout) : *	Les deux	949,595	_____	950,405	
Tension mesurée sur l'interface :	Les deux	Vout - 0,445	_____	Vout + 0,445	
Effet de charge de tension constante :					
	Les deux	- 0,060	_____	+ 0,060	
Ondulation et bruit de tension constante					
Crête à crête :	Les deux	S.O.	_____	1,000	
Valeur efficace vraie :	Les deux	S.O.	_____	0,200	
Réponse transitoire à 500 µs :					
	Les deux	- 2,375	_____	+ 2,375	
Programmation et relecture du courant					
Courant minimal (Iout) :	Les deux	- 0,012	_____	0,012	
Courant mesuré sur l'interface :	Les deux	Iout - 0,012	_____	Iout + 0,012	
Courant élevé (Iout) :	Les deux	19,968	_____	20,032	
Courant mesuré sur l'interface :	Les deux	Iout - 0,032	_____	Iout + 0,032	
Effet de charge de courant constant :					
	Les deux	- 0,009	_____	+ 0,009	
Tests d'absorption de courant					
100 % du courant nominal :	Les deux	- 20,032	_____	- 19,968	
		Réglages de l'appareil testé RP7953A/RP7963A	Réglages de la charge RP7953A/RP7963A		
Programmation et relecture de la tension min. :		Priorité de tension : 1,0 V, 10,75 A	non utilisé		
Programmation et relecture de la tension élevée :		Priorité de tension : 950 V, 10,75 A	non utilisé		
Effet de charge de tension constante, ondulation et bruit de tension constante :		Priorité de tension : 500 V, 20,5 A	Priorité de courant : 510 V, -20 A		
Réponse transitoire :		Priorité de tension : 500 V, 20,5 A	Priorité de courant : 570 V, -10 A à -20 A, vitesse de balayage=max		
Programmation et relecture du courant min. :		Priorité de courant : 510 V, 0 A	Priorité de tension : 500 V, 0 A		
Programmation et relecture du courant élevé :		Priorité de courant : 510 V, 20 A	Priorité de tension : 500 V, -20,5 A		
Effet de charge de courant constant :		Priorité de courant : 969 V, 10 A	Priorité de tension : 950 V, -10,75 A		
100 % du courant nominal (Isink) :		Priorité de courant : 510 V, - 20 A	Priorité de tension : 500 V, -20,5 A		

Keysight RP7931A/RP7941A

RP7931A/RP7941A Relevé de test des performances		Numéro de rapport _____		Date _____	
Description du test	Modèle	Valeurs min. spécifiées	Résultats	Valeurs max. spécifiées	
Programmation et relecture de la tension					
Tension minimale (Vout) :	Les deux	0,017996	_____	0,022004	
Tension mesurée sur l'interface :	Les deux	Vout - 0,002004	_____	Vout + 0,002004	
Haute tension (Vout) :	Les deux	19,994	_____	20,006	
Tension mesurée sur l'interface :	Les deux	Vout - 0,006	_____	Vout + 0,006	
Effet de charge de tension constante :					
	Les deux	- 0,001	_____	+ 0,001	
Ondulation et bruit de tension constante					
Crête à crête :	Les deux	S.O.	_____	0,030	
Valeur efficace vraie :	Les deux	S.O.	_____	0,003	
Réponse transitoire à 300 µs :					
	Les deux	- 0,20	_____	+ 0,20	
Programmation et relecture du courant					
Courant minimal (Iout) :	Les deux	- 0,045	_____	0,045	
Courant mesuré sur l'interface :	Les deux	Iout - 0,045	_____	Iout + 0,045	
Courant élevé (Iout) :	Les deux	399,795	_____	400,205	
Courant mesuré sur l'interface :	Les deux	Iout - 0,205	_____	Iout + 0,205	
Effet de charge de courant constant :					
	Les deux	- 0,025	_____	+ 0,025	
Tests d'absorption de courant					
100 % du courant nominal :	Les deux	- 399,795	_____	- 400,205	
Réglages de l'appareil testé RP7931A/RP7941A			Réglages de la charge RP7933A/RP7943A		
Programmation et relecture de la tension min. :	Priorité de tension : 0,02 V, 204 A		non utilisé		
Programmation et relecture de la tension élevée :	Priorité de tension : 20 V, 204 A		non utilisé		
Effet de charge de tension constante, ondulation et bruit de tension constante :	Priorité de tension : 10 V, 408 A		Priorité de courant : 10,2 V, -400 A		
Réponse transitoire :	Priorité de tension : 10 V, 408 A		Priorité de courant : 15 V, -160 A à -360 A, vitesse de balayage=5 A/µs		
Programmation et relecture du courant min. :	Priorité de courant : 10,2 V, 0 A		Priorité de tension : 10 V, 0 A		
Programmation et relecture du courant élevé :	Priorité de courant : 10,2 V, 400 A		Priorité de tension : 10 V, -408 A		
Effet de charge de courant constant :	Priorité de courant : 20,4 V, 200 A		Priorité de tension : 20 V, -204 A		
100 % du courant nominal (Isink) :	Priorité de courant : 10,2 V, - 400 A		Priorité de tension : 10 V, -408 A		

Keysight RP7932A/RP7942A

RP7932A/RP7942A Relevé de test des performances		Numéro de rapport _____		Date _____	
Description du test	Modèle	Valeurs min. spécifiées	Résultats	Valeurs max. spécifiées	
Programmation et relecture de la tension					
Tension minimale (Vout) :	Les deux	0,071984	_____	0,088016	
Tension mesurée sur l'interface :	Les deux	Vout - 0,008016	_____	Vout + 0,008016	
Haute tension (Vout) :	Les deux	79,976	_____	80,024	
Tension mesurée sur l'interface :	Les deux	Vout - 0,024	_____	Vout + 0,024	
Effet de charge de tension constante :					
	Les deux	- 0,003	_____	+ 0,003	
Ondulation et bruit de tension constante					
Crête à crête :	Les deux	S.O.	_____	0,080	
Valeur efficace vraie :	Les deux	S.O.	_____	0,008	
Réponse transitoire à 300 µs :					
	Les deux	- 0,80	_____	+ 0,80	
Programmation et relecture du courant					
Courant minimal (Iout) :	Les deux	- 0,013	_____	0,013	
Courant mesuré sur l'interface :	Les deux	Iout - 0,013	_____	Iout + 0,013	
Courant élevé (Iout) :	Les deux	124,9495	_____	125,0505	
Courant mesuré sur l'interface :	Les deux	Iout - 0,0505	_____	Iout + 0,0505	
Effet de charge de courant constant :					
	Les deux	- 0,013	_____	+ 0,013	
Tests d'absorption de courant					
100 % du courant nominal :	Les deux	- 124,9495	_____	- 125,0505	
Réglages de l'appareil testé RP7932A/RP7942A			Réglages de la charge RP7935A/RP7945A		
Programmation et relecture de la tension min. :	Priorité de tension : 0,08 V, 63,75 A		non utilisé		
	Priorité de tension : 80 V, 63,75 A		non utilisé		
Programmation et relecture de la tension élevée :	Priorité de tension : 40 V, 127,5 A		Priorité de courant : 40,4 V, -125 A		
	Priorité de tension : 40 V, 127,5 A		Priorité de courant : 60 V, -50 A à -112,5 A, vitesse de balayage=2 A/µs		
Effet de charge de tension constante, ondulation et bruit de tension constante :	Priorité de courant : 40,4 V, 0 A		Priorité de tension : 40 V, 0 A		
Réponse transitoire :	Priorité de courant : 80,8 V, 62,5 A		Priorité de tension : 40 V, -127,5 A		
Programmation et relecture du courant min. :	Priorité de courant : 40,4 V, - 125 A		Priorité de tension : 80 V, -63,75 A		
Programmation et relecture du courant élevé :			Priorité de tension : 40 V, -127,5 A		
Effet de charge de courant constant :					
100 % du courant nominal (Isink) :					

Keysight RP7933A/RP7943A

RP7933A/RP7943A Relevé de test des performances		Numéro de rapport _____		Date _____	
Description du test	Modèle	Valeurs min. spécifiées	Résultats	Valeurs max. spécifiées	
Programmation et relecture de la tension					
Tension minimale (Vout) :	Les deux	0,017996	_____	0,022004	
Tension mesurée sur l'interface :	Les deux	Vout - 0,002004	_____	Vout + 0,002004	
Haute tension (Vout) :	Les deux	19,994	_____	20,006	
Tension mesurée sur l'interface :	Les deux	Vout - 0,006	_____	Vout + 0,006	
Effet de charge de tension constante :					
	Les deux	- 0,001	_____	+ 0,001	
Ondulation et bruit de tension constante					
Crête à crête :	Les deux	S.O.	_____	0,030	
Valeur efficace vraie :	Les deux	S.O.	_____	0,003	
Réponse transitoire à 300 µs :					
	Les deux	- 0,2	_____	+ 0,2	
Programmation et relecture du courant					
Courant minimal (Iout) :	Les deux	- 0,090	_____	0,090	
Courant mesuré sur l'interface :	Les deux	Iout - 0,090	_____	Iout + 0,090	
Courant élevé (Iout) :	Les deux	799,59	_____	800,41	
Courant mesuré sur l'interface :	Les deux	Iout - 0,41	_____	Iout + 0,41	
Effet de charge de courant constant :					
	Les deux	- 0,050	_____	+ 0,050	
Tests d'absorption de courant					
100 % du courant nominal :	Les deux	- 799,59	_____	- 800,41	
Réglages de l'appareil testé RP7933A/RP7943A			Réglages de la charge RP7933A/RP7943A		
Programmation et relecture de la tension min. :	Priorité de tension : 0,02 V, 408 A		non utilisé		
Programmation et relecture de la tension élevée :	Priorité de tension : 20 V, 408 A		non utilisé		
Effet de charge de tension constante, ondulation et bruit de tension constante :	Priorité de tension : 10 V, 816 A		Priorité de courant : 10,2 V, -800 A		
Réponse transitoire :	Priorité de tension : 10 V, 816 A		Priorité de courant : 15 V, -320 A à -720 A, vitesse de balayage=10 A/µs		
Programmation et relecture du courant min. :	Priorité de courant : 10,2 V, 0 A		Priorité de tension : 10 V, 0 A		
Programmation et relecture du courant élevé :	Priorité de courant : 10,2 V, 800 A		Priorité de tension : 10 V, -816 A		
Effet de charge de courant constant :	Priorité de courant : 20,4 V, 400 A		Priorité de tension : 20 V, -408 A		
100 % du courant nominal (Isink) :	Priorité de courant : 10,2 V, - 800 A		Priorité de tension : 10 V, -816 A		

Keysight RP7935A/RP7945A

RP7935A/RP7945A Relevé de test des performances		Numéro de rapport _____		Date _____	
Description du test	Modèle	Valeurs min. spécifiées	Résultats	Valeurs max. spécifiées	
Programmation et relecture de la tension					
Tension minimale (Vout) :	Les deux	0,071984	_____	0,088016	
Tension mesurée sur l'interface :	Les deux	Vout - 0,008016	_____	Vout + 0,008016	
Haute tension (Vout) :	Les deux	79,976	_____	80,024	
Tension mesurée sur l'interface :	Les deux	Vout - 0,024	_____	Vout + 0,024	
Effet de charge de tension constante :					
	Les deux	- 0,003	_____	+ 0,003	
Ondulation et bruit de tension constante					
Crête à crête :	Les deux	S.O.	_____	0,080	
Valeur efficace vraie :	Les deux	S.O.	_____	0,008	
Réponse transitoire à 300 µs :					
	Les deux	- 0,80	_____	+ 0,80	
Programmation et relecture du courant					
Courant minimal (Iout) :	Les deux	- 0,025	_____	0,025	
Courant mesuré sur l'interface :	Les deux	Iout - 0,025	_____	Iout + 0,025	
Courant élevé (Iout) :	Les deux	249,9	_____	250,1	
Courant mesuré sur l'interface :	Les deux	Iout - 0,1	_____	Iout + 0,1	
Effet de charge de courant constant :					
	Les deux	- 0,025	_____	+ 0,025	
Tests d'absorption de courant					
100 % du courant nominal :	Les deux	- 249,9	_____	- 250,1	
		Réglages de l'appareil testé RP7935A/RP7945A		Réglages de la charge RP7935A/RP7945A	
Programmation et relecture de la tension min. :		Priorité de tension : 0,08 V, 127,5 A		non utilisé	
		Priorité de tension : 80 V, 127,5 A		non utilisé	
Programmation et relecture de la tension élevée :		Priorité de tension : 40 V, 255 A		Priorité de courant : 40,4 V, -250 A	
		Priorité de tension : 40 V, 255 A		Priorité de courant : 60 V, -100 A à -225 A, vitesse de balayage=4 A/µs	
Effet de charge de tension constante, ondulation et bruit de tension constante :		Priorité de courant : 40,4 V, 0 A		Priorité de tension : 40 V, 0 A	
Réponse transitoire :		Priorité de courant : 80,8 V, 125 A		Priorité de tension : 40 V, -255 A	
Programmation et relecture du courant min. :		Priorité de courant : 40,4 V, - 250 A		Priorité de tension : 80 V, -127,5 A	
Programmation et relecture du courant élevé :				Priorité de tension : 40 V, -255 A	
Effet de charge de courant constant :					
100 % du courant nominal (Isink) :					

Keysight RP7936A/RP7946A

RP7936A/RP7946A Relevé de test des performances		Numéro de rapport _____		Date _____	
Description du test	Modèle	Valeurs min. spécifiées	Résultats	Valeurs max. spécifiées	
Programmation et relecture de la tension					
Tension minimale (Vout) :	Les deux	0,143968	_____	0,176032	
Tension mesurée sur l'interface :	Les deux	Vout - 0,016032	_____	Vout + 0,016032	
Haute tension (Vout) :	Les deux	159,952	_____	160,048	
Tension mesurée sur l'interface :	Les deux	Vout - 0,048	_____	Vout + 0,048	
Effet de charge de tension constante :					
	Les deux	- 0,006	_____	+ 0,006	
Ondulation et bruit de tension constante					
Crête à crête :	Les deux	S.O.	_____	0,200	
Valeur efficace vraie :	Les deux	S.O.	_____	0,020	
Réponse transitoire à 300 µs :					
	Les deux	- 1,6	_____	+ 1,6	
Programmation et relecture du courant					
Courant minimal (Iout) :	Les deux	- 0,013	_____	0,013	
Courant mesuré sur l'interface :	Les deux	Iout - 0,013	_____	Iout + 0,013	
Courant élevé (Iout) :	Les deux	124,9495	_____	125,0505	
Courant mesuré sur l'interface :	Les deux	Iout - 0,0505	_____	Iout + 0,0505	
Effet de charge de courant constant :					
	Les deux	- 0,013	_____	+ 0,013	
Tests d'absorption de courant					
100 % du courant nominal :	Les deux	- 124,9495	_____	- 125,0505	
Réglages de l'appareil testé RP7936A/RP7946A			Réglages de la charge RP7936A/RP7946A		
Programmation et relecture de la tension min. :	Priorité de tension : 0,16 V, 63,75 A		non utilisé		
Programmation et relecture de la tension élevée :	Priorité de tension : 160 V, 63,75 A		non utilisé		
Effet de charge de tension constante, ondulation et bruit de tension constante :	Priorité de tension : 80 V, 125 A		Priorité de courant : 80,8 V, -125 A		
Réponse transitoire :	Priorité de tension : 80 V, 62,5 A		Priorité de courant : 120 V, -50 A à -112,5 A, vitesse de balayage=2 A/µs		
Programmation et relecture du courant min. :	Priorité de courant : 80,8 V, 0 A		Priorité de tension : 80 V, 0 A		
Programmation et relecture du courant élevé :	Priorité de courant : 80,8 V, 125 A		Priorité de tension : 80 V, -127,5 A		
Effet de charge de courant constant :	Priorité de courant : 161,6 V, 62,5 A		Priorité de tension : 160 V, -63,75 A		
100 % du courant nominal (Isink) :	Priorité de courant : 80,8 V, - 125 A		Priorité de tension : 80 V, -127,5 A		

7

Maintenance et réparation

Introduction

Procédure d'autotest

Mise à jour du microprogramme

Nettoyage de la mémoire de l'instrument

Commutateurs d'étalonnage

Remplacement de la pile

Démontage

Introduction

Service de réparation disponible

Si votre instrument tombe en panne pendant la période de garantie, Keysight Technologies s'engage à le réparer ou le remplacer selon les conditions de votre garantie. Après l'expiration de la garantie, Keysight propose des services de réparation économiques.

De nombreux produits Keysight peuvent faire l'objet de contrats de maintenance en option après l'expiration de la garantie.

Trouver un service de réparation (international)

Pour faire réparer votre instrument, contactez votre **Centre de maintenance Keysight Technologies** le plus proche. Ce dernier organisera la maintenance ou le remplacement, et vous fournira des informations sur la garantie ou le coût des réparations selon le cas. Demandez au Centre de maintenance Keysight Technologies les consignes d'expédition, y compris les composants à envoyer. Nous recommandons de conserver le carton d'emballage pour les expéditions de retour.

Avant de retourner l'appareil

Avant de retourner l'appareil, vérifiez que la panne provient de l'instrument et non de connexions externes. Vérifiez également que l'instrument a été étalonné avec précision au cours de l'année précédente (voir la section **Intervalle d'étalonnage**).

Si l'appareil ne fonctionne pas, vérifiez que :

- le cordon d'alimentation secteur est correctement branché à l'instrument ;
- le cordon d'alimentation secteur est branché dans une prise secteur sous tension ;
- l'interrupteur d'alimentation Power On/Standby du panneau avant est enfoncé.

Si l'autotest échoue, vérifiez que :

tous les raccords (avant et arrière) sont retirés pendant l'exécution de l'autotest. Pendant l'autotest, des erreurs peuvent se produire en raison des signaux présents sur les câbles externes (ex. longs cordons de test qui provoquent un effet d'antenne).

Remballage pour l'expédition

Pour expédier l'instrument à des fins de maintenance ou de réparation, procédez comme suit :

- Apposez sur l'appareil une étiquette d'identification du propriétaire et indiquant l'intervention nécessaire (maintenance ou réparation). Incluez les numéros de modèle et de série complets de l'appareil.

- Placez l'appareil dans son emballage d'origine avec des matériaux d'emballage adéquats.
- Protégez le colis avec des bandes adhésives ou métalliques résistantes.
- Si le conteneur d'expédition d'origine n'est pas disponible, Keysight recommande fortement de se procurer l'un des kits d'emballage suivants pour veiller à ce que l'appareil ne soit pas endommagé pendant l'expédition :
 - RÉF. 5188-9520 - Kit d'emballage pour modèles RP795xA/RP796xA
 - RÉF. 5188-9614 - Kit d'emballage pour modèles RP793xA/RP794xA.

Keysight recommande d'assurer systématiquement vos expéditions.

Nettoyage

AVERTISSEMENT

RISQUE D'ÉLECTROCUTION Pour éviter tout risque, débranchez l'alimentation secteur avant le nettoyage.

Nettoyez l'extérieur de l'instrument avec un chiffon doux non pelucheux et légèrement humide. N'utilisez pas de détergent. Le démontage n'est pas nécessaire ni recommandé pour le nettoyage.

Procédure d'autotest

Autotest à la mise sous tension

À chaque mise sous tension de l'instrument, un autotest est réalisé. Il certifie que l'instrument est opérationnel.

L'autotest vérifie que l'ensemble minimum du système d'alimentation et d'analyse logique fonctionnent correctement. Il n'active pas la sortie et ne soumet la sortie à aucune tension. Il laisse l'instrument à l'**état de réinitialisation**.

Autotest initié par l'utilisateur

L'autotest initié par l'utilisateur est identique à l'autotest à la mise sous tension.

Aide-mémoire des menus du panneau avant	Commande SCPI
Mettez l'instrument hors tension, puis rallumez-le.	*TST?
Si l'autotest échoue, le voyant EER du panneau avant s'allume. Appuyez sur la touche Error pour afficher la liste des erreurs.	Si la valeur 0 est renvoyée, l'autotest est réussi. Si la valeur 1 est renvoyée, l'autotest échoue. Si l'autotest échoue, utilisez la commande SYSTem:ERRor? pour afficher l'erreur d'autotest.

Pour une liste des erreurs, reportez-vous à la section **Messages d'erreur SCPI**.

Mise à jour du microprogramme

REMARQUE

Pour déterminer la version de microprogramme installée sur votre instrument, reportez-vous à la section **Identification de l'instrument**. Pour obtenir les derniers microprogrammes pour les séries RP793xA et RP794xA, rendez-vous à la page www.keysight.com/find/RPSfirmware. Pour obtenir les derniers microprogrammes pour les séries RP795xA et RP796xA, rendez-vous à la page www.keysight.com/find/RPS2firmware.

Logiciel requis

Pour mettre à jour le microprogramme, vous devez télécharger les deux composants suivants vers votre ordinateur à partir de la page de produit RPS via le lien vers le microprogramme RPS référencé ci-dessus.

- L'utilitaire de mise à jour de programmes universel
- La dernière version du microprogramme

Procédure de mise à jour

Une fois que vous avez copié les deux éléments sur votre ordinateur, procédez comme suit :

1. Exécutez l'utilitaire de mise à jour de microprogrammes universel
2. Accédez au dossier où vous avez enregistré le microprogramme que vous venez de télécharger. Appuyez sur Next.
3. Sélectionnez l'interface que vous utilisez pour communiquer avec votre instrument et entrez la chaîne d'adresse ou de connexions. Appuyez sur Next.
4. Vérifiez que les informations correspondent bien à l'instrument que vous mettez à jour. Appuyez sur Lancer la mise à jour.

L'utilitaire de mise à jour va maintenant mettre à jour le microprogramme et redémarrer votre instrument.

Restriction de l'accès

Notez que vous pouvez restreindre l'accès à l'instrument à l'aide de l'utilitaire de mise à jour de microprogrammes. Cela empêche les utilisateurs non autorisés de mettre le microprogramme à jour.

Aide-mémoire des menus du panneau avant

Commande SCPI

7 Maintenance et réparation

Sélectionnez **System\Admin\Update**

Non disponible

Cochez la case **Must log in as admin** (Doit se connecter en tant qu'administrateur).

Cette option requiert qu'un utilisateur se connecte au menu Admin avant que l'utilitaire de mise à jour de microprogrammes ne mette à jour le microprogramme.

Nettoyage de la mémoire de l'instrument

REMARQUE Cette procédure est déconseillée dans les applications de routine en raison des risques de perte involontaire de données.

Cette procédure nettoie toutes les données utilisateur. Elle écrit uniquement des zéros dans la mémoire Flash, puis effectue un effacement complet de la mémoire du processeur conformément à la fiche technique du fabricant. Les données d'identification, telles que le microprogramme de l'instrument, le numéro du modèle, le numéro de série, l'adresse MAC et les données d'étalonnage ne sont pas effacées. Une fois les données effacées, l'instrument est redémarré.

Si le menu Admin est inaccessible, il est probablement protégé par un mot de passe.

Aide-mémoire des menus du panneau avant	Commande SCPI
Sélectionnez System\Admin\Sanitize	SYST:SEC:IMM
Sélectionnez Sanitize.	
Cette option permet de supprimer toutes les données utilisateurs de l'instrument et de remettre ce dernier sous tension.	

Pour plus d'informations, consultez la page <http://rfmw.em.keysight.com/aerospace/index.aspx>.

Activation après le nettoyage

La première fois que l'appareil est allumé après avoir été nettoyé, plusieurs erreurs de somme de contrôle NVRAM seront générées. Ces erreurs annoncent le fait que deux fichiers manquaient et ont été recréés avec des valeurs par défaut. La prochaine fois que l'appareil s'allume, il ne devrait y avoir aucune erreur.

Nettoyage d'un instrument désactivé

Si l'instrument ne fonctionne plus et que vous ne pouvez pas utiliser la procédure de nettoyage décrite ci-dessus, vous devez retirer physiquement la carte P600 de l'instrument et la détruire. Reportez-vous à la section **Démontage**.

Commutateurs d'étalonnage

AVERTISSEMENT

RISQUE D'ÉLECTROCUTION Seules des personnes qualifiées, formées à la maintenance et conscientes des risques d'électrocution encourus peuvent démonter les capots de l'instrument. Débranchez toujours le cordon d'alimentation secteur et tous les circuits externes avant de démonter le capot de l'instrument. Certains circuits sont activés et brièvement alimentés, même lorsque l'interrupteur d'alimentation est en position d'arrêt.

L'accès aux commandes d'étalonnage est contrôlé au moyen de deux commutateurs. Situés sur la carte d'interface, ces commutateurs sont accessibles en retirant le capot supérieur.

Accès au commutateur d'étalonnage

1. Retirez le capot de l'instrument comme décrit dans la section **Démontage**.
2. Le commutateur d'étalonnage est situé sur la carte d'interface sur l'angle arrière de l'appareil. Pour modifier les réglages des commutateurs d'étalonnage, déplacez les commutateurs à l'aide d'un petit tournevis. Par défaut, tous les commutateurs sont réglés en position ON (ACTIVÉ) (voir ci-dessous).
3. Reposez le capot supérieur une fois l'opération terminée.

ATTENTION

N'utilisez pas de pinceau pour déplacer les commutateurs. Toute poussière de graphite déposée sur les commutateurs est conductrice.

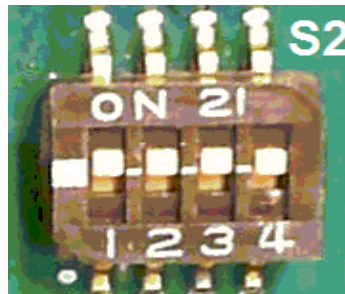
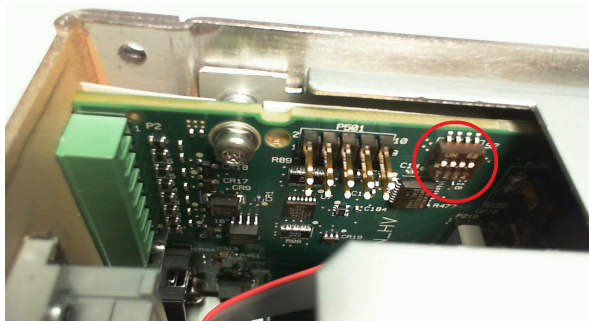

Fonctions de commutation

Les commutateurs 1 et 2 définissent la configuration de l'étalonnage comme suit. Les commutateurs 3 et 4 ne sont pas utilisés.

	Commutateur 1	Commutateur 2	Description
Normal	ON	ON	Réglage par défaut du commutateur. Les fonctions d'étalonnage sont accessibles après la saisie d'un mot de passe numérique. Le mot de passe par défaut est 0 (zéro).
Clear Password	OFF	ON	Le mot de passe d'administration/étalonnage est réinitialisé à 0 lorsque l'instrument est mis sous tension pour la première fois. Utilisez ce réglage si vous avez oublié le mot de passe.
Inhibit Calibration	ON	OFF	Toutes les commandes d'étalonnage sont désactivées. Cela est utile lorsque l'accès est protégé par les joints de l'instrument.

Remplacement de la batterie

AVERTISSEMENT

RISQUE D'ÉLECTROCUTION Seules des personnes qualifiées, formées à la maintenance et conscientes des risques d'électrocution encourus peuvent démonter les capots de l'instrument. Débranchez toujours le cordon d'alimentation secteur et tous les circuits externes avant de démonter le capot de l'instrument. Certains circuits sont activés et brièvement alimentés, même lorsque l'interrupteur d'alimentation est en position d'arrêt.

La batterie interne commande l'horloge en temps réel. La fonction principale de l'horloge est de fournir des informations d'horodatage pour le logiciel de contrôle et d'analyse Keysight 14585A. Si la batterie tombe en panne, le logiciel n'aura plus d'heure. Aucune autre fonction de l'instrument n'est affectée.

Dans des conditions normales de fonctionnement à température ambiante, la durée de vie de la batterie de lithium est comprise entre sept et dix ans. Notez que la durée de vie de la batterie sera réduite si l'instrument est stocké pendant une longue période à des températures supérieures à 40 degrés C.

La référence de la batterie est Panasonic CR 2032.

Procédure de remplacement

1. Retirez le capot de l'instrument comme décrit dans la section **Démontage**.
2. Retirez la carte de commande comme décrit dans la section **Démontage**.

7 Maintenance et réparation

3. La batterie est située sur la carte Constellation, sous le câble-ruban.

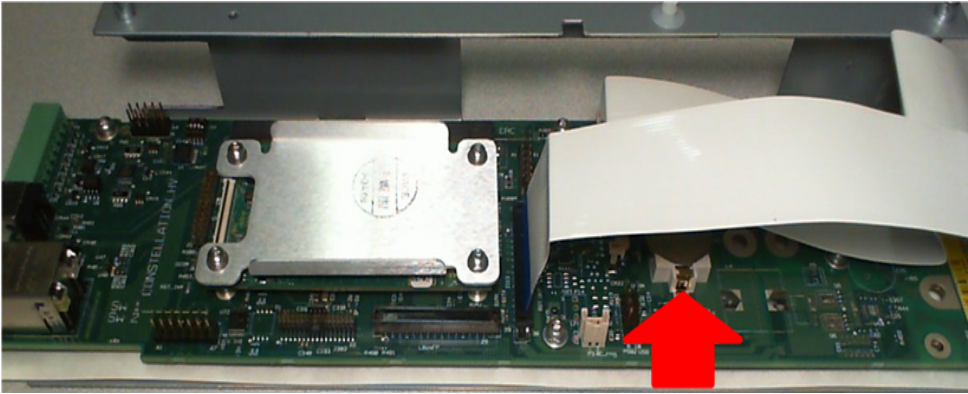

4. Pour accéder à la batterie, libérez les câbles-ruban en tirant sur la languette de verrouillage.

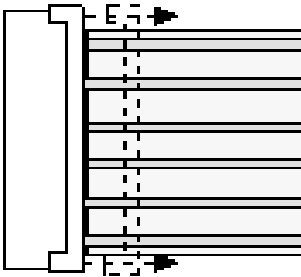

5. À l'aide d'un petit tournevis à lame plate, soulevez délicatement le côté de la batterie indiqué par une flèche.

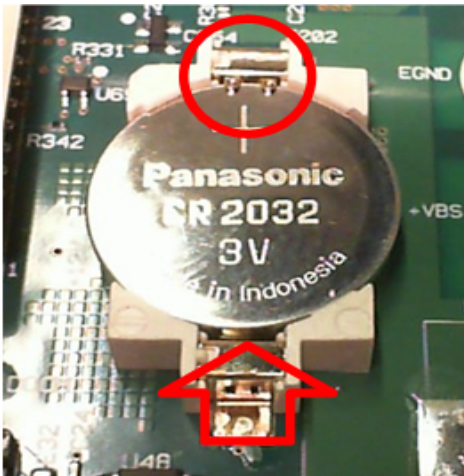

6. Installez la batterie neuve. Assurez-vous que le côté positif (+) est orienté vers le haut. Placez la batterie sous les petites agrafes à ressort indiquées par le cercle, puis enfoncez le côté opposé de la batterie indiqué par la flèche rouge. La partie supérieure des agrafes à ressort doit être visible une fois la batterie en place (voir le cercle rouge).
7. Reposez les rubans-câbles en introduisant complètement les câbles dans le connecteur, puis fixez les câbles en appuyant sur la languette de verrouillage.
8. Remplacez la carte de commande et le capot supérieur lorsque vous avez terminé.

9. Réinitialisez la date et l'heure (voir [Réglage de l'horloge](#)).

Démontage

AVERTISSEMENT

RISQUE D'ÉLECTROCUTION Seules des personnes qualifiées, formées à la maintenance et conscientes des risques d'électrocution encourus peuvent démonter les capots de l'instrument. Débranchez toujours le cordon d'alimentation secteur et tous les circuits externes avant de démonter le capot de l'instrument. Certains circuits sont activés et brièvement alimentés, même lorsque l'interrupteur d'alimentation est en position d'arrêt.

Précautions contre les décharges électrostatiques (ESD)

Pendant les manipulations, même des décharges électrostatiques inférieures à 50 V peuvent endommager la plupart des composants électriques.

Les recommandations suivantes permettent d'éviter les dommages dus aux décharges électrostatiques (ESD) pendant les interventions de maintenance :

- Démontez les instruments uniquement dans une zone antistatique.
- Utilisez un plan de travail conducteur pour réduire les décharges.
- Utilisez un bracelet antistatique pour réduire les décharges.
- Manipulez l'instrument au minimum.
- Conservez les pièces détachées dans un emballage d'origine antistatique.
- Enlevez de l'environnement immédiat du poste de travail les matières plastiques, la mousse, le vinyle, le papier et les autres matériaux à fort potentiel électrostatique.

Outils nécessaires

- Tournevis Torx T10 pour le démontage du capot et de la carte
- Tournevis Torx T8 pour le démontage de la P600
- Petit tournevis à lame plate pour retirer la batterie

Démontage du capot

1. Coupez l'alimentation. Débranchez tous les câbles de l'instrument.
2. Retirez les 7 vis à tête plate situées en haut de l'instrument, les 10 vis à tête plate situées sur les côtés et les 3 vis à tête cylindrique situées à l'arrière (voir la figure ci-dessous). Placez les vis dans un récipient afin de ne pas les perdre.
3. Retirez le capot de l'instrument.

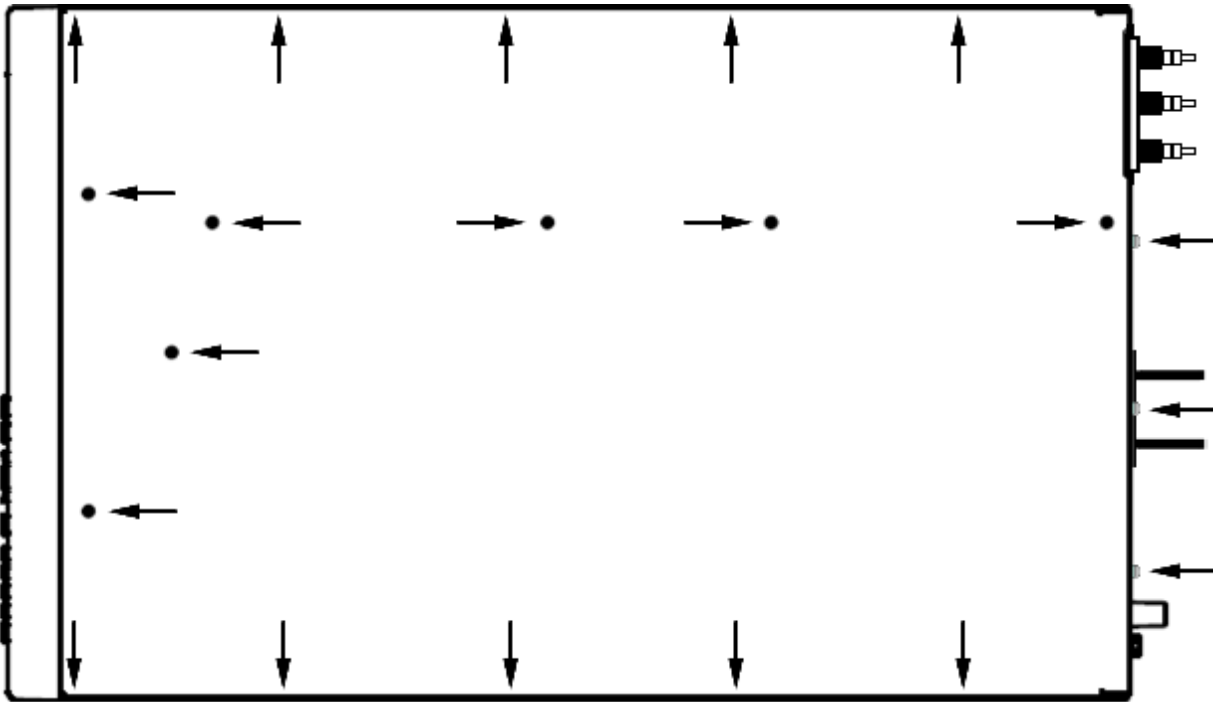

Démontage de la carte de commande

La carte de commande est située à l'extérieur de la carte Constellation. Il faut la retirer pour pouvoir accéder à la batterie et à la carte P600, qui sont toutes deux situées sur la carte Constellation.

1. Comme indiqué ci-dessous, retirez d'abord les deux vis situées sur la partie supérieure du panneau de commande. Placez les vis dans un récipient afin de ne pas les perdre.

RP793xA
RP794xA

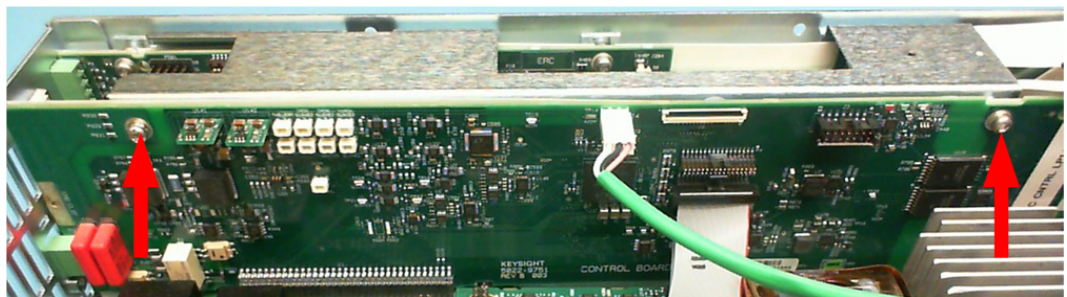

RP795xA
RP796xA

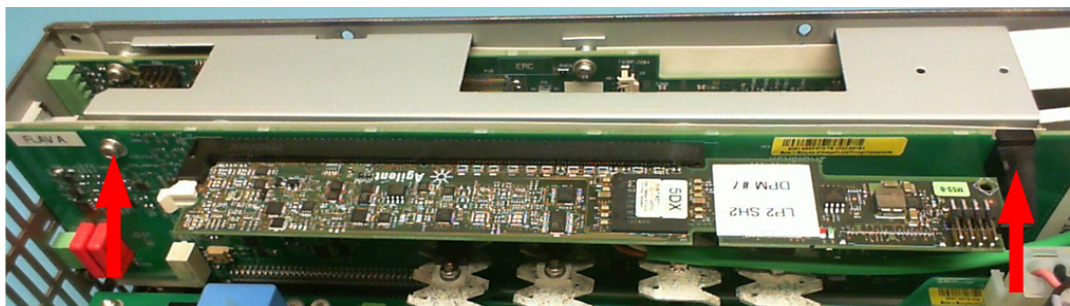

7 Maintenance et réparation

2. Vous pouvez maintenant soulever la carte de son socket et la déplacer sur le côté.
(Lors du remontage de la carte de commande, n'oubliez pas de remplacer l'isolant derrière celle-ci.)

Démontage de la carte Constellation

Si vous avez du mal à accéder à la carte Constellation après avoir déplacé la carte de commande, vous pouvez retirer l'ensemble de la carte Constellation.

1. Retirez les trois vis sur le côté du châssis qui maintiennent la carte Constellation. Placez les vis dans un récipient afin de ne pas les perdre.

Retirez les vis

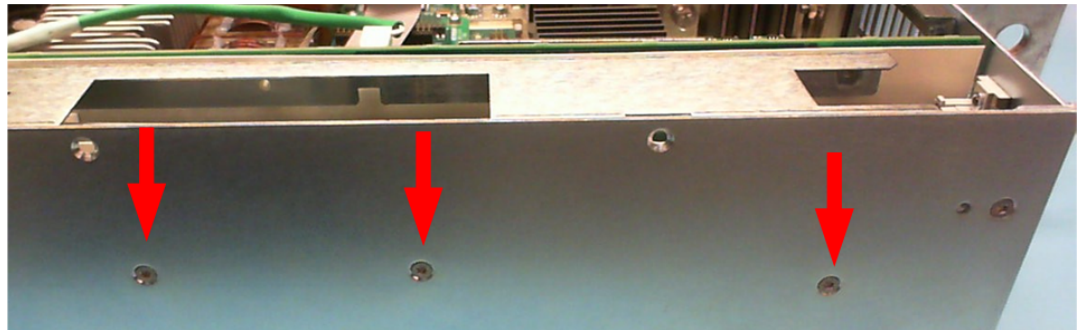

2. Vous pouvez maintenant soulever l'ensemble Constellation de l'appareil pour accéder à la carte P600 et à la batterie.
3. Pour accéder à la carte P600, utilisez un tournevis Torx T8 pour retirer les quatre vis du dissipateur thermique. Vous pouvez maintenant retirer la carte P600 de son socket.

Retirez les 4 vis du dissipateur thermique pour déposer la carte P600

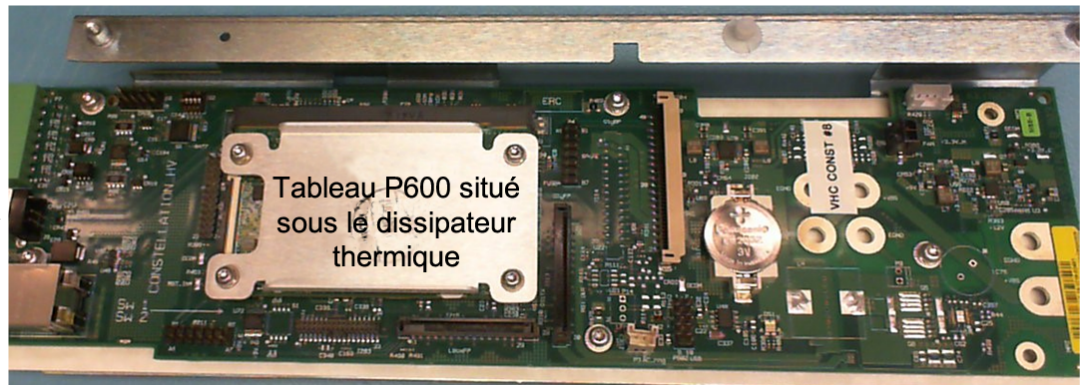

Annexe A

Systeme de déconnexion de sécurité Keysight SD1000A

Description

Installation

Fonctionnement

Système de déconnexion de sécurité Keysight SD1000A

Introduction

Présentation succincte du système de déconnexion de sécurité

Caractéristiques supplémentaires

ATTENTION

Le système de déconnexion de sécurité (SDS) Keysight SD1000A avec option 500 ne peut être utilisée qu'avec les modèles Keysight RP7951A, RP7952A, RP7961A et RP7962A.

Le système de déconnexion de sécurité (SDS) Keysight SD1000A avec option 950 ne peut être utilisée qu'avec les modèles Keysight RP7953A et RP7963A.

Introduction

REMARQUE

Toutes les **informations légales et de sécurité** pour la série Keysight RP7900 s'appliquent également à l'appareil Keysight SD1000A.

Le système de déconnexion de sécurité (SDS) Keysight SD1000A est une interface de commutation automatisée entre l'alimentation de la série Keysight RP7900 et l'appareil testé (UUT). Il est destiné à assurer la sécurité de l'opérateur lorsque l'alimentation RP7900 est utilisée dans un environnement de production. Le système de déconnexion de sécurité (SDS) fournit l'interface entre les entrées de sécurité telles qu'un commutateur d'arrêt d'urgence ou un commutateur de protection et un appareil testé, ainsi l'opérateur n'est jamais exposé à des tensions nuisibles lors de l'utilisation du système de test.

Le système de déconnexion de sécurité (SDS) contient des relais redondants connectés en série (deux relais d'alimentation et deux relais de mesure) qui fournissent un niveau de sécurité supplémentaire lors de la déconnexion de la haute tension de l'appareil testé (UUT). Le système de déconnexion de sécurité (SDS) est raccordé à l'alimentation de la série Keysight RP7900 via un câble d'interface dédié. Le fonctionnement du SDS est intégré dans la série Keysight RP7900 de façon à fonctionner comme si les relais étaient internes à l'alimentation électrique.

Présentation succincte du système de déconnexion de sécurité Keysight SD1000A

Vue de face

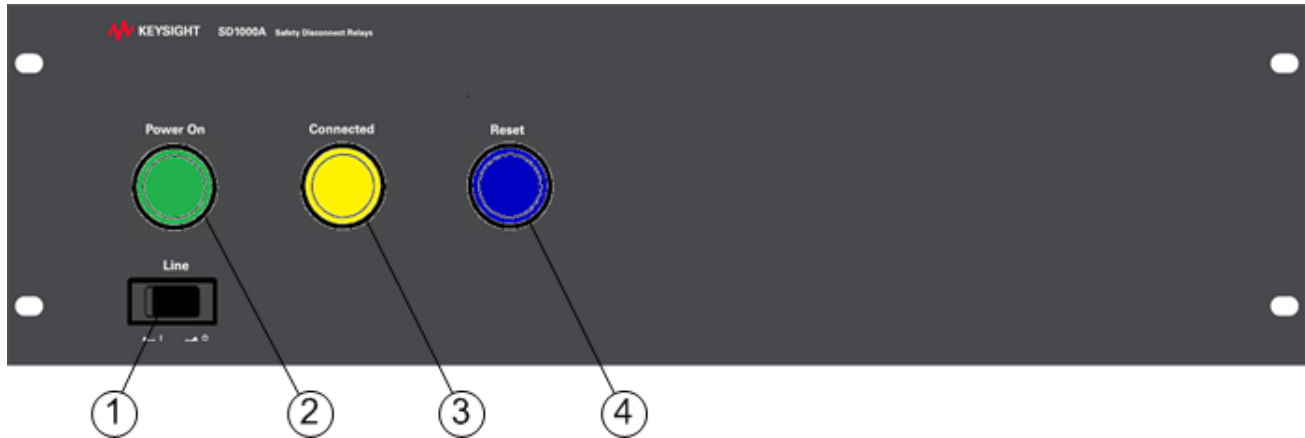

Vue arrière

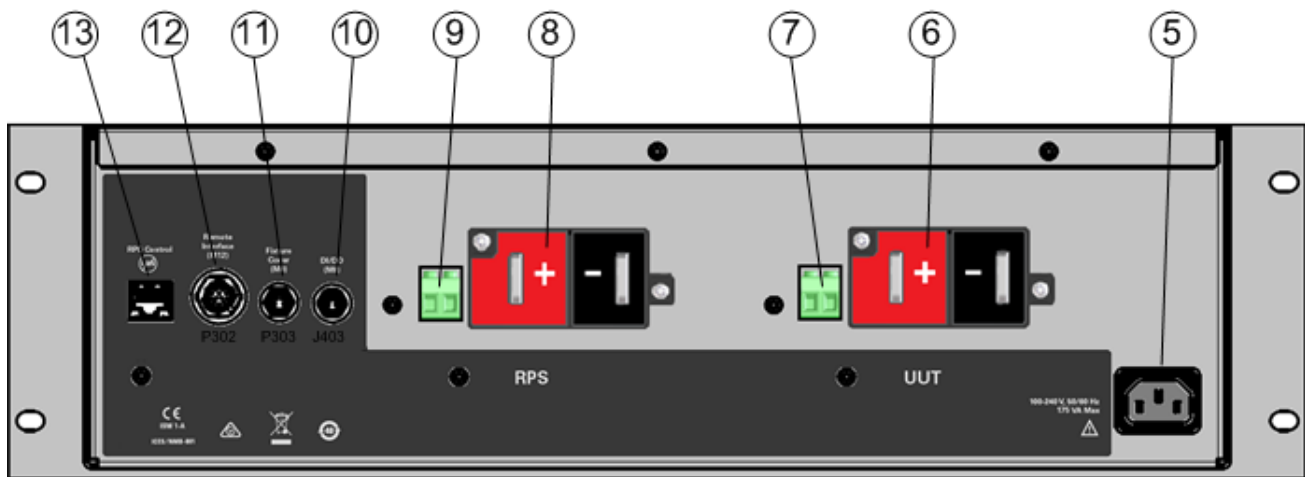

1. **Interrupteur secteur** Permet d'allumer ou d'éteindre l'appareil.
2. **Voyant de mise sous tension vert** Indique que l'appareil SDS est sous tension lorsqu'il est allumé
3. **Voyant de connexion jaune** Indique qu'un ou plusieurs relais sont fermés lorsqu'il est allumé
4. **Voyant de réinitialisation bleu** Indique que le SDS doit être réinitialisé lorsqu'il est allumé
5. **Entrée CA** Entrée CA universelle (100-240 V CA)
6. **Bornes de sortie UUT** Connexions de sortie + et - pour mettre sous tension l'appareil testé
7. **Bornes de mesure UUT ¹** Connexions + et - pour la mesure locale ou à distance
8. **Bornes d'entrée RPS** Connexions d'entrée + et - de l'appareil RP7900
9. **Bornes de mesure RPS ¹** Connexions + et - pour la mesure locale ou à distance
10. **Connecteur DI/DO** Connecteur femelle pour commande E/S numérique

11. **Connecteur du capot de l'appareil** Connecteur mâle pour capot de l'appareil (voir **Commutateur du capot**)
12. **Connecteur d'interface distante** Connecteur mâle pour interface d'état et de commande (voir **Commutateur ESTOP**)
13. **Interface de commande RPS** Connecteur d'interface pour les alimentations de la série RP7900

Remarque 1 Lors de l'expédition, les bornes de mesure sont connectées pour le mode de mesure locale.

Caractéristiques supplémentaires

Les caractéristiques supplémentaires ne sont pas garanties, mais décrivent les performances déterminées par définition ou par test type. Toutes les caractéristiques supplémentaires sont standard, sauf indication contraire.

Caractéristique	Keysight SD1000A
Valeurs nominales des relais d'alimentation	500 V CC ; 60 A CC
Option 500 :	950 V CC ; 60 A CC
Option 950 :	
Relais d'alimentation, durée de vie mécanique :	1 000 000 cycles 10 000 cycles
Relais d'alimentation, durée de vie avec commutation à chaud :	1 000 000 cycles
Durée de vie des relais de mesure :	
Résistance de décharge	
Option 500 :	25 k Ω , 10 W
Option 950 :	97,5 k Ω , 10 W
Conformité réglementaire	
CEM :	Conforme à la directive CEM relative aux produits de test et de mesure. Conforme à la norme Australienne et porte la marque C-Tick. This ISM device complies with Canadian ICES-001. Cet appareil ISM est conforme à la norme NMB-001 du Canada.
Sécurité :	Conforme à la directive basse tension européenne et porte la marque CE. Conforme aux réglementations de sécurité américaines et canadiennes. Vous pouvez télécharger sur Internet les déclarations de conformité concernant ce produit. Accédez à la page http://regulations.corporate.keysight.com et cliquez sur « Declarations of Conformity » (Déclarations de conformité).
Conditions environnementales	
Conditions de fonctionnement :	Utilisation interne, catégorie d'installation II (pour l'entrée secteur), degré de pollution 2 0 à 55°C
Plage de température : ¹	95% au maximum (sans condensation)
Humidité relative :	Jusqu'à 2 000 mètres
Altitude :	-30 à 70°C
Température de stockage :	
Isolation des bornes de sortie :	Aucune borne de sortie ne doit être soumise à une tension de plus de 950 V CC par rapport à une autre borne ou à la masse du châssis.
Entrée secteur	
Valeur nominale :	Entrée monophasée, 100–240 V CA, 50–60 Hz
Plage d'entrée :	86–264 VCA, 47–63 Hz
Consommation électrique :	150 W
Poids type	15 kg (33 livres)

Annexe A Système de déconnexion de sécurité Keysight SD1000A

¹ La puissance continue maximale est déclassée à 1 % de la puissance nominale par degré C entre 40 et 55 °C

Dimensions

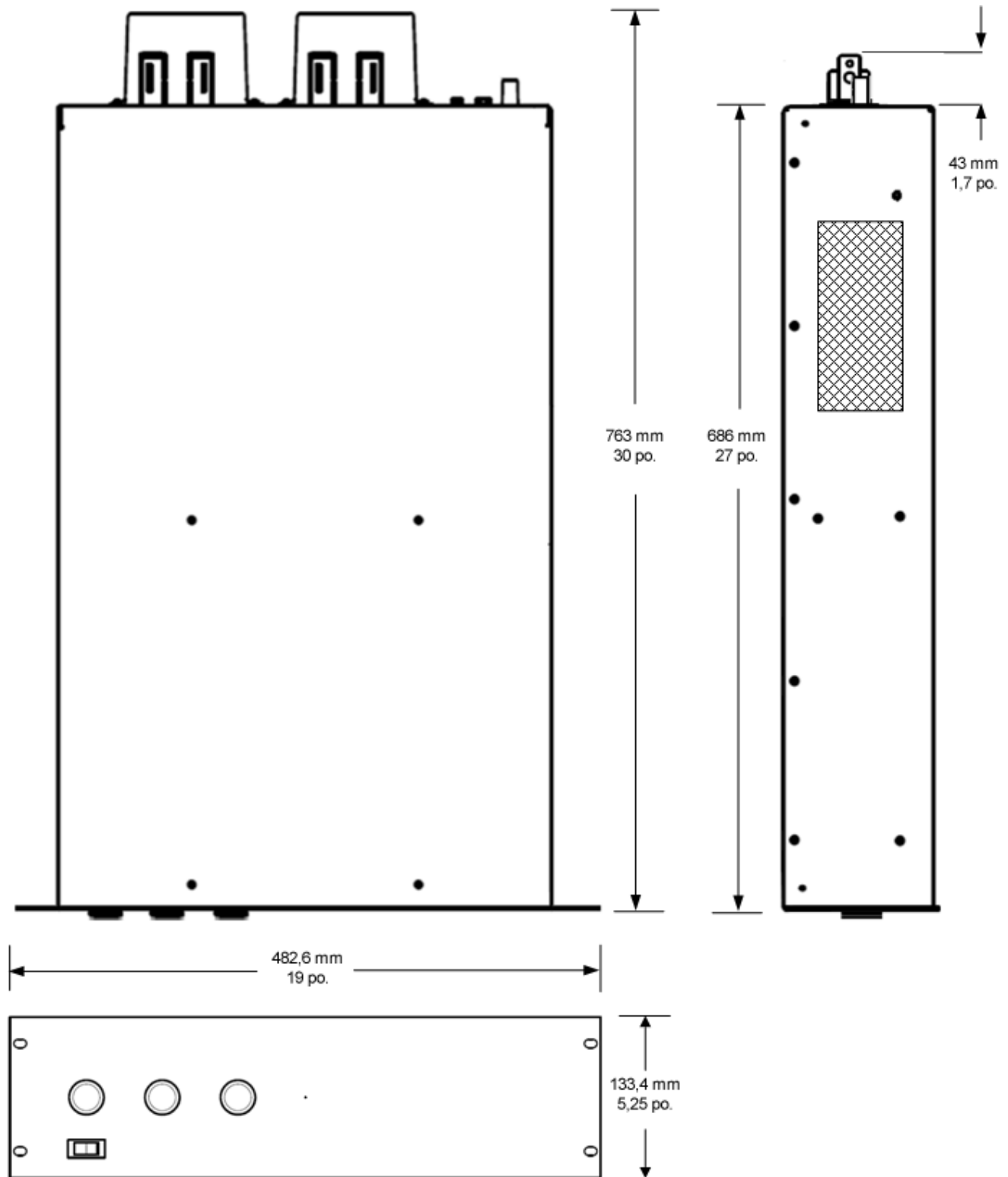
**REMARQUE**

L'appareil SDS dispose d'un refroidissement passif et ne nécessite aucun ventilateur ou autres considérations de refroidissement ; à condition que les orifices d'aération sur les côtés de l'appareil ne soient pas obstrués.

Installation du système de déconnexion de sécurité Keysight SD1000A

Connexions Keysight SD1000A à RP7900

Connexions de commandes externes

Pour en savoir plus sur les éléments fournis, consultez la section **Éléments fournis**. Pour des informations détaillées sur les connexions et les tailles de fil, consultez la section **Connexions d'un appareil unique**.

Connexions Keysight SD1000A à RP7900

Comme indiqué dans les figures suivantes, installez le système de déconnexion de sécurité (SDS) aussi près que possible de l'appareil de la série RP7900. Les deux appareils sont conçus pour un montage dans des baies standard System II. Les oreilles de montage en baie sont intégrées dans l'appareil SDS.

Si vous utilisez une configuration d'alimentation principale/secondaire, l'alimentation principale doit être connectée à l'appareil SDS.

Schéma fonctionnel du SDS simplifié

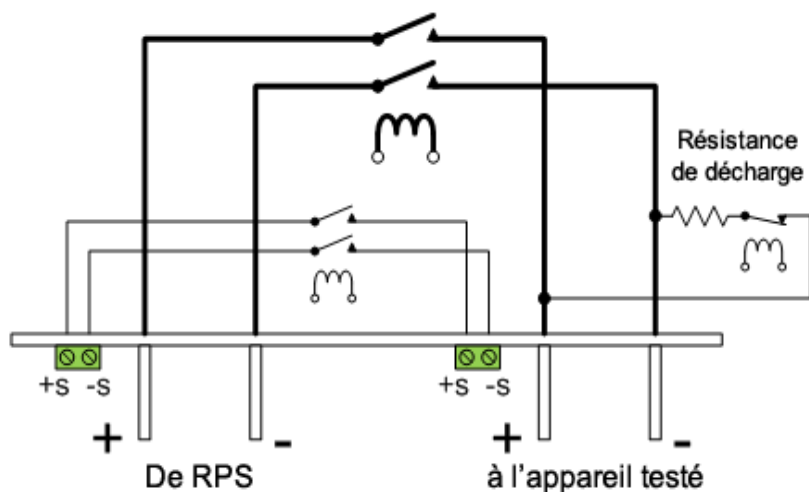

Connexions de fils

Les facteurs suivants doivent être pris en compte lors du raccordement de l'appareil RPS, SDS et testé :

- Intensité du courant des fils de charge
- Le facteur d'isolation des fils de charge doit être équivalent à la tension de sortie nominale
- Effets de la chute de tension dans les fils de charge, du bruit et de l'impédance

ATTENTION

Le couple de serrage de boulons de sortie ne doit pas dépasser 10,8 Nm (8 lb-ft).
Les connexions de mesure sur l'appareil SDS ne doivent PAS être utilisées pour les mesures locales.

Connexions avec mesure locale

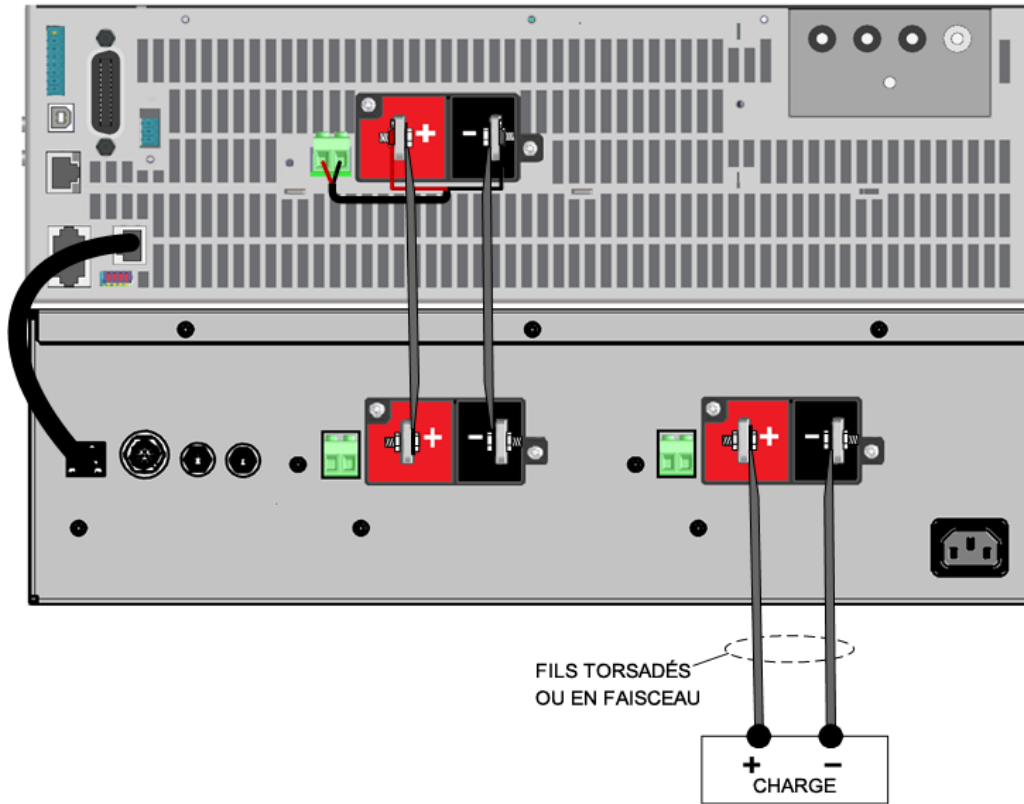

Connexions avec mesure à distance

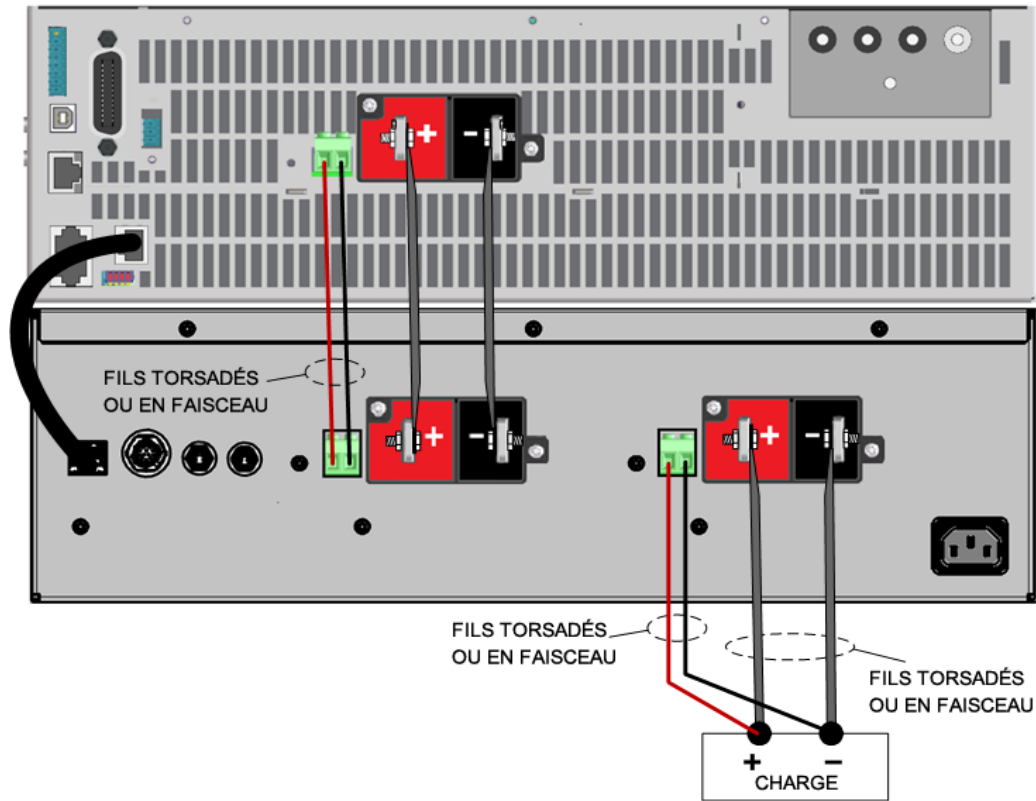

1. Connectez le câble d'interface de l'appareil RP7900 à l'appareil SDS.
2. Connectez la sortie de la série RP7900 à l'entrée de l'appareil SDS.
3. Connectez la sortie de l'appareil SDS à l'appareil testé (la charge).
4. En cas d'utilisation la mesure à distance, ne regroupez PAS la paire de fils torsadée et les fils de charge ; maintenez les fils de charge à l'écart des fils de mesure.
5. Installez les **capots de sécurité** de la barre conductrice. Selon la façon dont les appareils sont raccordés, vous devrez peut-être retirer les découpes de la barre conductrice des capots de sécurité.

Connexions avec des appareils en parallèle

Le facteur limitant le nombre d'appareils Keysight RP7900 que vous pouvez raccorder à un appareil SDS est le courant nominal des relais SDS, qui est de 60 A. Par exemple, vous pouvez raccorder un appareil de 500 V et 10 kW et un appareil de 500 V et 5 kW à un appareil SDS tout en respectant le courant nominal maximum de 60 A.

- Dans une configuration principale/secondaire, connectez le câble d'interface SDS à l'appareil RP7900 principal.
- Pour obtenir des informations détaillées sur les connexions pour les appareils connectés en parallèle, reportez-vous à la section **Connexions de plusieurs appareils**.
- Si la mesure à distance est utilisée, connectez les câbles de mesure des deux appareils RP7900 aux bornes de mesure **RPS** de l'appareil SDS.

- Si plusieurs appareils RPS sont utilisés dans une configuration en parallèle, chaque groupe de 60 A supplémentaire nécessitera son propre appareil SDS dédié.

Connexions de commandes externes

Plusieurs fonctions configurables par le client sont disponibles sur le panneau arrière du SDS (voir la section **Contrôle du SDS à l'aide des commandes raccordées à l'extérieur**). Les connecteurs et les fonctions de brochage sont décrits comme suit :

Connecteur d'interface distante (M12)

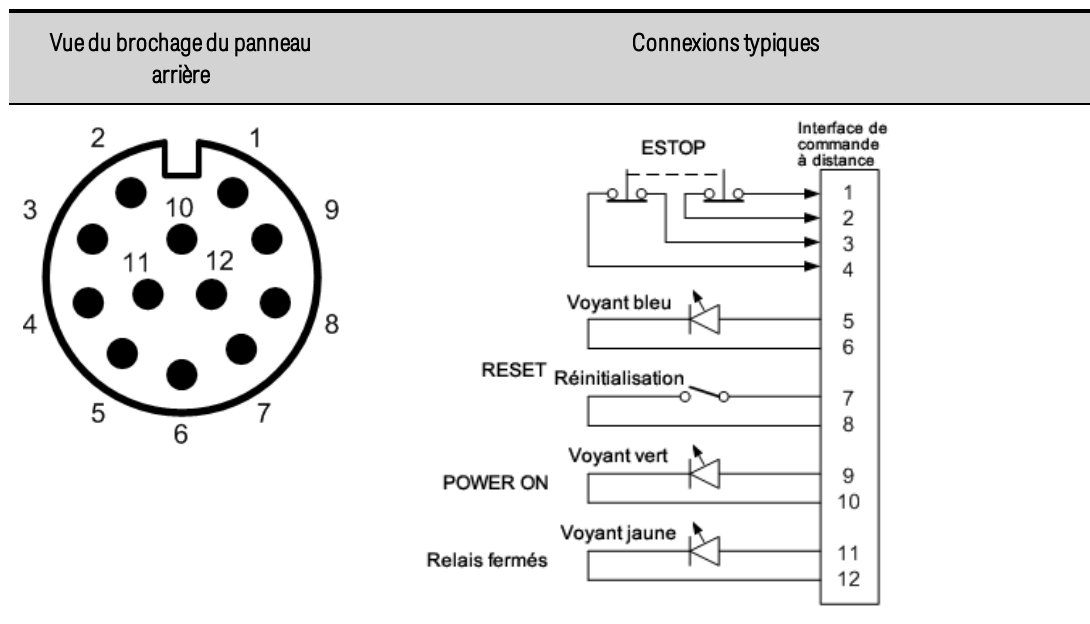

Broche	Description
1	Commutateur ESTOP , contact des commutateurs des broches 1-2 normalement fermé
2	Commutateur ESTOP , contact des commutateurs des broches 1-2 normalement fermé
3	Commutateur ESTOP , contact des commutateurs des broches 3-4 normalement fermé
4	Commutateur ESTOP , contact des commutateurs des broches 3-4 normalement fermé
5	Voyant RESET (bleu) +24 V
6	Voyant RESET (bleu) retour 24 V
7	Commutateur RESET , contact normalement fermé
8	Commutateur RESET , contact normalement fermé
9	Mise sous tension voyant (vert) +24 V
10	Mise sous tension voyant (vert) retour 24 V
11	Relais fermés voyant (jaune) +24 V

Broche	Description
12	Relais fermés voyant (jaune) retour 24 V

Connecteur du capot de l'appareil (M8)

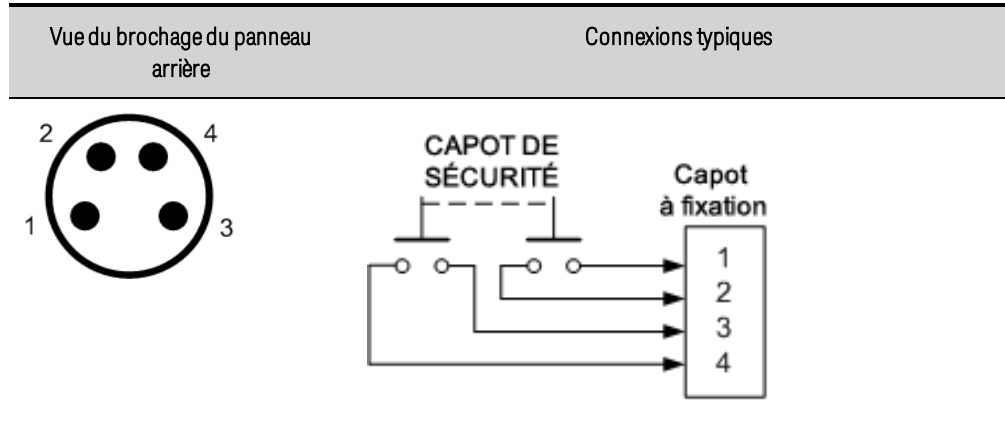

Broche	Description
1	Commutateur Capot de sécurité , contact des commutateurs des broches 1-2 normalement ouvert
2	Commutateur Capot de sécurité , contact des commutateurs des broches 1-2 normalement ouvert
3	Commutateur Capot de sécurité , contact des commutateurs des broches 3-4 normalement ouvert
4	Commutateur Capot de sécurité , contact des commutateurs des broches 3-4 normalement ouvert

Connecteur (M8) DI/DO

En mode de déconnexion de sécurité, les entrées/sorties DI/DO sont destinées à commander un contacteur CA auxiliaire.

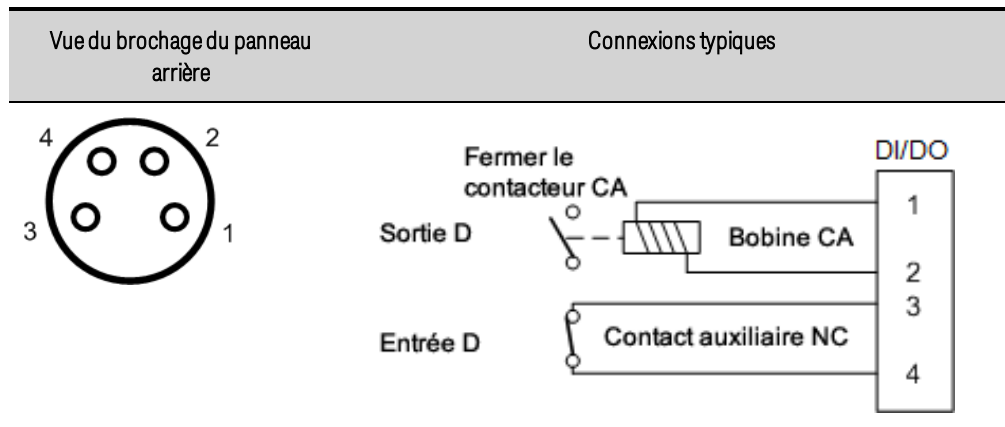

Broche	Description
1	DOutput, signal de commande + 24 V pour contacteur CA (courant de commande ≤ 500 mA)
2	DOutput, retour du signal de commande 24 V
3	DInput, contacteur CA OK lorsque raccordé à la broche 4
4	DInput, contacteur CA OK lorsque raccordé à la broche 3

Références des connecteurs

Connecteur	Se connecte avec	Numéro de référence Phoenix Contact
Femelle M12	Interface distante (M12)	1404420 (câbles 24-28 AWG)
Femelle M8	Capot de l'appareil (M8)	1681185 (câbles 22-28 AWG)
Mâle M8	DI/DO (M8)	1681169 (câbles 22-28 AWG)

Composants types fournis par le client

Composant	Description	Numéro de référence
Commutateur ESTOP	2 bornes NC, verrouillage, compatible avec 24 V	Eaton C22-PVT45P-K02
Voyant/commutateur de réinitialisation RESET	Voyant bleu 24 V avec commutateur NO de contact provisoire	Eaton C22S-DL-B-K10-24
Voyant de mise sous tension POWER ON	Voyant vert 24 V	Eaton C22-L-G-24
Voyant de relais fermés RELAYS CLOSED	Voyant jaune 24 V	Eaton C22-L-Y-24
Interrupteur du capot de sécurité	Se connecte directement avec un relais magnétique	Relais magnétique Pilz 504222
Contacteur CA	Contacteur triphasé CA avec contacts auxiliaires NC	Omron J7KNA-09-01

Fonctionnement du système de déconnexion de sécurité SD1000A

Contrôle du SDS à l'aide de l'alimentation du RP7900

Contrôle du SDS à l'aide des commandes raccordées à l'extérieur

Contrôle du SDS à l'aide de l'alimentation de la série RP7900

Lors de la connexion à l'alimentation de la série RP7900, les relais du SDS s'ouvrent et se ferment automatiquement en même temps que l'état de sortie de l'alimentation.

Connexion au SDS

Étape 1. Assurez-vous que le câble d'interface du SDS a été installé (voir [Installation](#)).

Étape 2. Allumez d'abord l'appareil SDS. Le voyant d'alimentation vert sur le SDS indique que l'alimentation CA est appliquée. Le voyant de réinitialisation bleu est également activé, car le SDS ne communique pas encore avec le RP7900.

Étape 3. Allumez le RP7900.

Étape 4. Activez le SDS à l'aide du panneau avant du RP7900 ou la commande SCPI.

Aide-mémoire des menus du panneau avant	Commande SCPI
Sélectionnez System\SDS	SYST:SDS:ENAB ON
Cochez le matériel présent <input checked="" type="checkbox"/>	

Étape 5. Connectez l'appareil SDS à l'alimentation du RP7900. Si la tentative de connexion au SDS échoue, l'appareil RP7900 passera en mode de **protection SDP**.

Aide-mémoire des menus du panneau avant	Commande SCPI
Sélectionnez System\SDS\Config	SYST:SDS:CONN
Cliquez sur le bouton Connect pour connecter le SDS.	

Étape 6. (facultatif) Vous pouvez programmer le RP7900 de façon à se connecter automatiquement au SDS lors de la mise sous tension.

Aide-mémoire des menus du panneau avant	Commande SCPI
Sélectionnez System\SDS\Config	SYST:SDS:CONN:MODE AUTO
Sélectionnez Auto dans le menu déroulant Connect. Appuyez ensuite sur Select.	

Étape 7. Vérifiez l'état de connexion de l'appareil SDS comme suit :

Aide-mémoire des menus du panneau avant	Commande SCPI
---	---------------

Sélectionnez **System\SDS>Status**

SYST:SDS:STAT?

La boîte de dialogue State indiquera l'état de connexion du SDS.

Séquence d'ouverture/fermeture de relais normale

En fonctionnement normal, l'alimentation RP7900 contrôle directement l'état des relais SDS pour empêcher la commutation à chaud des relais CC. Voici la séquence de fermeture normale du SDS et de l'alimentation :

1. Fermer les relais d'alimentation
2. Activer la sortie d'alimentation
3. Programmer en aval la sortie d'alimentation
4. Fermer les relais de mesure

Voici la séquence d'ouverture normale du SDS et de l'alimentation :

1. Désactiver la sortie d'alimentation
2. Ouvrir les relais de mesure et d'alimentation

Vous pouvez choisir de verrouiller les relais de sortie du SDS fermé pour améliorer le temps de réponse de sortie des applications qui ne nécessitent pas de déconnexion de sortie physique lors de la mise sous/hors tension normale de l'alimentation RP7900 (voir **OUTput:RELAY:LOCK**).

Voici l'état « sécurisé » verrouillé du SDS après un événement de déconnexion de sécurité :

1. Les relais d'alimentation sont ouverts
2. Les relais de mesure sont ouverts
3. Le voyant « Connected » (Connecté) est éteint
4. La sortie de l'alimentation est désactivée
5. Les relais de décharge sont fermés et déchargent le DUT
6. La sortie auxiliaire est désactivée
7. La sortie universelle est désactivée

Dans le cadre de la séquence de déconnexion de sécurité, le SDS décharge les bornes UUT à un niveau inférieur à 40 V en trois secondes. Cela garantit un niveau de sécurité supplémentaire au niveau de l'appareil testé. Pour ce faire, il suffit de commuter une résistance de 25 k Ω pour l'option 500 et une résistance de 97,5 k Ω pour l'option 950 sur les bornes de sortie de l'appareil SDS. Dans le cas improbable où l'appareil testé ne coupe pas l'alimentation, les résistances du SDS sont dimensionnées de façon tolérer la consommation énergétique continue.

Protection par déconnexion du système

L'alimentation RP7900 vérifie périodiquement l'état du SDS. Si lors de la mise sous tension ou à tout autre moment, le SDS ne répond pas, le RP7900 entrera en mode de protection par déconnexion du

système (SDP) verrouillée. Si l'état du SDS indique une anomalie, le RP7900 entrera également en mode de protection SDP verrouillée. Enfin, une protection verrouillée se produira également si un contacteur CA externe est connecté, mais ne sera pas active lorsque les relais SDS sont fermés.

Une requête **SYST:SDS:STAT?** peut être utilisée pour déterminer la cause d'une SDP.

Une protection SDP ne peut être désactivée qu'en désactivant l'appareil RP7900, en corrigeant le problème et en redémarrant l'appareil RP7900.

REMARQUE Le SDS dispose d'un temporisateur de surveillance qui le mettra également en mode de sécurité en cas de perte de la communication avec l'appareil RP7900.

Contrôle du SDS à l'aide des commandes raccordées à l'extérieur

REMARQUE Le SDS doit rester connecté au RP7900 lorsqu'il est contrôlé par l'extérieur.

Les lignes de commande externes décrites dans cette section doivent être raccordées aux connecteurs appropriés à l'arrière de l'appareil SDS (voir la section d'installation). Ces lignes de commande externes offrent une couche supplémentaire de sécurité à l'opérateur, car elles permettent de programmer le SDS à l'extérieur de l'alimentation RP7900.

Commutateur d'arrêt d'urgence (ESTOP) fourni par le client

REMARQUE Si aucun commutateur de sécurité d'arrêt d'urgence n'est utilisé, vous devez raccorder la broche 1 à la broche 2 et la broche 3 à la broche 4 de l'interface distante. Si les broches ne sont pas en court-circuit, il y aura un événement de protection SDP, nécessitant une remise sous tension.

Le commutateur de sécurité ESTOP doit être un commutateur normalement fermé à deux canaux qui, lorsqu'il est pressé, met le SDS dans un état sécurisé et verrouillé, qui comprend l'ouverture des relais secteur et de mesure, ainsi que la décharge de l'appareil testé. Appuyer sur ESTOP a pour résultat un état de sécurité verrouillé exigeant que l'opérateur réinitialise le SDS pour sortir de l'état sécurisé. Les signaux ESTOP sont situés sur le connecteur de l'interface distante sur le panneau arrière du SDS.

La séquence d'ouverture en réponse à un événement ESTOP est la suivante :

1. Ouvrir les relais d'alimentation
2. Ouvrir les relais de mesure
3. Désactiver la sortie d'alimentation
4. Décharger l'appareil testé (UUT)
5. Rester dans cet état de sécurité verrouillé jusqu'à ce que l'événement ESTOP soit désactivé et que le commutateur RESET soit pressé

Lorsque le SDS est en mode ESTOP, l'alimentation indique un état d'inhibition (Inhibit (INH)). Une requête SCPI peut être utilisée pour déterminer la cause de l'inhibition de l'alimentation.

Il est recommandé de monter un commutateur de réinitialisation pour que l'opérateur puisse désactiver l'état du SDS et réactiver la sortie (voir Commutateur Reset).

Commutateur Reset fourni par le client

RESET est un commutateur d'entrée de contact à contact temporaire utilisé par l'opérateur pour réinitialiser manuellement l'appareil SDS et sortir de l'état de sécurité verrouillé. Lorsque les commutateurs ESTOP sont fermés ou que les autres anomalies sont corrigées, l'opérateur doit appuyer sur le bouton RESET pour utiliser à nouveau le système. Le commutateur RESET doit être un commutateur bleu allumé et distant, ce qui indique qu'une réinitialisation est nécessaire lorsqu'il est allumé. Un voyant RESET bleu supplémentaire se trouve également sur le panneau avant du SDS. Les signaux RESET sont situés sur le connecteur de l'interface distante sur le panneau arrière du SDS.

Le fonctionnement des voyants de réinitialisation est défini comme suit :

- S'allume lorsqu'un commutateur ESTOP se ferme
- S'allume lorsqu'une anomalie se produit (perte de puissance, perte de communication, etc.)
- S'éteint lorsque le bouton ESTOP est relâché et que le SDS et l'alimentation sont réinitialisés

Commutateurs du capot de l'appareil fournis par le client

REMARQUE Si aucun capot de l'appareil n'est utilisé, vous devez raccorder la broche 1 à la broche 2 et la broche 3 à la broche 4 du capot de l'appareil. Si les broches ne sont pas en court-circuit, il y aura un événement de protection SDP, nécessitant une remise sous tension.

Les commutateurs du capot de l'appareil doivent être des commutateurs à deux canaux, normalement ouverts, qui sont enclenchés mécaniquement sur un capot de sécurité. Ce capot de sécurité doit limiter l'accès à l'appareil testé pendant le fonctionnement normal. L'entrée du capot de l'appareil est une entrée non réinitialisable. Lorsque le capot de l'appareil est ouvert, permettant d'accéder à l'appareil testé, il s'ouvre, lançant ainsi une séquence de déconnexion. Lorsque le capot de l'appareil est fermé, tous les commutateurs se referment, remettant ainsi le SDS à l'état précédent. Les signaux du capot de l'appareil sont situés sur le connecteur du capot de l'appareil sur le panneau arrière du SDS.

La séquence de fonctionnement du SDS en réponse à une entrée du capot de l'appareil est la suivante :

1. Ouvre les relais d'alimentation
2. Ouvre les relais de mesure
3. Désactive la sortie d'alimentation
4. Décharge l'appareil testé
5. Remet le SDS et l'alimentation à l'état précédent lorsque le capot est fermé

Le SDS reste à l'état sécurisé tant que l'entrée du capot de l'appareil est vraie (ouverte). Lorsque le capot de l'appareil est ouvert, l'alimentation indique un état d'inhibition (Inhibit (INH)). Une requête SCPI peut être utilisée pour déterminer la cause de l'inhibition de l'alimentation.

Contacteur CA fourni par le client

REMARQUE Si aucun contacteur CA n'est utilisé, vous devez raccorder la broche 3 à la broche 4 du DI/DO. Si les broches ne sont pas en court-circuit, il y aura un événement de protection SDP, nécessitant une remise sous tension.

Une sortie programmable universelle, + 24 V (DOutput-1) avec un retour (DOutput-2), est disponible sur le connecteur DI/DO du panneau arrière du SDS pour commander la bobine de relais d'un contacteur CA externe. Les contacts auxiliaires normalement fermés du contacteur CA doivent également être raccordés à DInput-3 et à DInput-4 pour mesurer l'état du contacteur CA. La combinaison DInput-DOutput forme un ensemble de sécurité avec le contacteur CA.

Sélectionnez la sortie universelle comme suit :

Aide-mémoire des menus du panneau avant	Commande SCPI
Sélectionnez System\SDS\Output	SYST:SDS:DIG:DATA:OUTP 1
Indiquez un 1 pour activer la sortie générale. Appuyez ensuite sur Select.	

Le mode de fonctionnement du SDS lorsqu'un contacteur CA externe est installé est le suivant :

- Lorsque les relais SDS ou le contacteur CA sont activés (programmés pour se fermer), le SDS vérifie si le contacteur CA est actuellement ouvert (DInput-3 et DInput-4 raccordées).
- Si l'entrée numérique est raccordée, les relais du SDS et le contacteur peuvent être activés et désactivés.
- Si l'entrée numérique est ouverte sans que le contacteur soit activé, le SDS passe en mode de protection SDP.
- Si l'entrée numérique s'ouvre lorsque le contacteur est activé via le panneau avant ou une commande SCPI, les relais du SDS peuvent être activés ou désactivés.
- La vérification du contacteur du SDS se réinitialisera lorsque les relais du SDS et le contacteur seront désactivés.

REMARQUE Le temps de traitement de la commande est beaucoup plus rapide que le temps nécessaire pour changer l'état du relais du contacteur. Si vous envoyez rapidement une commande d'activation de contacteur CA, puis une commande de désactivation, puis une autre commande, l'entrée numérique pourrait lire une ouverture entraînant la protection de l'appareil.

Informations sur l'état de la commande externe

Vous pouvez réinitialiser l'état des fonctions de commande externe via le panneau avant de l'alimentation.

Aide-mémoire des menus du panneau avant	Commande SCPI
Sélectionnez System\SDS\Data\Input	non disponible
Safety Cover (Capot de sécurité) - closed or open (fermé ou ouvert)	
EStop signal (Signal EStop) - off or on (désactivé ou activé)	
Relay Control (Commande du relais) - internal or external (interne ou externe)	
Remote start (Démarrage à distance) - off or on (désactivé ou activé)	

Index

*
*CLS 231
*ESE 231
*ESR? 231
*IDN? 232
*OPC 232
*OPC? 233
*OPT? 233
*RCL 233
*RST 233
*SAV 234
*SRE 234
*STB? 235
*TRG 235
*TST? 235
*WAI 235

A

Absorption de courant 142
Accessoires 36
Aide 114
aide-mémoire des commandes 26
Alimentation secteur
 caractéristiques communes 79
 type triangle et étoile 80

Appareil de déconnexion de sécurité
 description 344
 fonctionnement 356
 installation 350
Attente de déclenchement 235
Autotest 235

C

Capot de sécurité 88
Caractères de fin de commande 204
Caractéristiques
 communes 40, 61
 RP7900 régénératifs 39, 60
caractéristiques et fonctionnalités 16
Charge capacitive 49, 68
Charge inductive 47, 66
Circulation d'air 74
CLS 231, 293
Commande FUNCTION 229
Commande LXI 244
Commande STEP 264
Commandes courantes IEEE-488 231
Commandes de compatibilité 301
Commandes de sous-système 209

Connexions
 alimentation secteur 79
 appareil unique 86
 interface 105
 parallèles 98
 principale/secondaire 101
 série 103
Consignes de sécurité 12

Contacter Keysight 15
Conventions syntaxiques 205
Coupure secteur 132
Courant 112

D

Décalage CC 114
Démontage 340
Didacticiel d'état 280
Didacticiel de déclenchement 286

E

E/S 293
 file d'attente 293
Écran
 veille 194
 verrouillage 195

EDP
 protection dynamique excessive 145

Effacer l'état 293

End-Or-Identify 205

Enregistrement des configurations 193

Entrée CA
 détails 42, 63

Environnement 73

ESE 231

ESR? 231

Étalonnage 314
 commutateurs 336
 équipement de test 304
 fréquence 315

État de réinitialisation 288

F

Factory Reset 233

FIFO (PEPS) 293

File d'attente 293
 E/S 293

fonction d'enregistrement de données 172

Fonctionnement en parallèle 133

Formulaires de relevé de test 321

G

GPIB 293

I

Identification de l'instrument 193

IDN? 232

Informations légales 9

Inspection 72

interface à distance 115

interface de commande à distance de communication 115

Introduction 203
 Langage SCPI 203

L

langage de commande
 aide-mémoire 26

Langage SCPI 203
 Introduction 203

Limitation
 sorties sinusoïdales 162

M

Maintenance 329

menus 23

menus du panneau avant 23

Message disponible 234-235

Messages d'erreur 293

Mesures en ampères-heures 177

Mesures en watts-heures 177

Mesures moyennes 176

Mise à jour du micro-programme 333

Mode de priorité
 courant 198
 tension 197

Modèles 35

Montage en baie 77

Mot de passe
 définition 195

Mots-clés 204

N

Nettoyage 14, 331

Nettoyage de la mémoire de l'instrument 335

O

Octet d'état 234

OPC 232

OPC? 233

OPT? 233

Options 36

P

Palier de sortie 155

panneau arrière 19

panneau avant 18, 20-21, 23

Paramètres non volatiles 290

Partage de courant 133

Premier entré / premier sorti 293

Principal/secondaire fonctionnement 134

Principale/secondaire programmation 136

Procédure d'autotest 332

Programmation

- absorption du courant 142
- ARB 160
- bande passante 127-128
- courant 126
- port numérique 186
- priorité 124
- protection 144
- résistance 127
- tension 125
- transitoires 151
- vitesse de balayage 126

Protection contre les sur-tensions 82

R

RCL 233

Réalisation de mesures 176

Récapitulatif des données douteuses 234-235

Récapitulatif des opérations standard 234-235

REference 26

Régénératif fonctionnement 17, 79

Registre d'octet d'état 234-235

Registre des opérations standard 234-235

Régler la surtension 113

Régler la tension de décalage CC 114

Régler la tension de sortie 111

Régler le courant de sortie 112

Réinitialisation de la configuration d'usine 293

Remballage pour l'expédition 330

Remplacement de la batterie 337

Réponse de programmation 55, 68

Représentation graphique des impédances 45, 65

Requête

- Registre de l'octet d'état 235
- Requête POWer 253
- Requêtes 204
- RST 233

S

SAV 234

Schéma d'état 285

Schéma de déclenchement 287

SCPI 203

- aide-mémoire 26
- Sécurité 73
- Séparateurs de commandes 204
- Service 329
- Service de réparation 330
- Sortie

 - courant 112
 - liste 155
 - transitoire 151

- Sorties

 - séquencement 164

- Sorties sinusoïdales 162
- Sous-système ABORt 210
- Sous-système ARB 211
- Sous-système CALibrate 213

Sous-système
 CURRent 217

Sous-système DIGital 222

Sous-système DISPlay 224

Sous-système FETCh 225

Sous-système FORMat 228

Sous-système HCOPy 230

Sous-système INITiate 237

Sous-système
 INSTrument 238

Sous-système LIST 241

Sous-système
 MEASure 245

Sous-système OUTPut 247

Sous-système SENSE 254

Sous-système SOURce 258

Sous-système STATus 259

Sous-système SYSTem 265

Sous-système TRIGger 271

Sous-système
 VOLTage 274

Spécifications
 RP7900 régénératifs 37,
 58

SRE 234

STB? 235

surchauffe 145

surintensité 144

surtension 144

Surtension 113

Système d'aide 114

Système d'état SCPI 293

T

Tension 111

Tension de décalage
 CC 114

Tension de sortie 111

TRG 235

TST? 235

Types de paramètres 206

U

Utilisation de Device
 Clear 207

V

Vérification 306
 équipement de test 304

W

WAI 235