Keysight Wireless Test Set

E6640A Wireless Test Set

Notices

© Keysight Technologies, Inc.
2014-2025

No part of this manual may be reproduced in any form or by any means (including electronic storage and retrieval or translation into a foreign language) without prior agreement and written consent from Keysight Technologies, Inc. as governed by United States and international copyright laws.

Trademark Acknowledgments

Manual Part Number

E6640-90001

Edition

Edition 1, February 2025

Supersedes: September 2024

Published by:
Keysight Technologies
1400 Fountaingrove Parkway
Santa Rosa, CA 95403

Warranty

THE MATERIAL CONTAINED IN THIS DOCUMENT IS PROVIDED "AS IS," AND IS SUBJECT TO BEING CHANGED, WITHOUT NOTICE, IN FUTURE EDITIONS. FURTHER, TO THE MAXIMUM EXTENT PERMITTED BY APPLICABLE LAW, KEYSIGHT DISCLAIMS ALL WARRANTIES, EITHER EXPRESS OR IMPLIED WITH REGARD TO THIS MANUAL AND ANY INFORMATION CONTAINED HEREIN, INCLUDING BUT NOT LIMITED TO THE IMPLIED WARRANTIES OF MERCHANTABILITY AND FITNESS FOR A PARTICULAR PURPOSE. KEYSIGHT SHALL NOT BE LIABLE FOR ERRORS OR FOR INCIDENTAL OR CONSEQUENTIAL DAMAGES IN CONNECTION WITH THE FURNISHING, USE, OR PERFORMANCE OF THIS DOCUMENT OR ANY INFORMATION CONTAINED HEREIN. SHOULD KEYSIGHT AND THE USER HAVE A SEPARATE WRITTEN AGREEMENT WITH WARRANTY TERMS COVERING THE MATERIAL IN THIS

DOCUMENT THAT CONFLICT WITH THESE TERMS, THE WARRANTY TERMS IN THE SEPARATE AGREEMENT WILL CONTROL.

Technology Licenses

The hardware and/or software described in this document are furnished under a license and may be used or copied only in accordance with the terms of such license.

U.S. Government Rights

The Software is "commercial computer software," as defined by Federal Acquisition Regulation ("FAR") 2.101. Pursuant to FAR 12.212 and 27.405-3 and Department of Defense FAR Supplement ("DFARS") 227.7202, the U.S. government acquires commercial computer software under the same terms by which the software is customarily provided to the public.

Accordingly, Keysight provides the Software to U.S. government customers under its standard commercial license, which is embodied in its End User License Agreement (EULA), a copy of which can be found at

<http://www.keysight.com/find/sweula>

The license set forth in the EULA represents the exclusive authority by which the U.S. government may use, modify, distribute, or disclose the Software. The EULA and the license set forth therein, does not require or permit, among other things, that Keysight: (1) Furnish technical information related to commercial computer software or commercial computer software documentation that is not customarily provided to the public; or (2) Relinquish to, or otherwise provide, the government rights in excess of these rights customarily provided to the public to use, modify, reproduce, release, perform, display, or disclose commercial computer software or commercial computer software documentation. No additional

government requirements beyond those set forth in the EULA shall apply, except to the extent that those terms, rights, or licenses are explicitly required from all providers of commercial computer software pursuant to the FAR and the DFARS and are set forth specifically in writing elsewhere in the EULA. Keysight shall be under no obligation to update, revise or otherwise modify the Software. With respect to any technical data as defined by FAR 2.101, pursuant to FAR 12.211 and 27.404.2 and DFARS 227.7102, the U.S. government acquires no greater than Limited Rights as defined in FAR 27.401 or DFAR 227.7103-5 (c), as applicable in any technical data.

Safety Notices

CAUTION

A **CAUTION** notice denotes a hazard. It calls attention to an operating procedure, practice, or the like that, if not correctly performed or adhered to, could result in damage to the product or loss of important data. Do not proceed beyond a CAUTION notice until the indicated conditions are fully understood and met.

WARNING

A **WARNING** notice denotes a hazard. It calls attention to an operating procedure, practice, or the like that, if not correctly performed or adhered to, could result in personal injury or death. Do not proceed beyond a WARNING notice until the indicated conditions are fully understood and met.

Where to Find the Latest Information

Documentation is updated periodically. For the latest information about these products, including instrument software upgrades, application information, and product information, browse to one of the following URLs, look for the name of your product:

<https://www.keysight.com/find/exm>

To receive the latest updates by email, subscribe to Keysight Email Updates at the following URL:

<https://www.keysight.com/find/MyKeysight>

Information on preventing instrument damage can be found at:

<https://www.keysight.com/find/PreventingInstrumentRepair>

Is your product software up-to-date?

Periodically, Keysight releases software updates to fix known defects and incorporate product enhancements. To search for software updates for your product, go to the Keysight Technical Support website at:

<https://www.keysight.com/find/techsupport>

Product and Solution Cybersecurity

Keysight complies with multinational regulations for the cybersecurity of its own products and is committed to providing information to assist you in protecting your products and solutions from external cyber threats. For more information, see:

<https://www.keysight.com/us/en/about/quality-and-security/security/product-and-solution-cyber-security.html>

Keysight also recommends that you secure your IT environments using appropriate third-party tools. For instruments that run the Microsoft Windows operating system, Keysight concurs with Microsoft's recommendations for ensuring that the instrument is protected:

- Get the latest critical Windows updates
- For network-connected instruments, use an Internet firewall (in Keysight instruments, Windows Firewall is enabled by default)
- For network-connected instruments, use up-to-date antivirus and anti-spyware software

Responsible Disclosure Program

Keysight recommends that security researchers share the details of any suspected vulnerabilities across any asset owned, controlled, or operated by Keysight (or that would reasonably impact the security of Keysight and our users) using this form:

<https://www.keysight.com/us/en/contact/responsible-disclosure-program.html>

Report a Product Cybersecurity Issue

If you discover a cybersecurity issue that you suspect may involve Keysight's proprietary software, or third-party software supplied by Keysight as part of a product, or that may affect the operation of Keysight products, we encourage you to report it to us using this form:

<https://www.keysight.com/us/en/about/quality-and-security/security/product-and-solution-cyber-security/report-a-product-cybersecurity-issue>

Table of Contents

Quick-Start 11

- About the Test Set 12
 - Elements of the TRX 13
 - Input/Output Matrix (M9432A, Option 2FD) 14
 - Input/Output Matrix (M9433A, Option 4FD) 15
- Initial Inspection 16
 - Shipping problems? 17
- Test Set Location and Mounting Requirements 18
 - Locating the test set 18
 - Cooling and rack mounting 18
- Separate Application Interfaces 19
 - MultiTouch Interface 20
 - Traditional Interface 21
- Desktop Icons 22
 - TRX Configurator 23
 - Launch XSA 24
 - Configure Applications 25
- Turning on the test set the first time 27
 - Initializing the test set 27
- Options and Licenses 32
 - Checking Options (MultiTouch Interface) 32
 - Checking Options (Traditional Interface) 33
 - Option 2FD 34
 - Option 4FD 34
 - Frequency Range Options 35
 - Bandwidth Options 35
 - MIMO Options 35
- Anti-Virus Software and Firewalls 36
- Shortening the Test Set Power-On Time 36
- Instrument Safety & Environmental Information 37
 - Power requirements 37
 - Environmental Conditions (Operating) 38
 - EMC (Electromagnetic Compatibility) 39
 - Ventilation 40
 - Instrument Maintenance 40
 - Protecting against electrostatic discharge 42

Contents

Front and Rear Panel Features 43

- Front Panel Features 44
 - Controller Hardware Interface 45
 - TRX Module Hardware Interface 47
 - Reference Module Hardware Interface 49
 - Virtual Front Panel (Traditional Interface) 50
 - When the Test Set is Controlled Remotely 52
 - Display Annotations (MultiTouch interface) 53
 - Display Annotations (Traditional Interface) 55
- Rear Panel Features 57
- Front and Rear Panel Symbols 58

Test Set Operating System 61

- Keysight Software Installed 62
 - Measurement Software Applications 62
- Customer Installation of Software 63
 - 3rd party software verified by Keysight 63
 - Installation of other 3rd party software 63
- User Accounts 64
 - Administrator login 64
 - User login 64
 - Customer creation of accounts 65
- Licensing 66
 - Licensed Applications 66
 - Flexible Software Licensing 67
- Licensing New Measurement Application Software - After Initial Purchase 68
 - Installation procedure over USB 68
- Transporting a License Between Test Sets 70
 - Procedure for Transporting a License, Neither Test Set Connected to the Internet 70
- Windows Configuration 73
 - Settings that can be changed 73
 - Settings that must not be changed 74
- Configuring Printers 76
- Configuring LAN 76
 - Hostname 76
 - IP Address & Gateway 76
- Windows Security 77
 - Windows Firewall 78
 - Automatic updates 79
 - Virus protection 80

Spyware protection	80
System Maintenance	81
Backup	81
System restore	81
Disk defragmenting	81
USB Connections	82
Hard Drive Partitioning and Use	84
Hard Drive Recovery Process	85
Updating the software	87
Configuring recovery prompt timing	94
OperatingTasks: System-Level Tasks	95
TRX Selection	96
Using HiSLIP	97
Using Socket Ports	97
Using VXI-11/SICL	97
Using Telnet Connection	97
Port Configuration	98
Full Duplex Port Setup (RFIO 1 and RFIO 2)	99
Separate Input and Output Port Setup (RF3 I O and RF4 I O)	101
Separate Input and Output Port Setup (RFIO 1 and RFIO 2)	105
Option 4FD: Full Duplex Port Setup	107
Option 4FD: Separate Input and Output Port Setup	108
Millimeter-Wave Accessory Instruments	109
Switched MIMO	114
Constraints on Radio Standards	114
MIMO Port Configuration	114
Source Sync Control	115
RF Input Port Mode	115
Half Duplex RF Input	116
Acquisition Triggers	116
Acquisition Integration	116
Acquisition RF Input Port	117
Switched MIMO Modulation Accuracy measurement SCPI commands	118
Switched MIMO Results	120
True MIMO	121
TRX Configurations	121
Source Settings for MIMO	124
Constraints on Waveform File Names	126
Constraints on TRX Selection	126
Constraints on Radio Standards	127

Contents

MIMO Type	127
Remote Analyzer Configuration (MultiTouch Interface)	127
Remote Analyzer Configuration (Traditional Interface)	129
MIMO Modulation Analysis measurement SCPI commands	131
MIMO Modulation Analysis Results	132
Tx Beam Forming	135
Tx Beam Forming Commands	135
Tx Beam Forming Results	136
E6640A Calibration Status	137
Certificates of Calibration	138
Alignments (MultiTouch Interface)	139
“All” Alignment (daily use)	139
Weekly alignment procedure	140
Alignment statistics	141
Alignments (Traditional Interface)	142
“All” Alignment (daily use)	142
Weekly alignment procedure	143
LAN Address Configuration	145
Managing Licenses	147
Flexible Software Licensing	148
Operating Tasks: Receiver Setup	149
Measurement Setup (MultiTouch Interface)	150
Measurement Setup (Traditional Interface)	154
Marker Setup (MultiTouch Interface)	157
Marker Setup (Traditional Interface)	159
Operating Tasks: Source Setup	161
General RF Source Setup	162
Loading and Running Waveform Files (MultiTouch Interface)	163
Loading and Running Waveform Files (Traditional Interface)	166
Creating Waveform Sequences (MultiTouch Interface)	168
Using the waveform sequence (MultiTouch interface)	169
Creating Waveform Sequences (Traditional Interface)	170
Using the waveform sequence (Traditional interface)	172
Using Waveform Markers	173
Waveform Marker Settings (MultiTouch Interface)	174
Waveform Marker Settings (Traditional Interface)	175
Generating Trigger Outputs (MultiTouch Interface)	177
Generating Trigger Outputs (Traditional Interface)	178

- Locking Waveform Files (MultiTouch Interface) 179
- Locking Waveform Files (Traditional Interface) 181
- Header Utilities (MultiTouch Interface) 183
- Header Utilities (Traditional Interface) 184

Windows Operating System 185

- Navigating Windows Without a Mouse 186
- Remote Desktop: Using the Test Set Remotely 187
 - Overview of Remote Desktop operation 187
 - Setting up Remote Desktop operation 188
 - How to locate the computer name of the test set 189
 - Running a Remote Desktop session 191
 - The Virtual Front Panel 201
- Programmatic Control of the Test Set 202
- Capturing/Printing Displays and Windows 203
- Windows Shortcuts and Miscellaneous Tasks 204
 - Windows shortcuts (key combinations) 204
 - Windows taskbar auto-hide feature 206
 - Windows startup folder 208

Troubleshooting 209

- Check the Basics 210
- Problems with Microsoft Windows Operating System 212
- Returning a test set for Service 213
 - Read the Warranty 213
 - Service Options 213
 - Calling Keysight Technologies 213
 - Locations for Keysight Technologies 213
 - Packaging the Test Set 214

Contents

1 Quick-Start

This section explains how to initialize the test set and generate and view a signal.

[“About the Test Set” on page 12](#)

[“Initial Inspection” on page 16](#)

[“Test Set Location and Mounting Requirements” on page 18](#)

[“Separate Application Interfaces” on page 19](#)

[“Desktop Icons” on page 22](#)

[“Turning on the test set the first time” on page 27](#)

[“Options and Licenses” on page 32](#)

[“Anti-Virus Software and Firewalls” on page 36](#)

[“Shortening the Test Set Power-On Time” on page 36](#)

[“Instrument Safety & Environmental Information” on page 37](#)

About the Test Set

The E6640A EXM Wireless Test set contains one to four Keysight M943xA TRXs. The specific TRX model number is dependent on the options and applications ordered with the test set:

- M9432A (Option 2FD) has 2 half-duplex and 2 full-duplex ports.
- M9433A (Option 4FD) has 4 full-duplex ports.

NOTE

Two older TRX models are no longer being manufactured, but it is usually possible to repair and recalibrate them if necessary: M9430A (2 half-duplex and 2 full-duplex ports), and M9431A (4 full-duplex ports).

NOTE

The M9432A TRX is not currently supported by the 5G NR test application.

Elements of the TRX

Each TRX contains the full set of hardware elements illustrated below. Two separate examples are shown, for models M9432A (Option 2FD) and M9433A (Option 4FD).

Figure 1-1 TRX elements

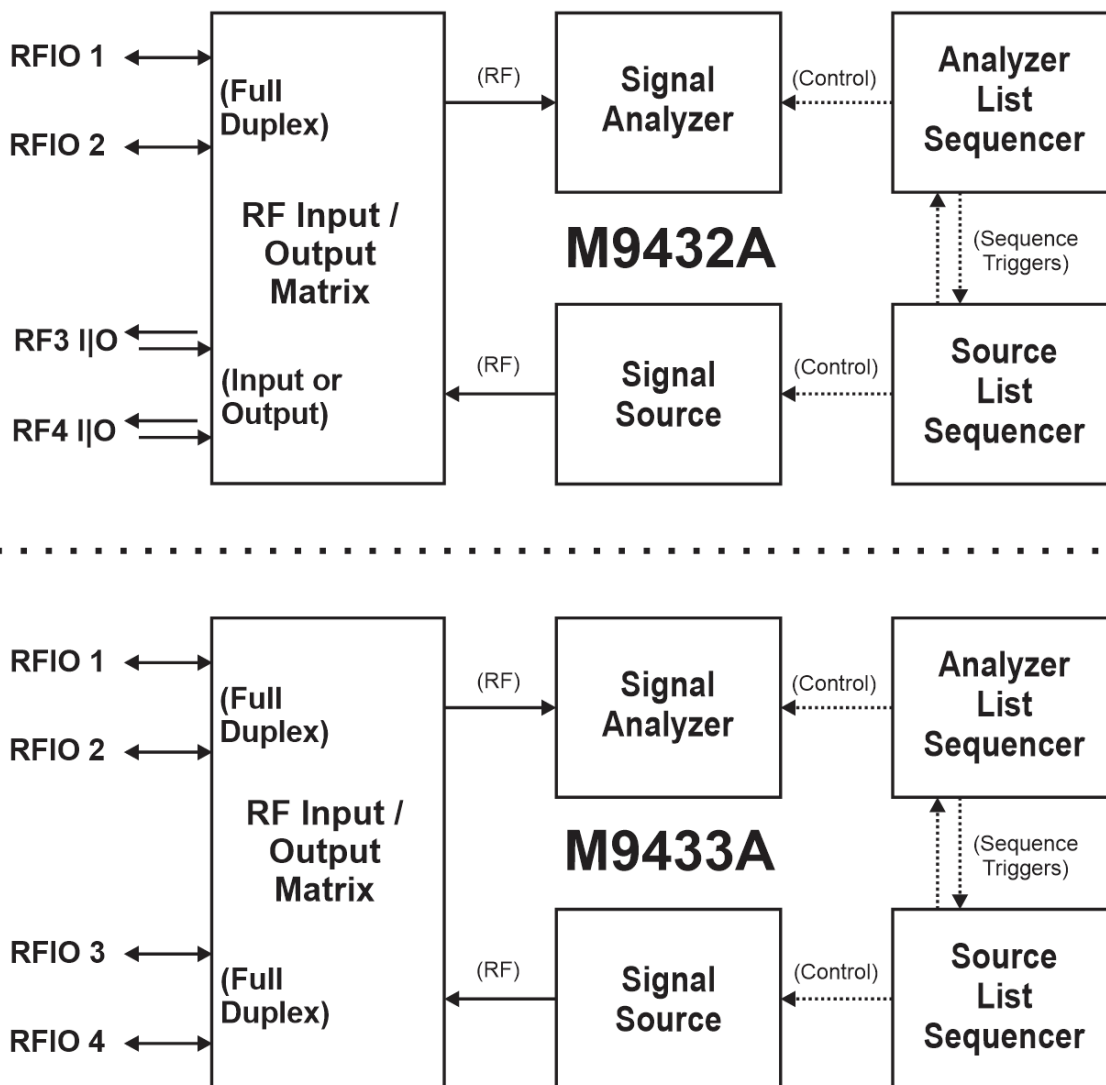

Each TRX is run by its own instance of the XSA firmware application. A fully loaded test set shows four independent XSA windows on its monitor display.

The TRX includes a signal analyzer and a signal source, both of which interface with the front panel of the test set through an input/output matrix, and each of which is controlled by an independent list sequencer (the two sequencers exchange trigger signals to coordinate their operations).

Input/Output Matrix (M9432A, Option 2FD)

The input/output matrix is illustrated below, for the M9432A TRX. Ports RFIO 1 and RFIO2 are full-duplex ports (simultaneously inputs and outputs). Ports RF3 I/O and RF4 I/O can be inputs or outputs, but not simultaneously.

Figure 1-2 M9432A input/output matrix

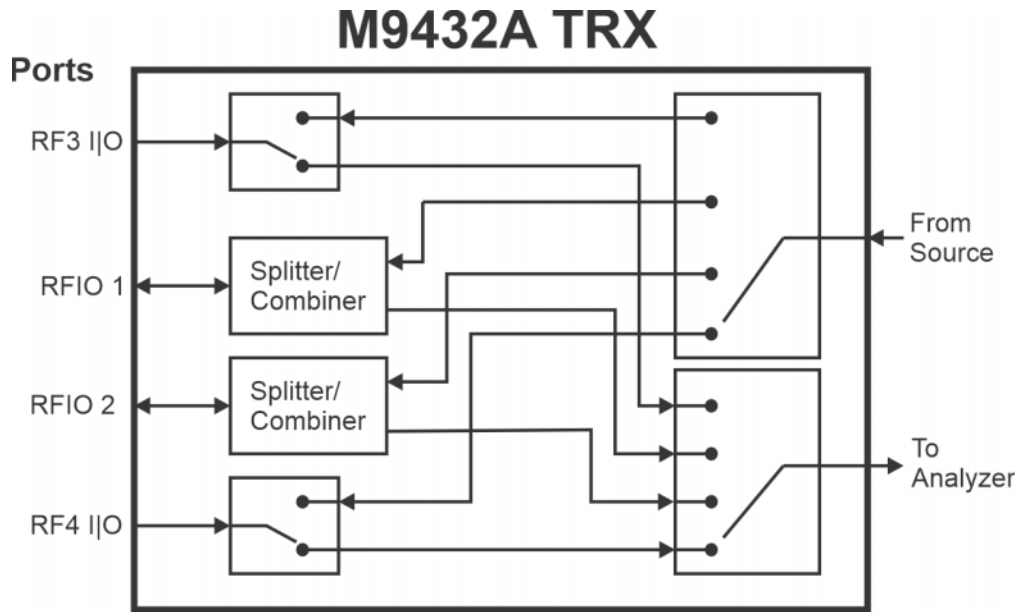

See "Port Configuration" on page 98 for more information.

Input/Output Matrix (M9433A, Option 4FD)

The input/output matrix is illustrated below, for the M9433A TRX. Ports RFIO 1 through RFIO4 are full-duplex ports (simultaneously inputs and outputs).



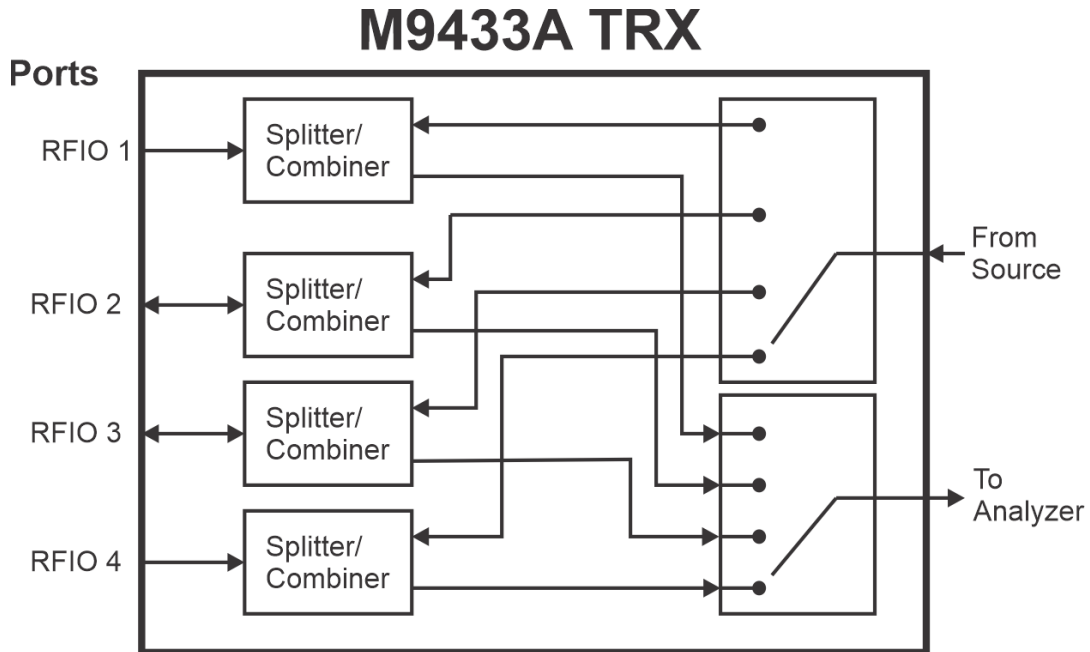

Figure 1-3 M9433A input/output matrix



See "Port Configuration" on page 98 for more information.

Initial Inspection

Inspect the shipping container and the cushioning material for signs of stress. Retain the shipping materials for future use, as you may wish to ship the test set to another location or to Keysight Technologies for service.

Item	Deliverable	Notes
Keysight Model E6640A		EXM Wireless Test Set
USB keyboard & mouse		A keyboard and mouse for communication with the controller and measurement applications. (These accessories are provided only if options E6640A-KYB and E6640A-MSE are ordered.)
Monitor cable adapter (Display Port to VGA)		An adapter for the front panel Display Port which makes it possible to use the test set with a monitor which has a VGA connector.
Software Entitlement Certificates		Redemption certificates for the measurement options purchased.
Power cable		Connection for test set power.

Shipping problems?

If the shipping materials are damaged or the contents of the container are incomplete:

- Contact the nearest Keysight Technologies office.
- Keep the shipping materials for the carrier's inspection.
- If you must return an test set to Keysight Technologies, use the original (or comparable) shipping materials. See **“Returning a test set for Service” on page 183.**

Test Set Location and Mounting Requirements

Locating the test set

Make sure that the fan inlet and exhaust vent areas on the sides, bottom, and back of the test set chassis are not obstructed. The minimal required clearance is 1 inch (25 cm). Airflow restrictions cause additional airflow noise and cause the fans to speed up so they can draw in enough air for the required cooling resulting in excessive audible noise.

It is recommended to orient the instrument horizontally (as illustrated below), not vertically, and at least half a meter above the floor.

Cooling and rack mounting

Do not mount the test set side-by-side with any other instrument with side-by-side ventilation. Make sure the exhaust air from one instrument is directed away from the inlet of any other instrument (heated air directed into the inlet of an instrument can cause instrument failure due to excessive operating temperatures). The test set draws air in from the sides and bottom of the chassis and exhausts air from the back.

Figure 1-4 EXM front panel view



Separate Application Interfaces

There are two different interfaces available for test applications which run on the EXM (the newer **MultiTouch** interface and the older **Traditional** interface). Any TRX can be set up to use either interface.

Figure 1-5 Traditional interface and MultiTouch interface

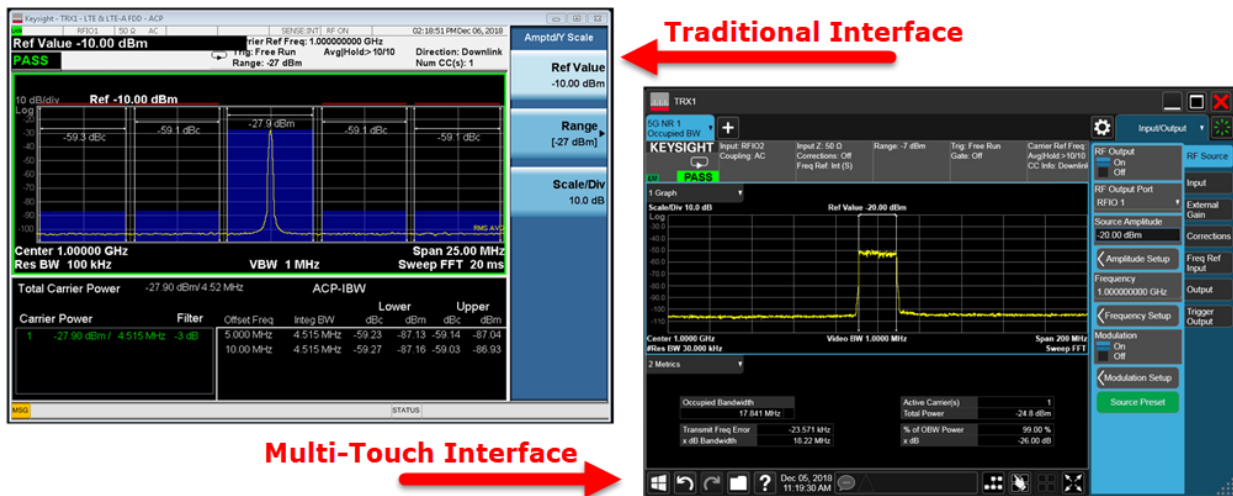

Because there are some differences in menu structure between the two interfaces, many EXM procedures are performed in a slightly different way, depending on which of the two interfaces a TRX is running.

The **MultiTouch** interface is the recommended choice, because its menus are easier to navigate.

SCPI commands to a TRX are the same regardless of which interface it is running.

NOTE

This guide describes procedures primarily with reference to the **MultiTouch** interface. However, alternative instructions are also provided, where necessary, for users who prefer to use the **Traditional** interface.

MultiTouch Interface

The MultiTouch interface features a set of menus accessible from the right pane of the display. Many of the menu selections open a temporary configuration window (for example, the window for setting the RF power level shown in the illustration below).

Figure 1-6

MultiTouch Interface

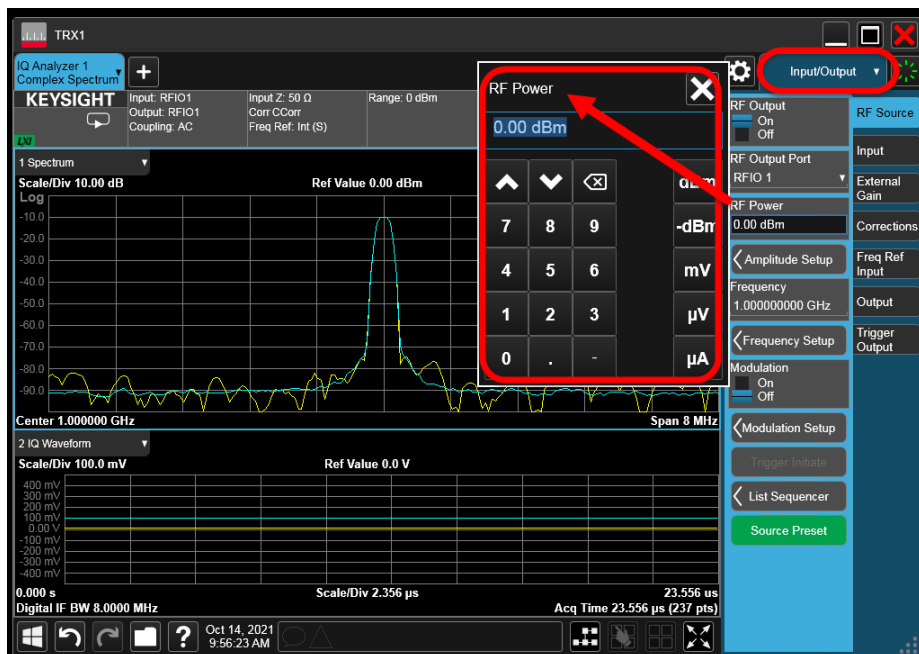

In addition to the menus, the interface also provides a set of **System** setting windows and a **Preset** menu, accessed by means of the gear icon and the green-flash icon at the top right section of the application window.

Figure 1-7

MultiTouch system & preset icons

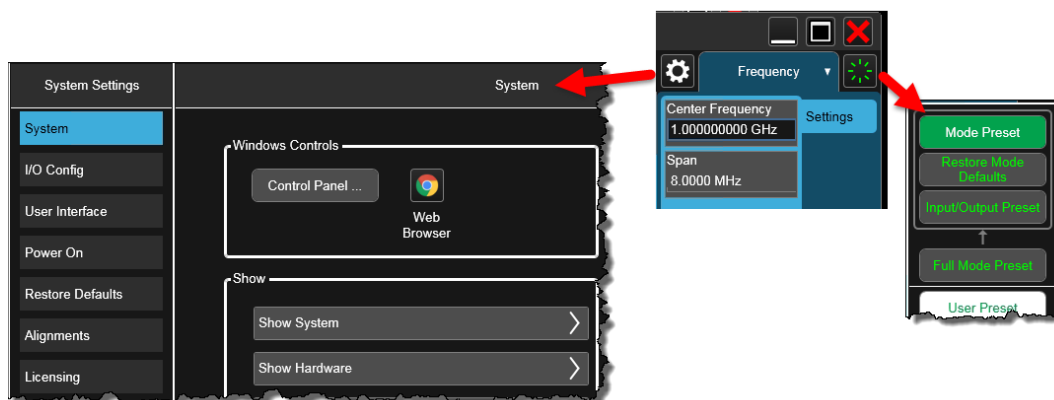

Traditional Interface

The Traditional interface also displays menus in the right pane, but in this case the menu must be selected from a **Virtual Front Panel** popup window. This window is accessed by right-clicking on the display and selecting **Utility** > **Virtual Front Panel** in the temporary menu which appears.

Figure 1-8 Traditional interface

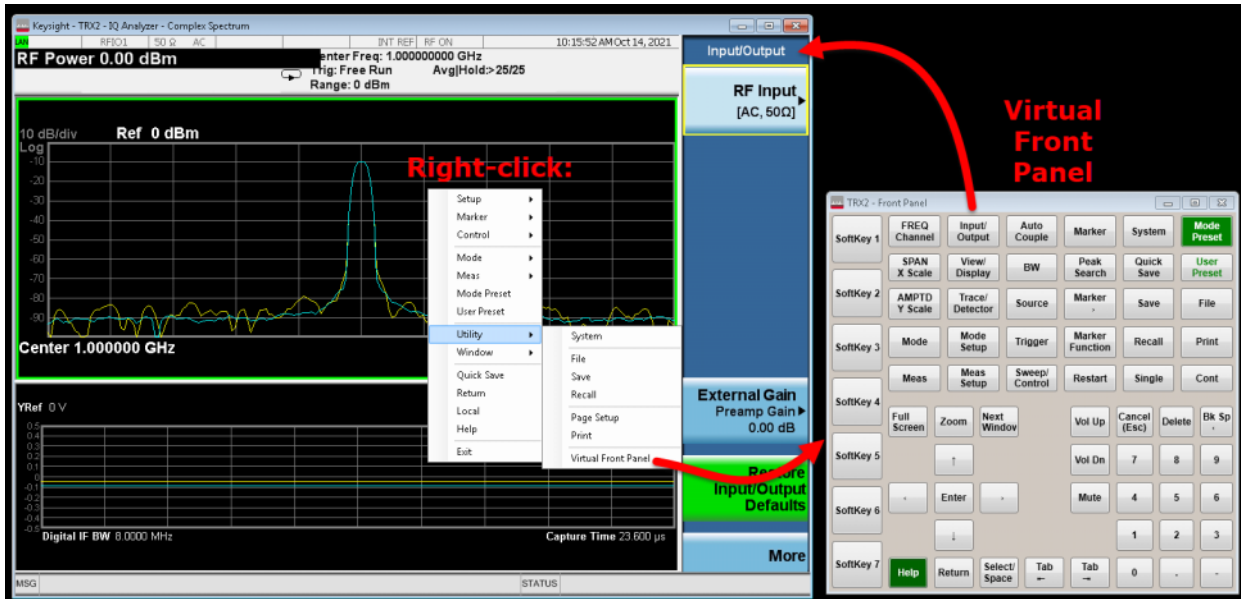

Once a menu has been selected, it appears in the right pane of the display (however, not all menu items are shown at once; use the **More** key at the bottom of the menu pane to find any menu selections which are not immediately visible).

Desktop Icons

Four desktop icons provide access to utilities which support the E6640A's measurement firmware.

Click the **Configure Applications** icon to specify which measurements are to be loaded and run at launch. (This is for the **Traditional** interface.) Or: click the **Configure Applications MultiTouch UI** icon to specify which measurements are to be loaded and run at launch. (This is for the **MultiTouch** interface.)

NOTE

Separate versions of the **Configure Applications** window are needed because a few of the E6640A measurement applications are supported in one interface but not in the other.

Figure 1-9

Desktop icons

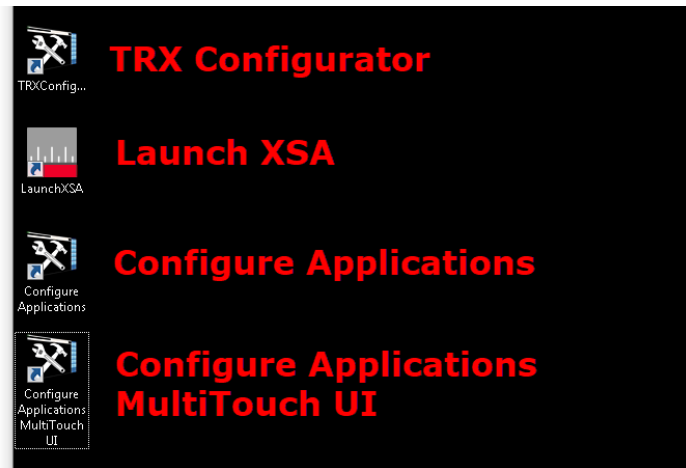

TRX Configurator

Use the **TRX Configurator** icon (at the left edge of the desktop display) to open the configurator.

The **TRX Configurator** shows which of the four possible TRXs are installed in the PXIe rack, and identifies them by SCPI address. At a minimum, TRX1 must be installed, and cannot be disabled using this tool. However, the other TRXs, if installed, can be enabled or disabled using the **Enable** checkboxes in the **xSA Configuration** column.

In the **GUI Type**, column, use the dropdown selector to choose the interface type for each of the installed TRXs (**MultiTouch** or **Traditional**). Then click **Save**.

Figure 1-10 TRX Configurator

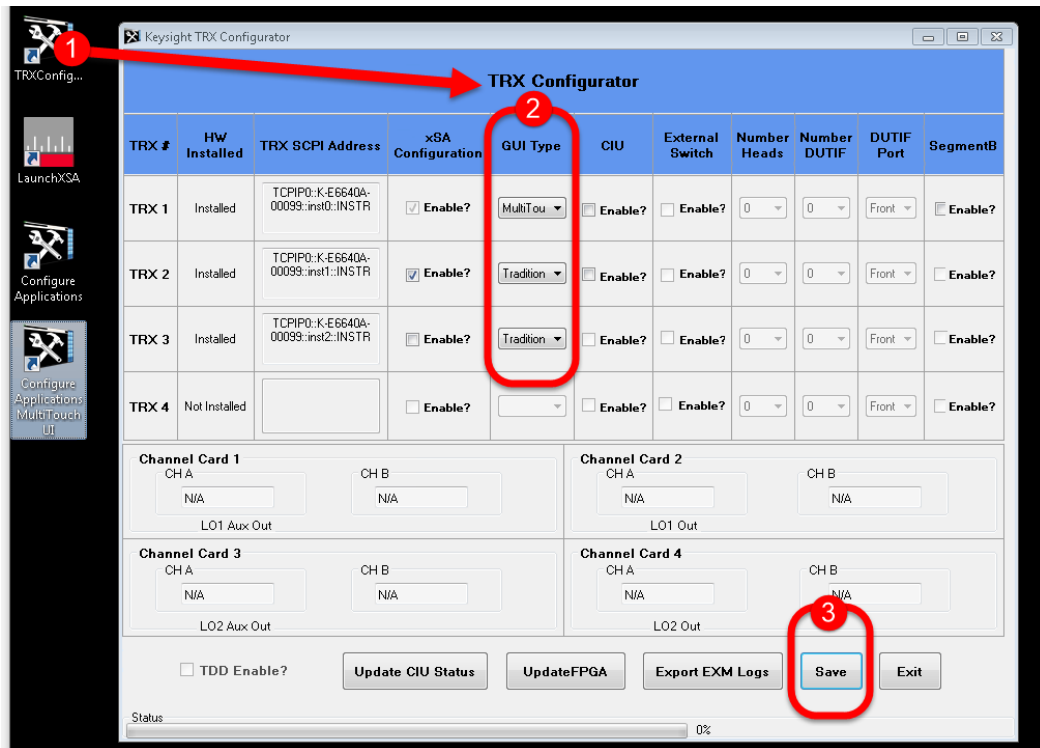

When you use the **Launch XSA** desktop icon to start the measurement applications, separate application windows open for each active TRX, and each TRX window has the type of interface you selected for it.

The **UpdateFPGA** button is used when installing a new TRX into an E6640A which was purchased without it, to ensure software compatibility.

Launch XSA

Use the **Launch XSA** icon to open an application window for each TRX which is (1) installed and (2) enabled in the **TRX Configurator**. The application window will have whichever interface was selected for that TRX in the configurator. (In the example below, **TRX3** is running the **Traditional** interface, and **TRX1** is running the **MultiTouch** interface.)

Figure 1-11 Launching XSA applications

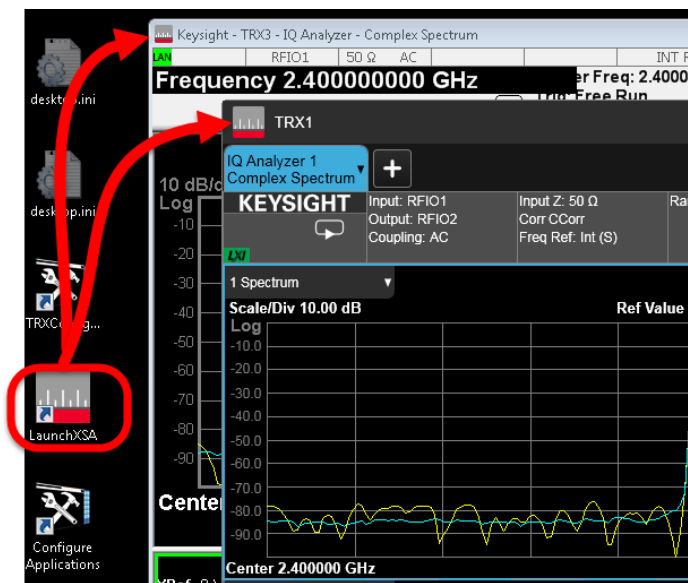

If you have closed any of the XSA application windows, you can reopen them without rebooting, by clicking the Launch XSA icon. This will only open a window for a given TRX if it is enabled in the TRX Configurator.

Minimized windows can be reopened by finding the icon representing them in the Windows taskbar.

Figure 1-12 Reopening minimized windows

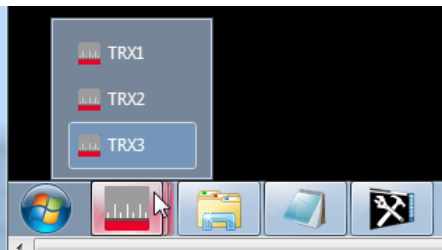

Configure Applications

Click the **Configure Applications** icon to launch this utility, which allows you to specify which of the E6640A's X-series measurement applications will be preloaded into memory at startup. Preloading the most frequently-used applications is a convenience (however, selecting fewer of them for preload shortens the startup time and uses less memory).

Configure Applications (MultiTouch Interface)

Click the **Configure Applications** icon to launch this utility, which allows you to specify which of the E6640A's X-series measurement applications will be preloaded into memory at startup. Preloading the most frequently-used applications is a convenience (however, selecting fewer of them for preload shortens the startup time and uses less memory).

If an application is not listed here, this indicates that the application is not supported by the **MultiTouch** interface.

Figure 1-13 Configure Applications MultiTouch

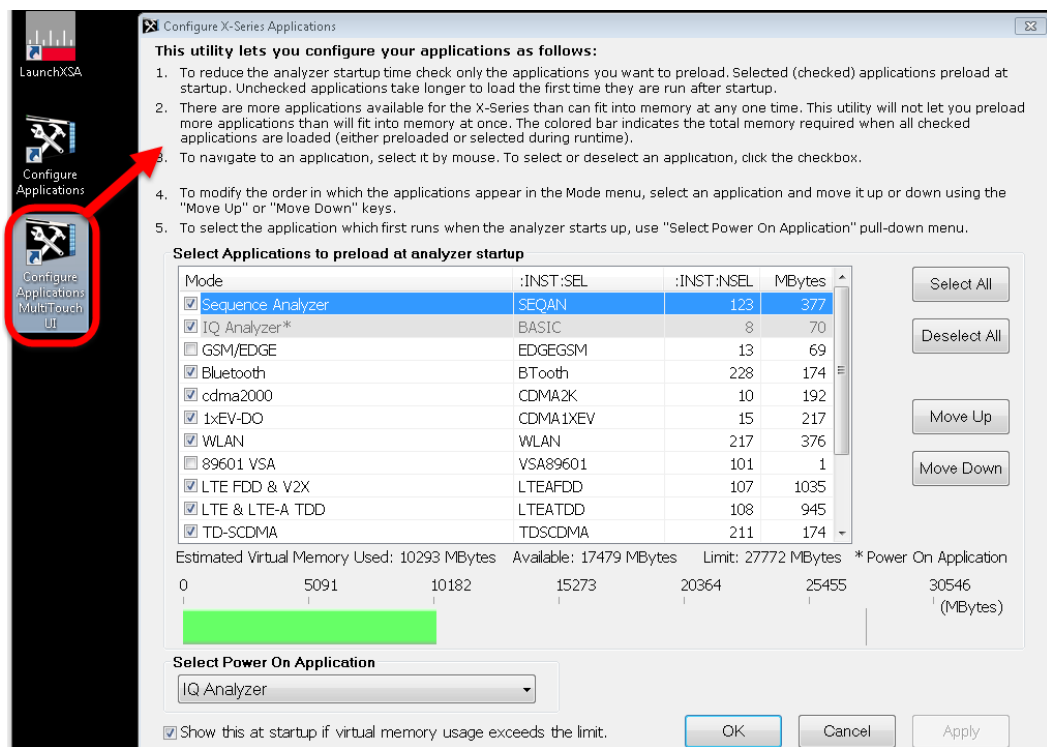

Use the selection table to specify which application will be running when the E6640A starts up.

Applications which are not pre-loaded at startup can be loaded later if needed, simply by making the necessary mode/measurement selections.

Configure Application (Traditional Interface)

This version of the **Configure Applications** window is specific to the **Traditional** interface; see the following page for the **MultiTouch** interface version. If an application is not listed here, this indicates that the application is not supported by the **Traditional** interface.

Figure 1-14 Configure Applications

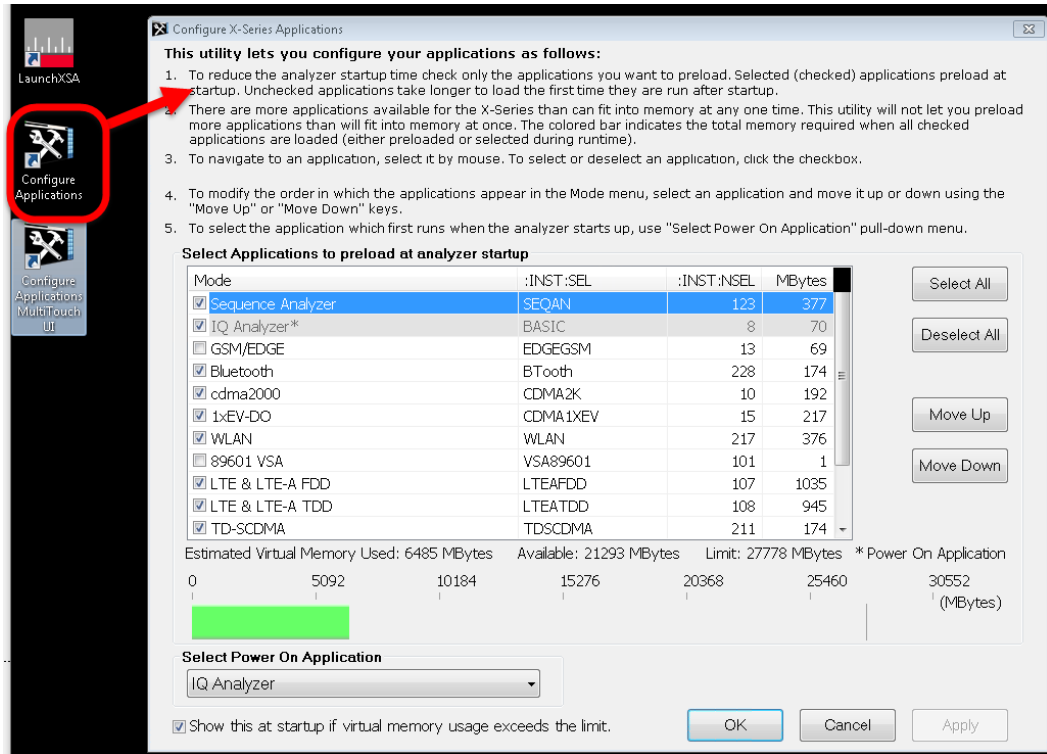

Use the selection table to specify which application will be running when the E6640A starts up.

Applications which are not pre-loaded at startup can be loaded later if needed, simply by making the necessary mode/measurement selections.

Turning on the test set the first time

NOTE

During the initial power-on process, the test set turns off and restarts several times. This *only* happens during the initial installation process.

Initializing the test set

NOTE

This procedure requires that a monitor, keyboard, and mouse are connected to the E6640A.

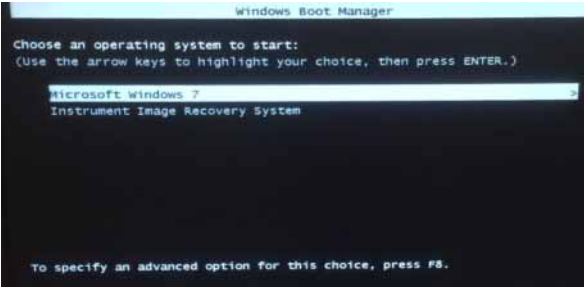
Item	Deliverable	Notes
1 Connect a mouse and keyboard	Connect the mouse and keyboard to two of the USB ports on the front panel of the test set.	
2 Connect a monitor	Connect the monitor to the monitor port on the front panel of the test set.	Model E6640A has no display; an external monitor is required. See “Virtual Front Panel” on page 28.
3 Power on the test set	Position the test set so you have easy access to the power cord and plug it in. Press the power switch (located near the top right corner of the PXI rack) to turn the test set on.	See “Test Set Location and Mounting Requirements” and “Power requirements” on page 37 for more details. The test set can require more than 5 minutes to power-on. This is affected by Windows start-up requirements. The Keysight Technologies screen appears. 
4 Launch Microsoft Setup Wizard	Highlight Microsoft Windows and press Enter to start the pre-installed operating system.	At this time, it is safe to turn off the test set before starting the Setup Wizard. 

Quick-Start
Turning on the test set the first time

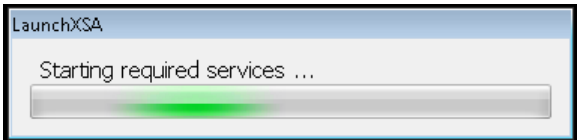
Item	Deliverable	Notes
	<p>The analyzer performs the following steps:</p> <ul style="list-style-type: none"> Windows Startup window Black screen Windows message window, "Please wait while windows prepares to setup" Keysight window <p>At this time, it is safe to turn off the instrument before initializing the software.</p>	
<p>CAUTION</p>	<p>After launching the setup, do not turn off the instrument or remove power before the Setup Wizard completes and the system restarts. Turning off the instrument may corrupt the system and the application may not operate.</p>	
<p>5 Reboot and log on</p>	<p>Click OK.</p>	<p>When the instrument restarts, the following message window appears:</p>  <p>The system reboots. Several required processes continue. The system reboots. The XSA application initializes</p>
<p>6</p>		<p>Separate instances of the application are launched for each TRX installed in the PXI rack (they are identified as "TRX1" through "TRX4" in the upper left corner of the application window). The verification procedures which follow should be done for all TRXs in the rack. (The following figures show the visual differences between the two possible interfaces.)</p>

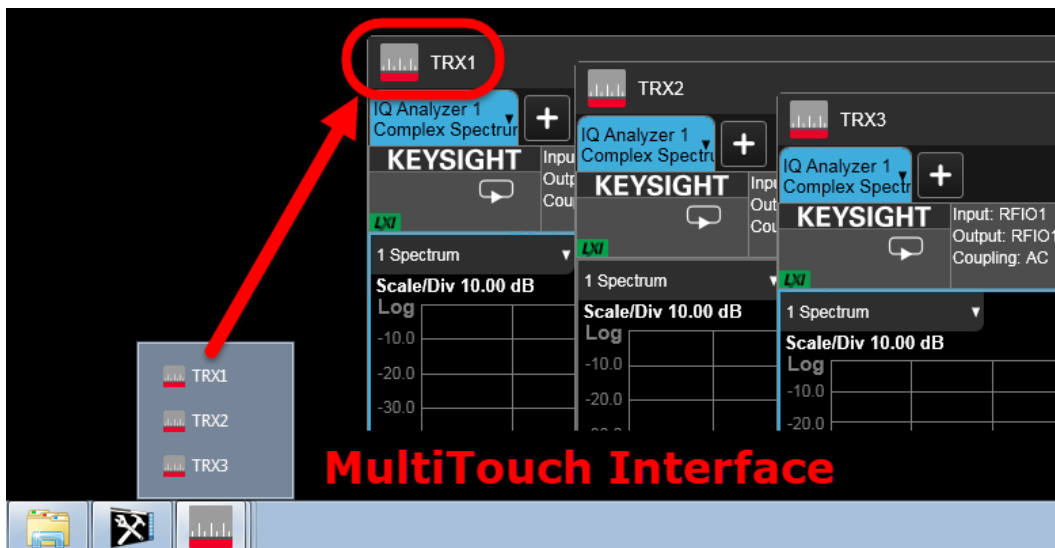

Quick-Start
Turning on the test set the first time

Item	Deliverable	Notes
------	-------------	-------

Traditional Interface

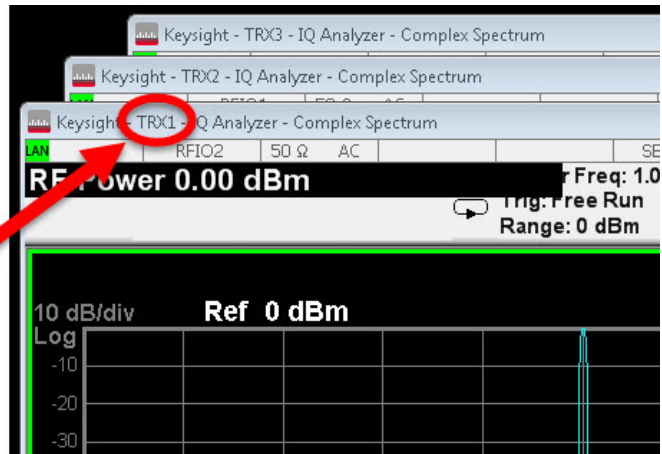
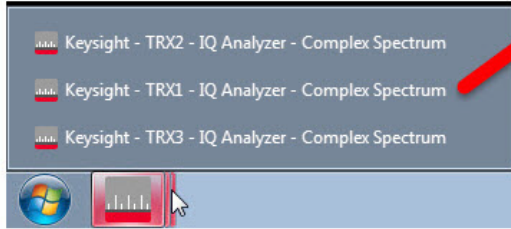

<p>7 Verify the installation (Traditional Interface)</p>	<p>From the mouse right-click menu, select Utility > Virtual Front Panel. (All key-presses that follow refer initially to a key shown on the Virtual Front Panel, and then to whatever menu keys that key makes available.)</p> <p>Press System > Show > System.</p> <p>Verify that the purchased application(s) appear in the list.</p>	<p>If you require further assistance, contact the Keysight support team. Online assistance: http://www.keysight.com/find/assist</p>
<p>8 Verify the installation (MultiTouch Interface)</p>	<p>Open the System window by clicking on the gear icon</p> <p>Press System > Show System.</p> <p>Verify that the purchased application(s) appear in the list.</p>	<p>If you require further assistance, contact the Keysight support team. Online assistance: http://www.keysight.com/find/assist</p>
<p>9 Attach a loopback cable</p>	<p>Use an RF cable to connect the front panel RFIO 1 and RFIO 2 ports for this TRX.</p>	<p>The purpose is to use a loopback cable to verify that the test set's source can generate a signal and the test set's analyzer can measure it.</p>

Quick-Start
Turning on the test set the first time

Item	Deliverable	Notes
10 Generate and view a signal (Traditional interface)	<p>Press Input/Output > RF Input > RF Input Port > RFIO 1.</p> <p>Press Input/Output > More > RF Output & Test Set Config > RF Output Port > RFIO 2.</p> <p>Press AMPTD Y Scale > Ref Value > 10 > dBm.</p> <p>Press FREQ > Center Freq > 2.4 > GHz.</p> <p>Press SPAN X Scale > Span > 8 > MHz.</p> <p>Press Source > Frequency > 2.4 > GHz.</p> <p>Press Source > RF Output > On.</p> <p>Press Source > Amplitude > RF Power > -15 dBm.</p> <p>Press Peak Search.</p>	<p>Select RFIO 1 as the input port</p> <p>Select RFIO 2 as the output port.</p> <p>Set the amplitude reference to 10 dBm</p> <p>Set the analyzer center frequency to 2.4 GHz.</p> <p>Set the analyzer span to 8 MHz.</p> <p>Set the source frequency to 2.4 GHz.</p> <p>Set the source RF output to On.</p> <p>Set the source amplitude to -15 dBm.</p> <p>To ensure accurate power levels from the source, see “Alignments” on page 36.</p>

The 2.4 GHz signal appears on the display.

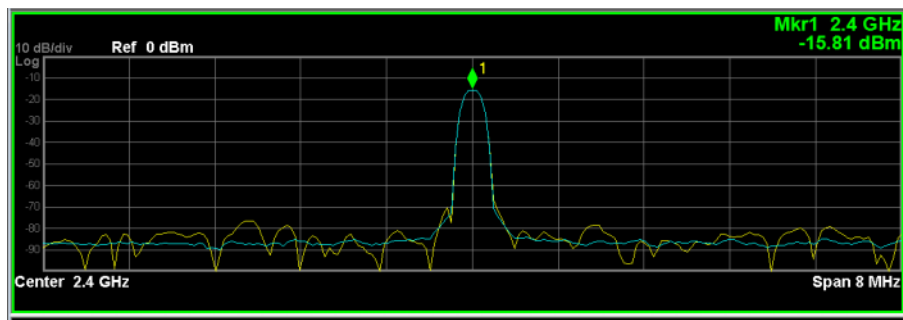

Quick-Start
Turning on the test set the first time

Item	Deliverable	Notes
11 Generate and view a signal (MultiTouch interface)	Press Input/Output > Input > RF Input Port, RFIO 1.	Select RFIO 1 as the input port
	Press Input/Output > RF Source > RF Output Port, RFIO 2.	Select RFIO 2 as the output port.
	Press Amplitude > Scale/Div > 10 > dB.	Set the amplitude reference to 10 dBm
	Press Frequency > Center Frequency > 2.4 > GHz.	Set the analyzer center frequency to 2.4 GHz.
	Press Frequency > Span > 8 > MHz.	Set the analyzer span to 8 MHz.
	Press Input/Output > Frequency > 2.4 > GHz.	Set the source frequency to 2.4 GHz.
	Press Input/Output > RF Source > RF Output > On.	Set the source RF output to On.
	Press Input/Output > RF Source > RF Power > 15 > -dBm.	Set the source amplitude to -15 dBm.
Press Peak Search > Peak Search.	To ensure accurate power levels from the source, see “Alignments” on page 36.	

The 2.4 GHz signal appears on the display.

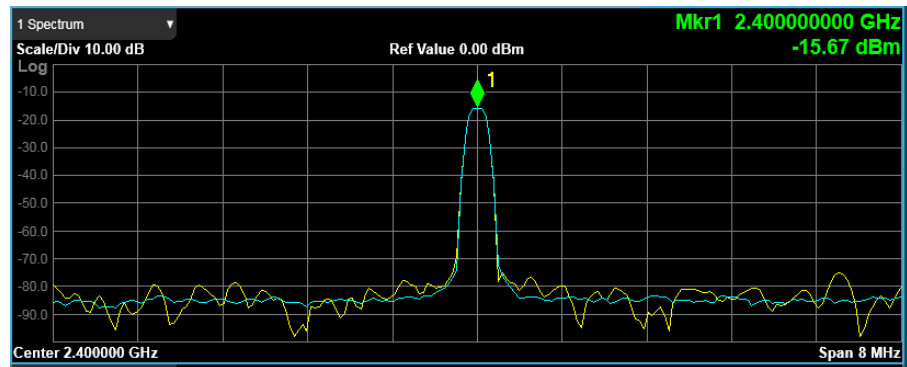

Options and Licenses

Checking Options (MultiTouch Interface)

The options and licenses installed on the test set are listed on the **System > Show System** display, as illustrated below. Certain features of the test set (such as its frequency range, its analysis bandwidth, the measurement applications it runs, and in some cases individual measurements within an application) are licensed features, and are unavailable if the appropriate license is not installed.

Figure 1-15 Checking options (MultiTouch)

Option	Name / Description	Option Version
Y9077EM1E	WLAN 802.11ac/ax Measurement Application	1.3.61325.18779
Y9079EM0E	TD-SCDMA Measurement Application (Remote Control Only)	1.3.61325.18779
Y9080B-1FP	LTE Measurement Application	---
Y9080B-2FP	LTE-Adv FDD Measurement Application	---
Y9080B-BFP	LTE Feature Enhancements	---
Y9080EM0E	LTE-Adv FDD Measurement Application	1.3.61325.18779
Y9080EM4E	LTE V2X Measurement Application	1.3.61325.18779
Y9081B-2FP	Bluetooth Measurement Application	---
Y9081B-3FP	Bluetooth 5 Measurement Application	---
Y9081B-AFP	Bluetooth Measurement Application	---
Y9081B-BFP	Bluetooth Feature Enhancements	---
Y9081EM0D	Bluetooth Measurement Application	---
Y9081EM0E	Bluetooth Measurement Application	1.3.61325.18779
Y9082EM0E	LTE-TDD Measurement Application	1.3.61325.18779
Y9084EM0E	Short Range Comms and IoT Application	1.3.61325.18779
Y9085EM0E	5G NR Measurement Application	1.3.61325.18779

NOTE

Hardware-related options such as frequency range and analysis bandwidth are specific to the TRX; measurement applications apply to any TRX in the same test set chassis.

Checking Options (Traditional Interface)

The options and licenses installed on the test set are listed on the **System > Show > System** display, as illustrated below. Certain features of the test set (such as its frequency range, its analysis bandwidth, the measurement applications it runs, and in some cases individual measurements within an application) are licensed features, and are unavailable if the appropriate license is not installed.

Figure 1-16 Checking options (Traditional)

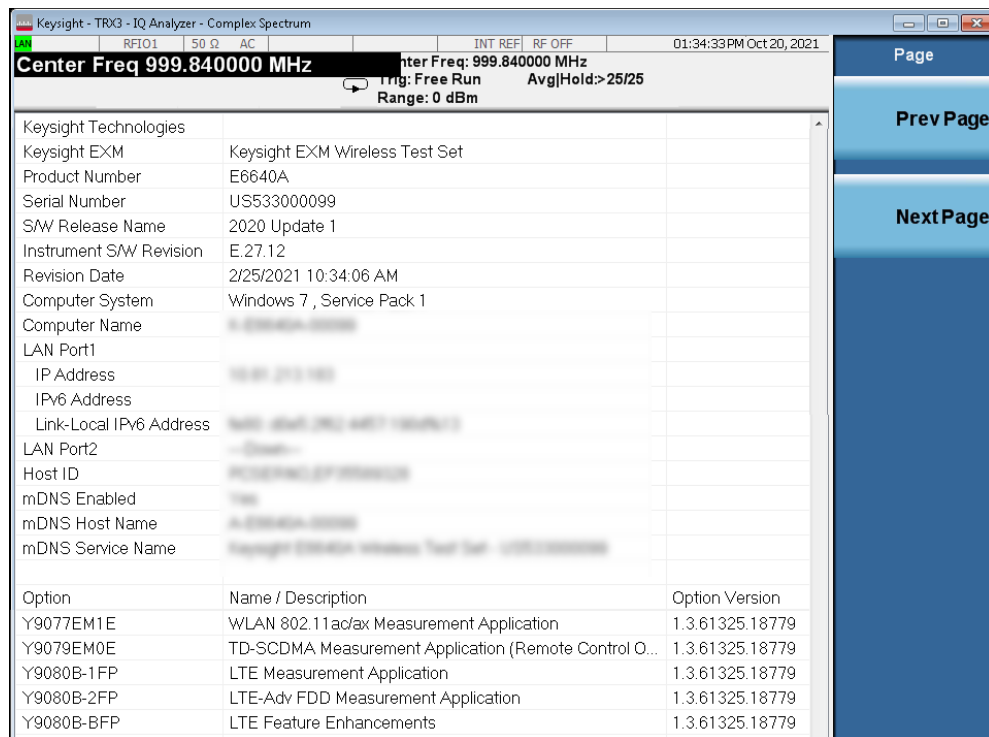

The screenshot displays the Keysight TRX3 IQ Analyzer software interface. The top status bar shows 'Center Freq: 999.840000 MHz', 'Trig: Free Run', and 'AvgJHold: >25/25'. Below this, a table lists system information:

Keysight Technologies		
Keysight EXM	Keysight EXM Wireless Test Set	
Product Number	E6640A	
Serial Number	US533000099	
SAW Release Name	2020 Update 1	
Instrument SAW Revision	E.27.12	
Revision Date	2/25/2021 10:34:06 AM	
Computer System	Windows 7 , Service Pack 1	
Computer Name	A-228646-00000	
LAN Port1		
IP Address	192.168.253.100	
IPv6 Address		
Link-Local IPv6 Address	fe80::424b:28c2:4877:1646%11	
LAN Port2	-None-	
Host ID	F022746C277000000000	
mDNS Enabled	Yes	
mDNS Host Name	A-228646-00000	
mDNS Service Name	Keysight-EXM-Wireless-Test-Set-10000000000	

Option	Name / Description	Option Version
Y9077EM1E	WLAN 802.11ac/ax Measurement Application	1.3.61325.18779
Y9079EM0E	TD-SCDMA Measurement Application (Remote Control O...	1.3.61325.18779
Y9080B-1FP	LTE Measurement Application	1.3.61325.18779
Y9080B-2FP	LTE-Adv FDD Measurement Application	1.3.61325.18779
Y9080B-BFP	LTE Feature Enhancements	1.3.61325.18779

NOTE

Hardware-related options such as frequency range and analysis bandwidth are specific to the TRX; measurement applications apply to any TRX in the same test set chassis.

Option 2FD

Option 2FD modifies the RFIO interface of the E6640A EXM Wireless Test Set as follows:

- Each TRX in the test set has a model designation M9432A.
- Ports RFIO 1 and RFIO2 are full-duplex ports (simultaneously inputs and outputs). Ports RF3 I/O and RF4 I/O are half-duplex ports (they can be inputs or outputs, but not simultaneously).
- Performance characteristics for the four ports are described in the E6640A EXM Wireless Test Set Data Sheet.
- Port settings found under the **Input/Output** menu (and equivalent SCPI commands) reflect the options installed.

See **“Port Configuration” on page 98** for more information.

Option 4FD

Option 4FD modifies the RFIO interface of the E6640A EXM Wireless Test Set as follows:

- Each TRX in the test set has a model designation M9433A.
- All four ports (RFIO 1, RFIO 2, RFIO 3, and RFIO 4) on each module are full-duplex ports (that is, any port can be used simultaneously as an RF input (to the test set’s analyzer) and as an RF output (from the test set’s source)).
- Any of the TRX’s four RFIO ports can be configured as a full duplex port; it can also be configured as an input port (accepting a signal to be analyzed), with a separate port configured as an output port (providing an RF stimulus).
- Performance characteristics for all four ports are same as those described for ports RFIO 1 and RFIO 2 in the E6640A EXM Wireless Test Set Data Sheet.
- Port settings found under the **Input/Output** menu (and equivalent SCPI commands) reflect the options installed.

See **“Port Configuration” on page 98** for more information.

Frequency Range Options

Option E6640A-504

380 MHz to 3.8 GHz (cellular communications)

Option E6640A-5WC

1.1 to 1.8, 2.3 to 2.6, and 4.8 to 6 GHz (wireless connectivity)

Option E6640A-506

380 MHz to 6 GHz (cellular communications and wireless connectivity)

Option E6640A-5B0 (required for 5G NR testing)

380 MHz to 6 GHz with 5G NR bands (cellular communications and wireless connectivity)

Option E6640A-5LF

76-110 MHz and 207-222 MHz (Tx only)

Bandwidth Options

(Standard bandwidth is 40 MHz.)

Option E6640A-B1X (required for 5G NR testing)

160 MHz bandwidth

MIMO Options

Option E6640A-M22

Up to 2x2 True MIMO

Option E6640A-M33

Up to 3x3 True MIMO

Option E6640A-M44

Up to 4x4 True MIMO

Anti-Virus Software and Firewalls

No anti-virus software is shipped with the test set. It is recommended that you install anti-virus software if your test set is connected to the LAN. Check with your IT department to see what they recommend.

The test set is shipped with the Windows firewall enabled. Do not modify the default network settings as this may cause problems with the operating system of the test set.

Keysight recommends installing Windows updates. This should be enabled in Windows security settings.

Shortening the Test Set Power-On Time

You can set the configuration to pre-load only the applications that you typically run. This can significantly shorten the time it takes for your test set to power-on. See **“Configure Applications” on page 25** for more information.

If (after power-on) you want to access an application that you did not pre-load, it will take a little longer to bring it up once you press the application softkey. This longer time-frame is only for the first access after power-on. After the initial access, mode (application) switching will operate as quickly as if the application had been pre-loaded.

Instrument Safety & Environmental Information

NOTE

This product has been designed and tested in accordance with accepted industry standards and has been supplied in a safe condition. The documentation contains information and warnings that must be followed by the user to ensure safe operation and to maintain the product in a safe condition.

WARNING

The input terminals for this product are classified as Measurement Category None. Intended for other circuits not directly connected to mains.

WARNING

Safety of any system incorporating the equipment is the responsibility of the operator of the system.

Power requirements

The only physical installation of your Keysight test set is a connection to a power source. Line voltage does **not** need to be selected.

This test set does **not** contain customer serviceable fuses.

WARNING

This is a Safety Class 1 Product (provided with a protective earthing ground incorporated in the power cord). The mains plug shall only be inserted in a socket outlet provided with a protective earth contact. Any interruption of the protective conductor inside or outside of the product is likely to make the product dangerous. Intentional interruption is prohibited.

Failure to ground the test set properly can result in personal injury. Before turning on the test set, you must connect its protective earth terminals to the protective conductor of the main power cable. Insert the main power cable plug into a socket outlet that has a protective earth contact only. **DO NOT** defeat the earth-grounding protection by using an extension cable, power cable, or autotransformer without a protective ground conductor.

WARNING

This instrument has autoranging line voltage input. Before switching on the instrument, be sure the supply voltage is within the specified range.

The Mains wiring and connectors shall be compatible with the connector used in the premise electrical system. Failure, to ensure adequate earth grounding by not using the correct components may cause product damage, and serious injury.

AC power cord

The test set is equipped with a three-wire power cord, in accordance with international safety standards. This cable grounds the test set cabinet when connected to an appropriate power line outlet. The cable appropriate to the original shipping location is included with the test set. See:

<http://www.keysight.com/find/powercords>

CAUTION

Always use the three-prong AC power cord supplied with this product. Failure to ensure adequate earth grounding by not using this cord can cause product damage.

This instrument has auto-ranging line voltage input; be sure the supply voltage is within the specified range and voltage fluctuations do not to exceed 10 percent of the nominal supply voltage:

100-120 VAC 50/60 Hz, 1000 W MAX
220-240 VAC 50/60 Hz, 1200 W MAX.

WARNING

If this product is not used as specified, the protection provided by the equipment could be impaired. This product must be used in a normal condition (in which all means for protection are intact) only.

Install the instrument so that the detachable power cord is readily identifiable and easily reached by the operator. The detachable power cord is the instrument disconnecting device. It disconnects the mains circuits from the mains supply before other parts of the instrument. The front panel switch is only a standby switch and is not a LINE switch.

Environmental Conditions (Operating)

This product is designed for use in the following conditions:

- For indoor use only
- Temperature 5°C to 45°C
- Altitude up to 3000 meters
- Maximum Relative Humidity (non-condensing): 95%RH up to 40°C, decreases linearly to 73%RH at 45°C. ¹

CAUTION

This product is designed for use in Installation Category II and Pollution Degree 2.

1. From 40°C to 45°C, the maximum % Relative Humidity follows the line of constant dew point.

EMC (Electromagnetic Compatibility)

This product complies with the essential requirements of the European EMC Directive and the UK Electromagnetic Compatibility Regulations 2016, as well as current editions of the following standards (dates and editions are cited in the Declaration of Conformity):

- IEC/EN 61326-1
- CISPR Pub 11 Group 1, class A
- AS/NZS CISPR 11
- ICES/NMB-001

This ISM device complies with Canadian ICES-001.

Cet appareil ISM est conforme a la norme NMB-001 du Canada.

CAUTION

This equipment is not intended for use in residential environments and may not provide adequate protection to radio reception in such environments.

South Korean Class A EMC declaration

This equipment is Class A suitable for professional use and is for use in electromagnetic environments outside of the home.

A 급 기기 (업무용 방송통신기자재) 이 기기는 업무용 (A 급) 전자파적합기기로서 판매자 또는 사용자는 이 점을 주의하시기 바라며 , 가정외의 지역에서 사용하는 것을 목적으로 합니다 .

Declaration of Conformity

The Declaration of Conformity for any Keysight product can be found on the website:

<http://www.keysight.com/go/conformity>

Ventilation

CAUTION

VENTILATION REQUIREMENTS: When installing the product in a cabinet, the convection into and out of the product must not be restricted. The ambient temperature (outside the cabinet) must be less than the maximum operating temperature of the product by 40C for every 100 watts dissipated in the cabinet. If the total power dissipated in the cabinet is greater than 800 watts, then forced convection must be used.

Instrument Maintenance

Cleaning the instrument

WARNING

To prevent electrical shock, disconnect the test set from mains before cleaning. Use a dry cloth or one slightly dampened with water to clean the external case parts. Do not attempt to clean internally.

Cleaning the connectors

WARNING

Cleaning connectors with alcohol shall only be done with the instrument power cord removed, and in a well-ventilated area. Allow all residual alcohol moisture to evaporate, and the fumes to dissipate prior to energizing the instrument.

Battery Information

The test set uses a lithium battery located on the CPU board. This is not an operator replaceable part. See **“Returning a test set for Service” on page 183**. Replaceable parts must be approved or supplied by Keysight Technologies.

You can order the service documentation for the instrument through your Keysight Sales and Service office.

WARNING

Danger of explosion if battery is incorrectly replaced. Replace only with the same or equivalent type recommended. Discard used batteries according to the manufacturer's instructions.

Do not throw batteries away but collect as small chemical waste.



**DO NOT THROW BATTERIES AWAY BUT
COLLECT AS SMALL CHEMICAL WASTE.**

Protecting against electrostatic discharge

Electrostatic discharge (ESD) can damage or destroy electronic components (the possibility of unseen damage caused by ESD is present whenever components are transported, stored, or used).

Test equipment and ESD

To help reduce ESD damage that can occur while using test equipment:

WARNING

Do not use these first three techniques when working on circuitry with a voltage potential greater than 500 volts.

- Before connecting any coaxial cable to a test set connector for the first time each day, momentarily short the center and outer conductors of the cable together.
- Personnel should be grounded with a 1 M Ω resistor-isolated wrist-strap before touching the center pin of any connector and before removing any assembly from the test set.
- Be sure that all instruments are properly earth-grounded to prevent build-up of static charge.
- Perform work on all components or assemblies at a static-safe workstation.
- Keep static-generating materials at least one meter away from all components.
- Store or transport components in static-shielding containers.
- Always handle printed circuit board assemblies by the edges. This reduces the possibility of ESD damage to components and prevent contamination of exposed plating.

Additional information about ESD

For more information about ESD and how to prevent ESD damage, contact the Electrostatic Discharge Association (<http://www.esda.org>). The ESD standards developed by this agency are sanctioned by the American National Standards Institute (ANSI).

2 Front and Rear Panel Features

The following topics can be found in this section:

[“Front Panel Features” on page 44](#)

[“Rear Panel Features” on page 57](#)

[“Front and Rear Panel Symbols” on page 58](#)

Front Panel Features

The test set consists of instruments loaded in a PXI rack, hidden behind a front panel. There is a controller (located on the far left), and one to four TRX (transmit/receive) sub-instruments, each of which includes an RF signal generator and an RF signal analyzer. A frequency-reference instrument, shared by all the TRX sub-instruments, is placed in the center.

Figure 2-1 EXM Front Panel

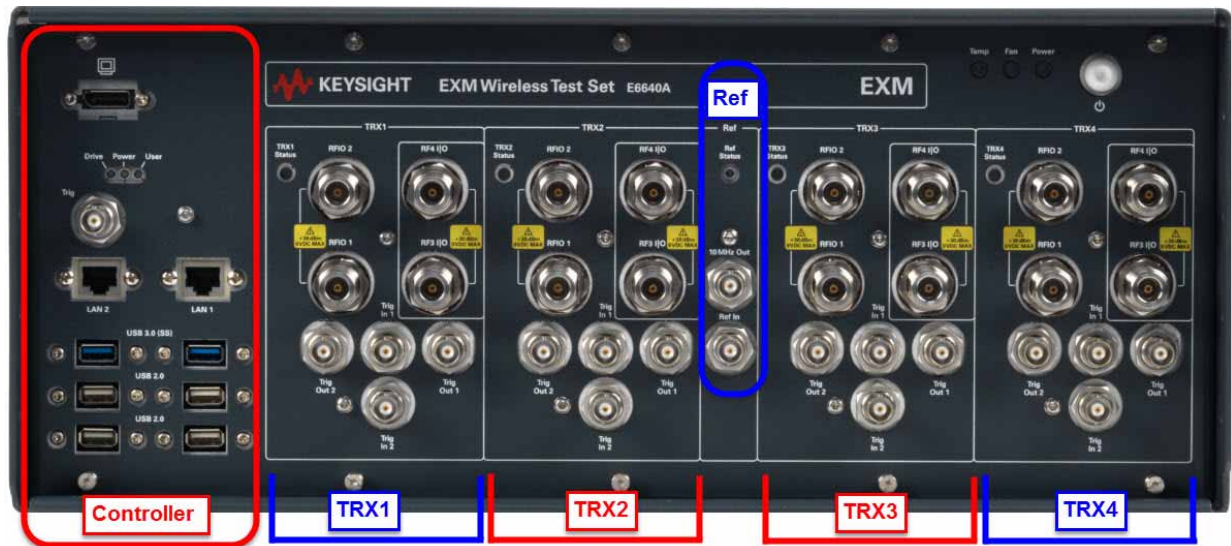

Controller Hardware Interface

The controller's front panel features are illustrated below:

Figure 2-2 Controller front panel



Number	Item Name	Description
1	Monitor Port	This connector supports a connection to a monitor with a DisplayPort input.
2	LED Indicators	<ul style="list-style-type: none">– DRIVE: When the Solid State Drive is active, the LED will flash.– POWER: If the LED is on, the power supply to the controller is good and the system should boot.– USER: Not used.
3	TRIG	This trigger line is not used by the E6640A.

Front and Rear Panel Features
Front Panel Features

Number	Item Name	Description
4	LAN Connectors	Two TCP/IP Interface connectors that are used for remote test set operation. Choose the LAN 1 port to have an IP address assigned to the test set dynamically, using DHCP. If your local network does not support DHCP, choose the LAN 2 port to use a private static IP address. (See “LAN Address Configuration” on page 105.)
5	USB 3.0	The controller provides two USB 3.0 ports.
6	USB 2.0	The controller provides four USB 2.0 ports.

TRX Module Hardware Interface

There can be as many as four TRX modules in the PXI rack; each has the same hardware interface, as illustrated below.

NOTE

If the E6640A test set was purchased with Option 4FD, all four RF ports have full-duplex capability, therefore two of the ports are labeled and used differently than they are described below. See [“Option 4FD” on page 14.](#)

Figure 2-3

TRX module front panel



Number	Item Name	Description
1	TRXn STATUS	When the PXI chassis is powered on, the STATUS LED for each TRX module lights red when the software application controlling the TRX hardware begins loading. When the software application is done loading, the LED will be green the TRX will be ready for use.
2	RFIO 2	This Type N connector is a full-duplex RF input/output port.
3	RFIO 1	This Type N connector is a full-duplex RF input/output port.

Front and Rear Panel Features
Front Panel Features

Number	Item Name	Description
4	TRIG OUT 2	A trigger output used to synchronize other test equipment with the test set. Configurable from the Input/Output keys.
5	TRIG IN 1	A trigger input used to synchronize other test equipment with the test set. Configurable from the Input/Output keys.
6	RF4 I/O	This Type N connector is a half-duplex RF port which can be configured as an input or an output. (If Option 4FD is installed, see “Option 2FD” on page 34.)
8	RF3 I/O	This Type N connector is a half-duplex RF port which can be configured as an input or an output. (If Option 4FD is installed, see “Option 2FD” on page 34.)
9	TRIG OUT 1	A trigger output used to synchronize other test equipment with the test set. Configurable from the Input/Output keys.
10	TRIG IN 2	A trigger input used to synchronize other test equipment with the test set. Configurable from the Input/Output keys.

Reference Module Hardware Interface

The connectors which are exposed when the impact cover is in place are illustrated below:

Figure 2-4 Reference module front panel



Number	Item Name	Description
1	10 MHz OUT	This BNC input port provides a timebase reference output from the M9300A Reference module.
2	REF IN	This BNC input port accepts a timebase reference input to the Ref In port of the M9300A Reference module.

Virtual Front Panel (Traditional Interface)

The E6640A model does not include physical front-panel keys. However, if you have a PC mouse, monitor, and keyboard plugged in (or are working through a Remote Desktop interface), you can navigate front-panel functions using the virtual front panel (VFP) shown below. Access the VFP as follows:

1. Right-click the mouse.
2. Left-click Utility (1) in the menu, as shown below.
3. Left-click Virtual Front Panel (2) in the menu, as shown below.

WARNING

The PC mouse and monitor are required when using the E6640A. For ease in using the VFP, the PC keyboard is recommended.

Figure 2-5 Accessing the virtual front panel

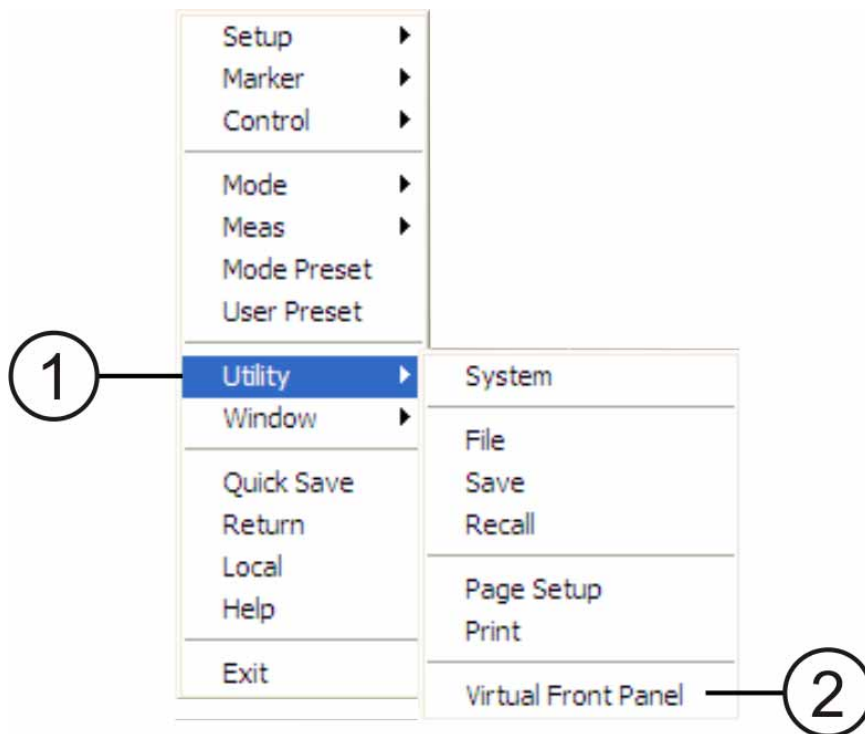

On the VFP the keys labeled **SoftKey 1** through **SoftKey 7** function as the menu keys. Using the mouse to click on a combination of the VFP keys and the menu keys on the display screen, you can operate the instrument as if it had conventional front-panel keys. The VFP frame shows the **TRX** number at the upper left corner of the frame, so that it's clear which sub-instrument within the PXI rack is being controlled by it.

Figure 2-6 VFP keys

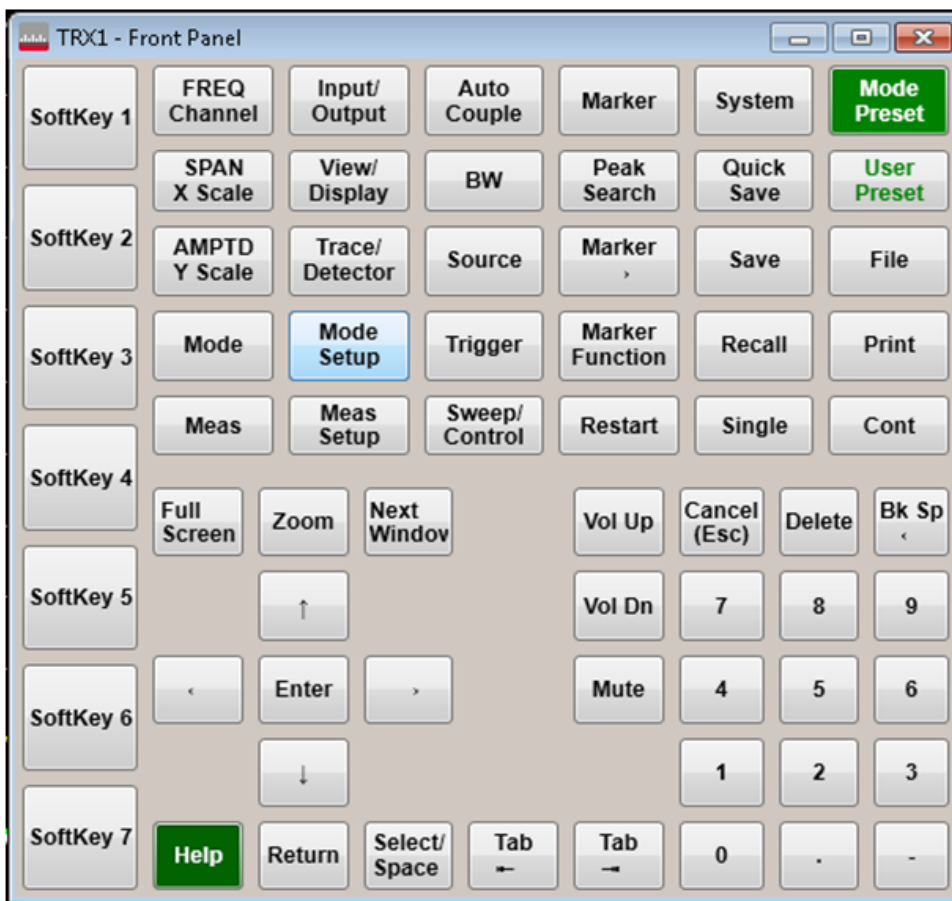

NOTE

The VFP window is not used in the **MultiTouch** interface, because that interface makes all menus and functions available from the main display screen.

When the Test Set is Controlled Remotely

The test set can be controlled remotely, from another computer. (See **“Remote Desktop: Using the Test Set Remotely” on page 187.**) When the test set is being controlled remotely, a log-on screen is displayed on the monitor. f

Under these circumstances, pressing the front-panel Power switch does not immediately turn instrument power off. Instead, the following message appears:

Other people are logged on to this computer. Shutting down windows might cause them to lose data. Do you want to continue shutting down?

Although pressing and holding down the Power button will force a power shutdown, this is not recommended; use the Windows shutdown function instead.

WARNING

Do not shut down power by pulling out the power plug; this will damage the power supply.

Display Annotations (MultiTouch interface)

Figure 2-7 Display annotations (XSA MultiTouch interface)

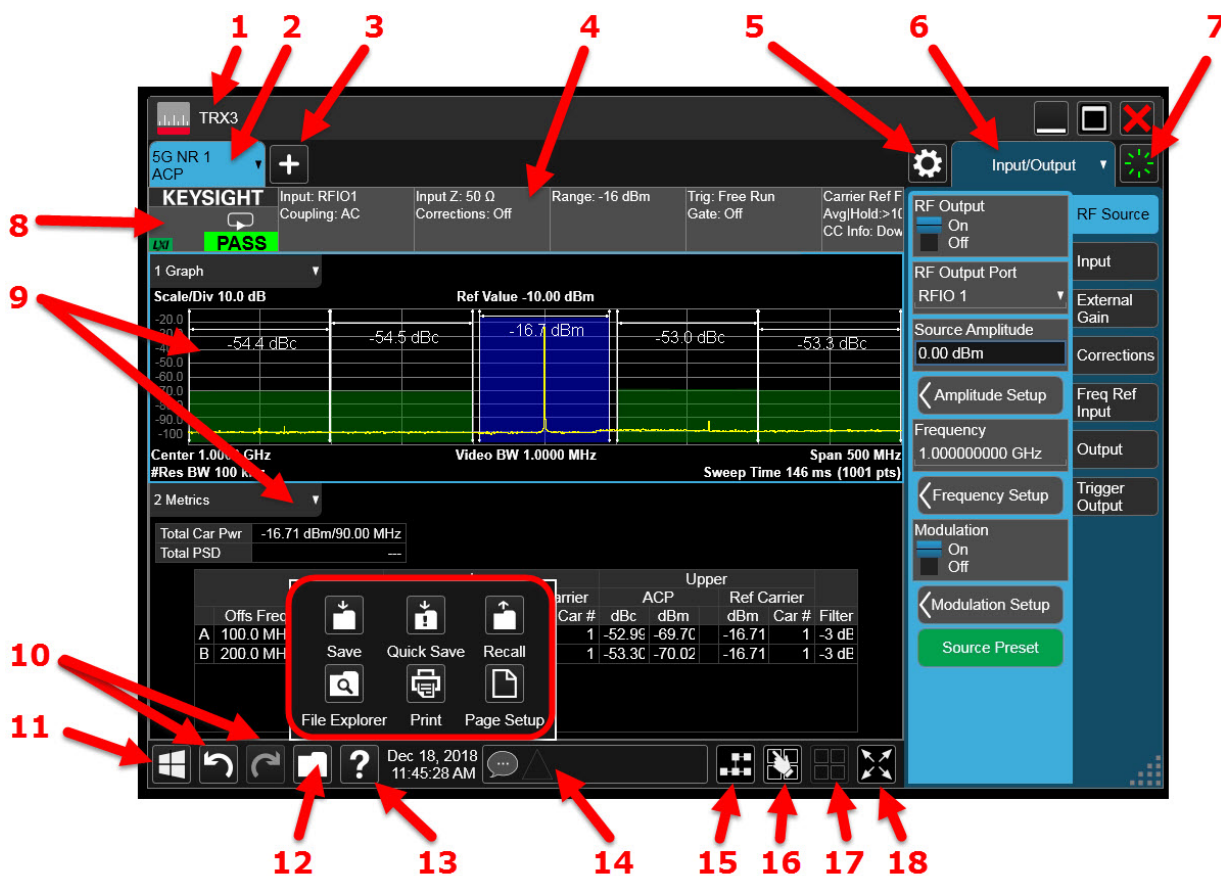

Number	Description	Notes
1	The TRX sub-instrument associated with the application (identified as “TRX1” through “TRX4”).	This is needed because the E6640A can include up to four independent TRX sub-instruments in one PXI rack.
2	Screen tab. Shows mode and measurement selected for that tab.	To change the selection, click on the tab to open the Mode/Meas/View dialog.
3	Add another screen tab.	Click to add another screen tab for this TRX; can be set to another mode and measurement.
4	Measurement bar.	Shows the most important parameters for the measurement.
5	System Settings icon.	Click to open a complex System Settings window, which provides access to many settings which are independent of a particular measurement (alignments, for example).
6	Menus.	Measurement settings menus and submenus.



Front and Rear Panel Features
Front Panel Features

Number	Description	Notes
7	Preset icon.	Access to presets and defaults.
8	Left side of measurement bar; includes display of pass/fail result, plus single/continuous measurement selection and indicator.	The following graphics indicate single/continuous measurement: 
9	Measurement results.	Graphs plus numerical tables; the number and type of displays is determined by the measurement that is running.
10	Undo/Redo icons.	Undo the last executed function, or redo the last undone function.
11	Windows icon.	Open the Windows Start menu and taskbar.
12	File icon.	Access to a variety of file-related functions, including Save and Recall.
13	Help icon.	Open the help content. To dismiss the help, use the ESC key or the X at the upper right of the help screen.
14	Status window.	Displays status messages.
15	Block diagram.	Opens a graphical representation of internal hardware and signal paths. Individual blocks can be clicked to open related menus.
16	View editor.	Opens an editor for adding and deleting windows, resizing and rearranging windows, and creating User Views.
17	Multiscreen icon.	Displays all the existing screen tabs simultaneously, in multiple windows.
18	Fullscreen icon.	Expand the measurement window horizontally over the entire instrument display. The screen graticule area expands to fill the available display area.

Display Annotations (Traditional Interface)

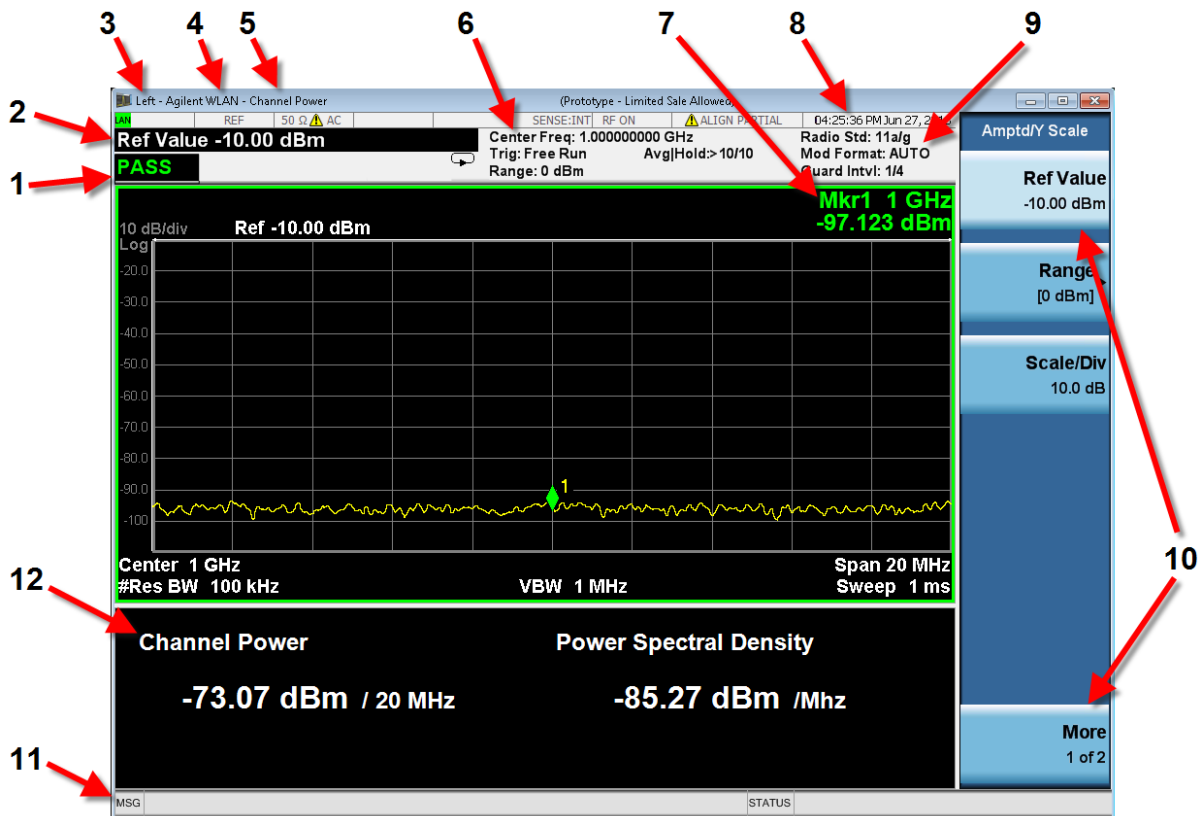
Figure 2-8 Display annotations (XSA interface)



Number	Description	Function Key
1	Measurement bar; shows general measurement settings and information. Some measurements include limits which the data is tested against. A Pass/Fail indication may be shown in the lower-left corner. The following graphics indicate single/continuous measurement:  	All the keys in the test set Setup part of the front panel.
2	Active Function (measurement bar); when the current active function has a settable numeric value, it is shown here.	Currently selected front panel key.
3	The TRX sub-instrument associated with the application (identified as “TRX1” through “TRX4”). This is needed because the E6640A can include up to four independent TRX sub-instruments in one PXI rack.	

Front and Rear Panel Features
Front Panel Features

Number	Description	Function Key
4	Banner; shows the name of the selected application that is currently running.	Mode
5	Measurement title; shows title information for the current measurement, or a title that you created for the measurement.	Meas View/Display, Display, Title
6	Settings panel; displays system information that is not specific to any one application. <ul style="list-style-type: none"> – Input/Output status - green LXI indicates the LAN is connected. RLTS indicate Remote, Listen, Talk, SRQ – Input impedance and coupling – Selection of external frequency reference – Setting of automatic internal alignment routine 	Local and System, I/O Config, Input/Output, Amplitude, System, and others
7	Active marker frequency, amplitude, or function value	Marker
8	Settings panel; time and date display	System, Control Panel
9	Trace and detector information	Trace/Detector, Clear Write (W) Trace Average (A) Max Hold (M) Min Hold (m) Trace/Detector, More, Detector, Average (A) Normal (N) Peak (P) Sample (S) Negative Peak (p)
10	Key labels that change based on the most recent key press	Softkeys
11	Displays information, warning, and error messages. Message area: single events. Status area: conditions.	
12	Measurement settings for the data currently being displayed in the graticule area. In the example above: center frequency, resolution bandwidth, video bandwidth, frequency span, sweep time and number of sweep points.	Keys in the test set Setup part of the front panel.

Rear Panel Features













Figure 2-9 EXM rear panel











Number	Item Name	Description
1	Line power input	The AC power connection. See the product specifications for more details.
2	POWER SYNCH IN/OUT	Reserved for future use.
3	FAN	Fan speed control (settings are HIGH and AUTO).
4	INHIBIT	Inhibit switch. The settings are DEF (default) and MAN (manual). <ul style="list-style-type: none"> – When the switch is in the default position, the chassis is powered up by the front panel ON/Standby pushbutton. This is the recommended setting. – When the switch is in the manual position, the chassis is powered up by the Inhibit input signal on the rear panel INHIBIT/VOLTAGE MON DB-9 connector.
5	INHIBIT/VOLTAGE MON	This DB-9 connector provides access for testing of internal power supply voltages. The voltages (by Pin #) are: (1) Logic Gnd, (2) +5 VDC, (3) Rsvrd, (4) +3.3 VDC, (5) Inhibit [Low], (6) +12 VDC, (7) Rsvrd, (8) -12 VDC, (9) Logic Gnd.
6	10 MHz REF OUT	This BNC connector is not used by the E6640A test set. The front panel 10 MHz OUT connector should be used instead.
7	10 MHz REF IN	This BNC connector is not used by the E6640A test set. The front panel REF IN connector should be used instead.

Front and Rear Panel Symbols

Labels and symbols which may be shown on the E6640A (mainly on the rear panel of the chassis) are described in the table below.

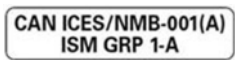
Symbol	Description
	This symbol marks the standby position of the power line switch.
	This symbol marks the ON position of the power line switch.
	This symbol marks the OFF position of the power line switch.
	This symbol indicates the input power required is AC.
	This symbol indicates DC voltage.
	This symbol indicates a three-phase alternating current.
	This symbol indicates frame or chassis terminal.
	The instruction documentation symbol. The product is marked with this symbol when it is necessary for the user to refer to the instruction in the documentation.
	This symbol indicates the presence of a laser device.
	This symbol indicates that the surface can be hot.
	This symbol identifies the Protective Conductor Terminal.
	This symbol indicates the equipment is protected throughout by double or reinforced insulation.
	The CE marking is a registered trademark of the European Community (if accompanied by a year, it is the year when the design was proven). It indicates that the product complies with all relevant directives.

Front and Rear Panel Features
Front and Rear Panel Symbols

Symbol	Description
	UK conformity mark is a UK government owned mark. Products showing this mark comply with all applicable UK regulations.
	The Keysight email address is required by EU directives applicable to our product.
	The CSA mark is a registered trademark of the CSA international.
CAN ICES/NMB-001(A)	Canada EMC label. Interference-Causing Equipment Standard for industrial, scientific and medical (ISM) equipment. Matériel industriel, scientifique et médical (ISM).
	CE/ICES/ISM label. This is a space-saver label that combines three markings – CE with CAN ICES (see above) and ISM (see below).
	The RCM mark is a registered trademark of the Australian Communications and Media Authority.
	This is a combined marking to indicate product compliance with the Industry Canadian Interference-Causing Equipment Standard (ICES/NMB-001). This is also a symbol of an Industrial Scientific and Medical Group 1 Class A product (CISPR 11, Clause 5).
ISM 1-A	This is a symbol of an Industrial Scientific and Medical Group 1 Class A product (CISPR 11, Clause 5).
	South Korean Certification (KC) mark. It includes the marking's identifier code.
	The crossed-out wheeled bin symbol indicates that separate collection for waste electric and electronic equipment (WEEE) is required, as obligated by the EU DIRECTIVE and other National legislation. Please refer to www.keysight.com/go/takeback for information about your trade-in options with Keysight, in addition to product takeback instructions.
	China Restricted Substance Product Label. The EPUP (environmental protection use period) number in the center indicates the time period during which no hazardous or toxic substances or elements are expected to leak or deteriorate during normal use and generally reflects the expected useful life of the product.
	Universal recycling symbol. This symbol indicates compliance with the China standard GB 18455-2001 as required by the China RoHS regulations for paper/fiberboard packaging.
IP x y	This mark indicates product has been designed to meet the requirements of “IP x y”, where “x” is the solid particle protection and “y” is the liquid ingress protection.

Front and Rear Panel Features
Front and Rear Panel Symbols

3 Test Set Operating System

The following topics can be found in this section:

[“Keysight Software Installed” on page 62](#)

[“Customer Installation of Software” on page 63](#)

[“User Accounts” on page 64](#)

[“Licensing” on page 66](#)

[“Licensing New Measurement Application Software - After Initial Purchase” on page 68](#)

[“Transporting a License Between Test Sets” on page 70](#)

[“Windows Configuration” on page 73](#)

[“Configuring Printers” on page 76](#)

[“Configuring LAN” on page 76](#)

[“Windows Security” on page 77](#)

[“System Maintenance” on page 81](#)

[“USB Connections” on page 82](#)

[“Hard Drive Partitioning and Use” on page 84](#)

[“Hard Drive Recovery Process” on page 85](#)

Keysight Software Installed

Measurement Software Applications

A set of Keysight measurement applications for different modes (GSM/EDTE, cdma2000, Sequence Analyzer mode, etc.) is installed by default in the test set, but these must be licensed in order to be used. Whichever licenses were purchased with the instrument are installed at the factory (see **“Options and Licenses” on page 13**). Other licenses can be purchased and installed later (including transportable licenses). For more information, see: <http://www.keysight.com/find/e6640a>

Customer Installation of Software

3rd party software verified by Keysight

Keysight has verified that the following programs are compatible with the test set applications:

- Symantec AntiVirus™ Corporate Edition version 10
- MathWorks MATLAB

Installation of other 3rd party software

The E6640A platform is an open Windows environment, so you can install non-approved software on the test set. However, installation of non-approved software may affect test set performance. Keysight does not warrant the performance of the test set with non-approved software installed.

NOTE

Before installing any additional programs on the test set, you should exit the test set application.

Also, you must not remove any applications or programs that are installed on the test set when it is shipped from the factory.

If you install programs other than those that Keysight has tested, it could cause problems with the test set's applications. If this happens, you should try uninstalling the program that has caused the problem, or try changing the program's configuration. If this does not correct the problem, you may have to use the Keysight Recovery system to reinstall the test set's system software.

User Accounts

Administrator login

The Administrator account ships from the factory with the password “Keysight4u!”. Using the Administrator account, you can perform the following operations:

- Install software
- Configure network and printer access
- Access all files on the test set
- Add or change user accounts and passwords
- Change Firewall settings
- Change Windows settings (for example, using Device Manager)
- Change the time and date
- Run any application

NOTE

The E6640A was formerly a product of Agilent Technologies. If the front panel of the test set shows Agilent as the manufacturer, then “agilent4u” may have been set as the password for the Administrator account.

User login

The default user account that ships from the factory is “Instrument” with the password “measure4u”. This user is a member of the Power Users group. Using the Instrument account you can perform the following operations:

- Install software
- Configure network and printer access
- Access files on the test set that are accessible to the Power Users group
- Run applications that are accessible to the Power Users group

Customer creation of accounts

You can create additional user accounts and decide on the level of security granted to any new user accounts created. For example, the level of security can be assigned as administrator, power user, user, backup operators. User names are not case sensitive but passwords are case sensitive.

NOTE

For the test set software to operate, the user account executing the software must be assigned Administrator or Power User privileges. Otherwise, the test set software will not operate correctly.

It is Keysight's expectation that each user's My Documents folder is mapped to the D: drive. This is to avoid overwriting the user's data in the event the Keysight Recovery must be performed. Also, this facilitates convenient backup by copying the contents of the D: drive to external media. All users accounts created by the factory already have My Documents mapped to the D: drive. Please map all new users My Documents folders to the D: drive.

Licensing

Licensed Applications

The following application licenses are available for the EXM:

Licenses	Description
V9060EM0E	IQ Analyzer Measurement Application (always installed)
V9065EM0E	Sequence Analyzer Downlink Application
V9065EM1E	Sequence Analyzer Uplink Application (always installed)
V9071EM0E and Y9071EM0E ^a	GSM/EDGE/Evo Application
V9072EM0E and Y9072EM0E ^a	cdma2000® Application
V9073EM0E and Y9073EM0E ^a	WCDMA/HSPA/HSPA+ Application
V9076EM0E and Y9076EM0E ^a	1xEV-DO Application
V9077EM0E and Y9077EM0E ^a	WLAN 802.11a/b/g/j/p/n Application
V9077EM1E and Y9077EM1E ^a	WLAN 802.11ac/ax Application
V9079EM0E and Y9079EM0E ^a	TD-SCDMA/HSPA Application
V9080EM0E and Y9080EM0E ^a	LTE and LTE-Advanced FDD Application
V9080EM3E and Y9080EM3E ^a	NB-IoT and eMTC Application
V9080EM4E and Y9080EM4E ^a	LTE V2X Application
V9081EM0E and Y9081EM0E ^a	Bluetooth® Application
V9082EM0E and Y9082EM0E ^a	LTE and LTE-Advanced TDD Application
V9085EM0E and Y9085EM0E ^a	5G NR Application
V9085EM1E	PAvT Measurement Application

a. Licenses beginning with a "Y" support both measurement and waveform generation; licenses beginning with a "V" support measurement only.

Flexible Software Licensing

Keysight offers a variety of flexible licensing options to fit your needs and budget. You have two or more options to choose from for the license term, license type, and KeysightCare software support subscription.

License Terms

- *Perpetual:*
License can be used indefinitely.
- *Time-based:*
License can be used through the term of the license only (6, 12, 24, or 36 months).

License Types

- *Node-locked:*
License can be used on one specified instrument/computer.
- *Transportable:*
License can be used on one instrument/computer at a time but may be transferred to another using Keysight Software Manager (internet connection required).
- *USB Portable:*
License can be used on one instrument/computer at a time but may be transferred to another using a certified USB dongle (available for additional purchase with Keysight part number E8900-D10).
- *Floating (single site):*
Networked instruments/computers can access a license from a server one at a time. Multiple licenses can be purchased for concurrent usage.

KeysightCare Software Support Subscriptions

- Perpetual licenses are sold with a 12 (default), 24, 36, or 60-month software support subscription. Support subscriptions can be renewed for a fee after that.
- Time-based licenses include a software support subscription through the term of the license.

For More information

On licensing in general:

www.keysight.com/find/licensing

On upgrading software:

www.keysight.com/find/upgrade_to_software_support

Licensing New Measurement Application Software - After Initial Purchase

Additional measurement application software can be ordered after your initial purchase of the E6640A test set. Software upgrades are provided in a kit that includes an option based Entitlement Certificate, a license agreement. The licenses are downloaded from the license Web site onto a storage device so they can be loaded into the instrument.

If you do not want to wait for your upgrade kit to arrive, licenses can be installed using any available USB storage device. If you choose to do this, we recommend that the latest version of the instrument software be installed. This ensures that the measurement application being licensed and activated is installed and is the most current version.

The latest revision of the software may be downloaded from:
<http://www.keysight.com/find/e6640a>

A license key is usually for one instrument model and serial number combination. The license key will only install itself on that instrument.

NOTE

No calibration is required after a test set application installation.

Installation procedure over USB

Step	Action	Notes
1 Redeem the Option Upgrade Entitlement Certificate	· Follow the instructions on the Certificate	After redeeming your Option Upgrade Entitlement Certificate you will receive an e-mail with an attached License File.
2 Save the license file	· Save the .lic file to the root directory of a USB storage device	
3 Load the license file	· Connect the USB storage device to one of the test set USB ports.	Windows will detect the new hardware and may display the configuration menu. The test set automatically loads the license file. (This may take a few minutes) Upon completion, the Keysight License Manager displays a "Successful License Installation" message.

NOTE

Alternatively the license file can be manually installed over USB or LAN by placing the license file in the following folder on the test set.

C:\Program Files\Agilent\licensing

Test Set Operating System
Licensing New Measurement Application Software - After Initial Purchase

Step	Action	Notes
4 Verify installation	Cycle the power on the signal test set. On the Virtual Front Panel press System, Show, System . Verify that the new application appears in the list.	The application will not be available for use until after the power has been cycled This displays the list of installed applications. If you require further assistance, please contact the Keysight support team. Online assistance: http://www.keysight.com/find/assist If you do not have access to the Internet, contact your local Keysight Technologies Sales and Service Office, or if in the United States, call 1-800-829-4444.

Transporting a License Between Test Sets

To move a transportable license from one test set to another, Keysight recommends that both test sets be at the same instrument software release. This ensures that the user experience is identical between instruments.

As a minimum, the instrument software release in the test set that will receive the transportable license (the "target instrument") must at least be able to support the desired application.

The E6640A test sets support several ways of transporting licenses. The procedure below will focus on the most common procedure, where neither of the test sets has access to an internet connection.

NOTE

This procedure requires a PC with an internet connection.

You will need the following:

- USB flash drive
- USB keyboard
- USB mouse

The test set from which the transportable license will be removed is here called the "source instrument". The test set which will receive the transportable license is here called the "target instrument".

Procedure for Transporting a License, Neither Test Set Connected to the Internet

The test set from which the transportable license will be removed is here called the "source instrument". The test set which will receive the transportable license is here called the "target instrument".

Step	Action	Notes
1 Connect the USB devices to the source instrument	– Connect the USB flash drive, USB keyboard, and USB mouse to the USB ports on the source instrument.	It will be necessary to use one or more of the front panel ports to connect the USB devices.
2 Verify software version in each test set	– On the Virtual Front Panel for each test set, press System > Show > System and make note of the Instrument S/W Revision on each.	Ideally, the revisions will be the same. But at least, both versions should be able to support the application whose license is being transported.
3 Obtain the Host ID from the Target Instrument	– On the target instrument, press System > Show > System and make note of the host ID.	This information will be needed to issue the license for the target instrument. The Host ID is the model number, followed by a comma, followed by the serial number.

Test Set Operating System
Transporting a License Between Test Sets

Step	Action	Notes
4 Start the License Manager on the Source Instrument	<ul style="list-style-type: none"> – On the source instrument, press System > More > Licensing... – It may take a minute for the Keysight License Manager screen to be fully populated with all the installed licenses. 	
5 Transport the Transportable License from Source Instrument	<ul style="list-style-type: none"> – On the source instrument, locate the desired license to be transported and highlight it. Its option designator should include the letters "TP". – Right-click on the mouse and select Delete. – Click Yes in the License Deletion Confirmation dialog box. – After a few seconds, a Transport License dialog box will appear. Click OK and save the *.url files on the USB flash drive, with a name such as "PhaseNoise_License.url". 	<p>Be sure you are selecting a transportable license and not a fixed perpetual license.</p> <p>Although you are "deleting" the transportable license, the ultimate action will be to transport it.</p> <p>The information in this dialog box will be used to issue a new license for the target instrument.</p>
6 Get New License from KSM Transportation Web page	<ul style="list-style-type: none"> – Insert USB flash drive into PC that is connected to the internet. – On the PC, locate the *.url file on the USB flash drive that was saved in the previous step and click on it. – After a few seconds, the KSM Transportation Web page will appear. One field, the New Host ID will be empty. – Enter the Host ID of the target instrument (step 3 above) into the field marked New Host ID. – Click Submit. 	<p>The PC must have an internet connection and an available USB port.</p> <p>Most of the fields have been populated from the information in the *.url file.</p> <p>Be very careful when entering the New Host ID. A mistake made in entering the New Host ID will result in an invalid license being issued. Be sure there is a comma between the model number and serial number. There should be no spaces in the Host ID.</p>

Test Set Operating System
Transporting a License Between Test Sets

Step	Action	Notes
7 Save License File to USB Flash Drive	<ul style="list-style-type: none"> – The KSM Transportation Web page will indicate that a license file is available and display two links to the license file. Right-click on the license file and select Save Target As... – Save the license file to the root level of the USB flash drive, keeping the ".lic" file extension. – Close the Save dialog and exit the KSM Transportation Web page. 	<p>Either link can be used to either display or save the license file.</p> <p>The license file must be saved to the root level of the USB flash drive for it to be recognized by the target instrument.</p>
8 Install License File in Target Instrument	<ul style="list-style-type: none"> – With the target instrument running, insert the USB flash drive into one of the front panel USB ports. After a few minutes, you should see a message saying "Successful License Installation". – Cycle power on the target instrument. – Once the test set has re-booted, the application should be ready to use on the target instrument. 	<p>The Keysight License Services running on the target instrument looks for *.lic files whenever it detects a USB device has been inserted. If the contents of the *.lic file are appropriate for the instrument, the license will be installed automatically.</p> <p>Newly-installed licenses are only recognized by the instrument software on power-up.</p>

Windows Configuration

The Windows settings have been optimized for the best measurement performance. Any modifications to these settings may degrade test set performance and measurement speed. In general, most Windows System settings (typically set through the Windows Control Panel) should not be modified. Those that can be safely modified are listed below.

CAUTION







To recover from problems caused by changing Windows systems settings, you may have to reinstall the Windows system and test set application using the Keysight Recovery process.

Settings that can be changed

You may change the following Windows settings or administrative tasks (available from the Windows Control Panel) to select your personal preferences.

NOTE







Before changing any Windows System settings, exit the test set application.

You may use this feature	To do this...
 Windows Update	Configure Microsoft Windows Automatic Updates.
 Action Center	Install and configure an Anti Virus program.
 User Accounts	Set up new test set user accounts.
 Network and Sharing Center	Add the test set to a network.
 Devices and Printers	Install and configure a printer.
 Date and Time	Set the time and date.

You may use this feature	To do this...
 System	Under Advanced System Settings, System Properties, Advanced, Performance: choose either “Let Windows choose what’s best for my computer” or “Adjust for best performance”. Leave all other settings unchanged.

Settings that must not be changed

Avoid changing any settings in this section. Changes to the following settings may degrade test set performance, screen displays, and measurement speed.

Do NOT use this feature	To do this...
 Power Options	Do not change Power Options.
 System	Do not modify System Properties, Hardware Tab settings. Do not modify System Properties, Advanced Tab settings (except as recommended under “Settings that can be changed” above).
 Fonts	Do not remove installed Fonts.
 Display	Do not change the following Display Settings: <ul style="list-style-type: none">– Screen Saver settings (under “Personalization”)– Screen resolution, 1024 x 768 (under “Adjust Resolution”)– DPI setting (under “Set custom text size”)
 Region and Language	Do not change any settings under “Region and Language” or the instrument keyboard and display may not operate properly
 User Accounts	Do not delete or modify the “KeysightOnly” or “AgilentOnly” user account.

In addition, **DO NOT**:

- Add, delete, or modify hard-disk drive partitions.
- Delete or modify Agilent/Keysight registry entries.
- Change the contents of any directories containing the name “Agilent” or “Keysight”.
- Stop these services:
 - The MSSQL\$CDF service or uninstall the “Microsoft SQL Server Desktop Engine”
 - The IIS server or tamper with any virtual directories (or their contents) that came configured with the test set.
- Uninstall these libraries, interfaces, or programs:
 - The Agilent/Keysight I/O Libraries
 - The .NET Framework or any Hotfixes or Service Packs for the .NET Framework
 - The “Microsoft Visual J# .NET Redistributable Package 1.1”
 - Programs that begin with “Agilent” or “Keysight”
 - The Adobe Acrobat Reader
- Modify
 - The Agilent/Keysight I/O Library “GPIB27”, “GPIB28” interfaces shown as configured Instrument I/O in the Agilent/Keysight Connection Expert or I/O Config.

Configuring Printers

Printers are configured using the Microsoft Windows Control Panel. It is easily accessed from the Windows Start menu or from under the front panel **System** key. This setup process is most easily done using a USB mouse and an external keyboard.

When setting up a new printer, you may need to load the printer driver (unless you are using a network printer that your IT department has set up to include the driver). The manufacturer of the printer supplies the driver software and process. That may require that you attach an external USB disk drive. An alternative is to connect the test set to the LAN and download the driver from the printer manufacturer's internet site.

Configuring LAN

Hostname

The Computer Name, or hostname, is pre-configured from the factory. It must be a unique name so that it does not conflict with other equipment on your LAN. The pre-configured Computer Name is K-E6640A-xxxxx, where xxxxx represents the last 5 digits of the test set serial number.

To change the Computer Name consult the Microsoft Windows Help and Support Center.

IP Address & Gateway

The test set is pre-configured to obtain an IP Address using DHCP. The IP Address and Gateway can be changed. Consult the Microsoft Windows Help and Support Center to configure the LAN.

Windows Security

Microsoft recommends the following to ensure the test set Windows operating system is protected:

- Use an internet firewall.
- Get the latest critical Windows updates.
- Use up-to-date antivirus software.

To check the status or make changes in the security settings for your test set, click **Start, Control Panel**, and then **System and Security**. The following window appears:

Figure 3-1 System and Security settings

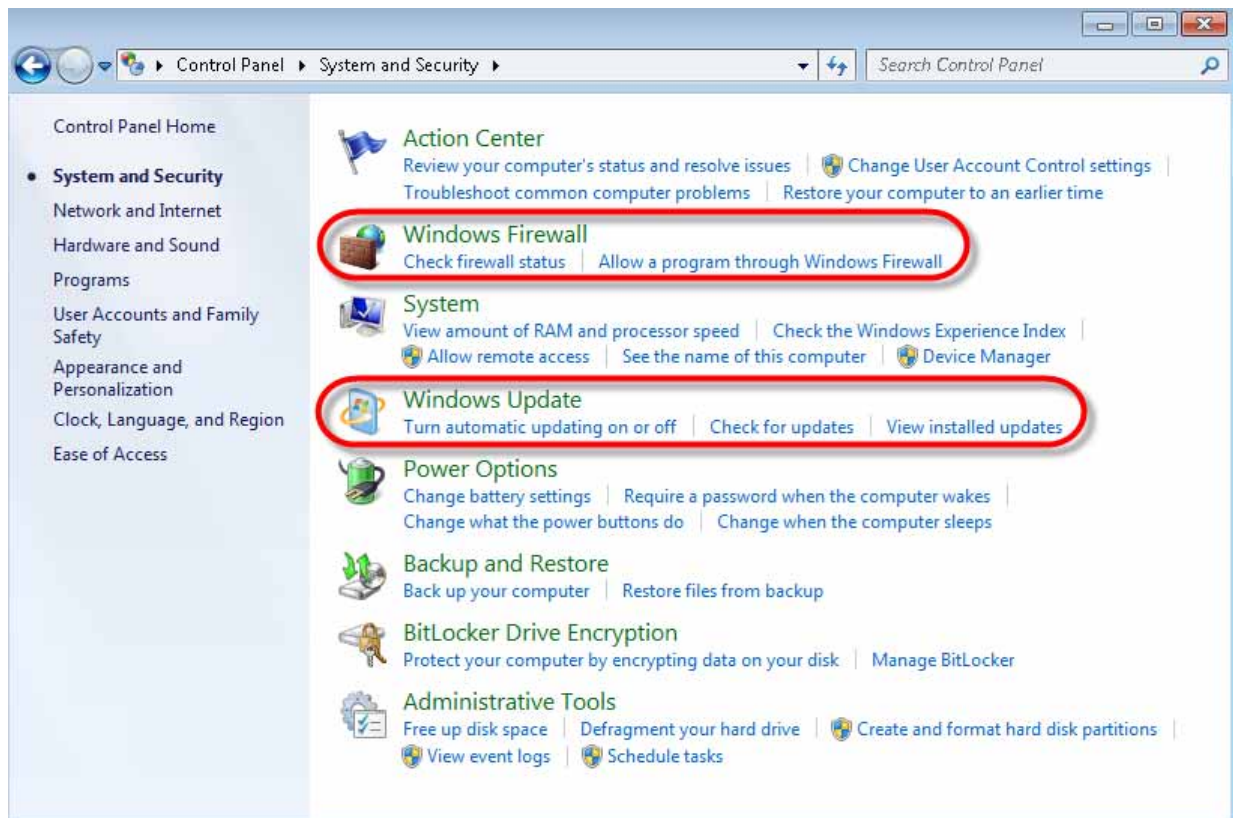

NOTE

The window may look slightly different on your test set.

Windows Firewall

Click **Windows Firewall** in the System and Security window to check the firewall status of your test set. The test set is shipped with the Windows Firewall enabled.

Figure 3-2 Firewall settings

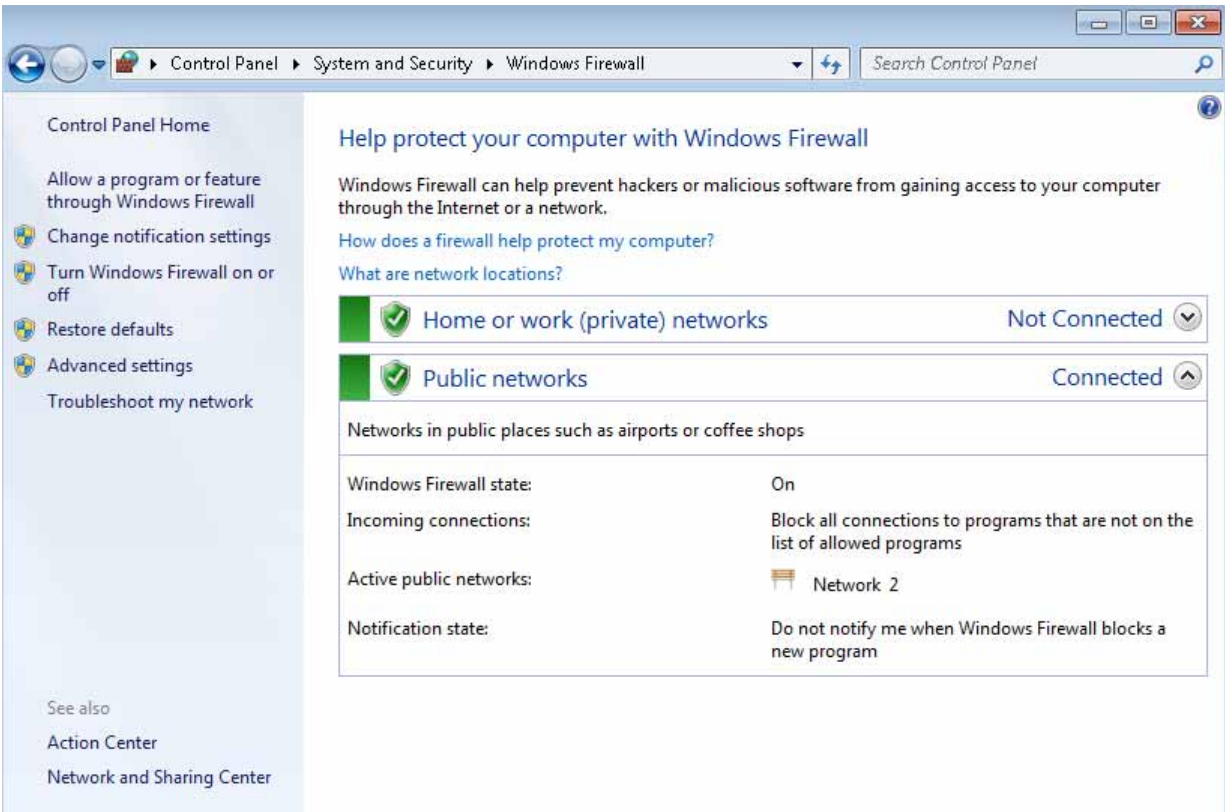

NOTE

The window may look slightly different on your test set.

Windows Firewall exceptions for programs and ports have been added to allow proper operation of the test set over a network. Modifying these settings may prevent the test set from operating properly.

Automatic updates

Keysight recommends installing Windows updates. This should be enabled in Windows security settings. The default test set setting is to automatically check for critical Windows Updates and notify you, if the test set has internet access.

You can change the configuration of the Microsoft Automatic Updates. Under **Windows Update** in the **System and Security** window, click **Turn automatic updating on or off** to change settings. If you choose not to have automatic updates, you can manually update windows by clicking **Check for updates** on the **System and Security** window.

Figure 3-3 Automatic update settings

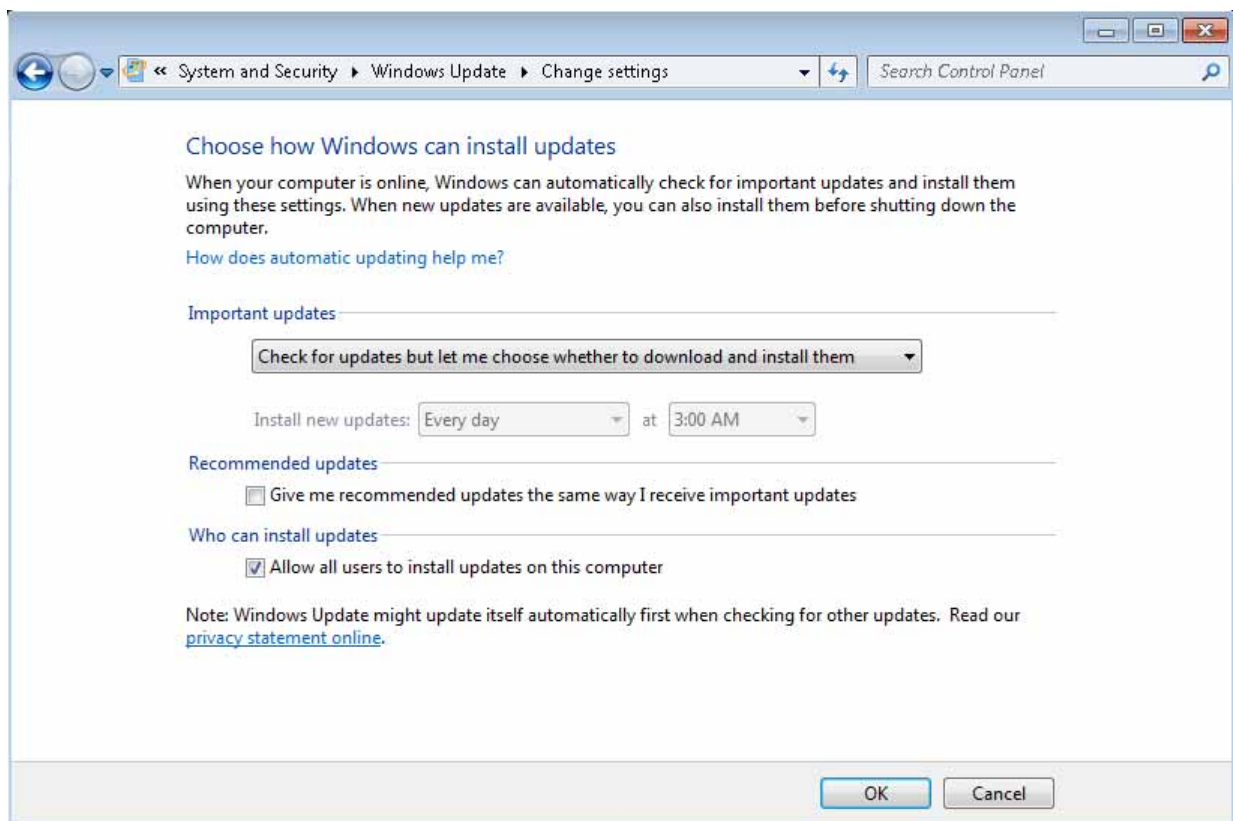

NOTE

Be aware that downloading and installing Windows Updates can be network and CPU usage intensive (impacting the test set performance), and some Windows Updates automatically reboot the test set. It is recommended that Windows Updates be performed when the test set is not in normal use.

Virus protection

Under **Action Center** in the **System and Security** window, click **Review your computer's status and resolve issues** to check the status of virus protection on your test set. There is no antivirus software included with your test set. Antivirus application software has been tested to be compatible with the test set. See the section on **“3rd party software verified by Keysight” on page 63** for anti-virus software that has been tested by Keysight.

NOTE

Having antivirus software installed may have a slight impact on the test set performance.

Figure 3-4 Virus protection settings

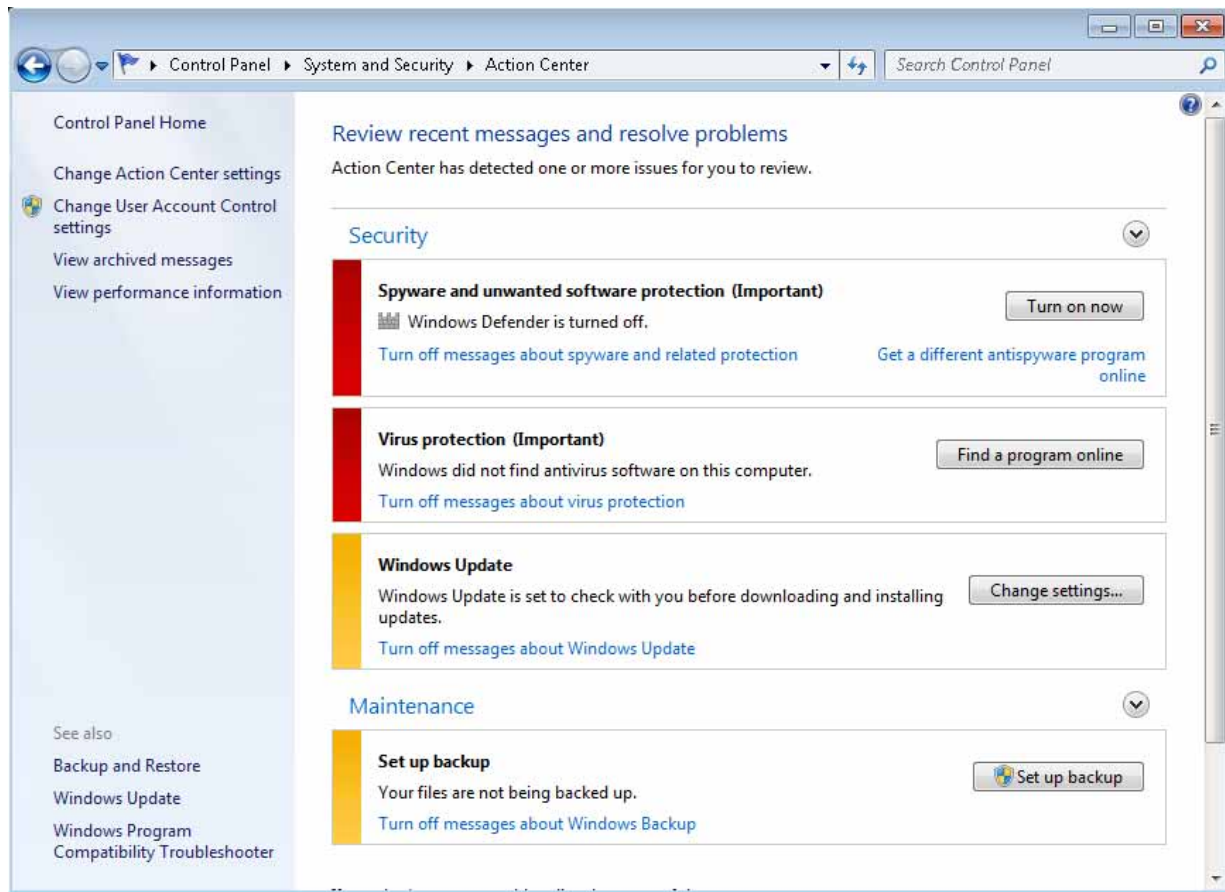

Spyware protection

The **Review your computer's status and resolve issues** window described above also shows the status of spyware protection. There is no anti-spyware software installed on the test set. This should not be a problem if you do not use the test set for a lot of internet browsing. Having spyware in the test set could have an impact on the test set performance.

System Maintenance

Backup

It is recommended that you have a regular backup strategy. Your IT department may already have a backup strategy in place which is suitable for the test set and its data. Using the Keysight Recovery system in conjunction with a regular backup strategy should allow full recovery of the test set data.

The Windows operating system has a Backup utility that you can use to archive files and folders in case of a hard disk drive failure. See the Microsoft Windows Help and Support Center for more information on this utility. You can also use third party backup utilities. However, you must ensure that this third party software is compatible with the test set's system software. See **“Customer Installation of Software” on page 63** for more information.

When performing backups, we recommend that you backup the data to an external storage device connected to the network or one of the test set's USB connectors. Also, you should perform backups at times when the test set is not being used for normal operations as it may impact the test set's overall performance.

System restore

Windows contains the capability to restore the system to a previous point in time. System Restore is enabled with default settings as provided by Microsoft. However, System Restore is not 100% successful. Therefore, it is not the recommended method to backup the test set. System Restore has not been tested to verify successful restoring.

Disk defragmenting

Over time the hard disk on the test set becomes fragmented. Windows has a Disk Defragmenter utility that you can use to defragment the hard disk. See the Microsoft Windows Help and Support Center for more information on this utility.

NOTE

Running Disk Defragmenter should be performed when the measurement application is not running. Measurement throughput is significantly impacted while disk defragmentation is in process.

USB Connections

The controller front panel provides two USB 3.0 ports and four USB 2.0 ports to which you can connect USB mass storage devices and accessories such as printers and keyboards. The test set USB Host support includes the standard Microsoft Windows USB class drivers for human interface, mass storage, printing, scanning, and imaging devices. A complete up-to-date list of the Windows USB class driver support is available on the Microsoft website:

http://www.microsoft.com/whdc/system/bus/usb/USBFAQ_intro.mspx

Figure 3-5 USB ports

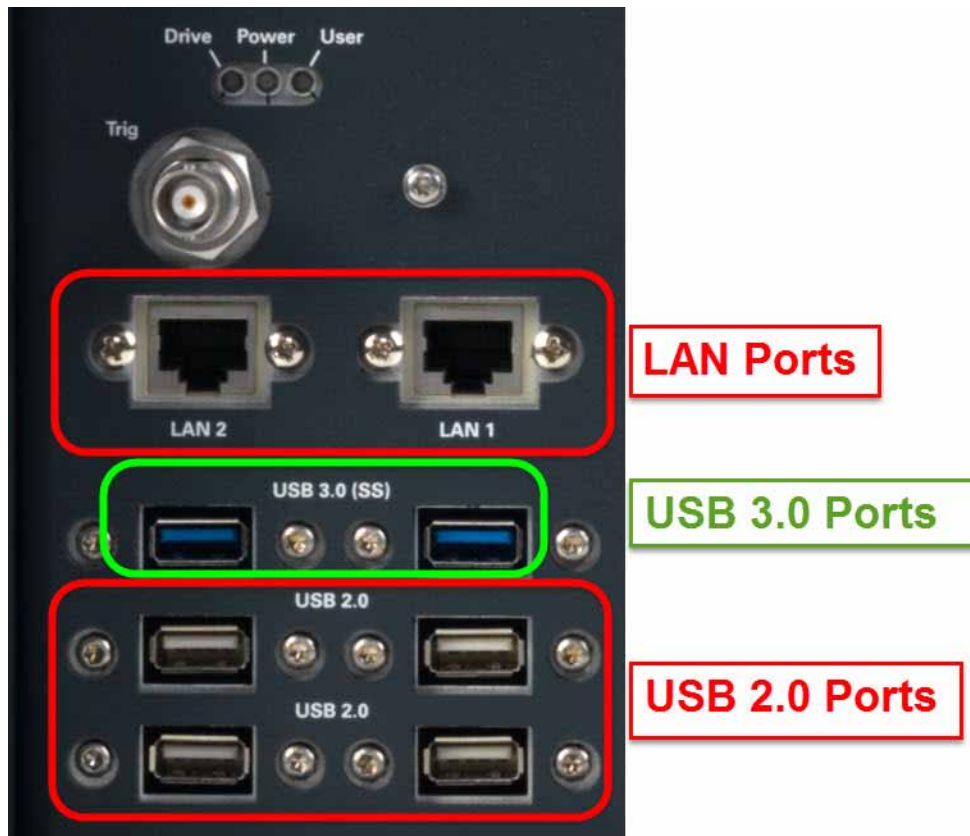

The test set USB device driver included in the test set software supports the test and measurement industry standard USBTMC-USB488 device class.

In addition, the Agilent/Keysight IO Libraries that is installed on your test set contains USB Host drivers that allow control of other test sets connected to the USB bus.

Test Set Operating System USB Connections

Keysight Technologies does not support or warrant correct test set operation if additional USB drivers from third parties are installed in the test set. It is possible that additional drivers could break the normal USB operation. If USB operation is broken, recovery would require reinstalling the test set application using the hard drive recovery process.

Hard Drive Partitioning and Use

The drive is partitioned into 3 sections: C:, D: and E:

- The **C: partition** contains the Windows operating system and software installed by Keysight. This is an Open System which means you can install additional software, and these should be installed on the C: drive. However, only a limited set of software applications are tested for use with the Keysight measurement software. The installation and/or use of other software is not warranted, and could interfere with the operation of the measurement software. If test set repair is ever needed, the Keysight version of the C: drive is the only part of the test set software that is restored by the Keysight Recovery process. You must reload any other software that you have added in the test set.
- The **D: partition** is reserved for data storage. Additionally, this drive is used to save customer waveforms and to save custom instrument states. The User Accounts that are configured by Keysight have their My Documents folder mapped to the D: drive. This is for the convenience of backing-up the measurement data. You should always back-up the data on the D: drive to an external device. This allows you to restore the data if you ever need to replace the hard drive.
- The **E: partition** is reserved for Keysight's use. The primary use of the E: drive is for housing the Calibration and Alignment data. Do not change or overwrite the files on this drive. This could cause your test set to not meet specifications, or even to stop functioning correctly. Do not use this drive for data storage. It is also recommended that you back up the contents of this drive by using the factory calibration data backup utility.

Hard Drive Recovery Process

The Keysight Recovery System can be used to repair errors on the test set's C: drive partition, or to restore the original factory configuration of the system software. The Keysight Recovery System is stored in a separate hidden hard disk drive partition.

Repairing errors on the hard disk drive may result in loss of data or files. If you need more information about the Windows “chkdsk” error repair process, see the chkdsk documentation in the Microsoft Windows Help and Support Center.

Restoring the original factory system software does not restore any of the following items:

- Windows system configurations that were made after the test set was shipped from the factory. For example, Windows and Service Pack updates, user accounts, and Windows configuration settings. After an Keysight Recovery, these configurations need to be redone.
- Additional software that was installed after the test set was shipped from the factory. After an Keysight Recovery, that software needs to be re-installed.
- Any data or programs saved on the D: or E: drives.
- Any upgrades that were made to the Keysight measurement application software.

Restoring the original factory system software will not synchronize the code in the Field Programmable Gate Arrays (FPGAs) on the various hardware assemblies. As a result, you may see an error dialog box appear during the final boot-up at the end of the recovery process. This typically occurs when there are significant differences between the software version installed prior to performing the recovery and the version restored by the recovery. In these situations, upgrade the software to the latest version.

NOTE

It is recommended that you use a regular back up strategy. Your IT department may already have a back up strategy in place which is suitable for the test set and its data. See **“System Maintenance” on page 81**. Using the Keysight Recovery System in conjunction with a regular back up strategy should allow you to fully recover the test set software and data.

It is recommended that routine backups of the test set information be performed to keep current archives of the test set information. This allows a full recovery of the test set information after the test set recovery system operations are performed. See **“Backup” on page 81** for more details.

Table 3-1

Using the test set recovery system

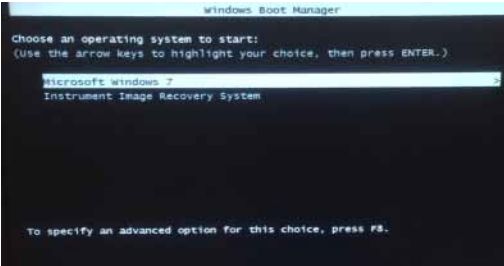
Step	Notes
1 Make sure the test set is turned off.	
2 Turn on the test set. Press the down arrow key to move the highlight to Keysight Recovery System, then press Enter .	After the Keysight Technologies screen is displayed,  This screen is displayed for five seconds. 
3 When the Keysight Recovery System has booted, follow the on-screen instructions to recover the image of the C: drive. Press 2 , then press Enter to select the recovery. Press 1 , then press Enter to continue. Press 1 , then press Enter to confirm.	It may take up to 25 minutes for this process to complete.

After exiting the Keysight Recovery System, the test set reboots. If the original factory test set system has been restored, the test set re-executes the following process: **“Turning on the test set the first time” on page 27.**

NOTE

Additional recovery steps may be required to fully recover the system to a more current working state. This could involve restoring your own backups of the test set configuration, including re-installing applications, data, and performing system customizations.

Updating the software

The purpose of this update is to ensure that the E6640A's software, its measurement mode applications, and the FPGA content of its PC boards are all current and up to date.

NOTE

An update to the instrument software revision does not require a new license key for the measurement applications, so long as the applications were licensed prior to the update.

NOTE

This procedure will only update the instrument software that currently resides on the C: drive of the instrument. It will not update the version that exists on the recovery partition. Because of this, if the recovery process is performed, the instrument will revert back to the instrument software revision that was originally shipped from the factory.

Determining the current software revision

To determine what revision of instrument software is currently installed, press **System, Show, System** using the instrument's virtual front panel. You can access the virtual front panel using a mouse and right-clicking in the application window, and selecting **Utility, Virtual Front Panel**. Once in the show system screen, look for the "Instrument S/W Revision" entry (for example: "A.13.85"). If the installed revision is the same as the latest revision on the web, there is no need to update the instrument software.

Requirements

The following requirements must be met to use this procedure:

- The E6640A must be functioning properly before the update is attempted.
- You must have a USB keyboard and mouse.
- You must be able to log in to the instrument as the administrator.
- You must be able to transfer a large file (~1 GByte) to the E6640A being updated.

File Download

1. Go to <http://www.keysight.com/find/e6640a> and go to the Technical Support section; select the Driver, Firmware & Software tab.
2. Download the executable file by clicking on the file link. Save the file to a location of your choice. If you do not have the ability to download files directly to the C: drive of the E6640A being updated, store the file on a large capacity USB storage device for transfer to the instrument. (The file size is ~1 GByte.)

User account and log-in

The default user account is Instrument, which does not have the required permissions to install the instrument software updates. For the process outlined below, the user must be logged in as Administrator.

The automated instrument software upgrade process has an install wizard which removes the old software version and installs new software version without manual steps. The removal of the old software version and the installation of the new software version completes in approximately 15 minutes.

1. Connect a USB keyboard and mouse to the E6640A.
2. If the E6640A is not already running, power it up and allow it to boot up completely.
3. Shut down the E6640A measurement application if it is running (close all TRX windows).
4. Log out as the default user (Instrument). Click the Start icon at the lower left corner of the screen, and select **Log Off**.
5. Select the Administrator icon on the Windows desktop, to log in as follows:
User Name: administrator
Password: Keysight4u!
6. If a “Found New Hardware” wizard window pops up, select “No, not at this time” to bypass the activity.

Instrument software installation

If you downloaded the instrument software update file to the instrument via LAN, access that file from the location that it was stored and proceed to step 1.

If you downloaded the instrument software update file to a USB storage device, plug that into one of the USB ports on the front of the instrument. Access the file for the removable drive, then proceed to step 1.

NOTE

During the installation process, the installer may need to obtain software components from external web sites (such as www.microsoft.com). For this reason, it is necessary for the instrument to have internet access via the LAN during installation of the software.

Table 3-2

Preparing the installation

Step	Notes
1 Double click on the installer file, and click Yes in the confirmation window that appears.	The file name is in the format: XSA_Installer_E.XX.XX.exe
2 A window appears showing the extraction of the software installer. Click Install in the confirmation window to begin the installation process. When the extraction process is complete, a software updater display appears, showing progress of the software removal and installation.	The update process causes various messages and windows to appear and disappear on the screen, but the process doesn't require further interaction. Examples of what will be displayed are shown below, as a guide to what the process looks like while it is running.

Table 3-2 **Preparing the installation**

Step	Notes
------	-------

Extraction window:

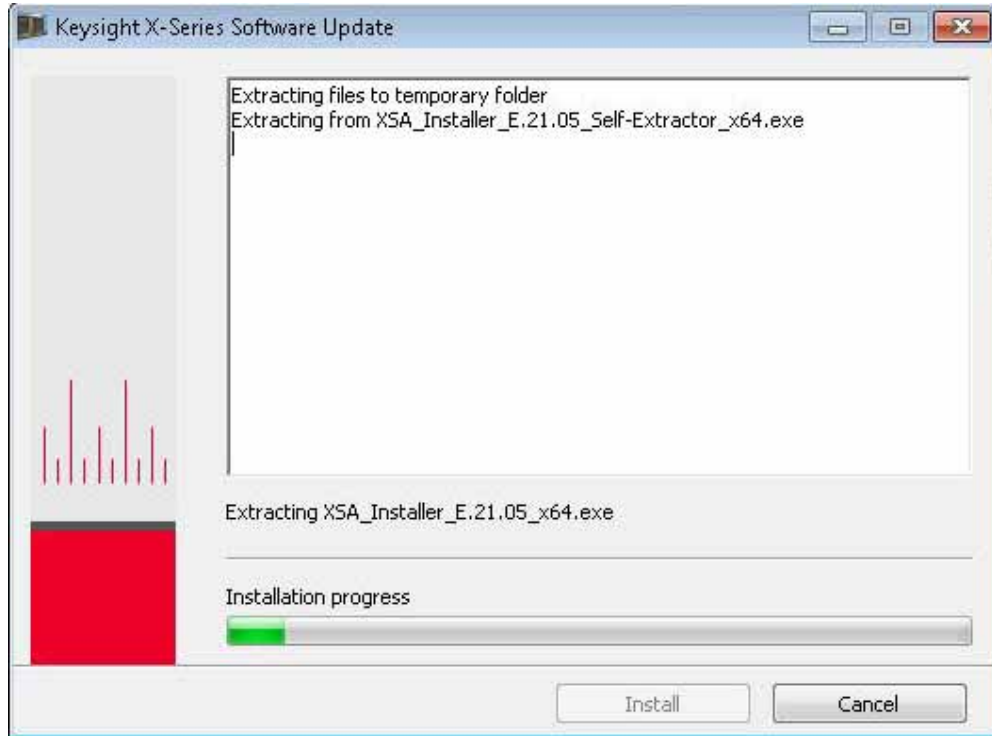

Software updater window, showing uninstallation progress:

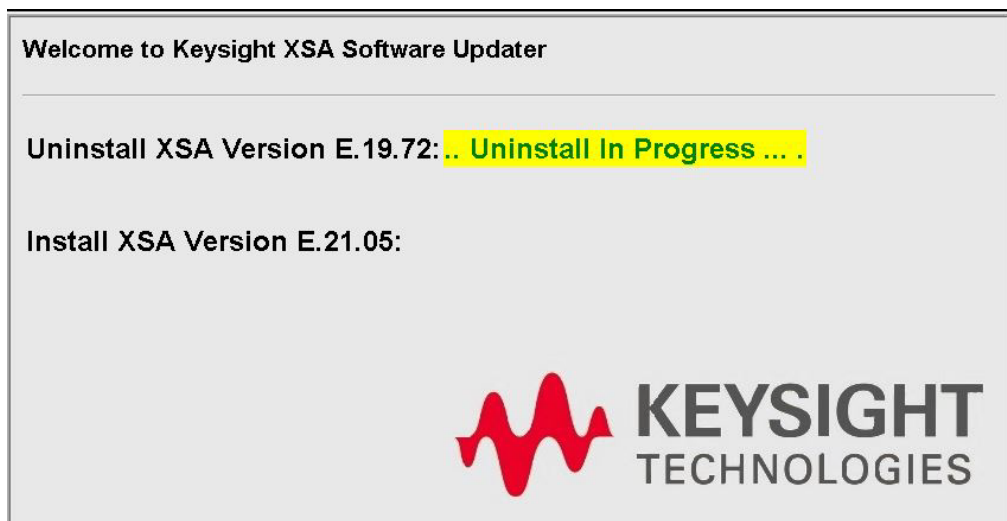

While the old instrument software is being uninstalled, the text "Uninstall in Progress" text rolls across the screen, to be replaced finally by "Completed Successfully". No interaction is required at this point.

Table 3-2 **Preparing the installation**

Step	Notes
------	-------

Software updater window, showing installation progress:



During installation, various popup windows may appear temporarily, while required software components are downloaded from external sites.

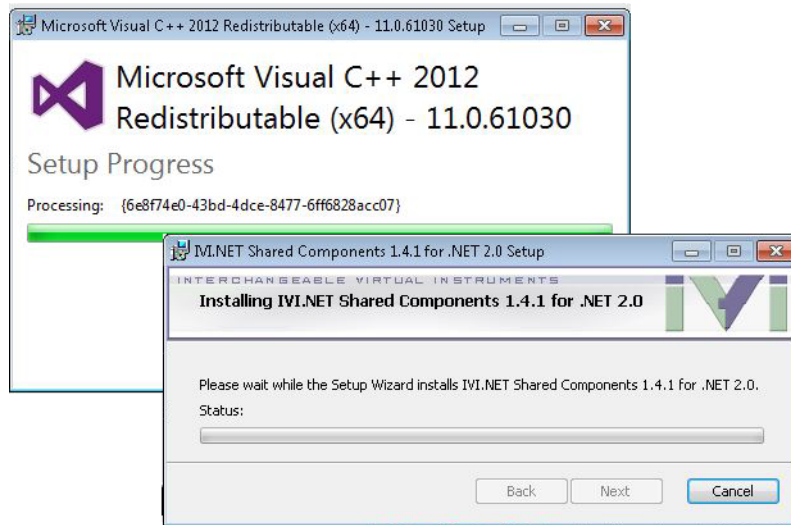

While the new instrument software is being installed, the text “Installation in Progress” text rolls across the screen. No interaction is required at this point.

Please be patient: the total installation process can take 30 to 40 minutes.

Table 3-2 **Preparing the installation**

Step	Notes
------	-------

During the installation process, an FPGA update warning window (may be displayed, if any FPGA updating occurs):

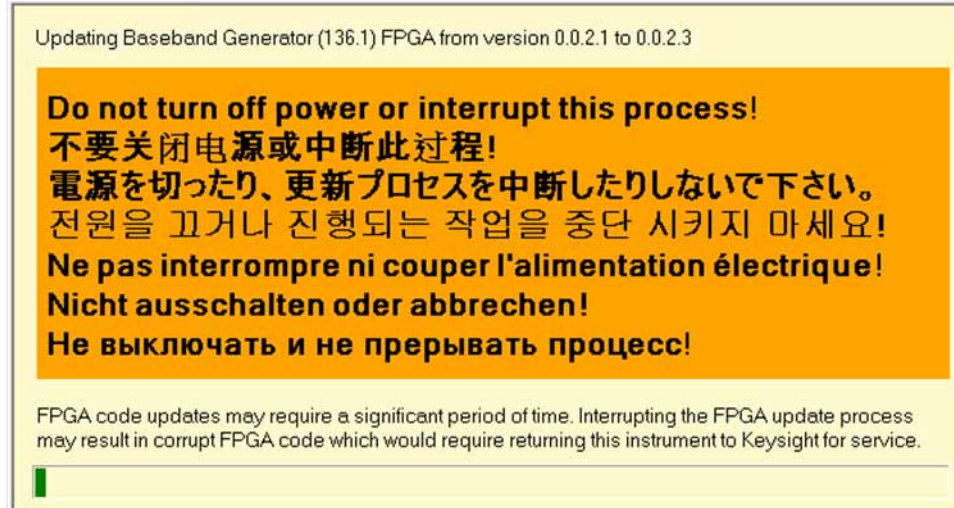

NOTE

During FPGA programming, DO NOT power off the E6640A for ANY reason! Interrupting the FPGA update process can place the instrument in an unusable state, requiring it to be returned to Keysight for repair.

After the installation has completed successfully, a confirmation message is displayed:

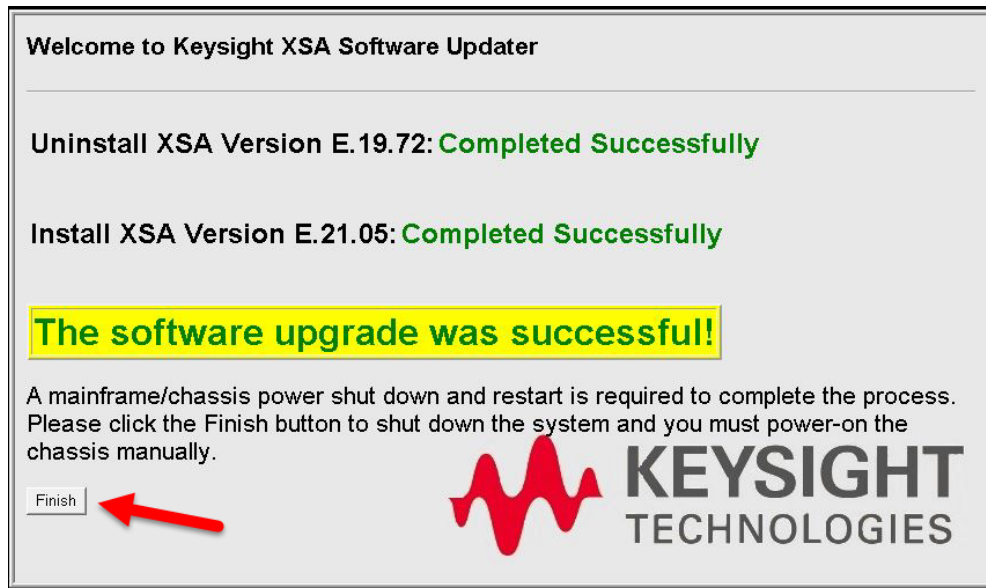

- 3 A reboot is required following the installation process. Reboot the E6640A by clicking **Finish** in the window. Windows will display a “System Shutdown” warning window; this is normal.

Table 3-2 **Preparing the installation**

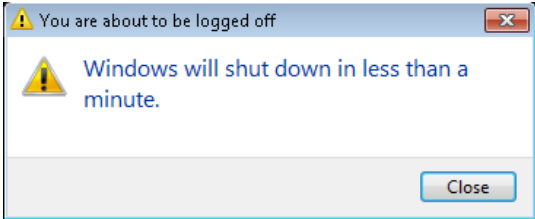
Step	Notes
4	Clicking the “Finish” button results in a Windows shutdown.
	
5	<p>After you power the E6640A back on, it will boot up in the default “Instrument” account, perform alignments, and finally display the measurement screen.</p> <p>If the instrument does not reboot, remove the USB storage device and cycle power. The boot order for the instrument may have been changed in the instrument BIOS previously, and the instrument may be instructed to boot from USB first, and the internal drive second. If this is the case, failure to remove the USB device will result in an error, as the instrument attempts to boot from it.</p>
6	<p>Check for any errors, and verify that the new software version is installed.</p> <p>In the System menu, press Show > System. Look for the line “Instrument S/W Revision”.</p>

Instrument S/W Revision (as it appears in the Traditional interface):

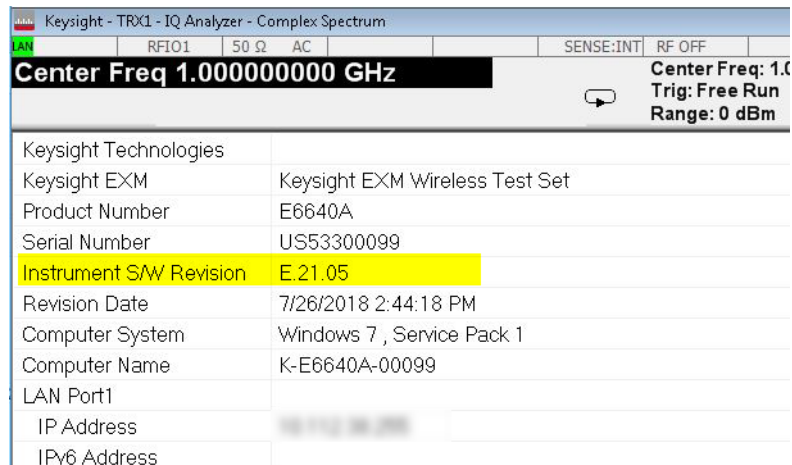

It is possible a newer version of the instrument software is available on the web at <http://www.keysight.com/find/e6640a>

NOTE

Additional recovery steps may be required to fully recover the system to a more current working state. This could involve restoring your own backups of the instrument configuration, including re-installing applications, data, and performing system customizations.

Configuring recovery prompt timing

You can configure the time at which the test set power-up process waits for the selection of the recovery process by performing the following steps:

Table 3-3

Recovery prompt timing

Step	Notes
1 From the Windows Start menu, right-click Computer and click Properties .	This opens the System window.
2 Click Advanced System Settings in the left pane.	This opens the System Properties window.
3 In the Startup and Recovery section, click Settings .	This opens the Startup and Recovery window.
4 Under the System Startup section you can either clear the Time to display a list of operating systems check box, or, select the Time to display recovery option when needed check box, and change the delay setting in seconds.	

NOTE

You must be logged in as an administrator to change these settings. See **“User Accounts”** on page 64 for more information.

4 OperatingTasks: System-Level Tasks

The following topics can be found in this section:

- “TRX Selection” on page 96
- “Port Configuration” on page 98
- “Switched MIMO” on page 114
- “True MIMO” on page 121
- “Tx Beam Forming” on page 135
- “E6640A Calibration Status” on page 137
- “Alignments (MultiTouch Interface)” on page 139
- “Alignments (Traditional Interface)” on page 142
- “LAN Address Configuration” on page 145
- “Managing Licenses” on page 147

TRX Selection

On the monitor or remote desktop view of the test set, each TRX is represented by a separate XSA window. You can identify which TRX a window controls by looking for the identifier (TRX1 through TRX4 for a fully loaded system) at the top left corner of the window. The TRXs are placed in numerical order in the PXIe chassis, beginning with TRX1 on the left.

Figure 4-1 Identifying application windows for different TRXs

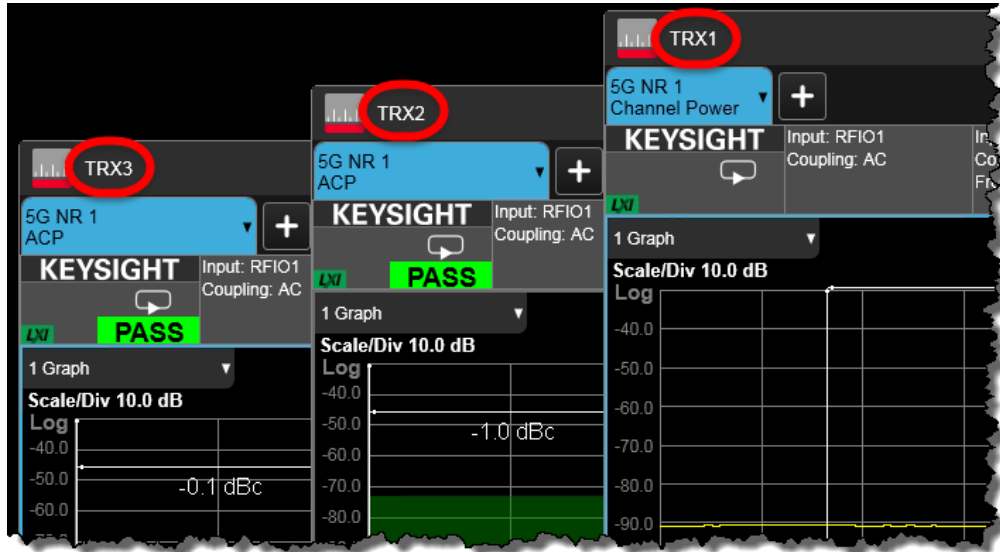

The **Traditional** interface uses a different color scheme than the **MultiTouch** example illustrated above, but the presentation is otherwise similar.

Open TRX windows are also shown in the Windows taskbar.

Figure 4-2 TRX icons in Windows taskbar



Although the test set as a whole is assigned only one IP address for the entire PXIe chassis, the individual TRXs within the chassis can be differentiated in network communication with the test set. The means of identifying a TRX depends upon the connection method, as outlined below.

Using HiSLIP

NOTE

HiSLIP (High-Speed LAN Instrument Protocol) is the recommended interface for connection to the E6640A, because of its superior performance characteristics.

Use hislip0 through hislip3:

- **TRX1:**
TCP/IP0::::hislip0::INSTR
- **TRX2:**
TCP/IP0::::hislip1::INSTR
- **TRX3:**
TCP/IP0::::hislip2::INSTR
- **TRX4:**
TCP/IP0::::hislip3::INSTR

Using Socket Ports

Use sockets 5025, 5125, 5225, and 5325:

Using VXI-11/SICL

Use inst0 through inst3:

- **TRX1:**
TCP/IP0::::inst0::INSTR
- **TRX2:**
TCP/IP0::::inst1::INSTR
- **TRX3:**
TCP/IP0::::inst2::INSTR
- **TRX4:**
TCP/IP0::::inst3::INSTR

Using Telnet Connection

Use telnet ports 5023, 5123, 5223, 5323:

- **TRX1:**
5023
- **TRX2:**
5123
- **TRX3:**
5223
- **TRX4:**
5323

Port Configuration

Any of the TRXs four RF ports can be configured as an input port (accepting a signal to be analyzed) or as an output port (providing an RF stimulus).

If the test set was purchased with Option 4FD, the TRX model used is M9433A, and ports RFIO 1 through RFIO 4 connect to the source and analyzer through a splitter/combiner rather than a switch; therefore, they can be used in full-duplex mode (that is, with a given port used for both input and output simultaneously). These ports can also be configured as input-only, or output-only. For more information on this option, see [“Option 4FD: Full Duplex Port Setup” on page 107](#) and [“Option 4FD: Separate Input and Output Port Setup” on page 108](#).

If the test set was purchased with Option 2FD, the TRX model used is M9432A. In this model, only ports **RFIO 1** and **RFIO 2** connect to the source and analyzer through a splitter/combiner (and can therefore be used in full-duplex mode). Ports **RF3 I/O** and **RF4 I/O** connect to the source and analyzer through a switch (each can serve as an input or an output, but can't do both at once).

NOTE

The 5G NR test application is currently not supported on the M9432A TRX.

Full Duplex Port Setup (RFIO 1 and RFIO 2)

Ports RFIO 1 and RFIO 2 on the M9432A TRX (Option 2FD) connect to a splitter/combiner, and can therefore be used in full duplex mode.

Figure 4-3 RFIO 1 on M9432A used in full duplex mode

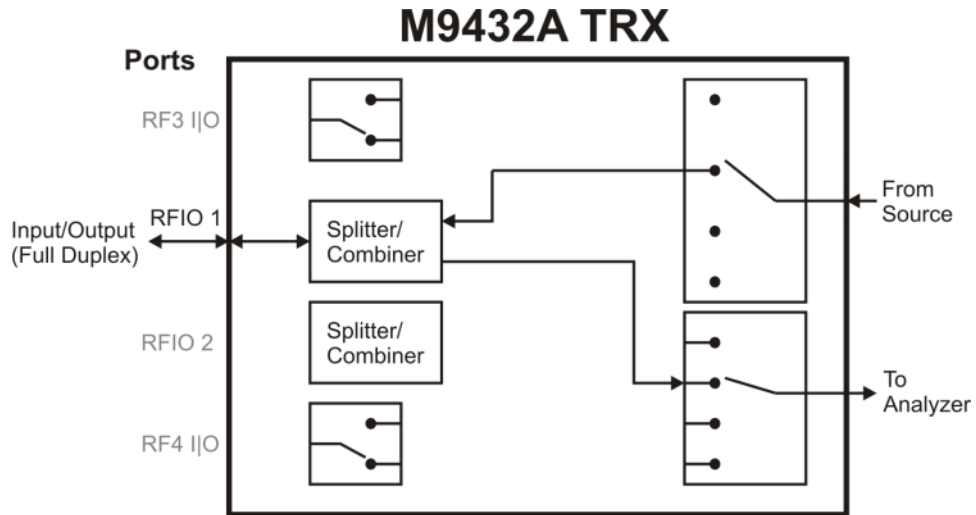

NOTE

The menu path for the **MultiTouch** interface is listed first, followed by the path for the **Traditional** interface in *italics*.

To use the RFIO 1 port as the input and output, set up the RF Input using this menu setting or its equivalent command.

Input/Output > Input > RF Input Port > RFIO 1

Input/Output > RF Input > RF Input Port > RFIO 1

Command:

:FEED:RF:PORT RFIO1

Then set up the RF Output using this menu setting or its equivalent command:

Input/Output > RF Source > RF Output Port RFIO1

Input/Output > More > RF Output & Test Set Config > RF Output Port > RFIO 1

Command:

:FEED:RF:PORT:OUTP RFIO1

Figure 4-4

RFIO 2 on M9432A used in full duplex mode

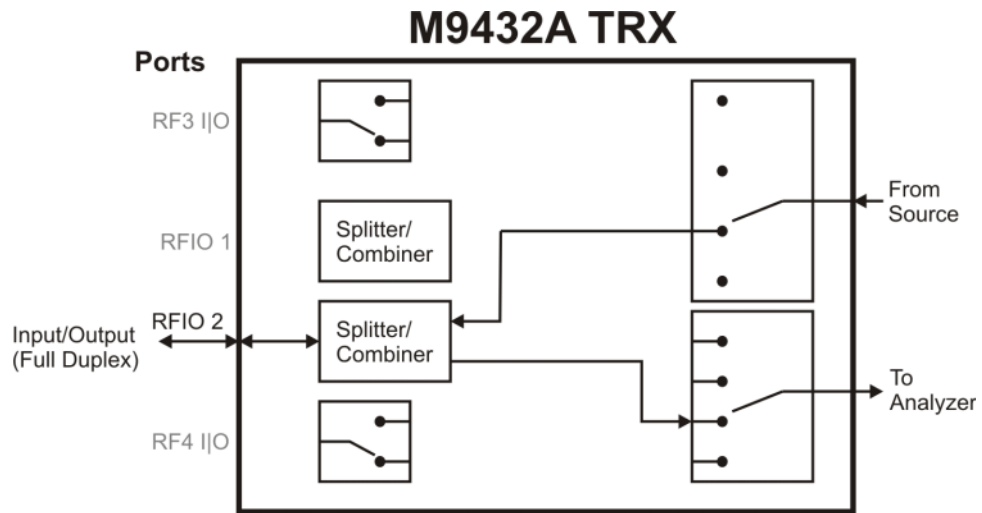

NOTE

The menu path for the **MultiTouch** interface is listed first, followed by the path for the **Traditional** interface in *italics*.

To use the RFIO 2 port as the input and output, set up the RF Input using this menu setting or its equivalent command:

Input/Output > Input > RF Input Port > RFIO 2

Input/Output > RF Input > RF Input Port > RFIO 2

Command:

:FEED:RF:PORT RFIO2

Then set up the RF Output using this menu setting or its equivalent command:

Input/Output > RF Source > RF Output Port RFIO 2

Input/Output > More > RF Output & Test Set Config > RF Output Port > RFIO 2

Command:

:FEED:RF:PORT:OUTP RFIO2

Separate Input and Output Port Setup (RF3 I/O and RF4 I/O)

Ports RF3 I/O and RF4 I/O on the M9432A TRX (Option 2FD) connect to a switch rather than a splitter/combiner, which means that one of these ports must be used as either an input or an output, not both, at any given time.

Because there is less RF path loss when a switch is used, these ports are preferred in situations where it is important to maximize RF power to the analyzer or from the source.

Figure 4-5 RF3 I/O on M9432A used as input, RF4 I/O as output

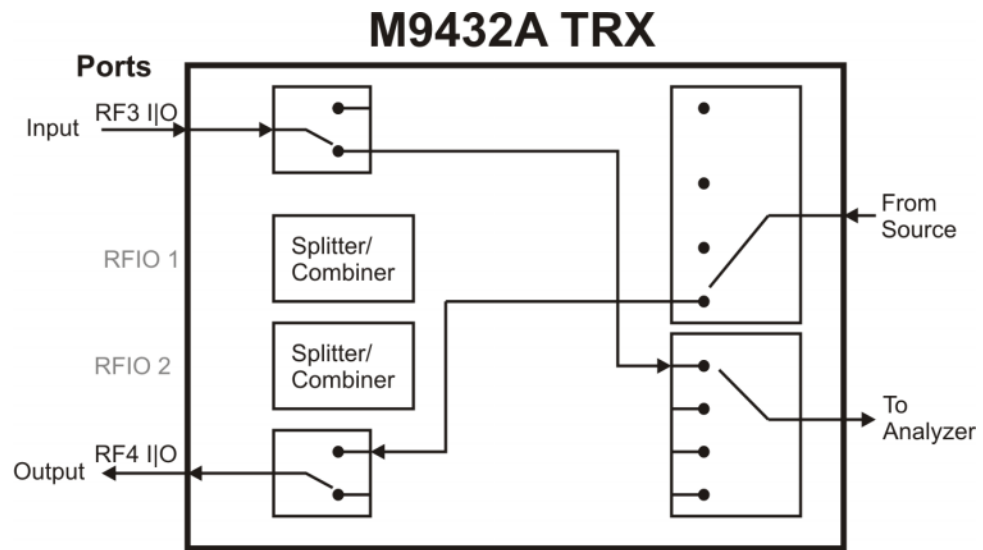

NOTE

The menu path for the **MultiTouch** interface is listed first, followed by the path for the **Traditional** interface in *italics*.

To define RF3 I/O as an input and RF4 I/O as an output, follow this four-step process.

(1) Define RF3 I/O as an input, using this menu setting or its equivalent command:

Input/Output > Input > Half Duplex Input Port > RF3 I/O

Input/Output > More > RF Output & Test Set Config > Half Duplex Config > RF Input Port > RF3 I/O

Command:

:HDUPlex:PORT:INPut RFIO3

(2) Define RF4 I|O as an output, using this menu setting or its equivalent command:

Input/Output > RF Source > Half Duplex Output Port > RF4 I|O

Input/Output > More > RF Output & Test Set Config > Half Duplex Config > RF Output Port > RF4 I|O

Command:

`[:SENSe]:HDUPlex:PORT:OUTPut RFIO4`

(3) Set up the RF Input using this menu setting or its equivalent command:

Input/Output > Input > RF Input Port > RF Input

Input/Output > RF Input > RF Input Port > RF Input

Command:

`:FEED:RF:PORT RFIN`

(4) Set up the RF Output using this menu setting or its equivalent command:

Input/Output > Source > RF Output Port > RF Output

Input/Output > More > RF Output & Test Set Config > RF Output Port > RF Output

Command:

`:FEED:RF:PORT:OUTP RFO`

Figure 4-6

RF3 I/O on M9432A used as output, RF4 I/O as input

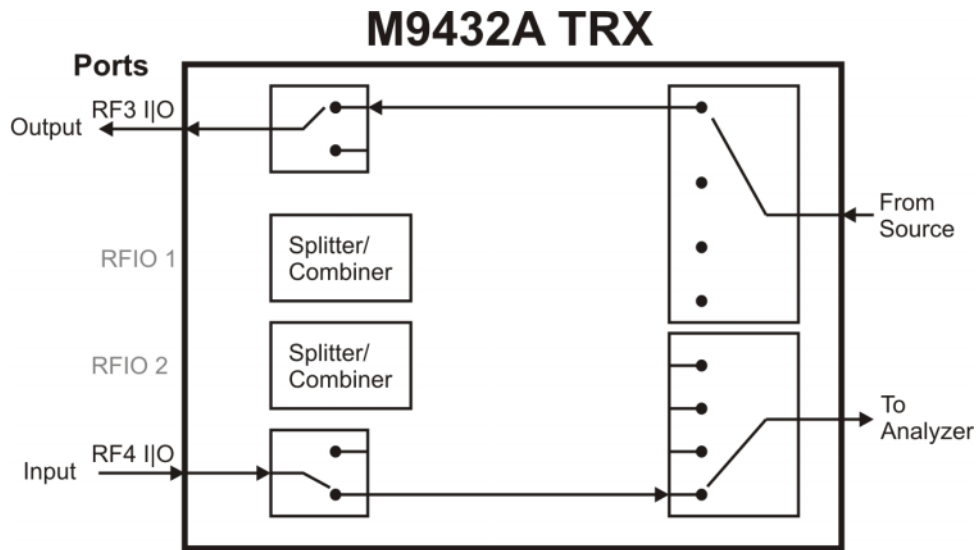

NOTE The menu path for the **MultiTouch** interface is listed first, followed by the path for the **Traditional** interface in *italics*.

To define RF4 I/O as an input and RF3 I/O as an output, follow this four-step process.

(1) Define RF4 I/O as an input, using this menu setting or its equivalent command:

Input/Output > Input > Half Duplex Input Port > RF4 I/O

Input/Output > More > RF Output & Test Set Config > Half Duplex Config > RF Input Port > RF4 I/O

Command:
:HDUPlex:PORT:INPut RFI04

(2) Define RF3 I/O as an output, using this menu setting or its equivalent command:

Input/Output > RF Source > Half Duplex Output Port > RF3 I/O

Input/Output > More > RF Output & Test Set Config > Half Duplex Config > RF Output Port > RF3 I/O

Command:
[:SENSe]:HDUPlex:PORT:OUTPut RFI03

(3) Set up the RF Input using this menu setting or its equivalent command:

Input/Output > Input > RF Input Port > RF Input

Input/Output > RF Input > RF Input Port > RF Input

Command:

:FEED:RF:PORT RFIN

(4) Set up the RF Output using this menu setting or its equivalent command:

Input/Output > Source > RF Output Port > RF Output

Input/Output > More > RF Output & Test Set Config > RF Output Port > RF Output

Command:

:FEED:RF:PORT:OUTP RFO

Separate Input and Output Port Setup (RFIO 1 and RFIO 2)

Although Ports RFIO 1 and RFIO 2 on the M9432A TRX (Option 2FD) are designed to operate as full-duplex ports, they can function as separate inputs and outputs.

Figure 4-7 RFIO 1 on M9432A used as input, RFIO 2 as output

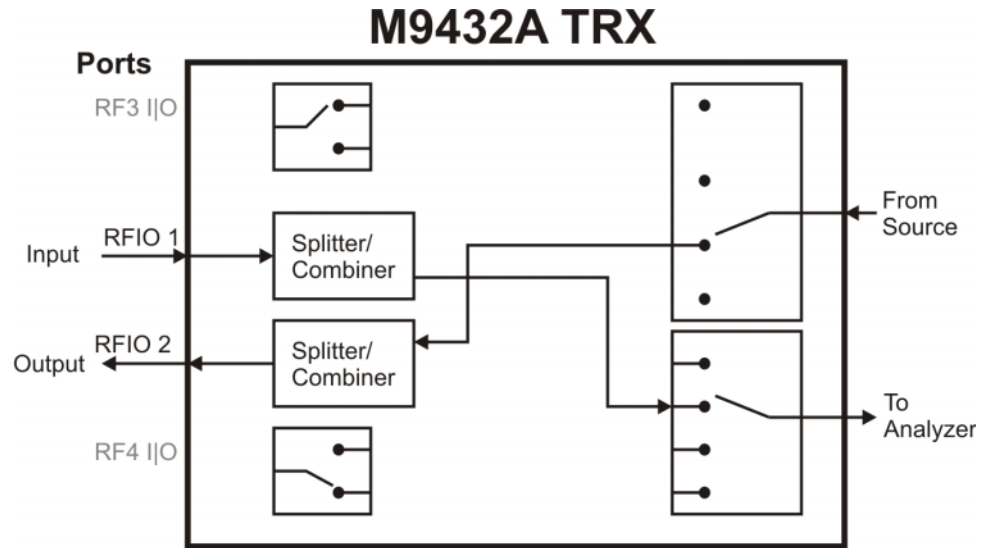

NOTE

The menu path for the **MultiTouch** interface is listed first, followed by the path for the **Traditional** interface in *italics*.

To use the RFIO 1 port as the input and the RFIO 2 port as the output, set up the RF Input using this menu setting or its equivalent command:

Input/Output > Input > RF Input Port > RFIO 1

Input/Output > RF Input > RF Input Port > RFIO 1

Command:

:FEED:RF:PORT RFIO1

Then set up the RF Output using this menu setting or its equivalent command:

Input/Output > RF Source > RF Output Port RFIO 2

Input/Output > More > RF Output & Test Set Config > RF Output Port > RFIO 2

Command:

:FEED:RF:PORT:OUTP RFIO2

Figure 4-8

RFIO 2 on M9432A used as input, RFIO 1 as output

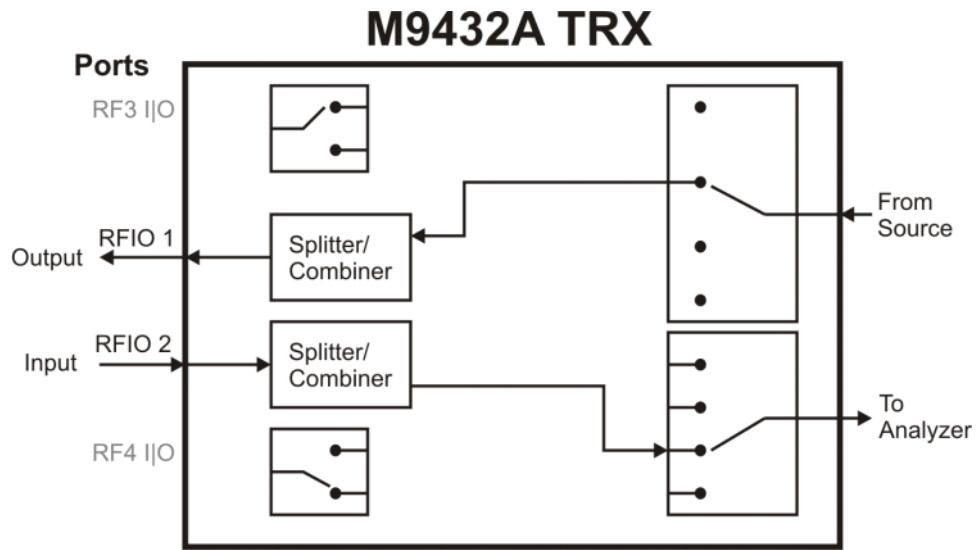

NOTE

The menu path for the **MultiTouch** interface is listed first, followed by the path for the **Traditional** interface in *italics*.

To use the RFIO 1 port as the input and the RFIO 2 port as the output, set up the RF Input using this menu setting or its equivalent command:

Input/Output > Input > RF Input Port > RFIO 2

Input/Output > RF Input > RF Input Port > RFIO 2

Command:

:FEED:RF:PORT RFIO2

Then set up the RF Output using this menu setting or its equivalent command:

Input/Output > RF Source > RF Output Port RFIO 1

Input/Output > More > RF Output & Test Set Config > RF Output Port > RFIO 1

Command:

:FEED:RF:PORT:OUTP RFIO1

Option 4FD: Full Duplex Port Setup

If the test set was purchased with Option 4FD, the M9433A TRX is used. Each of the IO ports connects to a splitter/combiner rather than a switch, and it can be used in full duplex mode, as a simultaneous input and output. In the example illustrated below, the RFIO 2 port is used in this way. (Other ports could be selected simply by substituting different port names in the instructions provided below.)

Figure 4-9 RFIO 2 on M9433A used in full duplex mode

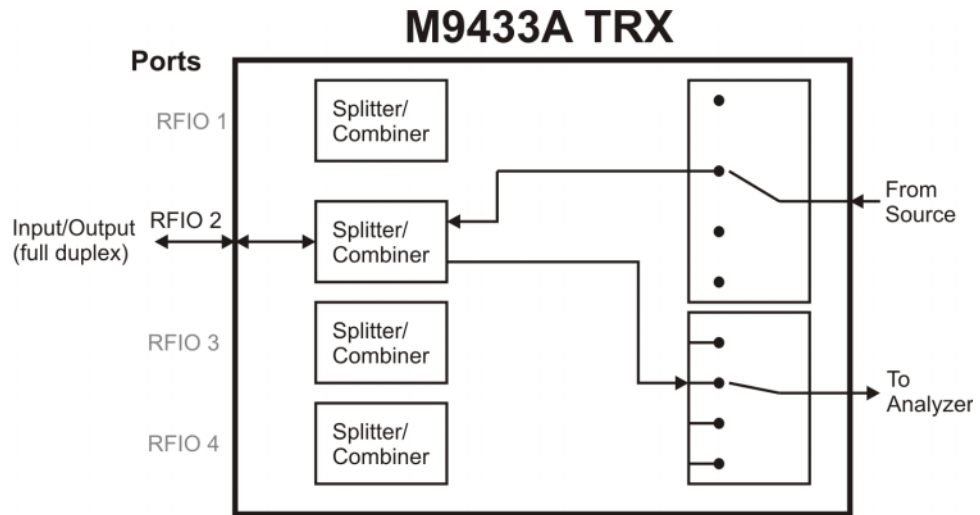

NOTE

The menu path for the **MultiTouch** interface is listed first, followed by the path for the **Traditional** interface in *italics*.

To use the RFIO 2 port as the input and output, set up the RF Input using this menu setting or its equivalent command:

Input/Output > Input > RF Input Port > RFIO 2

Input/Output > RF Input > RF Input Port > RFIO 2

Command:

:FEED:RF:PORT RFIO2

Then set up the RF Output using this menu setting or its equivalent command:

Input/Output > RF Source > RF Output Port RFIO 2

Input/Output > More > RF Output & Test Set Config > RF Output Port > RFIO 2

Command:

:FEED:RF:PORT:OUTP RFIO2

Option 4FD: Separate Input and Output Port Setup

Although, with Option 4FD, all of the RFIO ports are designed to operate as full-duplex ports, they can function as separate inputs and outputs. In this example, the RFIO 2 port is used as an input, and the RFIO 3 port as an output. (Other port combinations could be selected simply by substituting different port names in the instructions provided below.)

Figure 4-10 RFIO 2 on M9433A used as input, RFIO 3 as output

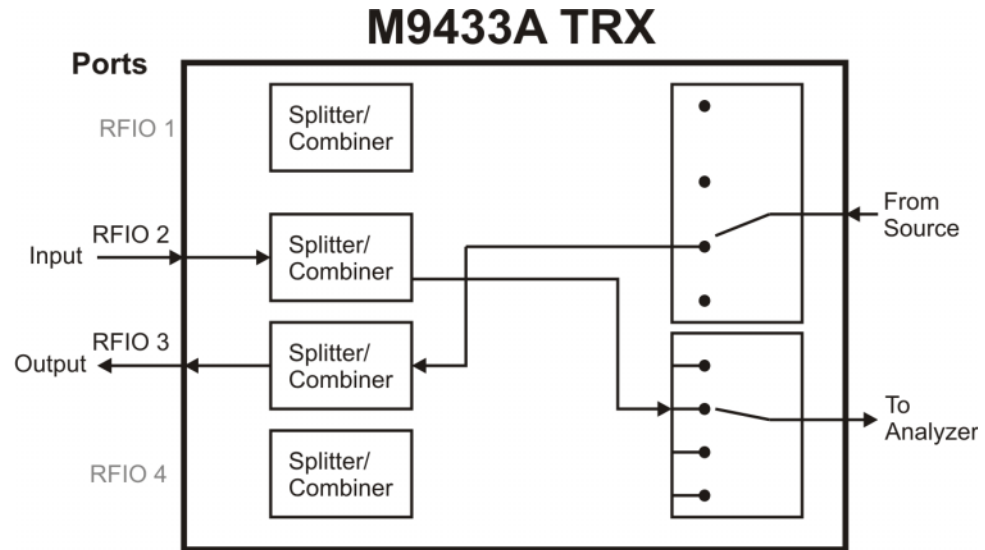

NOTE

The menu path for the **MultiTouch** interface is listed first, followed by the path for the **Traditional** interface in *italics*.

To use the RFIO 2 port as the input and the RFIO 3 port as the output, set up the RF Input using this menu setting or its equivalent command:

Input/Output > Input > RF Input Port > RFIO 2

Input/Output > RF Input > RF Input Port > RFIO 2

Command:
:FEED:RF:PORT RFIO2

Then set up RFIO 3 as the RF Output, using this menu setting or its equivalent command:

Input/Output > RF Source > RF Output Port RFIO 3

Input/Output > More > RF Output & Test Set Config > RF Output Port > RFIO 3

Command:
:FEED:RF:PORT:OUTP RFIO3

Millimeter-Wave Accessory Instruments

For testing at higher frequencies than the EXM itself can generate, two other instruments are commonly used with the EXM: the M1740A mmWave Transceiver (usually called the Remote Radio Head or RRH) and the E7770A Common Interface Unit (usually called the CIU).

Figure 4-11 EXM used with M1740A (left) and E7770A (top)



As illustrated below, the CIU is able to upconvert the RF output of the EXM to the 6-12 GHz range (the lower portion of the picture), and apply this signal to the DUT. On the same path, it also can accept a return signal from the DUT, downconvert it to the range of the EXM, and return it to an input port on the EXM.

For mmWave testing (the upper portion of the picture), the RF output of the EXM can pass through the CIU (bypassing the upconverter) to the M1740A remote radio head, where it is upconverted to a mmWave signal which is transmitted wirelessly to the DUT. The returned mmWave signal is received by the M1740A, downconverted, and passed back through the CIU to the EXM RF input. The CIU also supplies the combined LO, DC Power, and Control inputs which the M1740A requires. The LO/Ctrl/Pwr output of the CIU is the only essential connection between the CIU and M1740A, because the RF input and output from the EXM can be cabled directly between the EXM and the M1740A, rather than passing through the CIU as in this illustration.

Figure 4-12 Functional block diagrams of M1740A and E7770A

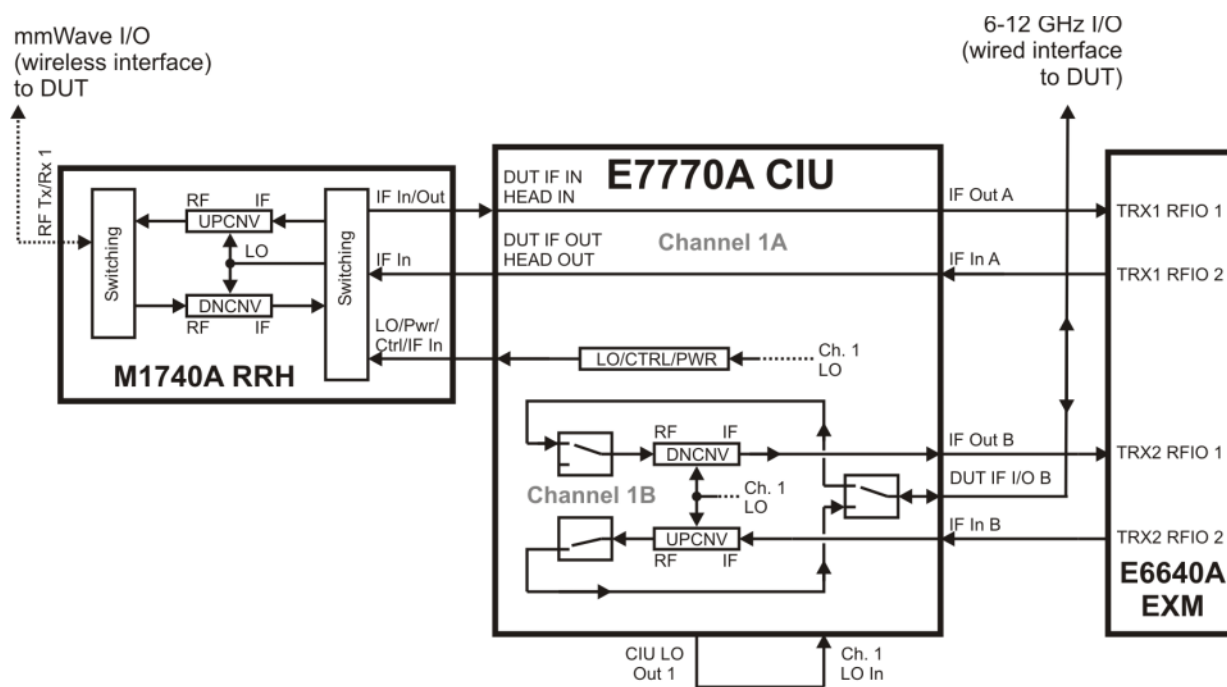

In the test setup illustrated below, the EXM is used to drive mmWave testing of the DUT over a wireless interface (typically using horn antennas within a test chamber). The CIU provides the combined LO, Power, and Control inputs needed by the M1740As. In this case the inputs and outputs from the EXM are applied directly to the M1740As, instead of being passed through the CIU.

Figure 4-13 EXM, CIU, and four M1740As used for mmWave testing

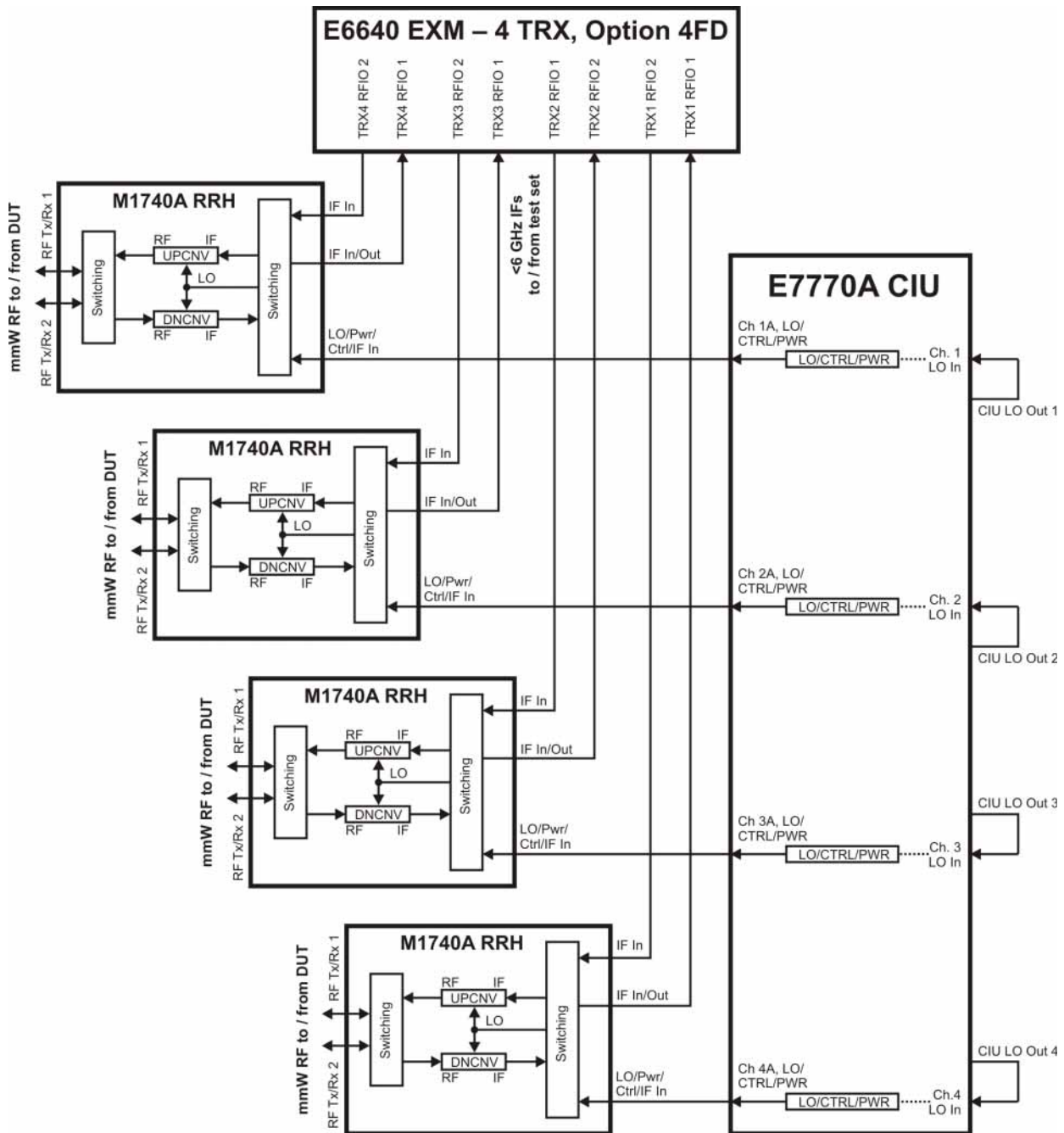

The test setup illustrated below expands on the previous example, by adding 6-12 GHz testing of the DUTs over a wired interface. A second CIU is used for upconversion of the EXM output to the 6-12 GHz range (and downconversion of the signal returned by the DUT). The first CIU is not used for this, because its LO resources are providing the combined LO, Power, and Control inputs needed by the M1740As, and are therefore not available to support upconversion and downconversion.

Figure 4-14 EXM, 2 CIUs, and four M1740As; mmWave testing and 6-12 GHz testing

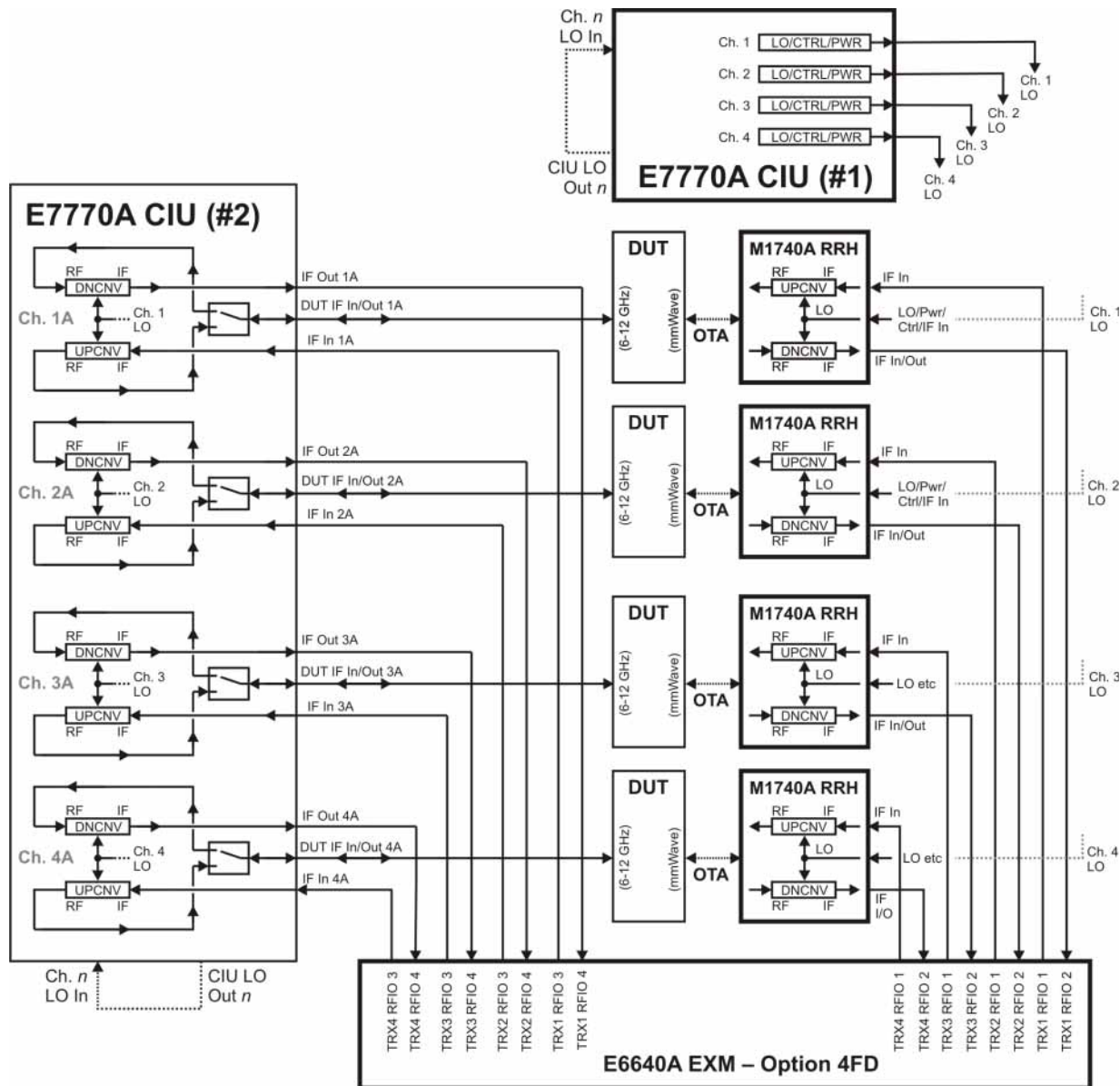

The test setup illustrated is used for WLAN testing, which requires an input to the DUT in the 7 GHz range, which is slightly above the frequency range of the EXM. An output signal from the EXM is upconverted by the CIU and furnished to the DUT. The returned signal from the DUT, being below 6 GHz, is returned directly to the EXM instead of being passed through the CIU for downconversion.

Figure 4-15 CIU used for WLAN testing

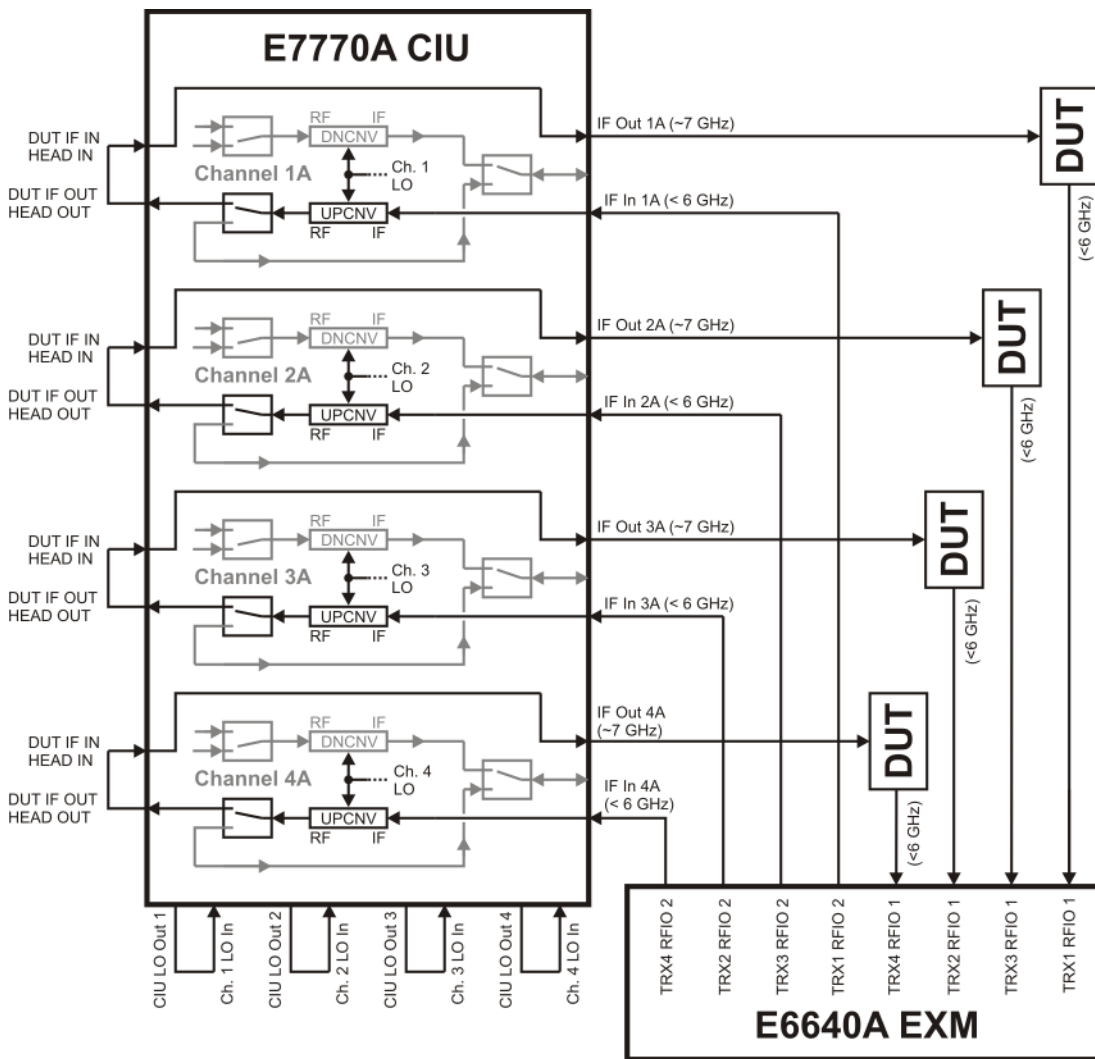

Switched MIMO

For WLAN modulation accuracy measurements, a form of MIMO measurement can be made with a single TRX, using a time-division multiplexing process. The same source/analyzer pair within the TRX switches between the antenna ports of the Device Under Test.

In contrast to true MIMO functionality, which is available in WLAN mode but not in Sequence Analyzer mode, the switched MIMO feature is a WLAN measurement which is available **only** in Sequence Analyzer mode.

Constraints on Radio Standards

Only the **802.11n** and **802.11ac** radio standards for WLAN support MIMO.

MIMO Port Configuration

For 2x2 MIMO, the RFIO 1 port (a full-duplex port) captures the data stream from the first antenna port of the DUT. The other full-duplex port, RFIO 2, captures the data stream from the second antenna port of the DUT.

Figure 4-16

2X2 switched MIMO connections

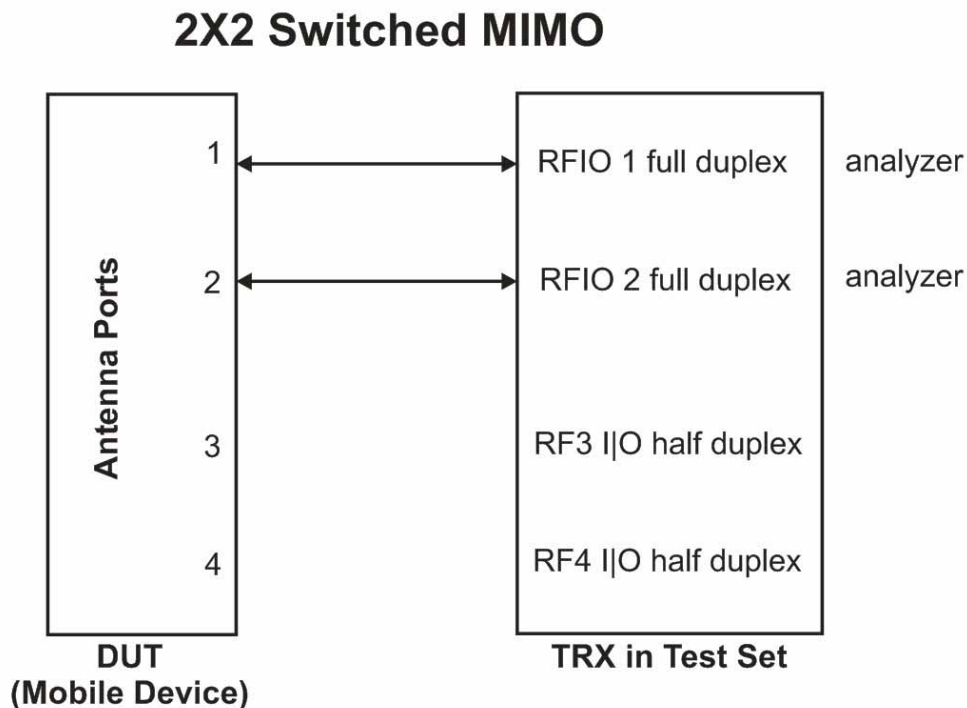

For 3x3 MIMO, the RFIO 1 port (a full-duplex port) captures the data stream from the first antenna port of the DUT. The other full-duplex port, RFIO 2, captures the data stream from the second antenna port of the DUT. One of the half-duplex ports, RF3 I/O or RF4 I/O, captures the data stream from the third antenna port of the DUT.

Figure 4-17 3X3 switched MIMO connections

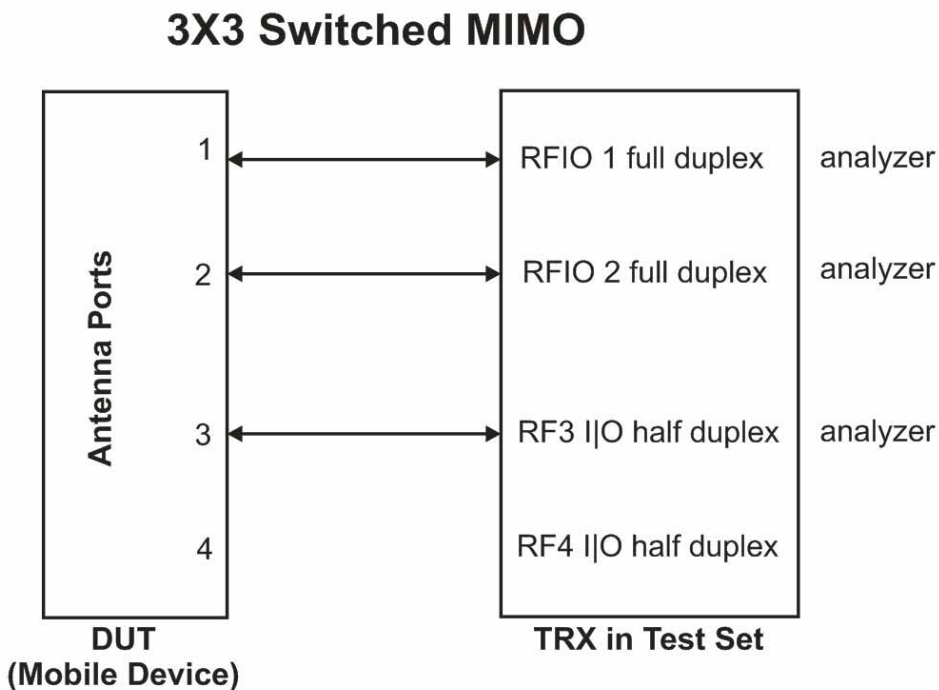

Source Sync Control

Switched MIMO is a measurement process only; it is not necessary to use Source Sync Control (required for true MIMO) in the case of switched MIMO.

RF Input Port Mode

The RF Input Port Mode must be set to List, so that the sequence can change the input port path from one acquisition to the next. In the **Meas Setup > Advanced > RF Input Port Mode** menu, select **List**.

The equivalent menu path in the **Traditional** interface is: **Meas Setup > RF Input Port Mode**.

The equivalent SCPI command is:

```
[ :SENSe ] :LSEQuencer :PORT :INPut :MODE LIST
```

Half Duplex RF Input

In the case of 3x3 switched MIMO, one of the half-duplex ports (RF3 I/O or RF4 I/O) must be designated as an RF input port for the third input. In the **Input/Output > Input > Half Duplex Input Port** menu, select **RFIO3** or **RFIO4**, so that the RF3 I/O port or the RF4 I/O port is defined as the input port.

The equivalent menu path for the **Traditional** interface is:

Input/Output > RF Output & Test Set Config > Half Duplex Config > RF Input Port

The equivalent SCPI command is:

```
[ :SENSe ]:HDUPlex:PORT:INPut RFIO3|RFIO4
```

Acquisition Triggers

Each of the acquisitions which make up a sequence used for switched MIMO testing needs to have the same trigger settings as the others.

Acquisition Integration

For 2x2 switched MIMO in Sequence Analyzer mode, two separate acquisitions are used for the two separate ports, and must be integrated. Set up acquisition integration as follows: in the **Meas Setup > Settings > Integration Type** menu, select **Primary** for the first acquisition and **Switch MIMO** for the second. The equivalent SCPI commands are:

```
[ :SENSe ]:LSEQuencer:ACQuire{1:512}:SETup:INTEgration PRIMary  
[ :SENSe ]:LSEQuencer:ACQuire{1:512}:SETup:INTEgration SMIMo
```

The equivalent menu path for the **Traditional** interface is:

Meas Setup > Acquisition Setup > Acquisition Integration

For 3x3 switched MIMO in Sequence Analyzer mode, three separate acquisitions are used for the three separate ports, and must be integrated. Set up acquisition integration as follows: in the **Meas Setup > Settings > Integration Type** menu, select **Primary** for the first acquisition and **Switch MIMO** for the second and third. The equivalent SCPI commands are:

```
[ :SENSe ]:LSEQuencer:ACQuire{1:512}:SETup:INTEgration PRIMary  
[ :SENSe ]:LSEQuencer:ACQuire{1:512}:SETup:INTEgration SMIMo  
[ :SENSe ]:LSEQuencer:ACQuire{1:512}:SETup:INTEgration SMIMo
```

The equivalent menu path for the **Traditional** interface is:

Meas Setup > Acquisition Setup > Acquisition Integration

NOTE

The integration parameter can also be set within the complex command which is used to set the Acquisition RF Input Port (see **“Acquisition RF Input Port” on page 117**); the integration parameter is the one which comes immediately before the Acquisition RF Input Port parameter.

Acquisition RF Input Port

An RF input path must be selected for each acquisition. In the **Meas Setup > Settings > RF Input Port** menu, select **RFIO1**, **RFIO2**, or **RF Input**, as needed for each acquisition.

The equivalent menu path for the **Traditional** interface is:
Meas Setup > Acquisition Setup > Acquisition RF Input Port

The **RF Input** selection, which is used for the third port in 3x3 switched MIMO, means that whichever of the half-duplex ports (RF3 I/O or RF4 I/O) has been designated as the RF input is used (see **“Half Duplex RF Input” on page 116**). In SCPI, the acquisition RF input port is controlled by the last parameter in the complex command which configures the acquisition (the values for the relevant parameter are italicized here):

```
[[:SENSe]:LSEQuencer:ACQuire[1]|2|...|4..512:SETup  
NONE | GSM | EDGE | WCDMA | CDMA2K | CDMA1XEV | LTE | LTETDD |  
TDSCDMA | BTooth | WLAN,  
NONE | PGSM | EGSM | RGSM | DCS1800 | PCS1900 | TGSM810 | GSM450 |  
GSM480 | GSM850 | GSM700 | BANDI | BANDII | BANDIII | BANDIV |  
BANDV | BANDVI | BANDVII | BANDVIII | BANDIX | BANDX | BANDXI |  
BANDXII | BANDXIII | BANDXIV | USCELL | USPCS | JAPAN | KOREAN |  
NMT | IMT2K | UPPER | SECOND | PAMR400 | PAMR800 | IMTEXT |  
PCS1DOT9G | AWS | US2DOT5G | PUBLIC | LOWER | BAND1 | BAND2 | BAND3  
| BAND4 | BAND5 | BAND6 | BAND7 | BAND8 | BAND9 | BAND10 | BAND11 |  
BAND12 | BAND13 | BAND14 | BAND17 | BAND18 | BAND19 | BAND20 |  
BAND21 | BAND24 | BAND25 | BAND26 | BAND27 | BAND28 | BAND31 |  
BAND33 | BAND34 | BAND35 | BAND36 | BAND37 | BAND38 | BAND39 |  
BAND40 | BAND41 | BAND42 | BAND43 | BAND44 | BANDA | BANDB | BANDC  
| BANDD | BANDE | BANDF,  
BTS | MS,  
<real>, <integer>, <ampl>,  
LOW | ZERO | HIGH,  
<time>, <time>,  
IMMediate | VIDEo | Video2 | INTernal | EXT1 | EXT2,  
<amptd>, <time>,  
NONE | INT/,  
<relative ampl>,  
OFF | RFIO0 | RFIO1 | RFIO2 | RFIO3 | RFIO4 | RFIO5 | RFIO6 |  
RFIO7,  
ON | OFF,  
NORMal | PRIMary | LOWer | UPPer | RANGE | SMIMo,  
RFIO1 | RFIO2 | RFIN | RFIO3 | RFIO4
```

NOTE

In the Acquisition RF Input Port parameter (italicized above), the values RFIO3 and RFIO4 apply only if the test set has Option 4FD. The parameter immediately preceding that one is the Acquisition Integration parameter, and can be set to PRIMary or SMIMo as needed (see **“Acquisition Integration” on page 116**).

Switched MIMO Modulation Accuracy measurement SCPI commands

The following commands are used to set up the MIMO Modulation Accuracy (“EVM MIMO”) measurement.

Command	Description	Notes
:CALCulate:LSEQuencer:WLAN:EVMMimo:LIMit:FERRor <real>	Freq Error	Sets a frequency error limit
:CALCulate:LSEQuencer:WLAN:EVMMimo:LIMit:CLKError <real>	Clock Error	Sets a clock error limit
:CALCulate:LSEQuencer:WLAN:EVMMimo:LIMit:CFLeakage <rel_amp1>	Center Freq Leakage	Sets Center Freq Leakage limit
:CALCulate:LSEQuencer:WLAN:EVMMimo:LIMit:CFLeakage <rel_amp1>	BPSK-1/2 RMS EVM	Sets BPSK coding rate 1/2 RMS EVM limit
:CALCulate:LSEQuencer:WLAN:EVMMimo:LIMit:RMS:BPSK:R1B2 <rel_amp1>	QPSK-1/2 RMS EVM	Sets QPSK coding rate 1/2 RMS EVM limit
:CALCulate:LSEQuencer:WLAN:EVMMimo:LIMit:RMS:QPSK:R1B2 <rel_amp1>	QPSK-3/4 RMS EVM	Sets QPSK coding rate 3/4 RMS EVM limit
:CALCulate:LSEQuencer:WLAN:EVMMimo:LIMit:RMS:QPSK:R3B4 <rel_amp1>	16QAM-1/2 RMS EVM	Sets 16QAM coding rate 1/2 RMS EVM limit
:CALCulate:LSEQuencer:WLAN:EVMMimo:LIMit:RMS:QA16:R1B2 <rel_amp1>	16QAM-3/4 RMS EVM	Sets 16QAM coding rate 3/4 RMS EVM limit
:CALCulate:LSEQuencer:WLAN:EVMMimo:LIMit:RMS:QA16:R3B4 <rel_amp1>	64QAM-2/3 RMS EVM	Sets 64QAM coding rate 2/3 RMS EVM limit
:CALCulate:LSEQuencer:WLAN:EVMMimo:LIMit:RMS:QA64:R2B3 <rel_amp1>	64QAM-3/4 RMS EVM	Sets 64QAM coding rate 3/4 RMS EVM limit
:CALCulate:LSEQuencer:WLAN:EVMMimo:LIMit:RMS:QA64:R5B6 <rel_amp1>	64QAM-5/6 RMS EVM	Sets 64QAM coding rate 5/6 RMS EVM limit
:CALCulate:LSEQuencer:WLAN:EVMMimo:LIMit:RMS:QA256:R3B4 <rel_amp1>	256QAM-3/4 RMS EVM	Sets 256QAM coding rate 3/4 RMS EVM limit
:CALCulate:LSEQuencer:WLAN:EVMMimo:LIMit:RMS:QA256:R5B6 <rel_amp1>	256QAM-5/6 RMS EVM	Sets 256QAM coding rate 5/6 RMS EVM limit

Command	Description	Notes
:CALCulate:LSEQuencer:WLAN:EVMMimo:EQualizer:TMODE SEQuence SDATA	Equalizer Training	Specifies how the equalizer is initialized or trained.
:CALCulate:LSEQuencer:WLAN:EVMMimo:PILot:TRACk:AMPLitude OFF ON 0 1	Track Amplitude	Specifies whether analyzer tracks amplitude changes in the pilot subcarriers.
:CALCulate:LSEQuencer:WLAN:EVMMimo:PILot:TRACk:PHASe OFF ON 0 1	Track Phase	Specifies whether analyzer tracks phase changes in the pilot subcarriers.
:CALCulate:LSEQuencer:WLAN:EVMMimo:PILot:TRACk:TIMing OFF ON 0 1	Track Timing	Specifies whether analyzer tracks timing changes in the pilot subcarriers.
:CALCulate:LSEQuencer:WLAN:EVMMimo:PILot:TRACk:MODE POSTeq PREeq	Pilot Tracking Mode	Specifies the Pilot Tracking Mode. The valid values are Post EQ and Pre EQ.
[:SENSe]:LSEQuencer:WLAN:EVMMimo:MTYPE DMAP FOURier	Matrix Type	Specifies MIMO matrix type.

Switched MIMO Results

The results available for a WLAN MIMO Modulation Accuracy measurement are as follows (the results for Stream 3 are returned as -1.0 (not tested) in the case of 2x2 MIMO):

Index	Result Parameter
0	Overall Pass/Fail Result (0 = Pass, 1 = Fail, -1 = Not tested)
1	Stream 1 RMS EVM pass/fail result (1.0 = fail, 0.0 = pass, -1.0 = Not tested)
2	Stream 1 RMS EVM (dB)
3	Stream 1 Peak EVM (dB)
4	Stream 1 Pilot EVM (dB)
5	Stream 1 Data EVM (dB)
6	Stream 1 Chips Peak EVM (%)
7-18	7-12: Stream 2 (as in Index 1-6 above). 13-18: Stream 3 (as in Index 1-6 above)
19-24	Reserved
25	Channel 1 RMS EVM pass/fail result (1.0 = fail, 0.0 = pass, -1.0 = Not tested)
26	Channel 1 Frequency Error pass/fail result (1.0 = fail, 0.0 = pass, -1.0 = Not tested)
27	Channel 1 Symbol Clock Error pass/fail result (1.0 = fail, 0.0 = pass, -1.0 = Not tested)
28	Channel 1 IQ Offset pass/fail result (1.0 = fail, 0.0 = pass, -1.0 = Not tested)
29	Channel 1 RMS EVM (dB)
30	Channel 1 Peak EVM (dB)
31	Channel 1 Pilot EVM (dB)
32	Channel 1 Data EVM (dB)
33	Channel 1 Frequency Error (Hz)
34	Channel 1 Symbol Clock Error (ppm)
35	Channel 1 IQ Gain Imbalance (dB)
36	Channel 1 IQ Offset (dB)
37	Channel 1 IQ Quadrature Error (deg)
38	Channel 1 IQ Timing Skew (pps)
39	Channel 1 Cross Power (dB)
40	Channel 1 Sync Corr
41-72	41-56: Channel 2 (as in Index 25-40 above). 57-72: Channel 3 (as in Index 25-40 above)
73-88	Reserved

True MIMO

In WLAN mode, True MIMO (simultaneous rather than switched MIMO) is supported for the MIMO Modulation Analysis measurement. (This functionality is not available in Sequence Analyzer mode.) Setting up this type of measurement requires configuration of two separate TRXs.

For MIMO Modulation Analysis, two or more measurement data streams are captured simultaneously, by two or more separate TRXs in the EXM test set. In the EXM, the TRXs share a common frequency reference. They also share a common IP address, but have separate socket numbers. In MIMO testing, a single TRX is designated the primary, and it controls the other TRX or TRXs used.

TRX Configurations

Here is an example of 2x2 MIMO:

Figure 4-18 2X2 true MIMO connections

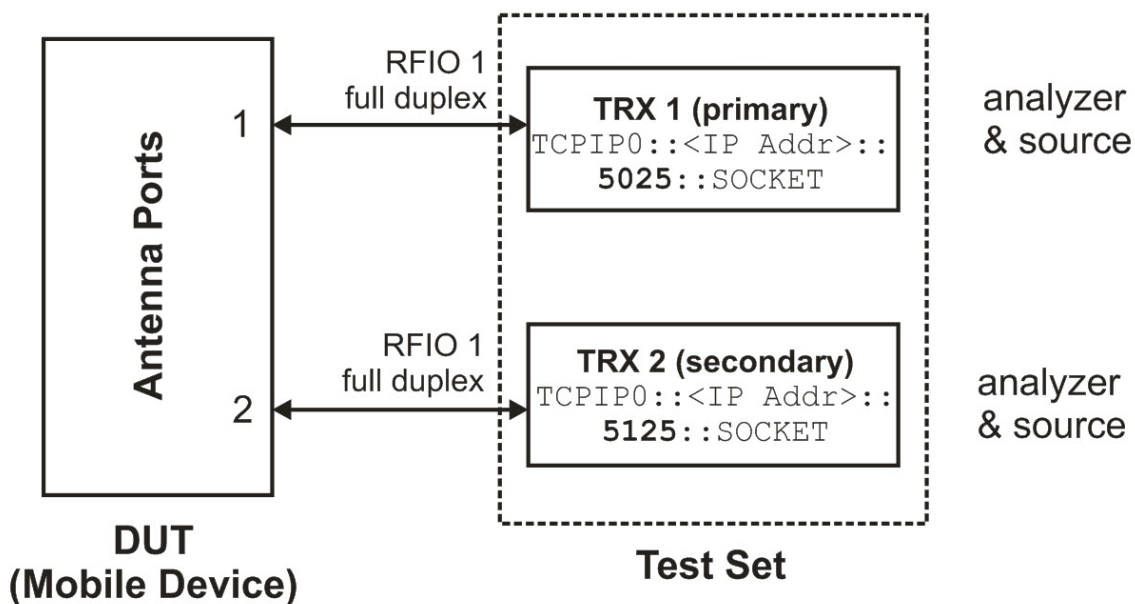

In the example setup shown here, TRX 1 runs the MIMO Modulation Analysis measurement, and is also configured to control TRX 2, which collects the second data stream. The primary TRX controls the measurement settings for the secondary TRX, and also processes the measurement data collected by the secondary. (The display window for the secondary will display a mostly-blank screen, with a message indicating that it is in use by the primary.)

Here is an example of 3x3 MIMO:

Figure 4-19

3X3 true MIMO connections

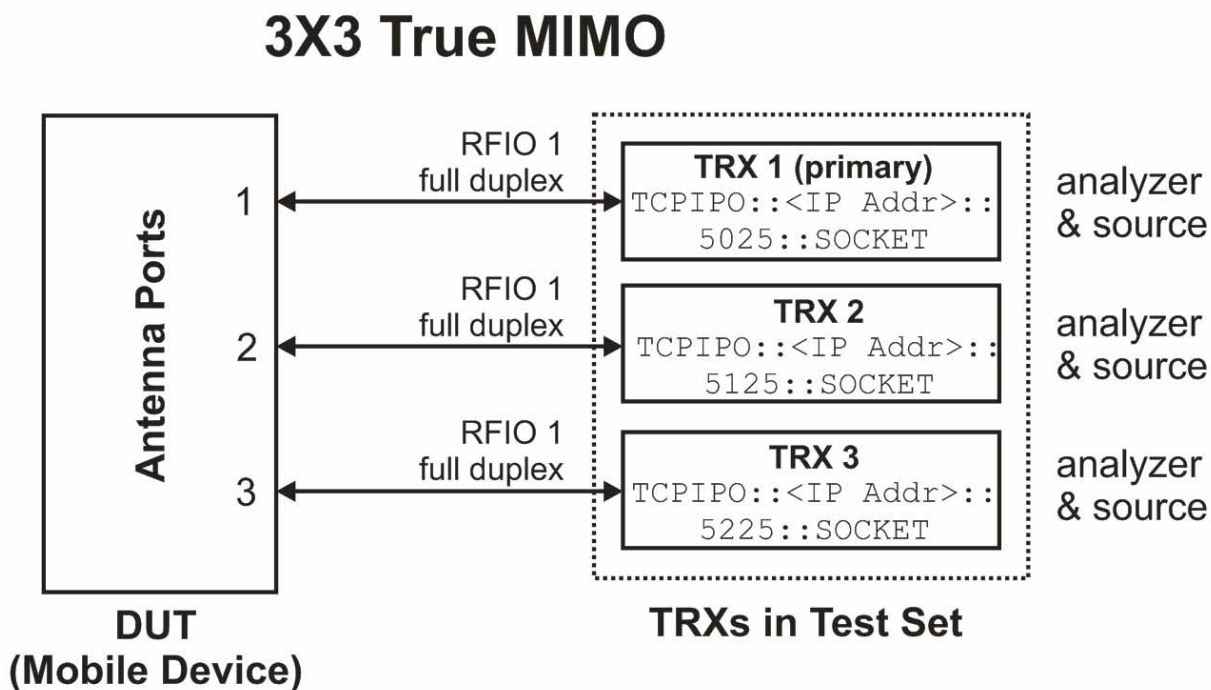

In the example setup shown here, TRX 1 runs the MIMO Modulation Analysis measurement, and is also configured to control TRX 2 and 3, which collect the second and third data streams.

Here is an example of 4x4 MIMO:

Figure 4-20

4X4 true MIMO connections

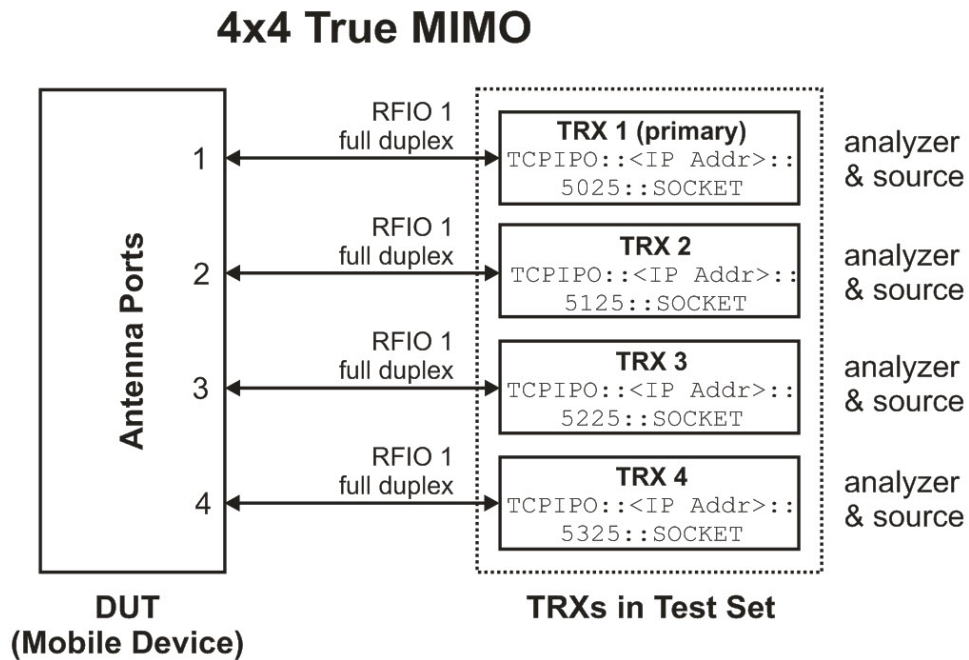

In the example setup shown here, TRX 1 runs the MIMO Modulation Analysis measurement, and is also configured to control TRX 2 to 4, which collect the second, third, and fourth data streams.

Source Settings for MIMO

Unlike measurement settings, which are made only to the primary TRX and applied to the others, source settings can be made separately for each TRX. However, it is possible to make certain source settings to other TRXs by making those settings on the primary TRX. Also, when the measurement is run, the primary TRX communicates with the other TRXs to ensure that they begin playing ARB files simultaneously.

To run the sources synchronously:

1. If there are any source settings which you don't plan to make by way of the primary TRX, begin by making them individually on each TRX which will be used in the MIMO test. Then open the primary TRX.
2. For the MultiTouch Interface: in the **Input/Output > RF Source > Source Sync** menu, click **Sync Config** and set the source synchronization type. (The menu path for the **Traditional** interface is **Source > Source Sync Control > Sync Config**.)
 - For 2x2 MIMO, select **2x2**. Do this for both TRXs. The equivalent SCPI command is:
:SOURce:SYNC:CONFig TWO
 - For 3x3 MIMO, select **3x3**. Do this for all three TRXs. The equivalent SCPI command is:
:SOURce:SYNC:CONFig THRee
 - For 4x4 MIMO, select **4x4**. Do this for all four TRXs. The equivalent SCPI command is:
:SOURce:SYNC:CONFig FOUR
 - For 2x2 + 2x2 MIMO, select **2x2+2x2**. Do this for all four TRXs. The equivalent SCPI command is:
:SOURce:SYNC:CONFig DTWO
 - For 1x1 + 1x1 MIMO, select **1x1+1x1**. Do this for all four TRXs. The equivalent SCPI command is:
:SOURce:SYNC:CONFig DONE
3. In the window for the primary TRX, go to the **Input/Output > RF Source > Source Sync > Sync Settings** window and set **Sync Settings Switch** to the **On** state. (The menu path for the **Traditional** interface is **Source > Source Sync Control > Sync Settings Setup > Sync Settings**.) With this feature enabled, certain settings for the primary TRX source (frequency, amplitude, waveform, trigger source, trigger type, and RF output) are also applied to the other TRX sources. The equivalent SCPI command is:
:SOURce:SYNC:SETT:ENAB ON
4. For 1x1 + 1x1 MIMO or 2x2 + 2x2 MIMO, go to the **Input/Output > RF Source > Source Sync > Sync Settings** window and set **Segment 2 Setup > Sync Segment 2** to the **On** state. (The menu path for the **Traditional** interface is **Source > Source Sync Control > Sync Settings Setup > Segment 2 Setup**.) With this feature enabled, certain non-frequency

settings for the primary TRX source (amplitude, waveform, trigger source, trigger type, and RF output) are also applied to the second of two “2x2 + 2x2” or “1x1 + 1x1” pairs of TRXs. The equivalent SCPI command is:
:SOUR:SYNC:SETT:SEGM2:ENAB ON

5. For 1x1 + 1x1 MIMO or 2x2 + 2x2 MIMO, go to the **Input/Output > RF Source > Source Sync > Sync Settings** window and enter a value for **Segment 2 Setup > Segment 2 Frequency**. (The menu path for the **Traditional** interface is **Source > Source Sync Control > Sync Settings Setup > Segment 2 Setup**.) This makes it possible to apply a frequency setting to the second of two “2x2 + 2x2” or “1x1 + 1x1” pairs of TRXs. This is necessary if the desired frequency is anything other than the default value of 1 GHz. An example of the equivalent SCPI command is:
:SOUR:SYNC:SETT:SEGM2:FREQ 2.00 GHz
6. In the window for the primary TRX, activate synchronization: go to the **Input/Output > RF Source > Source Sync** menu and click **Sync Start**. (The menu path for the **Traditional** interface is **Source > Source Sync Control**.) At this point, the other TRX sources are synchronized to the primary and will play their arb files simultaneously with it. The equivalent SCPI command is:
:SOUR:SYNC:START
You can stop synchronization by clicking **Sync Stop** in the menus described above. The equivalent SCPI command is:
:SOURce:SYNC:STOP

NOTE

When **Sync Settings** is enabled, the naming of waveform files used by the sources must be coordinated; see [“Constraints on Waveform File Names” on page 126](#).

Constraints on Waveform File Names

When **Sync Settings** is enabled, as described in the previous procedure, it is necessary to follow a convention for naming the waveform files used by the TRXs, so that the file associated with each TRX is distinguished by a TRX-specific suffix. The table below lists the suffixes for each MIMO configuration. Note that the convention for the 4X4 configuration is not the same as the convention for a pair of 2X2 configurations.

MIMO Configuration	TRX Numbers	Equivalent Waveform File Names (".xxx" can be .wfm, .bin, or .seq)
2x2	TRX 1 or TRX3 TRX 2 or TRX4	<name>0.xxx <name>1.xxx
3x3	TRX 1 TRX 2 TRX 3	<name>0.xxx <name>1.xxx <name>2.xxx
4x4	TRX 1 TRX 2 TRX 3 TRX 4	<name>0.xxx <name>1.xxx <name>2.xxx <name>3.xxx
2x2 + 2x2	TRX 1 TRX 2 TRX 3 TRX 4	<name>0_0.xxx <name>0_1.xxx <name>1_0.xxx <name>1_1.xxx
1x1 + 1x1	TRX1 or TRX3 TRX2 or TRX4	<name>0_0.xxx <name>1_0.xxx

Constraints on TRX Selection

Not every TRX can be designated the primary for purposes of MIMO testing. The permitted configurations are:

MIMO Configuration	Primary TRX	Secondary TRXs
2x2	TRX 1	TRX 2, Socket 5125
2x2 (alternative setup)	TRX 3	TRX 4, Socket 5325
3x3	TRX 1	TRX 2, Socket 5125 TRX 3, Socket 5225
4x4	TRX 1	TRX 2, Socket 5125 TRX 3, Socket 5225 TRX 4, Socket 5325

Constraints on Radio Standards

Only certain radio standards support MIMO. Under **Mode Setup > Radio Std**, select **802.11n** or **802.11ac**.

MIMO Type

For the MIMO Modulation Analysis measurement, go to the **Meas Setup > MIMO Type** menu and select **2x2**, **3x3**, or **4x4**. (This setting determines whether the display shows two, three, or four constellation diagrams for the measurement.) The equivalent SCPI command is:

```
[ :SENSe ]:EVMMimo:TYPe M2M2|M3M3|M4M4
```

Remote Analyzer Configuration (MultiTouch Interface)

This feature is used to coordinate TRXs within the test set; it is named this way because its original purpose was to coordinate the test set with external equipment.

NOTE

The MIMO configuration that is set up here needs to match the **MIMO Type** selection, as described above. Error messages will be displayed until the two are in agreement.

1. From the primary TRX window (TRX 1 in this example), in **WLAN** mode, **MIMO Modulation Analysis** measurement, select **Meas Setup > Global > Remote Analyzer Config**.
2. A table is displayed which includes any TRX which you have previously used (unless you have deleted it) and any added by means of the **Add Analyzer** key. However, the list may be blank, or may not include the desired TRX.
3. To add a TRX to the list, click **Add Analyzer**.
4. Click **IP** and use the popup window to enter an IP address for the test set. In this example, the test set's localhost address is used (for the EXM test set, the localhost address has a fixed value of 127.0.0.1).
5. Click **SCPI Socket Port** and use the popup window to enter the socket number of the secondary TRX. In this example socket number 5125 (TRX 2) is used.
6. Highlight the secondary TRX in the table and press **Verify Highlighted Analyzer**. (A message confirming that the analyzer has been verified successfully will appear, if everything is configured correctly.)
7. Highlight the secondary TRX in the table and press **Select Highlighted Analyzer**. The secondary TRX is now being run from the present TRX. The window for the secondary TRX displays a message stating that a remote computer or instrument is in control of the local hardware. If you need to release it from control, go to the primary TRX and select **Release**.

Highlighted Analyzer from the **Remote Analyzer Config** window, or send to the primary the equivalent SCPI command:

:SYST:COMM:ANAL:REL

8. The equivalent SCPI command for the steps described above is as follows (modify the address string "127.0.0.1:5125" as needed):

:SYST:COMM:ANAL:SEL "127.0.0.1:5125"

Figure 4-21

IP and socket port addresses (MultiTouch interface)

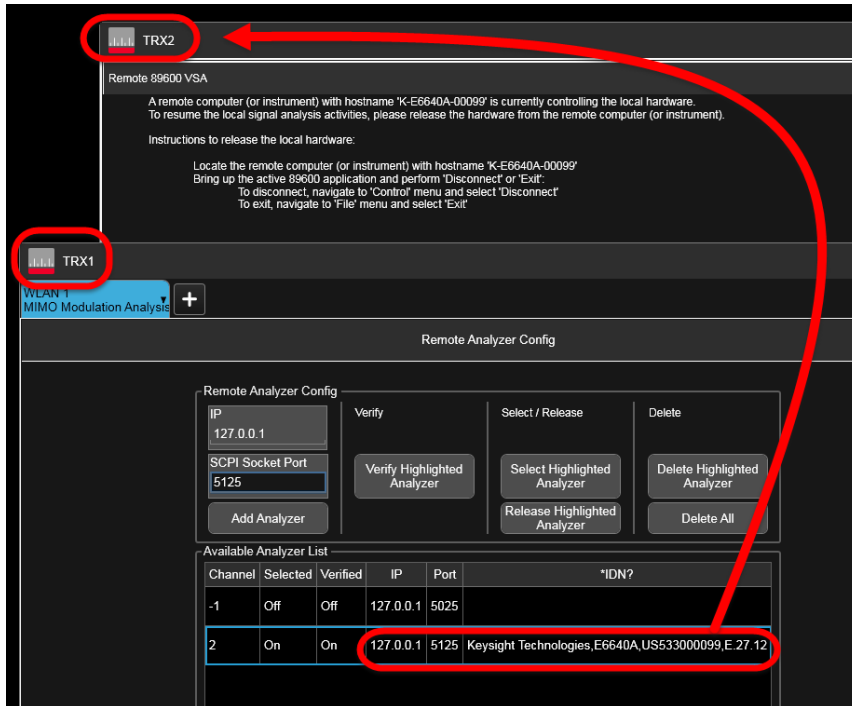

The command equivalent for 3x3 MIMO would be:

:SYST:COMM:ANAL:SEL "127.0.0.1:5125"

:SYST:COMM:ANAL:SEL "127.0.0.1:5225"

The command equivalent for 4x4 MIMO would be:

:SYST:COMM:ANAL:SEL "127.0.0.1:5125"

:SYST:COMM:ANAL:SEL "127.0.0.1:5225"

:SYST:COMM:ANAL:SEL "127.0.0.1:5325"

The procedure given above is for 2x2 MIMO; the process is the same for 3x3 or 4x4 MIMO, except that more TRXs are added.

Remote Analyzer Configuration (Traditional Interface)

1. From the primary TRX window (TRX 1 in this example), select **Mode Setup > Global Settings > Remote Analyzer Config**.
2. A list is displayed which includes any TRX which you have previously used (unless you have deleted it) and any added while in the **Add Analyzer to List** menu. However, the list may be blank, or may not include the desired TRX.
3. To add a TRX to the list, press **Add Analyzer to List**.
4. Click **IP Address**, use the numeric keys to enter an IP address for the test set, and press **Enter**. In this example, the test set's localhost address is used (for the EXM test set, the localhost address has a fixed value of 127.0.0.1).
5. Click **SCPI Socket Port**, use the numeric keys to enter the socket number of the secondary TRX, and press **Enter**. In this example socket number 5125 (TRX 2) is used.
6. Press **Add**. The secondary TRX is now displayed in the list.
7. Select the desired TRX from the displayed list (use the up and down arrow keys to move the highlighted selection to the desired TRX and then press **Select Highlighted Analyzer**).
8. The secondary TRX is now being run from the present TRX. The window for the secondary TRX displays a "This instrument is in use..." message. If you need to release it from control, go to the primary TRX and select **Remote Analyzer Config > Release Current Analyzer**, or send to the primary the equivalent SCPI command:
:SYST:COMM:ANAL:REL
9. The equivalent SCPI command for the steps described above is as follows (modify the address string "127.0.0.1:5125" as needed):
:SYST:COMM:ANAL:SEL "127.0.0.1:5125"

Figure 4-22 IP and socket port addresses (traditional interface)

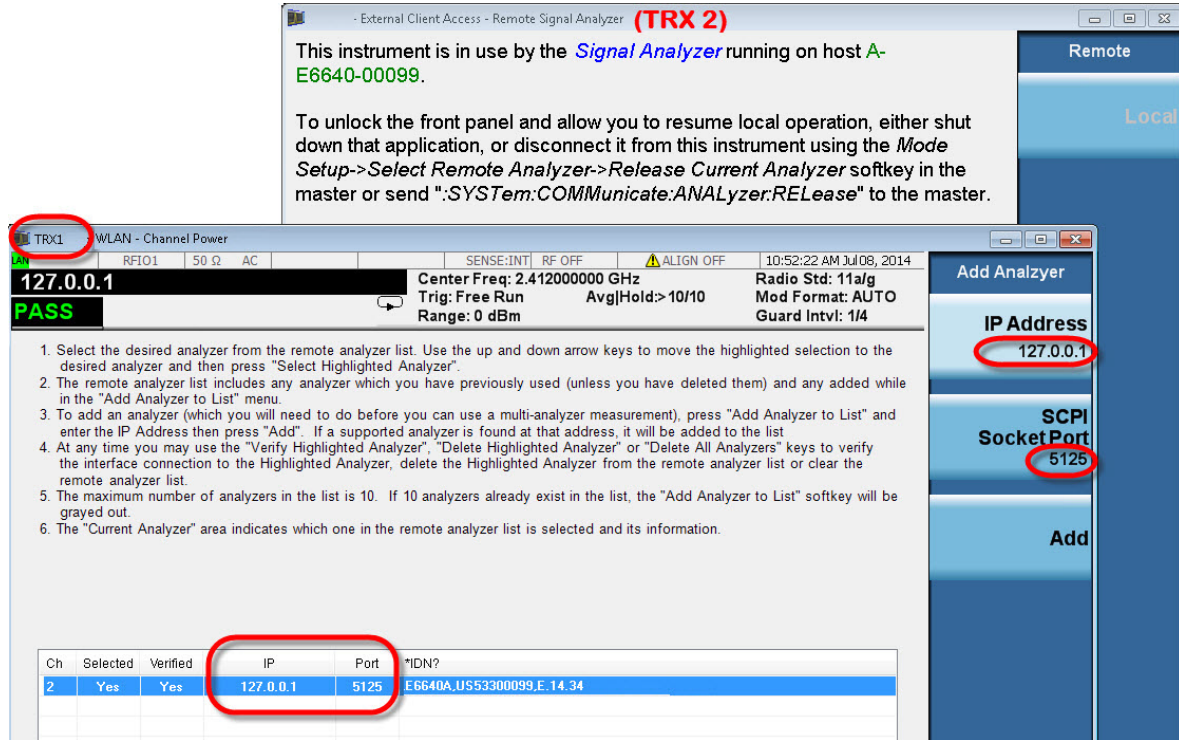

The procedure given above is for 2x2 MIMO; the process is the same for 3x3 or 4x4 MIMO, except that more TRXs are added.

The command equivalent for 3x3 MIMO would be:
`:SYST:COMM:ANAL:SEL "127.0.0.1:5125"`
`:SYST:COMM:ANAL:SEL "127.0.0.1:5225"`

The command equivalent for 4x4 MIMO would be:
`:SYST:COMM:ANAL:SEL "127.0.0.1:5125"`
`:SYST:COMM:ANAL:SEL "127.0.0.1:5225"`
`:SYST:COMM:ANAL:SEL "127.0.0.1:5325"`

MIMO Modulation Analysis measurement SCPI commands

The following commands are used to set up the MIMO Modulation Analysis measurement.

Command	Description	Notes
<code>[:SENSe]:EVMMimo:MTYPE DMAP FOURier</code>	Matrix Type	Sets the type as DMAP or Fourier
<code>[:SENSe]:EVMMimo:TYPE M2M2 M3M3 M4M4</code>	MIMO Type	Sets the type as 2x2, 3x3, or 4x4
<code>[:SENSe]:EVMMimo:RESult:STReam <integer></code>	MIMO Result Stream Index	Specifies the result stream by number.
<code>[:SENSe]:EVMMimo:RESult:CHANnel <integer></code>	MIMO Result Channel Index	Specifies the result channel by number.

MIMO Modulation Analysis Results

The results available for a WLAN MIMO Modulation Analysis measurement are as follows (the results for Stream 3 are returned as -1.0 (not tested) in the case of 2x2 MIMO):

Index	Result Parameter
0	<p>Returns unprocessed I/Q trace data of Capture Interval, as a series of trace point values for Channel m. Channel index m can be set and queried through EVMM:RESult:CHAN command.</p> <p>The I values are listed first in each pair, using the 0 through even-indexed values. The Q values are the odd-indexed values.</p>
1	<p>Returns the comma-separated EVM results by stream. The EVM scalar results for each stream are in the following order:</p> <ol style="list-style-type: none"> 1. RMS EVM Max (dB) 2. RMS EVM Avg (dB) 3. Peak EVM Max (dB) 4. Peak EVM Avg (dB) 5. Pilot EVM Max (dB) 6. Pilot EVM Avg (dB) 7. Data EVM Max (dB) 8. Data EVM Avg (dB) 9. CPE EVM Max (dB) 10. CPE EVM Avg (dB) <p>When MIMO Type is 2x2, this result gives stream 1 EVM scalar results first, then stream 2 EVM scalar results. When MIMO Type is 3x3, stream 1, 2 and 3 EVM scalar results are provided in order. When MIMO Type is 4x4, returns 40 comma-separated EVM scalar results, provided in stream order.</p>
2	<p>Returns a value of the pass/fail (0.0 = passed, or 1.0 = failed) results determined by testing the result of RMS EVM. Only when all the stream RMS EVM Average results are passed, will this value be passed.</p>
3	<p>Returns series of floating point numbers that alternately represent I and Q pairs of the corrected measured trace for STRM m. Stream index m can be set and queried through EVMM:RESult:STReam command.</p> <p>The magnitude of each I and Q pair are normalized to 1.0, when the IQ Normalize is turned on. The first number is the in-phase (I) sample and the second is the quadrature-phase (Q) sample.</p>
4	<p>Returns series of floating point numbers (in dB) that represent each sample in the Stream EVM vs. Carrier trace of Capture Interval for STRM m. Stream index m can be set and queried through EVMM:RESult:STReam command.</p>
5	<p>Returns series of floating point numbers (in dB) that represent each sample in the Stream EVM vs. Symbol trace of Capture Interval for STRM m. The first number is the symbol 0 decision point. Stream index m can be set and queried through EVMM:RESult:STReam command.</p>

Index	Result Parameter
6	Returns series of floating point numbers that represent each sample in the Channel Response for STRM m CH k. Stream index m can be set and queried through EVMM:RESult:STReam command. Channel index k can be set and queried through EVMM:RESult:CHAN command.
7	<p>Returns comma-separated EVM scalar results by channel. The EVM scalar results for each channel are in the following order:</p> <ol style="list-style-type: none"> 1. RMS EVM Max (dB) 2. RMS EVM Avg (dB) 3. Peak EVM Max (dB) 4. Peak EVM Avg (dB) 5. Pilot EVM Max (dB) 6. Pilot EVM Avg (dB) 7. Data EVM Max (dB) 8. Data EVM Avg (dB) 9. Freq Error Max (Hz) 10. Freq Error Avg (Hz) 11. Freq Error Ppm Max (ppm) 12. Freq Error Ppm Avg (ppm) 13. Sym Clock Error Max (ppm) 14. Sym Click Error Avg (ppm) 15. IQ Gain Imb Max (dB) 16. IQ Gain Imb Avg (dB) 17. IQ Offset Max (dB) 18. IQ Offset Avg (dB) 19. IQ Quad Error Max (degree) 20. IQ Quad Error Avg (degree) 21. IQ Timing Skew Max (s) 22. IQ Timing Skew Avg (s) 23. Cross Pwr Max (dB) 24. Cross Pwr Avg (db) 25. Sync Corr Max 26. Sync Corr Avg 27. Avg Burst Power Max (dBm) 28. Avg Burst Power Avg (dBm) 29. Peak Burst Power Max (dBm) 30. Peak Burst Power Avg (dBm) <p>When MIMO Type is 2x2, 60 comma-separated scalar results are returned; When MIMO Type is 3x3, 90 comma-separated scalar results are returned; When MIMO Type is 4x4, 120 comma-separated scalar results are returned.</p>
8	Return the Channel Matrix results.
9	Return the decode bits of HT-SIG Signal.
10	Returns series of floating point numbers (in dB) that represent each sample in the Equalizer Impulse Response for STRM m CH k. Stream index m can be set and queried through EVMM:RESult:STReam command. Channel index k can be set and queried through EVMM:RESult:CHAN command.

OperatingTasks: System-Level Tasks
MIMO Modulation Analysis Results

Index	Result Parameter
11	Returns comma-separated floating point numbers of spectral flatness trace for STRM m CH k. Stream index m can be set and queried through EVMM:RESult:STReam command. Channel index k can be set and queried through EVMM:RESult:CHAN command.
12	Returns Data Rate (in Mbps) for MIMO input signals.
13	Returns the FFT SEM trace consisting of 5001 points if SEM is activated for Ch k. Chan index k can be set and queried through through EVMM:RESult:CHAN command.
14	Returns the SEM failed information consisting of (2(DeltaFreq,DeltaAmplitude) x 6(OffsetA Lower, OffsetA Upper, OffsetB Lower, OffsetB Upper, Offset C Lower, Offset C Upper)=12 values in upper and lower bands of three offsets for Ch k. Chan index k can be set and queried through through EVMM:RESult:CHAN command.

NOTE

When MIMO Type is 2X2 and Radio Standard is 80+80 MHz, all these measurement results are only for one segment. Use SCPI command EVMM:RESult:SEGment to specify that these contents are the first segment results or the second segment results.

Tx Beam Forming

If license V9077B-KFP is installed, Tx Beam-Forming results are available from the Modulation Analysis measurement in WLAN mode.

Tx Beam Forming Commands

Two commands are added for Tx Beam Forming, as described in the table below. The first command sets up the measurement's EVM demodulation algorithm to provide EVM results or Tx Beam Forming Results. The second command is used to specify the channel count of the measured MIMO signal.

Command	Description
<code>[:SENSe] :EVM:BFORming:MTYPE EVM TXBFca1</code>	<p>This command is only available when license V9077B-KFP is installed; otherwise, “-113, Undefined Header” error will be reported.</p> <p>This parameter takes effect when the Radio Std is 802.11n(20MHz), 802.11n (40MHz), 802.11ac (20MHz), 802.11ac (40MHz), 802.11ac (80MHz) and 802.11ac (160MHz)</p> <p>When EVM is selected, the result index 1~20 are calculated with meaningful values for EVM measurement, and result 21 and 22 results are -999.0;</p> <p>When TXBFca1 is selected, the result index 1~20 values will not be calculated; Instead, result 21 and 22 are calculated and returned</p>
<code>[:SENSe] :EVM:ACCHannel <integer> <real></code>	<p>For Radio Std 802.11n (20MHz) and 802.11n (40MHz), Tx Beam Forming with channel count <=4 is supported;</p> <p>For Radio Std 802.11ac (20MHz), 802.11ac (40MHz), 802.11ac (80MHz), and 802.11ac (160MHz), Tx Beam Forming with channel count <=8 is supported</p>

Tx Beam Forming Results

The Tx Beam Forming results are added to the Modulation Analysis measurement results as Index 21 and Index 22, as described in the table below.

Index	Result Parameter
21	<p>Tx Beam Forming Calibrated Angle Error returns a series of floating point numbers (in rad) that represent the calibrated angle error vectors on channels, when</p> <ul style="list-style-type: none">- Radio Std is 802.11n (20 MHz), or 802.11n (40 MHz), and MIMO Tx Channel Count ≤ 4- Radio Std is 802.11ac(20MHz), 802.11ac(40MHz), 802.11ac(80MHz), or 802.11ac(160MHz), and MIMO Tx Channel Count ≤ 8- MIMO Usage Type is TXBForming (available when license V9077B-KFP is installed) <p>Otherwise, returns -999.0.</p> <p>The first channel angle vector is used as reference; the angle error vectors are listed in order of channels. For the 20MHz BW signals, each channel's angle error vector contains 64 values; For the 40MHz BW signals, each channels angle error vector contains 128 values; For the 80MHz BW signals, each channels angle error vector contains 256 values, For 160MHz BW signals, each channels angle error vector contains 512 values.</p>
22	<p>Tx Beam Forming Gain returns gain after the calibrated angle error vector are compensated for the MIMO input signal, when</p> <ul style="list-style-type: none">- Radio Std is 802.11n (20 MHz), or 802.11n (40 MHz), and MIMO Tx Channel Count ≤ 4- Radio Std is 802.11ac(20MHz), 802.11ac(40MHz), 802.11ac(80MHz), or 802.11ac(160MHz), and MIMO Tx Channel Count ≤ 8- MIMO Usage Type is TXBForming (available when license V9077B-KFP is installed) <p>Otherwise, returns -999.0.</p>

E6640A Calibration Status

The E6640A EXM test set does not have a calibration certificate, because of its flexibility in configuration:

- The E6640A chassis can have 1, 2, 3, or 4 TRXs (M943xA) installed.
- Different TRXs can have different hardware configurations for frequency range and/or bandwidth.
- Additional TRXs can be added to an E6640A chassis after the initial instrument purchase. These would have different calibration due dates, and different warranty end dates, from the modules that were originally purchased with the E6640A.

There isn't a single instrument-level calibration (or calibration due-date) that covers the E6640A as a whole and all of the TRX modules (and the Reference module) within it. Each module is calibrated independently, and not necessarily at the same time that the others in the test set are calibrated.

The only way to track the calibration status of the E6640A is to track the calibration status of the reference module, and each TRX module, within it. The serial number of a particular module can be found from its XSA window, by selecting **System Settings > System > Show Hardware**. The serial number is listed in the row which shows "Reference" or "M943x TRX" under Assembly Name. The same row also shows the Cal Date for the relevant module.

The same information is available (in a different visual format) in the traditional interface (the menu path in that case is **System > Show > Hardware**).

Figure 4-23 Checking calibration status (MultiTouch interface)

System		Hardware Information						
Keysight EXM	Keysight EXM Wireless Test Set							
Product Number	E6640A							
Serial Number	US533000099							
S/W Release Name	2020 Update 1							
Instrument S/W Revision	E.27.12							
Revision Date	2/25/2021 10:34:06 AM							
Assembly Name	Part #	Serial #	Matl Rev	Rev	OF Rev	Hw Id	Misc	
PXIe Controller	M9037A			0		174		
Reference	M9300A	MY53000138				0165	2020.05.13	
Reference Carrier	M9300A	W1312-63261-23-1315-00397		2	1.2.1	0166		
Reference Plugin	M9300A	W1312-63386-30-1306-00024		01	1.3.0	0167		
Chassis	M9018A	TW52420102		0		171		
Wideband Digitizer	M943063074	79163200118	A0	3	A	138		
Downconverter	M943063075	79163400704	A0	3	A	139		
RFIO	M943063009	79162201260	003	2	A	140		
Power Supply	M943063002	79163500004	004	0	A	141		
M9432A TRX R2	9163506940	MY55130254	0	0	0	142	2020.10.09	
Baseband Generator	M943063076	79162602060	A0	3	A	136		
ModulatorSrcOutput	M943063077	79163300463	A0	3	A	137		

The same hardware information is also returned by the SCPI command:
SYST:CONF:HARD?

Certificates of Calibration

Customers receive 2 to 5 Certificates of Calibration (CoCs) with the E6640A EXM test set. The EXM is a scalable test set and can be purchased with 1 to 4 TRX modules. The TRX modules, along with the Reference module (supplied with each E6640A), are the only items that require calibration, and therefore they are the only items supplied with a CoC and calibration sticker at shipment.

Each E6640A test set is shipped with a yellow envelope which contains your calibration certificates; this envelope is labeled (lower right corner) with a sticker identifying the unit model number (E6640A) and serial number. Inside each envelope will be from two to five CoCs: one for the reference module, and one for each of the TRX modules installed in the test set. This package constitutes your test set's calibration data.

Figure 4-24 Certificates of calibration

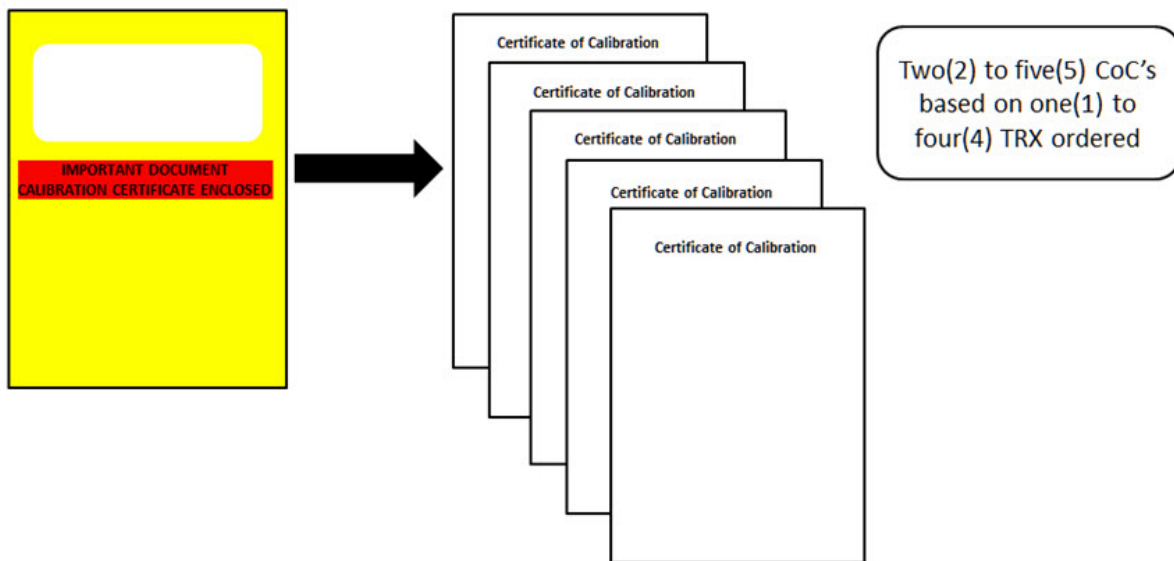

You may choose to physically attach calibration stickers to your E6640A test set (recommended), or, as many customers do, you may choose to use the modules' electronic calibration information to identify the calibration status of any module at any time. The use of electronic calibration information is of benefit to those customers that may want to move modules from one instrument to another: the calibration date always follows the module.

To summarize: calibration of the E6640A is not done at the instrument level, but an E6640A is fully calibrated when all of the modules (Reference module and TRX modules) are calibrated. At initial shipment, this information is provided in the yellow envelope supplied with each unit.

Alignments (MultiTouch Interface)

Alignments are internal calibration adjustments which each TRX module must make to ensure that internal signal levels are properly maintained. To avoid interruptions, the alignments are not run automatically, either at startup or afterward; you must run them explicitly. (See also: “**Alignments (Traditional Interface)**” on page 142).

The **System Settings > Alignments > Align Now** menu is illustrated below.

Figure 4-25 Alignments > Align Now menu

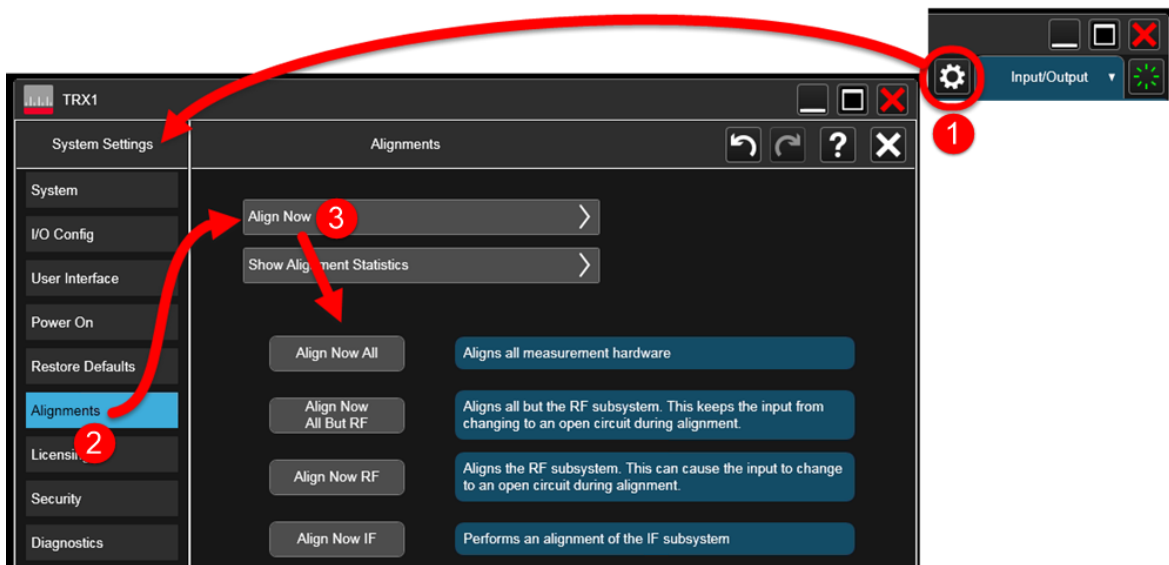

“All” Alignment (daily use)

This alignment of the source and analyzer in the TRX is sufficient to maintain specified performance, provided that (1) the TRX’s internal temperature has not drifted more than 5 degrees C since the previous alignment, (2) no more than 8 hours have elapsed since the previous “All” alignment, and (3) no more than 1 week has elapsed since the previous weekly alignment (see below). The “All” alignment typically takes less than 5 minutes to run.

The TRX’s internal temperature can be checked by sending the SCPI query `:CAL:TEMP:CURR?`

To run the alignment, select **System Settings > Alignments > Align Now > Align Now All**, or send the SCPI command `:CAL:ALL`.

NOTE

The alignment process requires a 45-minute preliminary warm-up period, after applying power or after restarting the XSA application (when the application is not running, power is not applied to the TRXs; therefore an application shutdown has the same effect on alignment as a power shutdown).

Weekly alignment procedure

A more thorough alignment of the source and analyzer in the TRX is required on a weekly basis. This procedure is similar to the “All” alignment described above, but it also performs additional alignment functions related to slow-drifting parameters which do not change significantly over time periods shorter than a week. This alignment procedure should be run whenever the TRX’s internal temperature has drifted more than 5° C since the previous “All” alignment (see **“Alignment statistics” on page 141**), or whenever more than 7 days have elapsed since the previous weekly alignment.

Perform the alignment procedure as follows:

1. Select **System Settings > Alignments > Align Now > Align All But RF**, or send the SCPI commands:
:CAL:NRF
*WAI
2. Select **System Settings > Alignments > Align Now > Align Source**, or send the SCPI commands:
:CAL:SOUR
*WAI
3. Select **System Settings > Alignments > Align Now > Align Now IF**, or send the SCPI commands:
:CAL:IF
*WAI

NOTE

This alignment process also requires the same 45-minute preliminary warm-up period described under **“All” Alignment (daily use)” on page 142**.

Alignment statistics

The TRX's internal temperature and the time since the most recent alignment can be checked by selecting **System Settings > Alignments > Show Alignment Statistics**, as illustrated below.

Figure 4-26

Show Alignment Statistics

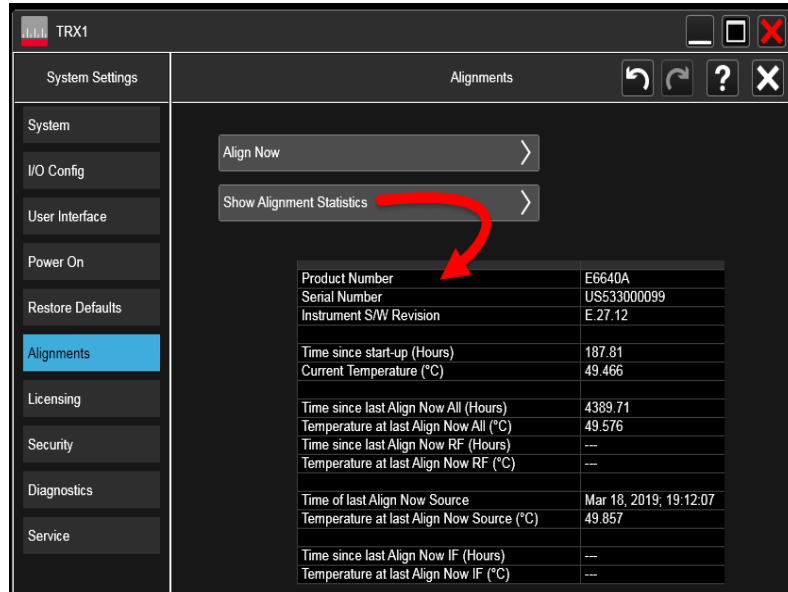

Alignments (Traditional Interface)

Alignments are internal calibration adjustments which each TRX module must make to ensure that internal signal levels are properly maintained. To avoid interruptions, the alignments are not run automatically, either at startup or afterward; you must run them explicitly. (See also: **“Alignments (MultiTouch Interface)” on page 139**).

“All” Alignment (daily use)

This alignment of the source and analyzer in the TRX is sufficient to maintain specified performance, provided that (1) the TRX’s internal temperature has not drifted more than 5 degrees C since the previous alignment, (2) no more than 8 hours have elapsed since the previous “All” alignment, and (3) no more than 1 week has elapsed since the previous weekly alignment (see below). The “All” alignment typically takes less than 5 minutes to run.

The TRX’s internal temperature can be checked by sending the SCPI query **:CAL:TEMP:CURR?**

To run the alignment, select **System > Alignments > Align Now > All**, or send the SCPI command **:CAL:ALL**.

NOTE

The alignment process requires a 45-minute preliminary warm-up period, after applying power or after restarting the XSA application (when the application is not running, power is not applied to the TRXs; therefore an application shutdown has the same effect on alignment as a power shutdown).

Weekly alignment procedure

A more thorough alignment of the source and analyzer in the TRX is required on a weekly basis. This procedure is similar to the “All” alignment described above, but it also performs additional alignment functions related to slow-drifting parameters which do not change significantly over time periods shorter than a week.

1. Select **System > Alignments > Align Now > IF**, or send the SCPI commands:
:CAL:IF
*WAI
2. Select **System > Alignments > Align Now > RF**, or send the SCPI commands:
:CAL:RF
*WAI
3. Select **System > Alignments > Align Now > Source**, or send the SCPI commands:
:CAL:SOUR
*WAI

Figure 4-27

Alignment menus

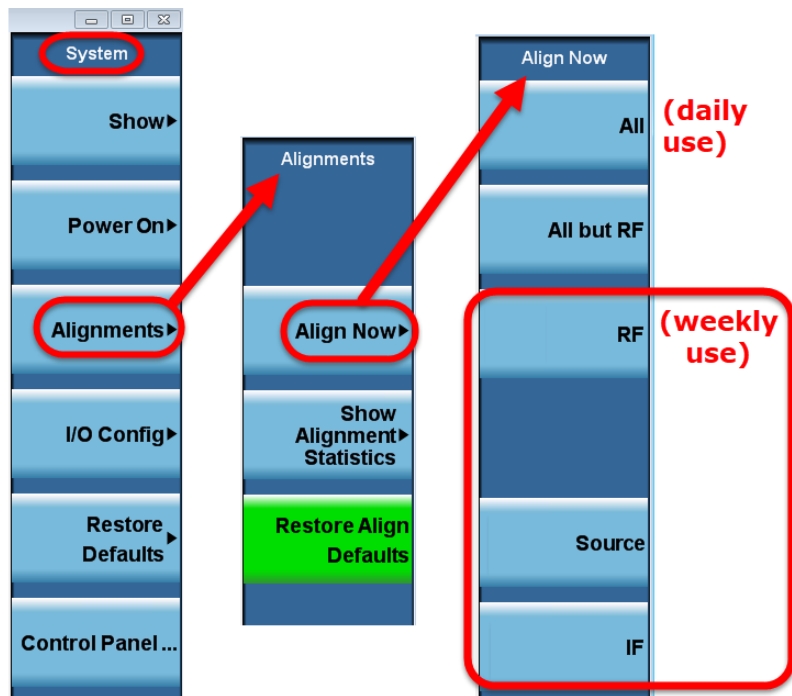

NOTE

This alignment process also requires the same 45-minute preliminary warm-up period described under ““All” Alignment (daily use)” on page 142.

Alignment statistics

The TRX's internal temperature and the time since the most recent alignment can be checked by selecting **System > Alignments > Show Alignment Statistics**, as illustrated below.

Figure 4-28

Show Alignment Statistics

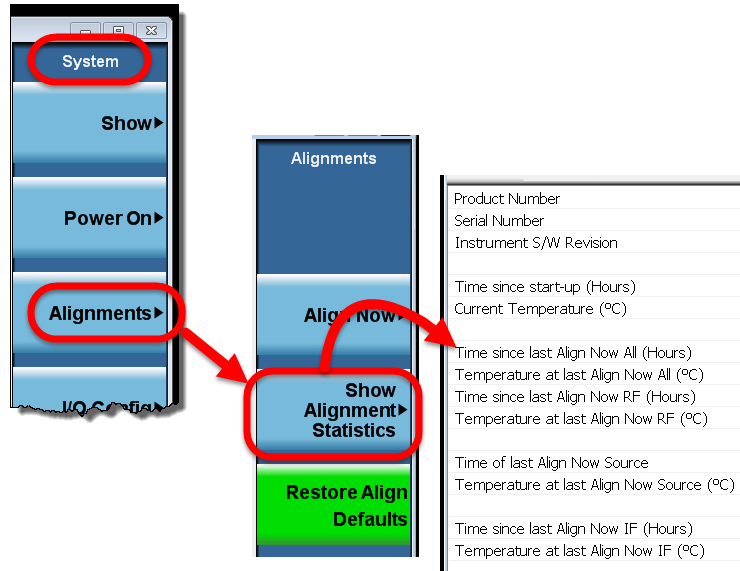

LAN Address Configuration

The E6640A supports both dynamic and static assignment of its IP address, using ports LAN 1 and LAN 2 respectively.

The LAN 1 port is designed for dynamic IP addressing, using the Dynamic Host Configuration Protocol. If your site network supports DHCP, the E6640A will be assigned an IP address automatically when it is connected to the LAN. Once the address is assigned, it is listed, along with the computer name, under **System Settings [Gear Icon] > System > Show System**. The address or computer name can be used to find the test set on the LAN. However, to see the **Show System** screen and find this information, it is necessary either to connect a monitor to the front panel monitor port, or else to use the LAN 2 port to connect test set to a PC directly.

The same information is available (in a different visual format) in the traditional interface (the menu path in that case is **System > Show > System**).

Figure 4-29 Checking the LAN address

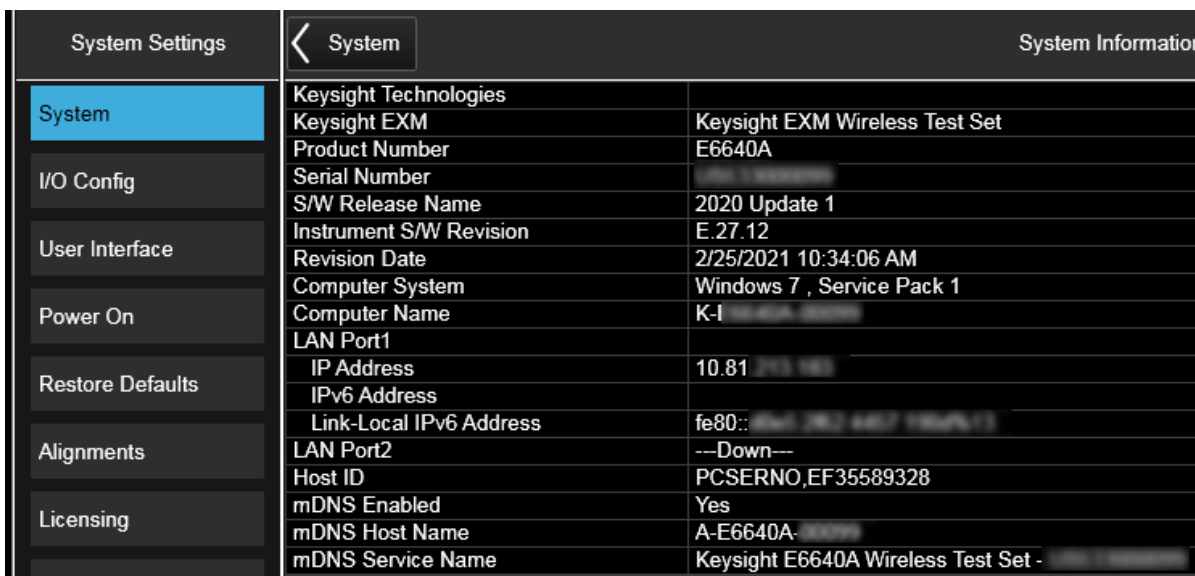

System Settings	< System	System Information
System	Keysight Technologies	
	Keysight EXM	Keysight EXM Wireless Test Set
	Product Number	E6640A
I/O Config	Serial Number	
	S/W Release Name	2020 Update 1
User Interface	Instrument S/W Revision	E.27.12
	Revision Date	2/25/2021 10:34:06 AM
	Computer System	Windows 7 , Service Pack 1
Power On	Computer Name	K-I
	LAN Port1	
	IP Address	10.81
Restore Defaults	IPv6 Address	
	Link-Local IPv6 Address	fe80::
Alignments	LAN Port2	--Down--
	Host ID	PCSERNO_EF35589328
Licensing	mDNS Enabled	Yes
	mDNS Host Name	A-E6640A-
	mDNS Service Name	Keysight E6640A Wireless Test Set -

NOTE

The menu path using the old interface is:
System > Show > System.

Using the LAN 1 port to connect the test set directly to the public LAN is potentially insecure, because the test set does not provide anti-virus protection. Connecting the test set to the public LAN by way of a PC with antivirus protection is the preferred solution.

The LAN 2 port is designed to use a private static IP address, 192.168.1.2 (changing this address is possible but not recommended). This port can be used for direct connection to a PC.

OperatingTasks: System-Level Tasks
LAN Address Configuration

To find the test set on the LAN, you will need to know its IP address or computer name. If you cannot easily obtain a monitor view of **System > Show > System**, you can determine the computer name using the instrument serial number. The computer name is in the format **K-E6640A-nnnnn**, ending in the last five digits of the serial number.

Managing Licenses

Licenses can be tied to a particular instrument, or transferable from one instrument to another by various means.

Licenses can be either time-based or perpetual (the latter have no expiration date).

To verify which licenses are installed, open the Keysight License Manager from the Windows **Start** menu. (In the MultiTouch interface, it can also be opened by clicking the "gear" icon at the upper left to open the **System Settings** screen, and clicking **Licensing > License Manager**.) The licenses installed on the test set are listed, with information provided about license types and expiration dates (in the illustrated example, "Fixed" indicates a node-locked license).

Figure 4-30 Installed licenses (as displayed in Keysight License Manager)

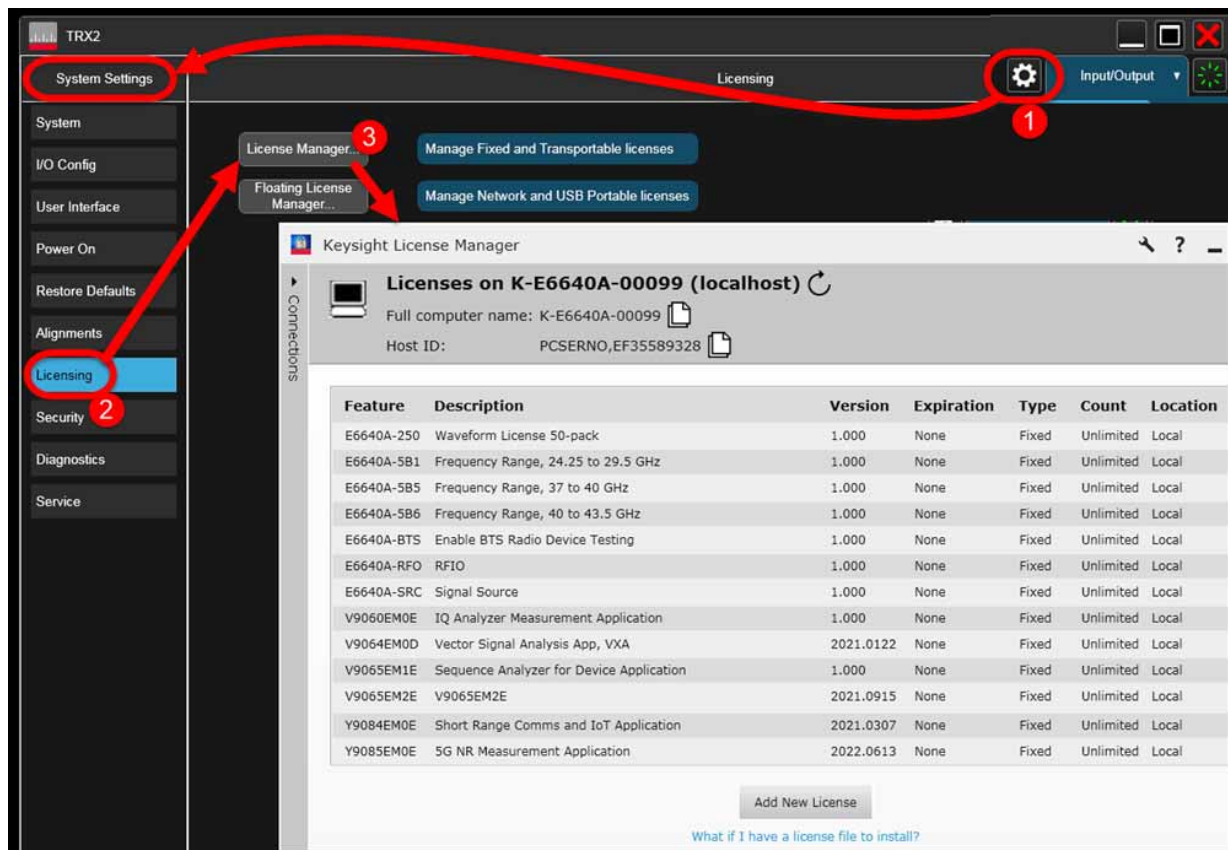

Flexible Software Licensing

Keysight offers a variety of flexible licensing options to fit your needs and budget. You have two or more options to choose from for the license term, license type, and KeysightCare software support subscription.

License Terms

- *Perpetual:*
License can be used indefinitely.
- *Time-based:*
License can be used through the term of the license only (6, 12, 24, or 36 months).

License Types

- *Node-locked:*
License can be used on one specified instrument/computer.
- *Transportable:*
License can be used on one instrument/computer at a time but may be transferred to another using Keysight Software Manager (internet connection required).
- *USB Portable:*
License can be used on one instrument/computer at a time but may be transferred to another using a certified USB dongle (available for additional purchase with Keysight part number E8900-D10).
- *Floating (single site):*
Networked instruments/computers can access a license from a server one at a time. Multiple licenses can be purchased for concurrent usage.

KeysightCare Software Support Subscriptions

- Perpetual licenses are sold with a 12 (default), 24, 36, or 60-month software support subscription. Support subscriptions can be renewed for a fee after that.
- Time-based licenses include a software support subscription through the term of the license.

See also: [“Licensing New Measurement Application Software - After Initial Purchase” on page 68](#) and [“Transporting a License Between Test Sets” on page 70](#).

For More information

On licensing in general:

www.keysight.com/find/licensing

On upgrading software:

www.keysight.com/find/upgrade_to_software_support

5 Operating Tasks: Receiver Setup

The following topics can be found in this section:

[“Measurement Setup \(MultiTouch Interface\)” on page 150](#)

[“Measurement Setup \(Traditional Interface\)” on page 154](#)

[“Marker Setup \(MultiTouch Interface\)” on page 157](#)

[“Marker Setup \(Traditional Interface\)” on page 159](#)

Measurement Setup (MultiTouch Interface)

The analyzer/receiver function of the E6640A relates to measurement of signals received from the DUT.

Clicking on the measurement tab at the upper left corner of the display opens the **Mode/Measurement/View Selector**, which you can use to select a particular kind of measurement. In this example, **WLAN** has been selected under **Mode**, and the selections under **Measurement** are the measurements available in that mode. (For some measurements, there are also selections to be made under **View**.) In the example illustrated below, the **Channel Power** measurement is selected. Click **OK** to run this mode/measurement selection.

Figure 5-1 Selecting Mode/Measurement

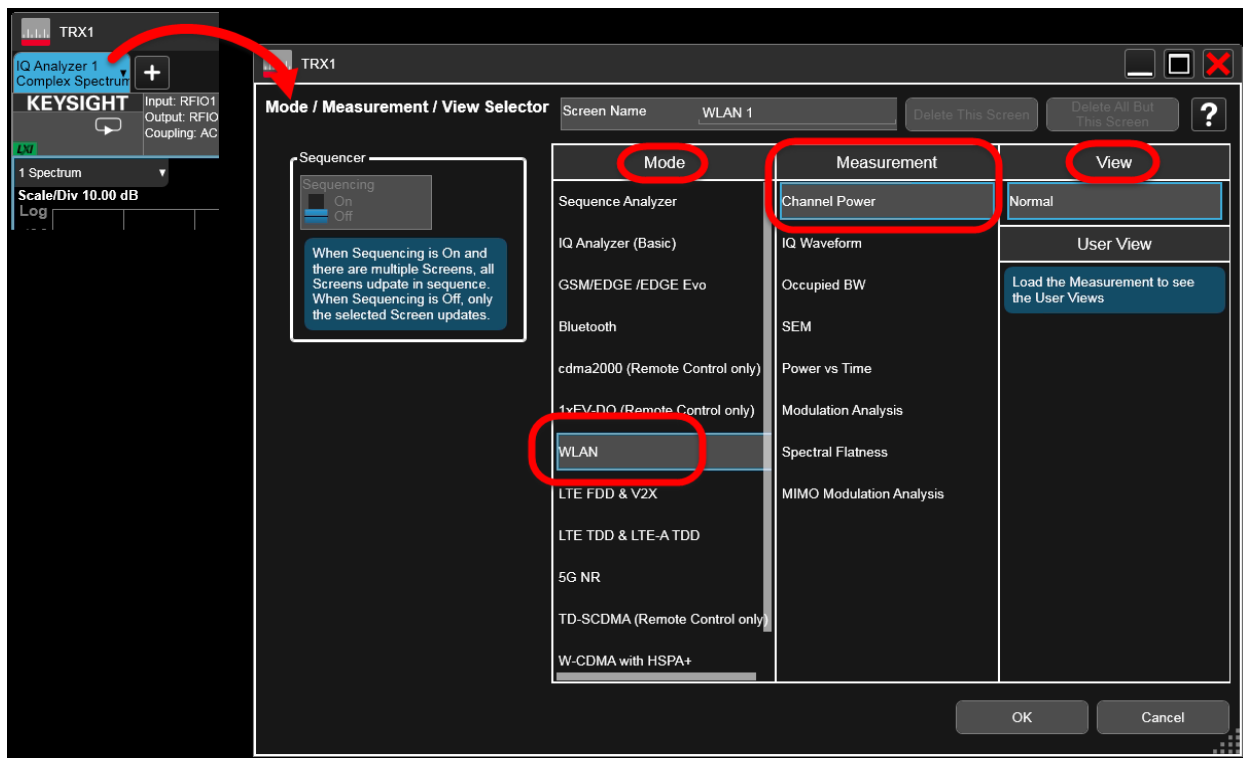

Most measurement settings are made from the menus, which can be accessed by selecting the dropdown button near the upper right of the display.

Figure 5-2 Accessing Menus

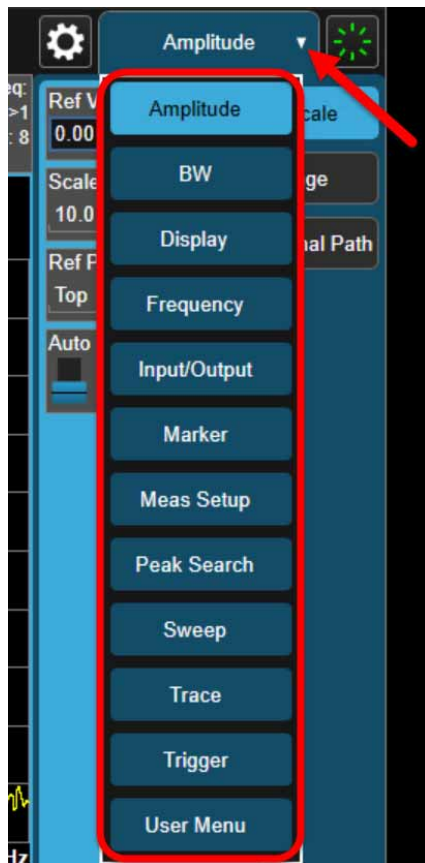

Selecting a menu from the dropdown list displays the menu selections (usually the selections are indented under multiple tabs shown at the right).

For example, the **Amplitude** menu has three tabs; the selections under the **Y Scale** and **Range** tabs are shown below.

Figure 5-3 Measurement Menus

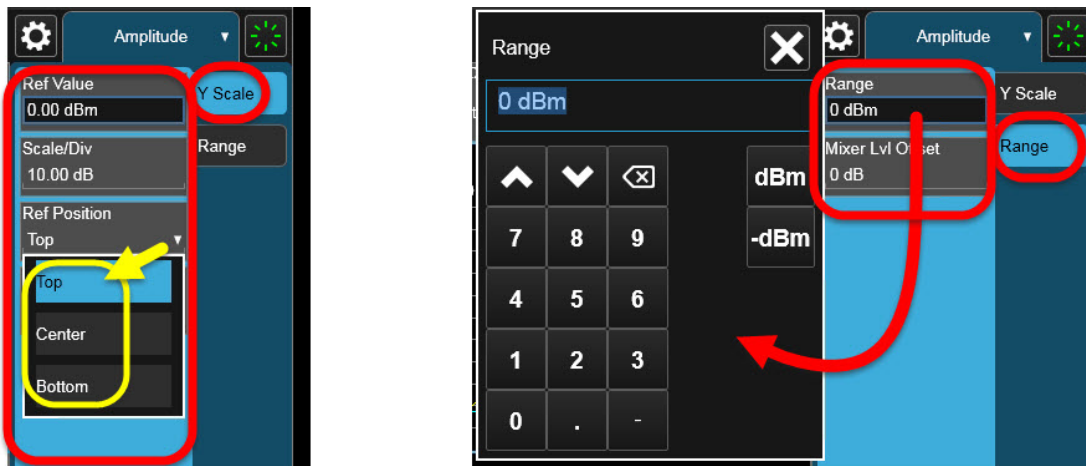

Although some menu choices involve only a simple selection (**Top | Center | Bottom**) or a value to be entered (**0 dBm**), some choices cause a more elaborate selection screen to appear in the display. In the example illustrated below, **Trigger > Trigger Settings Diagram** opens an interactive display (the trigger source can be changed from **Free Run** to **Ext 1** by clicking on the graphic).

Figure 5-4 Trigger Settings Diagram

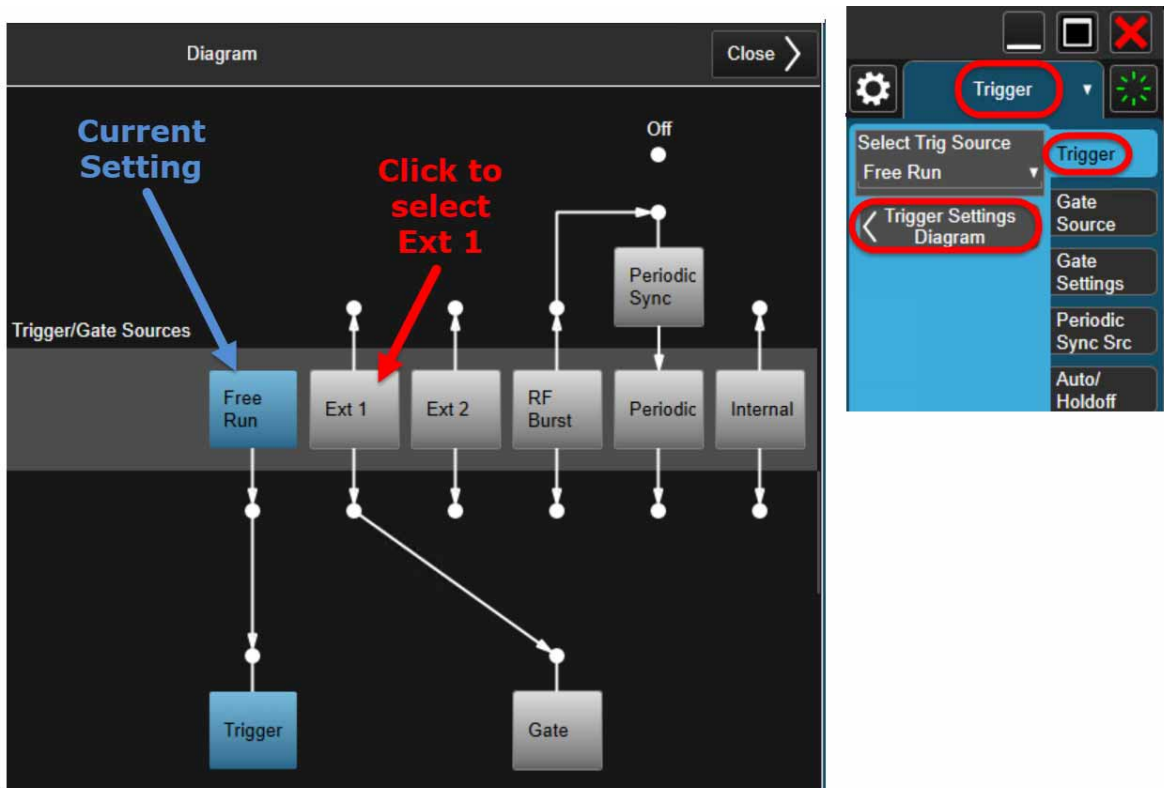

Another type of complex screen which some menu selections open is a configuration window such as the **Meas Setup Summary Table**, which gathers together multiple settings on one screen to make it easier to review them.

Figure 5-5 Meas Setup Summary Table

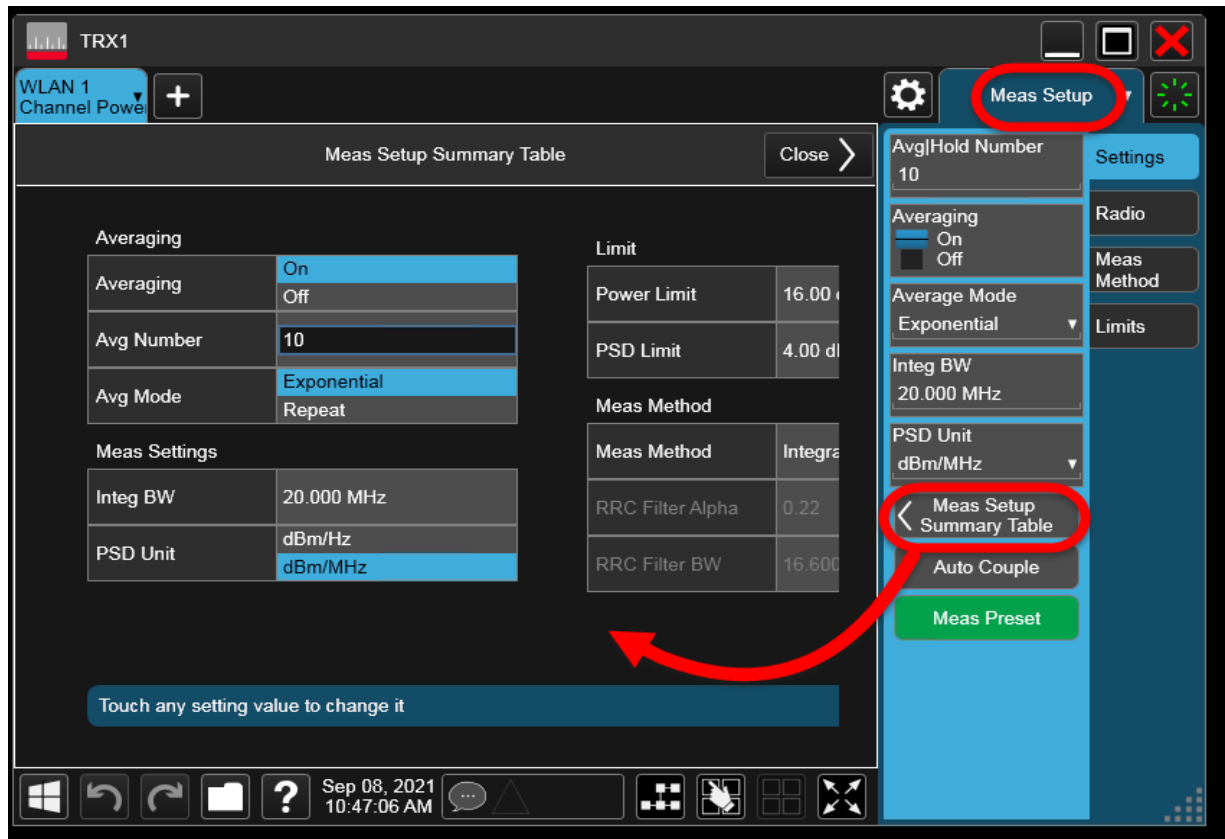

The menu choices are different for each measurement. For more detailed information, see the help file for the 5G application.

Measurement Setup (Traditional Interface)

The analyzer/receiver function of the E6640A relates to measurement of signals received from the DUT.

Menus are accessed from the the **Virtual Front Panel** popup window. To open the **VFP**, right-click on the display and select **Utility > Virtual Front Panel** in the temporary menu which appears.

Click the **Mode** button and select the desired mode (using the **More** function as necessary to see all the available choices). In this example, **WLAN** is selected.

Figure 5-6 Selecting a mode

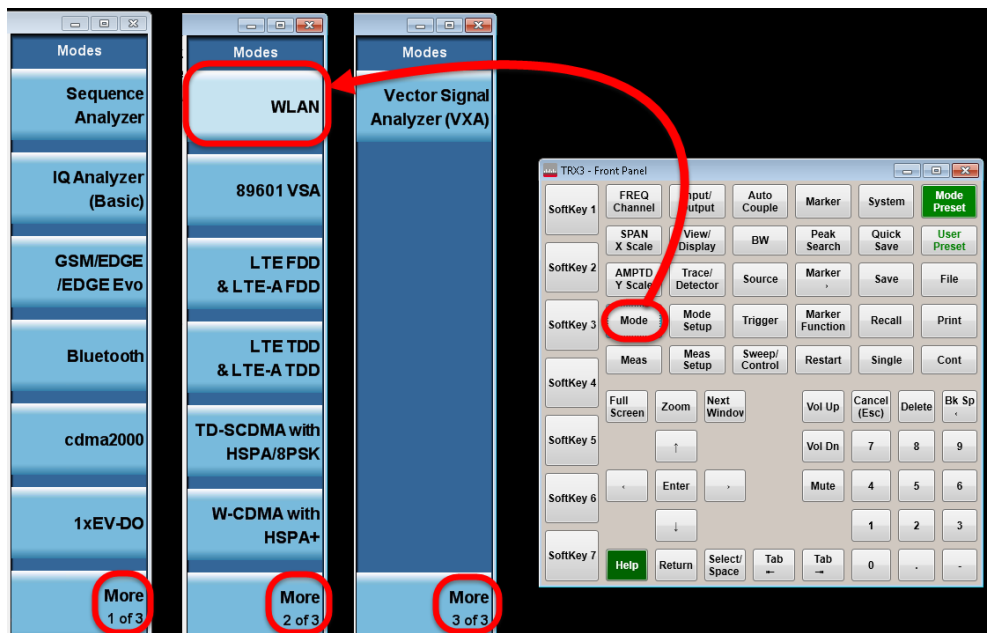

Click the **Meas** button on the VFP and select the desired measurement (using the **More** function as necessary to see all the available choices). In this example, the **Channel Power** measurement is selected.

Figure 5-7 Selecting a measurement

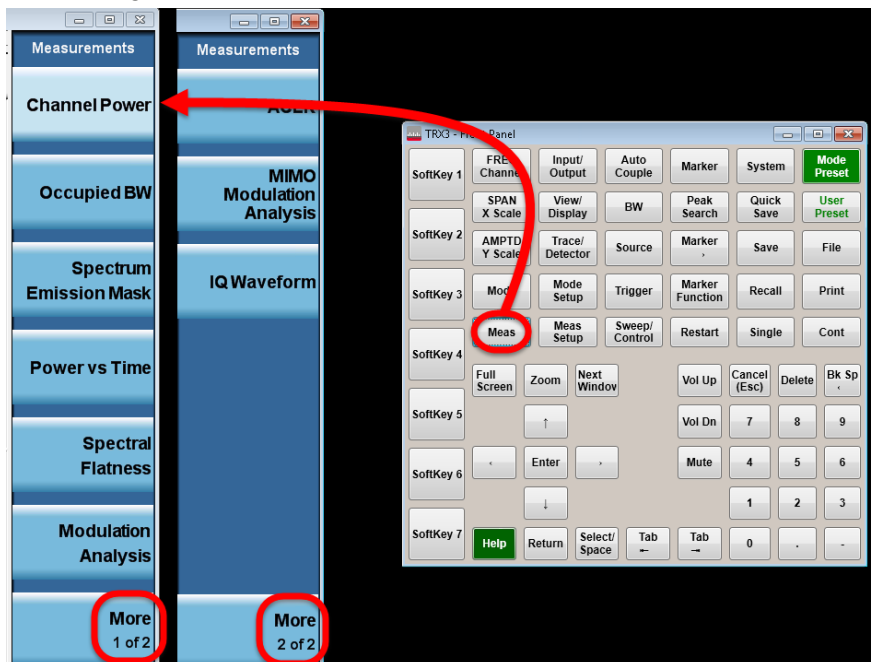

Settings for the selected measurement are made by selecting other menus.

Figure 5-8 Accessing menus

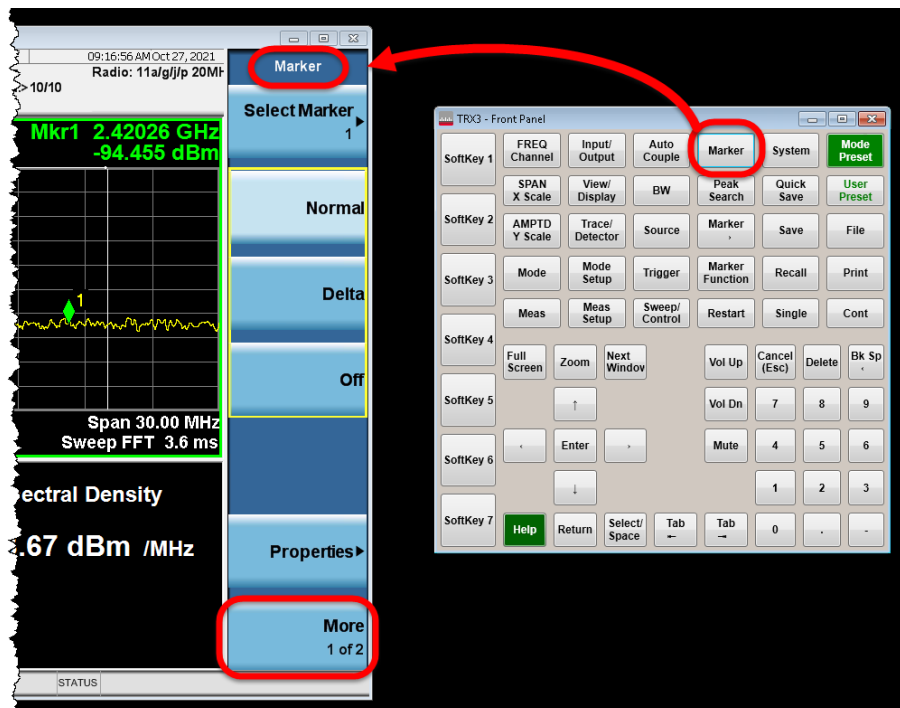

Where a menu setting requires a numerical value, use the numeric keypad at the lower right corner of the VFP to enter the number required.

Figure 5-9 Selecting menu settings

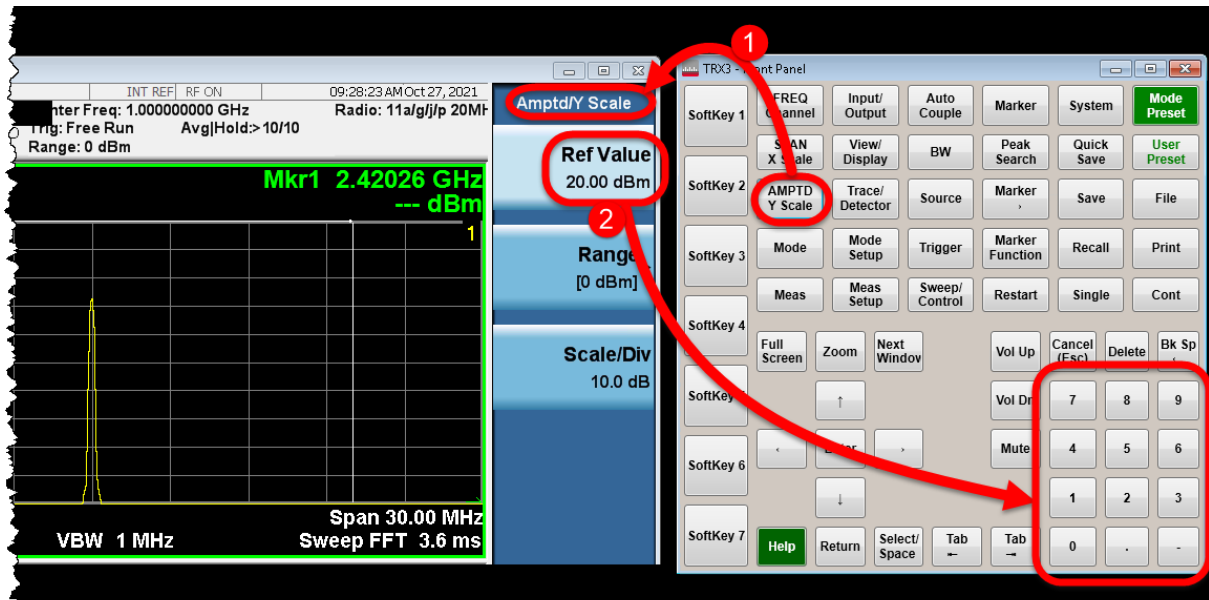

Marker Setup (MultiTouch Interface)

Multiple markers can be set up on the measurement display. Under **Marker > Select Marker**, choose the marker of interest and select **Settings** for it such as **Marker Frequency** and **Marker Mode**.

Figure 5-10

The Marker/Settings menu

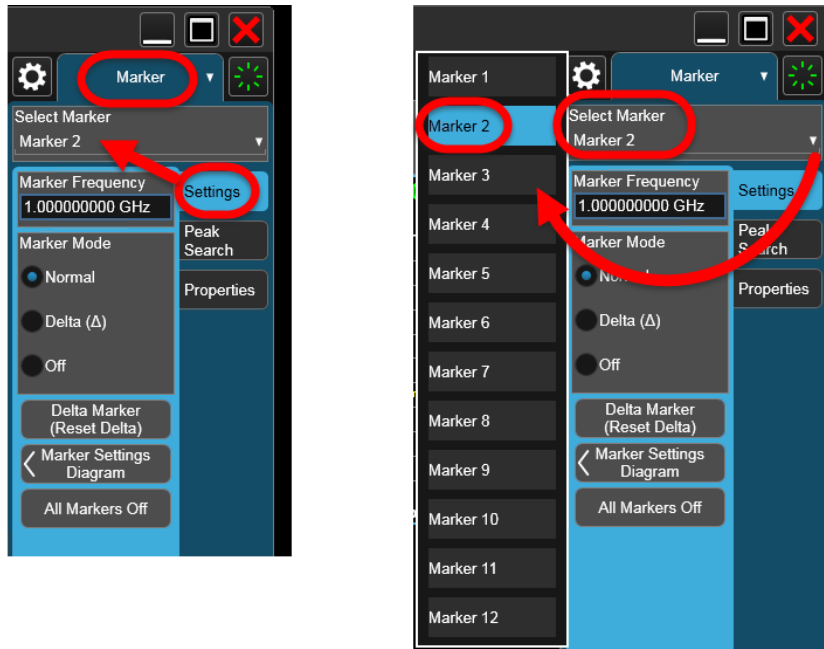

The currently selected marker can be moved simply by dragging it, but it can also be positioned more precisely by entering a specific **Marker Frequency** for it.

Figure 5-11

Changing marker frequency with cursor (left) or keypad (right)



Click **Marker Settings Diagram** on the **Settings** menu to display an interactive graphic showing the settings and dependencies of all markers at once. Click on a numbered **Marker** to select it and change its mode to **Normal**, **Off**, or **Delta**.

Operating Tasks: Receiver Setup
 Marker Setup (MultiTouch Interface)

(If **Delta** is selected, the marker is used with reference to another marker at a different frequency, to show the difference between trace amplitudes at those two points on the spectrum.)

To define **Marker 2** as a delta marker referenced to **Marker 1**, first click on the **Marker 1** icon and drag it to the space occupied by the **Reference Marker** icon directly under the **Marker 2** icon; this makes **Marker 1** the reference marker for **Marker 2**. Click on the **Marker 2** icon to select it, and set the **Marker Mode** to **Delta**.

Figure 5-12 The Marker Settings Diagram

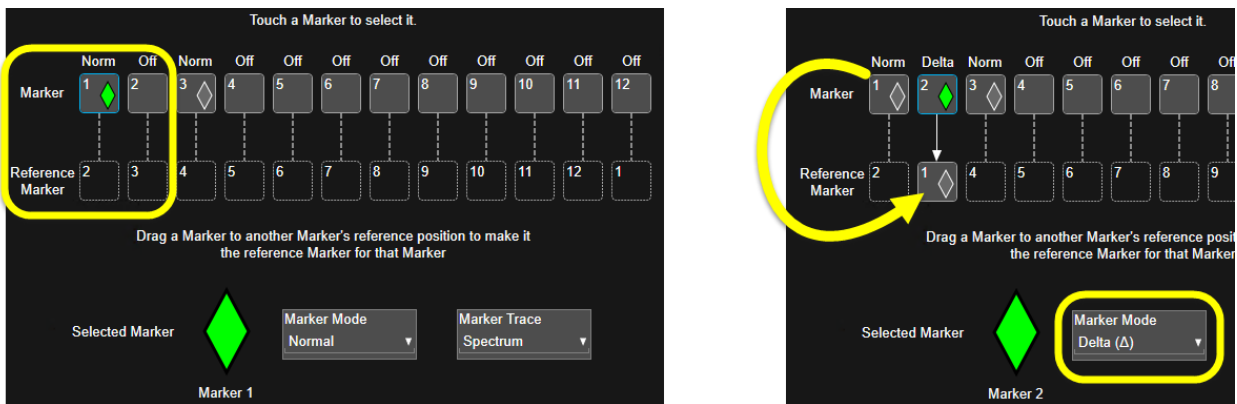

The illustration below shows the difference between **Normal** mode and **Delta** mode. When **Marker 2** is set to **Normal**, it displays the actual amplitude at that marker frequency. When **Marker 2** is set to **Delta**, it displays the difference between amplitude at **Marker 2** and amplitude at **Marker 1**.

Figure 5-13 The Marker/Settings menu

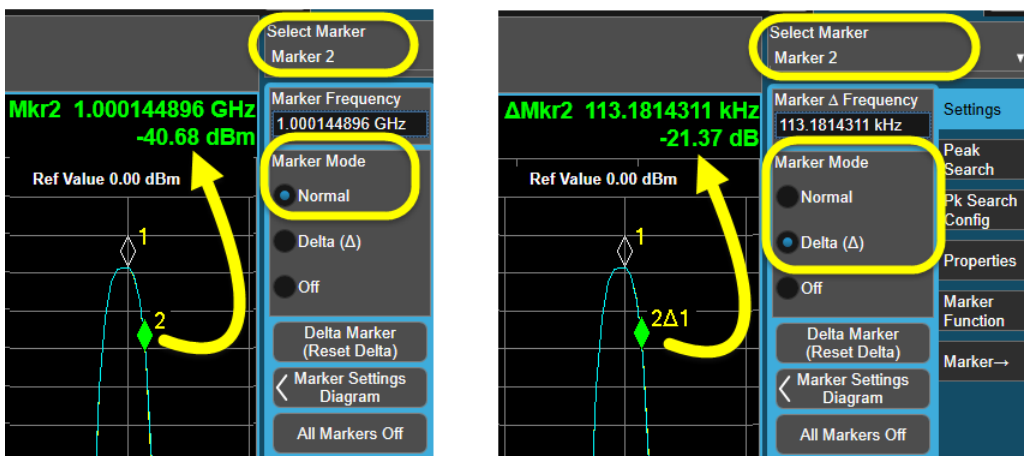

Marker Setup (Traditional Interface)

Multiple markers can be set up on the measurement display. Click **Marker** on the **VFP** to open the **Marker** menu, and click **Select Marker** to choose the particular marker for which you want to make settings.

Figure 5-14 The Marker > Select Marker menu



If the marker is **Off**, change it to **Normal** so that you can see its frequency displayed. Use the numeric keypad on the **VFP** to set its frequency. The frequency can also be adjusted by dragging it left or right on the display.

Figure 5-15 Viewing and changing marker frequencies

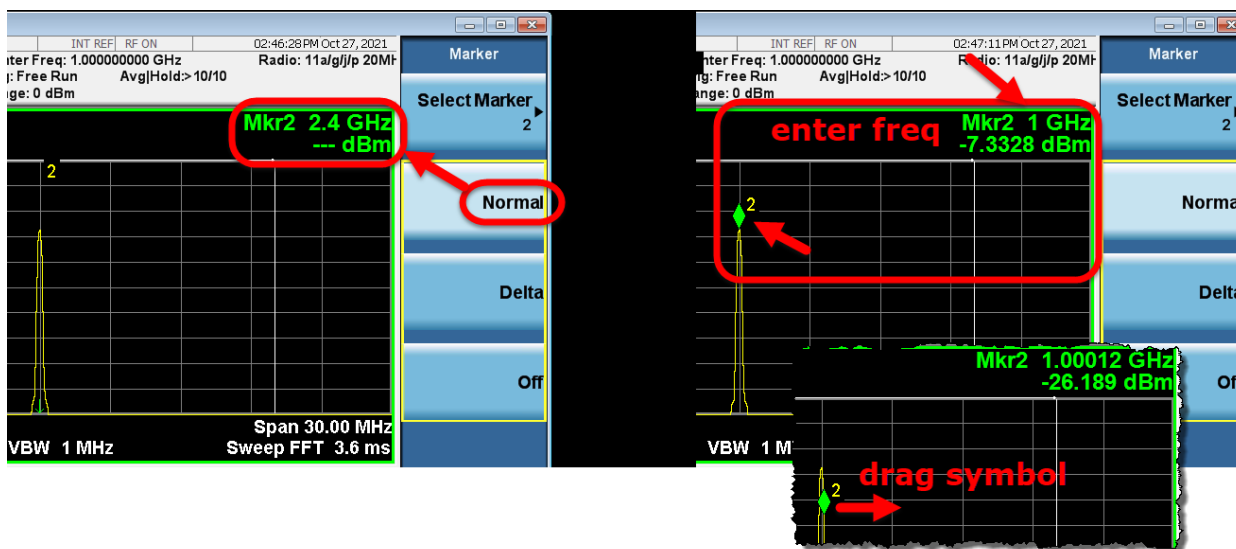

In the example setup below, **Marker 1** is configured as **Normal**, and **Marker 2** is configured as **Delta**. Under **Properties**, set **Marker 2** as **Relative To 1**. When **Marker 1** is selected, its frequency is displayed, as well as the measured power at that frequency. When **Marker 2** is selected, the values displayed indicate how much the frequency and measured power at **Marker 2** differ from the values for **Marker 1** (specifically, **Marker 2** is 120 kHz higher in frequency, and 18.849 dB lower in power, than **Marker 1**).

Figure 5-16 Setting up a Delta marker



6 Operating Tasks: Source Setup

The following topics can be found in this section:

- [“General RF Source Setup” on page 162](#)
- [“Loading and Running Waveform Files \(Traditional Interface\)” on page 166](#)
- [“Creating Waveform Sequences \(Traditional Interface\)” on page 170](#)
- [“Creating Waveform Sequences \(MultiTouch Interface\)” on page 168](#)
- [“Using Waveform Markers” on page 173](#)
- [“Locking Waveform Files \(MultiTouch Interface\)” on page 179](#)
- [“Locking Waveform Files \(Traditional Interface\)” on page 181](#)
- [“Locking Waveform Files \(MultiTouch Interface\)” on page 179](#)
- [“Header Utilities \(Traditional Interface\)” on page 184](#)

General RF Source Setup

The source function of the E6640A relates to generation of test signals to be transmitted to the DUT. (Not all measurement scenarios require these signals, but many do.)

In the **MultiTouch** interface, most source settings are made from the **Input/Output > RF Source** menu. In the **Traditional** interface, they are made from the Source menu. Both are illustrated below.

Figure 6-1 Source menus in the MultiTouch (left) and Traditional interfaces

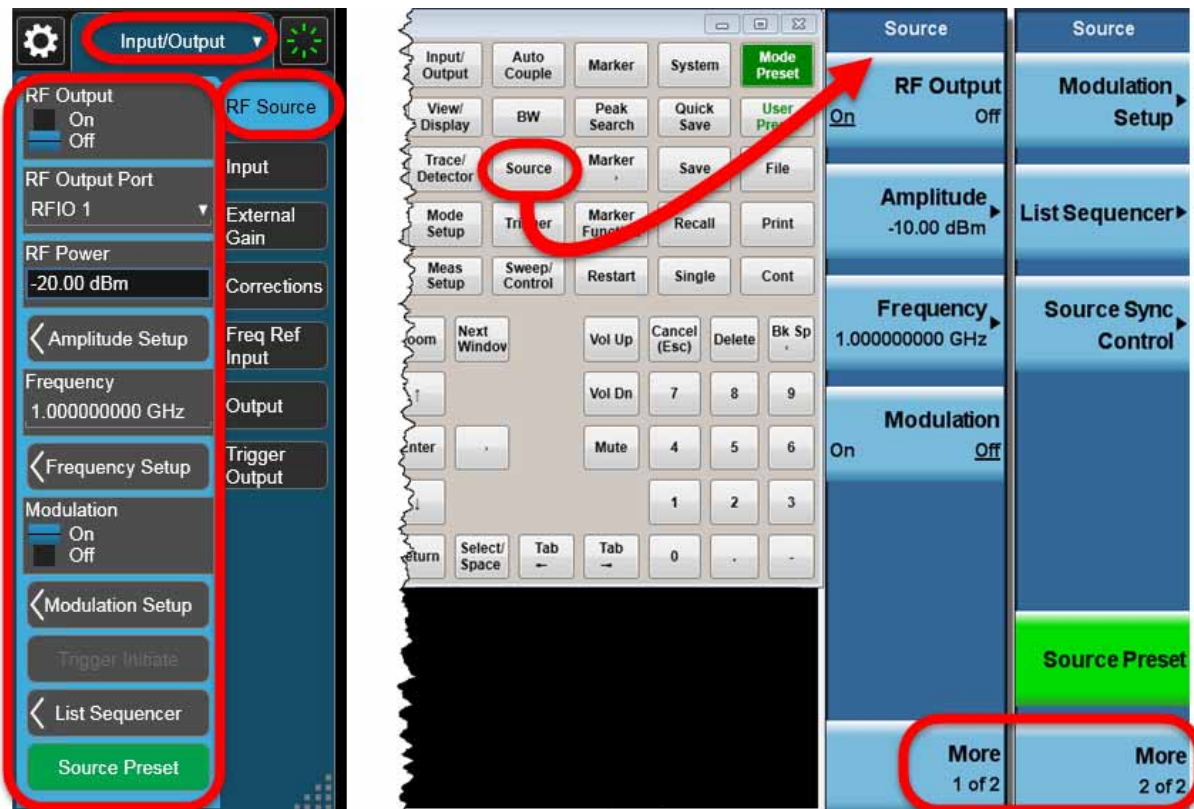

Loading and Running Waveform Files (MultiTouch Interface)

The **Modulation Setup > ARB Setup** window can be used to configure various functions of the arbitrary waveform generator, and to select which waveform files it plays.

Figure 6-2 ARB Setup Window

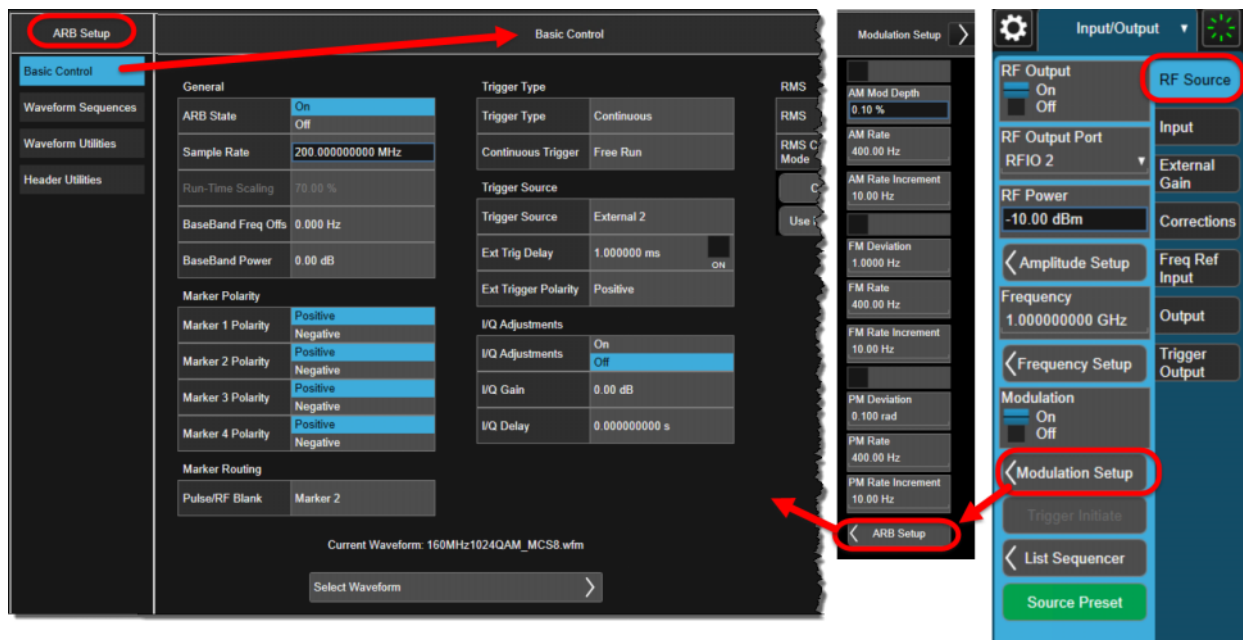

Basic Control is used to set markers and triggers, and to select waveform files as illustrated below. Click **Select Waveform** to choose a waveform file that is currently in ARB memory. If a desired waveform file is not currently shown in the **Segments in ARB Memory** list, use **Recall Waveform** to load it.

Figure 6-3 Basic Control (ARB Setup)

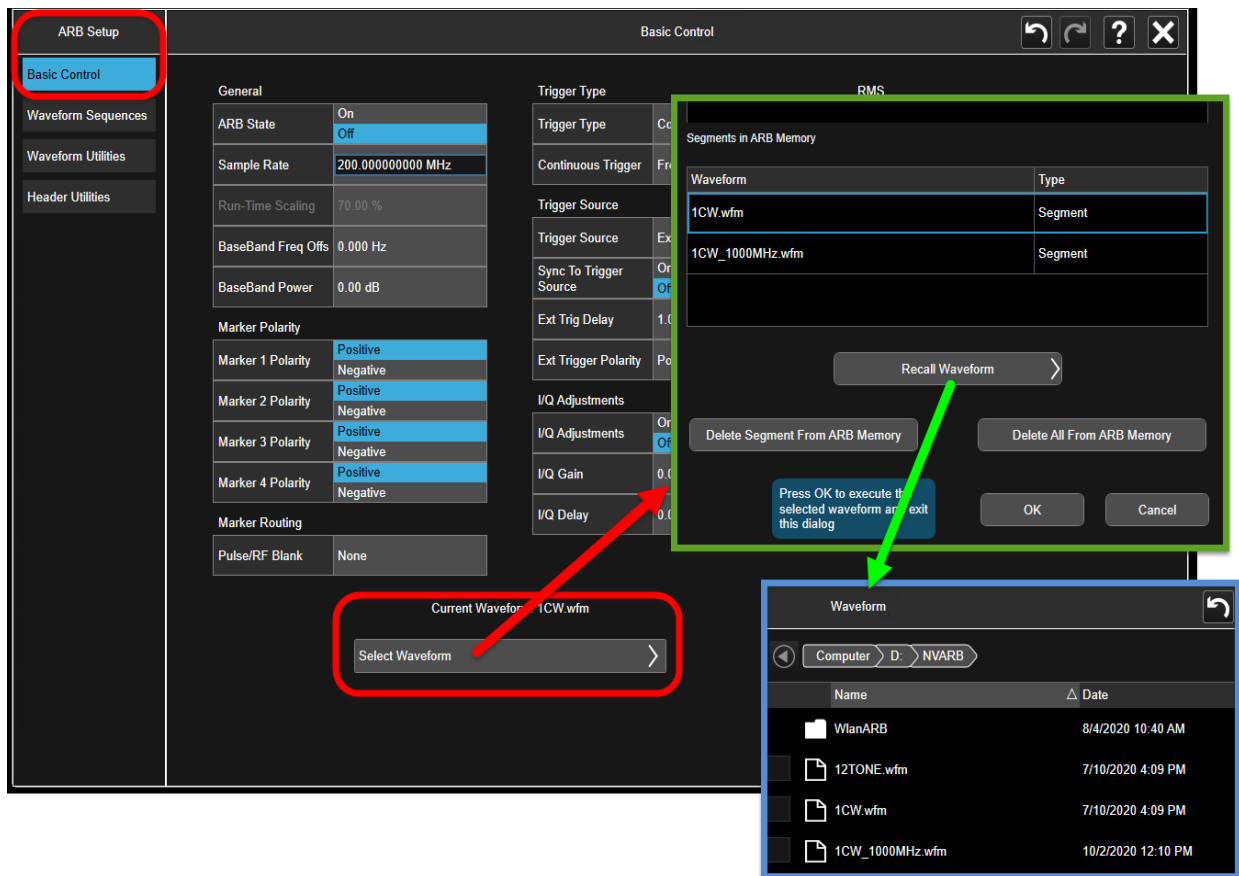

A waveform file can also be recalled directly from the **File > Recall** window:

Figure 6-4 Recalling an ARB file (Recall function)

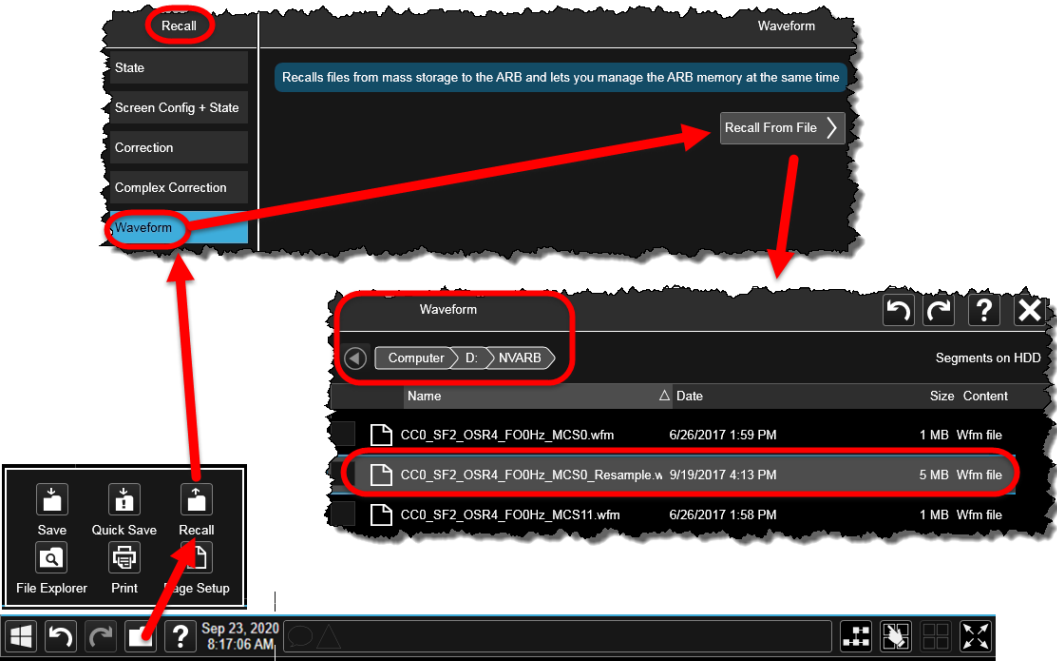

Loading and Running Waveform Files (Traditional Interface)

The **Source > Modulation Setup > ARB** menu can be used to configure various functions of the arbitrary waveform generator, and to select which waveform files it plays.

Figure 6-5 ARB Setup Window



The **ARB Waveform** menu and its submenus are used to control which waveforms are in ARB memory. Click **Segments on Hard Disk** to see a list of available waveform files on the hard disk drive (use the **Current Directory** or **Default Directory** selections to navigate to a different directory on the hard drive if necessary). Select a waveform file and click **Load Segment to ARB Memory** to add it (or use **Load All** to add all available waveform files at once).

If you want to remove a waveform file from ARB memory, click **Segments in ARB Memory**, and remove a selected waveform or all of them.

Figure 6-6 ARB Waveform menu and sub-menus

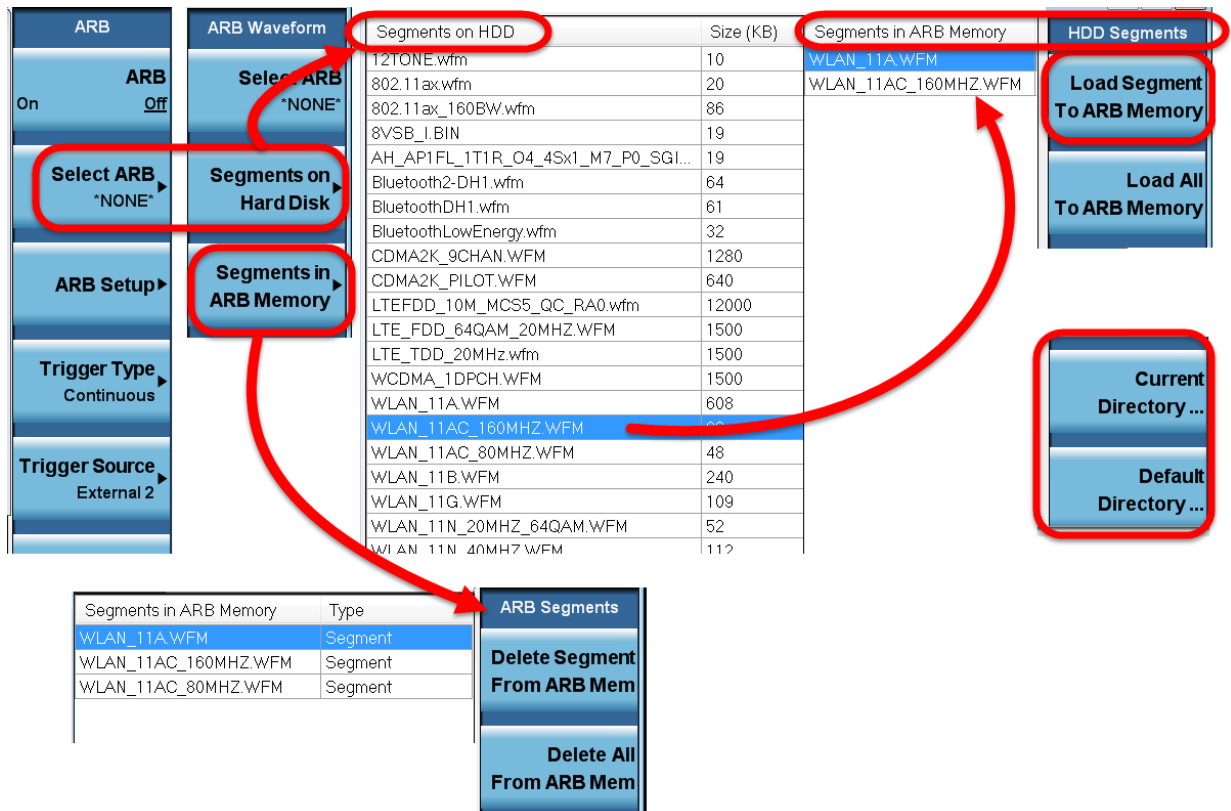

Creating Waveform Sequences (MultiTouch Interface)

Waveform Sequences (under **ARB Setup**) is used to create a sequence of waveform files to be played in order:

1. Click **Build New Sequence**.
2. In the window which opens, click **Insert Waveform** (this opens a window showing the waveforms that are in ARB memory. To add a waveform to the sequence, select it and click **OK**. Repeat this process to add more).
3. To add waveforms that are not shown in the table, use the **Recall Waveform** function to load them into ARB memory.
4. When you have all the waveforms added, and you've made the desired settings for their repetitions and markers, click **Save Sequence**.

Figure 6-7 Waveform sequences (ARB Setup)

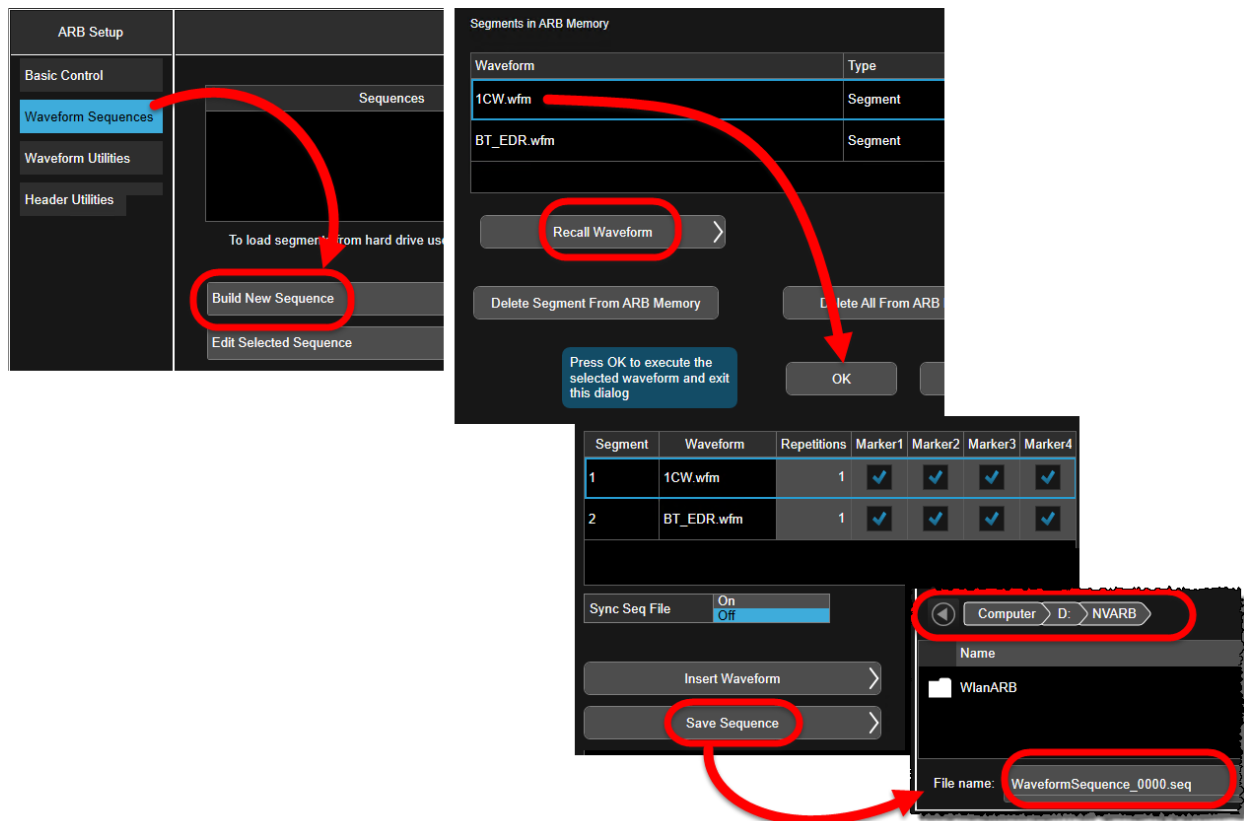

Using the waveform sequence (MultiTouch interface)

Once a waveform sequence file (.seq) has been saved, it can be used as if it were a regular waveform file (.wfm). In the **Recall Waveform** window, change the displayed **File Type** to **Waveform Sequence Files** and select the desired file, which is then loaded into ARB memory, and can be used in place of a waveform file.

Figure 6-8 Loading a waveform sequence (ARB Setup)

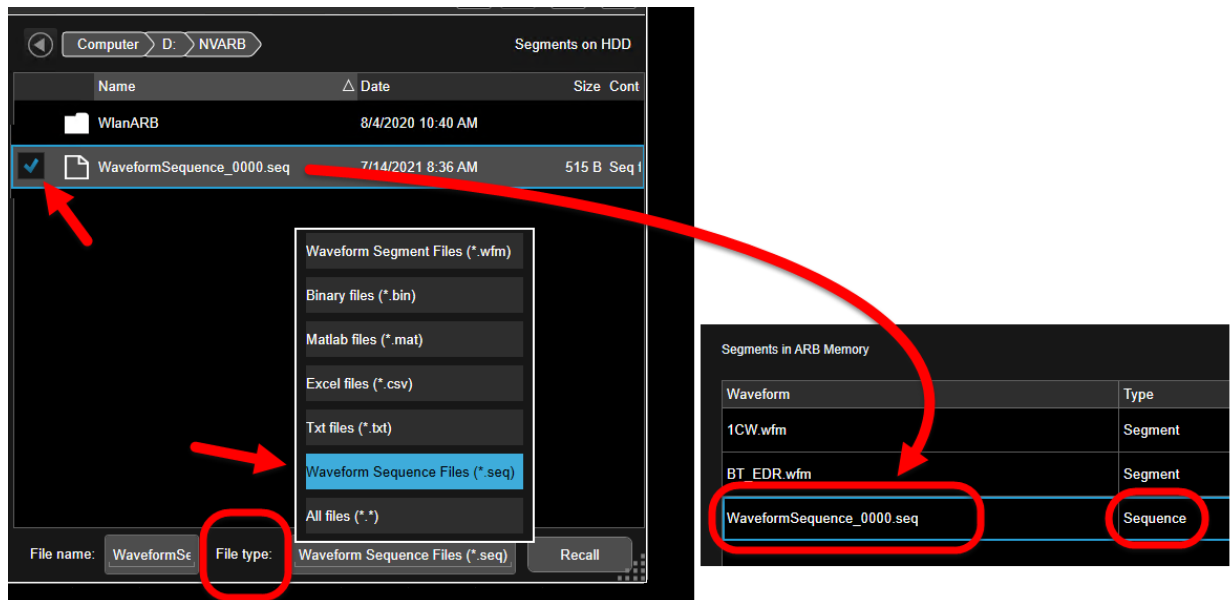

Creating Waveform Sequences (Traditional Interface)

To create a sequence of waveform files to be played in order, go to the **Source** menu and select **Modulation Setup > ARB > Waveform Sequences > Build New Sequence > Insert New Waveform**.

Figure 6-9

Navigating to the Insert New Waveform menu

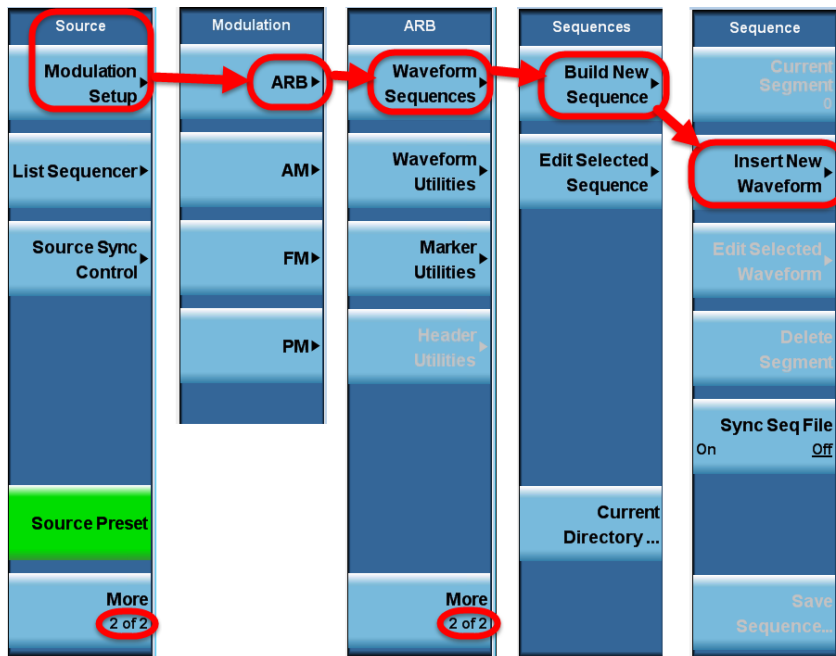

If the waveform segments you want to add to the waveform sequence are already loaded into ARB memory, you can select them from the displayed list of segments and click **Insert Waveform**. However, it is usually necessary as a first step to click **Segments on Hard Disk**, so that you can see all saved waveform segments and move the ones you want into ARB memory.

Figure 6-10

Obtaining waveform segments from the hard drive

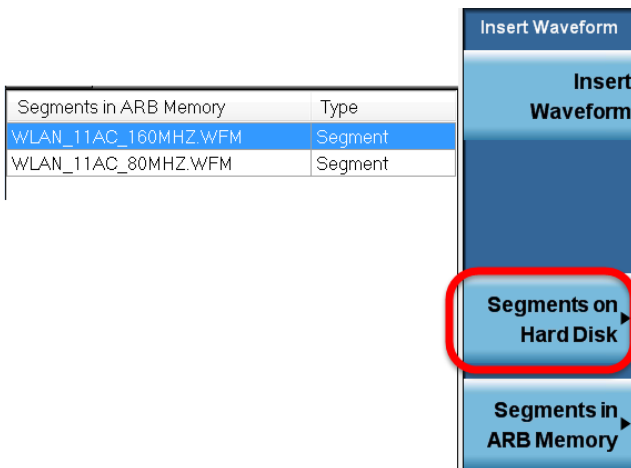

Select any waveform segments you need from the hard drive and click **Load Segment to Arb Memory**.

Figure 6-11

Loading waveform segments into ARB memory

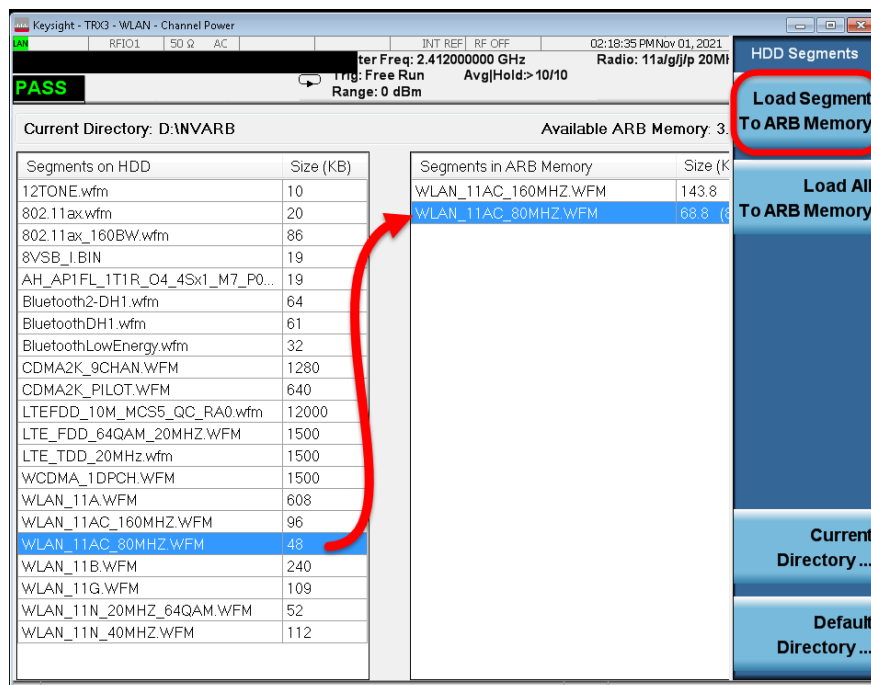

When the desired segments are in ARB memory, click **Insert Waveform** to add them to the waveform sequence. Click **Save Sequence** when the segments are added (a file-explorer window opens, so that you can chose the file path).

Figure 6-12

Loading waveform segments into waveform sequence

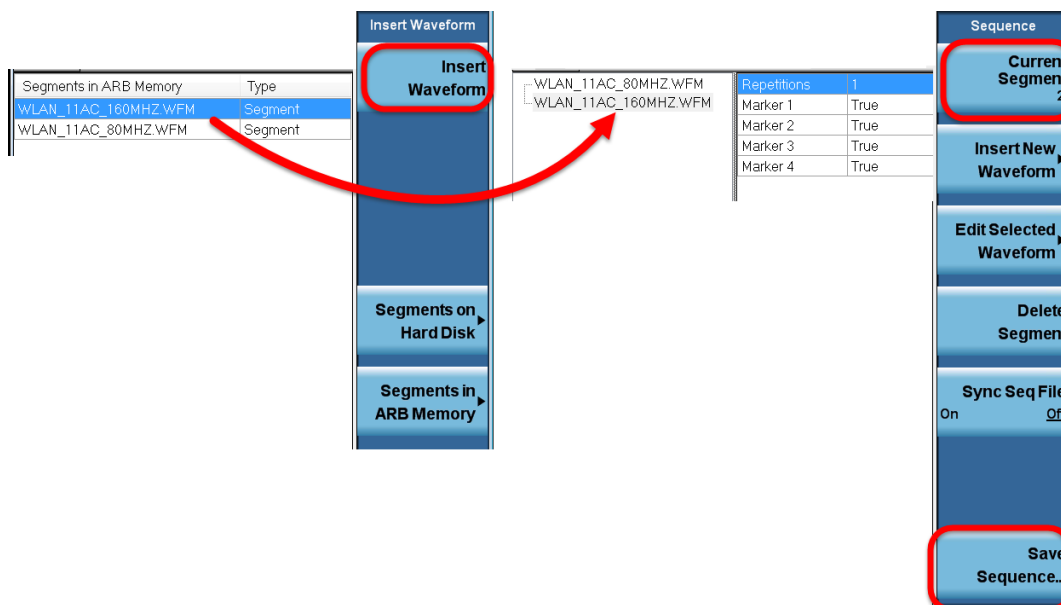

Using the waveform sequence (Traditional interface)

Once a waveform sequence file (.seq) has been saved, it can be used as if it were a regular waveform file (.wfm). On the **Source** menu, select **Modulation Setup > ARB > Select ARB > Segments on Hard Disk**.

Figure 6-13 Finding a saved sequence

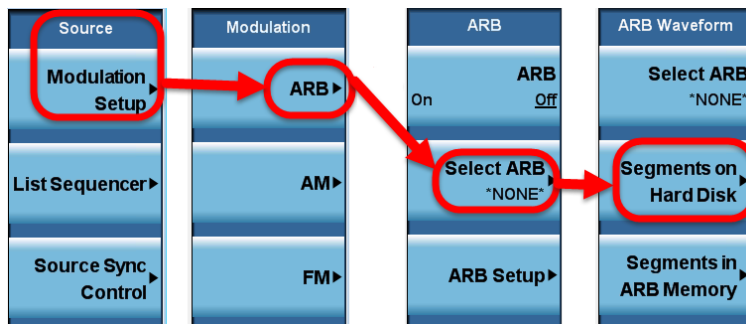

Use **Current Directory** to navigate to where you saved the sequence. Select the sequence and click **Load Segment to ARB Memory**.

Figure 6-14 Loading a waveform sequence

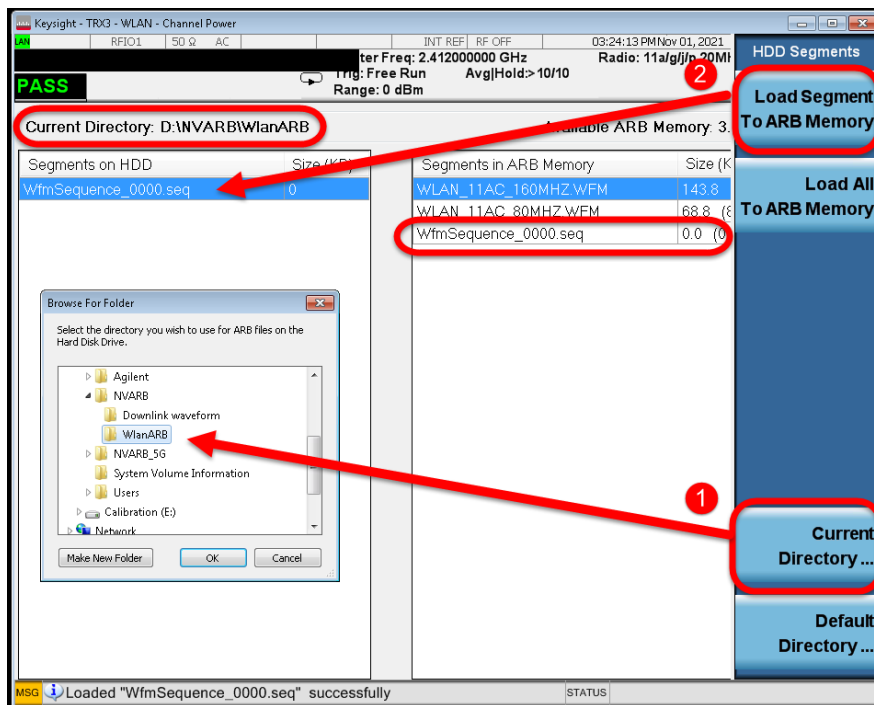

Using Waveform Markers

ARB waveform files played by the source in the E6640A include markers within the waveform data, together with settings for these markers included in the header of the waveform file. One of these markers can be designated for RF blanking of the source output (that is, RF power is on only during the marker event).

The markers can also be used to generate trigger outputs at the **Trig 1** and **Trig 2** connectors on the front panel.

The overall operation of waveform markers is illustrated in the diagram below.

Figure 6-15 Waveform markers

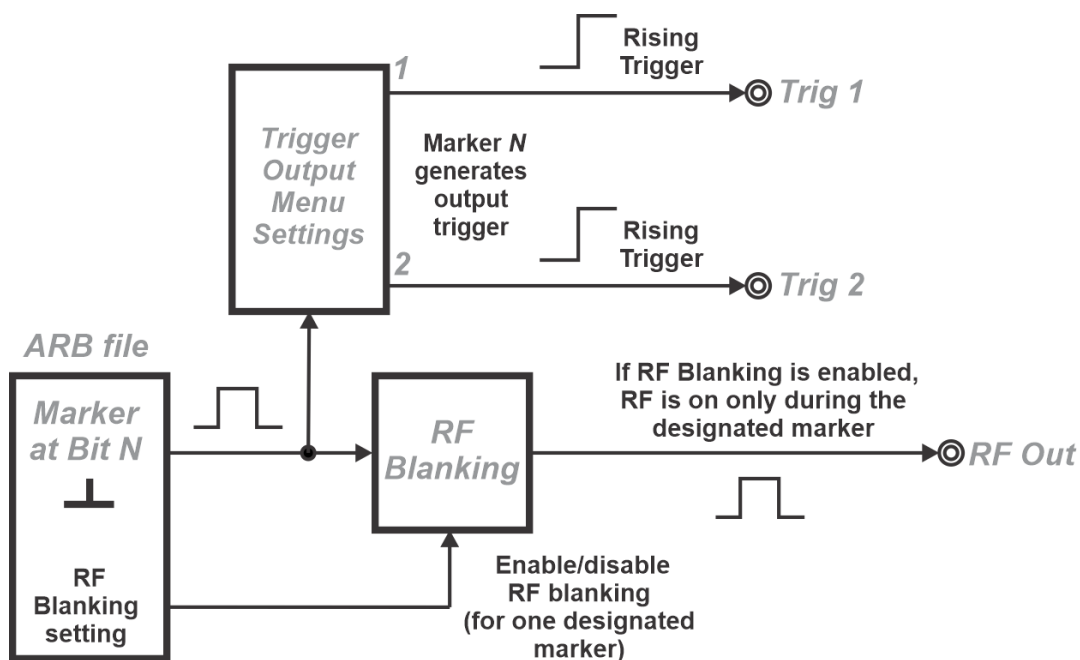

Waveform Marker Settings (MultiTouch Interface)

The marker settings included in the ARB file header can be viewed from the **Input/Ouput > RF Source > Modulation Setup > ARB Setup** screen, under **Basic Control** or under **Header Utilities**. Although settings can be changed in either of these places, the changes to the header can only be saved by using the **Save Header** button under **Header Utilities**.

Figure 6-16 Marker settings in ARB file header

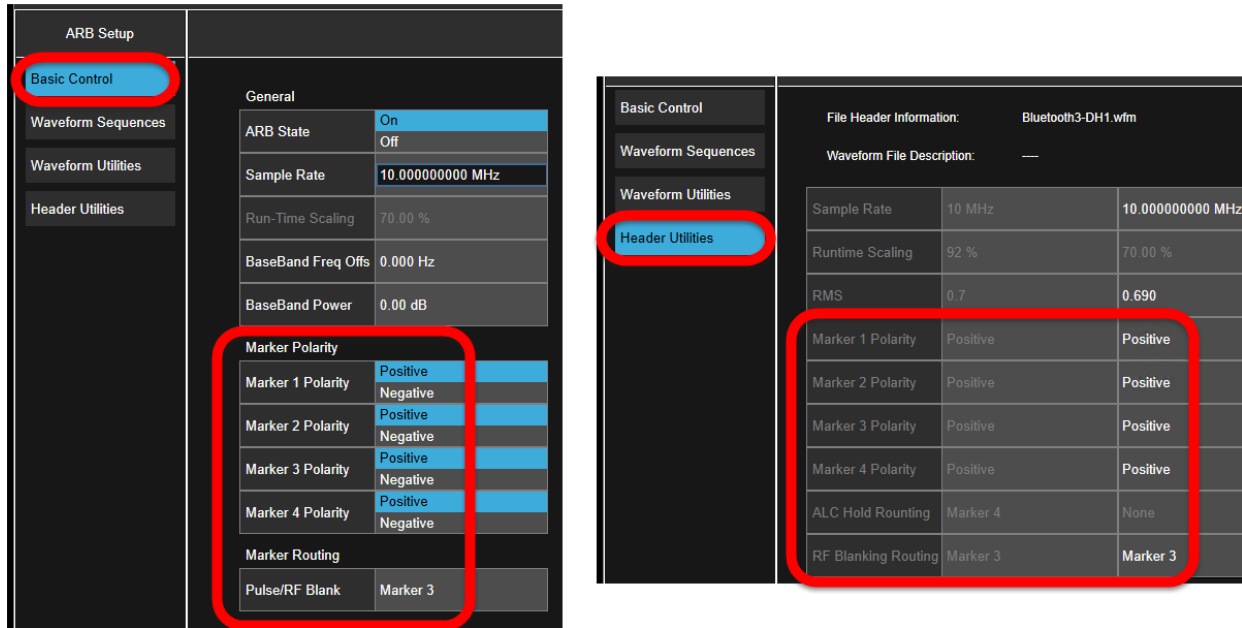

Marker Polarity settings determine whether the trigger is rising (**Positive**) or falling (**Negative**).

ALC Hold settings have no effect in model E6640A.

RF blanking is set up by **Marker Routing** (under **Basic Control**) or by **RF Blanking Routing** under **Header Utilities**. The possible settings include:

- **None** (no RF blanking)
- **Marker 1, 2, 3, or 4** (RF is off during the numbered marker selected here)
- **Per Arb** (this selection, although sometimes visible in the user interface, is not applicable to Model E6640A)

The exact result of these settings depends upon how markers were created in the ARB waveform file.

Waveform Marker Settings (Traditional Interface)

To view or alter marker settings included in the ARB file header, go to the **Source** menu and select **Modulation Setup > ARB > Marker Utilities**. Use the **Marker Polarity** menu to set the polarity of the four waveform markers as positive or negative. Use the **Marker Routing** menu to choose which of the four markers (or none) is used for RF Blanking.

Figure 6-17 Marker settings in ARB file header

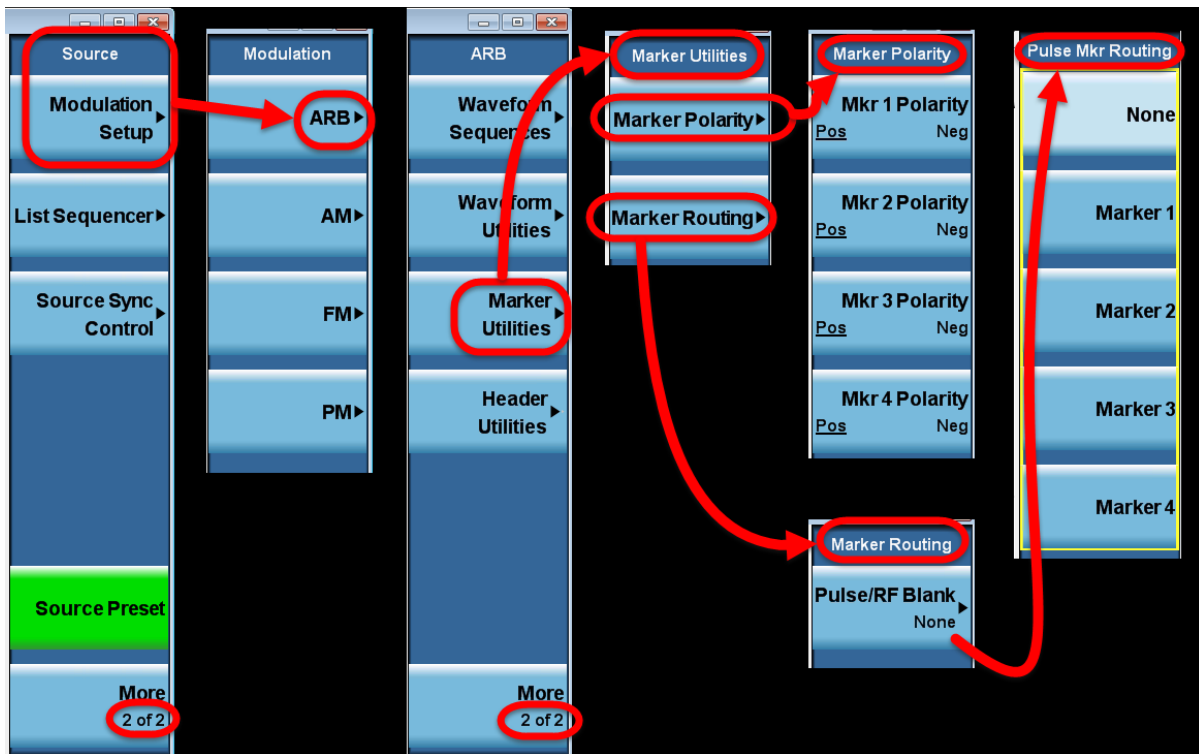

The exact result of these settings depends upon how markers were created in the ARB waveform file.

Operating Tasks: Source Setup
Using Waveform Markers

Select Utilities to see marker settings in the header file.

Figure 6-18 Marker settings in ARB file header

The screenshot shows a software interface with four main panels. The first panel, 'Source', has 'Modulation Setup' circled in red. An arrow points to the 'Modulation' panel, where 'ARB' is circled in red. Another arrow points to the 'ARB' panel, where 'Header Utilities' is circled in red. A final arrow points to a table titled 'File Header Information: WLAN_11A.WFM'. The table has three columns: 'Fields', 'File Settings', and 'Current Settings'. The 'Marker 1 Polarity' through 'Marker 4 Polarity' rows are highlighted in yellow. The 'ALC Hold Routing' and 'RF Blanking Routing' rows are highlighted in green. At the bottom of the interface, 'More 2 of 2' is circled in red in both the 'Source' and 'ARB' panels.

Fields	File Settings	Current Settings
Description	----	----
Sample Rate	80.00000000000000 MHz	80.0000000000 MHz
Runtime Scaling	95.000	70.00 %
RMS	0.181	0.181
Marker 1 Polarity	Positive	Positive
Marker 2 Polarity	Positive	Positive
Marker 3 Polarity	Positive	Positive
Marker 4 Polarity	Positive	Positive
ALC Hold Routing	Marker 2	Marker 2
RF Blanking Routing	Marker 2	Marker 2
BB Frequency Offset	0.000000000000000 Hz	0.000 Hz
AWGN State	Off	----
AWGN C/N Ratio	20.00dB	----
AWGN Carrier BW	16.250 MHz	----
AWGN Noise BW	Unspecified	----
AWGN Carrier RMS	Unspecified	----
Over-Range Protect...	Unspecified	----
Unique Waveform ID	3370438230	----
License Required	Yes, Required licenses installed	----

Generating Trigger Outputs (MultiTouch Interface)

The waveform markers can be used to generate triggers at the **Trig 1** and **Trig 2** outputs on the front panel. In the **Input/Output > Trigger Output** menu, separate settings are available for **Trig 1 Out** and **Trig 2 Out**.

Select **Source Marker N** and choose **Source** as the output device.

Figure 6-19 Using waveform markers to generate trigger outputs



In selecting a marker under **Trig 1 Out** or **Trig 2 Out**, the options include **Off** (no output trigger), **Marker N** (choose a numbered marker), or **Source Per Arb**. (The latter option does not apply to the E6640A model.)

Generating Trigger Outputs (Traditional Interface)

The waveform markers can be used to generate triggers at the **Trig 1** and **Trig 2** outputs on the front panel. In the **Input/Output > Trigger Output** menu, separate settings are available for **Trig 1 Out** and **Trig 2 Out**.

Figure 6-20 Using waveform markers to generate trigger outputs

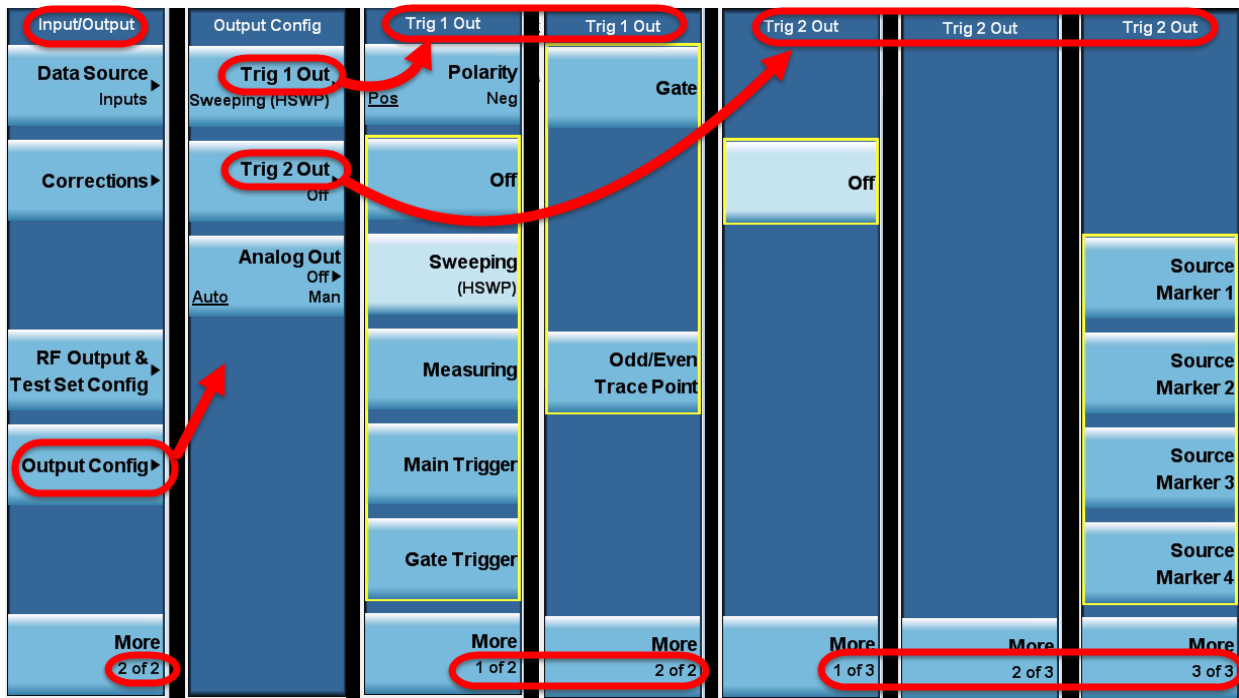

Locking Waveform Files (MultiTouch Interface)

The measurement applications which run on the E6640A can have a "Y" license (which supports unrestricted use of waveform files by the internal source) or a "V" license (a measurement-oriented license which limits the source to a fixed number of slots into which waveforms can be locked). For example, the license **Y9085EMOE** supports unrestricted use of waveform files in the 5GNR mode; the license **V9085EMOE** is also for the 5GNR mode but limits the source to waveforms already locked in slots.

If you are using a "V" license, you will have to lock a waveform into a slot in order to use it. Open the **Waveform Utilities** window under **Arb Setup**. Select the waveform from the list of files in ARB memory and click **OK**. (If a waveform you want is not shown in the table, use the **Recall Waveform** function to load it into ARB memory.)

Figure 6-21 Waveform Utilities: adding a waveform

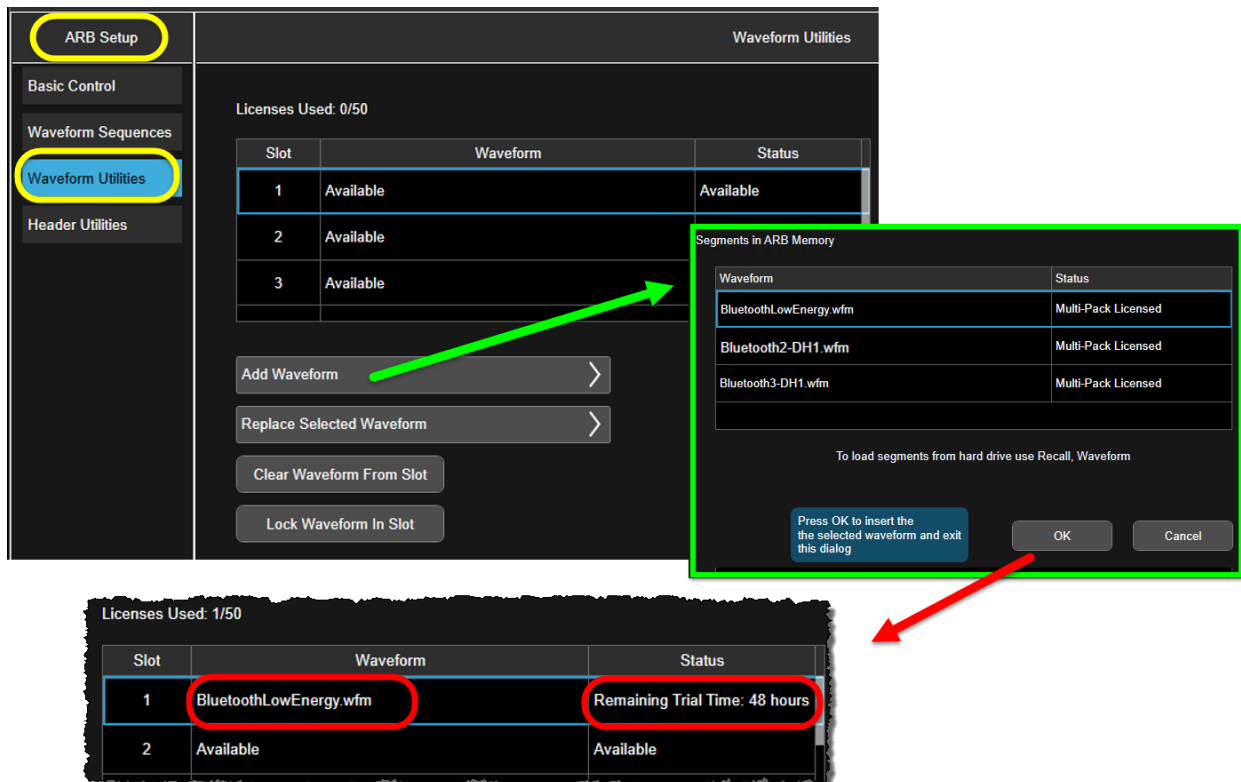

NOTE

If you have previously added a waveform file, but you removed it rather than locking it, that file name becomes unusable here; the interface will not allow you to add a new waveform file with the same name as a file added previously, even if that file is no longer shown in a slot.

To lock a waveform into a slot, highlight the name of the waveform in the list and click **Lock Waveform In Slot**. A confirmation window appears, giving you an opportunity to cancel if you don't want the slot permanently assigned.

Figure 6-22 Waveform Utilities: adding a waveform

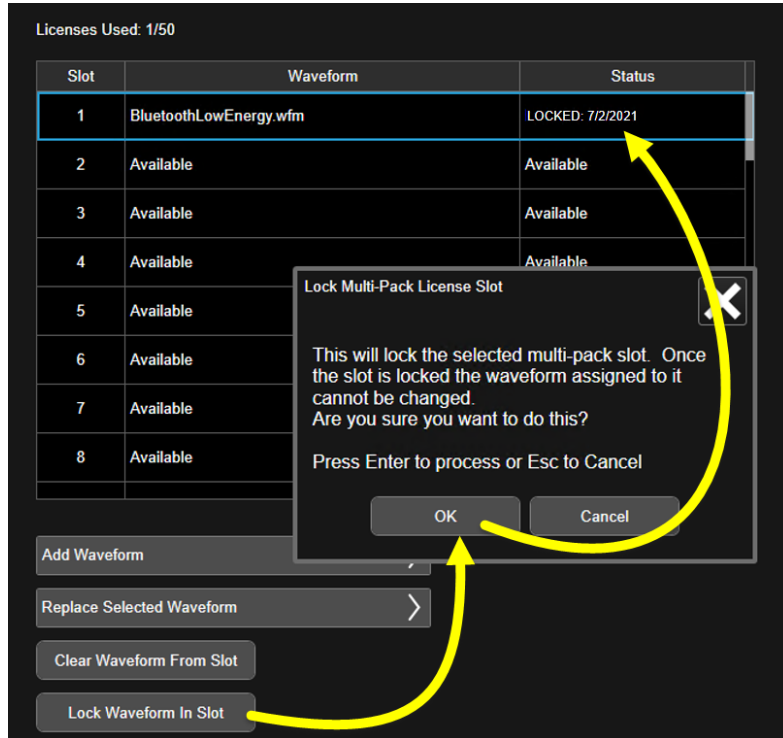

Locking Waveform Files (Traditional Interface)

The measurement applications which run on the E6640A can have a "Y" license (which supports unrestricted use of waveform files by the internal source) or a "V" license (a measurement-oriented license which limits the source to a fixed number of slots into which waveforms can be locked). For example, the license **Y9085EMOE** supports unrestricted use of waveform files in the 5GNR mode; the license **V9085EMOE** is also for the 5GNR mode but limits the source to waveforms already locked in slots.

If you are using a "V" license, you will have to lock a waveform into a slot in order to use it. Open the **Source** menu and select **Modulation Setup > ARB > Waveform Utilities > Multi-Pack Licenses**.

Figure 6-23

Waveform Utilities: finding the Multi-Pack Licenses menu

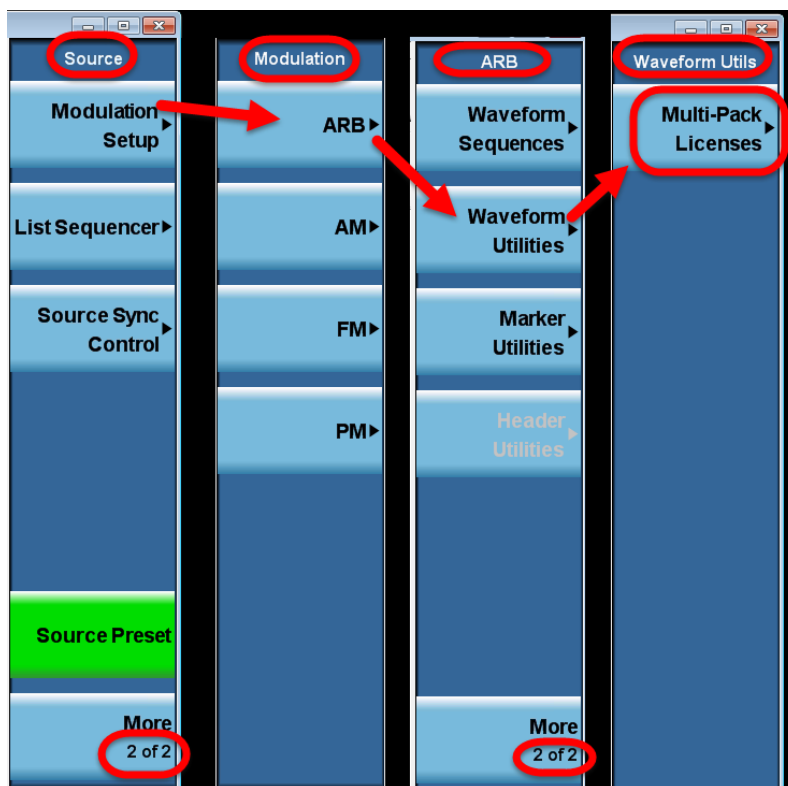

Click **Segments on Hard Disk** and move the desired waveform into ARB memory. Click **Add Waveform** to add the selected waveform into a license slot. A confirmation window appears, giving you an opportunity to cancel if you don't want the slot permanently assigned.

To lock a waveform into a slot, highlight the name of the waveform in the list and click **Lock Waveform In Slot**. A confirmation window appears, giving you an opportunity to cancel if you don't want the slot locked.

Figure 6-24 Waveform Utilities: adding a waveform

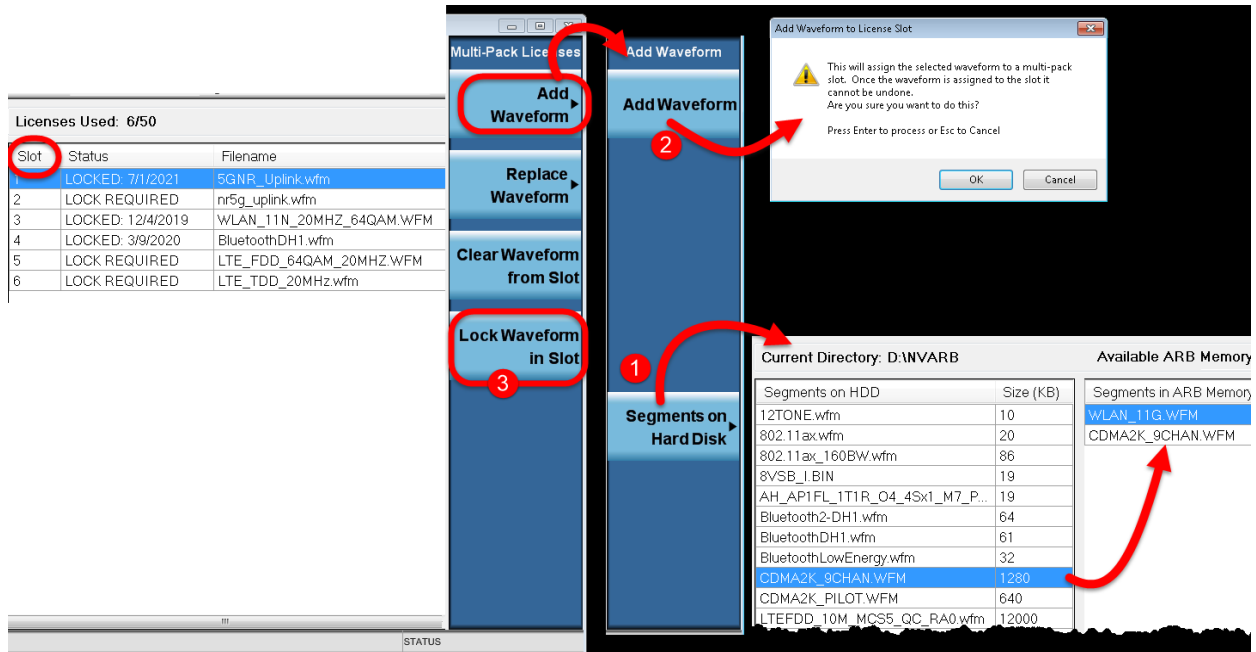

NOTE

If you have previously added a waveform file, but you removed it rather than locking it, that file name becomes unusable here; the interface will not allow you to add a new waveform file with the same name as a file added previously, even if that file is no longer shown in a slot.

Header Utilities (MultiTouch Interface)

The **Header Utilities** window displays information from the header of the current waveform file or waveform sequence file. Settings which are shown in white rather than gray (such as **Sample Rate** and **Marker Polarity**) are editable; to save your changes to these settings, click **Save Header**.

ALC Hold settings have no effect in model E6640A. However, the setting for **RF Blanking** is functional and can be selected here.

Figure 6-25 Header Utilities (ARB Setup)

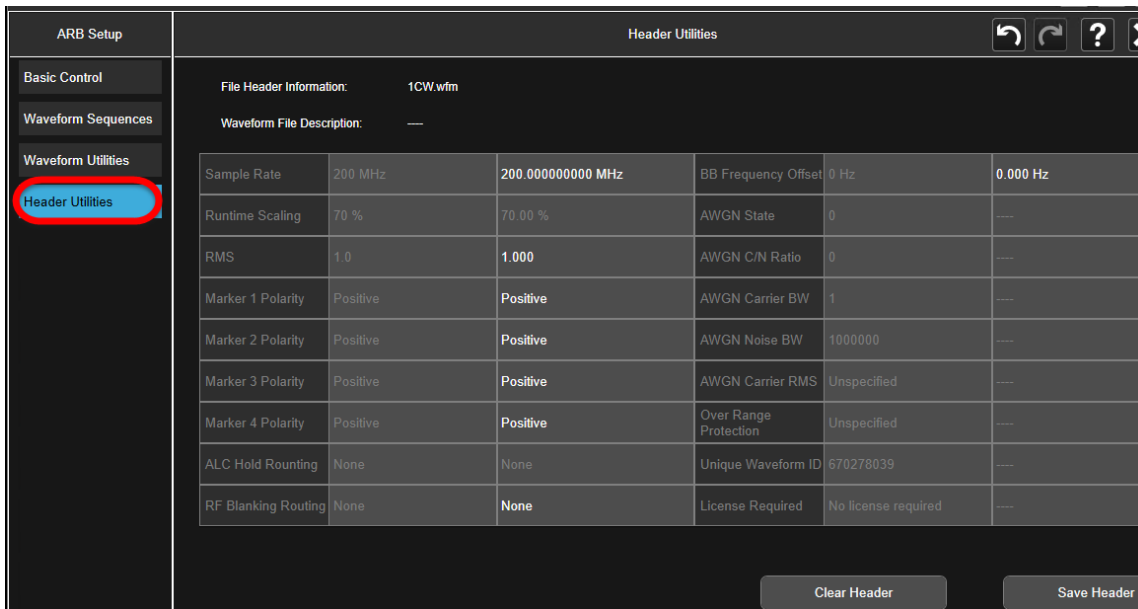

Header Utilities (Traditional Interface)

Select the **Source** menu and select **Modulation Setup > ARB > Header Utilities** to view the header of the current waveform file or waveform sequence file. The **Current Settings** column reveals differences between settings included in the file and settings that have been made using menus. (To save those modified settings to the header file, click **Save Setup To Header**.)

ALC Hold settings have no effect in model E6640A. However, the setting for **RF Blanking** is functional and can be selected here.

Figure 6-26 Header Utilities

The screenshot shows the navigation path: Source > Modulation Setup > ARB > Header Utilities. The 'Header Utilities' window displays 'File Header Information: WLAN_11G.WFM' and a table comparing 'File Settings' and 'Current Settings'.

Fields	File Settings	Current Settings
Description		----
Sample Rate	80.00000000000000 MHz	80.0000000000 MHz
Runtime Scaling	70.000	70.00 %
RMS	0.341	0.341
Marker 1 Polarity	Positive	Negative
Marker 2 Polarity	Positive	Positive
Marker 3 Polarity	Positive	Negative
Marker 4 Polarity	Positive	Positive
ALC Hold Routing	Marker 2	Marker 2
RF Blanking Routing	Marker 2	Marker 2
BB Frequency Offset	0.000000000000000 Hz	0.000 Hz
AWGN State	Off	----
AWGN C/N Ratio	20.00dB	----
AWGN Carrier BW	16.250 MHz	----
AWGN Noise BW	Unspecified	----
AWGN Carrier RMS	Unspecified	----
Over-Range Protection	Unspecified	----
Unique Waveform ID	151790590	----
License Required	Yes, Required licenses installed	----

7 Windows Operating System

The following topics can be found in this section:

[“Navigating Windows Without a Mouse” on page 186](#)

[“Remote Desktop: Using the Test Set Remotely” on page 187](#)

[“Programmatic Control of the Test Set” on page 202](#)

[“Capturing/Printing Displays and Windows” on page 203](#)

[“Windows Shortcuts and Miscellaneous Tasks” on page 204](#)

Navigating Windows Without a Mouse

Table 7-1 Key functions

Key Presses	Actions
Esc	Exits/closes a Windows dialog box (does not exit an Application window)
Enter	Does the current "default action". If a menu item or a button is currently highlighted, then the Enter key activates that menu item or button.
Alt	Moves focus/control to the pull down menus bar in the active Window
Right Arrow	In pull-down menu: opens the next menu to the right, or opens a submenu In a dialog box: selects an option button
Left Arrow	In pull-down menu: opens the next menu to the left, or opens a submenu In dialog box: selects an option button
Up Arrow	In pull-down menu: Moves to next selection up in the menu In dialog box: selects an option button
Down Arrow	In pull-down menu: Moves to next selection down in the menu In dialog box: selects an option button
Tab	In dialog box: moves to the next/previous field
Del	Deletes the currently selected item
Alt + Tab	Switches between the next/previous Application
Alt + Enter	Shows the Properties of the currently selected item
Alt + Esc	Cycles through items in the order that they had been opened
Backspace	In My Computer or Windows Explorer: move up one level In Internet Explorer: works like the BACK arrow key
Ctrl + Left arrow	Moves to the left one word at a time
Ctrl + Right arrow	Moves to the right one word at a time
Ctrl + Tab	In dialog box: moves to the next/previous Tab location
Alt + Space	Opens the window control menu for the currently active window, allowing you to minimize, maximize, move and restore (size) the window
Ctrl + Esc	Opens the Windows Start Menu
Ctrl + Alt + Delete	Opens the Windows Task Manager

Remote Desktop: Using the Test Set Remotely

Windows Remote Desktop is recommended for remote control of the test set.

NOTE

The Remote Desktop functionality is a Microsoft Windows capability. The following discussion provides some guidelines for using this capability with the test set. You need to refer to the Windows help documentation for more information. As Windows evolves, these instructions may no longer be exact.

Overview of Remote Desktop operation

Using the Remote Desktop functionality of the test set allows you to control and interact with the test set from a remote computer, as though you were sitting in front of the test set.

When you have configured the test set for remote connectivity, and configured a separate computer to act as a Remote Desktop Host, you can send commands to the test set from the remote computer, and you can see the test set display on the screen of the remote computer.

This section provides full details of how to set up the test set for remote connectivity, and also how to set up a computer running any 32-bit version of Microsoft Windows as a Remote Desktop Host.

Setting up Remote Desktop operation

Setting up the test set

Before the test set can be controlled through a Remote Desktop Connection, it must be set up to allow connection from a remote computer.

Table 7-2

Setting up a remote desktop connection

Step	Notes
1	To perform this operation successfully, you must have Administrator level access to the test set.
2	On the test set, open the Windows Control Panel . Using the Virtual Front Panel within the test set application, press System > Control Panel . Or, from the Windows Desktop, click Start > Control Panel .
3	Within the Control Panel , select System > System and Security .
4	Click Remote Settings . A System Properties window appears, with the Remote tab displayed.
5	Check the box labeled Allow Remote Assistance connections to this computer, if it is not already checked.
6	To add users, click Select Users > Add . Follow the on-screen instructions.

Setting up the remote computer

The procedure depends on whether the Remote Computer to be set up is running Windows XP, Windows 7, or another version of Microsoft Windows.

Remote computer running Windows XP or Windows 7

Windows XP and Windows 7 include the Remote Desktop Connectivity Client software, so no additional setup is required.

Remote computer running another version of Windows

You can use any 32-bit version of Windows (Windows 95, 98, ME, NT4, or 2000) to install and run the Client software for Remote Desktop Connectivity. However, you need to have available a Windows XP or Windows 7 installation CD-ROM, because that contains the Client software.

NOTE

The following instructions relate to software provided by Microsoft Corporation. Keysight offers no warranty regarding the operation of such software. The procedure described here may be changed by Microsoft at some future time.

Table 7-3 **Installing the Client software**

Step	Notes
1 When the Welcome Screen appears, click Perform additional tasks .	
2 From the What do you want to do? screen, click Set up Remote Desktop Connection .	The Remote Desktop Connection InstallShield Wizard appears.
3 Click Next .	Follow the on screen instructions provided by the Wizard.
4 To access the installed software, click Start > All Programs > Accessories > Communications > Remote Desktop Connection .	

How to locate the computer name of the test set

To connect a remote computer to the test set, you need to know its Computer Name. The Computer Name can be displayed as follows:

Table 7-4 **Locating the name from the Keysight application**

Step	Notes
1 On the test set front panel, press System > Show > System .	A page listing various parameters appears. The test set's computer name is shown in the list next to the title Computer Name.

Table 7-5 **Locating the name from the Windows desktop (with a mouse)**

Step	Notes
1 Click Start > Control Panel .	In the Control Panel window, select System and Security > System .
2 The computer name is displayed in the System window, under the heading "Computer name, domain, and workgroup settings".	The computer name is listed as Full computer name .

Table 7-6 **Locating the name from the Windows desktop (without a mouse)**

Step	Notes
1 Press Ctrl+Esc to display the Windows Start menu.	
2 Use the Up Arrow or Down Arrow keys to select the Control Panel item.	
3 Press Enter to open the Control Panel dialog.	
4 Use the Tab key to highlight System and Security , then press Enter .	The System and Security window is displayed.
5 Use the Tab key to highlight System , then press Enter .	The System window is displayed.
6 The computer name is displayed in the System window, under the heading Computer name, domain, and workgroup settings .	The computer name is listed as Full computer name .
7 To close the Control Panel dialog: Press Alt to open the drop-down File menu Press the Down Arrow until the Close menu item is selected Press Enter to close the Control Panel dialog.	

Running a Remote Desktop session

Initializing a Remote Desktop session

NOTE

To initialize a Remote Desktop Session, you need to know the Computer Name of the test set. This information can be shown on the test set display by following the procedure in the section **“How to locate the computer name of the test set” on page 189.**

After setting up both the test set and the remote computer for Remote Desktop Connectivity, as described in **“Setting up Remote Desktop operation” on page 188,** you are ready to start a Remote Desktop session.

Table 7-7

Starting a session

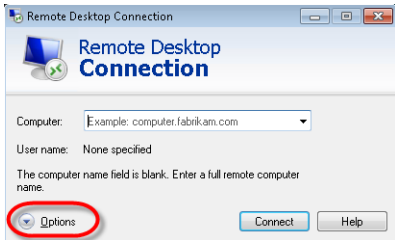
Step	Notes
1 Click Start > All Programs > Accessories > Remote Desktop Connection.	A Remote Desktop Connection dialog appears: 
2 Enter the computer name or IP address of the test set.	
3 Click Connect.	A login dialog box appears.
4 Enter the login account name and password.	The default account name is <i>Instrument</i> and the default password is <i>measure4u</i> , but these parameters may be changed by instrument users.

NOTE

Only the current User or an Administrator can remotely log into the test set. To see who the current user of the test set is, press **Ctrl+Esc** on the test set until you can view the current user name on the Start menu. If no one is currently logged into the test set, any valid instrument user can remotely log in.

The test set display appears on the screen of the remote computer. Because the test set front-panel keys are not available when using the test set remotely, three alternative methods are available to perform the functions of the front-panel keys, as detailed in the following sections:

- **“Accessing menus for Remote Desktop operation” on page 195**
- **“Keycode commands for Remote Desktop operation” on page 196**
- **“The Virtual Front Panel” on page 201**

Setting Remote Desktop options

Table 7-8 Setting options

Step	Notes
1 On the Remote Desktop Connection window, click Options . The window expands vertically to show several configuration tabs.	
2 Under the General tab, ensure that the Computer name, User name and Domain name are set correctly.	The Options dialog has several tabs. Generally, the default settings are correct.
	You may choose to enter the password and save it for future sessions, by checking the Save my password box.

Table 7-8 **Setting options**

Step	Notes
<p>3 Click the Display tab.</p> <p>Under Remote desktop size, you may select the size of the window in which the test set display appears. Do not select any size smaller than 1024 x 768 pixels. Selecting a remote desktop size smaller than 1024 x 768 results in the test set display not being fully visible. In such circumstances, scroll bars do not appear, so portions of the display are not accessible.</p> <p>Under Colors, you may select any setting that uses 15 bits or more. Selecting a color setting that uses less than 15 bits results in dithering and incorrect color rendition of the remote desktop window.</p>	
<p>4 Click the Local Resources tab.</p> <p>Click the More button to see a selection of local resources; selecting the Drives checkbox enables you to transfer data between the remote desktop and the local PC.</p> <p>To transfer data, click Start on the task bar of the remote computer, then click My Computer. Explorer opens on the remote computer and displays the drives of both the remote computer and the local computer. You can now copy and paste between the two disk drives.</p>	

Table 7-8 **Setting options**

Step	Notes
5 Click the Experience tab.	To Optimize the performance of the Remote Desktop session, choose the appropriate connection format from the drop-down list.

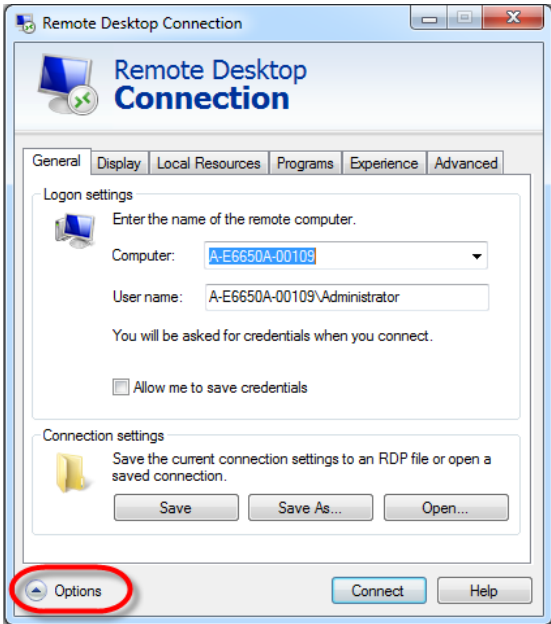
The screenshot shows the 'Remote Desktop Connection' dialog box with the 'Experience' tab selected. The 'Performance' section is expanded, showing a dropdown menu for 'Choose your connection speed to optimize performance.' set to 'LAN (10 Mbps or higher)'. Below this, a list of features is shown with checkboxes: Desktop background, Font smoothing, Desktop composition, Show window contents while dragging, Menu and window animation, Visual styles, and Persistent bitmap caching. All these checkboxes are checked. At the bottom of the Performance section, there is a checkbox for 'Reconnect if the connection is dropped', which is also checked. The 'Options' button is visible at the bottom left, and 'Connect' and 'Help' buttons are at the bottom right.

Accessing menus for Remote Desktop operation

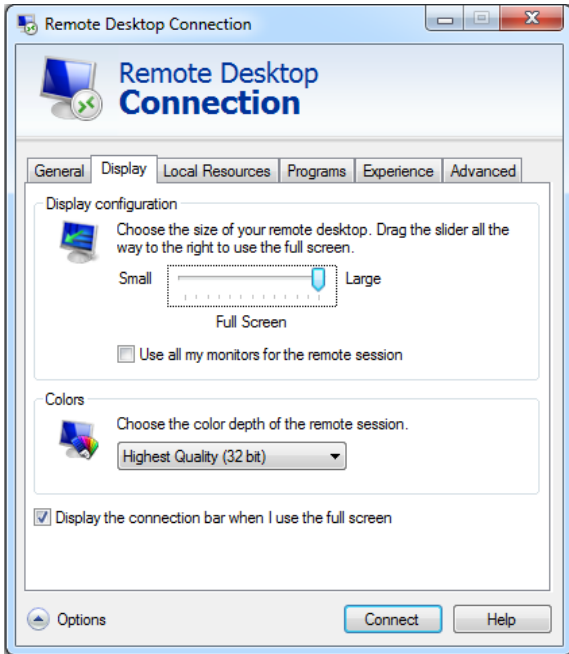
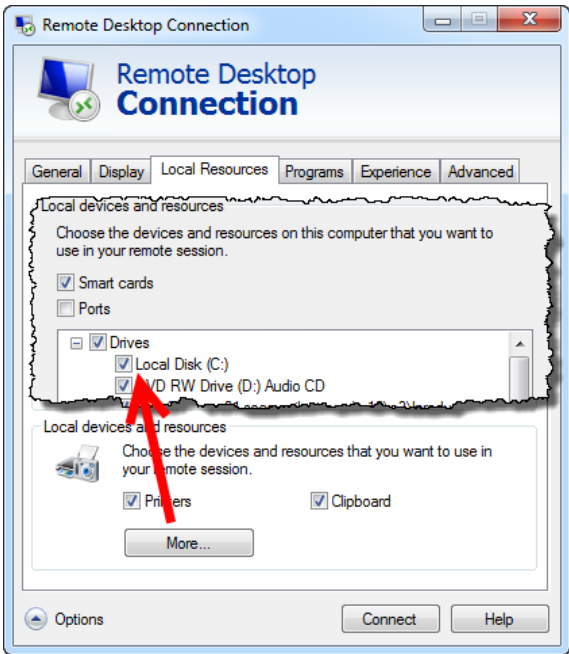
Using the mouse, right-click the application display window to access the following remote desktop menus:

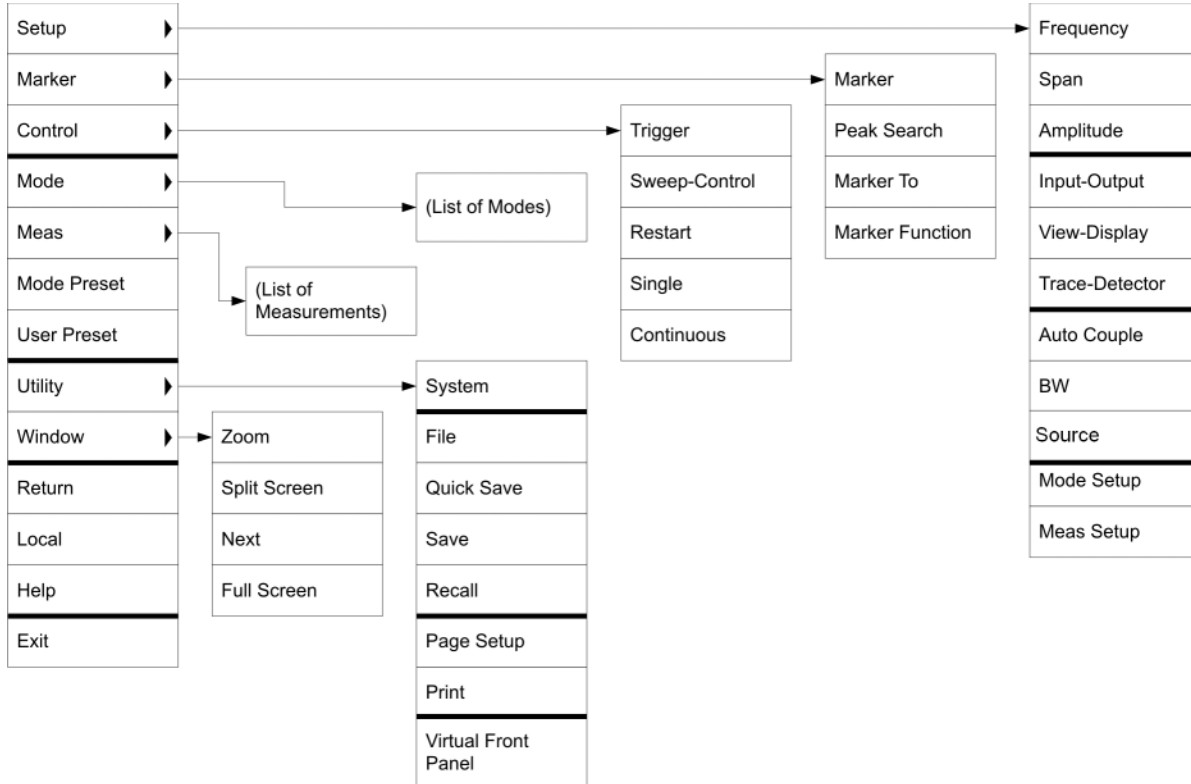

The function of each selection in the menu is generally identical to that of the corresponding Virtual Front Panel key. The following lists additional functionality:

Exit – Selecting this item closes the Application software.

Utility > Page Setup – Selecting this item opens a printer setup dialog.

Utility > Virtual Front Panel – Selecting this item opens the Virtual Front Panel window, as described in the Section **“The Virtual Front Panel” on page 201**.

NOTE

The menus are also available when using the test set directly, provided that a mouse or other pointing device is attached to it.

Keycode commands for Remote Desktop operation

When using the test set in remote desktop mode, the following combinations of remote keyboard keys can be used to perform the operation of the virtual front-panel keys.

Figure 7-1 Keycodes

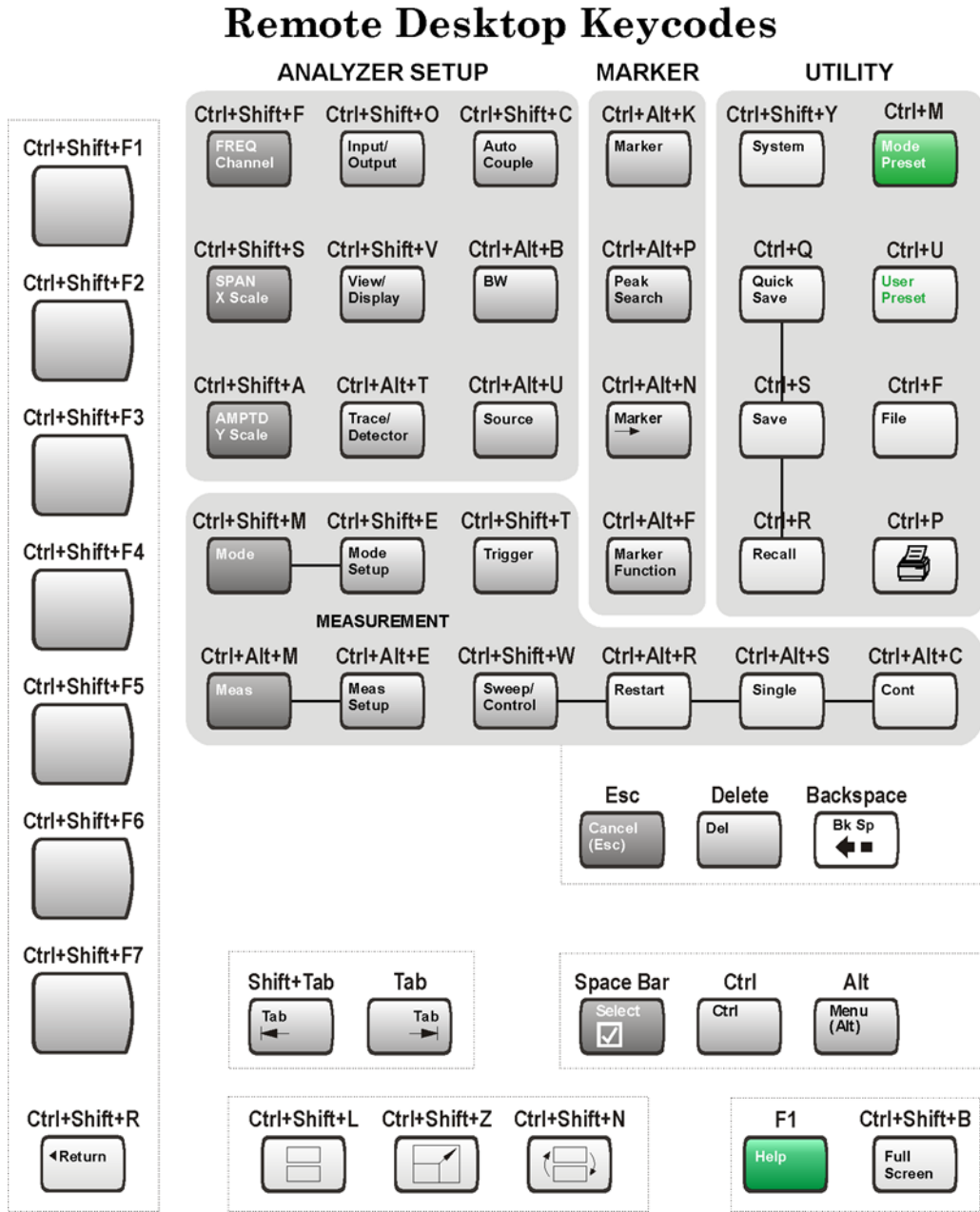

Table 7-9 Keycode commands

To initiate the following virtual key:	Press these keys on the remote computer keyboard:
AMPTD Y Scale	Ctrl+Shift+A
Auto Couple	Ctrl+Shift+C
Bk Sp	Backspace
BW	Ctrl+Alt+B
Cancel (Esc)	Esc
Cont	Ctrl+Alt+C
Ctrl	Ctrl
Decrease Audio Volume	Volume Control slider
Del	Delete
Down Arrow	Down Arrow
Enter	Enter (Return)
File	Ctrl+F
FREQ Channel	Ctrl+Shift+F
Full Screen	Ctrl+Shift+B
Help	F1
Increase Audio Volume	Volume Control slider
Input/Output	Ctrl+Shift+O
Left Arrow	Left Arrow
Marker	Ctrl+Alt+K
Marker ->	Ctrl+Alt+N
Marker Function	Ctrl+Alt+F
Meas	Ctrl+Alt+M
Meas Setup	Ctrl+Alt+E
Menu (Alt)	Alt
Mode	Ctrl+Shift+M
Mode Preset	Ctrl+M
Mode Setup	Ctrl+Shift+E

Table 7-9

Keycode commands

To initiate the following virtual key:	Press these keys on the remote computer keyboard:
Mute	Mute checkbox under the Volume Control
Next Window	Ctrl+Shift+N
Peak Search	Ctrl+Alt+P
Print	Ctrl+P
Quick Save	Ctrl+Q
Recall	Ctrl+R
Restart	Ctrl+Alt+R
Return	Ctrl+Shift+R
Right Arrow	Right Arrow
Save	Ctrl+S
Select	Space Bar
Single	Ctrl+Alt+S
Softkey 1	Ctrl+Shift+F1
Softkey 2	Ctrl+Shift+F2
Softkey 3	Ctrl+Shift+F3
Softkey 4	Ctrl+Shift+F4
Softkey 5	Ctrl+Shift+F5
Softkey 6	Ctrl+Shift+F6
Softkey 7	Ctrl+Shift+F7
Source	Ctrl+Alt+U
SPAN X Scale	Ctrl+Shift+S
Split Screen	Ctrl+Shift+L
Sweep/Control	Ctrl+Shift+W
System	Ctrl+Shift+Y
Tab	Tab
Trace/Detector	Ctrl+Alt+T
Trigger	Ctrl+Shift+T

Table 7-9 **Keycode commands**

To initiate the following virtual key:	Press these keys on the remote computer keyboard:
Up Arrow	Up Arrow
User Preset	Ctrl+U
View/Display	Ctrl+Shift+V
Zoom	Ctrl+Shift+Z
1	1^a
2	2^a
3	3^a
4	4^a
5	5^a
6	6^a
7	7^a
8	8^a
9	9^a
-	Use the - key to enter a negative value, as appropriate^a
.(Decimal Point)	.(Period)^a
0 (Zero)	0 (Zero)^a

a. For remote keyboards that feature a numeric keypad, use either the appropriate numeric keypad key or the main keypad key.

NOTE

The effect of pressing **Ctrl+Alt+Delete** on the keyboard of the remote computer *always* applies to the remote computer, and not to the test set. Generally, the effect of pressing this key combination is to display the Windows Task Manager. Therefore, pressing this key combination on the remote computer does *not* allow you to reboot the test set.

Ending a Remote Desktop session

There are two ways to disconnect the remote computer from the test set to end the session:

Table 7-10 **Ending the session**

Step	Notes
1 Click the X, then click OK.	For full-screen, the X appears at the top center of the window. For non full-screen, the X appears in a red box at the right of the window's title bar.
2 Or, when the remote desktop is full screen, move the cursor to the bottom left of the window. Click Start > Disconnect . Click Disconnect .	You are asked to confirm that you want to disconnect.

The Virtual Front Panel

The Virtual Front Panel is a software equivalent of the front-panel key set, which provides another alternate method for test set control. It may be displayed in a separate window on the test set (or remote desktop) display.

NOTE

The Virtual Front Panel is also available when using the test set directly, provided that a mouse or other pointing device is attached to it.

Using the mouse, right-click the application display window, then select **Utility** > **Virtual Front Panel**. The Virtual Front Panel appears, as shown below:

Figure 7-2

Virtual front panel keys

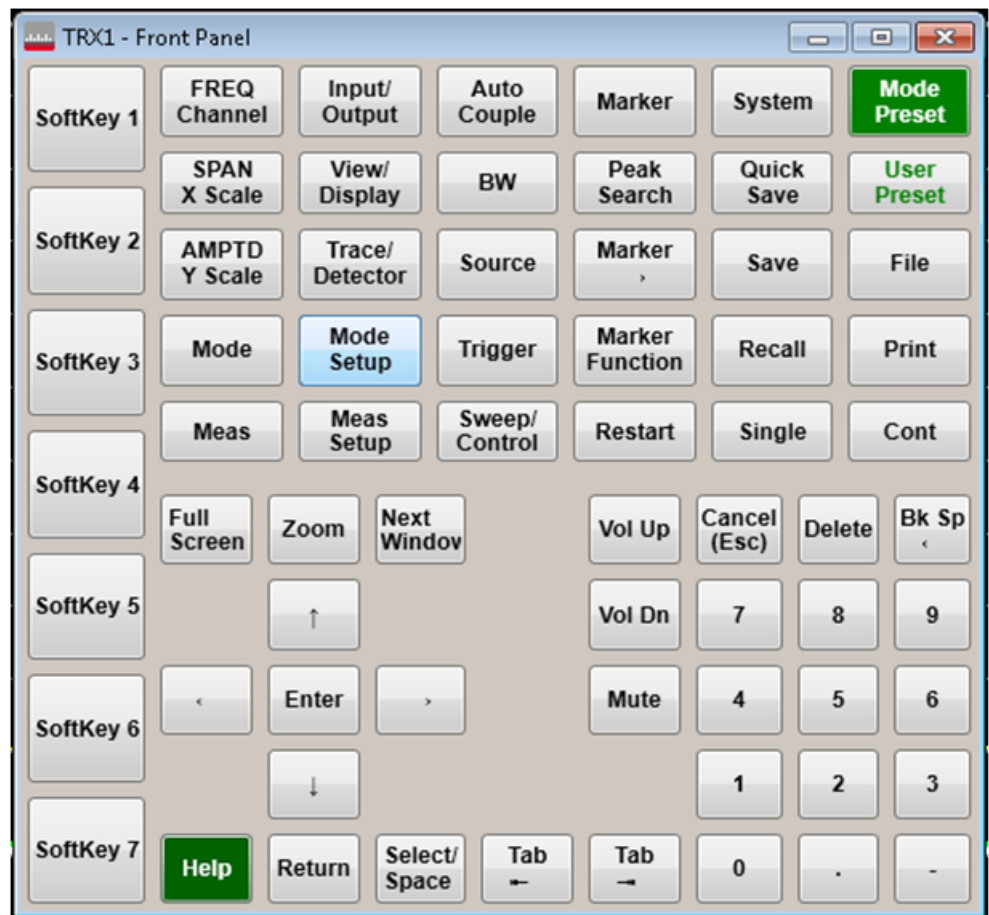

When you click a button in the Virtual Front Panel, it performs the operation of the corresponding test set front-panel key. The buttons at the left of the panel, named **Softkey 1** through **Softkey 7**, perform the operation of the respective softkeys. The **Up** and **Down** keys perform the operation of the knob.

Programmatic Control of the Test Set

For information on how to send commands to the test set, using a VISA connection, see the X-Series Signal Analyzer Programmer's Guide, which is available online at:

http://www.keysight.com/find/mxa_manuals

NOTE

The individual TRX instruments within the test set chassis are controlled using separate VISA connections; see **"TRX Selection" on page 38**.

Capturing/Printing Displays and Windows

You need an external keyboard and mouse to use this feature.

Table 7-11 **Saving the desktop**

Step	Notes
1 Press Print Screen on the external keyboard.	This captures the desktop and saves it on the Windows clipboard.
2 Open a graphics application, such as Microsoft Paint.	
3 Paste the clipboard contents into the application window.	The keyboard shortcut Ctrl + v will paste the contents of the clipboard.
4 Save the image in a file, and/or print it.	

Table 7-12 **Saving the currently active window**

Step	Notes
1 Click on the window you want to capture.	This activates the window.
2 Press Alt + Print Screen on the external keyboard.	This captures the window and saves it on the Windows clipboard.
3 Open a graphics application, such as Microsoft Paint.	
4 Paste the clipboard contents into the application window.	The keyboard shortcut Ctrl + v will paste the contents of the clipboard.
5 Save the image in a file, and/or print it.	

Windows Shortcuts and Miscellaneous Tasks

This section provides a list of Windows shortcuts (key combinations) that are useful when you operate the test set without an attached mouse and keyboard. (See also “[Navigating Windows Without a Mouse](#)” on page 186.) Although these shortcuts are available in any Windows system, they are not commonly used when a mouse and keyboard are attached.

Windows shortcuts (key combinations)

You can use the following combinations of front panel keys to perform basic Windows tasks when using the test set without an attached mouse and keyboard.

Table 7-13 Windows shortcut key combinations

To do the following:	Press:
Display the Windows Start Menu	Ctrl+Esc
Cycle through all open applications	Alt+Tab
Select the first menu of a menu bar	Alt
Move through menu headings	Left Arrow, Right Arrow
Open (drop down) a menu	Down Arrow
Move through items in an expanded menu	Up Arrow, Down Arrow
Close the current menu selection	Esc
Cancel the current menu bar selection	Alt
Open an application's control menu (usually the left-most menu on the menu bar, starting with F ile)	Alt+Select
In a dialog: move between tabs	Ctrl+Tab
In a dialog: move forward through dialog box items	Tab
In a dialog: move backward through dialog box items	Shift+Tab
In a dialog: open a list box	Alt+Down Arrow
In a dialog list box or check box: select or deselect items	Select
In a dialog list box or check box: select or deselect one item at a time	Shift+Up Arrow, Shift+Down Arrow
In My Computer , expand a selected folder	Enter
In My Computer , open a folder one level up from the current folder	Bk Sp

Navigating an Application Menu without a Mouse or Keyboard

This example uses Microsoft Excel, but you can use a similar sequence of operations to select and execute any menu item of any application.

To select and execute the item **Sheet > Rename** option from the **Format** menu in the menu bar shown below,

Figure 7-3 Format > Sheet > Rename

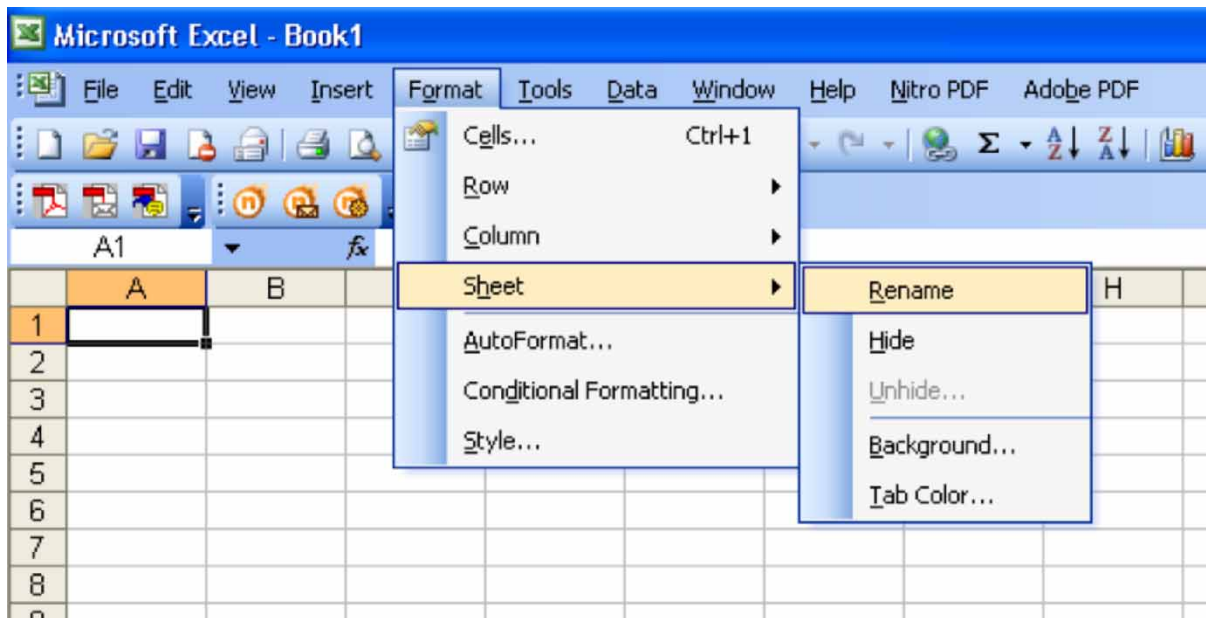

perform the following operations:

Table 7-14 Changing the sheet name

Step	Notes
1 Press Alt to select the File menu in the menu bar.	The focus must be in the appropriate window.
2 Use the Right Arrow and Left Arrow keys to move horizontally to the Format menu.	
3 Press the Down Arrow to expand the Format menu.	
4 Use the Down Arrow and Up Arrow keys to move vertically to the Sheet menu item.	
5 Press the Right Arrow key to expand the Sheet sub-menu.	The Rename sub-menu item appears already selected. If another item in the same sub-menu is required, use the Down Arrow and Up Arrow keys to move vertically to that item.
6 Press Enter to execute the selected action.	

Windows taskbar auto-hide feature

The Windows taskbar should always be in the auto-hide mode when using the test set application. If the taskbar is not set to auto-hide, the lower part of the test set display is obscured by the taskbar.

If a mouse is attached to the test set, and you move the mouse cursor to the bottom of the display (either deliberately or accidentally), the taskbar automatically appears. Provided that the taskbar is in auto-hide mode, you can make it disappear again by moving the mouse cursor away from the bottom of the screen.

If at any time the Windows taskbar is inadvertently set to the non-auto-hide mode, you can restore the auto-hide behavior by doing the following:

Table 7-15 Restoring taskbar auto-hide mode

Step	Notes
1 Click Start > Control Panel	If not using a mouse, press Ctrl+Esc .
2 Click Appearance and Personalization, Taskbar and Start Menu .	If you are not using a mouse, use the shortcut key combinations specified in the Section “Windows shortcuts (key combinations)” on page 204 to make these selections.
3 Click the Taskbar tab.	The Taskbar and Start Menu Properties dialog appears.

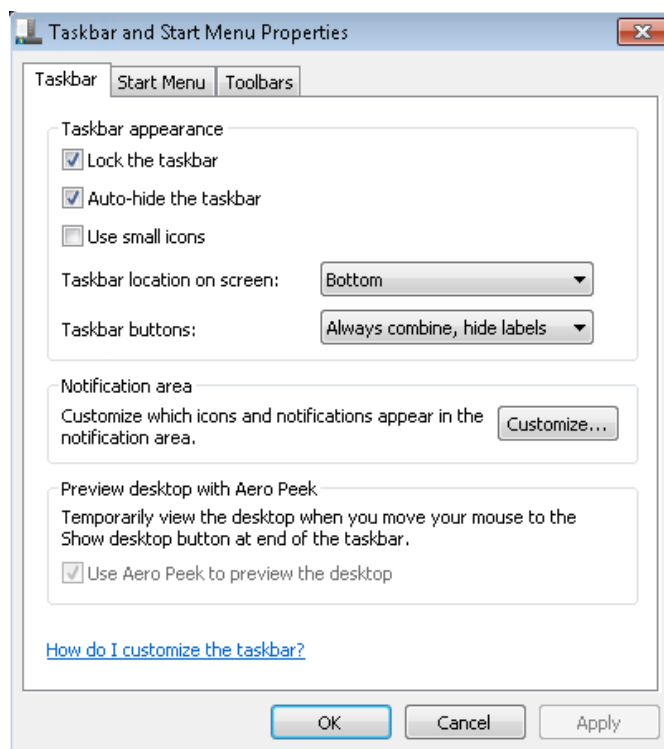

Table 7-15 **Restoring taskbar auto-hide mode**

Step	Notes
4 Select the Auto-hide the taskbar check box.	If you are not using a mouse, press Tab repeatedly until the auto-hide option is selected, then press Select to toggle the check box state.
5 Click OK .	This applies the change and closes the dialog box.

Windows startup folder

All Windows systems include a special folder, called the Startup folder. If a program, or a shortcut to a program, is placed in the Startup folder (either by Windows itself, or by a third-party application, or by any user), that program automatically runs every time Windows is restarted.

When your test set is first configured by Keysight, shortcuts to the appropriate application software and supporting programs are placed in the Startup folder. The exact contents of the Startup folder depends on the options you purchased with your test set.

NOTE

You should *never* delete items that appear in the Startup folder, or move any item from the Startup folder to another folder. Deleting or moving any item in the Startup folder may cause applications not to start automatically when Windows is restarted, or may cause certain options to be unavailable when using the test set.

If you wish to view the contents of the Startup folder, do one of the following:

- Either click **Start, All Programs**, then select **Startup**,
or,
- Click **Start, My Computer**, then navigate to the folder:
C:\Documents and Settings\All Users\Start Menu\Programs\Startup.

Additional startup items may also appear in the corresponding startup folder for the user that is currently logged on. For example, the startup folder for the **administrator** user is **C:\Documents and Settings\administrator\Start Menu\Programs\Startup**.

8 Troubleshooting

The following topics can be found in this section:

[“Check the Basics” on page 210](#)

[“Problems with Microsoft Windows Operating System” on page 212](#)

[“Returning a test set for Service” on page 213](#)

WARNING

No operator serviceable parts inside. Refer servicing to qualified personnel. To prevent electrical shock do not remove covers.

Check the Basics

- Is there power at the receptacle?
- Is the test set turned on? Check to see if the blue power light and the green fan LEDs beside the power switch are on and steady. Also, listen for internal fan noise to determine if the test set cooling fans are running.
- If other equipment, cables, and connectors are being used with your test set, make sure they are connected properly and operating correctly.
- If the test set cannot completely load or run the operating system, or the instrument application is not successfully launched, the problem could be a corrupt hard drive. If the test set gets far enough along in the boot process to run the "Keysight Recovery System", perform the **"Hard Drive Recovery Process" on page 85**. (The bootup process will be visible only if you have connected an external monitor.)
- Is the Measurement Application running? If not, there is a software launch shortcut/icon on the desktop.
- Does the test set application have the focus? (That is, is the blue window banner highlighted?) If not, move focus to the application with Alt-Tab.
- Review the measurement procedures being performed when the problem first appeared. Are all of the settings correct?
- If the test set is not functioning as expected, return the test set to a known state by pressing Mode Preset.

NOTE

Some test set settings are not affected by a Preset. If you wish to reset the test set settings, press **System > Power On > Restore Power On Defaults**.

- Is the measurement being performed, and the results that are expected, within the specifications and capabilities of the test set? Refer to the specifications in the data sheet for your test set, which is available on the Keysight website:
<http://www.keysight.com/find/e6640a>
- If the test set is not communicating via the LAN connection, check the LAN cable connection at the front panel.
- To meet specifications, the test set must be aligned. Either the Auto Align (On) feature must be selected (press **System > Alignments > Auto Align > Normal**), or the test set must be manually aligned.
- Perform an Alignment. Press **System > Alignments > Align Now > All**.

- If the previously performed alignments did not resolve the problem, press **System >Alignments > Restore Align Defaults**. Then press **System >Alignments > Align Now >All**.

NOTE

The test set must be powered on for 45 minutes prior to performing alignments.

-
- Is the test set displaying an error message? If so, refer to the Instrument Messages Guide.
 - Check if the external frequency reference is selected but not available. Verify that it is selected by pressing **Input/Output > Freq Ref In**. If **External** is selected, changing the setting to **Sense** allows the test set to sense the presence of an external reference and use it only if it is available. The frequency of the reference should be set correctly.
 - If you are using a Windows program, other than the test set application, you may notice it running slow. Place the test set application in single sweep/measurement.

Problems with Microsoft Windows Operating System

The Microsoft Windows operating system settings have been optimized for the best performance. Modification of these settings may degrade test set performance and measurement speed. Those that can be safely modified are described in **“Settings that can be changed” on page 73**.

The E6640A EXM Wireless Test Set operates in an open Windows environment, so you can install software on the test set. However, installation of non-approved software may affect test set performance. Keysight does not warrant the performance with non-approved software installed.

Returning a test set for Service

Read the Warranty

The warranty for your test set is in the front of your Specifications Guide. Please read it and become familiar with its terms.

If your test set is covered by a separate maintenance agreement, please be familiar with its terms.

Service Options

Keysight Technologies offers several optional maintenance plans to service your test set after the warranty has expired. Call your Keysight Technologies office for full details.

Calling Keysight Technologies

Keysight Technologies has offices around the world to provide you with complete support for your test set. To obtain servicing information or to order replacement parts, contact the nearest Keysight Technologies office listed in the following table. In any correspondence or telephone conversations, refer to your test set by its product number, full serial number, and software revision.

Press **System >Show > System**, and the product number, serial number, and software revision information is displayed on your test set screen. A serial number label is also attached to the rear panel of the test set.

Locations for Keysight Technologies

For a listing of service locations, see <http://www.keysight.com/find/assist>

Contact us: <http://www.keysight.com/find/contactus>

Packaging the Test Set

Use original packaging or comparable. It is best to pack the unit in the original factory packaging materials if they are available.

CAUTION

Test set damage can result from using packaging materials other than those specified. Never use styrene pellets in any shape as packaging materials. They do not adequately cushion the test set or prevent it from shifting in the carton. They cause test set damage by generating static electricity and by lodging in the test set louvers, blocking airflow.

You can repackage the test set with commercially available materials, as follows:

Step	Notes
1	Wrap the test set in antistatic plastic to reduce the possibility of damage caused by electrostatic discharge.
2	Use a strong shipping container. The carton must be both large enough and strong enough to accommodate the test set. A double-walled, corrugated cardboard carton with 159 kg (350 lb) bursting strength is adequate. Allow at least 3 to 4 inches on all sides of the test set for packing material.
3	Surround the equipment with three to four inches of packing material and prevent the equipment from moving in the carton. If packing foam is not available, the best alternative is plastic bubble-pak. This material looks like a plastic sheet filled with 1-1/4 inch air bubbles. Use the pink-colored bubble which reduces static electricity. Wrapping the equipment several times in this material should both protect the equipment and prevent it from moving in the carton.
4	Seal the shipping container securely with strong nylon adhesive tape.
5	Mark the shipping container "FRAGILE, HANDLE WITH CARE" to assure careful handling.
6	Retain copies of all shipping papers.



This information is subject to change without notice.

© Keysight Technologies 2014-2025

Edition 1, February 2025

E6640-90001

www.keysight.com