

Keysight M8194A 120 GSa/s Arbitrary Waveform Generator

User Guide

Notices

© Keysight Technologies 2019

No part of this manual may be reproduced in any form or by any means (including electronic storage and retrieval or translation into a foreign language) without prior agreement and written consent from Keysight Technologies as governed by United States and international copyright laws.

Trademarks

PCI Express® and PCIe® are registered trademarks of PCI-SIG.

Manual Part Number

M8194-91020

Edition

Edition 2.0, October 2019

Keysight Technologies Deutschland GmbH
Herrenberger Strasse 130,
71034 Böblingen, Germany

Technology Licenses

The hardware and/or software described in this document are furnished under a license and may be used or copied only in accordance with the terms of such license.

U.S. Government Rights

The Software is “commercial computer software,” as defined by Federal Acquisition Regulation (“FAR”) 2.101. Pursuant to FAR 12.212 and 27.405-3 and Department of Defense FAR Supplement (“DFARS”) 227.7202, the U.S. government acquires commercial computer software under the same terms by which the software is customarily provided to the public. Accordingly, Keysight provides the Software to U.S. government customers under its standard commercial license, which is embodied in its End User License Agreement (EULA), a copy of which can be

found at <http://www.keysight.com/find/sweula>. The license set forth in the EULA represents the exclusive authority by which the U.S. government may use, modify, distribute, or disclose the Software. The EULA and the license set forth therein, does not require or permit, among other things, that Keysight: (1) Furnish technical information related to commercial computer software or commercial computer software documentation that is not customarily provided to the public; or (2) Relinquish to, or otherwise provide, the government rights in excess of these rights customarily provided to the public to use, modify, reproduce, release, perform, display, or disclose commercial computer software or commercial computer software documentation. No additional government requirements beyond those set forth in the EULA shall apply, except to the extent that those terms, rights, or licenses are explicitly required from all providers of commercial computer software pursuant to the FAR and the DFARS and are set forth specifically in writing elsewhere in the EULA. Keysight shall be under no obligation to update, revise or otherwise modify the Software. With respect to any technical data as defined by FAR 2.101, pursuant to FAR 12.211 and 27.404.2 and DFARS 227.7102, the U.S. government acquires no greater than Limited Rights as defined in FAR 27.401 or DFAR 227.7103-5 (c), as applicable in any technical data.

Warranty

THE MATERIAL CONTAINED IN THIS DOCUMENT IS PROVIDED "AS IS," AND IS SUBJECT TO BEING CHANGED, WITHOUT NOTICE, IN FUTURE EDITIONS. FURTHER, TO THE MAXIMUM EXTENT PERMITTED BY APPLICABLE LAW, KEYSIGHT DISCLAIMS ALL WARRANTIES, EITHER EXPRESS OR IMPLIED WITH REGARD TO THIS MANUAL AND ANY INFORMATION CONTAINED

HEREIN, INCLUDING BUT NOT LIMITED TO THE IMPLIED WARRANTIES OF MERCHANTABILITY AND FITNESS FOR A PARTICULAR PURPOSE. KEYSIGHT SHALL NOT BE LIABLE FOR ERRORS OR FOR INCIDENTAL OR CONSEQUENTIAL DAMAGES IN CONNECTION WITH THE FURNISHING, USE, OR PERFORMANCE OF THIS DOCUMENT OR ANY INFORMATION CONTAINED HEREIN. SHOULD KEYSIGHT AND THE USER HAVE A SEPARATE WRITTEN AGREEMENT WITH WARRANTY TERMS COVERING THE MATERIAL IN THIS DOCUMENT THAT CONFLICT WITH THESE TERMS, THE WARRANTY TERMS IN THE SEPARATE AGREEMENT WILL CONTROL.

Safety Notices

CAUTION

A CAUTION notice denotes a hazard. It calls attention to an operating procedure, practice, or the like that, if not correctly performed or adhered to, could result in damage to the product or loss of important data. Do not proceed beyond a CAUTION notice until the indicated conditions are fully understood and met.

WARNING

A WARNING notice denotes a hazard. It calls attention to an operating procedure, practice, or the like that, if not correctly performed or adhered to, could result in personal injury or death. Do not proceed beyond a WARNING notice until the indicated conditions are fully understood and met.

Safety Summary

The following general safety precautions must be observed during all phases of operation of this instrument. Failure to comply with these precautions or with specific warnings or operating instructions in the product manuals violates safety standards of design, manufacture, and intended use of the instrument. Keysight Technologies assumes no liability for the customer's failure to comply with these requirements. Product manuals are provided with your instrument on CD-ROM and/or in printed form. Printed manuals are an option for many products. Manuals may also be available on the Web. Go to www.keysight.com and type in your product number in the Search field at the top of the page. Safe operation and the general safety precautions for the M9502A and M9505A AXIe chassis, must be followed. See: <http://www.keysight.com/find/M9505A>.

WARNING

To ensure mandatory safety requirements are being met, the module must be installed in a chassis which has been certified and marked by a Nationally Recognized Testing Lab (such as CSA, UL, TUV, ETL etc.) in which all the means of protection are properly implemented.
NOTE: CE marking alone is not adequate.

NOTE

This product has been designed and tested in accordance with accepted industry standards, and has been supplied in a safe condition. The documentation contains information and warnings that must be followed by the user to ensure safe operation and to maintain the product in a safe condition.

Initial Inspection

Inspect the shipping container for damage. If there is damage to the container or cushioning, keep them until you have selected the contents of the shipment for completeness and verified the instrument both mechanically and electrically. The Performance Tests give procedures for checking the operation of the instrument. If the contents are incomplete, mechanical damage or defect is apparent, or if an instrument does not pass the operator's checks, notify the nearest Keysight Technologies Sales/Service Office.

WARNING To avoid hazardous electrical shock, do not perform electrical tests when there are signs of shipping damage to any portion of the outer enclosure (covers, panels, etc.).

General

This product is a Safety Class 3 instrument (provided with a protective earth terminal). The protective features of this product may be impaired if it is used in a manner not specified in the operation instructions.



ESD Sensitive Device	All front-panel connectors of the M8194A are sensitive to Electrostatic discharge (ESD). There are also several exposed components on the PCAs, on both sides of M8194A, which can be touched accidentally while handling the unit and can risk damage to the instrument, due to ESD. It is recommend to operate the instrument in an electrostatic safe environment. There is a risk of instrument malfunction when touching a connector or side components. Please follow this instruction: Before touching the unit, discharge yourself by touching the properly grounded mainframe.
Environment Conditions	<p>This instrument is intended for indoor use in an installation category II, pollution degree 2 environment. It is designed to operate within a temperature range of 0 °C – 40 °C (32 °F – 105 °F) at a maximum relative humidity of 80% and at altitudes of up to 2000 meters.</p> <p>This module can be stored or shipped at temperatures between -40 °C and +70 °C. Protect the module from temperature extremes that may cause condensation within it.</p>
Before Applying Power	Verify that all safety precautions are taken. The power cable inlet of the instrument serves as a device to disconnect from the mains in case of hazard. The instrument must be positioned so that the operator can easily access the power cable inlet. When the instrument is rack mounted the rack must be provided with an easily accessible mains switch.
Line Power Requirements	The Keysight M8194A operates when installed in an Keysight AXIe mainframe.
Do Not Operate in an Explosive Atmosphere	Do not operate the instrument in the presence of flammable gases or fumes.
Do Not Remove the Instrument Cover	<p>Operating personnel must not remove instrument covers. Component replacement and internal adjustments must be made only by qualified personnel.</p> <p>Instruments that appear damaged or defective should be made inoperative and secured against unintended operation until they can be repaired by qualified service personnel.</p>
Ground the Instrument	To minimize shock hazard, the instrument chassis and cover must be connected to an electrical protective earth ground. The instrument must be connected to the ac power mains through a grounded power cable, with the ground wire firmly connected to an electrical ground (safety ground) at the power outlet. Any interruption of the protective (grounding) conductor or disconnection of the protective earth terminal will cause a potential shock hazard that could result in personal injury.

Instrument Markings

The **Table 1** lists the definitions of markings that may be on or with the product.



Table 1 Instrument Markings

Marking	Description
	<p>The instruction documentation symbol. The product is marked with this symbol when it is necessary for the user to refer to the instruction in the documentation.</p>
	<p>Frame or chassis ground terminal. Typically connects to the equipment's metal frame.</p>
	<p>South Korean Certification (KC) mark; includes the marking's identifier code which follows this format: R-R-Kst-<u>ZZZZZZZZZZZZZZ</u></p>
	<p>Indicates that anti-static precautions should be taken.</p>
	<p>China Restricted Substance Product Label. The EPUP (environmental protection use period) number in the center indicates the time period during which no hazardous or toxic substances or elements are expected to leak or deteriorate during normal use and generally reflects the expected useful life of the product.</p>
	<p>The RCM mark is a registered trademark of the Australian Communications and Media Authority.</p>
	<p>The CSA mark is a registered trademark of the CSA International.</p>

Marking	Description
	The CE mark is a registered trademark of the European Community (if accompanied by a year, it is the year when the design was proven). This product complies with all relevant directives.
	Universal recycling symbol. This symbol indicates compliance with the China standard GB 18455-2001 as required by the China RoHS regulations for paper/fiberboard packaging.
	The Keysight email address is required by EU directives applicable to our product.

Compliance and Environmental Information

Table 2 Compliance and Environmental Information

Safety Symbol	Description
	<p>This product complies with WEEE Directive (2002/96/EC) marking requirements. The affixed label indicates that you must not discard this electrical/electronic product in domestic household waste.</p> <p>Product Category: With reference to the equipment types in WEEE Directive Annex I, this product is classed as a "Monitoring and Control instrumentation" product.</p> <p>Do not dispose in domestic household waste.</p>
	<p>To return unwanted products, contact your local Keysight office, or see http://about.keysight.com/en/companyinfo/environment/takeback.shtml for more information.</p>

Contents

Safety Summary	3
Instrument Markings	5
Compliance and Environmental Information	6

1 Introduction

M8194A Overview	12
Key Features	12
Supporting Operating System	13
Options	13
Upgrade Options	14
Installing Licenses	14
Front Panel	15
Instrument Modes	17
Related Documents	18
Additional Documents	18

2 M8194A Software Installation

Prerequisites	20
Installation Steps	21
Post Installation Steps	27
How to use M8194A Instrument	28

3 M8194A Soft Front Panel

Launching the M8194A Soft Front Panel	30
M8194A Soft Front Panel	33
Title Bar	34
Menu Bar	34
Tabs	36
Run / Stop Button	36
Driver Call Log	37
Errors List Window	38
Status Bar	39
Working with M8194A Front Panel	40
Numeric Control Usage	40
Tooltip	41
Output Tab	42
Clock/Sync Tab	45
Standard Waveform Tab	48
Multi-Tone Waveform Tab	56
Complex Modulated Waveform Tab	64
Serial Data Waveform Tab	75
Import Waveform Tab	84
Supported File Types	93
Correction File Format	99
Converting the 285 MHz Reference Clock into a clock suitable as DCA Precision Timebase input	101
Using M8197A module for DCA Clock and Trigger Generation	101
Using M8196A or additional M8194A	103

Synchronous Multi-Module System	105
Requirements for a Synchronous System	105
Synchronous System Cabling	105
Synchronous System Operation Modes	108
Configuring the Synchronous System	109
Stopping Synchronous Operation	110

4 Remote Programming

Remote Programming Overview	112
SCPI Programming	112
AgM8194SFP.exe	113
Command Line Arguments	113
Communication	114
Programming Recommendations	115
SCPI Basics	116
Common Commands	118
Status Model	121
:STATus:PRESet	123
Status Byte Register	123
Questionable Data Register Command Subsystem	124
Operation Status Subsystem	126
Voltage Status Subsystem	128
Frequency Status Subsystem	128
Connection Status Subsystem	129
Run Status Subsystem	129
:ABOrt Commands	131
:INITiate Commands	132
:INSTrument Commands	133
:MMEMory Commands	135
:OUTPut Commands	141

[:SOURce] Commands	143
:SYSTem Commands	150
:TEST Commands	155
:TRACe Commands	156
Multi-Module Configuration Commands	165
SCPI Command Differences Between M8194A and M8196A	168

5 M8194A Maintenance

Service and Repair	172
ESD Protection	172
Power and Ventilation Requirements	174
Thermal Protection	174
Operating Environment	174

6 Characteristics

Performance Specification	175
Operating Environment	175
General	176

7 Appendix

Resampling Algorithms for Waveform Import	178
Resampling Requirements	178
Resampling Methodology	178
Examples for Generating Waveforms	181
Generating 64 GBaud QAM Waveform	181
Importing Sample Waveform Data	182

Index

Keysight M8194A 120 GSa/s Arbitrary Waveform Generator

User Guide

1 Introduction

[M8194A Overview](#) / 12

[Key Features](#) / 12

[Supporting Operating System](#) / 13

[Options](#) / 13

[Upgrade Options](#) / 14

[Installing Licenses](#) / 14

[Front Panel](#) / 15

[Instrument Modes](#) / 17

[Related Documents](#) / 18

[Additional Documents](#) / 18

This chapter provides an overview of M8194A Arbitrary Waveform Generator.

M8194A Overview

The Keysight M8194A is a 120 GSa/s AWG (Arbitrary Waveform Generator) with highest combination of speed, bandwidth and channel density. The M8194A is ideally suited to address following key applications:

- Coherent optical – a single M8194A module can generate 2 independent I/Q baseband signals (dual polarization = 4 channels) at 64 Gbaud and beyond.
- Multi-level / Multi-channel digital signals – generate NRZ, PAM4, PAM8, DMT, etc. signals at up to 56 Gbaud. Embed/De-embed channels, add Jitter, ISI, noise and other distortions.
- Physics, chemistry, and electronics research – generate any mathematically defined arbitrary waveforms, ultra-short yet precise pulses and extremely wideband chirps.
- Wideband RF/ μ W – generate extremely wideband RF signals with an instantaneous bandwidth of DC to 32 GHz for aerospace, defense and communication applications.

Key Features

The M8194A 120 GSa/s Arbitrary Waveform Generator has the following key features:

- Sample rate up to 120 GSa/s (on each channel)
- 1, 2 or 4 differential channels on a 1-slot AXIe module enable optimized channel density
- Vertical resolution: 8 bits
- Arbitrary signal generation with frequency content up to 50 GHz
- 8-bit vertical resolution
- 512 kSamples per channel (enables PRBS $2^{15}-1$)

Supporting Operating System

The Keysight M8194A supports the following operating systems:

- Windows 10 (32 bit or 64 bit)
- Windows 8.1 (32 bit or 64 bit)
- Windows 8 (32 bit or 64 bit)
- Windows 7 (32 bit or 64 bit)

Options

The following options are available for the current release of M8194A:

Table 3 M8194A feature options

Product Number	Description	Available as SW upgrade?	Comments
M8194A-001	Arbitrary waveform generator module 1 channel, 120 GSa/s	N/A (minimum configuration)	Must order either: 001, 002, or 004
M8194A-002	Arbitrary waveform generator module 2 channels, 120 GSa/s	Yes	Must order either: 001, 002, or 004
M8194A-004	Arbitrary waveform generator module 4 channels, 120 GSa/s	Yes	Must order either: 001, 002, or 004
M8194A-BU2	Bundle consisting of one M9502A 2-slot AXIe chassis with USB option		
M8194A-BU3	Bundle consisting of one M9502A 2-slot AXIe chassis with USB option and one M9537A AXIe embedded PC controller		

Option -001, Option -002, and Option -004

With this option the number of channels is selected. The M8194A is available in a one channel (-001), two channel (-002) or 4 channel (-004) version. A software upgrade from one to two channels is possible by installing option U02. A software upgrade from two to four channels is possible by installing option U04. In order to upgrade from one to four channels, first option -U02 and next -U04 must be installed.

Upgrade Options

For the M8194A, the following upgrade options are available.

Table 4 M8194A upgrade options

Option	Description
M8194AU-U02	Upgrade from 1 channel to 2 channels
M8194AU-U04	Upgrade from 2 channels to 4 channels

Installing Licenses

After you purchase a license and you acquire the corresponding license file, you need to install the license on M8194A.

You can install the new license in the following ways:

- 1 In the **Keysight License Manager**, click the **Tools** button, and then select **Install License File....** An **Install License File(s)** window appears. In this window, browse to the location where you saved the license file. Select the license file, and then click the **Open** button.
- 2 To manually install a license by entering the appropriate license file information, click the **Tools** button, click **Install License from Text...** The **Install License from Text** dialog box appears. Type in the license data exactly as you received from Keysight. Click the **Install** button to install the license.

Once the licenses are installed, you can use the **Keysight License Manager** to view all licenses for the local system as depicted in the following figure.

Options U02 and U04 are upgradeable using the KLM (Keysight License Manager); see [Table 4](#) on page -14.

Observe following steps while installing licenses:

- 1 Close the firmware of the M8194A.
- 2 Install the licenses using KLM.
- 3 Start the firmware of the M8194A. The firmware finds the new licenses in KLM and installs them in the M8194A.

In case of an upgrade from one channel (-001) to four channels (-004), the following steps must be observed:

- 1 Close the firmware of the M8194A.
- 2 Install license -U02 using KLM.
- 3 Start the firmware of the M8194A. The firmware finds the new license -U02 in KLM and installs it in the M8194A.
- 4 Close the firmware of the M8194A.
- 5 Install license -U04 using KLM.
- 6 Start the firmware of the M8194A. The firmware finds the new license -U04 in KLM and installs it in the M8194A.

Front Panel

Figure 1 on page 15 illustrates the front panel of the M8194A instrument.



Figure 1 M8194A front panel

The M8194A front panel include the following input/output ports:

Data Outputs

- The M8194A is always delivered with four physically available differential Data Outputs of the Digital to Analog Converter (DAC). The analog DAC outputs are labeled with Data Out Channel 1, Data Out Channel 2; Data Out Channel 3, Data Out Channel 4. Depending on the channel option (-001 or -002 or -004) that has been installed, the M8194A one, two, or four differential analog outputs of the Digital to Analog Converters (DAC) are enabled for data generation.
 - Option -001:** The differential output Data Out Channel 1 is enabled for analog data generation. Also, one or two digital markers can be generated at Data Out Channel 3 and Data Out Channel 4.
 - Option -002:** The selected Instrument Mode (see [Instrument Modes](#) on page 17) determines, which channels are enabled for analog data and marker generation.

- In '**Dual Channel**' mode the differential outputs Data Out Channel 1 and Data Out Channel 2 are enabled for analog data generation. Data Out Channel 3 and Data Out Channel 4 are disabled.
- In '**Dual Channel with Marker**' mode the differential outputs Data Out Channel 1 and Data Out Channel 2 are enabled for analog data generation. One or two digital markers can be generated at Data Out Channel 3 and Data Out Channel 4.
- **Option -004**: The differential output Data Out Channel 1, Data Out Channel 2, Data Out Channel 3 and Data Out Channel 4 are enabled for analog data generation.

NOTE

The Data Outputs can be used differentially or single-ended. In case the output is used single-ended, the unused output must be terminated with 50 Ohm to GND to achieve optimum signal quality.

- **Sync In A 1 2 3 4** - Multi-module synchronization control input.
- **Sync Out A 1 2 3 4** - Multi-module synchronization control output.
- **Sync In B** - 200-300 MHz reference clock input.
- **Sync Out B** - 285 MHz internal reference clock output.

Data Out LEDs

Table 5 Data out LEDs

State/Color	Meaning	Description
Off	Output disabled	Represents the state 'Disable'. Selectable from Soft Front Panel or SCPI. The output amplifier is not powered. After Power-On the LED is off. After successful initialization of the M8194A, the LED turns to its default state which is OFF.
ON, Green	Output enabled	Represents the state 'Enable'. Selectable from Soft Front Panel or SCPI: <ul style="list-style-type: none"> ▪ Output amplitude is equal to the adjusted amplitude. ▪ Offset is equal to the adjusted amplitude. ▪ External Termination voltage is equal the adjusted termination voltage.
On, Red	Protection circuit active	Error condition such as: <ul style="list-style-type: none"> ▪ The externally applied termination voltage significantly differs from the adjusted termination voltage. ▪ External termination resistor significantly differs from 50 Ohm. User interaction is required to remove the externally applied error condition. After removal, the user must actively enable the output again.

Status LEDs

Following LEDs are available at the front panel to indicate the status of the M8194A module:

- The green '**Access**' LED:
 - It indicates that the controlling PC exchanges data with the AWG module.
- The red '**Fail**' LED has following functionality:
 - It is 'ON' for about 30 seconds after powering the AXIe chassis.
 - After about 30 seconds the LED is switched 'OFF'. If an external PC is used to control the AXIe chassis, this PC can be powered after this LED has switched OFF.
 - During normal operation of the module this LED is 'OFF'. In case of an error condition such as e.g. a self-test error, the LED is switch 'ON'.

Instrument Modes

Following are the available instrument modes which are associated with the instrument options:

- Option -001 allows the selection of the instrument mode 'Single Channel' or 'Single Channel with Marker'.

The waveform is always sent at channel 1. The digital markers are always sent at channel 3 and 4.

- Option -002 allows the selection of the Instrument Mode 'Single Channel', 'Single Channel with Marker', 'Dual Channel with Marker' or 'Dual Channel'.

In Instrument mode 'Dual Channel', no digital markers are available.

Each channel can be enabled and disabled independently from other channels.

- Option -004 allows the selection of the Instrument Mode 'Single channel', 'Single Channel with Marker', 'Dual Channel with Marker', 'Dual Channel', or 'Four Channel'.

In Instrument mode 'Four Channel', no digital markers are available.

Each Channel can be enabled and disabled independently from other channels.

Related Documents

To access documentation related to the Keysight M8194A digitizer, use one of the following methods:

- **CD** - Browse the product CD for M8194A documentation.
- **Start > All Programs > Keysight M8194 > Keysight M8194 Documentation** - Provides links to all product documentation.
- **Start > All Programs > Keysight M8194 > Keysight M8194 Examples** - Provides example waveform files.
- Go to the product web site (www.keysight.com/find/M8194A) and browse the manuals under **Document Library** tab.

Additional Documents

Additional documentation can be found at:

- <http://www.keysight.com/find/M9502A> for 2-slot chassis related documentation.
- <http://www.keysight.com/find/M9505A> for 5-slot chassis related documentation.
- <http://www.keysight.com/find/M9514A> for 14-slot chassis related documentation.
- <http://www.keysight.com/find/M9537A> for embedded AXIe controller related documentation.

Keysight M8194A 120 GSa/s Arbitrary Waveform
Generator

User Guide

2 M8194A Software Installation

[Prerequisites](#) / 20

[Installation Steps](#) / 21

[Post Installation Steps](#) / 27

[How to use M8194A Instrument](#) / 28

This chapter explains the steps required to install M8194A software package.

Prerequisites

The following are the prerequisites for installing Keysight M8194A software:

1 Windows Operating System

The supported Windows operating systems are:

- Windows 10 (32 bit or 64 bit)
- Windows 8.1 (32 bit or 64 bit)
- Windows 8 (32 bit or 64 bit)
- Windows 7 (32 bit or 64 bit)

2 Keysight IO Libraries Suite

Ensure that you have **Keysight IO Libraries Suite** version 18.0 or higher installed on your system. The **Keysight IO Libraries Suite** can be found on the CD that is part of shipment content or at <http://www.keysight.com/find/iosuite>

NOTE

Even if a non-Keysight I/O library is already installed on your PC, it is still necessary to install the Keysight I/O library. The Keysight I/O library will install as “secondary” I/O library in this case.

Installation Steps

Follow the given steps to install Keysight M8194A software on your system:

- 1 Double-click the executable (*M8194A_Setup.exe*). This executable file is available either on CD or Web.



NOTE

The installer will first check and list some prerequisites. Click **Install** to install them. It is possible that your PC requests a reboot during this step. Reboot your PC, if requested.

- 2 The Keysight **M8194A Setup** will prepare the **InstallShield Wizard** for the installation process.
- 3 Follow the on-screen instructions to begin the installation process. Click **Next**.

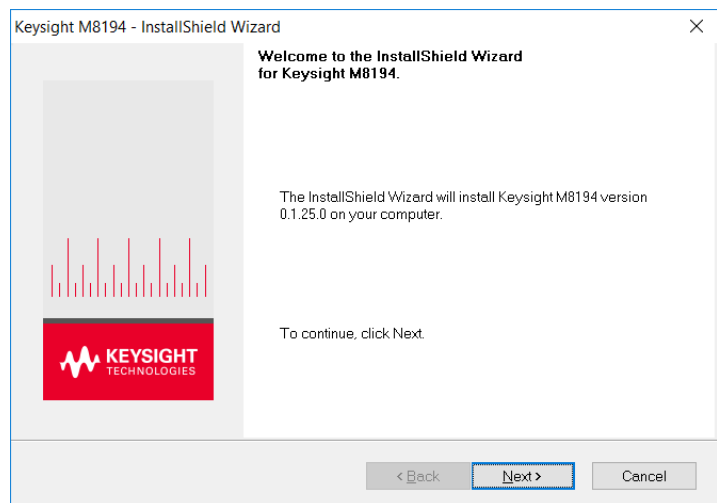

- 4 We recommend you to read the document to check if your hardware configuration is supported. Click **Next** to proceed to the license agreements.

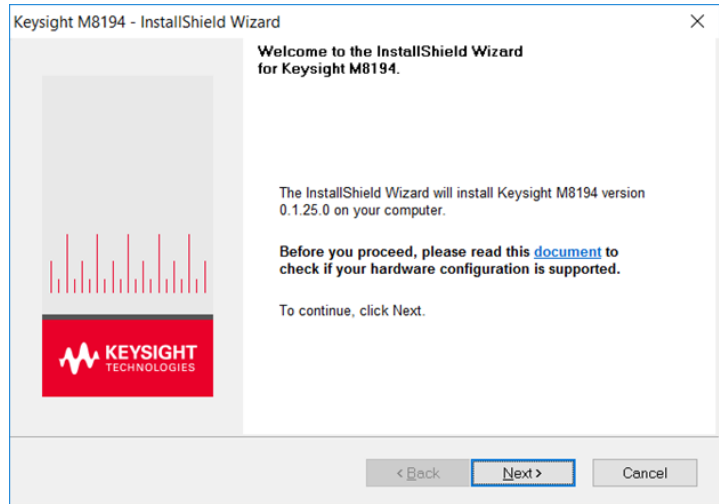

- 5 Accept the terms of Keysight software end-user license agreement and click **Next**.

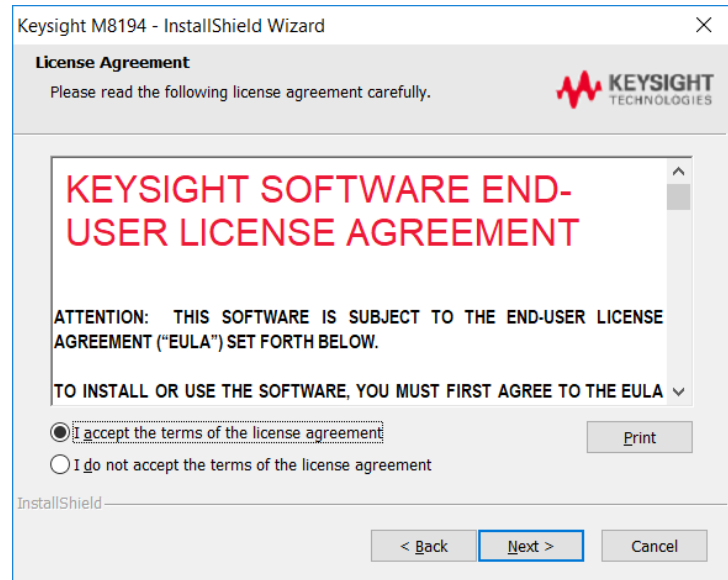

- 6 Select **Yes** if you want to read the post-installation instructions when finished. Click **Next** to select setup type.

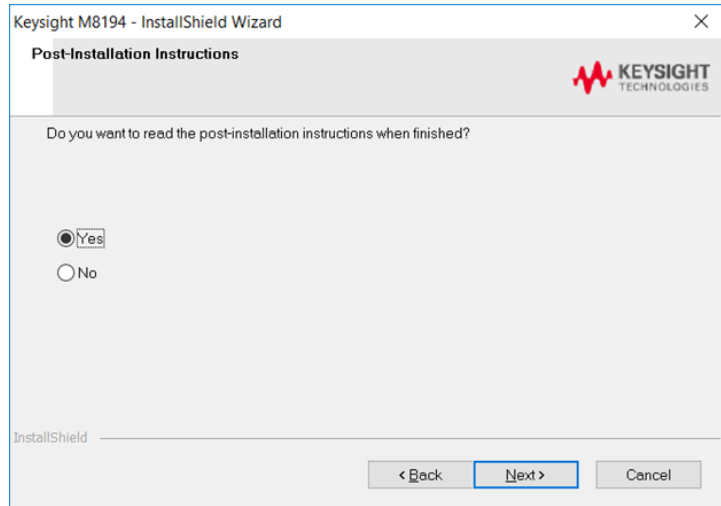

- 7 Select a setup type either **Complete** or **Custom**. Click **Next**.

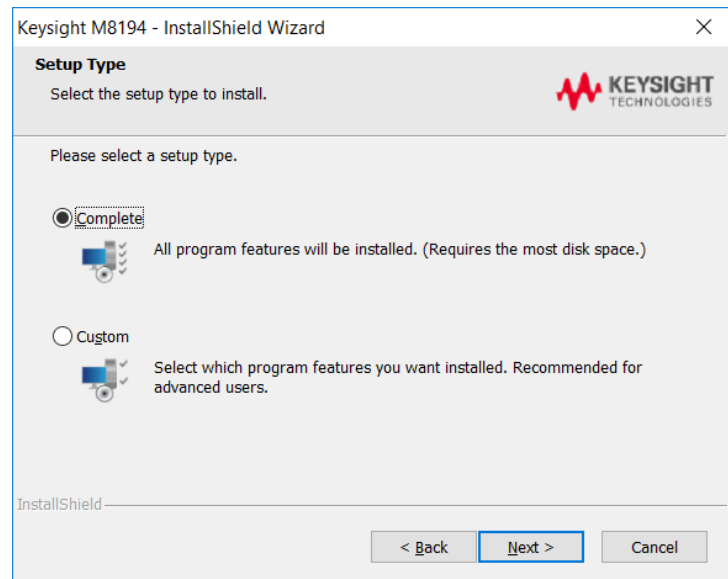

- 8 If you select **Custom** and click **Next**, you can specify which optional features will be installed.

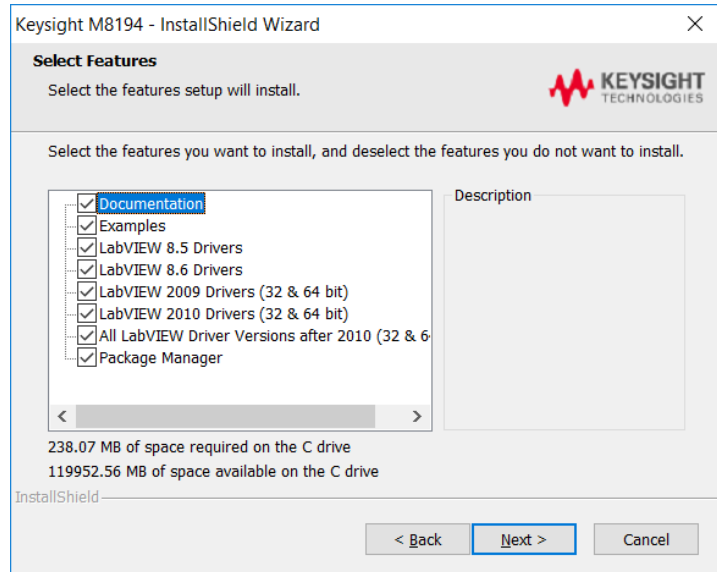

- 9 Click **Install** to begin installation.

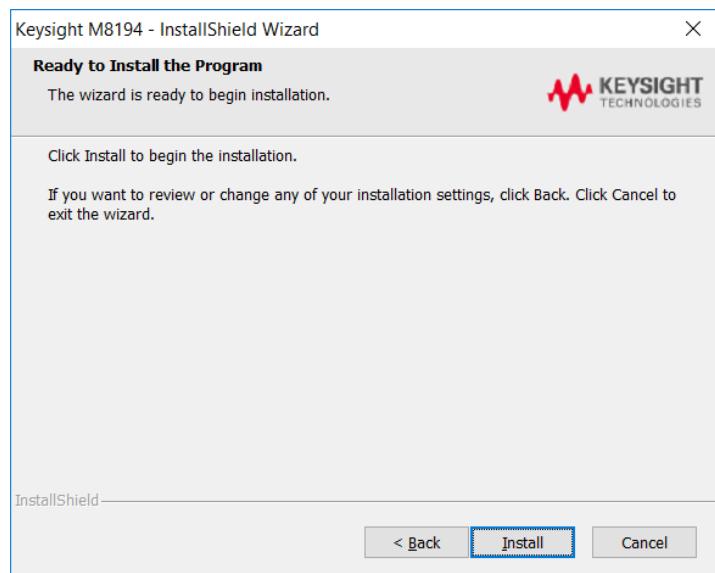

- 10 The **Setup Wizard** will now install M8194A beginning with Keysight Common Components Libraries, Host Processor Platform and USB driver installation.

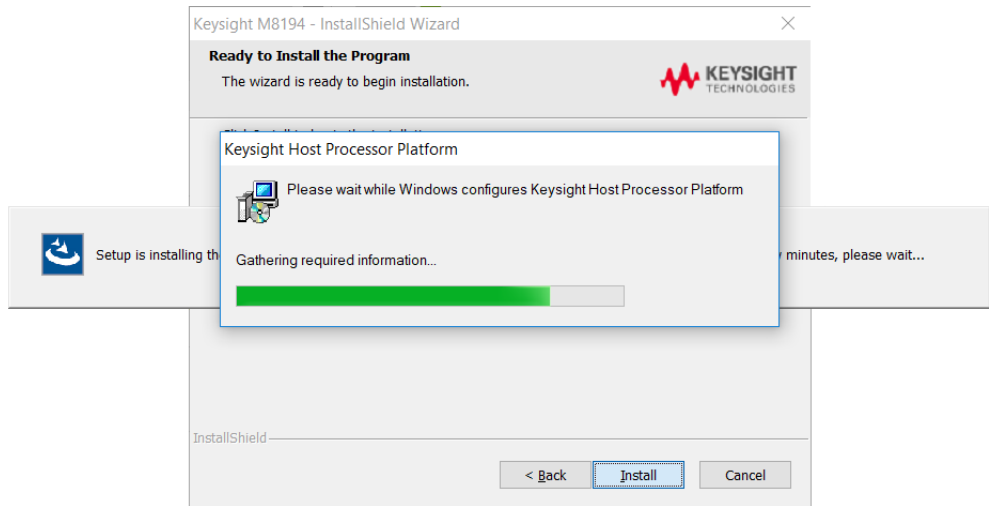

- 11 The Keysight M8194A will configure the new software installation.

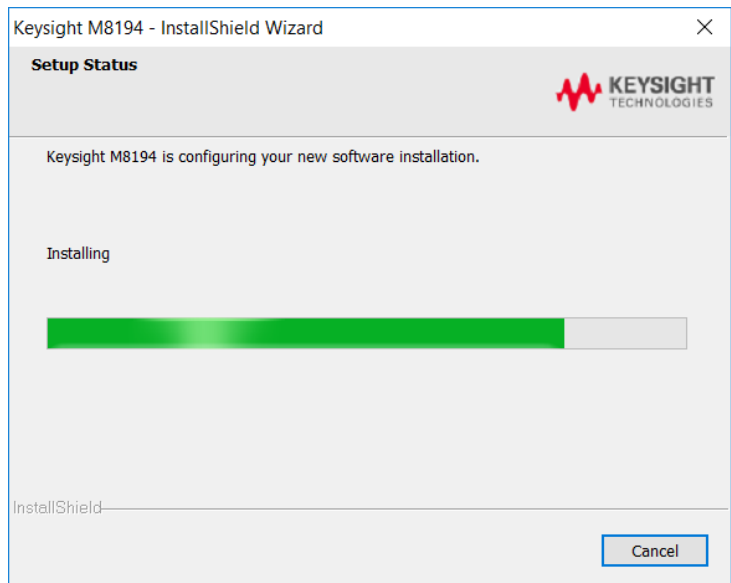

- 12 The following screen will appear once the Keysight M8194A software is successfully installed on your system.

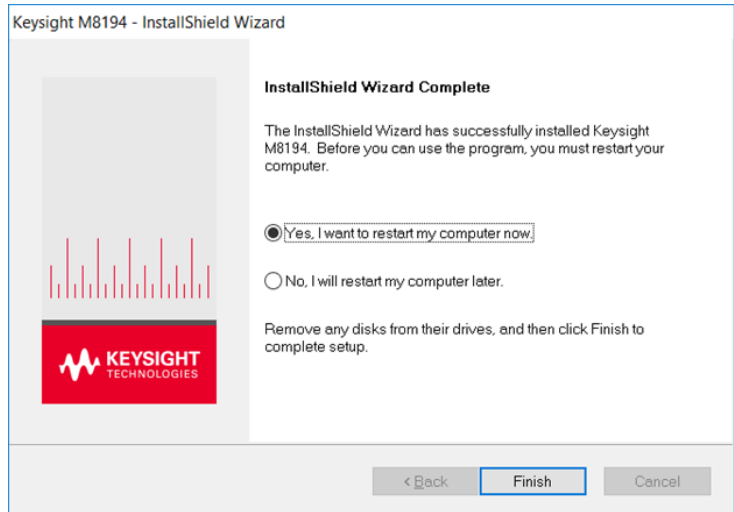

- 13 Click **Finish** to restart your system. Do not connect the AXIe chassis to your system using the PCIe or USB cable during this reboot. This completes the Keysight M8194A software installation.

Post Installation Steps

Follow the post installation steps as shown below:

NOTE

If M8194A is already powered up and connected to PC using the PCIe, just reboot the PC and start with step 5. No such reboot step is required in case of USB connection.

- 1 Shut down PC and instrument.
- 2 Connect the instrument to the PC using the PCIe cable.
- 3 Switch on the instrument. Wait until the 'Access' LED of the M8194A has switched from red to green.
- 4 Switch on the PC.
- 5 The PC should automatically recognize the instrument.

Check this in the device manager; e.g. via **Start > Control Panel > Device Manager**, or right-click **Computer > Manage > Device Manager**:

- In case of PCIe: The instrument should be visible in the device tree as **Keysight Technologies Modular Devices > M8194A**
- In case of USB: The instrument should be visible in the device tree as **Keysight Modular Platform (AMP/AXIe) > Keysight Technologies USB AMP/AXIe Chassis**

NOTE

In case of PCIe, post installation steps must be followed strictly in the same order as mentioned for successful connection of the PC with M8194A. However, in case of USB no such restriction is applicable i.e. the PC can be powered before the M8194 is turned ON.

NOTE

Your PC might request a reboot. Reboot your PC, if requested.

- 6 (For PCIe only) Check if the M8194 is also visible in the **Connection Expert**. The connection expert can be opened by clicking its icon in the system tray. If something went wrong and the instrument is not showing in the PXI section, it may be necessary to reboot the PC once more.

How to use M8194A Instrument

In order to use the instrument:

- 1 If you use a PCIe link to control the M8194A, the AXIe chassis must be switched on before you start the PC.
- 2 Start the M8194A Soft Front Panel (**Start > All Programs > Keysight M8121 > Keysight M8194A Soft Front Panel**). The user interface will display the VISA resource strings for different kinds of connection.
- 3 Using the appropriate VISA resource string you can control the instrument with your own application using the SCPI interface.

You must start the M8194A Soft Front Panel in order to send SCPI commands to the instrument.

NOTE

The M8194A IVI Drivers start the M8194A Soft Front Panel automatically.

3 M8194A Soft Front Panel

[Launching the M8194A Soft Front Panel](#) / 30

[M8194A Soft Front Panel](#) / 33

[Working with M8194A Front Panel](#) / 40

[Output Tab](#) / 42

[Clock/Sync Tab](#) / 45

[Standard Waveform Tab](#) / 48

[Multi-Tone Waveform Tab](#) / 56

[Complex Modulated Waveform Tab](#) / 64

[Serial Data Waveform Tab](#) / 75

[Import Waveform Tab](#) / 84

[Correction File Format](#) / 99

[Converting the 285 MHz Reference Clock into a clock suitable as DCA
Precision Timebase input](#) / 101

[Synchronous Multi-Module System](#) / 105

This chapter describes the M8194A Soft Front Panel.

Launching the M8194A Soft Front Panel

There are two ways to launch the M8194A Soft Front Panel:

- 1 Select **Start > All Programs > Keysight M8194 > Keysight M8194** from the **Start** menu.
- 2 From the **Keysight Connection Expert** select the discovered M8194A module, select the **“Installed Software”** tab and press the **“Soft Front Panel”** icon.

The following **Connect to Instrument** dialog box will appear:

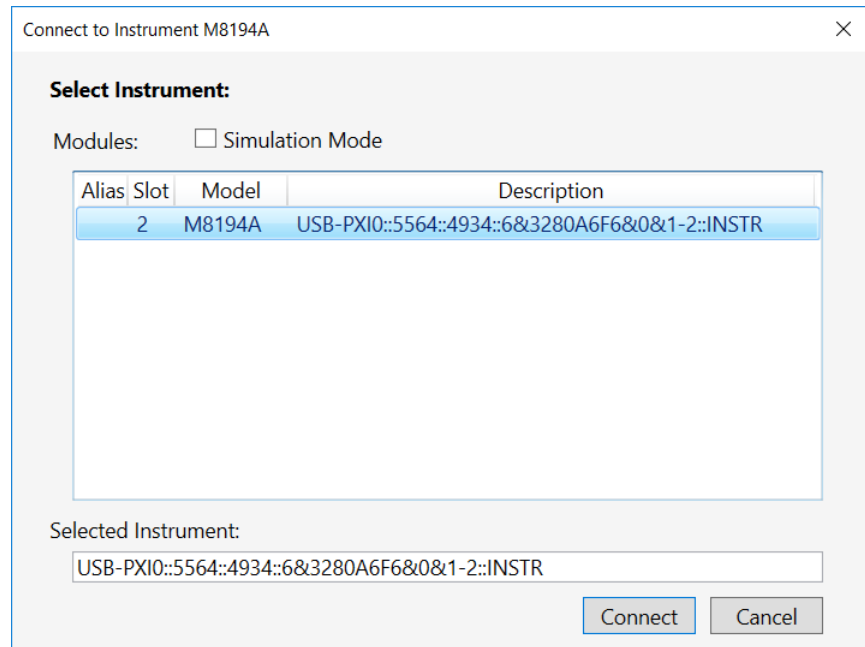

Figure 2 M8194A connected to PC

This dialog box displays the address of the discovered M8194A modules. Select a module from the list and click **Connect**.

If no M8194A module is connected to your PC, you can select **Simulation Mode** check box and then click on the **Simulate** button to simulate M8194A module.

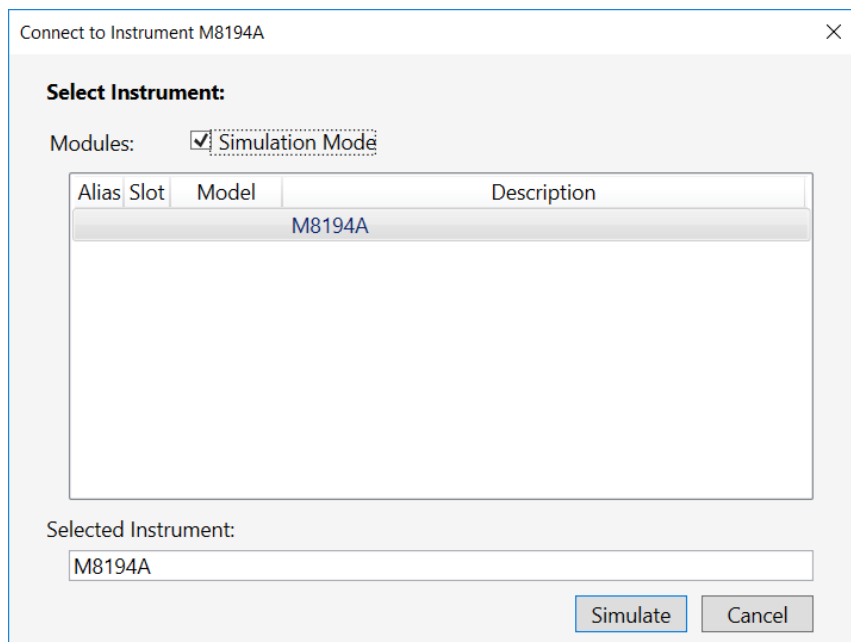

Figure 3 M8194A connected in simulation mode

Next, a M8194A software startup screen will be displayed as shown in [Figure 4](#) on page 32.



Figure 4 M8194A startup screen

M8194A Soft Front Panel

Figure 5 on page 33 shows the **M8194A Soft Front Panel**.

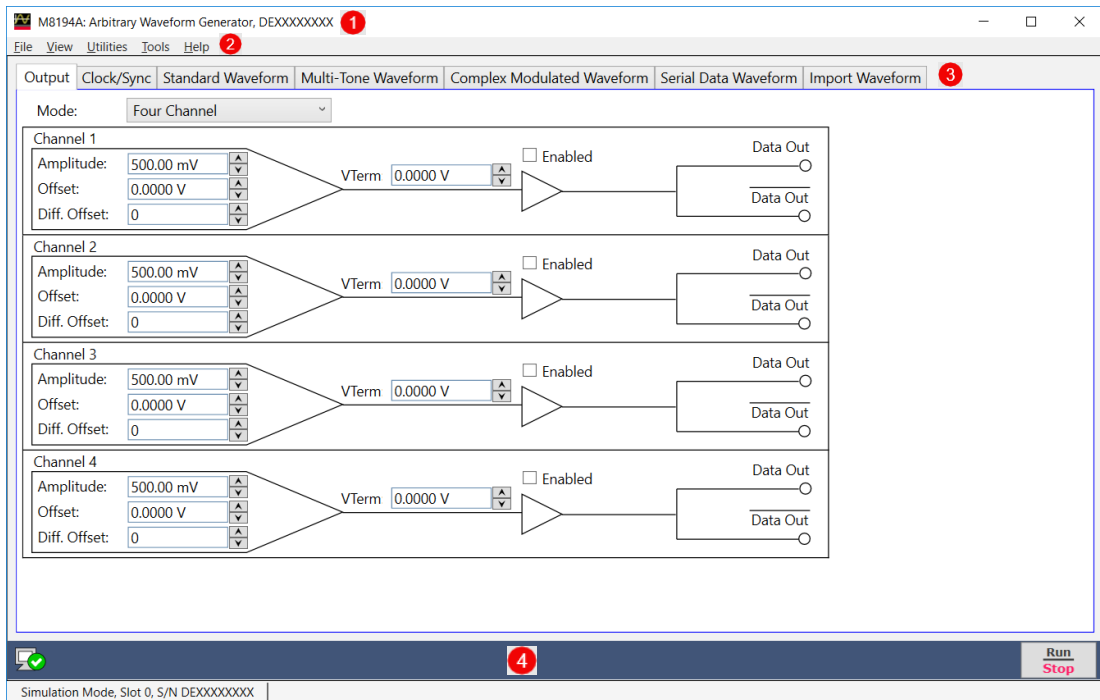

Figure 5 M8194A soft front panel

It includes the following GUI elements:

- 1 Title Bar
- 2 Menu Bar
- 3 Tabs
- 4 Lower Pane

The detailed information on these GUI elements are described in the sections, that follow.

Title Bar

The title bar is a horizontal bar present at the top of a window which contains standard Window elements such as the program name and the icons for minimizing, maximizing, or closing the window.

Menu Bar

The menu bar consists of various pull down menus that provide access to the different functions and launch interactive GUI tools.

The menu bar includes the following pull down menu:

- File
- View
- Utilities
- Tools
- Help

Each menu and its options are described in the following sections.

File Menu

The **File** menu includes the following selections:

File > Connect...	Opens the “Connect to Instrument” dialog box. For details, see Launching the M8194A Soft Front Panel on page 30.
File > Save Configuration As...	Saves the current configuration as a text file.
File > Load Configuration...	Loads the previously saved configuration file.
File > Exit	Exits the M8194A application.

View Menu

The **View** menu includes the following selections:

View > Refresh	Reads the instrument state and updates all fields.
View > Hide	Minimizes the GUI to the notify icon.

Utilities Menu

The **Utility** menu includes the following selections:

Utility > Identify	Identify the instrument by flashing the green “Access” LED on the front panel for a certain time.
Utility > Reset	Resets the instrument, reads the state and updates all fields.
Utility > Self Test...	Opens a “Self Test” window to start the self-test and display the result after completion. In addition, it also allows you to save the self-test results.

Tools Menu

The **Tools** menu includes the following selections:

Tools > Monitor Driver Calls	Opens the “Driver Call Log” window. For details, see Driver Call Log on page 37.
------------------------------	--

Help Menu

The **Help** menu includes the following selections:

Help > User Guide	Opens the M8194A User Guide.
Help > Driver Help	Opens the instrument’s driver help. This will be available in the next software release.
Help > Online Support	Opens the instrument’s product support web page.
Help > About	Displays product information including version number, build date, build info, installed licenses, available options and web links for M8194A information and support.

Tabs

The M8194A Soft Front Panel includes the following tabs to configure the most important parameters of the M8194A module:

- **Output** tab - For details, see [Output Tab](#) on page 42.
- **Clock/Sync** tab - For details, see [Clock/Sync Tab](#) on page 45.
- **Standard Waveform** tab - For details, see [Standard Waveform Tab](#) on page 48.
- **Multi-Tone Waveform** tab - For details, see [Multi-Tone Waveform Tab](#) on page 56.
- **Complex Modulated Waveform** tab - For details, see [Complex Modulated Waveform Tab](#) on page 64.
- **Serial Data Waveform** tab - For details, see [Serial Data Waveform Tab](#) on page 75.
- **Import Waveform** tab - For details, see [Import Waveform Tab](#) on page 84.

All these tabs are described in detail in the sections, that follow.

Run / Stop Button

The **Run/Stop** button is used to switch between Run and Program mode. When pressed the waveform generation is started and the “Run” turns

green . When pressed again the output sends a zero-waveform

and the “Stop” turns red . Output voltage offset remains active as long as output port is enabled.

Driver Call Log

Use this window to inspect the sequence of SCPI commands used to configure the M8194A module.

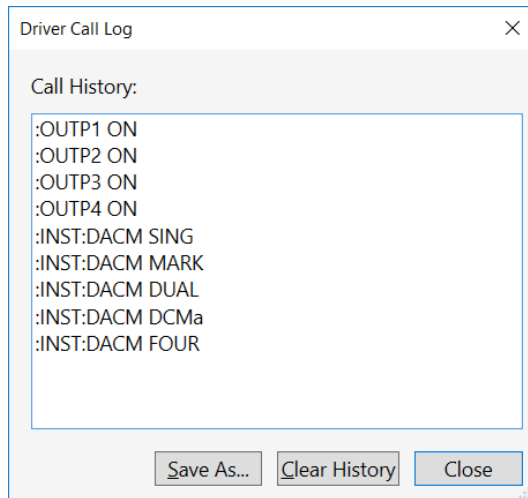

Figure 6 Driver call log window

It has the following buttons:

- **Save As...**
Saves the Driver Call Log as a text file.
- **Clear History**
Clears the Driver Call Log.
- **Close**
Exits the window.

Errors List Window

Use this window to view error and warning messages, generated by the M8194A software.

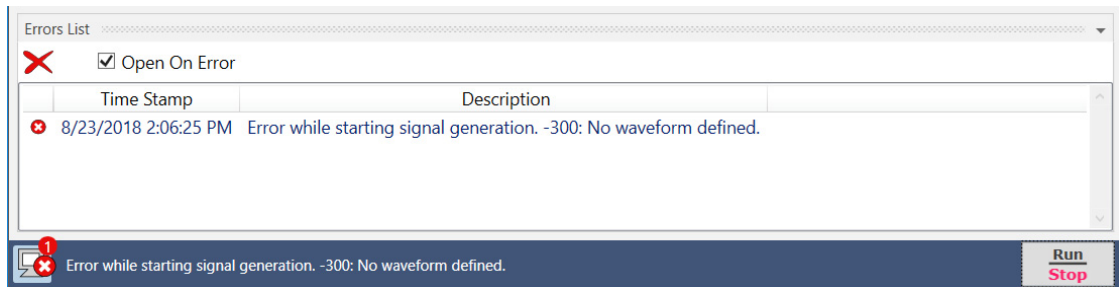





Figure 7 Errors list window

It has the following controls, signs, and options:

- **Open On Error**
Select this check box to automatically open the errors list window whenever an error occurs. This window will show error details i.e. time stamp and description.
- **(Clear All)**
Use this option to clear all the errors/waring messages from the errors list window.
-  or  (Hide Errors List Window or Show Errors List Window)
Use this toggle option to respectively show or hide the errors list window. It also shows total number of errors in the list. When the window has no errors, the green tick icon will appear.
- **(Warning)**
 - This icon represents a warning message.
- **(Error)**
 - This icon represents an error message.
- **Time Stamp**
This column lists the time stamp of individual error/warning message in the format: DD/MM/YYYY HH:MM:SS
- **Description**
This column provides the description of individual error/warning messages.

- **(Window Controls)**

This drop down list provides window control options like:

- Float
- Dock
- Auto Hide
- Close

Status Bar

The **Status Bar** contains the following fields from left to right:

- Connection state
 - “**Not Connected**” – No instrument is connected.
 - “**Connected: <Instrument resource string>**” – An instrument is connected. The resource string, for example PXI36::0::0::INSTR is displayed.
 - “**Simulation Mode**” – No real instrument is connected. The user interface is in simulation mode. Click this field to open the Instrument Selection Dialog.
- Instrument status - Displays the instrument status, for example “**Reset complete**” after issuing a reset command. In case of error it displays additional error information.
- Error status
 - “**Error**” – The connected instrument reported an error.
 - “**No Error**” – No errors occurred. Click this field to open the Report Error Window.
- Signal generation - Displays the information regarding the signal generation. Also, if the signal generation takes some time, it displays an indicator to show that the signal generation is in progress.

Working with M8194A Front Panel

Numeric Control Usage

The numeric control is used to adjust the value and units. Whenever you bring the mouse pointer over the numeric control, a tooltip appears which shows the possible values in that range.

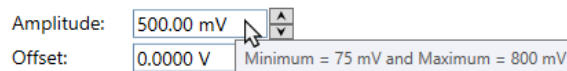

Figure 8 Tool tip showing possible values in the range

The numeric controls can be used in the following ways:

Use the up/down arrows to change the value. The control automatically stops at the maximum/minimum allowed value.

You can increase or decrease the value starting at a specific portion of the value. To do this, place the cursor to the right of the targeted digit and use the up/down arrows. This is especially useful when changing a signal characteristic that is immediately implemented, and observing the result in another instrument. For example, you can change the signal generator's frequency by increments of 10 MHz and observe the measured result in a signal analyzer.

Type directly into the field and press the [Enter] key. If you enter a value outside the allowed range, the control automatically limits the entered value to the maximum or minimum allowed value.



Figure 9 Typing directly into the field

When you type the value, you can type the first letter of the allowed unit of measure to set the units. For example, in the Frequency control you can use "H", "K", "M", or "G" to specify Hz, KHz, MHz or GHz, respectively. (The control is not case sensitive.)

The controls allow scientific notation if it is appropriate to the allowed range. Type the first decimal number, enter an "E", and omit any trailing zeroes. For example, in the Frequency control you can type 2.5e+9 and press [Enter] to set the frequency to 2.5 GHz. (The plus sign is automatically inserted if it is omitted.)

Tooltip

The tooltip is a small pop-up window that concisely describes the object being pointed to, such as descriptions of toolbar controls, icons, graphics, links, menu items and taskbar buttons.

The following example shows the tooltip providing a description of toolbar buttons.

Frequency	Amplitude	Phase
99.95880127 MHz	0.00 dB	81.45 deg

Enter frequency in Hz, relative amplitude in dB, and phase in degrees

Figure 10 Tooltip example

Here is another example where the tooltip provides information to the user on the minimum and maximum values the parameter can hold.

Amplitude:	500.00 mV	▲▼
Offset:	0.0000 V	Minimum = 75 mV and Maximum = 800 mV

Figure 11 Tooltip example

Output Tab

The **Output** tab is used to configure the data outputs of the different channels (Channel 1, Channel 2, Channel 3, and Channel 4) of the M8194A AWG module. [Figure 12](#) on page 42 display the **Output** tab and its options.

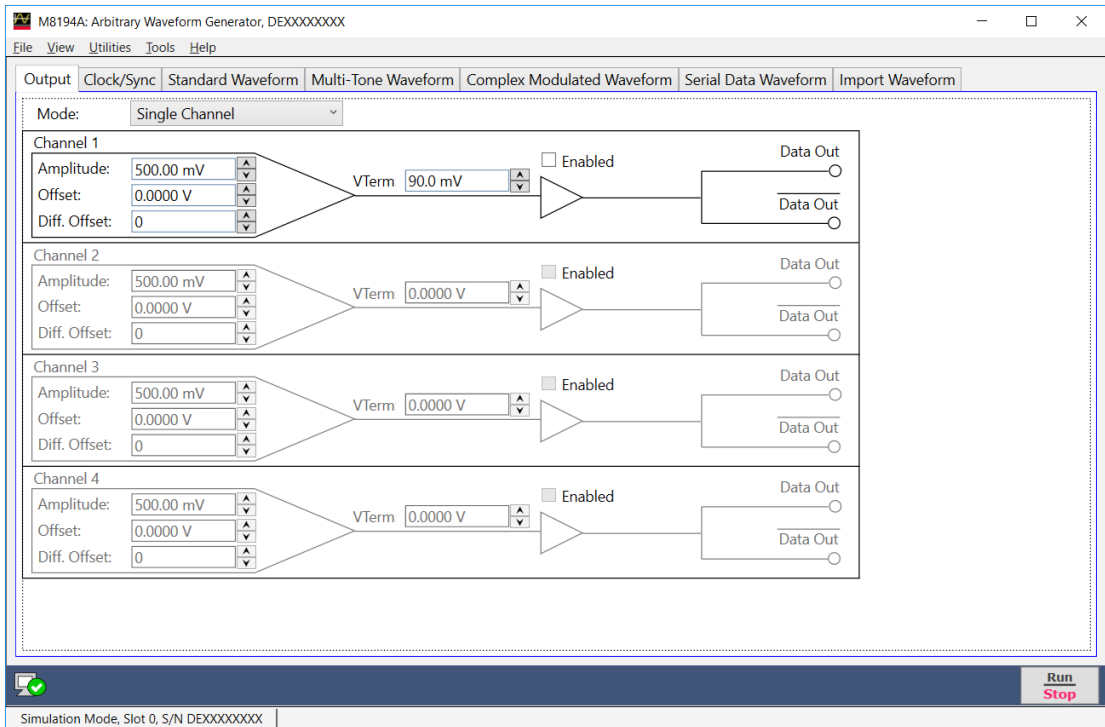

Figure 12 Output tab

- **Mode**

Use this drop-down list to select the mode. The M8194A AWG has five different modes of operation:

- **Single Channel**

If this mode is selected, Channel 1 is used to generate data; Channel 2, Channel 3, and Channel 4 are disabled. This mode is available with all options.

- **Single Channel with Markers**

If this mode is selected, Channel 1 is used to generate data, and channel 3 and 4 are used to generate digital markers. Channel 2 is disabled.

- **Dual Channel**

If this mode is selected, Channel 1 and Channel 2 are used to generate data. Channel 3 and Channel 4 are disabled. This mode is selectable, if option 002 or 004 is present.

- **Dual Channel with Markers**

If this mode is selected, Channels 1 and 2 are used to generate a signal. Channel 1 has two markers output on channel 3 and 4. Channel 2 can generate a signal without markers.

- **Four Channel**

This mode is only selectable, if option 004 is installed. If this mode is selected, all four channels can be used to generate data.

- **Channel Settings**

Each channel in the **Output** tab has the following input fields:

- **Amplitude** - Sets the single-ended, peak-to-peak amplitude of the output signal.
- **Offset** - Sets the common mode offset voltage of the output signal.
- **Diff. Offset** (Differential Offset) - Sets the differential offset of the output signal.
- **VTerm** (Termination Voltage) - Sets the termination voltage.

- **Output enable check box**

When this check box is selected, it enables the output so that the generated signal is present at the output.

- **Output status indicator.** This indicator reflects the color of the 'Channel' LED on the front panel:
 - It is 'OFF' when the channel is disabled and no overload condition at this channel has been detected.
 - It is 'GREEN' if the channel is enabled and no overload condition at this channel has been detected.

- It is 'RED' if an over-voltage has been detected on that channel. Potential overload conditions are e.g. an external short to GND or 50 Ohm termination to a wrong externally applied termination voltage V_{Term} . In case an overload condition is detected, remove the overload condition of the test set-up and re-enable the channel.

When the **Stop** button is pressed, the output voltage offset remains active as long as the output port is enabled.

Clock/Sync Tab

The **Clock/Sync** tab is used to configure the sample clock frequency, reference clock settings, and multi-module configuration settings of the M8194A module. [Figure 13](#) on page 45 displays the **Clock/Sync** tab and its options.

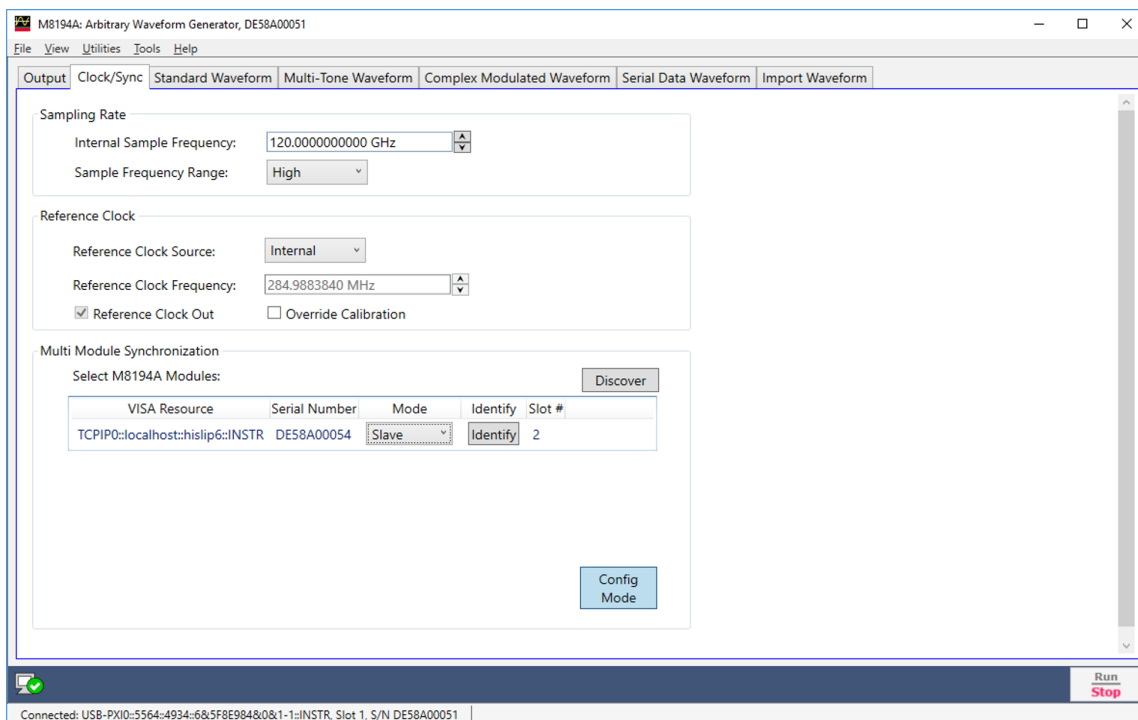

Figure 13 Clock/Sync tab

For more details on the multi-module system, refer to [Synchronous Multi-Module System](#) on page 105.

This tab has the following options:

- **Sampling Rate**

It allows you to select or set the sample clock frequency within the given range.

- **Sample Frequency Range**

This drop-down list allows to select a reference clock frequency from the three options; High, Medium or Low.

- **Internal Sample Frequency**

This field allows to set a sample clock frequency for the selected frequency range option (High, Medium, Low).

The frequency ranges are as following:

- Low - 95.6 GHz to 100.2 GHz
- Medium - 107.2 GHz to 112.2 GHz
- High - 115.2 GHz to 120.2 GHz

- **Reference Clock**

This field allows to configure the reference clock setup of the module.

- **Reference Clock Source**

This drop-down list allows to switch between using the internal reference oscillator (Internal) and the signal from the “Sync In B” connector (External) to be used as the reference clock source for the instrument. Switching is only allowed while the instrument is stopped.

- **Reference Clock Frequency**

This field shows and allows to specify the reference clock frequency. The shown value depends on the RefClk source setting.

External Ref Clk: The frequency on the “Sync In B” input when used as a reference clock input. The valid frequency range is 200 MHz to 300 MHz. The programmed value must match the actual input frequency to within +/- 1%. The value is used to calculate the settings of the PLL of the instrument.

Internal Ref Clk: Sets/shows the value that is assumed to be the internal oscillator frequency when ‘Override Calibration’ is checked. This command does not change the oscillator’s frequency in any way. It is only used for calculating the settings of the PLL of the instrument.

As an example, this command can be used if the measured output frequency slightly deviates from the programmed output frequency.

- **Reference Clock Out**

Turn on/off the “Sync Out B” output. When checked, the output of the internal reference clock oscillator running at nominally 285 MHz is available at the “Sync Out B” connector. When unchecked, the signal on the “Sync Out B” connector is undefined. The output can only be turned on if the internal reference oscillator is used.

- **Override Calibration**

When checked, uses the frequency given in the ‘Reference Clock Frequency’ control to be the assumed internal reference oscillator frequency. When unchecked, uses the factory calibrated frequency value as the assumed internal reference oscillator frequency.

- **Multi Module Synchronization**

This field allows to setup and modify a multi module group.

- **Discover**

This button starts a query for the VISA resource strings of all M8194A modules known by the VISA Resource Manager which could be used as slave modules in a multi module group with the current module as the master.

- **VISA Resource**

The visa resource string of the found module.

- **Serial Number**

The serial number of the found module.

- **Mode**

The drop-down list in each module row allows to add or remove a module from the multi-module group. Selecting ‘Slave’ adds the module to the multi-module group. Selecting ‘None’ removes the module from the multi-module group.

- **Identify**

Allow to identify the corresponding module by toggling the green ‘Access’ LED of this module.

- **Slot #**

The slot number of the found module.

- **Config Mode/Operation Mode**

Allows to switch between Operation Mode and Configuration Mode. If ‘Config Mode’ is shown the multi-module group is in configuration mode and pressing the button puts the group into operation mode and vice versa.

Standard Waveform Tab

The **Standard Waveform** tab is used to create a variety of standard waveform types. It provides the controls which allow the complete definition of signal generation parameters for the following waveform shapes:

- Sinusoidal
- Square with linear transitions
- Square with cosine-shaped transitions
- Triangle
- Sinc ($\text{Sin } x/x$)
- Bandwidth-limited Gaussian noise

The **Standard Waveform** tab allows you to generate signals for both direct and I/Q data generation modes. It also provides a graphic waveform preview functionality, which can be used to validate created signals before sending them to the instrument. The created signals can also be stored in a file for later use. The application takes care of handling the requirements and limits of the target hardware in aspects such as maximum and minimum record lengths and sampling rate and record length granularity. As a result, the signals designed in this tab will be always feasible to be generated by the instrument and free of distortions such as wrap-around or timing artifacts, even if the signal is generated in looped mode.

Figure 14 on page 49 display the **Standard Waveform** tab and its controls.

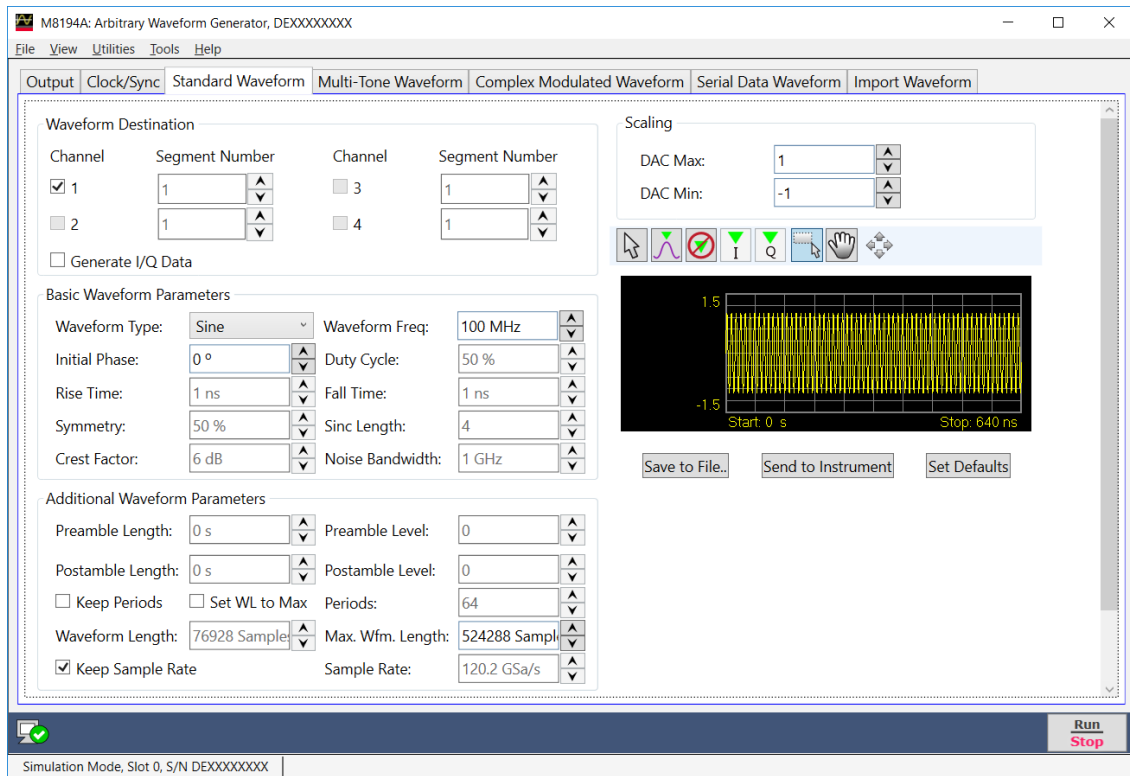

Figure 14 Standard Waveform tab

This **Standard Waveform** tab has the following controls:

Waveform Destination Section

- **Channel**

The independent check boxes allow to set the standard waveforms for Channel 1, Channel 2, Channel 3, or Channel 4. By default, one of the check box is always selected. When the '**Send To Instrument**' button is pressed, the waveform is sent to all channels that are selected.

- **Generate I/Q Data**

If selected, baseband (I/Q) signals will be generated. The effect of this control depends on the selected signal type. For Sinusoidal waves, the resulting complex signal will be a single spectral line located at positive

or negative frequencies. This implies that users can type negative numbers into the “Waveform Freq.” field. For noise, the resulting complex signal will be a limited-bandwidth Gaussian noise with uncorrelated positive and negative frequency components. All the other waveform types result in the same signal being generated by both I and Q assigned channels.

I/Q selection toggle buttons for each channel are shown when the Generate I/Q Data check box is selected. In-Phase (I) and Quadrature (Q) components can be independently assigned to each channel.

- **Segment Number**

The default segment number is 1. This option is unchangeable. The segment number section is only kept for compatibility to M8195A AWG.

Basic Waveform Parameters Section

- **Waveform Type**

The following waveform types are available:

- **Sine:** Sinusoidal waveform. Frequency and Initial Phase parameters can be defined for this waveform type using the corresponding controls. If the Generate I/Q check box is selected, two sine waves with a 90° phase difference will be assigned to the I and Q components.
- **Square_Linear:** Square signal with linear transitions. Frequency, Rise Time, Fall Time, Duty Cycle, and Initial Phase parameters can be defined for this waveform type using the corresponding controls.
- **Square_Cos:** Square signal with cosine shaped transitions. Frequency, Rise Time, Fall Time, Duty Cycle, and Initial Phase parameters can be defined for this waveform type using the corresponding controls.
- **Triangle:** Triangular waveform with linear transitions. Frequency, Symmetry, and Initial Phase parameters can be defined for this waveform type using the corresponding controls.
- **Sinc:** Sin x/x waveform. Frequency, Symmetry, Sinc Length, and Initial Phase parameters can be defined for this waveform type using the corresponding controls.
- **Noise:** Gaussian noise with limited bandwidth. Frequency, Crest Factor, and Noise Bandwidth parameters can be defined for this waveform type using the corresponding controls. If the Generate I/Q check box is selected, two uncorrelated noise waveforms will be assigned to the I and Q components.

- **Waveform Frequency**

Repetition rate for one cycle of the standard waveform. It is always a positive number except when Signal Type is set to Sine and the Generate I/Q Data check box is selected. In this case, frequency may be negative so the resulting SSB (Single-Side Band) will be located over or below the carrier frequency.
- **Initial Phase**

The phase within a normalized cycle of the standard waveform for the first sample in the segment.
- **Duty Cycle**

The relative width as a percentage of the mark and the space sections of square waves.
- **Rise Time**

The transition time (10%-90%) for the rising edge in square waveforms.
- **Fall Time**

The transition time (10%-90%) for the falling edge in square waveforms.
- **Symmetry**

For both triangular and sinc waveforms, it marks the location as a percentage of the positive highest peak within a period of the basic signal.
- **Sinc Length**

The number of zero crossings in a single period for the sinc waveform type.
- **Crest Factor**

The peak-to-average power ratio in dBs for Noise samples before low-pass filtering. Actual crest factor in the final signal after filtering will be higher.
- **Noise Bandwidth**

Baseband noise bandwidth for Noise waveforms. For IQ modes, noise bandwidth around the carrier frequency will be twice this parameter.

Additional Waveform Parameters Section

- **Preamble Length**

The duration of a DC section before the defined Standard waveform starts.

- **Preamble Level**

The level for the DC section before the defined Standard waveform starts. Acceptable range for this parameter is $-1/+1$, being the full dynamic range of the instrument's DAC.

- **Postamble Length**

The duration of a DC section after the defined Standard waveform stops.

- **Postamble Level**

The level for the DC section after the defined Standard waveform stops. Acceptable range for this parameter is $-1/+1$, being the full dynamic range of the instrument's DAC.

- **Keep Periods**

This check box is only available when "Keep Sample Rate" is selected. When this option is selected, the waveform calculation algorithm preserves the user-defined number of periods.

- **Set WL to Max**

This check box is only available when "Keep Sample Rate" is selected. When this option is selected, the waveform calculation algorithm always takes the maximum waveform length as defined in the "Max. Wfm. Length". As the waveform length must always be identical for all four channels, it is recommended to check the "Set WL to Max" box in case different waveforms shall be downloaded to different channels.

- **Periods**

The number of repetition of single periods of the standard waveform within the target segment. This parameter is set automatically when Frequency is changed and preamble and postamble lengths are set to zero in order to obtain the best timing accuracy and meet the record length granularity requirements.

- **Waveform Length**

The length in samples of the resulting segment. It may be set within acceptable limits and it may be calculated automatically to properly implement other signal and instrument parameters such as sampling rate.

- **Max. Wfm. Length**

Maximum waveform length must be used to force the resulting waveform to be shorter than or equal to a user-set limit.

- **Keep Sample Rate**

This check box preserves the sampling rate to a user-defined value no matter how any other signal parameters may be defined. Keeping the sampling rate to a fixed value may be necessary when multiple waveforms are created to be used in a sequence or scenario. By default, this check box is selected. The “Set WL to Max” check box gets activated when this check box is selected.

The “Set WL to Max” check box forces the usage of the number of samples defined in the “Max. Wfm. Length” numeric entry field. Some waveform parameters may be adjusted to make sure that continuous play-back of the waveform is seamless.

Marker Mode

These controls are available when the “Single Channel with Marker” or “Dual Channel with Marker” mode is selected in the **Output** tab. See [Output Tab](#) on page 42.

- **Ch. 3 (Marker 1)**

Marker 1 is output on Channel 3. Signaling the beginning of the Channel 1 waveform may be activated (Segment selection) and deactivated (None selection).

- **Ch. 4 (Marker 2)**

Marker 2 is output on Channel 4. Signaling the beginning of the Channel 1 waveform may be activated (Segment selection) and deactivated (None selection).

Scaling Section

- **DAC Max**

Standard waveforms may occupy a limited range of the DAC’s full scale. This parameter sets the maximum level. If set to a lower level than DAC Min, this will be automatically set to the same level. Acceptable range for this parameter is $-1/+1$, being the full dynamic range of the instrument’s DAC.

- **DAC Min**









Standard waveforms may occupy a limited range of the DAC’s full scale. This parameter sets the minimum level. If set to a higher level than DAC Max, this will be automatically set to the same level. Acceptable range for this parameter is $-1/+1$, being the full dynamic range of the instrument’s DAC.

Preview Section

• **Waveform Preview Toolbar**

The waveform preview toolbar includes the buttons that help to preview the waveform. The following buttons are available:

Table 6 Waveform Preview Toolbar

Toolbar Buttons	Description
	Uses the mouse to control the marker. The respective position of marker at X and Y axis are displayed on the top of waveform.
	Takes the marker to the peak position.
	Turns off the marker.
	Sets the marker on the I data part of the waveform.
	Sets the marker on the Q data part of the waveform.
	Provides zoom functionality. Use the mouse pointer to select the area on waveform that you want to zoom. Once done, you can click Autoscale icon to zoom out the waveform.
	Uses the mouse pointer to move the waveform around. You can also use the pan tool when the waveform is zoomed in.
	Autoscale the waveform.

• **Save To File...**

Use this button to store the waveform signals. It can be stored either in BIN (for non IQ modes) or IQBIN (for IQ modes) formats. These files may be reused within the **Import Waveform** tab.

- **Send To Instrument**

Use this button to send the waveform signal to the selected segments of the selected channels. The previous running status for the target instrument will be preserved but sampling rate may be modified depending on the waveform requirements.

- **Set Default**

Use this button to set the standard waveform parameters automatically to their corresponding default values.

Multi-Tone Waveform Tab

The **Multi-Tone Waveform** tab is used to create signals made-up of multiple tones, either equally or arbitrarily spaced. It also allows for the definition of a frequency interval without tones (or notch) for NPR (Noise Power Ratio) testing. Amplitudes and phases of the individual tones can be corrected through correction factor files defined by the user. The **Multi-Tone Waveform** tab allows you to generate both RF and baseband (I/Q Data) signals. It also provides a graphic waveform preview functionality, which can be used to validate the location and amplitudes of the tones in the signal before sending it to the instrument or be stored in a file for later use. The signal's crest factor or Peak-to-Average Power Ratio (PAPR) is also shown. The application handles requirements and limits of the target hardware in aspects such as maximum and minimum record lengths, sampling rate, and record length granularity. As a result, generation of signals designed in this tab will always be feasible through the instrument, and they will be free of distortions such as wrap-around or timing artifacts, even if they are generated in looped mode.

Figure 16 on page 63 display the **Multi-Tone Waveform** tab and its controls.

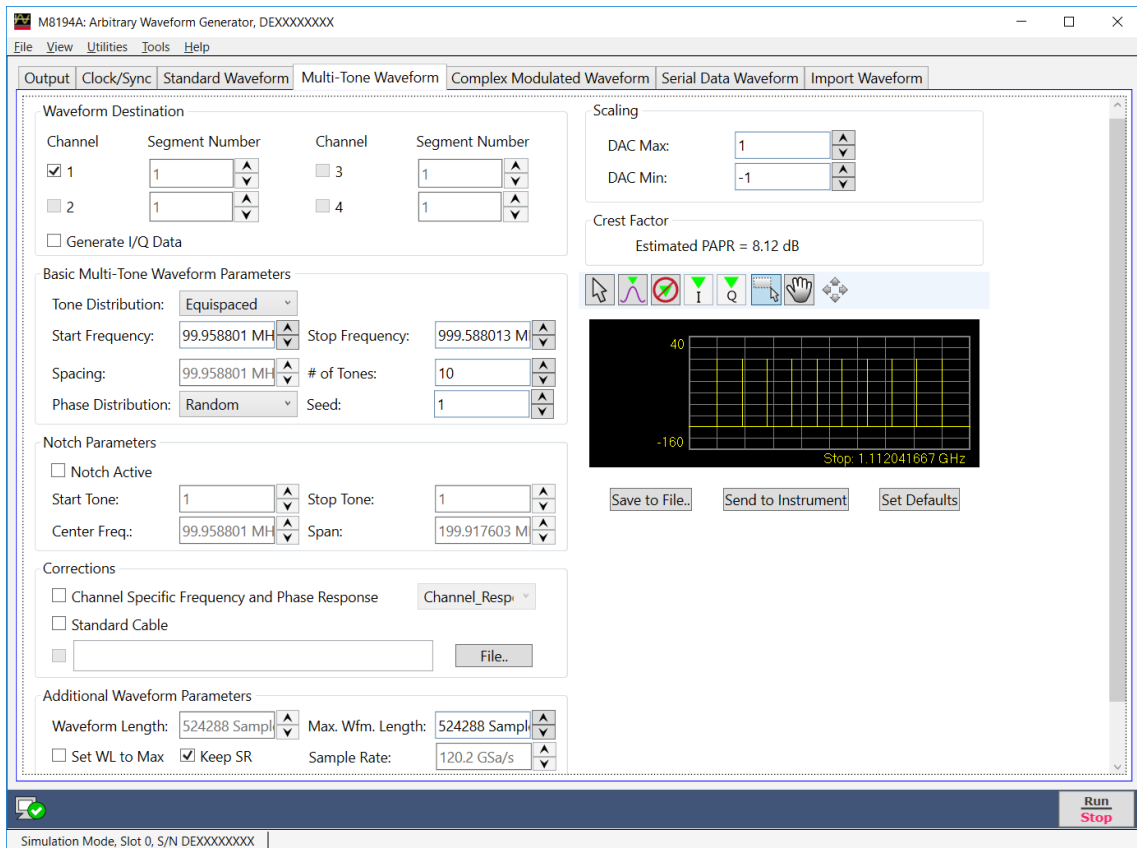

Figure 15 Multi-Tone Waveform tab

There are two basic operation modes for the definition of equally spaced or arbitrarily distributed tones respectively. The selection between the two modes is made through the “Tone Distribution” drop-down list. This control affects the contents of the “Basic Multi-Tone Waveform Parameters” section of the user interface and the presence of the “Notch Parameter” section, which only makes sense in case of equally spaced tones. However, controls in the other control groups are valid and operative for both operating modes. Equally spaced tones are defined on the basis of their common parameters such as start and stop frequencies, and tone spacing or number of tones or both. Arbitrarily distributed tones are defined through a table. In order to simplify the creation of complex scenarios, the tones defined in the equally spaced mode are loaded into

the tone table every time the user switches to the arbitrary mode and the tone table is empty. In this way, any number of tones may be easily defined in the equally spaced mode, and then the resulting table may be edited for frequency, amplitude, or phase for each individual tone. Tones may also be deleted or added.

This tab has the following controls:

Waveform Destination Section

- **Generate I/Q Data**

If selected, baseband (I/Q) signals will be generated. The resulting complex signal will be a series of tones located at positive and/or negative frequencies. As a consequence, negative values can be typed into any waveform frequency edition field in this panel when this check box is selected.

- **I/Q Toggle buttons**

I/Q selection toggle buttons for each channel will be shown when the Generate I/Q Data check box is selected. In-Phase (I) and Quadrature (Q) components can be independently assigned to each channel.

- **Channel selection check boxes**

Allow the definition of multi-tone waveforms for Channel 1, Channel 2, Channel 3 or Channel 4. One of the boxes is always selected. When pressing the 'Send To Instrument' button, the waveform is sent to all channels that are selected.

- **Segment Number**

The segment number is 1. Please note that the segment number section is only kept for compatibility to M8195A AWG.

Corrections Section

- **File...**

Open a correction file selection dialog box. Default file extensions match the File Format selection. The name of the successfully loaded correction factors file is shown in the field located at the left of this button. The accepted format for correction files may be found in the Correction File Format section.

- **Channel Specific Frequency and Phase Response**

This check box activates the application of corrections based on frequency-domain calibration data stored in the target instrument in an internal non-volatile memory. It improves flatness and linear phase distortion.

- **Standard Cable**

This check box activates the application of correction factors based on a typical 2.4mm connector, high-quality, high-bandwidth 0.85m microwave cable (Huber+Suhner type N4910-61601).

Additional Waveform Parameters Section

- **Waveform Length**

This field behaves as an indicator only. It display the length of the resulting segment in samples.

- **Max. Wfm. Length**

Maximum waveform length should be used to force the resulting waveform to be shorter than or equal to the limit set by the user.

- **Keep Sample Rate**

This check box preserves the sampling rate to a user-defined value irrespective of the manner in which other signal parameters may be defined. Keeping the sampling rate to a fixed value may be necessary when multiple waveforms are created for usage in a sequence or scenario. By default, this check box is selected. The “Set WL to Max” check box is displayed when this check box is selected.

- **Set WL to Max**

This check box is only available when “Keep Sample Rate” is selected. When this option is selected, the waveform calculation algorithm always takes the maximum waveform length as defined in the “Max. Wfm. Length”. As the waveform length must always be identical for all four channels, it is recommended to check the “Set WL to Max” box in case different waveforms shall be downloaded to different channels.

- **Sample Rate**

Final DAC conversion rate for the resulting signal. It may be set by the user or automatically calculated depending on other signal parameters.

Marker Mode

These controls are available when the “Single Channel with Marker” or “Dual Channel with Marker” mode is selected in the **Output** tab. See [Output Tab](#) on page 42.

- **Ch. 3 (Marker 1)**

Marker 1 is output on Channel 3. Signaling the beginning of the Channel 1 waveform may be activated (Segment selection) and deactivated (None selection).

- **Ch. 4 (Marker 2)**

Marker 2 is output on Channel 4. Signaling the beginning of the Channel 1 waveform may be activated (Segment selection) and deactivated (None selection).

Scaling Section

- **DAC Max**

Multi-Tone waveforms may occupy a limited range of the DAC's full scale. This parameter sets the maximum level. If set to a lower level than DAC Min, this will be automatically set to the same level. Acceptable range for this parameter is -1/+1, being the full dynamic range of the instrument's DAC.

- **DAC Min**

Multi-Tone waveforms may occupy a limited range of the DAC's full scale. This parameter sets the minimum level. If set to a higher level than DAC Max, this will be automatically set to the same level. Acceptable range for this parameter is -1/+1, being the full dynamic range of the instrument's DAC.

Crest Factor Section

It is an indicator only.

It shows the estimated PAPR for the current waveform in dB. Although the definition of the PAPR parameter is always the ratio between the peak and the average power for a signal, results change depending on the working mode. For the I/Q Data Generation mode, the result reflects the PAPR of the envelope of the resulting signal while for direct generation it reflects the overall signal. The difference between the former and the latter values is close to +3dBs in most cases.

Preview Section

- **Multi-Tone Preview Toolbar**

The waveform preview toolbar includes the icons that provide different functionality to preview the waveform. For details, see [Preview Section](#) on page 54.

Compilation and Panel Control Section

- **Save To File...**

Signals can be stored in files either in BIN (for non IQ modes) or IQBIN (for IQ modes) formats. These files may be reused within the Import Waveform tab.

- **Send To Instrument**

Signal will be transferred to the selected segments of the selected channels. The previous running status for the target instrument will be preserved but sampling rate may be modified depending on the waveform requirements.

- **Set Default**

All the Multi-Tone waveform parameters are set automatically to their corresponding default values. Entries in the Arbitrary Tone table are not modified by this button.

- Two control sections show-up for equally spaced tone definition (“Equispaced” selected in the Tone Distribution drop-down list): “Basic Multi-Tone Waveform Parameters” and “Notch Parameters”.

Basic Multi-Tone Waveform Parameters Section

- **Start Frequency**

It is the frequency of the first tone. If it is set to a value higher than the one in the Stop Frequency field, this is changed back to the previous Start Frequency.

- **Stop Frequency**

It is the frequency of the last tone. If it is set to a value lower than the one in the Stop Frequency field, this is changed back to the previous Stop Frequency.

- **Spacing**

It is an indicator only. It is calculated as:

$$\text{Spacing} = (\text{Stop Frequency} - \text{Start Frequency}) / (\# \text{ of Tones} - 1).$$

- **# of Tones**

It is the total number of tones in the Multi-Tone signal including the ones in the notch, if any.

- **Phase Distribution**

Phase for each tone can be set in the three different modes: constant, random, and parabolic. While constant phase Multi-Tone signals show a high crest factor, a random phase distribution results in a much lower value for this parameter while a parabolic distribution results in a close to optimal (or minimum) crest factor.

- **Seed**

This parameter is associated to the random phase distribution and allows generating the same or different random sequences for the phases of each tone. It is also useful to look for a distribution resulting in a desired crest factor value.

Notch Parameters Section

- **Notch Active**
This check box activates or deactivates the generation of a notch in the equally spaced Multi-Tone signal.
- **Start Tone**
It is the index of the first tone to be removed in a notch. Acceptable indexes start with 1.
- **Stop Tone**
It is the index of the last tone to be removed in a notch. Acceptable indexes start with 1.
- **Center Frequency**
It is an indicator only. The central frequency for the notch is computed and shown in this field.
- **Span**
It is an indicator only. The tone-free frequency span for the notch is computed and shown in this field.

Arbitrary Tones Section

Alternatively, an edition table is displayed for arbitrarily spaced tones definition (“Arbitrary” selected in the Tone Distribution drop-down list). When not previously edited (or empty), the table is automatically loaded with the parameters of the tones defined in the equally spaced tone section. This allows for easy edition of individual tones or the creation of multiple notches, or both. Parameters for each tone include its frequency (in Hz), its relative amplitude (in dB), and phase (in degrees). Entries in the table may be added, edited, and deleted. Entries in the table may be also sorted in ascending or descending order of any parameter by clicking in the corresponding field name.

Addition of a new entry in the table can be done by editing the empty edition field located at the bottom of the table. Deletion of any number of entries can be performed by selecting the ones to be deleted and then pressing the [Delete] key of the keyboard. Meaningful numeric values must be typed into the edition fields. Otherwise, an error can be generated. While a valid frequency entry must be always entered, any of the amplitude and phase edition fields may kept empty so they take the default values (0.0 dB for Amplitude and 0.0 degrees for Phase).

Arbitrary Tones

Tone Distribution:

Frequency	Amplitude	Phase
99.95880127 MHz	0.00 dB	81.45 deg
199.91760254 MHz	0.00 dB	114.24 deg
299.87640381 MHz	0.00 dB	96.49 deg
399.83520508 MHz	0.00 dB	20.94 deg
499.79400635 MHz	0.00 dB	-105.83 deg
599.75280762 MHz	0.00 dB	21.20 deg
699.71160889 MHz	0.00 dB	146.17 deg
799.67041016 MHz	0.00 dB	-20.82 deg
899.62921143 MHz	0.00 dB	171.92 deg

Figure 16 Multi-Tone waveform tab, arbitrary tone distribution

Complex Modulated Waveform Tab

The **Complex Modulated Waveform** tab is used to create baseband and IF/RF digitally modulated signals. User-defined corrections may be applied to signals to compensate for (or emulate) instrument, interconnections and channel linear distortions. The complex modulation tab allows you to generate both RF and Baseband (I/Q) signals. It directly supports a large variety of signal-carrier modulation schemes. This is a list of the currently supported standards, modulation orders, and modulation parameters:

- **ASK (Amplitude Shift Keying)**: Modulation Index (0%-100%).
- **PSK (Phase Shift Keying)**: BPSK, QPSK, $\pi/4$ -DQPSK, Offset-QPSK (OQPSK), 8PSK, and $3\pi/8$ 8PSK (EDGE).
- **QAM (Quadrature Amplitude Modulation)**: 8QAM, 16QAM, 32QAM, 64QAM, 128QAM, 256QAM, 512QAM, AND 1024QAM.
- **MSK (Minimum Shift Keying)**
- **APSK (Amplitude-Phase Shift Keying)**: 16APSK and 32 APSK. R2/R1 and R3/R1 can be set by the user to any desired value.
- **STAR**: STAR16 and STAR32. The R2/R1 parameter may be set for the STAR16 modulation scheme.
- **VSB (Vestigial Side Band)**: 8VSB and 16VSB.
- **FSK (Frequency Shift Keying)**: 2FSK, 4FSK, 8FSK, and 16FSK. Peak deviation frequency may be set by the user to any desired value.
- **Custom**: Users may define arbitrary constellations through simple ASCII files that may be read by the SFP application. Modulations with offset (Q delayed by half a symbol time) and rotating constellations may be also defined. (Refer to the section)

The user is allowed to select pulse shaping type, characteristics, and different data options. The panel provides a constellation preview functionality, which can be used to validate the selected modulation scheme and the corresponding modulation parameters. The application takes care of handling the requirements and limits of the target hardware with respect to maximum and minimum record lengths, sampling rate, and record length granularity. As a result, generation of the signals designed in this tab will always be feasible by the instrument and free of distortions such as wrap-around or timing artifacts at any signal domain (time, frequency, and modulation), even if the signal is generated in looped mode.

Figure 17 on page 65 display the **Complex Modulated Waveform** tab and its controls.

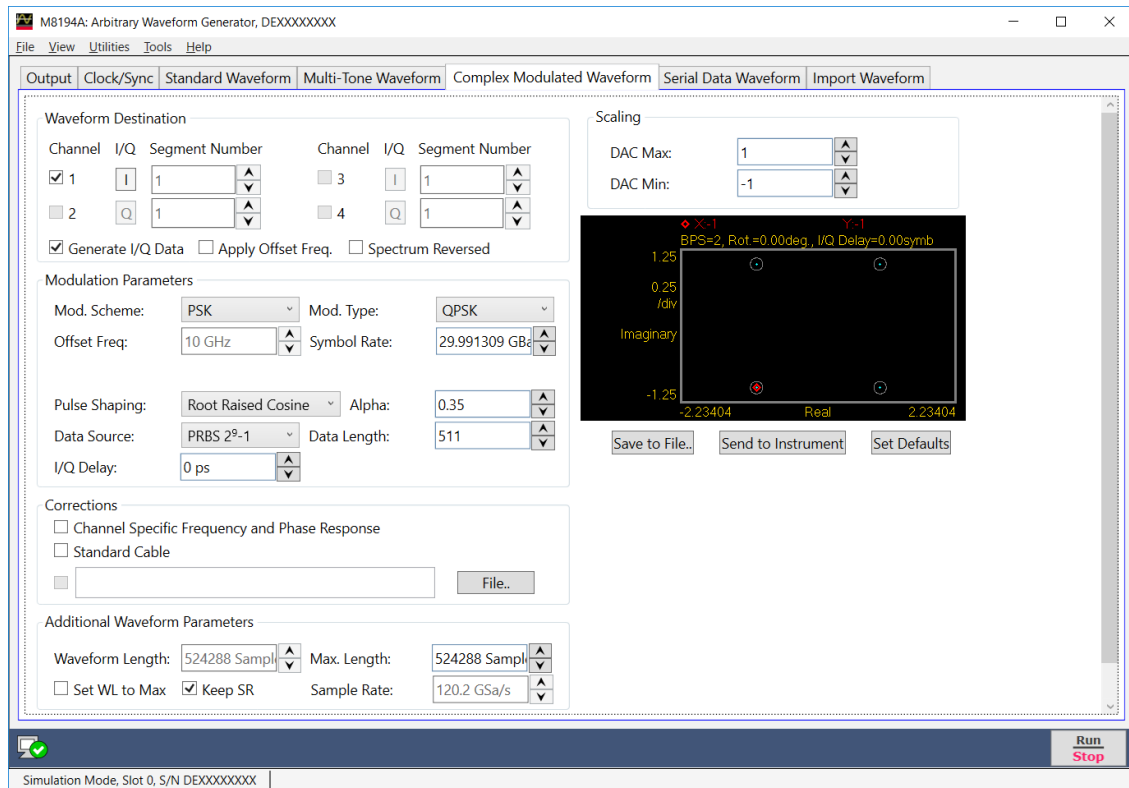

Figure 17 Complex modulated waveform tab

Only relevant parameters and edition fields are shown in the GUI at any time depending on the selected generation mode (RF or I/Q) and modulation scheme.

Waveform Destination Section

- **Generate I/Q Data**

If selected baseband (I/Q) signals will be generated.

- **I/Q Toggle buttons**

I/Q selection toggle buttons for each channel will be shown when the Generate I/Q Data check box is selected. In-Phase (I) and Quadrature (Q) components can be independently assigned to each channel.

- **Apply Offset Freq.**

This check box is only active for the I/Q Data Generation mode and it applies a frequency shift to the signal according to the 'Offset Freq.' edition field. Frequency shift, unlike carrier frequency, may be positive or negative.

- **Spectrum Reversed**

This check box should be selected for generation of signals in the second Nyquist band ($FS/2 - FS$). Its effect is the reversion of the fundamental signal (in the 1st Nyquist Band) in the frequency domain. It also reverses the effect of any correction so correction factors obtained for the second Nyquist band will be applied appropriately.

- **Channel**

Independent check boxes allow the definition of waveforms for Channel 1, Channel 2, Channel 3 or Channel 4. One of the boxes will be always selected. When pressing the 'Send To Instrument' button, the waveform is sent to all channels that are selected.

- **Segment Number**

The segment number is 1. Please note that the segment number section is only kept for compatibility to M8195A AWG.

Modulation Parameters Section

- **Mod. Scheme**

This drop-down list selects the different modulation scheme categories that are supported (see list above).

- **Mod. Type/Mod. Order**

This drop-down list selects the different modulation orders or modulation scheme sub-types for the selected modulation scheme category.

- **Carrier Freq. / Offset Freq.**

The purpose and labeling of this edition field changes depending on the generation mode. For the direct RF generation mode, it handles the carrier frequency while for the I/Q Data Generation mode it deals with the offset frequency (see the Apply Offset Freq. control). Units in both cases are in Hz.

- **Symbol Rate**

This edition field can be used to enter the signaling speed (or baud rate) for the modulated signal expressed in Bauds (1 Baud = 1 Symbol/s).

- **Mod. Index(%)**

This edition field only shows up when the ASK modulation scheme is selected. It sets the modulation index as a percentage for the signal.

- **R2/R1 Ratio**

This edition field only shows up when the 16APSK, 32APSK, and 16STAR modulation schemes are selected. It sets the ratio between the radius of the two inner symbol rings in the constellation.

- **R3/R1 Ratio**

This edition field only shows up when the 32APSK modulation scheme is selected. It sets the ratio between the radius of the outer and the most internal symbol rings in the constellation.

- **Freq. Dev.**

This edition field only shows up when the FSK modulation schemes are selected. It sets the peak frequency deviation in Hz.

- **Mod. File..**

This button only shows up when 'Custom' modulation scheme is selected. It opens a file selection window where modulation definition files may be selected. If a valid file is selected, its name will show up in the text field located at the left of this button. Otherwise, a "File Loading Error" message is shown.

- **Pulse Shaping**

This drop-down list can select different pulse shaping to be applied to the baseband symbols; choices are 'Root Raised Cosine', 'Raised Cosine', 'Gaussian', 'Rectangular', 'None', 'EDGE', and 'Half Sine'.

Notes:

- The default pulse shape is 'Gaussian'.
- The filter types 'None' and 'Rectangular' define the pulse shape in time domain. These filter types can only be applied for integer oversampling. Examples: Filter type 'None' with 4 times oversampling generates one sample with the actual value followed by 3 samples with a value of zero (Dirac-Pulse). The filter type 'Rectangular' with 4 times oversampling generates 4 identical sample values.
- The filter types 'Root Raised Cosine', 'Raised Cosine', 'Gaussian', 'EDGE', and 'Half Sine' describe the filter shape in frequency domain.

- **Alpha / BT**

The meaning and labeling of this edition field depends on the selected pulse shaping. For "Nyquist" filters (Raised Cosine and Square Root of Raised Cosine) it is the 'Alpha' parameter (or roll-off factor) of the filter.

For Gaussian filters it is the BT (Bandwidth/symbol period product) parameter. Some filter types do not require an additional filter parameter.

- **Data Source**

This drop-down list allows the selection of different pseudo random binary sequences as data sources for modulation. Choices are PRBS7 (Polynomial x^7+x^6+1), PRBS10 (Polynomial $x^{10}+x^7+1$), PRBS11 (Polynomial $x^{11}+x^9+1$), PRBS15 (Polynomial $x^{15}+x^{14}+1$), PRBS23 (Polynomial $x^{23}+x^{18}+1$), PRBS23p (Polynomial $x^{23}+x^{21}+x^{18}+x^{15}+x^7+x^2+1$), and PRB31 (Polynomial $x^{31}+x^{28}+1$).

- **Data Length**

This edition field may be used to set a given data length to be implemented by the modulated signal. This field defaults to the maximum non-repeating length of the selected PRBS. It also defaults to this value if the user types '0' (Zero). Otherwise, the sequence will be truncated when the number of bits set by this control is reached. If this number is longer than the PRBS maximum length, the sequence will be re-started as many times as necessary.

- **I/Q Delay**

This numeric edition field allows for the definition of the time skew between the I and the Q baseband components. It can be used to compensate or emulate timing misalignments caused by cabling, external modulators and other devices. This control is activated only when the Generate I/Q Data check box is selected. Delay is applied differentially to both components.

- **Gray Coding**

This check box enables gray coding for the applicable modulation modes.

Corrections Section

- **File...**

Opens a correction file selection dialog box. Default file extension is CSV (Comma-Separated Values). The name of the successfully loaded correction factors file is shown in the field located at the left of this button. The accepted format for correction files may be found in the Correction File Format section.

- **Channel Specific Frequency and Phase Response**

This check box activates the application of corrections based on frequency-domain calibration data stored in the target instrument in non-volatile memory. It improves flatness and linear phase distortions.

- **Standard Cable**

This check box activates the application of correction factors based on a typical 2.4 mm connector, high-quality, high-bandwidth 0.85m cable (Huber+Suhner type N4910-61601).

Additional Waveform Parameters Section

- **Waveform Length**

It is an indicator only. The length is in samples of the resulting segment.

- **Max. Length**

Maximum waveform length should be used to force the resulting waveform to be shorter or equal to a limit set by the user.

- **Keep Sample Rate**

This check box preserves the sampling rate to a user-defined value irrespective of any other defined signal parameter. Keeping the sampling rate to a fixed value may be necessary when multiple waveforms are created for usage in a sequence or scenario. By default, this check box is selected. The “Set WL to Max” check box gets activated when this check box is selected

- **Set WL to Max**

This check box is only available when “Keep Sample Rate” is selected. When this option is selected, the waveform calculation algorithm always takes the maximum waveform length as defined in the “Max. Wfm. Length”. As the waveform length must always be identical for all four channels, it is recommended to check the “Set WL to Max” box in case different waveforms shall be downloaded to different channels.

- **Sample Rate**

It is the final DAC conversion rate for the resulting signal. It may be set by the user or automatically calculated depending on other signal parameters.

Marker Mode

These controls are available when the “Single Channel with Marker” or “Dual Channel with Marker” mode is selected in the **Output** tab. See [Output Tab](#) on page 42.

- **Ch. 2 (Marker 1)**

Marker 1 is output on Channel 2. Signaling the beginning of the Channel 1 waveform may be activated (Segment selection) and deactivated (None selection).

- **Ch. 3 (Marker 2)**

Marker 2 is output on Channel 3. Signaling the beginning of the Channel 1 waveform may be activated (Segment selection) and deactivated (None selection).

Scaling Section

- **DAC Max**

Standard waveforms may occupy a limited range of the DAC's full scale. This parameter sets the maximum level. If set to a lower level than DAC Min, this will be automatically set to the same level. Acceptable range for this parameter is $-1/+1$, being the full dynamic range of the instrument's DAC.

- **DAC Min**

Standard waveforms may occupy a limited range of the DAC's full scale. This parameter sets the minimum level. If set to a higher level than DAC Max, this will be automatically set to the same level. Acceptable range for this parameter is $-1/+1$, being the full dynamic range of the instrument's DAC.

Constellation Diagram Section

The constellation diagram section shows a graphic representation of the ideal constellation corresponding to the selected modulation scheme and modulation parameters. It also shows the location of symbols from valid modulation definition files for validation. The line above the constellation diagram shows the following modulation parameters:

- BPS (Bits Per Symbol)
- Per symbol rotation angle (in degrees)
- I/Q delay (in symbol times)

Compilation and Panel Control Section

- **Save To File...**

Signals can be stored in files in whether BIN (for non IQ modes) or IQBIN (for IQ modes) formats. These files may be reused within the Import Waveform tab.

- **Send To Instrument**

Signal will be transferred to the selected segments of the selected channels. The previous running status for the target instrument will be preserved but sampling rate may be modified depending on the waveform requirements.

- **Set Default**

All the waveform parameters are set automatically to their corresponding default values.

- **Abort**

This button allows canceling signal calculation at any moment. It only shows up during signal compilation.

Custom Modulation File Format

A custom modulation file is an ASCII delimited file including all the information required to define a single carrier modulated signal based in quadrature (IQ) modulation. The file should be composed of a header including a series of lines with identifiers and parameters, and a list of numerical correction factors. For lines including more than one item (i.e. one identifier and one parameter), those must be separated using commas. Identifiers and parameters are not case sensitive. These are the significant fields for the header:

- **#N:** This is a mandatory field and it must be the first in the file. The N parameter is the bits per symbol parameter. $0 < N < 11$.
- **Offset:** It indicates if the Q component must be delayed by half a symbol time respect to the I component. Accepted parameters are 'yes' or 'no'. This parameter is optional. It defaults to 'no' if not included in the file.
- **Rotation:** It sets the rotation of the constellation for each consecutive symbol in degrees. This parameter is optional. It defaults to 0.0 if not included in the file.
- **RotMode:** Rotation mode. Parameter may be 'cont' (continuous) or 'alt' (alternate). This parameter is optional. It defaults to 'cont' if not included in the file.
- **Vsb:** It indicates that vestigial side band baseband filtering must be applied. Accepted parameters are 'yes' or 'no'. This parameter is optional. It defaults to 'no' if not included in the file.

The order of the above entries is not relevant except for the '#N' field that must be placed first in the file. The symbol location section starts with a line including the 'IQ' characters (not case-sensitive). Entries in this section are made by IQ pairs separated by commas. The number of entries must be at least 2N although additional entries will be ignored. Data to symbol mapping depends on the order of the symbols in the file so its position expressed in binary format corresponds to the binary code assigned to that

symbol. Comments must start with the '/' character sequence and may use a complete line or be located at the end of any valid line (including the first line). Empty lines are also valid.

The following example illustrates a simple example of a 3 bit per symbol QAM8 modulation with a particular constellation.

```
#3 // MyModulationFile
Iq
// Inner symbols
2.0, 0.0
0.0, -2.0
-2.0, 0.0
0.0, 2.0
// Outer symbols
3.0, 3.0
-3.0, 3.0
-3.0, -3.0
3.0, -3.0 // Final symbol
```

The above file does not include any unnecessary line in the header as it defines a non-rotating, non-offset modulation so default values for these fields are used instead. The resulting constellation after loading this file is shown as following:

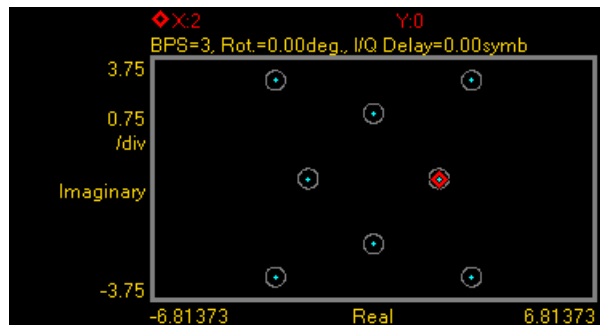

The following example illustrates another possible use of custom modulation to define a distorted constellation. In this particular case, a Q-QPSK modulation with a quadrature error (non-perpendicular I and Q axis) is defined:

```
#2
Offset, yes
iq
1.05, 1.05
-0.95, 0.95
-1.05, -1.05
0.95, -0.95
```

The above file includes a line to indicate that this is an offset modulation. The resulting constellation after loading this file is shown as following:



The following is a more complex example:

```
#3
Offset, no
Rotation, 10.0
RotMODE, cont
iq
1.0, 0.0
2.0, 0.0
0.0, 1.0
```

```

0.0, 2.0
-1.0, 0.0
-2.0, 0.0
0.0, -1.0
0.0, -2.0

```

The above file is composed of a header with relevant information. In this particular case, the file contains 8 (23) IQ pairs. The 'IQ' characters indicate the starting point for the symbol location list composed by 8 lines with I/Q pairs separated by commas. I and Q will not be delayed ('Offset, no') and constellation will rotate by 10.0 degrees ('Rotation, 10.0') in a continuous fashion ('RotMODE, cont'). In fact, the 'Offset' and 'RotMode' fields could be removed without any effect on the final signal as these fields take the default values. The resulting constellation after loading this file is shown as following:

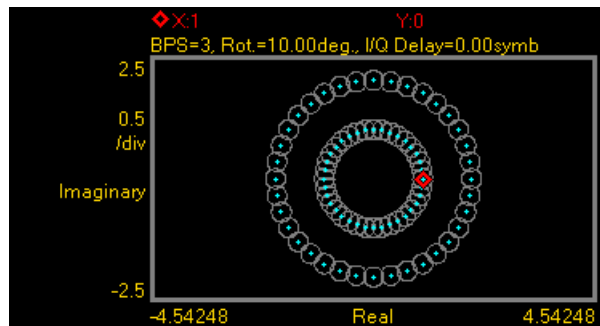

Serial Data Waveform Tab

The **Serial Data Waveform** tab can be used to create single lane and multi-lane bi-level and multi-level high-speed digital serial signals and clocks. User-defined corrections may be applied to signals to compensate for (or emulate) instrument, interconnections and interconnect linear distortions. The serial data tab allows you to generate both data and clock signals. It directly supports a large variety of channel coding and modulation schemes. This is a list of the currently supported modulation and channel coding formats:

- NRZ (Not Return to Zero).
- Unipolar RZ (Return to Zero).
- Polar RZ (Return to Zero).
- PAM-4 (Pulse-Amplitude Modulation, 4 level)
- PAM-5 (Pulse-Amplitude Modulation, 5 level)
- PAM-8 (Pulse-Amplitude Modulation, 8 level)
- PAM-10 (Pulse-Amplitude Modulation, 10 level)
- PAM-12 (Pulse-Amplitude Modulation, 12 level)
- PAM-16 (Pulse-Amplitude Modulation, 16 level)

Users can set the bit/signaling rate, basic pulse shape characteristics, and transition time. Any AWG channel may be selected to generate either a serial signal or a :2 or :4 synchronous clock. A series of standard PRBS sequences with different lengths may be selected in order to produce realistic traffic and to allow bit-error rate testing with standard BER testers. Signals may be corrected for cabling and the AWG frequency response in a channel by channel basis. Additionally, external correction data may be applied to account for the distortions added by additional cabling, passive or active system blocks or test fixturing. Channel to channel skew can be also adjusted with resolutions as low as 100fs. The application takes care of handling the requirements and limits of the target hardware with respect to maximum and minimum record lengths, sampling rate, and record length granularity. As a result, generation of the signals designed in this tab will always be feasible by the instrument and free of distortions such as wrap-around or timing artifacts at any signal domain (time, frequency, and modulation), even if the signal is generated in looped mode.

Figure 18 on page 76 display the **Serial Data Waveform** tab and its controls.

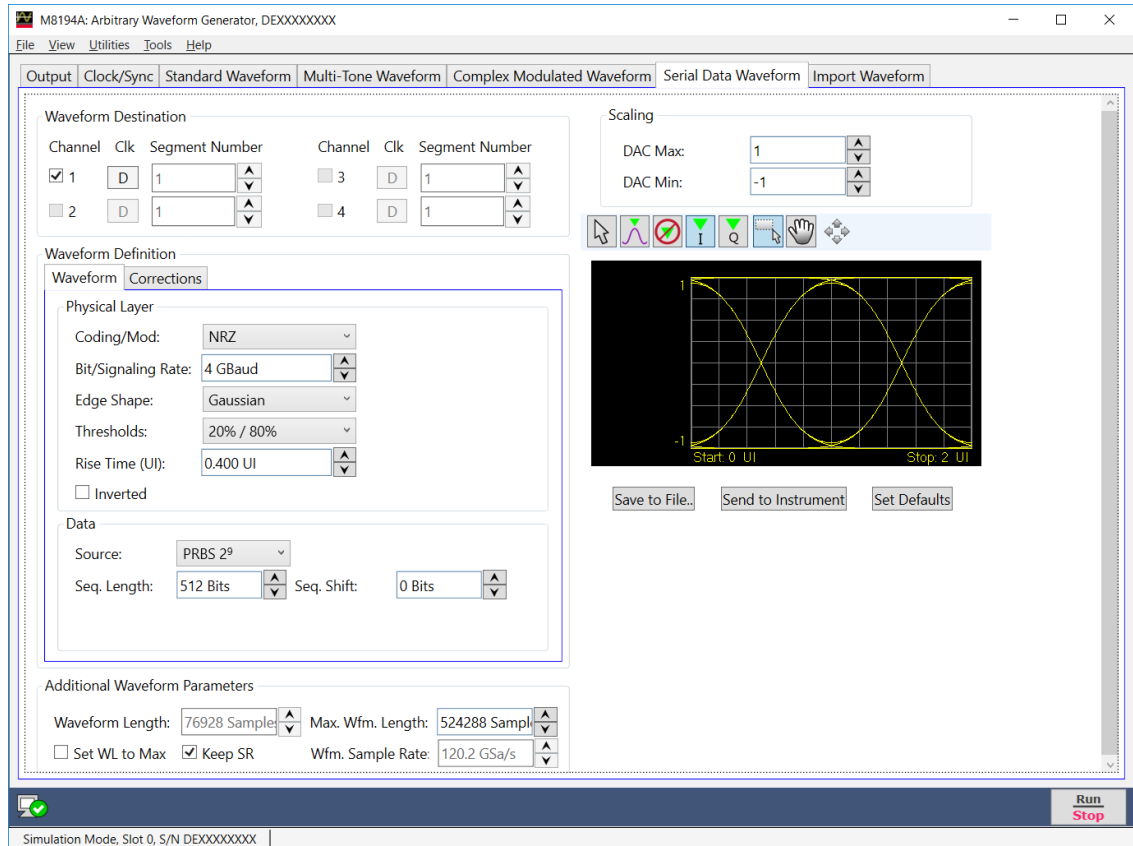

Figure 18 Serial data waveform tab

Only relevant parameters and edition fields are shown in the GUI at any time depending on the selected channel coding scheme.

Waveform Destination Section

- **Clock Toggle buttons**

Data/clock selection toggle buttons for each channel. The Data(D), Clock:2 (C/2), and Clock:4 (C/4) can be independently assigned to each channel. The nominal timing for the 50% level in the raising edge for the clock signals is located in the center of the eye for the current symbol.

- **Channel**

Independent check boxes allow the definition of waveforms for Channel 1, Channel 2, Channel 3, or Channel 4. One of the boxes will be always selected. When pressing the 'Send To Instrument' button, the corresponding waveforms are sent to all channels that are selected.

- **Segment Number**

The segment number is 1. Please note that the segment number section is only kept for compatibility to M8195A AWG.

Waveform Definition Section

The **Waveform Definition** section is organized in two tabs in which controls are grouped by their functionality: Waveform, Data, and Corrections.

The screenshot shows the 'Waveform Definition' dialog box with the 'Corrections' tab selected. The 'Physical Layer' section contains the following controls:

- Coding/Mod: NRZ (dropdown)
- Bit/Signaling Rate: 4 GBaud (text input with up/down arrows)
- Edge Shape: Gaussian (dropdown)
- Thresholds: 20% / 80% (dropdown)
- Rise Time (UI): 0.400 UI (text input with up/down arrows)
- Inverted

The 'Data' section contains the following controls:

- Source: PRBS 2⁹ (dropdown)
- Seq. Length: 512 Bits (text input with up/down arrows)
- Seq. Shift: 0 Bits (text input with up/down arrows)

Waveform Tab:

- **Physical Layer Section**

Physical characteristics of the waveform can be set up in this tab. These include the following controls:

- **Coding/Mod.**

This drop-down list selects the different channel coding and modulation schemes that are supported (see list above). NRZ is the default selection.

- **Bit/Signaling Rate**

This edition field should be used to enter the signaling speed (or baud rate) for the modulated signal expressed in Bauds (1 Baud = 1 Symbol/s). Baud rate is equal to the bit rate for two-level line coding schemes. 4GBaKeysight TechnologiesKeysight Technologiesud is the default value.

- **Edge Shape**

This drop-down list allows the selection of shape for the transitions (edges); choices are 'Rectangular', 'Trapezoidal' (linear), First Order (RC network), 'Gaussian', 'Bessel Thompson' (4th order Bessel-Thomson reference receiver filter), 'Raised Cosine' and 'Root Raised Cosine' (Square Root Raised Cosine).'

Notes:

- The default edge shape is 'Gaussian'.
- For clock signals (i.e. the Clock Toggle button is set to 'C/2' or 'C/4') the edge shape is always Gaussian.

- **Thresholds**

This drop-down list sets the level threshold convention for the measure rise/fall time parameters. Choices are b_20_80 (20%-80%) and b_10_90 (10%-90%). 20%-80% is the default selection for this control.

- **Rise Time (UI)**

Rise/fall times can be set-up through this edition field. Time must be expressed in UIs (Unit Interval) as a fraction of the symbol duration. Rise time can be set up for all the edges shapes except for the Unfiltered, Raised-Cosine and Square Root of Raised-Cosine shapes. Rise time is fixed for clock signals to two sample periods in order to minimize clock jitter. 400mUI (0.4 UI) is the default value for this field.

- **Alpha**

This edition field only shows up when the Raised Cosine and Square-root of Raised Cosine edge shapes are selected. With it, the excess bandwidth parameter (alpha) of the isolated pulses can be set up. Alpha = 1.0 is the default value.

- **Inverted**

This check box (if selected) reverses the polarity of the output waveform. Default state is unselected.

- **Data Section**

The sequence of data to be generated can be set up in this tab. To do so, the following control are available:

- **Source**

This drop-down list allows the selection of different pseudo random binary sequences as data sources for signal generation. Choices are PRBS 27-1 (Polynomial x^7+x^6+1), PRBS 29-1 (Polynomial x^9+x^5+1), PRBS 210-1 (Polynomial $x^{10}+x^7+1$), PRBS 27 (Polynomial x^7+x^6+1), PRBS 29 (Polynomial x^9+x^5+1), PRBS 210 (Polynomial $x^{10}+x^7+1$), PRBS 211 (Polynomial $x^{11}+x^9+1$), and PRBS 215 (Polynomial $x^{15}+x^{14}+1$). The sequences are identified by its non-repeating length. The $2x$ sequences add an extra '0' to the longest sequence of consecutive '0' in the corresponding $2x-1$ sequence.

- **Seq. Length**

This edition field may be used to set a given data length to be implemented by the modulated signal. This field defaults to the maximum non-repeating length of the selected PRBS. It also defaults to this value if the user types '0' (Zero). Otherwise, the sequence will be truncated when the number of bits set by this control is reached. If this number is longer than the PRBS maximum length, the sequence will be re-started as many times as necessary. The actual number of symbols (and record length) in the waveform memory will depend on the line coding/modulation and record length granularity requirements. The simultaneous generation of a clock signal can also influence on the actual sequence length as an integer number of clock cycles must be accommodated to keep its integrity (i.e. ISI distortion free characteristics).

- **Seq. Shift**

This numeric edition field adds a shift to the PRBS sequence being generated by each channel. In this way, uncorrelated data streams may be generated to simulate multi-lane links (i.e. to test the effects of crosstalk) or to emulate IQ baseband channels to feed electrical or optical coherent quadrature modulators. The shift added to each channel may be calculated (in bits) for each channel using the

expression $\text{Shift} = (\text{Channel Number} - 1) * (\text{Seq. Shift})$. Unshifted PRBS sequences always start with the longest run of '1' for that particular sequence.

Corrections Tab:

The purpose of these controls is the correction (de-embedding) of different linear distortions and differential delays added by cabling and fixturing, PCB interconnections, etc.

Waveform Definition

Waveform Corrections

Corrections

Channel Specific Frequency and Phase Response

Standard Cable

File..

Timing Alignment

CH1 Skew: 0 ps ▲▼

CH2 Skew: 0 ps ▲▼

CH3 Skew: 0 ps ▲▼

CH4 Skew: 0 ps ▲▼

The following controls are included:

- **Channel Specific Frequency and Phase Response**

This check box activates the application of corrections based on frequency-domain calibration data stored in the target instrument in non-volatile memory. It improves flatness and linear phase distortions.

- **Standard Cable**

This check box activates the application of correction factors based on a typical 2.4 mm connector, high-quality, high-bandwidth 0.85m cable (Huber+Suhner type N4910-61601).

- **File...**

Opens a correction file selection dialog box. Default file extension is CSV (Comma-Separated Values). The name of the successfully loaded correction factors file is shown in the field located at the left of this button. The accepted format for correction files may be found in the Correction File Format section. In particular, adaptive equalizer models obtained through the Keysight 89600 VSA software can be imported through this procedure to compensate for linear distortions added by any intermediate component, PCB trace, or cable. To obtain this model, apply a NRZ signal with sufficient bandwidth to an 89600 equipped oscilloscope and export the resulting equalizer model. Isolated pulse characteristics of the waveform must be known by the 89600 software so it is advisable to calibrate the SUT (System Under Test) using a Raised-Cosine signal with $\alpha = 1$ to maximize the nominal bandwidth for a given bit rate. The 89600 software must be set up to analyze a BPSK signal with the same baud rate and baseband filter characteristics.

- **CH1 Skew / CH2 Skew / CH3 Skew / CH4 Skew**

These numeric fields can be used to set-up the absolute delay for each channel in seconds. The valid range for them is -100ps ... +100ps. This feature may be used to control the skew of data and clock signals.

Additional Waveform Parameters Section

- **Waveform Length**

This field is an indicator only. Its length is in samples of the resulting segment.

- **Max. Length**

Maximum waveform length should be used to force the resulting waveform to be shorter or equal to a limit set by the user.

- **Keep Sample Rate**

This check box preserves the sampling rate to a user-defined value irrespective of any other defined signal parameter. Keeping the sampling rate to a fixed value may be necessary when multiple waveforms are created for usage in a sequence or scenario. By default, this check box is selected. The “Set WL to Max” check box gets activated when this check box is selected.

- **Set WL to Max**

This check box is only available when “Keep Sample Rate” is selected. When this option is selected, the waveform calculation algorithm always takes the maximum waveform length as defined in the “Max. Wfm. Length” field. As the waveform length must always be identical for all four channels, it is recommended to check the “Set WL to Max”

box in case different waveforms from different SGFP tabs shall be downloaded to different channels. Record length are calculated to contain an integer number of complete PRBS sequences except when the “Set WL to Max” is selected. In this case the number of symbols in the resulting waveform will be the closest integer for the signaling rate set by the user. As a result, signaling rate will be adjusted, if necessary, so it is consistent with the resulting time window (Time Window = Record Length * Sampling Rate).

- **Sample Rate**

Indicator only. It is the final DAC conversion rate for the resulting signal. It is automatically calculated depending on other signal parameters if the “Keep Sample Rate” check box is not selected.

Marker Mode

These controls are available when the “Single Channel with Marker” or “Dual Channel with Marker” mode is selected in the **Output** tab. See [Output Tab](#) on page 42.

- **Ch. 2 (Marker 1)**

Marker 1 is output on Channel 2. Signaling the beginning of the Channel 1 waveform may be activated (Segment selection) and deactivated (None selection).

- **Ch. 3 (Marker 2)**

Marker 2 is output on Channel 3. Signaling the beginning of the Channel 1 waveform may be activated (Segment selection) and deactivated (None selection).

Scaling Section

- **DAC Max**

Standard waveforms may occupy a limited range of the DAC’s full scale. This parameter sets the maximum level. If set to a lower level than DAC Min, this will be automatically set to the same level. Acceptable range for this parameter is $-1/+1$, being the full dynamic range of the instrument’s DAC.

- **DAC Min**

Standard waveforms may occupy a limited range of the DAC’s full scale. This parameter sets the minimum level. If set to a higher level than DAC Max, this will be automatically set to the same level. Acceptable range for this parameter is $-1/+1$, being the full dynamic range of the instrument’s DAC.

Compilation and Panel Control Section

- **Save To File...**

Signals can be stored in files in BIN format. These files may be reused within the **Import Waveform** tab.

The waveform is always saved without applying corrections. Also, the waveform of the data signal (Clock Toggle button is set to 'D') and not the clock signal (Clock Toggle button is set to 'C/2' or 'C/4') is saved.

- **Send To Instrument**

Signal will be transferred to the selected segments of the selected channels. The previous running status for the target instrument will be preserved but sampling rate may be modified depending on the waveform requirements.

- **Set Default**

All the waveform parameters are set automatically to their corresponding default values.

- **Abort**

This button allows canceling signal calculation at any moment. It only shows up during signal compilation.

Import Waveform Tab

The **Import Waveform** tab is used to perform the functions such as importing, scaling, and re-sampling waveform files in a variety of formats for their generation by the M8194A Arbitrary Waveform Generator. It provides the controls which allow the complete definition of signal processing parameters for the waveform file format (see [File Format](#)).

Depending on the file format and contents, information regarding the original sampling rate of the input waveforms can be extracted and re-used within the import tool. Re-sampling is performed so no images or aliases show up in the re-sampled waveform.

Figure 19 on page 84 display the **Import Waveform** tab and its controls.

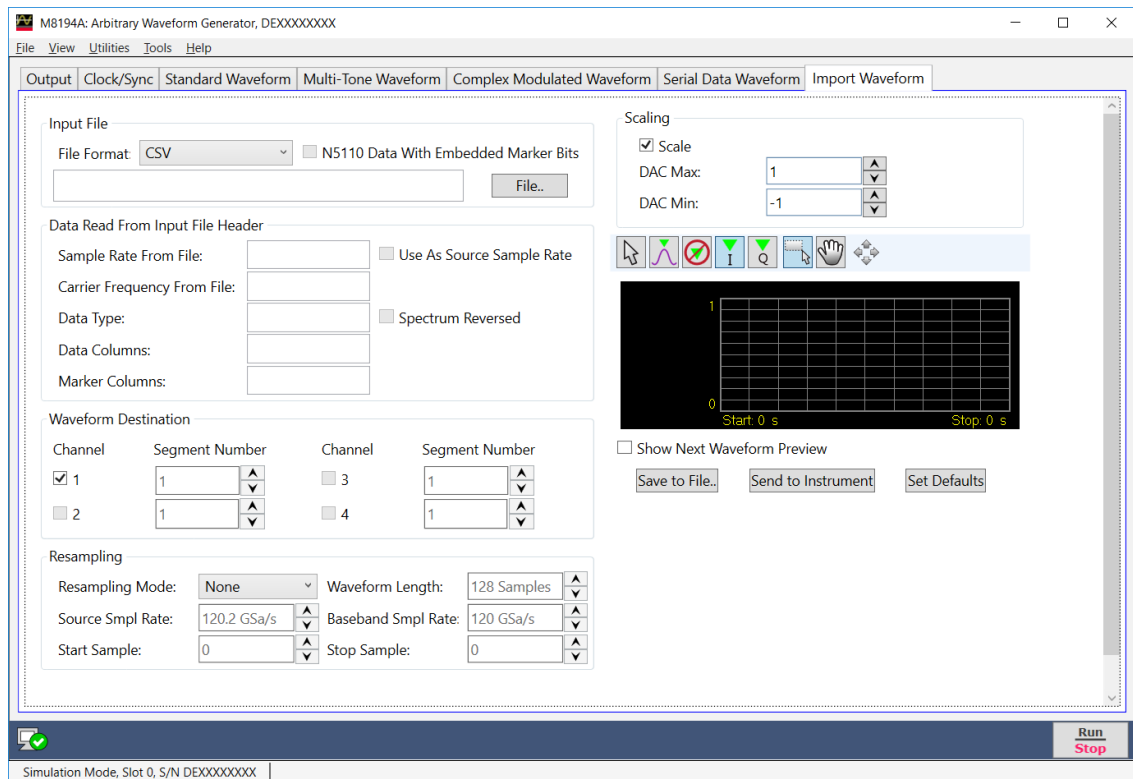

Figure 19 Import Waveform tab

This tab has the following controls and indicators:

Input File Section

- **File Format**

For details on the available file format, see [File Format](#).

Sample waveform data files are available in different formats as listed in the [Table 7](#) on page -85. The files can be simply imported using the Input File section and can be sent to the instrument to view the waveform preview. The sample waveform data can be found at the location: **Start > All Programs > Keysight M8194 > Keysight M8194 Examples**

Steps to view the sample data file waveform preview:

- 1 Select the **Show Next Waveform Preview** check box.
- 2 Select the required **File Format** from the drop-down list.
- 3 Click **File...**
- 4 In the **Open** dialog box, select the sample waveform file (as per selected file format)
- 5 Click **Open**.
- 6 Click **Send to Instrument**.

Table 7 Sample waveform data files

File format	Waveform data file
TXT	Sin125MHzAt120GHz.txt
BIN	Sin125MHzAt120GHz.bin
BIN8	Sin125MHzAt120GHz.bin8
BIN6030	Sin125MHzAt120GHz.bin6030
BIN5110	SinDelta125MHzIQ.bin5110
IQBIN	SinDelta125MHzIQ.iqbin
MAT89600	Sin125MHzAt120GHz.mat89600
CSV	Sin125MHzAt120GHz.csv
DSA90000	Sin125MHzAt120GHz.dsa90000

- **N5110 Data With Embedded Marker Bits**

This check box is only enabled, if the file format is BIN5110. When this check box is selected, the BIN5110 format with 14-bit data for I and Q and embedded marker bits is used. If unselected, the BIN5110 format with 16-bit data for I and Q and no marker bits is used.

- **File...**

This button opens a file selection dialog. Default file extensions match the file format selection. Once the file is successful loaded, the waveform updates multiple information fields through the panel reflecting the waveform settings and a graph of the waveform is shown in the preview display.

Data Read From Input File Header Section

- **Sample Rate From File**

This field is an indicator only. It shows the input waveform sample rate, if any, contained in the loaded file. If no sample rate is specified “n.a.” (not available) is shown.

- **Use As Source Sample Rate**

This check box assigns the sample rate specified in the file as the Source Sample Rate used for re-sampling.

- **Carrier Frequency From File**

This field is an indicator only. It shows the input waveform carrier frequency, if any, contained in the loaded file. If no carrier frequency is specified “n.a.” (not available) is shown.

- **Data Type**

This is the organization of samples within the file. It may be Single (real-only waveform) or IQ (complex waveforms).

- **Spectrum Reversed**

This check box is only active for complex (IQ) waveforms. It results in an imported signal which is the complex conjugate of the input signal, thus its spectrum will be reversed.

- **Data Columns**

This field shows the internal organization of the file regarding waveforms. It can show from one column (Y1) up to 4 (Y1, Y2, Y3, Y4).

- **Marker Columns**

This field shows the internal organization of the file regarding markers. It can show from one column (M1) up to 4 (M1, M2, M3, M4).

Waveform Destination Section

- **Channel**

Independent check boxes allow to import waveforms for Channel 1, Channel 2, Channel 3 or Channel 4. One of the boxes is always selected. If the file contains only one waveform, when pressing the 'Send To Instrument' button, the waveform is sent to all channels that are selected. If the file contains multiple waveforms (file types MAT89600 and CSV), they can be sent to multiple channels in one operation.

The following two tables show the standard column-to-channel mapping for the case of no additional data header in the CSV file or no reordering of the column names in the MAT89600 file.

Table 8 Standard column-to-channel mapping in four-channel mode

Number of columns in file for real values	Import and download to M8194A, when corresponding channel box is selected
1.	Column 1 to Ch 1 and Ch 2 and Ch 3 and Ch4
2.	Column 1 to Ch 1 and Column 2 to Ch 2
3.	Column 1 to Ch 1 and Column 2 to Ch 2 and Column 3 to Ch 3
4.	Column 1 to Ch 1 and Column 2 to Ch 2 and Column 3 to Ch 3 and Column 4 to Ch 4

Table 9 Standard Column to channel mapping in two-channel mode

Number of columns in file for real values	Import and download to M8194A, when corresponding channel box is selected
1.	Column 1 to Ch 1 and Ch4
2.	Column 1 to Ch 1 and Column 2 to Ch 4
3.	Column 1 to Ch 1 and Column 2 to Ch 4, Column 3 is ignored
4.	Column 1 to Ch 1 and Column 2 to Ch 4, Column 3 and 4 are ignored

For MAT89600 file and CSV file with data header, the mapping shown below applies:

Table 10 Modified column-to-channel mapping in four-channel mode

Name of column	Import and download to M8194A, when corresponding channel box is selected
Y1	Ch 1
Y2	Ch 2
Y3	Ch 3
Y4	Ch 4

Table 11 Modified column-to-channel mapping in two-channel mode

Name of column	Import and download to M8194A, when corresponding channel box is selected
Y1	Ch 1
Y2	Ch 2
Y3	Ignored
Y4	Ch 4, if Y2 is not present; ignored, if Y2 is present

- **I/Q Toggle buttons**

I/Q selection toggle buttons for each channel is shown when the file containing an I/Q waveform is selected for import. In-Phase (I) and Quadrature (Q) components can be independently assigned to each channel.

- **Segment Number**

The segment number is 1. Please note that the segment number section is only kept for compatibility to M8195A AWG.

Resampling Section

- **Resampling Mode**

It controls the way waveforms are imported and resampled. Please refer to the description of the Resampling Methodology in the Chapter , “Appendix,” on page 177. The following modes are available:

- **None:** Baseband Sample Rate will be the same as the Source Sampling Rate. The output waveform will use the same number of samples as the selected portion of the input waveform. Granularity requirements will be met by repeating the basic waveform the minimum number of times so the combined length is a multiple of the granularity for the current DAC mode.
- **Timing:** The time window of the input signal (Waveform Length / Sample Rate) will be used to calculate the best value for the output record length being a multiple of the granularity for the current DAC mode according to the output sampling rate defined by the user. Final output sampling rate will be slightly adjusted to accurately keep the timing of the original signal.
- **Output_SR:** The user-defined output sampling rate will be used to calculate the best value for the output record length being a multiple of the granularity for the current DAC mode according to the time window of the input signal. Final time window will be slightly adjusted to keep the selected output sampling rate. This change is reflected in the Source Sampling Rate numeric entry field value.
- **Output_RL:** The user-defined output Waveform Length will be used to calculate the best value for the output Sample Rate according to the time window of the input signal. Waveform Length will be adjusted to the nearest multiple of the granularity for the current DAC mode according to the time window of the input signal.
- **Zero_Padding:** Output Waveform Length is calculated based on the input waveform time window and the user-defined output sampling rate. The resulting waveform length will not be, in general, a multiple of the granularity. To meet the granularity conditions, a number of zero samples are added until the combined number of samples is a multiple of the granularity. Output Sample Rate will be slightly adjusted to keep the input waveform time window.

- **Truncate:** Output Waveform Length is calculated based on the input waveform time window and the user-defined output sampling rate. The resulting waveform length will not be, in general, a multiple of the granularity. To meet the granularity conditions, a number of samples is removed until the resulting number of samples is a multiple of the granularity. Output Sample Rate will be slightly adjusted to keep the input waveform time window.
 - **Repeat:** Output Waveform Length is calculated based on the input waveform time window and the user-defined output sampling rate. The resulting waveform length will not be, in general, a multiple of the granularity. To meet the granularity conditions, the base waveform is repeated the minimum number of times so the overall number of samples is a multiple of the granularity. Output Sample Rate will be slightly adjusted to keep the input waveform time window. The Waveform Length field will show the length of the combined waveform.
- **Waveform Length**
This field shows the number of samples of the resampled output waveform. It can be set when Resampling Mode is "Output_RL". Otherwise, this field behaves as an indicator.
- **Source Sample Rate**
The speed at which samples in the input waveform are sampled. It can be set by typing a valid value unless the "Use As Source Sample Rate" check box is selected. In this particular case, the sampling rate information contained in the input waveform file will be always used.
- **Baseband Sample Rate**
This field denotes the speed at which samples in the output waveform will be converted. It can be set in all "Resampling Modes" except for the "Output_RL" mode.
- **Start Sample**
This field can be used to select the starting sample of the section of the input waveform to be imported. It cannot be set to a value higher than the "Stop" Sample.
- **Stop Sample**
This field can be used to select the final sample of the section of the input waveform to be imported. It cannot be set to a value lower than the "Start" Sample.

- **Scale**

This check box controls the way the input output waveform will be scaled after resampling. If unselected, the output waveform samples will not be re-scaled. Sample levels over +1.0 or under -1.0 will be clipped.

Scaling Section

- **DAC Max**

Imported waveforms may occupy a limited range of the DAC's full scale. This parameter sets the maximum level. If set to a lower level than DAC Min, this will be automatically set to the same level. Acceptable range for this parameter is -1/+1, being the full dynamic range of the instrument's DAC.

- **DAC Min**

DAC Max: Imported waveforms may occupy a limited range of the DAC's full scale. This parameter sets the minimum level. If set to a higher level than DAC Max, this will be automatically set to the same level. Acceptable range for this parameter is -1/+1, being the full dynamic range of the instrument's DAC.

Preview Section

Waveform Preview Toolbar

The waveform preview toolbar includes the icons which provide different functionality to preview the waveform. For details, see "[Preview Section](#)" on page -54.

- **Show Next Waveform Preview**

This check box affects the behavior of the preview for the next waveform. If selected, a preview of the imported waveform is displayed when a waveform file is imported. You can leave this check box unselected to speed up the import of large waveforms.

- **Save To File...**

Use this button to store the waveform signals. It can be stored either in BIN (for non IQ modes) or IQBIN (for IQ modes) formats. These files may be reused within the **Import Waveform** tab.

- **Send To Instrument**

Use this button to send the waveform signal to the selected segments of the selected channels. The previous running status for the target instrument will be preserved but sampling rate may be modified depending on the waveform requirements.

- **Set Default**

Use this button to set the standard waveform parameters automatically to their corresponding default values.

Supported File Types

TXT

Compatibility: Keysight M8190A, Tek AWG 7000

One file contains waveform samples for one M8194A channel as normalized values (-1.0 .. +1.0) and (optionally marker values) separated by ',' or ';' or '\t'. Not given marker values are just set to 0. Space ' ' and '\t' are ignored. Line end can be '\r' or '\r\n'. The waveform samples can be imported to any of the four M8194A channels.

Example (US locale)

0.7,0,1

0.9,1

Example (German locale):

0,7;0;1

0,9;1

NOTE

In German locale it is recommended (but not required) to use ';' or '\t' as separator. But it must then be ensured that the double really has a decimal point (,) or there is some space inserted to ensure correct parsing:

0,7,0,1

0,0,1

BIN

Compatibility: Keysight M8194A.

One file contains waveform samples for one channel. The waveform samples can be imported to any of the four M8194A channels. Samples consist of binary int16 values (in little endian byte order).

15	14	13	12	11	10	9	8	7	6	5	4	3	2	1	0
DB13	DB12	DB11	DB10	DB9	DB8	DB7	DB6	DB5	DB4	DB3	DB2	DB1	DB0	SYNM	SMPM

When imported the MSBs DB13 to DB6 are used as 8-bit sample values. All other bits including marker bits SYNM and SMPM are ignored.

BIN8

BIN8 is the most memory efficient file format for the M8194A without digital markers. As a result, the fastest file download can be achieved

One file contains waveform samples for one channel. The waveform samples can be imported to any of the four M8194A channels. Samples consist of binary int8 values:

7	6	5	4	3	2	1	0
DB7	DB6	DB5	DB4	DB3	DB2	DB1	DB0

IQBIN

Compatibility: Keysight M8190A.

One file contains waveform samples for two M8190A channels plus optionally digital marker information.

Channel mapping

I is mapped to channel 1

Q mapped to channel 2

Sample Marker 1 is ignored

Sample Marker 2 is ignored

BIN6030

Compatibility: Keysight N6030

Binary int16 values (in little endian byte order). The Keysight N6030 has 15 bits and uses the most significant digits, ignoring the LSB.

15	14	13	12	11	10	9	8	7	6	5	4	3	2	1	0
DB13	DB12	DB11	DB10	DB9	DB8	DB7	DB6	DB5	DB4	DB3	DB2	DB1	DB0	X	X

BIN5110

Compatibility: Keysight 5110A

Binary int16 I/Q sample pairs (in little endian byte order). May contain full 16 bit DAC values without the marker bits or 14 bit value plus two markers.

When importing 16 bit values without markers the marker flag should be set to 'OFF' so that 8 LSB are ignored.

15	14	13	12	11	10	9	8	7	6	5	4	3	2	1	0
I13	I12	I11	I10	I9	I8	I7	I6	I5	I4	I3	I2	I1	I0	X	SMPM
Q13	Q12	Q11	Q10	Q9	Q8	Q7	Q6	Q5	Q4	Q3	Q2	Q1	Q0	X	SYNM

MAT89600

Compatibility: Keysight 89600 VSA

One file contains waveform samples for one or two or three or four M8194A channels. It is a 89600 VSA recording file in MATLAB binary format (.mat) containing floating point values (without markers). Only MATLAB level 4.0 and 5.0 files are supported.

MATLAB binary files with one, two, three or four columns are supported. If the MATLAB file consists of one column, the data can be imported to channel 1 or channel 2 or channel 3 or channel 4. If it consists of multiple columns, column 1 can be imported to channel 1, column 2 to channel 2, column 3 to channel 3 and column 4 to channel 4.

If it consists of multiple columns, the handling depends on the number of available channels.

Four-channel mode: Column 1 can be imported to channel 1, column 2 to channel 2, column 3 to channel 3 and column 4 to channel 4,

Two-channel mode: Column 1 can be imported to channel 1, column 2 to channel 4. If column 2 is not present, column 4 can be imported to channel 4.

Both real and complex I/Q data formats are supported. For I/Q format the values are stored as array of complex numbers with the real part corresponding to I value and the imaginary part corresponding to Q value. The header variable 'XDelta' (1/XDelta) is used to set the currently selected sample frequency.

DSA90000

Compatibility: Keysight DSA90000 Oscilloscope

One file contains waveform samples for one M8194A channel. The waveform samples can be imported to any of the four M8194A channels.

DSA90000 waveform file in binary format (.bin) containing header and floating point data (without markers). Only waveform type 'Normal' is supported. If the file contains more than one waveform only the first waveform will be imported.

CSV

Compatibility: M8190A

One file contains waveform samples for one, two, three, or four M8194A channels.

Normalized values (-1.0 .. +1.0) and markers in comma delimited format. Without header information, the columns are pre-defined in the following way:

- 1 column: waveform data for channel 1
- 2 columns: waveform data for channel 1 & 2
- 3 columns: waveform data for channel 1 & 2 & 3
- 4 columns: waveform data for channel 1 & 2 & 3 & 4

If the file consists of one column, the data can be imported to channel 1 or channel 2 or channel 3 or channel 4. If it consists of multiple columns, the handling depends on the number of available channels.

Four-channel mode: Column 1 can be imported to channel 1, column 2 to channel 2, column 3 to channel 3 and column 4 to channel 4,

Two-channel mode: Column 1 can be imported to channel 1, column 2 to channel 4. If column 2 is not present (possible when a data header is used, see below), column 4 can be imported to channel 4.

Examples:

1 channel (without markers):

0.7

0.9

...

2 channel (without markers):

0.7,0.7

0.9,1.0

...

3 channels (without markers):

0.7,0,65,0.36

0.8,0,66,0.35

0.9,0,67,0.34

...

4 channels (without markers):

0.7,0,65,0.36,-0.1

0.8,0,66,0.35;-0.2

0.9,0,67,0.34;-0.33

...

The CSV format may contain optional header information as follows:

- Parameter Header - The parameter header contains optional header parameters as name and value pairs separated by '='. Each parameter should be specified in a single line. This header is optional. There are following header parameters:
 - SampleRate - The sample rate.
 - SetConfig - Flag to indicate if the header parameters need to be set. This can be set to either 'true' or 'false'. If this flag is 'false' header parameters will not be set. If this flag is omitted header parameters are set.
 - Data Header - The data header contains the names of the data columns separated by ','. The waveform data are specified after the data header. This header is optional. If this header is not specified the data need to be defined similar to CSV files without the header (see above). The data columns are as follows:
 - Y1 - Waveform data for channel 1.
 - Y2 - Waveform data for channel 2.
 - Y3 - Waveform data for channel 3.
 - Y4 - Waveform data for channel 4.
 - SampleMarker1 - Sample Marker for channel 2.
 - SampleMarker2 - Sample Marker for channel 3.

Notes: If any of the marker columns (SampleMarker1 or Sample Marker2) is present for a channel the data header must contain the waveform data column (Y1 or Y2). It is possible to have only the data columns (Y1 , Y2, Y3, Y4 or any combination) without the marker columns though.

Examples:

SampleRate = 7.2 GHz

Y1, Y2, SampleMarker1, SampleMarker2

0.7,0.7,0,0

0.9,1.0,0,1

0.3,-0.3,1,1

...

Y1, SampleMarker1

0.7,0

0.9,1

0.3,0

...

Y1, SampleMarker1, SampleMarker2

0.7,0,0

0.9,0,1

0.3,1,1

...

Y1, Y2, Y4

0.7,0,65,0.36

0.8,0,66,0.35

0.9,0,67,0.34

...

Correction File Format

A correction file is an ASCII delimited file carrying all the information required to compensate or embed a given frequency response in the multi-tone or complex modulation signal. The file must be composed of a header including a series of lines with identifiers and parameters, and a list of numerical correction factors. In lines including more than one item (i.e., one identifier and one parameter), the items must be separated using commas. Identifiers and parameters are not case sensitive.

These are the significant fields for the header:

- **InputBlockSize:** It states the number of valid correction factors in the file. It is a mandatory field.
- **XStart:** It is frequency in Hz corresponding to the first entry in the correction factor section of the file. It is a mandatory field for multi-tone generation in direct mode and optional for multi-tone in upconverter mode and complex modulation.
- **XDelta:** It is frequency distance in Hz between consecutive entries in the correction factor section of the file. It is a mandatory field.
- **YUnit:** Units for the amplitude values in the correction factor section of the file. Parameter associated to it may be 'dB' (for logarithmic relative amplitudes) or 'lin' (for dimensionless linear relative amplitude). This parameter is optional and its default value is 'lin'. Phase unit must be always stated in radians.

The order of the above entries is not relevant. The correction factor section starts with a line including a single 'y' or 'Y' character. Entries in this section are made by Amp1(Fi), Phase1(Fi) pairs. In particular, this format is compatible with adaptive equalizer files exported in comma-separated value (CSV) format from the Keysight 89600 VSA software package. These files reflect the channel response corrected by the equalizer so they should be applied through the selection of the 'Channel_Response' option in the corresponding 'Correction Mode' drop-down list in the 'Corrections' section of the 'Multi-Tone' or 'Complex Modulation' panel, respectively. Comments must start with the '/' character sequence and may use a complete line or be located at the end of any valid line. Empty lines are also valid.

This is an example correction file:

```
// MyCorrectionFile
InputBlockSize, 1024
XStart, 1.0E+09 // 1.0GHz
```

```

XDelta, 1.0E+06
YUnit, lin
Y
0.987, -0.2343
0.995, 0.5674
...
...
1.269, -0.765

```

The above files are is composed of a header with relevant information. In these particular cases, the files contains 1024 linear correction factors spaced by 1 MHz and starting at 1 GHz. The ‘Y’ character indicates the starting point for the correction factor list composed of 1024 lines with amplitude/phase pairs separated by commas. For one-channel files there is a amplitude/phase pair per line while for two channel files there are two pairs (Amp1, Phase1, Amp2, Phase2).

The way this information is applied by the Soft Front Panel software depends on the signal generation mode and the signal category. For direct conversion multi-tone RF generation modes (‘Generate IQ Data’ unselected), corrections are applied directly to the tones based on their absolute frequency. For up-converted multi-tone baseband generation (I/Q) modes (‘Generate IQ Data’ selected), corrections are applied to the complex baseband signals. So, the internal or external carrier frequency is represented by the central entry in the list (i.e., entry #512 in the 1024 entries example shown above) regardless of the ‘XStart’ parameter. For Complex Modulated waveforms, corrections are always applied to the complex baseband signals regardless of the ‘Generate IQ Data’ check box setting so, as it happens with the correction of multi-tone baseband signals, the internal or external carrier frequency is represented by the central entry in the list.

Converting the 285 MHz Reference Clock into a clock suitable as DCA Precision Timebase input

This section describes how to operate a M8194A with a Keysight Digital Communication Analyzer (DCA). For high quality acquisition, the DCA requires a trigger signal and Precision Time Base (PTB) signal that must be synchronous to actual data signal. Furthermore, the PTB signal must be at least 2 GHz.

If only a subset of the four M8194A channels are needed by the application, an unused M8194A channel can be used to generate both a trigger and PTB signal. Since the polarity of the signal does not matter, the simplest approach is to use the “normal” output as a trigger and the “complement” output of the same AWG channel as a PTB clock.

If all four channels of the M8194A are required by the application, it is recommend to use a Keysight M8197A module for DCA clock and trigger generation. Alternatively, a M8196A or an additional M8194A may be used.

Using M8197A module for DCA Clock and Trigger Generation

Hardware Setup

Connect the M8194A, M8197A, and DCA as follows:

- 1 M8197A, Sys Clock Out 1 → M8194A “Sync In B”
The required cable is supplied with the M8197A. This provides a 250 MHz reference clock signal to the M8194A.
- 2 M8197A, Sys Clock Out 2 → DCA Front Panel Trigger.
The required cable is supplied with the M8197A. This connection provides a trigger signal to the DCA and enables the use of the “Pattern Lock” functionality in the DCA.
- 3 M8197A “Ref Clk Out” → DCA PTB.
Use a standard SMA cable. This connection provides a 2 GHz PTB clock signal to the DCA.

Software Setup

- 1 Launch the M8197A Soft Front Panel, and perform the following steps:
 - a Select **Clock** tab.
 - b Set the switch and divider to get a **2 GHz** Reference Clock OUT.

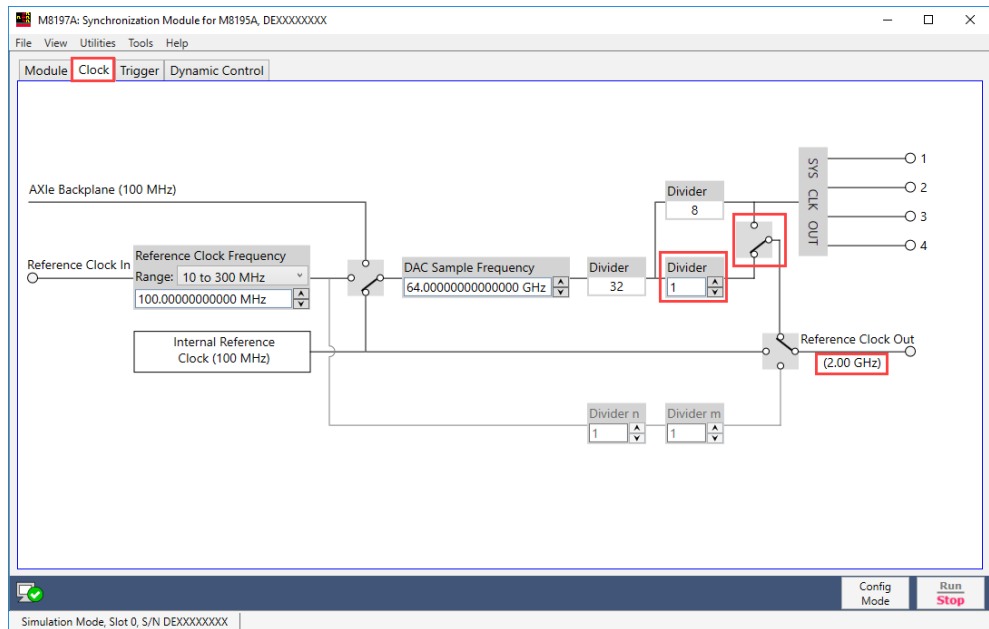

- 2 Launch the M8194A Soft Front Panel, and perform the following steps:
 - a Select **Clock/Sync** tab.
 - b Set the **Reference Clock Source** to **External**.
 - c Set the **Reference Clock Frequency** to 250 MHz.

Ensure that the Sample Clock Frequency is set to a value that is a multiple of 250 MHz.

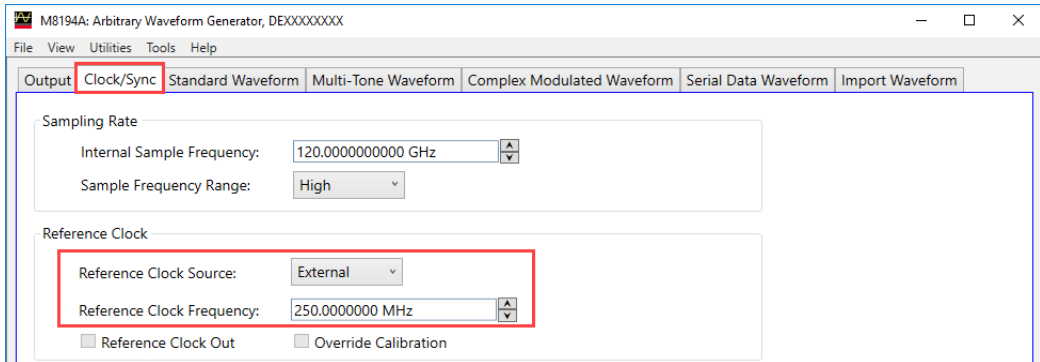

Using M8196A or additional M8194A

To convert the 285 MHz reference clock from “Sync Out B” of the M8194A into a higher speed clock signal using a M8196A or an additional M8194A module, connect the modules as shown in figure:

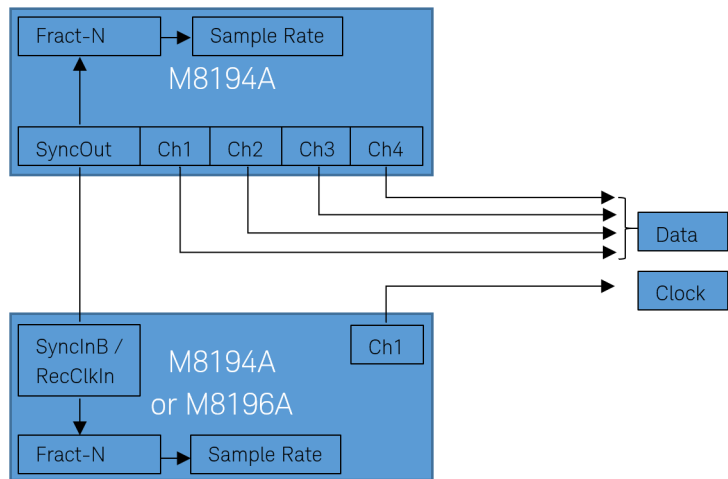

For the clock to be fully phase coherent to the data signals, the Fract-N PLLs in the two instruments must be configured either with identical settings (in case of two M8194A's) or with integer factors for their respective Fractional-N PLLs. Also, the reference frequency in the M8194A's must be set to (exactly) 285 MHz to avoid any rounding errors.

On the M8194A, the following commands must be executed:

:ROSCillator:INTernal:FREQuency 285E6	Pretend that the reference is exactly 285 MHz
:ROSCillator:INTernal:FREQuency:OVerride 1	Use this frequency to set the PLL
:OUTPut:ROSCillator 1	Output the Ref.Clk signal on Sync Out B

If a M8196A is used as a secondary unit, there are only a few possible sample rate ratios with small nominators and denominators that can be used for fully coherent operation:

M8194A sample rate	M8196A sample rate	Ratio
119.700 GSa/s (= 420 * 285 MHz)	89.775 GSa/s (= 315 * 285 MHz)	4/3
119.700 GSa/s (= 420 * 285 MHz)	85.500 GSa/s (= 300 * 285 MHz)	7/5
115.425 GSa/s (= 405 * 285 MHz)	92.340 GSa/s (= 324 * 285 MHz)	5/4

Synchronous Multi-Module System

Up to four M8194A modules (= up to 16 channels) can be configured as a multi-module system. All channels that are part of such a multi-module system operate at the same sample rate and are starting synchronously.

Requirements for a Synchronous System

The requirements for controlling the synchronous system are as follows:

- All M8194A modules that will be part of synchronous system must be plugged into the same 2 slot or 5 slot AXIe chassis. The bottom-most module will be referred to as the “master” module. All others are referred to as “slave” modules.
- An instance of the M8194A firmware (version 2.0.5 or later) must be running for each module prior to configuring the synchronous system.
- All M8194A modules that will become part of the synchronous system must be made visible with their VISA addresses in KCE (Keysight Connection Expert).
- Synchronization cable kits and in some cases an external reference clock source must be connected as described in [Synchronous System Cabling](#) on page 105.

Synchronous System Cabling

For synchronizing N modules, N-1 synchronization cable kits (product number M8194A-830) are required. The synchronization cable kit consists of a blue multi-coax cable and a semi-rigid SMA cable.



Starting with the bottom-most (“master”) M8194A, the blue multi-coax cables are used to connect Sync Out A to the next higher module’s Sync In A connector.

For a synchronous system that consists of two modules, the semi-rigid SMA cable is used to connect Sync Out B of the bottom module to Sync In B of the top module. No external clock generator is required.

2 Modules, internal ref clock

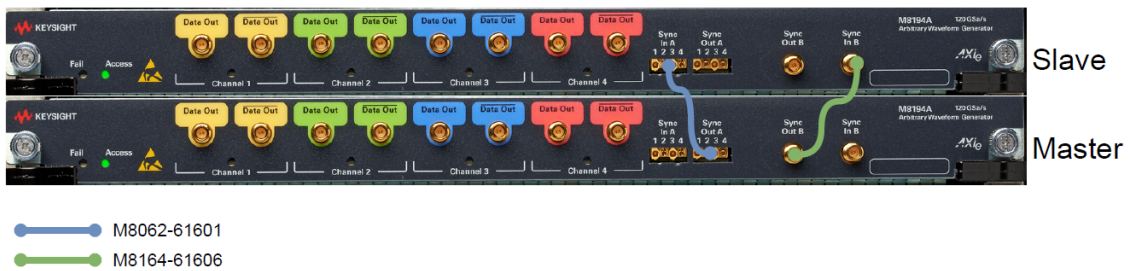

2 Modules, external ref clock

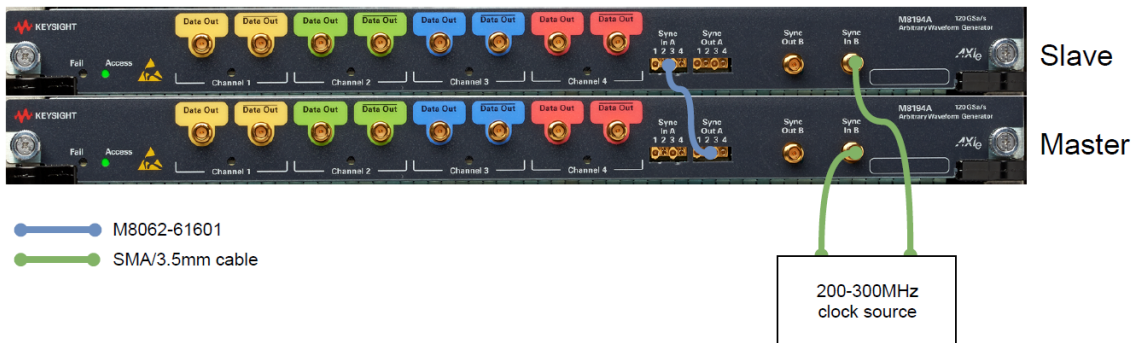

For synchronous systems that consist of three or four modules, an external 250 MHz reference clock signal must be connected to the Sync In B ports of all 3 (4) modules. The suggested way to generate such a 250 MHz clock is an M8197A module, but a user-provided generator that meets the electrical requirements of the Sync In B input and generates the 3 (4) signals with less than 5 ps of skew can be used as well.

4 Modules, ref clock from M8197



If a M8197A module is used for clock generation, the M8197A Soft Front Panel must be running, but nothing needs to be configured in the M8197A Soft Front Panel. The M8197A Soft Front Panel is not used to control the M8194A modules.

Synchronous System Operation Modes

The synchronous system has the following two modes of operation:

- Configuration mode
- Operation mode

The operation mode can be set through a SCPI command or the button on Clock/Sync tab of the Soft Front Panel.

Configuration Mode

The configuration mode is used while connecting external cables of the synchronous system or to set/change the sample clock frequency that will be used the entire synchronous system. Specifically, when defining which M8194A modules belong to the synchronous system, the system must be stopped and set in configuration mode.

Operation Mode

The operation mode is used for data generation and to synchronously start the system. Before you can start data generation, you must switch to operation mode.

When switching from configuration mode to operation mode, the firmware performs the following:

- Verifies the cabling between the master and slave modules.
- Transfers the setting of sample frequency from the master module to the slave module(s).
- Performs delay alignment among all M8194A channels in the synchronous system.

Configuring the Synchronous System

- 1 In the **Clock/Sync** tab of the master (bottom-most) module, click **Discover** under the **Multi Module Synchronization** pane.

The list of modules will be populated with all the potential slave M8194A modules that are found in KCE (Keysight Connection Expert). Alternatively, the VISA addresses of the slave modules can also be configured through SCPI commands.

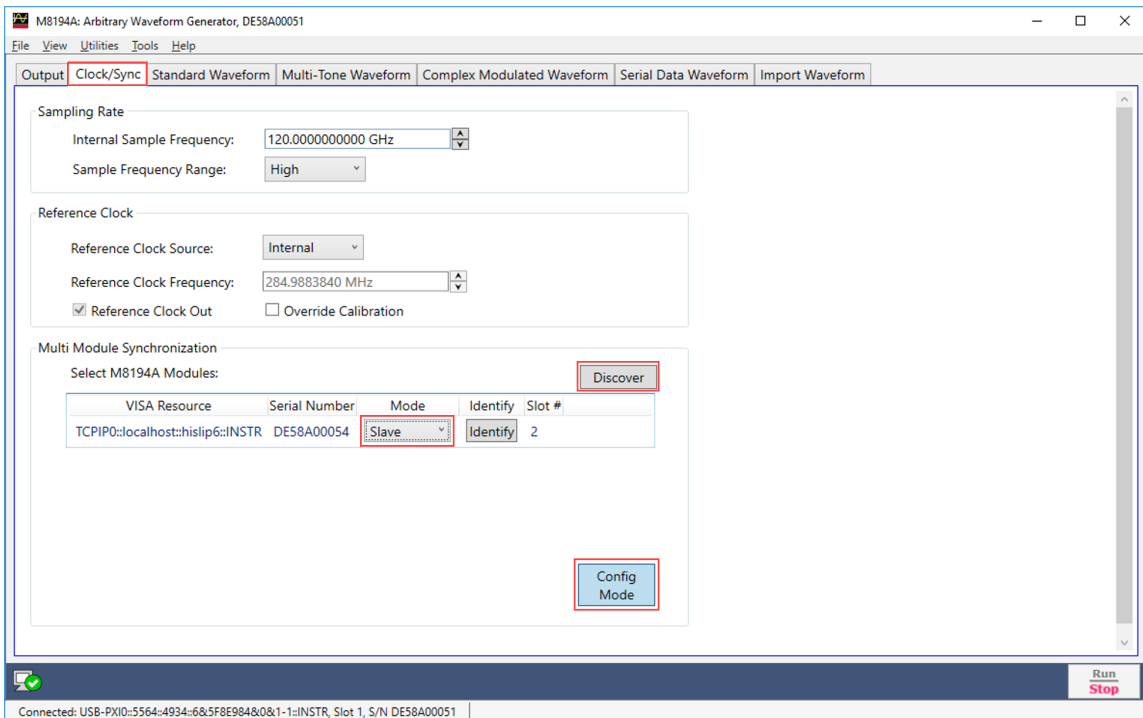

- 2 Change the **Mode** drop-down option from **None** to **Slave** for those modules that should be included in the synchronous system. This causes all GUI controls in the **Clock/Sync** tab as well as the Run/Stop button of the corresponding slave module to be grayed out (disabled).
- 3 Click **Config Mode** button to switch to **Operation Mode**.

Now, you can download waveforms into each channel, turn outputs on or off – as you would in standalone operation. Once you have a waveform loaded in all channels, you can click the Run button on the master module to start synchronous playback.

Stopping Synchronous Operation

To stop waveform playback, click the “Run/Stop” button. You can now download new waveforms and click “Run/Stop” again as long as you don’t need to change the sample rate. If you need to change the sample rate, you have to click on “Operation Mode” button in order to switch back to “Config Mode”.

To exit synchronous multi-module operation altogether and use the modules independently again, switch to “Config Mode” and set the “Mode” drop-down of all the modules to “None”.

4 Remote Programming

[Remote Programming Overview](#) / 112

[Common Commands](#) / 118

[Status Model](#) / 121

[:ABOrt Commands](#) / 131

[:INITiate Commands](#) / 132

[:INSTrument Commands](#) / 133

[:MMEMory Commands](#) / 135

[:OUTPut Commands](#) / 141

[\[:SOURce\] Commands](#) / 143

[:SYSTem Commands](#) / 150

[:TEST Commands](#) / 155

[:TRACe Commands](#) / 156

[Multi-Module Configuration Commands](#) / 165

[SCPI Command Differences Between M8194A and M8196A](#) / 168

Remote Programming Overview

The M8194A can be programmed like other modular instruments using SCPI commands is supported. This chapter introduces the basics for remote programming of an M8194A instrument using SCPI commands.

The M8194A Soft Front Panel talks to the actual M8194A module using a PCI express or USB connection. I/O to the module is done using VISA library of Keysight I/O library. Addressing is done with PXI resource strings, e.g. "PXI36::0::0::INSTR" or USB resource strings, e.g. "USB-PXI0::5564::4819::DE00000001::INSTR". The purpose of the Soft Front Panel is to provide a classic instrument like SCPI interface that is exposed via LAN.

The M8194A Soft Front Panel provides the user interface. It is used for interactively changing settings. In addition, it can log what IVI or SCPI calls need to be done when changing a setting. This can be activated with

Tools > Monitor Driver calls...

SCPI Programming

In addition to IVI programming SCPI programming using a LAN connection is also supported. Three LAN protocols are supported. The correct resource strings are shown in the Soft Front Panel's About window. A context menu is provided to copy the resource strings.

- **VXI-11:** The Visa resource string is e.g. "TCPIP0::localhost::inst0::INSTR".
- **HiSLIP:** This protocol is recommended. It offers the functionality of VXI-11 protocol with better performance that is near socket performance. Visa resource strings look like "TCPIP0::localhost::hislip0::INSTR". To use the HiSlip protocol an I/O library such as the Keysight I/O Libraries Suite must be installed. Since the protocol is new it might not be supported by the installed I/O library. The Keysight I/O Libraries Suite 16.3 and above supports it. However, the Keysight I/O Libraries Suite might be installed as secondary I/O library. In this case, check if the primary I/O library supports HiSLIP. If it does not, the socket protocol must be used.
- **Socket:** This protocol can be used with any I/O library or using standard operating system socket functionality connecting to port 5025. This protocol must be used if the used I/O library is not supporting HiSLIP protocol. Visa resource string looks like "TCPIP0::localhost::5025::SOCKET", the exact resource string can be seen in the Kt8194 Soft Front Panel main window.

NOTE

AgM8194SFP.exe must be started prior to sending SCPI to the instrument. (See [AgM8194SFP.exe](#) on page 113).

AgM8194SFP.exe

Before sending SCPI commands to the instrument, the Soft Front Panel (*AgM8194SFP.exe*) must be started. This can be done in the Windows Start menu (**Start > All Programs > Keysight M8194 > Keysight M8194 Soft Front Panel**).

Command Line Arguments

(See [Communication](#) on page 114 for details about /Socket, /Telnet, /Inst, /HiSLIP, /AutoID, /NoAutoID, /FallBack).

Table 12 Command line arguments

Option	Description
/Socket socketPort	Set the socket port at which the Soft Front Panel waits for SCPI commands
/Telnet telnetPort	Set the telnet port at which the Soft Front Panel waits for SCPI commands
/Inst instrumentNumber	Set the instrument number (instN, hislipN) at which the Soft Front Panel waits for SCPI commands on VXI-11.3 and HiSLIP connections (if not specified with /HiSLIP).
/HiSLIP hislipNumber	Set the instrument number for HiSLIP SCPI communication. If not specified, the same number as for VXI-11.3 is used.
/AutoID	Automatically select ports and numbers for the connections (default behavior).
/NoAutoID	Disable the default behavior; i.e. do not automatically select ports and numbers for the connections.
/FallBack	Try to find unused ports and number if starting a server fails.
/NoSplash	Don't show the splash screen.
/Minimized	Start with the SFP window minimized to the Windows task bar.
/Title "title"	Additional information shown in the SFP window title.
/r resourceName	Visa PXI resource string of the module to connect to, e.g. PXI12::0::0::INSTR. "auto" selects the next free instrument.

Communication

Depending on the command line arguments `/Socket`, `/Telnet`, `/Inst`, `/AutoID`, `/NoAutoID`, `/FallBack`, the Soft Front Panel starts several servers to handle SCPI commands. (Refer to the table above.)

- **`/Socket`, `/Telnet`, `/Inst`, `/HiSLIP`**: If `-1`, don't start the respective servers

Defaults:

- **Socket port**: 5025 (e.g. `TCPIP0::localhost::5025::SOCKET`)
- **Telnet port**: 5024
- **HiSLIP**: 0 (e.g. `TCPIP0::localhost::hislip0::INSTR`)
- **VXI-11.3**: 0 (e.g. `TCPIP0::localhost::inst0::INSTR`)
- **`/FallBack`**: If starting a server fails because of a conflict, try using another port or number
 - **HiSLIP, VXI-11.3**: increase the index until a server can be started successfully
 - **Socket, Telnet**: start with port 60000, then increase it until the servers can be started successfully. If neither socket nor telnet is disabled the Soft Front Panel tries to start the servers on two consecutive ports (`socket port = telnet port + 1`)
- **`/AutoID`**: Automatically select ports and number for the connections, which are unique per instrument.

This is the default behavior; it is not necessary to specify this argument on the command line.

If only one AXIe module is connected to this PC and it is an M8194 module, first try to use the command line arguments `/Socket`, `/Telnet`, `/Inst`, or their respective default values if they are not specified. If starting the servers fails, proceed with the steps below.

`/Socket`, `/Telnet`, `/Inst`, `/HiSLIP` are ignored (unless they are `-1` and a server is disabled)

If the Soft Front Panel detects more than one AXIe module, use a special mechanism to obtain a number for the HiSLIP and VXI-11.3 servers, which makes sure that the Soft Front Panel uses always the same VISA resource string per module

The socket and telnet port are then calculated from the HiSLIP index:

- `telnet port = 60000 + 2 * <HiSLIP index>`
- `socket port = 60000 + 2 * <HiSLIP index> + 1`

NOTE

Ports may already be in use by Windows or other applications, so they are not available for M8194A.

- **/NoAutoID:** Do not automatically select ports and number for the connections, use the values specified with /Socket, /Telnet, /Inst, /HiSLIP or their respective default values instead.
If both /NoAutoID and /AutoID are specified, /AutoID overrides /NoAutoID.

NOTE

The first port not assigned by IANA is 49152 (IANA, Internet Assigned Numbers Authority, <http://www.iana.org>).

Programming Recommendations

This section lists some recommendations for programming the instrument:

- 1 Start programming from the default setting. The common command for setting the default setting is:

```
*RST
```

- 2 Use the binary data format when transferring waveform data.

The SCPI standard defines a long and a short form of the commands. For fast programming speed, it is recommended to use the short forms. The short forms of the commands are represented by upper case letters. For example the short form of the command to set 10mV offset is:

```
:VOLT:OFFS 0.01
```

- 3 To improve programming speed it is also allowed to skip optional subsystem command parts. Optional subsystem command parts are depicted in square brackets, e.g.: Set amplitude

```
[ :SOURce ] :VOLTage [ 1 | 2 ]  
[ :LEVel ] [ :IMMediate ] [ :AMPLitude ]
```

Sufficient to use:

```
:VOLT
```

M8194A is a 4 channel instrument. Parameters have to be specified for output 1, 2, 3, and 4. If there is no output specified the command will set the default output 1. So, for setting an offset of 10 mV for output 1 and output 2 the commands are:

```
:VOLT:OFFS 0.01 # sets offset of 10mV at output 1  
:VOLT1:OFFS 0.01 # sets offset of 10mV at output 1  
:VOLT2:OFFS 0.01 # sets offset of 10mV at output 2
```

- 4 If it is important to know whether the last command is completed then send the common query:
*OPC?
- 5 It is recommended to test the new setting which will be programmed on the instrument by setting it up manually. When you have found the correct setting, then use this to create the program.
- 6 In the program it is recommended to send the command for starting data generation (:INIT:IMM) as the last command. This way intermediate stop/restarts (e.g. when changing sample rate or loading a waveform) are avoided and optimum execution performance is achieved.

```
*RST          # set default settings
...          # other commands to set modes
...          # and parameters
:OUTP1 ON    # enable the output 1
:INIT:IMM    # start data generation.
```

SCPI Basics

Instructions

Instructions, both commands and queries, normally appear as strings embedded in a statement of your host language, such as Visual Basic for Applications (VBA), Visual Basic .NET, C#, C, etc.

The only time a parameter is not meant to be expressed as a string is when the instruction's syntax definition specifies <binary_block_data>, such as with the :SYSTEM:SET command. There are only a few instructions that use block data.

Instructions are composed of two main parts:

- The header, which specifies the command or query to be sent.
- The program data, which provides additional information to clarify the meaning of the instruction.

Instruction Header

The instruction header is one or more command mnemonics separated by colons (:). They represent the operation to be performed by the oscilloscope. Queries are formed by adding a question mark (?) to the end of the header. Many instructions can be used as either commands or

queries, depending on whether or not you include the question mark. The command and query forms of an instruction usually have different program data. Many queries do not use any program data.

White Space (Separator)

White space is used to separate the instruction header from the program data. If the instruction does not require any program data parameters, you do not need to include any white space. In this manual, white space is defined as one or more spaces. ASCII defines a space to be character 32 in decimal.

Braces

When several items are enclosed by braces, { }, only one of these elements may be selected. Vertical line (|) indicates "or". For example, {ON | OFF} indicates that only ON or OFF may be selected, not both.

Ellipsis

. . . An ellipsis (trailing dots) indicates that the preceding element may be repeated one or more times.

Square Brackets

Items enclosed in square brackets, [], are optional.

Program Data

Program data is used to clarify the meaning of the command or query. It provides necessary information, such as whether a function should be on or off, or which waveform is to be displayed. Each instruction's syntax definition shows the program data and the values they accept.

When there is more than one data parameter, they are separated by commas (,). You can add spaces around the commas to improve readability.

Common Commands

*IDN?

Read the instrument's identification string which contains four fields separated by commas. The first field is the manufacturer's name, the second field is the model number, the third field is the serial number, and the fourth field is a revision code which contains four numbers separated by dots and a fifth number separated by a dash:

```
Keysight Technologies, M8194A, <serial number>,
x.x.x.x-h
```

x.x.x.x= Soft Front Panel revision number, e.g. 0.1.23.0

h= Hardware revision number

*CLS

Clear the event register in all register groups. This command also clears the error queue and cancels a *OPC operation. It doesn't clear the enable register.

*ESE

Enable bits in the Standard Event Status Register to be reported in the Status Byte. The selected bits are summarized in the "Standard Event" bit (bit 5) of the Status Byte Register. The *ESE? query returns a value which corresponds to the binary-weighted sum of all bits enabled decimal by the *ESE command. These bits are not cleared by a *CLS command. Value Range: 0-255.

ESR?

Query the Standard Event Status Register. Once a bit is set, it remains set until cleared by a *CLS (clear status) command or queried by this command. A query of this register returns a decimal value which corresponds to the binary-weighted sum of all bits set in the register.

*OPC

Set the "Operation Complete" bit (bit 0) in the Standard Event register after the previous commands have been completed.

***OPC?**

Return “1” to the output buffer after the previous commands have been completed. Other commands cannot be executed until this command completes.

***OPT?**

Read the installed options. The response consists of any number of fields separated by commas.

***RST**

Reset instrument to its factory default state.

***SRE[?]**

Enable bits in the Status Byte to generate a Service Request. To enable specific bits, you must write a decimal value which corresponds to the binary-weighted sum of the bits in the register. The selected bits are summarized in the “Master Summary” bit (bit 6) of the Status Byte Register. If any of the selected bits change from “0” to “1”, a Service Request signal is generated. The `*SRE?` query returns a decimal value which corresponds to the binary-weighted sum of all bits enabled by the `*SRE` command.

***STB?**

Query the summary (status byte condition) register in this register group. This command is similar to a Serial Poll but it is processed like any other instrument command. This command returns the same result as a Serial Poll but the “Master Summary” bit (bit 6) is not cleared by the `*STB?` command.

***TST?**

Execute Self Tests. If self-tests pass, a 0 is returned. A number larger than 0 indicates the number of failed tests.

To get actual messages, use `:TEST:TST?`

***LRN?**

Query the instrument and return a binary block of data containing the current settings (learn string). You can then send the string back to the instrument to restore this state later. For proper operation, do not modify the returned string before sending it to the instrument. Use `:SYST:SET` to send the learn string. See `:SYSTem:SET[?]` on page 154.

***WAI?**

Prevents the instrument from executing any further commands until the current command has finished executing.

Status Model

This section describes the structure of the SCPI status system used by the M8194A. The status system records various conditions and states of the instrument in several register groups as shown on the following pages. Each of the register groups is made up of several low level registers called Condition registers, Event registers, and Enable registers which control the action of specific bits within the register group.

These groups are explained below:

- A condition register continuously monitors the state of the instrument. The bits in the condition register are updated in real time and the bits are not latched or buffered. This is a read-only register and bits are not cleared when you read the register. A query of a condition register returns a decimal value which corresponds to the binary-weighted sum of all bits set in that register.
- An event register latches the various events from changes in the condition register. There is no buffering in this register; while an event bit is set, subsequent events corresponding to that bit are ignored. This is a read only register. Once a bit is set, it remains set until cleared by query command (such as `STAT:QUES:EVENT?`) or a `*CLS` (clear status) command. A query of this register returns a decimal value which corresponds to the binary-weighted sum of all bits set in that register.
- An enable register defines which bits in the event register will be reported to the Status Byte register group. You can write to or read from an enable register. A `*CLS` (clear status) command will not clear the enable register but it does clear all bits in the event register. A `STAT:PRES` command clears all bits in the enable register. To enable bits in the enable register to be reported to the Status Byte register, you must write a decimal value which corresponds to the binary weighted sum of the corresponding bits.
- Transition Filters are used to detect changes of the state in the condition register and set the corresponding bit in the event register. You can set transition filter bits to detect positive transitions (PTR), negative transitions (NTR) or both. Transition filters are read/write registers. They are not affected by `*CLS`.

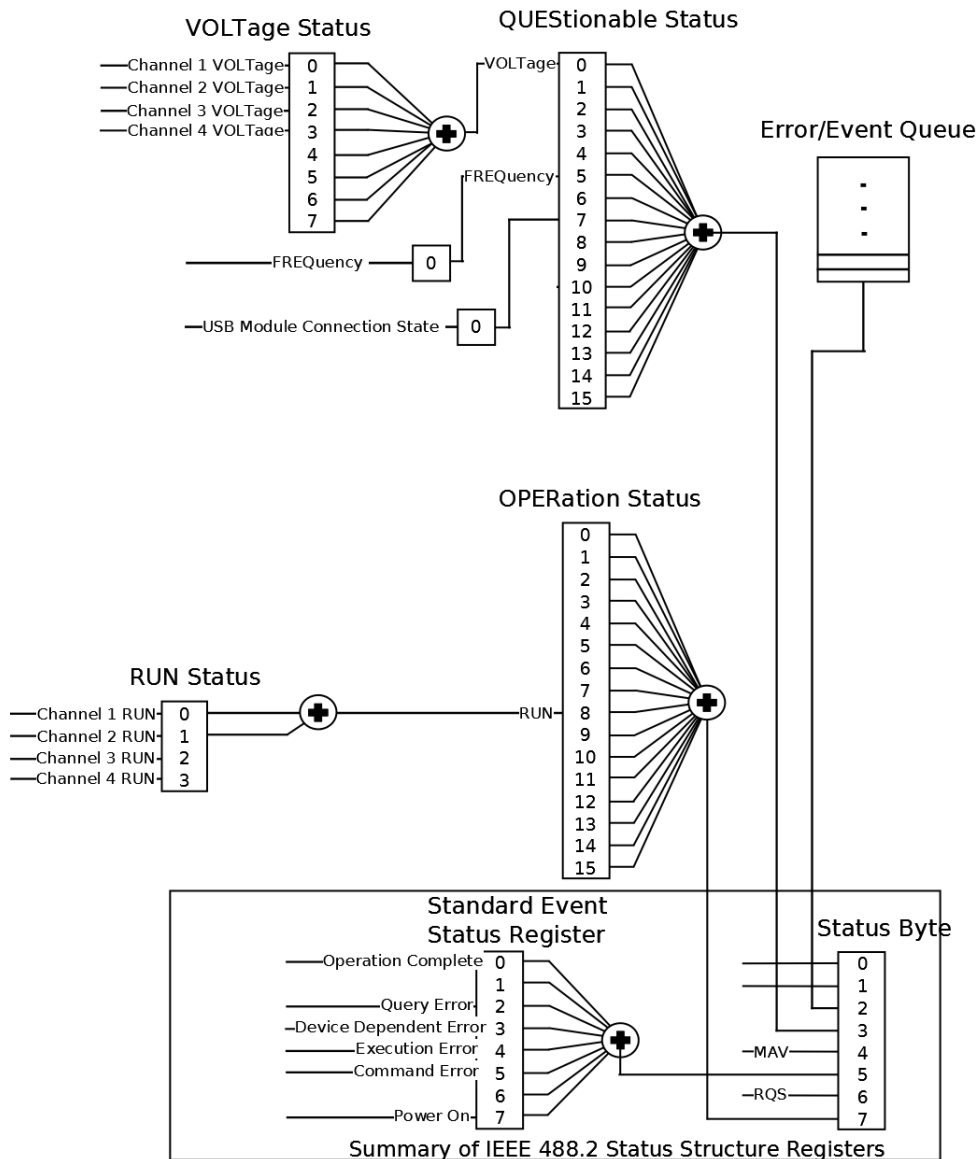

Figure 20 Status register structure

:STATus:PRESet

Clears all status group event registers. Presets the status group enables PTR and NTR registers as follows:

`ENABLe = 0x0000, PTR = 0xffff, NTR = 0x0000`

Status Byte Register

The Status Byte summary register reports conditions from the other status registers. Data that is waiting in the instrument's output buffer is immediately reported on the "Message Available" bit (bit 4) for example. Clearing an event register from one of the other register groups will clear the corresponding bits in the Status Byte condition register. Reading all messages from the output buffer, including any pending queries, will clear the "Message Available" bit. To set the enable register mask and generate an SRQ (service request), you must write a decimal value to the register using the *SRE command.

Table 13 Status byte register

Bit Number		Decimal Value	Definition
0	Not used	1	Not Used. Returns "0"
1	Not used	2	Not Used. Returns "0"
2	Error Queue	4	One or more error are stored in the Error Queue
3	Questionable Data	8	One or more bits are set in the Questionable Data Register (bits must be enabled)
4	Message Available	16	Data is available in the instrument's output buffer
5	Standard Event	32	One or more bits are set in the Standard Event Register
6	Master Summary	64	One or more bits are set in the Status Byte Register
7	Operational Data	128	One or more bits set in the Operation Data Register (bits must be enabled)

Questionable Data Register Command Subsystem

The Questionable Data register group provides information about the quality or integrity of the instrument. Any or all of these conditions can be reported to the Questionable Data summary bit through the enable register.

Table 14 Questionable data register

Bit Number		Decimal Value	Definition
0	Voltage warning	1	Output has been switched off (to protect itself)
1	Not used	2	Returns "0"
2	Not used	4	Returns "0"
3	Not used	8	Returns "0"
4	Not used	16	Returns "0"
5	Frequency warning	32	Output signal is invalid, because of an instable or missing external reference clock.
6	Not used	64	Returns "0"
7	USB disconnected	128	USB module connection state
8	Not used	256	Returns "0"
9	Not used	512	Returns "0"
10	Not used	1024	Returns "0"
11	Not used	2048	Returns "0"
12	Not used	4096	Returns "0"
13	Not used	8192	Returns "0"
14	Not used	16384	Returns "0"
15	Not used	32768	Returns "0"

The following commands access the questionable status group.

:STATus:QUESTionable[:EVENT]?

Reads the event register in the questionable status group. It's a read-only register. Once a bit is set, it remains set until cleared by this command or the *CLS command. A query of the register returns a decimal value which corresponds to the binary-weighted sum of all bits set in the register.

:STATus:QUESTionable:CONDition?

Reads the condition register in the questionable status group. It's a read-only register and bits are not cleared when you read the register. A query of the register returns a decimal value which corresponds to the binary-weighted sum of all bits set in the register.

:STATus:QUESTionable:ENABle[?]

Sets or queries the enable register in the questionable status group. The selected bits are then reported to the Status Byte. A *CLS will not clear the enable register but it does clear all bits in the event register. To enable bits in the enable register, you must write a decimal value which corresponds to the binary-weighted sum of the bits you wish to enable in the register.

:STATus:QUESTionable:NTRansition[?]

Sets or queries the negative-transition register in the questionable status group. A negative transition filter allows an event to be reported when a condition changes from true to false. Setting both positive/negative filters true allows an event to be reported anytime the condition changes. Clearing both filters disable event reporting. The contents of transition filters are unchanged by *CLS and *RST.

:STATus:QUESTionable:PTRansition[?]

Set or queries the positive-transition register in the questionable status group. A positive transition filter allows an event to be reported when a condition changes from false to true. Setting both positive/negative filters true allows an event to be reported anytime the condition changes. Clearing both filters disable event reporting. The contents of transition filters are unchanged by *CLS and *RST.

Operation Status Subsystem

The Operation Status register contains conditions which are part of the instrument's normal operation.

Table 15 Questionable status register

Bit Number		Decimal Value	Definition
0	Not used	1	Returns "0"
1	Not used	2	Returns "0"
2	Not used	4	Returns "0"
3	Not used	8	Returns "0"
4	Not used	16	Returns "0"
5	Not used	32	Returns "0"
6	Not used	64	Returns "0"
7	Not used	128	Returns "0"
8	Run Status	256	Indicates if system is running
9	Not used	512	Returns "0"
10	Not used	1024	Returns "0"
11	Not used	2048	Returns "0"
12	Not used	4096	Returns "0"
13	Not used	8192	Returns "0"
14	Not used	16384	Returns "0"
15	Not used	32768	Returns "0"

The following commands access the operation status group.

:STATus:OPERation[:EVENT]?

Reads the event register in the operation status group. It's a read-only register. Once a bit is set, it remains set until cleared by this command or *CLS command. A query of the register returns a decimal value which corresponds to the binary-weighted sum of all bits set in the register.

:STATus:OPERation:CONDition?

Reads the condition register in the operation status group. It's a read-only register and bits are not cleared when you read the register. A query of the register returns a decimal value which corresponds to the binary-weighted sum of all bits set in the register.

:STATus:OPERation:ENABle[?]

Sets or queries the enable register in the operation status group. The selected bits are then reported to the Status Byte. A *CLS will not clear the enable register but it does clear all bits in the event register. To enable bits in the enable register, you must write a decimal value which corresponds to the binary-weighted sum of the bits you wish to enable in the register.

:STATus:OPERation:NTRansition[?]

Sets or queries the negative-transition register in the operation status group. A negative transition filter allows an event to be reported when a condition changes from true to false. Setting both positive/negative filters true allows an event to be reported anytime the condition changes. Clearing both filters disable event reporting. The contents of transition filters are unchanged by *CLS and *RST.

:STATus:OPERation:PTRansition[?]

Set or queries the positive-transition register in the operation status group. A positive transition filter allows an event to be reported when a condition changes from false to true. Setting both positive/negative filters true allows an event to be reported anytime the condition changes. Clearing both filters disable event reporting. The contents of transition filters are unchanged by *CLS and *RST.

:STATus:PRESet

Clears all status group event registers. Presets the status group enables PTR and NTR registers as follows:

ENABle = 0x0000, PTR = 0xffff, NTR = 0x0000

Voltage Status Subsystem

The Voltage Status register contains the voltage conditions of the individual channels.

The following SCPI commands and queries are supported:

```
:STATus:QUESTionable:VOLTage[:EVENT]?
:STATus:QUESTionable:VOLTage:CONDition?
:STATus:QUESTionable:VOLTage:ENABle[?]
:STATus:QUESTionable:VOLTage:NTRansition[?]
:STATus:QUESTionable:VOLTage:PTRansition[?]
```

Table 16 Voltage status register

Bit Number		Decimal Value	Definition
0	Voltage warning	1	Output 1 has been switched off (to protect itself)
1	Voltage warning	2	Output 2 has been switched off (to protect itself)
2	Voltage warning	4	Output 3 has been switched off (to protect itself)
3	Voltage warning	8	Output 4 has been switched off (to protect itself)
4	Not used	16	Returns "0"
5	Not used	32	Returns "0"
6	Not used	64	Returns "0"
7	Not used	128	Returns "0"

Frequency Status Subsystem

The Frequency Status register contains the frequency conditions of the module. The following SCPI commands and queries are supported:

```
:STATus:QUESTionable:FREQuency[:EVENT]?
:STATus:QUESTionable:FREQuency:CONDition?
:STATus:QUESTionable:FREQuency:ENABle[?]
:STATus:QUESTionable:FREQuency:NTRansition[?]
:STATus:QUESTionable:FREQuency:PTRansition[?]
```

Table 17 Frequency status register

Bit Number		Decimal Value	Definition
0	Frequency warning	1	Output signal is invalid, because of an instable or missing external reference clock.

Connection Status Subsystem

The Connection Status register contains the state of the USB connection to the M8194A module.

The following SCPI commands and queries are supported:

```
:STATUS:QUESTIONABLE:CONNECTION[:EVENT]?
:STATUS:QUESTIONABLE:CONNECTION:CONDITION?
:STATUS:QUESTIONABLE:CONNECTION:ENABLE[?]
:STATUS:QUESTIONABLE:CONNECTION:NTRANSITION[?]
:STATUS:QUESTIONABLE:CONNECTION:PTRANSITION[?]
```

Table 18 Connection status register

Bit Number		Decimal Value	Definition
0	USB disconnected	1	USB module connection state

Run Status Subsystem

The Run Status register contains the run status conditions of the individual channels.

The following SCPI commands and queries are supported:

```
:STATUS:OPERATION:RUN[:EVENT]?
:STATUS:OPERATION:RUN:CONDITION?
:STATUS:OPERATION:RUN:ENABLE[?]
:STATUS:OPERATION:RUN:NTRANSITION[?]
:STATUS:OPERATION:RUN:PTRANSITION[?]
```

Table 19 Run status register

Bit Number		Decimal Value	Definition
0	Run Status	1	Indicates if channel 1 is running
1	Run Status	2	Indicates if channel 2 is running
2	Run Status	3	Indicates if channel 3 is running
3	Run Status	4	Indicates if channel 4 is running

:ABOrt Commands

:ABORt[1|2|3|4][?]

Command	:ABORt [1 2 3 4]
Query	:ABORt [1 2 3 4] ?
Parameters	None
Parameter Suffix	None
Description	This command stops signal generation on all channel.
Examples	Command :ABOR1 Query :ABOR1 ?

:INITiate Commands

:INITiate:IMMEDIATE[1|2|3|4]

Command	:INITiate:IMMEDIATE[1 2 3 4]
Parameters	None
Parameter Suffix	None
Description	This command starts signal generation on all channels.
Examples	Command :INIT:IMM1

:INITiate:ASYNc[1|2|3|4]

Command	:INITiate:ASYNc[1 2 3 4]
Parameters	None
Parameter Suffix	None
Description	This command starts signal generation on all channels. This command is implemented as an overlapped command. Use *OPC? to synchronize to the execution of this overlapped command.
Examples	Command :INIT:ASYN1

:INSTRument Commands

:INSTRument:DACMode[?]

Command	:INSTRument:DACMode SINGLE DUAL FOUR MARKer DCMarker
Query	:INSTRument:DACMode?
Parameters	SINGLE DUAL FOUR MARKer DCMarker <ul style="list-style-type: none"> • SINGLE – Channel 1 can generate a signal • DUAL – Channels 1 and 2 can generate a signal, channels 3 and 4 are unused • FOUR – Channels 1, 2, 3, and 4 can generate a signal • MARKer – Channel 1 with two markers output on channel 2 and 3 • DCMarker – Dual channel with marker: Channels 1 and 2 can generate a signal. Channel 1 has two markers output on channel 3 and 4. Channel 2 can generate signals without markers.
Parameter Suffix	None
Description	This command sets the operation mode of the DAC. The value of the operation mode determines, to which channels waveforms can be transferred and the format of the waveform data. In operation mode SINGLE, DUAL, or FOUR the data consists of 1-byte waveform samples only. In operation mode MARKer or DCMarker the data loaded to channel 1 consists of interleaved 1-byte waveform and 1-byte marker samples
Examples	Command :INST:DACM DUAL Query :INST:DACM? -> DUAL

:INSTRument:HWRevision?

Command	:INSTRument:HWRevision?
Parameters	None
Parameter Suffix	None
Description	This query returns the M8194A hardware revision number.

Examples Query
`:INST:HWR? -> "1"`

:INSTrument:IDENTify

Command `:INSTrument:IDENTify [<seconds>]`
 Parameters `<seconds>`
 Parameter Suffix None
 Description This command identifies the instrument by flashing the green “**Access**” LED on the front panel for a certain time. `<seconds>` optional length of the flashing interval, default is 10 seconds.
 Examples Command
`:INST:IDEN`

:INSTrument:IDENTify:STOP

Command `:INSTrument:IDENTify:STOP`
 Parameters None
 Parameter Suffix None
 Description This command stops the flashing of the green “Access” LED before the flashing interval has elapsed.
 Examples Command
`:INST:IDEN:STOP`

:INSTrument:SLOT[:NUMBer]?

Query `:INSTrument:SLOT[:NUMBer]?`
 Parameters None
 Parameter Suffix None
 Description This query returns the instrument’s slot number in its AXIe frame.
 Examples Query
`:INST:SLOT? "2"`

:MMEMory Commands

This node provides access to parts of the remote host file system, so that waveform files can be loaded from the remote host into the module.

:MMEMory:CATalog?

Command	:MMEMory:CATalog? [<directory_name>]
Parameters	None
Parameter Suffix	None
Description	<p>Query disk usage information (drive capacity, free space available) and obtain a list of files and directories in a specified directory in the following format:</p> <pre><numeric_value>,<numeric_value>,{<file_entry>}</pre> <p>This command returns two numeric parameters and as many strings as there are files and directories. The first parameter indicates the total amount of storage currently used in bytes. The second parameter indicates the total amount of storage available, also in bytes. The <file_entry> is a string. Each <file_entry> indicates the name, type, and size of one file in the directory list:</p> <pre><file_name>,<file_type>,<file_size></pre> <p>As the Windows file system has an extension that indicates file type, <file_type> is always empty. <file_size> provides the size of the file in bytes. In case of directories, <file_entry> is surrounded by square brackets and both <file_type> and <file_size> are empty.</p>
Examples	<p>Command</p> <pre>:MMEM:CAT?</pre>

:MMEMory:CDIRectory[?]

Command	:MMEMory:CDIRectory [<directory_name>]
Query	:MMEMory:CDIRectory?
Parameters	None
Parameter Suffix	None

Description Changes the default directory for a mass memory file system. The `<directory_name>` parameter is a string. If no parameter is specified, the directory is set to the `*RST` value. At `*RST`, this value is set to the default user data storage area, that is defined as `System.Environment.SpecialFolder.Personal`

e.g. `C:\Users\Name\Documents`

`MMEMory:CDIRectory?` – Query returns full path of the default directory

Examples Command

```
:MMEM:CDIR "C:\Users\Name\Documents"
```

Query

```
:MMEM:CDIR? -> "C:\Users\Name\Documents"
```

:MMEMory:COPY[?]

Command `:MMEMory:COPY <string>,<string>[,<string>,<string>]`

Parameters `<string>,<string>[,<string>,<string>]`

Parameter Suffix None

Description Copies an existing file to a new file or an existing directory to a new directory. Two forms of parameters are allowed. The first form has two parameters. In this form, the first parameter specifies the source, and the second parameter specifies the destination.

The second form has four parameters. In this form, the first and third parameters specify the file names. The second and fourth parameters specify the directories. The first pair of parameters specifies the source. The second pair specifies the destination. An error is generated if the source doesn't exist or the destination file already exists.

Examples Command

```
:MMEM:COPY "C:\data.txt", "C:\data_new.txt"
```

:MMEMory:DATA[?]

Command :MMEMory:DATA <file_name>, <data>

Query :MMEMory:DATA?

Parameters <file_name>, <data>

Parameter Suffix None

Description The command form is MMEMory:DATA <file_name>,<data>. It loads <data> into the file <file_name>. <data> is in 488.2 block format. <file_name> is string data.

The query form is MMEMory:DATA? <file_name> with the response being the associated <data> in block format.

Examples Command

```
:MMEM:DATA "C:\data.txt", #14test
```

Query

```
:MMEM:DATA "C:\data.txt"
```

:MMEMory:DATA:APPend

Command :MMEMory:DATA:APPend "<file_name>",<blockdata>

Parameters <file_name>,<blockdata>

<file_name> - This variable names the destination file.

<blockdata> - This parameter represents the file length and data to be appended.

Parameter Suffix None

Description The command appends byte data to an existing file stored in memory in the specified "<file name>".

Examples Command

```
:MMEM:DATA "NVWFM1:IQ_Data",#14Y9oL
```

- "NVWFM1:IQ_Data" - File path and file name.
- #149oL - Data block
 - # - This character indicates the beginning of the data block.
 - 1 - Number of digits in the byte count.

- 4 - Byte count
- $\Upsilon 9\circ L$ - Four bytes of data to be appended (used for example purpose only)

:MMEMory:DElete

Command	:MMEMory:DElete <file_name>[,<directory_name>]
Parameters	<file_name>[,<directory_name>]
Parameter Suffix	None
Description	Removes a file from the specified directory. The <file_name> parameter specifies the file to be removed.
Examples	Command :MMEM:DEL "C:\data.txt"

:MMEMory:LOAD:CState

Command	:MMEMory:LOAD:CState <file_name>
Parameters	<file_name >
Parameter Suffix	None
Description	This command loads the current state of instrument from a file.
Examples	Command :MMEM:LOAD:CST "C:\data.txt"

:MMEMory:MDIRectory

Command	:MMEMory:MDIRectory <directory_name>
Parameters	<directory_name>
Parameter Suffix	None
Description	Creates a new directory. The <directory_name> parameter specifies the name to be created.
Examples	Command :MMEM:MDIR "C:\data_dir"

:MMEMory:MOVE

Command	:MMEMory:MOVE <string>,<string>[,<string>,<string>]
Parameters	<string>,<string>[,<string>,<string>]
Parameter Suffix	None
Description	<p>Moves an existing file to a new file or an existing directory to a new directory. Two forms of parameters are allowed. The first form has two parameters. In this form, the first parameter specifies the source, and the second parameter specifies the destination.</p> <p>The second form has four parameters. In this form, the first and third parameters specify the file names. The second and fourth parameters specify the directories. The first pair of parameters specifies the source. The second pair specifies the destination. An error is generated if the source doesn't exist or the destination file already exists.</p>
Examples	<p>Command</p> <pre>:MMEM:MOVE "C:\data_dir","C:\newdata_dir"</pre>

:MMEMory:RDIRECTory

Command	:MMEMory:RDIRECTory <directory_name>
Parameters	<directory_name>
Parameter Suffix	None
Description	Removes a directory. The <directory_name> parameter specifies the directory name to be removed. All files and directories under the specified directory are also removed.
Examples	<p>Command</p> <pre>:MMEM:RDIR "C:\newdata_dir"</pre>

:MMEemory:STORe:CState

Command	:MMEemory:STORe:CState <file_name>
Parameters	<file_name >
Parameter Suffix	None
Description	This command stores the current state of instrument to a file.
Examples	Command :MMEemory:STORe:CState "C:\data.txt"

:OUTPut Commands

:OUTPut[1|2|3|4]:DIOffset[?]

Command	:OUTPut [1 2 3 4]:DIOffset <value> MINimum MAXimum
Query	:OUTPut [1 2 3 4]:DIOffset?
Parameters	<value> MINimum MAXimum
Parameter Suffix	None
Description	This command sets the differential offset. The hardware can compensate for little offset differences between the normal and complement output. “<value>” is the offset to the calibrated optimum DAC value, so the minimum and maximum depend on the result of the calibration.
Examples	<p>Command</p> <pre>:OUTP:DIOF MAX</pre> <p>Query</p> <pre>:OUTP:DIOF? -> MAX</pre>

:OUTPut[1|2|3|4]:STATe[?]

Command	:OUTPut [1 2 3 4][:STATe] OFF ON 0 1
Query	:OUTPut [1 2 3 4][:STATe]?
Parameters	OFF ON 0 1
Parameter Suffix	None
Description	This command enables or disables the amplifier of the output path for a channel.
Examples	<p>Command</p> <pre>:OUTP1 ON</pre> <p>Query</p> <pre>:OUTP1? -> 1</pre>

:OUTPut:ROSCillator[:STATe][?]

Command	:OUTPut:ROSCillator[:STATe] [0 1]
Query	:OUTPut:ROSCillator[:STATe]?
Parameters	[0 1]
Parameter Suffix	None
Description	Turn on/off the “Sync Out B” output. When set to 1, the output of the internal reference clock oscillator running at nominally 285 MHz is available at the “Sync Out B” connector. When set to 0, the signal on the “Sync Out B” connector is undefined. The output can only be turned on if the internal reference oscillator is used (:ROSC:SOUR INT).
Examples	<p>Command</p> <pre>:OUT:ROSC 1</pre> <p>Query</p> <pre>:OUT:ROSC? -> 1</pre>

[:SOURce] Commands

[:SOURce]:CHARacteris[1|2|3|4][:VALue]?

Command	<code>[:SOURce]:CHARacteris[1 2 3 4][:VALue]? [<amplitude>[,<sample_frequency>]]</code>
Query	<code>[:SOURce]:CHARacteris[1 2 3 4][:VALue]?</code>
Parameters	<code>[<amplitude>[,<sample_frequency>]]</code> <code><amplitude></code> the output amplitude <code><sample_frequency></code> the sample frequency
Parameter Suffix	None
Description	<p>Query the frequency and phase response data for a channel. The query returns the data for the AWG sample frequency and output amplitude passed as parameters as a string of comma-separated values. If the sample frequency or both parameters are omitted, the currently configured AWG sample frequency and output amplitude are used.</p> <p>The frequency and phase response includes the $\sin x/x$ roll-off of the currently configured AWG sample frequency. As a result the query delivers different results when performed at e.g. 88 GSa/s or 120 GSa/s.</p> <p>To achieve optimum frequency and phase compensation results, the frequency and phase response has been characterized individually per channel and for different output amplitudes. As a result, the query delivers different results when performed at e.g. 500 mV or 800 mV.</p> <p>The frequency and phase response refers to the 2.4 mm connector. In case external cables from the 2.4 mm connector to the Device Under Test (DUT) shall be mathematically compensated for as well, the corresponding S-Parameter of that cable must be taken into account separately.</p> <p>Format: The first three values are output frequency 1 in Hz, corresponding relative magnitude in linear scale, corresponding phase in radians. The next three values are output frequency 2, corresponding relative magnitude, corresponding phase, and so on.</p>
Examples	<p>Query</p> <pre>:CHAR1? "0,1.01068,0, 1e+008,1.00135,-6.11215e-005,</pre>

```

2e+008,0.993992,-0.000179762,
...
3.19e+010,0.0705237,-3.82659,
3.2e+010,0.0665947,-3.85028"

```

[[:SOURce]:FREQuency:RASTer[?]

Command	<code>[:SOURce] :FREQuency:RASTer <frequency> MINimum MAXimum</code>
Query	<code>[:SOURce] :FREQuency:RASTer?</code>
Parameters	<code><frequency> MINimum MAXimum</code>
Parameter Suffix	None
Description	This command sets or queries the sample frequency of the output DAC for the currently selected reference clock and its range.
Examples	<p>Command</p> <pre>:FREQ:RAST MAX</pre> <p>Query</p> <pre>FREQ:RAST? -> MAX</pre>

[[:SOURce]:FREQuency:RANGe[?]

Command	<code>[:SOURce] :FREQuency:RANGe <LOW MEDIum HIGH></code>
Query	<code>[:SOURce] :FREQuency:RANGe?</code>
Parameters	<code>LOW MEDIum HIGH</code>
Parameter Suffix	None
Description	This command sets or queries the sample frequency of the output DAC for a specific reference clock source.
Examples	<p>Command</p> <pre>:FREQ:RANG HIGH</pre> <p>Query</p> <pre>:FREQ:RANG? -> HIGH</pre>

[[:SOURCE]:VOLTage[1|2|3|4][:LEVel][:IMMediate][:AMPLitude][?]

Command	[:SOURCE] :VOLTage [1 2 3 4] [:LEVel] [:IMMediate] [:AMPLitude] <level>
Query	[:SOURCE] :VOLTage [1 2 3 4] [:LEVel] [:IMMediate] [:AMPLitude] ?
Parameters	<level>
Parameter Suffix	None
Description	This command sets or queries the output amplitude.
Examples	Command :VOLT 0.685 Query :VOLT? -> 0.685

[[:SOURCE]:VOLTage[1|2|3|4][:LEVel][:IMMediate]:HIGH[?]

Command	[:SOURCE] :VOLTage [1 2 3 4] [:LEVel] [:IMMediate] :HIGH <level>
Query	[:SOURCE] :VOLTage [1 2 3 4] [:LEVel] [:IMMediate] :HIGH?
Parameters	<level>
Parameter Suffix	None
Description	This command sets or queries the output high level.
Examples	Command :VOLT:HIGH 3e-1 Query :VOLT:HIGH? -> 3e-1

[:SOURce]:VOLTage[1|2|3|4][:LEVel][:IMMediate]:LOW[?]

Command	[:SOURce]:VOLTage[1 2 3 4][:LEVel][:IMMediate]:LOW <level>
Query	[:SOURce]:VOLTage[1 2 3 4][:LEVel][:IMMediate]:LOW?
Parameters	<level>
Parameter Suffix	None
Description	This command sets or queries the output low level.
Examples	Command :VOLT:LOW -0.3 Query :VOLT:LOW? -> -0.3

[:SOURce]:VOLTage[1|2|3|4][:LEVel][:IMMediate]:OFFSet[?]

Command	[:SOURce]:VOLTage[1 2 3 4][:LEVel][:IMMediate]:OFFSet <level>
Query	[:SOURce]:VOLTage[1 2 3 4][:LEVel][:IMMediate]:OFFSet ?
Parameters	<level>
Parameter Suffix	None
Description	This command sets or queries the output offset.
Examples	Command :VOLT:OFFS 0.02 Query :VOLT:OFFS? -> 0.02

[:SOURce]:VOLTage[1|2|3|4][:LEVel][:IMMediate]:TERMination[?]

Command	[:SOURce]:VOLTage[1 2 3 4][:LEVel][:IMMediate]:TERMin ation <level>
Query	[:SOURce]:VOLTage[1 2 3 4][:LEVel][:IMMediate]:TERMin ation?

Parameters	<level>
Parameter Suffix	None
Description	This command sets or queries the termination voltage level.
Examples	Command :VOLT:TERM -0.3 Query :VOLT:TERM? -> -0.3

[[:SOURce]:ROSCillator:SOURce[?]]

Command	[[:SOURce]:ROSCillator:SOURce [INTernal EXTernal]]
Query	[[:SOURce]:ROSCillator:SOURce?
Parameters	INTernal EXTernal
Parameter Suffix	None
Description	This command switches between using the internal reference oscillator (INTernal) and the signal from the “Sync In B” connector (EXTernal) to be used as the reference clock source for the instrument. Switching is only allowed while the instrument is stopped (:ABORT). This query returns the current state of Reference Clock Source.
Examples	Command :ROSC:SOUR INT Query :ROSC:SOUR? -> INT

[[:SOURce]:ROSCillator:SOURce:CHECK?]

Query	[[:SOURce]:ROSCillator:SOURce:CHECK? [EXTernal INTernal]]
Parameters	INTernal EXTernal
Parameter Suffix	None
Description	This query checks whether a reference clock source is available or not. This query returns 1 if it is available and 0 if not available.

Examples Command
 :ROSC:SOUR:CHEC? INT

[[:SOURce]:ROSCillator:EXTernal:FREQuency[?]

Command [:SOURce]:ROSCillator:EXTernal:FREQuency <value>
 Query [:SOURce]:ROSCillator:EXTernal:FREQuency?
 Parameters <Value> 200 MHz to 300 MHz
 Parameter Suffix None
 Description Sets/queries the frequency on the “Sync In B” input when used as a reference clock input. The valid frequency range is 200 MHz to 300 MHz. The programmed value must match the actual input frequency to within +/- 1%. The value is used to calculate the settings of the PLL of the instrument.
 Examples Command
 :ROSC:EXT:FREQ 285
 Query
 :ROSC:EXT:FREQ? -> 285

[[:SOURce]:ROSCillator:INTernal:FREQuency[?]

Command [:SOURce]:ROSCillator:INTernal:FREQuency <value>
 Query [:SOURce]:ROSCillator:INTernal:FREQuency?
 Parameters <value>
 Parameter Suffix None
 Description Sets/queries the value that is assumed to be the internal oscillator frequency when :ROSC:INT:FREQ:OVERRIDE is set to 1. This command does not change the oscillator’s frequency in any way. It is only used for calculating the settings of the PLL of the instrument.
 As an example, this command can be used if the measured output frequency slightly deviates from the programmed output frequency.
 Examples Command
 :ROSC:INT:FREQ 285

Query

```
:ROSC:INT:FREQ? -> 285
```

[:SOURce]:ROSCillator:INTernal:FREQuency:OVERride[?]

Command	[:SOURce]:ROSCillator:INTernal:FREQuency:OVERride [1 0]
Query	[:SOURce]:ROSCillator:INTernal:FREQuency:OVERride?
Parameters	[1 0]
Parameter Suffix	None
Description	When set to 1, uses the frequency given in :ROSC:INT:FREQ to be the assumed internal reference oscillator frequency. When set to 0, uses the factory calibrated frequency value as the assumed internal reference oscillator frequency. This query returns 0 if the Override Calibration checkbox is selected, else returns 1.
Examples	Command :ROSC:INT:FREQ:OVER 1 Query :ROSC:INT:FREQ:OVER? -> 1

[:SOURce]:ROSCillator:CALibration[:FREQuency]?

Query	[:SOURce]:ROSCillator:CALibration[:FREQuency]?
Parameters	None
Parameter Suffix	None
Description	This query returns the frequency of the internal reference oscillator as measured during the manufacturing process. If :ROSC:INT:FREQ:OVER is set to 0, this frequency is used to calculate the settings of the PLL of the instrument.
Examples	Query :ROSC:CAL? -> 2.85000000000000E+08

:SYSTem Commands

:SYSTem:COMMunicate:HISLip[:NUMBer]?

Query :SYSTem:COMMunicate:HISLip[:NUMBer]?

Parameters None

Parameter Suffix None

Description This query returns the HiSLIP number used by the firmware.

Examples Query

:SYST:COMM:HISL?

:SYSTem:COMMunicate:INSTr[:NUMBer]?

Query :SYSTem:COMMunicate:INSTr[:NUMBer]?

Parameters None

Parameter Suffix None

Description This query returns the VXI-11 instrument number used by the firmware.

Examples Query

:SYST:COMM:INST?

:SYSTem:COMMunicate:SOCKet[:PORT]?

Query :SYSTem:COMMunicate:SOCKet[:PORT]?

Parameters None

Parameter Suffix None

Description This query returns the socket port used by the firmware.

Examples Query

:SYST:COMM:SOCK?

:SYSTem:COMMunicate:TCPIP:CONTRol?

Query	:SYSTem:COMMunicate:TCPIP:CONTRol?
Parameters	None
Parameter Suffix	None
Description	This query returns the port number of the control connection. You can use the control port to send control commands (for example "Device Clear") to the instrument.
Examples	Query :SYST:COMM:TCP:CONT?

:SYSTem:COMMunicate:TELNet[:PORT]?

Query	:SYSTem:COMMunicate:TELNet[:PORT]?
Parameters	None
Parameter Suffix	None
Description	This query returns the telnet port used by the firmware.
Examples	Query :SYST:COMM:TELN?

:SYSTem:ERRor:COUNT?

Query	:SYSTem:ERRor:COUNT?
Parameters	None
Parameter Suffix	None
Description	This query returns the error count.
Examples	Query :SYST:ERR:COUNT? -> "5"

:SYSTem:ERRor[:NEXT]?

Query	:SYSTem:ERRor[:NEXT]?
Parameters	None
Parameter Suffix	None
Description	<p>Read and clear one error from the instrument's error queue.</p> <p>A record of up to 30 command syntax or hardware errors can be stored in the error queue. Errors are retrieved in first-in-first-out (FIFO) order. The first error returned is the first error that was stored. Errors are cleared as you read them.</p> <p>If more than 30 errors have occurred, the last error stored in the queue (the most recent error) is replaced with "Queue overflow". No additional errors are stored until you remove errors from the queue.</p> <p>If no errors have occurred when you read the error queue, the instrument responds with 0, "No error".</p> <p>The error queue is cleared by the *CLS command, when the power is cycled, or when the firmware is re-started.</p> <p>The error queue is not cleared by a reset (*RST) command.</p> <p>The error messages have the following format (the error string may contain up to 255 characters):</p> <p>error number,"Description", e.g.</p> <p>-113,"Undefined header".</p>
Examples	<p>Query</p> <p>:SYST:ERR?</p>

:SYSTem:HELP:HEADers?

Query	:SYSTem:HELP:HEADers?
Parameters	None
Parameter Suffix	None
Description	<p>The HEADers? query returns all SCPI commands and queries and IEEE 488.2 common commands and common queries implemented by the instrument. The response is a <DEFINITE LENGTH ARBITRARY BLOCK RESPONSE DATA> element. The full path for every command and query is returned separated by line feeds. The syntax of the response is defined as:</p>

Description This query returns the subscription date of the licenses installed in YYYYMMDD format.

Examples Query

```
:SYST:LIC:SUBS:DATE? "M8070A-CAL"
```

:SYSTem:SET[?]

Command :SYSTem:SET <binary block data>

Query :SYSTem:SET?

Parameters <binary block data>

Parameter Suffix None

Description In query form, the command reads a block of data containing the instrument's complete set-up. The set-up information includes all parameter and mode settings, but does not include the contents of the instrument setting memories or the status group registers. The data is in a binary format, not ASCII, and cannot be edited.

In set form, the block data must be a complete instrument set-up read using the query form of the command.

This command has the same functionality as the *LRN command.

Examples Command

```
:SYST:SET <binary block data>
```

Query

```
:SYST:SET?
```

:SYSTem:VERSion?

Query :SYSTem:VERSion?

Parameters None

Parameter Suffix None

Description This query returns a formatted numeric value corresponding to the SCPI version number for which the instrument complies.

Examples Query

```
:SYST:VERS? -> "1999.0"
```

:TEST Commands

:TEST:PON?

Query	:TEST:PON?
Parameters	None
Parameter Suffix	None
Description	This query returns the results of the power on self-tests.
Examples	Query :TEST:PON?

:TEST:TST?

Query	:TEST:TST?
Parameters	None
Parameter Suffix	None
Description	This query is similar to *TST?, but the actual test messages are returned.
Examples	Query :TEST:TST?

:TRACe Commands

:TRACe[1|2|3|4]:CATalog?

Query	:TRACe[1 2 3 4]:CATalog?
Parameters	None
Parameter Suffix	None
Description	The query returns a comma-separated list of segment-ids that are defined and the length of each segment. So first number is a segment id, next length ... If no segment is defined, "0, 0" is returned.
Examples	Query :TRAC1:CAT? -> 0,0

:TRACe[1|2|3|4]:COMMent[?]

Command	:TRACe[1 2 3 4]:COMMent[?] <segment_id>,<comment>
Query	:TRACe[1 2 3 4]:COMMent?
Parameters	<segment_id>,<comment>
Parameter Suffix	None
Description	This command associates a comment to a segment. The query gets the comment for a segment. <segment_id> – must be 1 <comment> – string of at most 256 characters
Examples	Command :TRAC:COMM 1, "Comment" Query :TRAC:COMM? 1

:TRACe[1|2|3|4][:DATA][?] <segment_id>,<offset>,<length>|<block>|<numeric_values>)

Command	:TRACe[1 2 3 4][:DATA] <segment_id>,<offset>,<length> <block> <numeric_values>)
Query	:TRACe[1 2 3 4][:DATA]? <segment_id>,<offset>,<length>
Parameters	<segment_id>,<offset>,<length> <block> <numeric_values>) <ul style="list-style-type: none"> • <segment_id> – id of the segment, must be 1 • <offset> offset in samples for direct modes and I/Q sample pairs for interpolated modes to allow splitting the transfer in smaller portions. The offset parameter is necessary to overcome the SCPI restriction that only allows transferring up to 999999999 bytes at once. • <block> waveform data samples and marker values in the data format described above in IEEE binary block format • <numeric_values> waveform data samples and marker values in the data format described above in comma separated list format; each element is a 16-bit integer values representing DAC samples and marker data Di in direct modes or I/Q samples and marker data li, Qi in interpolated modes. • Direct mode: D0, D1, D2,... • Interpolated mode: I0, Q0, I1, Q1, I2, Q2...
Parameter Suffix	None
Description	Use this command to load waveform and marker data into the module memory. If <segment_id> is already filled with data, the new values overwrite the current values. If length is exceeded error -223 (too much data) is reported.

NOTE

If the segment is split in smaller sections, the sections have to be written in order of ascending <offset> values. If modification of the segment contents is necessary, the whole segment with all sections must be rewritten.

If segments are created and deleted in arbitrary order, their position and order in memory cannot be controlled by the user, because the M8190A reuses the memory space of deleted segments for newly created segments. To fulfill the streaming and minimum linear playtime requirements the only way to control the position of the first downloaded segment and the order of the following segments is to delete all segments from memory (:TRACe[1|2|3|4]:DELeTe:ALL) and then creating the segments in the order in which they should be placed in memory.

Examples Command

Load data consisting of 480 samples as comma-separated list into previously defined segment 1 starting at sample offset 0.

```
:TRAC1:DATA 1,0,0,1,2,...,479
```

Query

```
:TRAC:DATA? 1,0,48
```

:TRACe[1|2|3|4]:DEFine[?]

Command :TRACe[1|2|3|4]:DEFine
<segment_id>,<length>[,<init_value1>[,<init_value2>]]

Query :TRACe[1|2|3|4]:DEFine?

Parameters <segment_id>,<length>[,<init_value1>[,<init_value2>]]

- <segment_id> – id of the segment, 1..512k for option SEQ, 1 if not installed
- <length> – length of the segment in samples for direct modes or in I/Q sample pairs for interpolated modes
- <init_value1> – optional initialization value. For direct modes this is a DAC value. For interpolated modes this is the I-part of an I/Q sample pair.
- <init_value2> – optional initialization value, only applicable for interpolated modes. This is the Q-part of an I/Q sample pair.

Parameter Suffix	None
Description	Use this command to define the size of a waveform memory segment. If is specified (direct modes) or and (interpolated modes) are specified, all sample values in the segment are initialized. If not specified, memory is only allocated but not initialized. The segment will be flagged write-only, so it cannot be read back or stored.
Examples	<p>Commands</p> <p>To set precision mode</p> <pre>TRAC1:DWID WPR</pre> <p>To define a segment with id 1 and length 480 samples. Initialize to sample value 0.</p> <pre>TRAC1:DEF 1,480,0</pre> <p>To set interpolated mode, interpolation factor 3.</p> <pre>TRAC1:DWID INTX3</pre> <p>To define a segment with id 1 and length 480 samples. Initialize with I/Q value pair (0,1).</p> <pre>TRAC:DEF 1,480,0,1</pre>

:TRACe[1|2|3|4]:DEFine:NEW?

Command

Query :TRACe[1|2|3|4]:DEFine:NEW? <length>
[,<init_value1>[,<init_value2>]]

Parameters

<length> [,<init_value1>[,<init_value2>]]

- <length> – length of the segment in samples for direct modes or in I/Q sample pairs for interpolated modes
- <init_value1> – optional initialization value. For direct modes this is a DAC value. For interpolated modes this is the I-part of an I/Q sample pair.
- <init_value2> – optional initialization value, only applicable for interpolated modes. This is the Q-part of an I/Q sample pair.

Parameter Suffix None

Description Use this query to define the size of a waveform memory segment. If <init_value1> is specified (direct modes) or <init_value1> and <init_value2> (interpolated modes) are specified, all sample values in

the segment are initialized. If not specified, memory is only allocated but not initialized. If the query was successful, a new <segment_id> will be returned.

Examples Query

Define a segment of length 480 samples. Returns the segment id.

```
TRAC1:DEF:NEW? 480
```

:TRACe[1|2|3|4]:DEFine:WONLy

Command :TRACe[1|2|3|4]:DEFine:WONLy
<segment_id>,<length>[,<init_value>]

Parameters <segment_id>,<length>[,<init_value>]

- < segment_id > - id of the segment
- <length> - length of the segment in samples, marker samples do not count
- <init_value> - optional initialization DAC value.

Parameter Suffix None

Description Use this command to define the size of a waveform memory segment. If <init_value> is specified, all values in the segment are initialized. If not specified, memory is only allocated but not initialized. The segment will be flagged write-only, so it cannot be read back or stored.

Examples Command

The following command defines a write-only segment with id 1 and length 1280 samples on channel 1.

```
:TRAC1:DEF:WONL 1,1280
```

:TRACe[1|2|3|4]:DEFine:WONLy:NEW?

Query :TRACe[1|2|3|4]:DEFine:WONLy:NEW?
<length>[,<init_value>]

Parameters <length>[,<init_value>]

- <length> - length of the segment in samples, marker samples do not count
- <init_value> - optional initialization DAC value

Parameter Suffix None

Description Use this query to define the size of a waveform memory segment. If `<init_value>` is specified, all sample values in the segment are initialized. If not specified, memory is only allocated but not initialized. If the query was successful, a new `<segment_id>` will be returned. The segment will be flagged write-only, so it cannot be read back or stored.

Examples Query

Define a write-only segment with length 1280 samples on channel 1.

Returns the segment Id.

```
:TRAC1:DEF:WONL:NEW? 1280
```

:TRACe[1|2|3|4]:DELeTe

Command :TRACe[1|2|3|4]:DELeTe <segment_id>

Query

Parameters <segment_id>

Parameter Suffix None

Description <segment_id> must be 1

Delete a segment. The command can only be used in program mode.

Examples Command

```
:TRAC:DEL 5
```

:TRACe[1|2|3|4]:DELeTe:ALL

Command :TRACe[1|2|3|4]:DELeTe:ALL

Query

Parameters None

Parameter Suffix None

Description Delete all segments. The command can only be used in program mode.

Examples Command

```
:TRAC:DEL:ALL
```

:TRACe[1|2|3|4]:IMPoRt[?]

Command	:TRACe[1 2 3 4]:IMPoRt <segment_id>,<file_name>,TXT BIN BIN8 IQBIN BIN6030 BIN5110 MAT89600 DSA90000 CSV,IONLY QONLY,ON OFF 1 0,[<marker_flag>],ALENgtH FILL][,<init_value>][,<ignore_header_parameters>]
Query	:TRACe[1 2 3 4]:IMPoRt?
Parameters	<segment_id>,<file_name>,TXT BIN BIN8 IQBIN BIN6030 BIN5110 MAT89600 DSA90000 CSV,IONLY QONLY,ON OFF 1 0,[<marker_flag>],ALENgtH FILL][,<init_value>][,<ignore_header_parameters>]

- File Format - Import segment data from a file. Different file formats are supported. An already existing segment can be filled, or a new segment can be created. This can be used to import real waveform data as well as complex I/Q data.
- <segment_id> - the number of the segment, into which the data will be written.
- <file_name> - the complete path of the file.
TXT|BIN|BIN8|IQBIN|BIN6030|BIN5110|MAT89600|DSA90000|CSV.
(See File Type) For details, see [Supported File Types](#) on page 93
- <data_type> - IONLY|QONLY. This parameter is only used, if the file contains I/Q data.
- <marker_flag> - ON|OFF|1|0
This flag is used to specify if the marker data need to be downloaded or not. If this flag is 'OFF' marker data will not be downloaded. Default value is 'ON'. This flag is applicable to BIN5110 format only. If BIN5110 format consists of full 16 bit DAC values (without markers) this flag should be set to 'OFF' so that 2 LSB's are ignored.
Since M8194A does not support markers this flag should be set to 'OFF'.
- <padding> - ALENgtH|FILL
 - ALENgtH: Automatic LENgtH : <segment_id> may or may not exist. After execution <segment_id> has exactly the length of the pattern in file or a multiple of this length to fulfill granularity and minimum segment length requirements. This behavior is default if <padding> is omitted.

- **FILL:** <segment_id> must exist. If pattern in file is larger than the defined segment length, just ignore excessive samples. If pattern in file is smaller than defined segment length, fill remaining samples with <init_value>. <init_value> defaults to 0 if it is not specified.
- <init_value> – optional initialization value. For non-I/Q format this is a DAC value. For I/Q file format this is the I-part or Q-part of an I/Q sample pair in binary format (int8). Defaults to 0 if not specified.
- <ignore_header_parameters> ON|OFF|1|0
This flag is used to specify if the header parameters need to be set. If this flag is 'ON' header parameters will not be set. This flag is optional and the default value is 'OFF' i.e. by default the header parameters are set. This flag is applicable to formats (CSV and MAT89600) that contain header parameters.

Parameter Suffix None

Description This command imports segment data from a file. It supports different file formats. Using this command, you can fill an already existing segment, or can create a new segment.

- <segment_id> must be 1
- <file_name> file name.
- <type> BIN. File format. (See File Type)
- <padding> ALENgth|FILL. (See Padding)
- <dac_value> a DAC value in binary format

Examples :TRAC1:IMP 1, "C:\Program Files (x86)\Keysight\M8194\Examples\WaveformDataFiles\ Sin10MHzAt64GHz.bin",
BIN, IONLY, ON, ALEN

:TRACe[1|2|3|4]:MARKer[:STATE][?]

Command :TRACe[1|2|3|4]:MARKer[:STATE] OFF|ON|0|1

Query :TRACe[1|2|3|4]:MARKer[:STATE]?

Parameters OFF | ON | 0 | 1

Parameter Suffix None

Description Use this command to enable or disable markers for the selected segment. The query form gets the current marker state.

Examples Command
:TRAC:MARK ON

Query

:TRAC:MARK?

:TRACe[1|2|3|4]:NAME[?]

Command :TRACe[1|2|3|4]:NAME <segment_id>, <name>

Query :TRACe[1|2|3|4]:NAME?

Parameters <segment_id>, <name>

Parameter Suffix None

Description This command associates a name to a segment. The query gets the name for a segment.

<segment_id> – must be 1

<name> – string of at most 32 characters

Examples Command

:TRAC:NAME 1, "ADY"

Query

:TRAC:NAME? 1

Multi-Module Configuration Commands

These commands and queries are used to identify reachable M8194A modules and to define a multi-module group consisting of up to four modules.

:INSTRument:MDIScover?

Query	:INSTRument:MDIScover?
Parameters	None
Parameter Suffix	None
Description	This query returns a comma-separated list of VISA resource strings of all M8194A modules known by the VISA Resource Manager.
Examples	:INST:MDIS?

:INSTRument:MMODule:IDENtify

Command	:INSTRument:MMODule:IDENtify <visa_resource_string>
Parameters	<visa_resource_string>
Parameter Suffix	None
Description	This command toggles the green "Access" LED of the M8194 module with the passed VISA resource string for 10 seconds. This allows easy identification of one module in a setup consisting of multiple AXI frames and multiple modules.
Examples	:INST:MMOD:IDEN "TCPIP0::localhost::hislip0::INSTR"

:INSTRument:MMODule:MODE?

Query	:INSTRument:MMODule:MODE?
Parameters	None
Parameter Suffix	None
Description	This query returns the multi-module configuration mode of the module. Possible return values are: 'NORMal' - Mmodule does not belong to a multi-module group, 'SLAVE' - Module is a slave module in a multi-module group, 'MASTer' - Module is the master in a multi-module group.
Examples	:INST:MMOD:MODE?

:INSTRument:MMODule:CONFig[?]

Command	:INSTRument:MMODule:CONFig[?] 0 1 OFF ON
Parameters	0 1 OFF ON
Parameter Suffix	None
Description	<p>The command form enables (1 ON) or disables (0 OFF) the multi-module configuration mode for the complete multi-module group. The command forms of the following SCPIs for slave selection are only available in multi-module configuration mode. The commands to change reference clock or sample rate settings are also only available in multi-module configuration mode.</p> <p>Only available on the master module of a multi-module group.</p> <p>The query form returns the state of the multi-module configuration mode.</p>
Examples	<p>Command</p> <pre>:INST:MMOD:CONF ON</pre> <p>Query</p> <pre>:INST:MMOD:CONF?</pre>

:INSTRument:SLAVe:LIST?

Query	:INSTRument:SLAVe:LIST?
Parameters	None
Parameter Suffix	None
Description	This query returns a comma-separated list of VISA resource strings of all M8194A slave modules that belong to the multi-module group.
Examples	:INST:SLAV:LIST?

:INSTRument:SLAVe:ADD

Command	:INSTRument:SLAVe:ADD <visa_resource_string>
Parameters	<visa_resource_string>
Parameter Suffix	None

Description This command adds the M8194A module with the passed VISA resource string as slave to the multi-module group. Only available if the module is in 'NORMal' or 'MASTer' mode. After adding the first slave module, the calling module is the master of the multi-module group.

Examples `:INST:SLAV:ADD "TCPIP0::localhost::hislip0::INSTR"`

:INSTrument:SLAVe:DELeTe

Command `:INSTrument: SLAVe:DELeTe <visa_resource_string>`

Parameters `<<visa_resource_string>`

Parameter Suffix None

Description This command deletes the M8194A slave module with the passed VISA resource string from the multi-module group. Only available on the master module of a multi-module group.

Examples `:INST:SLAV:DEL "TCPIP0::localhost::hislip0::INSTR"`

:INSTrument:SLAVe:DELeTe:ALL

Command `:INSTrument: SLAVe:DELeTe:ALL`

Parameters None

Parameter Suffix None

Description This command deletes all M8194A slave modules from the multi-module group. Only available on the master module of a multi-module group.

Examples `:INST:SLAV:DEL:ALL`

SCPI Command Differences Between M8194A and M8196A

This section is intended to the users who are using both M8194A and M8196A AWGs for waveform generation. Since, most of the SCPI commands in both the instruments are similar, so the user can use the same test automation suit, by making few edits. The following table only lists the differences in the SCPI commands between these two instruments:

Commands	M8194A	M8196A
:ARM[:SEQuence][:START][:LAYer]:MDElay	✗	✓
:ARM[:SEQuence][:START][:LAYer]:TRIGger:LEVel	✗	✓
:ARM[:SEQuence][:START][:LAYer]:TRIGger:SLOPe	✗	✓
:INITiate:CONTInuous[:STATe]	✗	✓
:INSTrument:MMODule:IDENTify	✓	✗
:INSTrument:MMODule:MODE?	✓	✗
:INSTrument:MMODule:CONFig[?]	✓	✗
:INITiate:ASYNc [1 2 3 4]	✓	✗
:INSTrument: SLAVE:LIST?	✓	✗
:INSTrument:SLAVE:ADD	✓	✗
:INSTrument:SLAVE:DELeTe	✓	✗
:INSTrument:SLAVE:DELeTe:ALL	✓	✗
:OUTPut{1:4}:ROSCillator:RCD1 RCD	✗	✓
:OUTPut{1:4}:ROSCillator:RCD2	✗	✓
:OUTPut{1:4}:ROSCillator:SCD	✗	✓
:OUTPut{1:4}:ROSCillator:SOURce	✗	✓
[:SOURce]:FREQuency:INT:RASTer	✗	✓
[:SOURce]:FREQuency:RANGe	✓	✗
[:SOURce]:FREQuency:RNG1 RNG:RASTer	✗	✓
[:SOURce]:FREQuency:RNG2:RASTer	✗	✓
[:SOURce]:ROSCillator:FREQuency	✗	✓

Commands	M8194A	M8196A
[.SOURce]:ROSCillator:RANGe	✗	✓
[.SOURce]:ROSCillator:RNG1 RNG:FREQuency	✗	✓
[.SOURce]:ROSCillator:RNG2:FREQuency	✗	✓
[.SOURce]:ROSCillator:RNG3:FREQuency	✗	✓
[.SOURce]:ROSCillator:CALibration[:FREQuency]?	✓	✗
[.SOURce]:ROSCillator:EXTernal:FREQuency[?]	✓	✗
[.SOURce]:ROSCillator:INTernal:FREQuency[?]	✓	✗
[.SOURce]:ROSCillator:INTernal:FREQuency:OVERRIDE[?]	✓	✗
:TRIGger[:SEQuence][:START]:BEGIN:HWDisable[:STATE]	✗	✓
:TRIGger[:SEQuence][:START]:BEGIN[:IMMediate]	✗	✓

Keysight M8194A 120 GSa/s Arbitrary Waveform
Generator

User Guide

5 M8194A Maintenance

[Service and Repair](#) / 172

[ESD Protection](#) / 172

[Power and Ventilation Requirements](#) / 174

[Thermal Protection](#) / 174

[Operating Environment](#) / 174

This chapter explains the steps required to install M8194A software package.

Service and Repair

This system should be serviced only by authorized personnel.

WARNING

Using controls or adjustments or performing procedures other than those specified in the documentation supplied with your equipment can result in hazardous radiation exposure.

ESD Protection

CAUTION

All the connectors are very sensitive to electrostatic discharge (ESD). There are also several exposed components on the PCAs, on both sides of M8194A, which can be touched accidentally while handling the unit and can risk damage to the instrument, due to ESD. When you connect a device or cable that is not fully discharged to these connectors, you risk damage to the instrument and expensive instrument repairs.

CAUTION

Electrostatic discharge (ESD) can damage the circuits of the M8194A. Avoid applying static discharges to the front-panel connectors. Avoid touching the front-panel connectors without first touching the frame of the instrument. Be sure the instrument and all connected devices (DUT, etc.) are properly earth-grounded (to a common ground) to prevent buildup of static charge and electrical over-stress.

Electrostatic discharge (ESD) can damage or destroy electronic components. All work on electronic assemblies should be performed at a static-safe work station. The following list and figure shows an example of a static-safe work station using two types of ESD protection. Purchase acceptable ESD accessories from your local supplier.

- Conductive table-mat and wrist-strap combination.
- Conductive floor-mat and heel-strap combination.

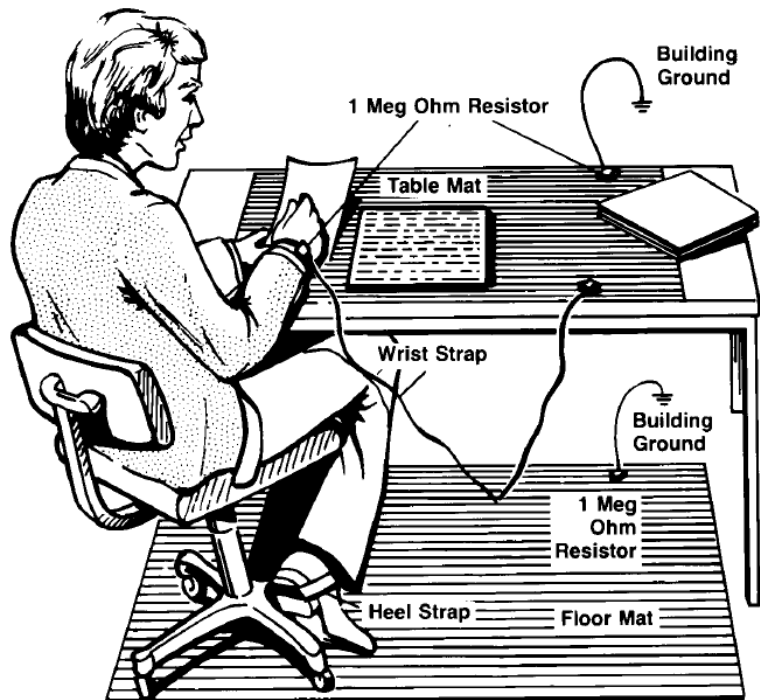

Figure 21 ESD protection

Both types, when used together, provide a significant level of ESD protection. Of the two, only the table-mat and wrist-strap combination provides adequate ESD protection when used alone. To ensure user safety, the static-safe accessories must provide at least 1 MW of isolation from ground.

WARNING

These techniques for a static-safe work station should not be used when working on circuitry with a voltage potential greater than 500 volts.

Power and Ventilation Requirements

For power and ventilation requirements, refer to:

- <http://www.keysight.com/find/M9514A> for 14-slot chassis related documentation.
- <http://www.keysight.com/find/M9505A> for 5-slot chassis related documentation.
- <http://www.keysight.com/find/M9502A> for 2-slot chassis related documentation.

Thermal Protection

Overheating Detection

The instrument monitors its internal temperature. If the temperature exceeds approximately 80°C the power supply is switched off. The instrument will not turn on automatically if the temperature is decreasing again.

Fan Failure

If a fan is broken or prevented from operating by a blockage the temperature will increase. When the temperature exceeds approximately 80°C the overheating detection switches off the instrument for safety reasons. For reliability it is recommended to send instruments with broken or defective fans immediately to Keysight Service for repair.

Operating Environment

For details on operating environment for M8194A module, refer to the section [Operating Environment](#) on page 175.

6 Characteristics

Performance Specification / 175

Operating Environment / 175

General / 176

Performance Specification

The performance specification can be found in the Data Sheet of the M8194A at: <http://www.keysight.com/find/M8194A>.

Operating Environment

Storage Temperature	-40 °C to +70 °C
Operating Temperature	0 °C to 40 °C
Operating Humidity	5% to 80% relative humidity, non-condensing
Operating Altitude	Up to 2000 m
Installation	Category II
Pollution	Degree 2

WARNING

The instrument is not designed for outdoor use. Do not expose the instrument to rain or other excessive moisture. Protect the instrument from humidity and temperature changes, which could cause condensation within the instrument.

Do not operate the instrument in the presence of flammable gases, fumes or powders. Operation of any electrical instrument in such an environment constitutes a definite safety hazard.

General

Power consumption	50 W (nom)
Safety designed to	IEC61010-1, UL61010, CSA22.2 61010.1 tested
EMC tested to	IEC61326-1
Warm-up time	30 min
Calibration interval	2 years recommended
Cooling Requirements	When operating the M8194A choose a location that provides at least 80 mm of clearance at rear, and at least 30 mm of clearance at each side for the AXIe chassis.

7

Appendix

[Resampling Requirements](#) / 178

[Resampling Methodology](#) / 178

[Generating 64 GBaud QAM Waveform](#) / 181

[Importing Sample Waveform Data](#) / 182

Resampling Algorithms for Waveform Import

Resampling Requirements

Resampling is typically associated to a series of processes applied to a waveform sampled at a given sampling frequency to generate a new waveform with a different sampling rate while preserving all the original information contained in the signal within the Nyquist bandwidth corresponding to the output sampling rate. Processes involved in resampling may vary depending on the output to input sampling rate ratio (or resampling factor) and the integer nature of the ratio itself. Resampling calculations, when applied to arbitrary waveform generation, must meet additional constraints such as available record length boundaries, record length granularity requirements, or acceptable sampling rate range.

Typically, the characteristics of the input waveform (sampling rate, record length) are externally defined (i.e. by the horizontal settings of an oscilloscope used to capture the waveform). Users may be interested in resampling the signal to adapt the input waveform to the AWG requirements or the user desires. In some cases, it may be necessary to reduce the sampling rate if it has been captured at a higher sampling rate than the one allowed by the AWG or to reduce the record length required to generate it. The opposite is also true as oversampling may help to “smooth” the signal as increasing sampling rate will shift the images created by the DAC to a higher frequency. Finally, resampling may be also necessary to adapt the record length of the input waveform to a legal record length that can be applied to a real AWG (i.e. to meet the record length granularities) without applying truncation or “zero padding” to the input waveform.

Resampling Methodology

Generally speaking, resampling factors do not have to be an integer or a simple fractional ratio. Because of that, traditional methods based in upsampling/filtering/decimation techniques may not be suitable given the amount of calculations resulting from the typical input waveform sizes involved. Instead of this, a more straight forward approach has been chosen. This approach is based in the following principles:

- Only output samples will be calculated so there is not any up-sampling and/or down-sampling operations involved.
- Filtering calculations will be kept to a minimum by using a filter with a fast enough roll-off and sufficient stop band attenuation according to the target AWG dynamic range.

- Interpolation filter and anti-alias filters are exactly the same although the filter parameters will depend on the resampling parameters.
- The implemented algorithm does perform filtering and interpolation simultaneously so the number of calculations is greatly reduced. Additionally, filters are implemented as look-up tables so those are calculated only once during the process.
- Timing parameters are based in double precision floating-point numbers while amplitude related parameters are single precision numbers. Most calculations consist in multiplication/addition operations required by convolution processes and only involve amplitude related variables (input samples and filter coefficients). Single precision numbers will minimize calculation time while offering more than enough dynamic range.

Interpolators and anti-aliasing filters share most characteristics as they are required to be low-pass with good flatness, linear phase, fast roll-off, and high stop-band rejections ratio. Ideal interpolator filters show a “brick-wall” response. However, such filters require a very long “sinc-like” impulse response to obtain good-enough performance. Impulse response length has a direct effect on calculation times resulting of applying the filter. Roll-off characteristics are especially important when applying the filter as the anti-alias filter required for down-sampling. The filter implemented in these algorithms has been designed with the following objectives:

- Pass band flatness better than 0.01 dB
- Stop band attenuation better than 80 dB
- F80dB/F3dB ratio better than 1.15

The final filter consists in a sinc signal with a 41 sample periods length after applying a Blackman-Harris time-domain window.

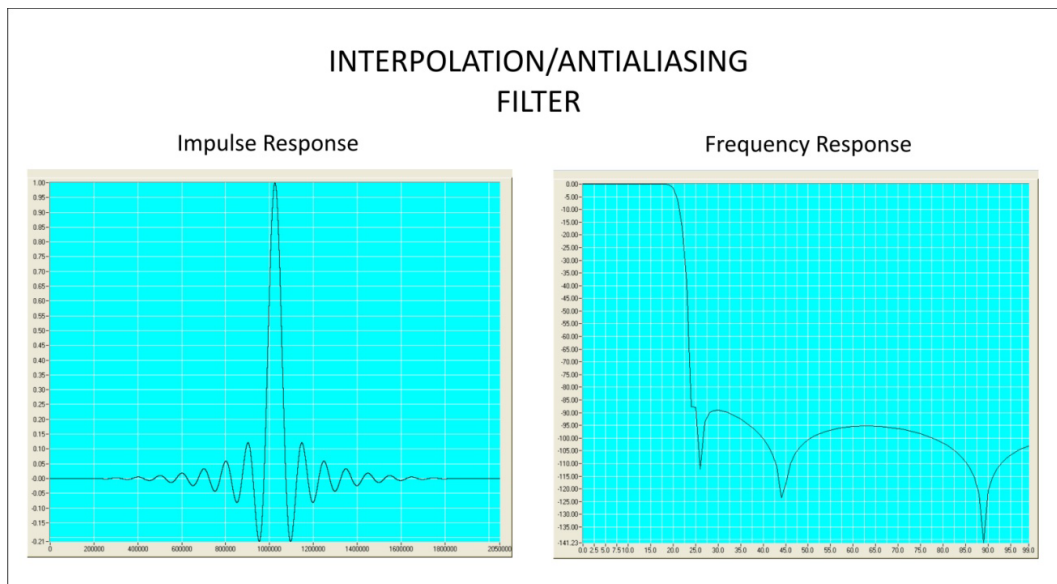

Figure 22 Interpolation/Antialiasing filter

The filter shape remains the same no matter the resampling characteristics. For resampling ratios greater than 1.0, filter will implement an interpolator so nulls in the impulse response must be located at multiples of the sampling period of the input signal. For ratios lower than 1.0 the filter will implement an antialiasing filter. In this case, distance between nulls will have to be longer than the output waveform sampling period so the filter reach the required attenuation (>80 dB) at the output signal Nyquist frequency. For the implemented filter this is accomplished by choosing 0.89 ratio between the output sampling period and the distance between consecutive nulls in the filter's impulse response.

Examples for Generating Waveforms

Generating 64 GBaud QAM Waveform

The **Complex Modulated Waveform** tab can be used to generate 64 GBaud QAM waveform. For details on **Complex Modulated Waveform** tab and its parameters, refer to section [Complex Modulated Waveform Tab](#) on page 64.

Follow the given steps to generate 64 GBaud QAM waveform:

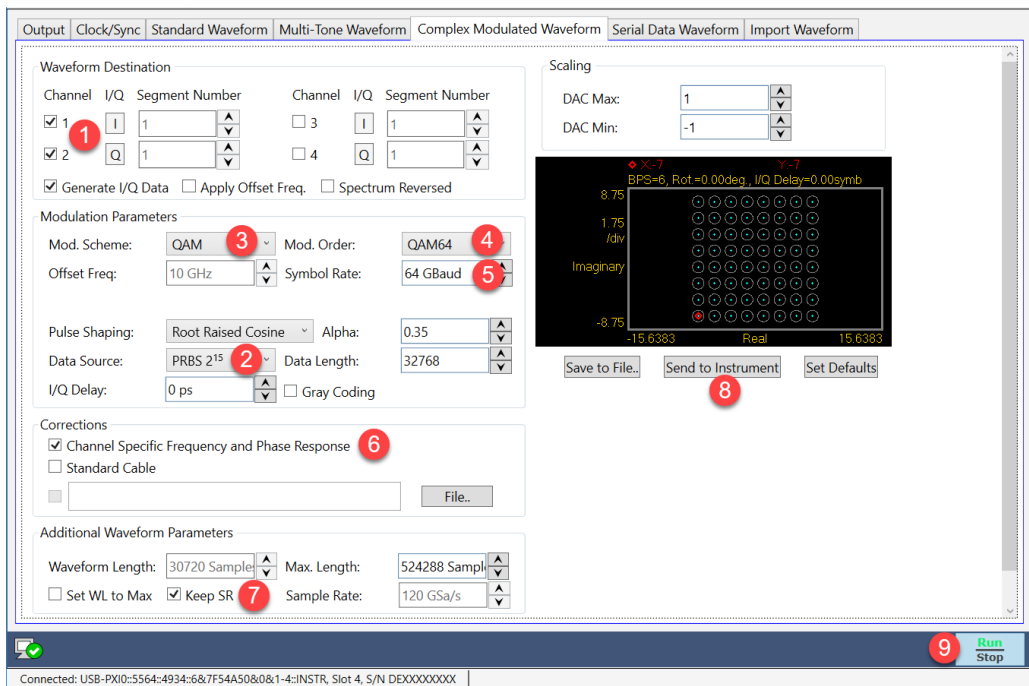

- 1 Select the channels on which the waveform will be defined. When the **'Send To Instrument'** button is pressed, the waveform will be sent to all selected channels.
- 2 Select the data source "PRBS 2¹⁵".
- 3 Select modulation scheme as QAM.
- 4 Select modulation order as QAM64.
- 5 Select the symbol rate as 64 GBaud.

- 6 Select the “**Channel Specific Frequency and Phase Response**” check box. This helps to improve flatness and linear phase distortions.
- 7 Ensure that the “**Keep SR**” check box is selected. This keeps the sampling rate to a user-defined value, irrespective of any other defined signal parameter.
- 8 Click “**Send to Instrument**” button. The signal will be transferred to the selected segments of the selected channels.
- 9 Click “**Run**” button to start a waveform generation on the selected channels.

Importing Sample Waveform Data

The sample waveform data files are available for user in different formats. These files can be simply imported using the **Import Waveform** tab and can be sent to the instrument to view the waveform preview. For details on **Import Waveform** tab, see [Import Waveform Tab](#) on page 84. The sample waveform data can be found at the location: **Start > All Programs > Keysight M8194 > Keysight M8194 Examples > WaveformDataFiles**

Follow the given steps to view the sample data file waveform preview:

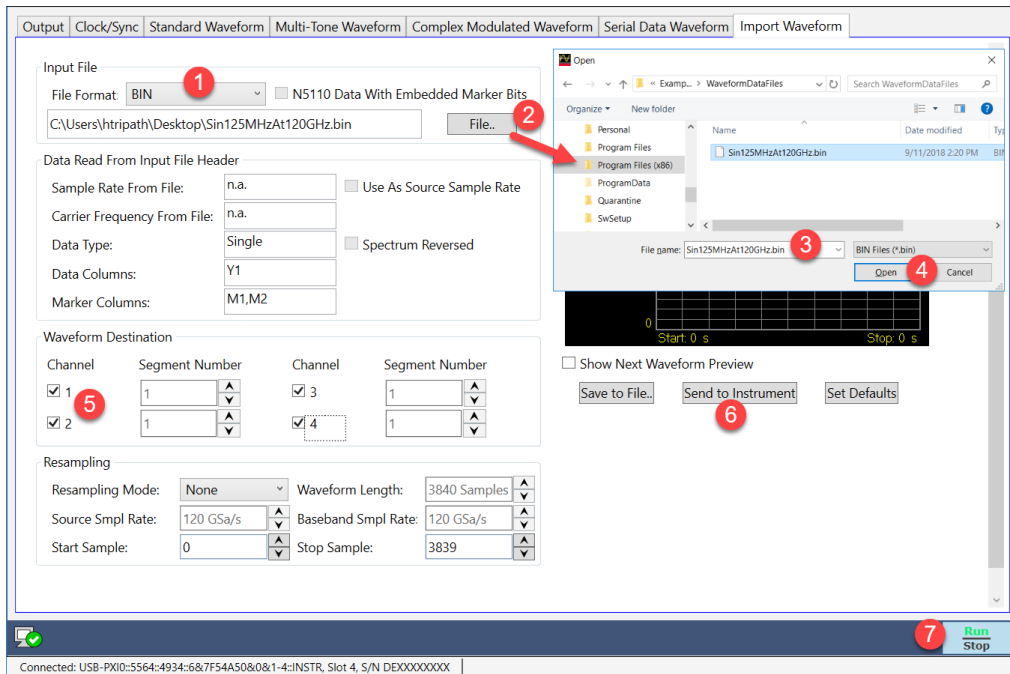

- 1 Select the required **File Format** from the drop-down list. for details on supported file formats, see [Supported File Types](#) on page 93.
- 2 Click **File...** button.
- 3 In the **Open** dialog box, select the sample waveform file (as per selected file format).
- 4 Click **Open**.
- 5 Select the channels on which the waveform will be defined. When the '**Send To Instrument**' button is pressed, the waveform will be sent to all selected channels.
- 6 Click **Send to Instrument**.
- 7 Click "**Run**" button to start a waveform generation on the selected channels.

Index

A

Additional Documents, [18](#)
Arbitrary Waveform Generator, [12](#)

C

Characteristics, [175](#)
Common Commands, [118](#)
Connect to Instrument dialog, [30](#)

D

Data Source Tab, [56](#)
Document Library, [18](#)

E

ESD Protection, [172](#)
Examples, [175](#)

F

Fan failure, [174](#)
Feature Options, [13](#)
File menu, [34](#)

H

Help menu, [35](#)

I

Installation Process, [21](#)
IOs Tab, [56](#)

K

Key Features, [12](#)

Keysight IO Libraries Suit, [20](#)

M

M8194A Arbitrary Waveform Generator, [11](#)
M8194A Installation, [21](#)
M8194A IVI Drivers, [28](#)
M8194A Overview, [12](#)
M8194A Soft Front Panel, [30, 33](#)
M8194A User Interface, [29](#)
Menu bar, [34](#)

N

Numeric Control Usage, [40](#)

O

Operating Environment, [175](#)
Operating environment, [174](#)
Overheating detection, [174](#)

P

PCIe, [28](#)
Performance Specification, [175](#)
Post Installation Steps, [27](#)
Post-installation steps, [27](#)
Power requirements, [174](#)
Pre-requisites, [20](#)

R

Related Documents, [18](#)
Remote Programming, [111, 112](#)

S

Safety Summary, [3](#)
Service and Repair, [172](#)
Status Indicator, [39](#)

T

Thermal protection, [174](#)
Title bar, [34](#)
Tools menu, [35](#)

U

Using M8194A Instrument, [28](#)
Utilities menu, [35](#)

V

Ventilation requirements, [174](#)
View menu, [34](#)

