



Revision 1.00

February 27, 2015

**Keysight Method of Implementation (MOI) for
VESA DisplayPort (DP) Standard Version 1.3
Cable-Connector Compliance Tests
Using E5071C ENA Option TDR**

Table of Contents

1.	Modification Record.....	4
2.	Purpose	4
3.	References	4
4.	Resource Requirements	4
5.	Test Procedure	5
5.1.	Outline of Test Procedure	5
5.2.	Instrument Setup.....	6
5.3.	Connection Configuration	7
5.4.	Calibration	10
5.4.1.	Time Domain Calibration	10
5.4.2.	Frequency Domain Calibration	14
5.4.3.	Set System Impedance (Optional).....	16
5.5.	Measurement and Data Analysis	17
5.5.1.	Bulk Cable and Connector Impedance	17
5.5.2.	Intra-Pair Skew	18
5.5.3.	Insertion Loss	19
5.5.4.	Return Loss.....	20
5.5.5.	Inter- pair Skew	21
5.5.6.	Near End Noise (NEN).....	22
5.5.7.	Far End Noise (FEN).....	23
6.	Appendix	28
6.1.	Defining a calibration Kit.....	28
6.2.	Manual Setup for Time Domain Measurement	31
6.2.1.	Starting Setup	31
6.2.2.	Bulk Cable and Connector Impedance Measurements (Normative)	32
6.2.3.	Intra-Pair Skew Measurement (Normative)	33
6.2.4.	Inter-pair Skew Measurements (Normative)	35

Keysight MOI for DisplayPort Cable & Connector Compliance Tests

6.3. Manual Setup for Frequency Domain Measurement.....	35
6.3.1. Channel and Trace Settings	35
6.3.2. Common Settings	36
6.3.3. Far End Noise (FEN) Measurement (Normative)	36
6.3.4. Return Loss Measurement (Normative)	37
6.3.5. Insertion Loss Measurement (Normative).....	37
6.3.6. Near End Noise (NEN) Measurement	37
6.4. Limit Test Settings	38
6.4.1. Displaying Judgment Result of Test	38
6.4.2. Setting the Warning Beeper	38
6.4.3. Defining the Limit Line	38
6.5. Calculating formula for Limit Line	39
6.5.1. Bulk Cable and Connector Impedance	39
6.5.2. Insertion Loss	41
6.5.3. Return Loss.....	42
6.5.4. Near End Noise (NEN).....	44
6.5.5. Far End Noise (FEN).....	44

1. Modification Record

Revision	Comments	Issue Date
1.00	Initial Release.	Feb 27, 2015

2. Purpose

This test procedure was written to explain how to use the Keysight E5071C ENA Option TDR to make the measurements required per VESA DisplayPort Standard Version 1.3.

3. References

VESA DisplayPort Standard Version 1.3, 17 September 2014

4. Resource Requirements

1. E5071C Network Analyzer with option TDR and option 4D5 or 4K5

Note: Ensure that

- E5071C firmware revision A.11.31 or above (Windows XP), or B.12.04 or above (Windows 7) is installed

- E5071C-TDR application software revision A.01.57 or above (Windows XP), or B.02.00 or above (Windows 7) is installed

2. Display Port test fixtures: BitifEye BIT-1050-0001-0, or equivalent
3. Four 3.5 mm cables 20 GHz bandwidth or equivalent (cables of equal length and characteristics must be used for all test ports)
4. 50 Ohm terminators to terminate unused channels (ex. Keysight 909D-301)

5. Test Procedure

5.1. Outline of Test Procedure

- 1. Connect 3.5 mm test cables to instrument**
- 2. Set measurement conditions**
- 3. Perform Calibration**
- 4. Measurements and Data Analysis**

Time Domain Measurements

- Bulk Cable and Connector Impedance Measurements (Normative)
- Intra-pair Skew Measurements (Normative)
- Inter-pair Skew Measurements (Normative)

Frequency Domain Measurements

- Insertion Loss Measurements (Normative)
- Return Loss Measurements (Normative)
- Near End Noise (NEN) Measurements
- Far End Noise (FEN) Measurements (Normative)

Note:

- Hard keys (keys located on the E5071C front panel) are displayed in **blue color** and **bold**.
(Example: **Avg, Analysis**)
- Soft keys (keys located on the display) are displayed in **bold**. (Example: **S11, Real, Transform**)
- Buttons (located in the TDR GUI) are displayed in **green color** and **bold**. (Example: **Trace, Rise Time**)
- Tabs (located in the TDR GUI) are displayed in **brown color** and **bold**. (Example: **Setup, Trace Control**)

Keysight MOI for DisplayPort Cable & Connector Compliance Tests

5.2. Instrument Setup

This section describes how to recall a state file for DisplayPort compliance test settings. The state file can be downloaded from www.keysight.com/find/ena-tdr_dp1_3-cabcon. If you use your local PC to download, save the state file to a USB mass storage device in order to move it to E5071C. Connect the USB mass storage device into the front USB port of the E5071C. For manual settings, refer to Appendix.

1. If TDR setup wizard appears, click **Close** button on the wizard.
2. Open **Setup** tab (item 1).
3. Click **Advanced Mode** (item 2).

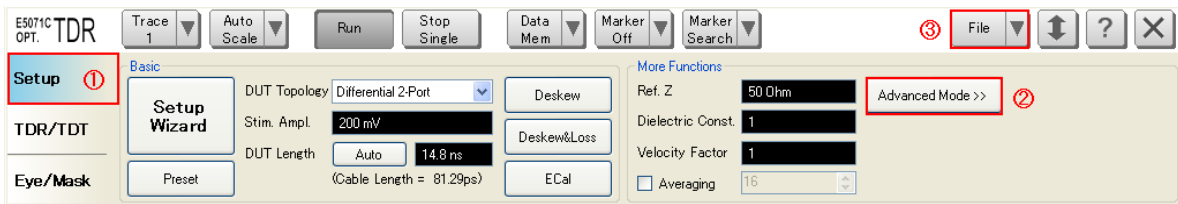

4. A dialog box appears requesting for confirmation. Then click **Yes**. (Clear the check box for “Use Advanced Calibration Methods”)

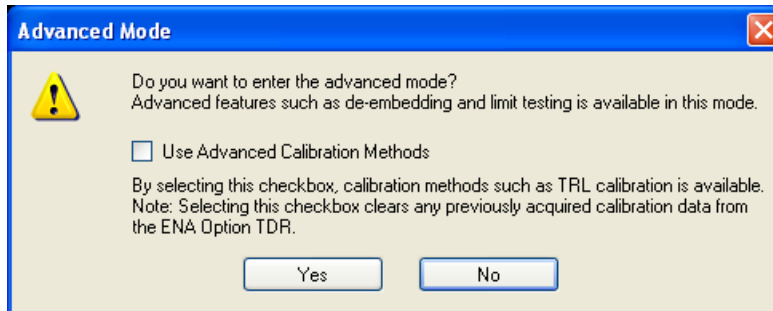

5. Click **File** (item 3) and select **Recall State** to open the Recall State dialog box.
6. Specify a folder and a file name, and click **Open**.

5.3. Connection Configuration

This section describes the ENA Option TDR screen allocation and the test cable connection requirements.

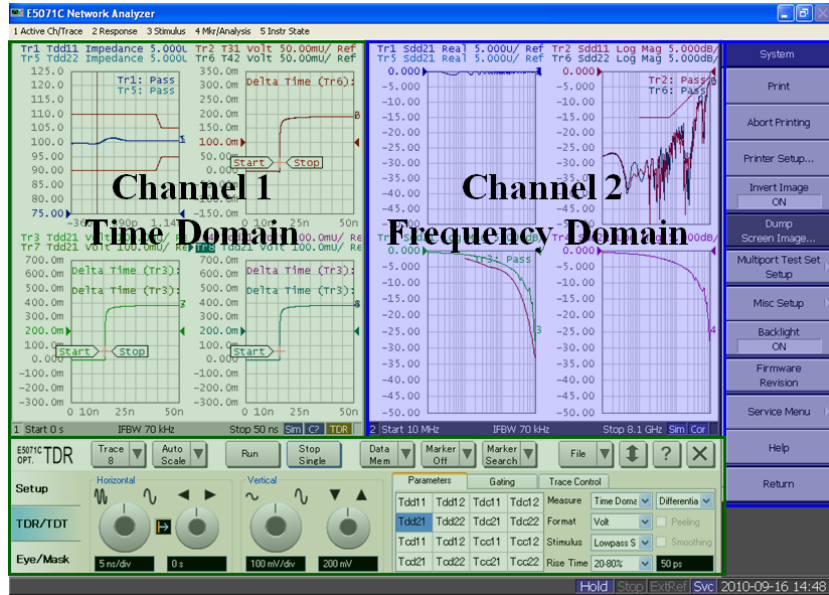

Figure 5-1: Measurement screen description.

Channel 1, for time domain measurements, is controlled by the TDR user interface at the bottom of the screen and Channel 2, for frequency domain measurements, is controlled by the soft-key on the right-side of the screen and hard-key on the instrument front panel.

Keysight MOI for DisplayPort Cable & Connector Compliance Tests

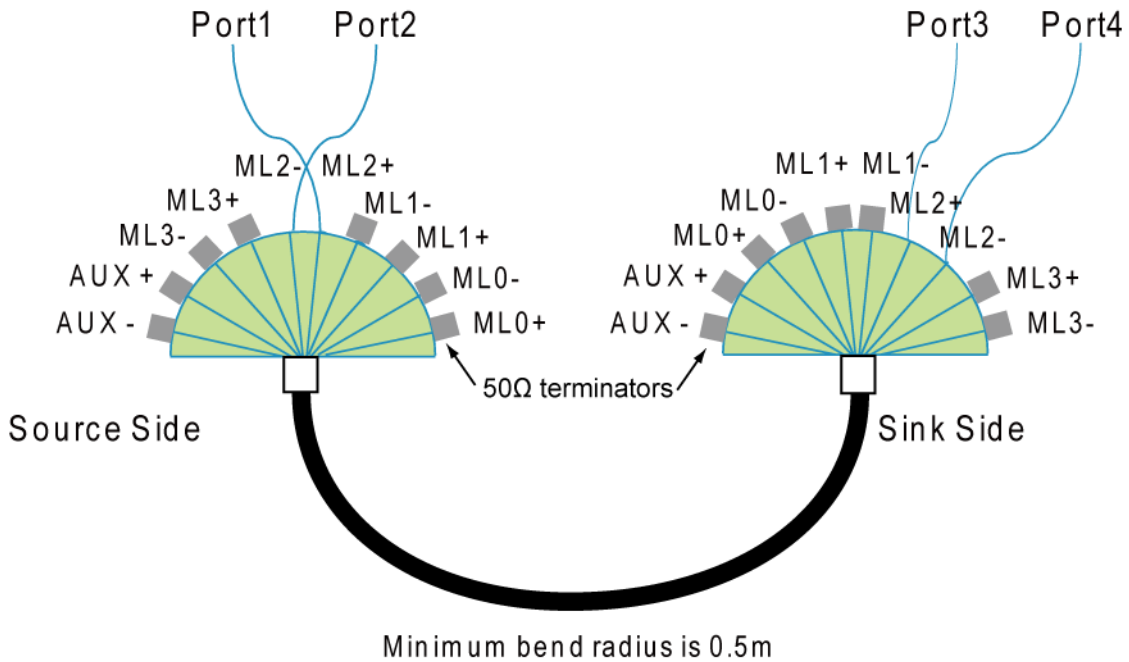

Figure 5-2: Connection example between the instrument and test fixture

The test cables and fixtures should be connected to the instrument as shown in the figure above. Table 5-1 shows the test cable connection for each measurement item. The measurement items of the same cable connection can be done simultaneously.

Table 5-1 Cable and Fixture Connection (A: Source Side, B: Sink Side)

ENA Port Number		Port1	Port2	Port3	Port4
Fixture PIN Number	Bulk Cable and Connector Impedance	A ML0+	A ML0-	B ML0+	B ML0-
		A ML1+	A ML1-	B ML1+	B ML1-
		A ML2+	A ML2-	B ML2+	B ML2-
		A ML3+	A ML3-	B ML3+	B ML3-
		A AUX+	A AUX-	B AUX+	B AUX-
	Intra-pair Skew	A ML0+	A ML0-	B ML0+	B ML0-
		A ML1+	A ML1-	B ML1+	B ML1-
		A ML2+	A ML2-	B ML2+	B ML2-
		A ML3+	A ML3-	B ML3+	B ML3-
		A AUX+	A AUX-	B AUX+	B AUX-
Insertion Loss	A ML0+	A ML0-	B ML0+	B ML0-	
	A ML1+	A ML1-	B ML1+	B ML1-	
	A ML2+	A ML2-	B ML2+	B ML2-	
	A ML3+	A ML3-	B ML3+	B ML3-	
	A AUX+	A AUX-	B AUX+	B AUX-	
Return Loss	A ML0+	A ML0-	B ML0+	B ML0-	
	A ML1+	A ML1-	B ML1+	B ML1-	
	A ML2+	A ML2-	B ML2+	B ML2-	
	A ML3+	A ML3-	B ML3+	B ML3-	
	A AUX+	A AUX-	B AUX+	B AUX-	
Inter-pair Skew	A ML0+	A ML0-	B ML0+	B ML0-	
	A ML1+	A ML1-	B ML1+	B ML1-	
	A ML2+	A ML2-	B ML2+	B ML2-	
	A ML3+	A ML3-	B ML3+	B ML3-	
	A AUX+	A AUX-	B AUX+	B AUX-	

Keysight MOI for DisplayPort Cable & Connector Compliance Tests

Near End Noise (NEN)	A ML0+	A ML0-	A AUX+	A AUX-
	A ML1+	A ML1-	A AUX+	A AUX-
	A ML2+	A ML2-	A AUX+	A AUX-
	A ML3+	A ML3-	A AUX+	A AUX-
	B AUX+	B AUX-	B ML0+	B ML0-
	B AUX+	B AUX-	B ML1+	B ML1-
	B AUX+	B AUX-	B ML2+	B ML2-
Far End Noise ¹ (FEN)	A ML1+	A ML1-	B ML0+	B ML0-
	A AUX+	A AUX-		
	A ML0+	A ML0-	B ML1+	B ML1-
	A ML2+	A ML2-		
	A ML1+	A ML1-	B ML2+	B ML2-
A ML3+	A ML3-			
A ML2+	A ML2-	B ML3+	B ML3-	
A ML0+	A ML0-	B AUX+	B AUX-	

¹ Switch the Display Port cable end and repeat the same measurement for the opposite direction.

Measurement Window Description

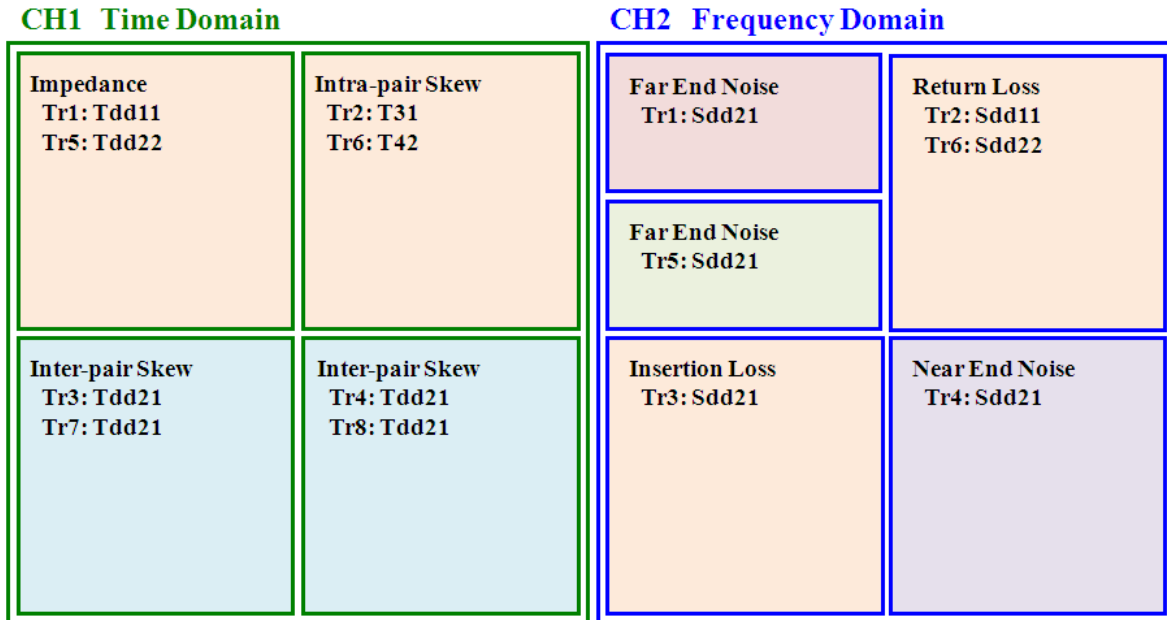

Background colors coincide with the table in the previous page.

5.4. Calibration

5.4.1. Time Domain Calibration

5.4.1.1. Deskew & Loss Compensation Calibration

1. Press **Channel Next** key to select Channel 1.
2. Open **Setup** tab (item 1).
3. Click **Deskew&Loss** (item 2) to launch the Deskew & Loss Compensation wizard.

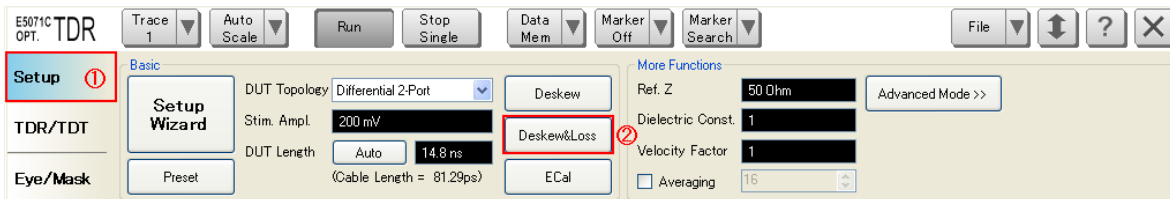

4. Click **Options** (item3), then Deskew Options dialog box appears.

Keysight MOI for DisplayPort Cable & Connector Compliance Tests

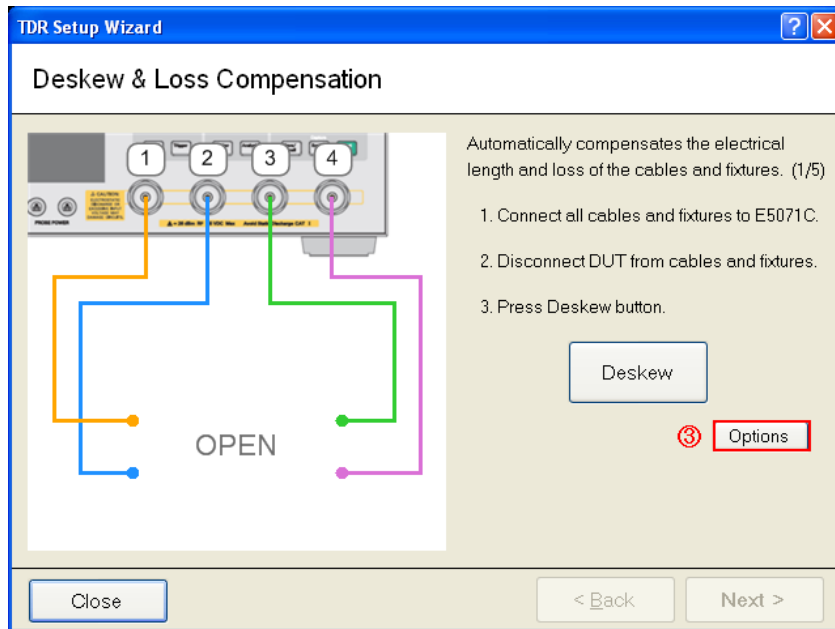

5. Select **standard type** (item 4) to Short.
6. Connect “Short” standard to Port1.
7. Click **Port 1** (item 5). Wait until the check-mark appears under Port1.
8. Connect “Short” standard to Port2.
9. Click **Port 2** (item 6). Wait until the check-mark appears under Port2.
10. Connect “Short” standard to Port3.
11. Click **Port 3** (item 7). Wait until the check-mark appears under Port3.
12. Connect “Short” standard to Port4.
13. Click **Port 4** (item 8). Wait until the check-mark appears under Port4.
14. Click **OK** (item 9).

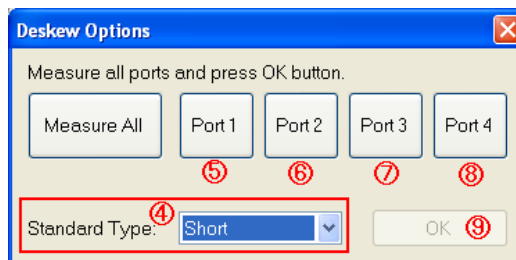

15. Click **Next**.
16. Connect “Thru” standard between Port 1 and Port 3.

Keysight MOI for DisplayPort Cable & Connector Compliance Tests

17. Click **Measure** (item 10).
18. Click **Next** (item 11).

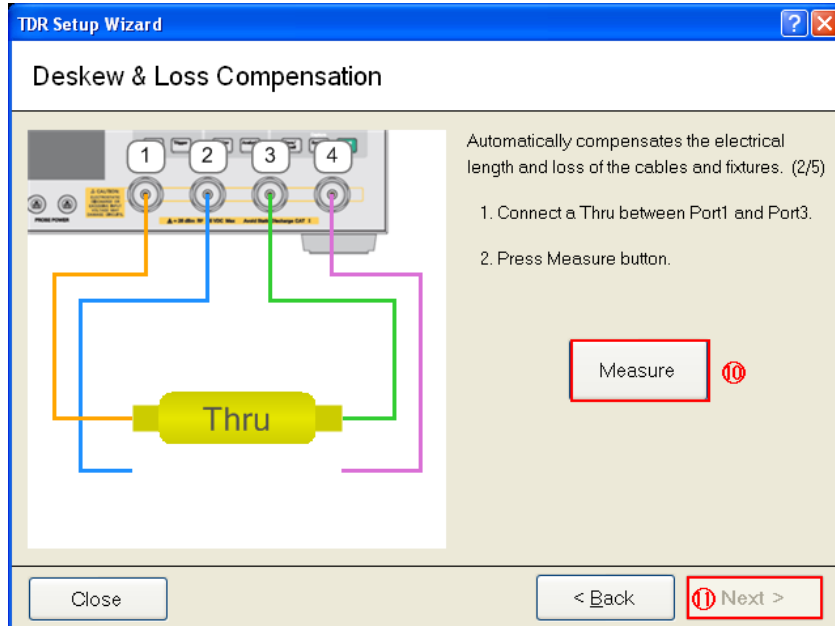

19. Connect “Thru” standard between Port 2 and Port 4.
20. Click **Measure** (item12).
21. Click **Next** (item13).

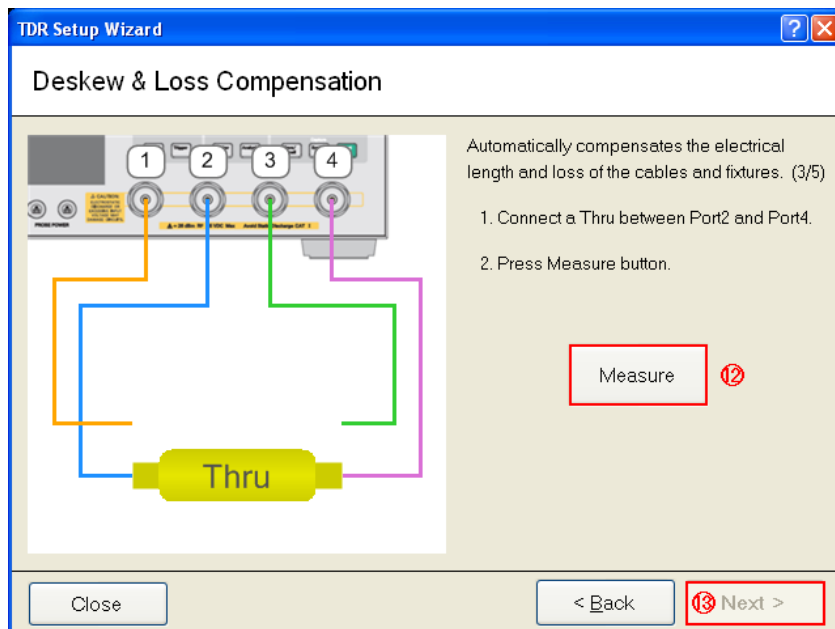

22. Connect “Load” standard to Port 1.

Keysight MOI for DisplayPort Cable & Connector Compliance Tests

23. Click **Port 1** (item 14). Wait until the check-mark appears under Port 1.
24. Connect “Load” standard to Port 2.
25. Click **Port 2** (item 15). Wait until the check-mark appears under Port 2.
26. Connect “Load” standard to Port 3.
27. Click **Port 3** (item 16). Wait until the check-mark appears under Port 3.
28. Connect “Load” standard to Port 4.
29. Click **Port 4** (item 17). Wait until the check-mark appears under Port 4.
30. Click **Apply** (item 18).
31. Click **Finish** (item 19).

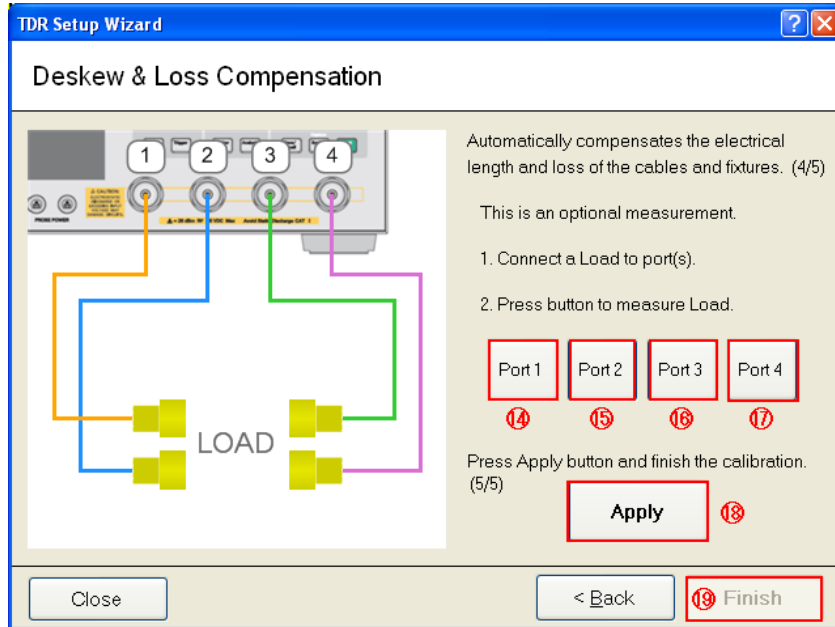

5.4.1.2. Set DUT Length

1. Click **Auto** (item 1) to measure the DUT length.

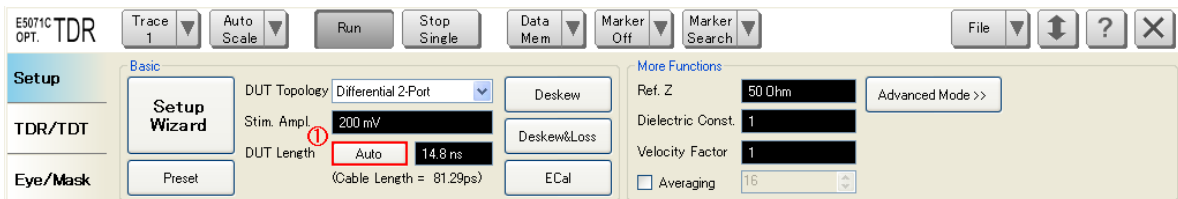

2. Connect the test fixture and DUT as follows.

Keysight MOI for DisplayPort Cable & Connector Compliance Tests

ENA Port Number	Port1	Port2	Port3	Port4
Fixture Pin Number	A ML0+	A ML0-	B ML0+	B ML0-

A: Source Side, B: Sink Side

3. Click **Measure** (item 1).
4. Click **Finish** (item 2).

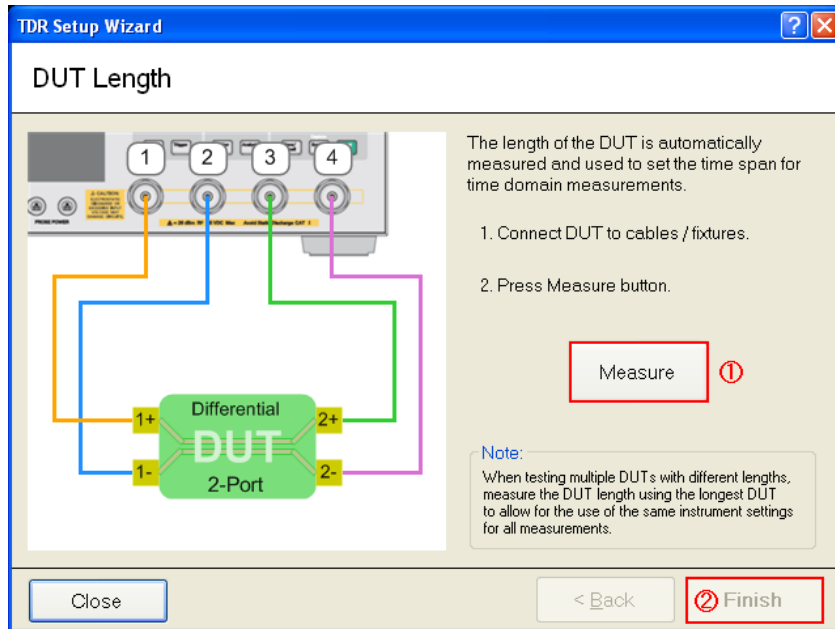

5.4.2. Frequency Domain Calibration

5.4.2.1. Define Cal kit

The cal kit definition file shall be provided by the fixture supplier, or created according to “Section 6.1 Defining a calibration Kit”.

1. Press **Cal** key to select channel 2.
2. Click **Cal Kit**, then select a **User**.
3. Click **Modify Cal Kit** > **Import Cal Kit...** to open the dialog box.
4. Specify a folder, enter a file name, and click **Open**.

Keysight MOI for DisplayPort Cable & Connector Compliance Tests

5.4.2.2. TRL Calibration

1. Press **Channel Next** key to select channel 2.
2. Press **Cal** key.
3. Click **Cal kit** and select Cal kit which you previously defined.
4. Click **Calibrate > 4-Port TRL Cal.**
5. Click **Thru/Line.**
 - a) Connect “Thru” standard between Port 1 and Port 2.
 - b) Click **1-2 Thru/Line.**
 - c) Connect “Thru” standard between Port 1 and Port 3.
 - d) Click **1-3 Thru/Line.**
 - e) Connect “Thru” standard between Port 3 and Port 4.
 - f) Click **3-4 Thru/Line.**
 - g) Click **Return.**
6. Click **Reflect.**
 - a) Connect “Short” or “Open” standard defined at subclass setting to Port 1.
 - b) Click **Port1 Reflect.**
 - c) Connect “Short” or “Open” standard defined at subclass setting to Port 2.
 - d) Click **Port2 Reflect.**
 - e) Connect “Short” or “Open” standard defined at subclass setting to Port 3.
 - f) Click **Port3 Reflect.**
 - g) Connect “Short” or “Open” standard defined at subclass setting to Port 4.
 - h) Click **Port4 Reflect.**
 - i) Click **Return.**
7. Click **Line/Match**
 - a) Click **1-2 Line/Match.**
 - b) Connect “Load” standard between Port 1 and Port 2.
 - c) Click **Line/Match 1[Load].**
 - d) Connect “Line1” standard between Port 1 and Port 2.

Keysight MOI for DisplayPort Cable & Connector Compliance Tests

- e) Click **Line/Match 2[Line1]**.
 - f) Connect “Line2” standard between Port 1 and Port 2.
 - g) Click **Line/Match 3[Line2]**.
 - h) Connect “Line3” standard between Port 1 and Port 2.
 - i) Click **Line/Match 4[Line3]**.
 - j) Connect “Line4” standard between Port 1 and Port 2.
 - k) Click **Line/Match 4[Line4]**.
 - l) Click **Return**.
 - m) Click **1-3 Line/Match** and repeat step b) to l).
 - n) Click **3-4 Line/Match** and repeat step b) to l).
 - o) Click **Return**.
8. Click **Done** to finish TRL 4-port calibration. At this point, the calibration coefficient is calculated and saved. The error correction function is automatically turned on.

Note: Refer to “4-port TRL Calibration” in the ENA online help for more details.

5.4.3. Set System Impedance (Optional)

In case that Load standard is not 50 ohm, system impedance must be set to the actual Load impedance.

1. Press **Cal** > Set **Set Z0** to actual impedance of the Load standard.
2. Click **Return**.

Keysight MOI for DisplayPort Cable & Connector Compliance Tests

5.5. Measurement and Data Analysis

5.5.1. Bulk Cable and Connector Impedance

5.5.1.1. Load Limit File

Using limit line files available on www.keysight.com/find/ena-tdr_dp1_3-cabcon, the ENA automatically performs pass/fail test. Since pass/fail criteria vary depending on the bit rate, cable category, or connector type, appropriate limit line files should be loaded prior to making measurements.

1. Select a trace on which a limit line should be set.
2. Press **Analysis > Limit Test > Edit Limit Line > Import from CSV File...** to display the **Open** dialog box.
3. Select an appropriate limit file according to the table for each measurement item.
4. Click **Return**.

Table 5-2: Impedance Limit File for Trace 1 and Trace 5 in Channel 1

Bit Rate	Cable Category	Connector Type	File Name
All	All	Full-size DP	DP_ImpedanceProfile_Full.CSV
All	All	Mini DP	DP_ImpedanceProfile_Mini.CSV

5.5.1.2. Measurement

1. Connect the test fixture to the test cables according to Table 5-3. Unused test ports should be terminated.

Table 5-3: Impedance, Intra-pair Skew, Insertion Loss and Return Loss Connection (A: Source Side, B: Sink Side)

ENA Port Number	Port1	Port2	Port3	Port4
Fixture PIN Number	A ML0+	A ML0-	B ML0+	B ML0-
	A ML1+	A ML1-	B ML1+	B ML1-
	A ML2+	A ML2-	B ML2+	B ML2-
	A ML3+	A ML3-	B ML3+	B ML3-

Keysight MOI for DisplayPort Cable & Connector Compliance Tests

	A AUX+	A AUX-	B AUX+	B AUX-
--	--------	--------	--------	--------

2. Connect Display Port cable to the test fixture.
3. Press **Channel Next** key to select Channel 1.
4. Press **Channel Max** key to enlarge Channel 1.
5. Click **Stop Single** for Time Domain measurement.

5.5.1.3. Data Analysis

Read Pass/Fail signs on Trace 1 and Trace 5. (item 1 in Figure 5-3)

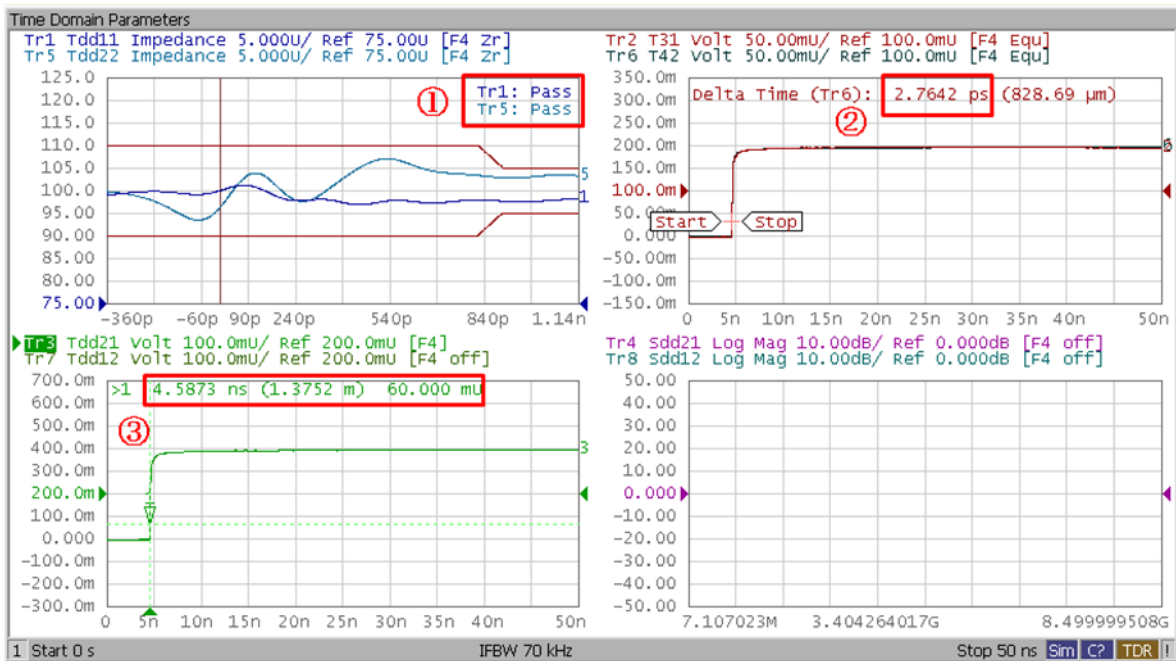

Figure 5-3: Time Domain Measurement Example

5.5.2. Intra-Pair Skew

5.5.2.1. Measurement

Refer to 5.5.1.2.

5.5.2.2. Data Analysis

Read the delta time between Trace 2 and Trace 6 (item 2 in Figure 5-3).

Keysight MOI for DisplayPort Cable & Connector Compliance Tests

Intra-pair Skew Upper Limit for High Bit Rate Cable Assembly

Cable Category	Limit
Cable Assembly	delta time <= 50 ps, then Pass. Otherwise Fail.
Resizing Adaptor	delta time <= 10 ps, then Pass. Otherwise Fail.
Extension Cable	delta time <= 35 ps, then Pass. Otherwise Fail.

Intra-pair Skew Upper Limit for Reduced Bit Rate Cable Assembly

Cable Category	Limit
Any	delta time <= 250 ps, then Pass. Otherwise Fail.

5.5.3. Insertion Loss

5.5.3.1. Load Limit file

Refer to 5.5.1.1.

Table 5-4 Insertion Loss Limit Line File for Trace 3 in Channel 2

Bit Rate	Cable Category	Connector Type	File Name
HBR	Cable	All	DP_HBR_InsertionLoss_Cable.CSV
	Resizing Adaptor	All	DP_HBR_InsertionLoss_Adapter.CSV
	Extension Cable	All	DP_HBR_InsertionLoss_ExtCable.CSV
RBR	All	All	DP_RBR_InsertionLoss.CSV

5.5.3.2. Measurement

1. Connect the test fixture to the test cables according to the Table 5-3. Unused test ports should be terminated.
2. Connect Display Port cable to the test fixture.
3. Press **Channel Next** key to select Channel 1.
4. Press **Channel Max** key to enlarge Channel 1.
5. Press **Trigger > Single** for frequency domain measurement.

Keysight MOI for DisplayPort Cable & Connector Compliance Tests

5.5.3.3. Data Analysis

Read Pass/Fail signs on Trace 3 (item 1 in Figure 5-4).

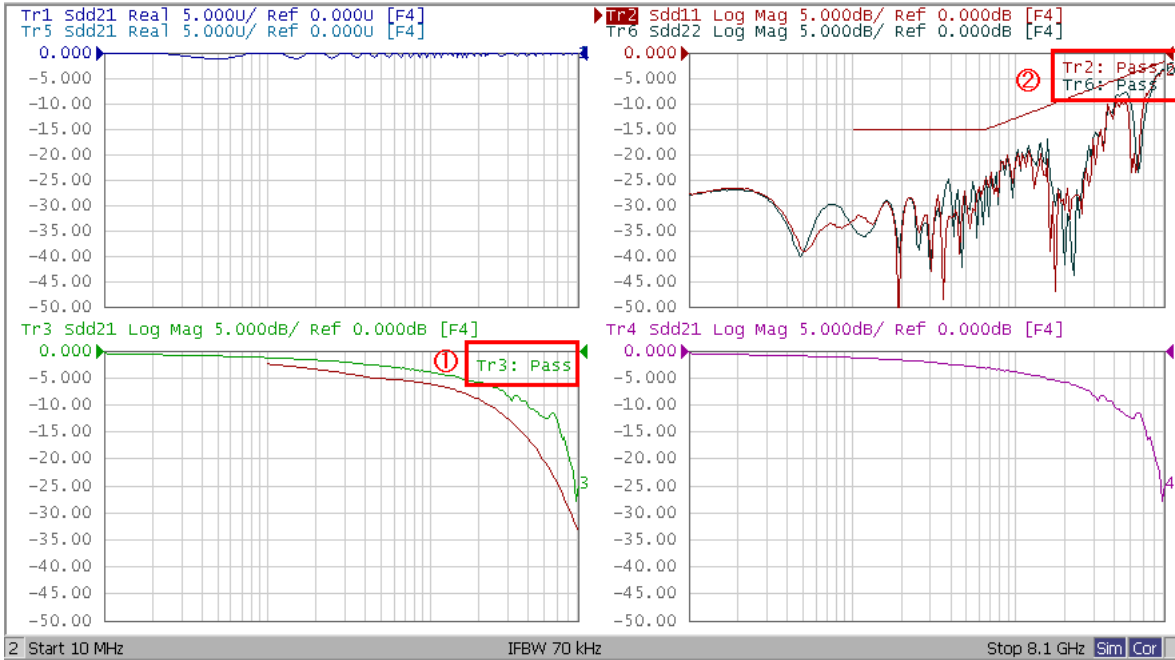

Figure 5-4: Frequency Domain Measurement Example

5.5.4. Return Loss

5.5.4.1. Load Limit File

Refer to 5.5.1.1.

Table 5-5 Return Loss Limit Line File for Trace 2 and Trace 6 in Channel 2

Bit Rate	Cable Category	Connector Type	File Name
HBR	All	All	DP_HBR_ReturnLoss.CSV
RBR	All	All	DP_RBR_ReturnLoss.CSV

5.5.4.2. Cable Connection

Refer to 5.5.1.2.

Keysight MOI for DisplayPort Cable & Connector Compliance Tests

5.5.4.3. Data Analysis

Read Pass/Fail signs on Trace 3. (item 2 in Figure 5-4).

5.5.5. Inter- pair Skew

Measurement

1. Connect the test fixture to the test cables according to Table 5-3. Unused test ports should be terminated.
2. Connect Display Port cable to the test fixture.
3. Press **Channel Next** key to select Channel 1.
4. Press **Channel Max** key to enlarge Channel 1.
5. Click **Stop Single** for Time Domain measurement.
6. Read the propagation delay (item 3 in Figure 5-3), and write it down.
7. Repeat step 1 to step 6 for every channel.

5.5.5.1. Data Analysis

Find the maximum and minimum value among the measured propagation delay. Then, Inter-pair Skew = Absolute (maximum value – minimum value)

Inter-pair Skew Upper Limit for High Bit Rate Cable Assembly

Types	Limit
Cable Assembly	delta time <= 2 UI, then Pass. Otherwise Fail.
Resizing Adaptor	delta time <= 0.2 UI, then Pass. Otherwise Fail.
Extension Cable	delta time <= 1 UI, then Pass. Otherwise Fail.

Inter-pair Skew Upper Limit for Reduced Bit Rate Cable Assembly

Types	Limit
All	delta time <= 2 UI, then Pass. Otherwise Fail.

Keysight MOI for DisplayPort Cable & Connector Compliance Tests

Note: UI (Unit Interval) is the reciprocal of the bit rate. At 5.4 Gbps, the UI = 185 ps. At 2.7 Gbps, the UI = 370.4 ps. At 1.62 Gbps, the UI = 617 ps.

5.5.6. Near End Noise (NEN)

5.5.6.1. Load Limit File

Refer to 5.5.1.1.

Table 5-6 Near End Noise Limit File for Trace 4 in Channel 2

Bit Rate	Cable Category	Connector Type	File Name
HBR	All	All	DP_HBR_NearEndNoise.CSV
RBR	All	All	DP_RBR_NearEndNoise.CSV

5.5.6.2. Measurement

1. Connect the test fixture to the test port cables according to Table 5-7. Unused test ports should be terminated.

Table 5-7: Near End Noise Connection

ENA Port Number	Port1	Port2	Port3	Port4
Fixture PIN Number	A ML0+	A ML0-	A AUX+	A AUX-
	A ML1+	A ML1-	A AUX+	A AUX-
	A ML2+	A ML2-	A AUX+	A AUX-
	A ML3+	A ML3-	A AUX+	A AUX-
	B AUX+	B AUX-	B ML0+	B ML0-
	B AUX+	B AUX-	B ML1+	B ML1-
	B AUX+	B AUX-	B ML2+	B ML2-
	B AUX+	B AUX-	B ML3+	B ML3-

A: Source Side, B: Sink Side

2. Connect Display Port cable to the test fixture.

Keysight MOI for DisplayPort Cable & Connector Compliance Tests

3. Press **Channel Next** key to select Channel 2.
4. Press **Channel Max** key to enlarge Channel 2.
5. Press **Trigger > Single** for Frequency Domain measurement.

5.5.6.3. Data Analysis

Read Pass/Fail sign on Trace 4 (item 1 in Figure 5-5).

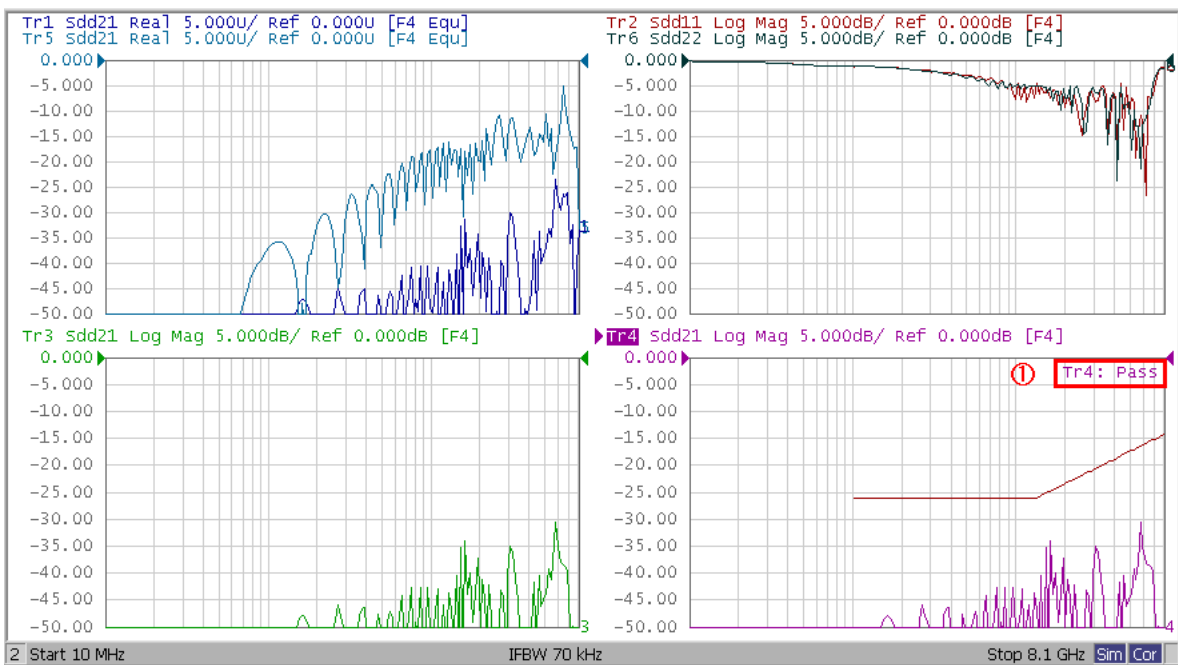

Figure 5-5: Near End Noise Measurement Example.

5.5.7. Far End Noise (FEN)

The Power Sum Equal Level Far-End Noise (PSELFEN) represents the difference between cable insertion loss and the total power sum far end noise from aggressor cable lanes. Prior to measuring the far-end noise between the victim and aggressor channels, the insertion loss of the victim channel must be measured on Trace 3, and saved to the trace memory.

Keysight MOI for DisplayPort Cable & Connector Compliance Tests

$$PSFEN(f) = 10 \times \log \sum_1^n 10^{\left(\frac{FENn(f)}{10}\right)}$$

$$PSELFEN(f) = PSFEN(f) - IL(f)$$

Where:

$FENn(f)$ is the far-end noise in dB

$IL(f)$ is the victim lane insertion loss in dB

Since the number of aggressor channels depends on the victim channel, use an appropriate trace for each test according to the Table 5-8. For test number 2 to 4 (dual aggressor test), the crosstalk measurements need to be performed separately on each combination of victim-aggressor, and combine the results to calculate Far End Noise. For instance, to obtain Far End Noise for test 3, measure Sdd21 between Main Link(0) and Main Link(1) crosstalk, then measure Sdd21 between Main Link(2) and Main Link(1).

Table 5-8 Victims and Aggressors

Test #	Aggressor(s) Channel(s) (Source Side)	Victim Channel (Sink Side)	Trace#
1	Main Link(2)	Main Link(3)	1
2	Main Link(1) + Main Link(3)	Main Link(2)	5
3	Main Link(0) + Main Link(2)	Main Link(1)	5
4	Main Link(1) + AUX Ch.	Main Link(0)	5
5	Main Link(0)	AUX Ch.	1

5.5.7.1. Load Limit File

Refer to 5.5.1.1.

Table 5-9 Far End Noise Limit Line File for Trace 1 and Trace 5 in Channel 2

Bit Rate	Cable Category	Connector Type	File Name
HBR	All	All	DP_HBR_FarEndNoise.CSV
RBR	All	All	DP_RBR_FarEndNoise.CSV

Keysight MOI for DisplayPort Cable & Connector Compliance Tests

5.5.7.2. Insertion Loss Measurement of Victim channel

1. Connect the test cables to the victim channel according to Table 5-10. Unused test ports should be terminated.
2. Select trace 3.
3. Press **Trigger** > **Single**.
4. Press **Display** > **Data -> Mem**.

Table 5-10 Insertion Loss Connection of Victim Channel

ENA Port Number	Test#	Port1	Port2	Port3	Port4
Fixture PIN Number	1	A ML3+	A ML3-	B ML3+	B ML3-
	2	A ML2+	A ML2-	B ML2+	B ML2-
	3	A ML1+	A ML1-	B ML1+	B ML1-
	4	A ML0+	A ML0-	B ML0+	B ML0-
	5	A AUX+	A AUX-	B AUX+	B AUX-

5.5.7.3. Measurement Setup for Single-Aggressor

1. Connect the test fixture to the test port cables according to Table 5-11. Unused test ports should be terminated.

Table 5-11 Far End Noise Connection for Single Aggressor

ENA Port Number	Test#	Port1	Port2	Port3	Port4
Fixture PIN Number	1	A ML2+	A ML2-	B ML3+	B ML3-
	5	A ML0+	A ML0-	B AUX+	B AUX-

A: Source Side, B: Sink Side

2. Select trace 1.
3. Press **Trigger** > **Single**.
4. Press **Display** > **Equation** to turn it **ON**.

Keysight MOI for DisplayPort Cable & Connector Compliance Tests

5.5.7.4. Measurement Setup for Dual-Aggressor

1. Connect the test fixture to the test port cables according to Table 5-12. Unused test ports should be terminated.

Table 5-12 Far End Noise Connection for Dual Aggressor 1

ENA Port Number	Test#	Port1	Port2	Port3	Port4
Fixture PIN Number	2	A ML1+	A ML1-	B ML2+	B ML2-
	3	A ML0+	A ML0-	B ML1+	B ML1-
	4	A ML1+	A ML1-	B ML0+	B ML0-

A: Source Side, B: Sink Side

5. Select trace 5.
6. Press **Display** > **Equation** to turn it **OFF**.
7. Press **Trigger** > **Single**.
8. Press **Display** > **Data -> Mem**.
9. Connect the test fixture to the test port cables according to Table 5-13. Unused test ports should be terminated.

Table 5-13 Far End Noise Connection for Dual Aggressor 2

ENA Port Number	Test#	Port1	Port2	Port3	Port4
Fixture PIN Number	2	A ML3+	A ML3-	B ML2+	B ML2-
	3	A ML2+	A ML2-	B ML1+	B ML1-
	4	A AUX+	A AUX-	B ML0+	B ML0-

A: Source Side, B: Sink Side

10. Press **Trigger** > **Single**.
11. Press **Display** > **Equation** to turn it **ON**.

5.5.7.5. Data Analysis

For Single Aggressor, read Pass/Fail signs on Trace 1.

For Dual Aggressor, read Pass/Fail signs on Trace 5.

Keysight MOI for DisplayPort Cable & Connector Compliance Tests

Note: Once you finish the measurement, switch the Display Port cable end and repeat the same measurement for the opposite direction.

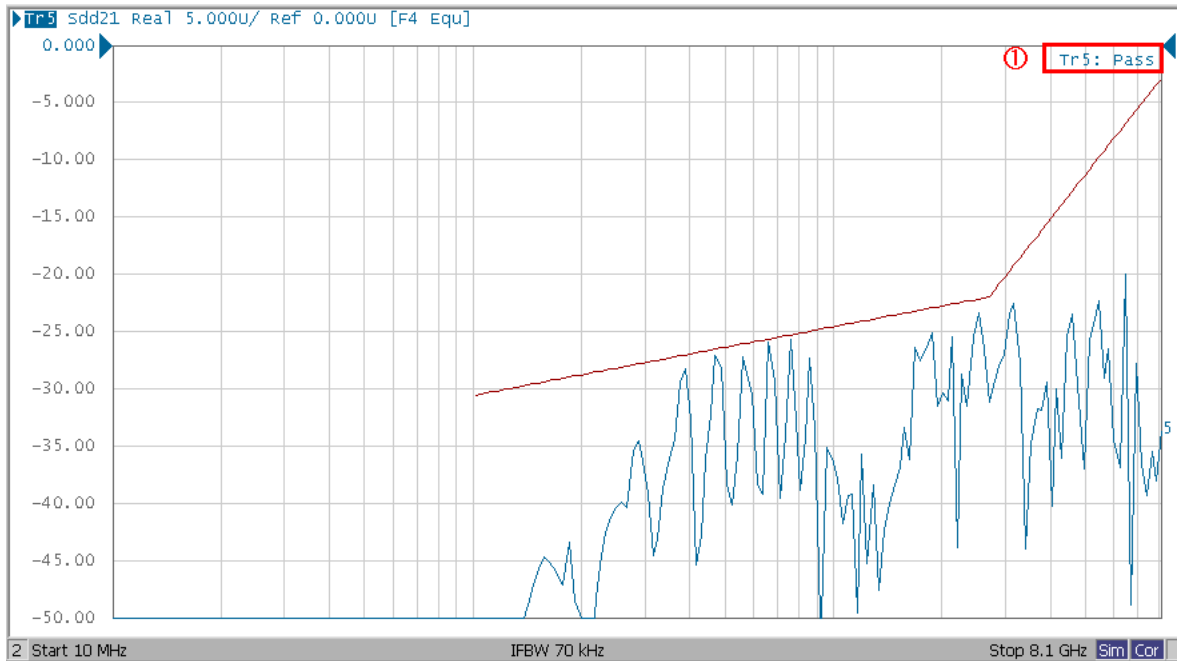

Figure 5-6: Far End Noise Measurement Example.

6. Appendix

6.1. Defining a calibration Kit

To change the definition of a calibration kit, follow the procedure below.

1. Press **Cal** key.
2. Click **Cal Kit > User**
3. Click **Modify Kit > Label Kit [User]**, then type in a name you want.
4. Click **Define STDs >**

- a) **1.No Name >**

Label : "Thru"

1. **STD Type :** Delay/Thru
2. **Offset Delay :** Value defined by the fixture
3. **Offset Z0 :** Value defined by the fixture
4. **Offset Loss :** Value defined by the fixture
5. **Min. Frequency :** Value defined by the fixture
6. **Max. Frequency :** Value defined by the fixture
7. **Return**

- b) **2. No Name >**

1. **Label :** "Short"
2. **STD Type :** Short
3. **Offset Delay :** Value defined by the fixture
4. **Offset Z0 :** Value defined by the fixture
5. **Offset Loss :** Value defined by the fixture
6. **Min. Frequency :** Value defined by the fixture
7. **Max. Frequency :** Value defined by the fixture
8. **Return**

- c) **3. No Name >**

1. **Label :** "Open"
2. **STD Type :** Open

Keysight MOI for DisplayPort Cable & Connector Compliance Tests

3. **Offset Delay** : Value defined by the fixture
 4. **Offset Z0** : Value defined by the fixture
 5. **Offset Loss** : Value defined by the fixture
 6. **Min. Frequency** : Value defined by the fixture
 7. **Max. Frequency** : Value defined by the fixture
 8. **Return**
- d) **4. No Name** >
1. **Label** : "Load"
 2. **STD Type** : Load
 3. **Offset Delay** : Value defined by the fixture
 4. **Offset Z0** : Value defined by the fixture
 5. **Offset Loss** : Value defined by the fixture
 6. **Min. Frequency** : Value defined by the fixture
 7. **Max. Frequency** : Value defined by the fixture
 8. **Return**
- e) **5. No Name** >
1. **Label** : "Line1"
 2. **STD Type** : Delay/Thru
 3. **Offset Delay** : Value defined by the fixture
 4. **Offset Z0** : Value defined by the fixture
 5. **Offset Loss** : Value defined by the fixture
 6. **Min. Frequency** : Value defined by the fixture
 7. **Max. Frequency** : Value defined by the fixture
 8. **Return**
- f) **6. No Name** >
1. **Label** : "Line2"
 2. **STD Type** : Delay/Thru
 3. **Offset Delay** : Value defined by the fixture

Keysight MOI for DisplayPort Cable & Connector Compliance Tests

4. **Offset Z0** : Value defined by the fixture
 5. **Offset Loss** : Value defined by the fixture
 6. **Min. Frequency** : Value defined by the fixture
 7. **Max. Frequency** : Value defined by the fixture
 8. **Return**
- g) **7. No Name** >
1. **Label** : "Line3"
 2. **STD Type** : Delay/Thru
 3. **Offset Delay** : Value defined by the fixture
 4. **Offset Z0** : Value defined by the fixture
 5. **Offset Loss** : Value defined by the fixture
 6. **Min. Frequency** : Value defined by the fixture
 7. **Max. Frequency** : Value defined by the fixture
 8. **Return**
5. Click **Return**.
6. Click **Specify CLSs** >
- h) **Sub Class 1** >
1. **TRL Thru** > **Set All** > **Thru** > **Return**
 2. **TRL Reflect** > **Short** or **Open**
 3. **TRL Line/Match** > **Set All** > **Line1** > **Return**
- i) **Sub Class 2** >
4. **TRL Line/Match** > **Set All** > **Line2** > **Return**
- j) **Sub Class 3** >
5. **TRL Line/Match** > **Set All** > **Line3** > **Return**
7. Click **Return**
8. Click **Export Cal Kit...** to open the dialog box and Save user Calkit.
9. Specify a folder, enter a file name, and click **Save**.

Note: Refer to "Modifying Calibration Kit Definition" in ENA online help for the detail.

6.2. Manual Setup for Time Domain Measurement

6.2.1. Starting Setup

1. If TDR setup wizard was appeared, click **Close** button in the TDR setup wizard.
2. Open **Setup** tab (item 1).
3. Click **Preset** (item 2) under Basic to preset the E5071C.
4. A dialog box appears requesting for confirmation. Then click **OK**.
5. Set **DUT Topology** (item 3) to “Differential 2-port”.
6. Click **Advanced Mode** (item 4).

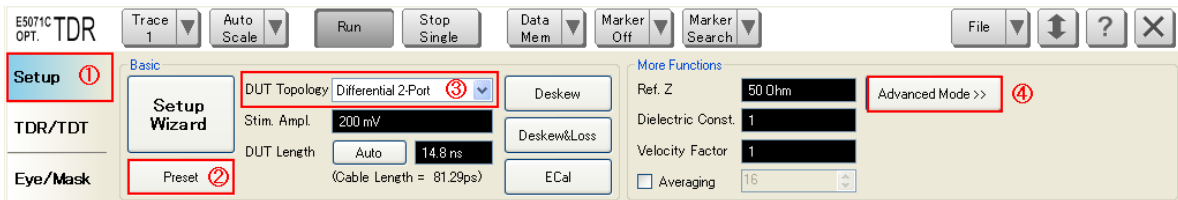

7. A dialog box appears requesting for confirmation. Then click **Yes**. (Clear the check box for “Use Advanced Calibration Methods”)

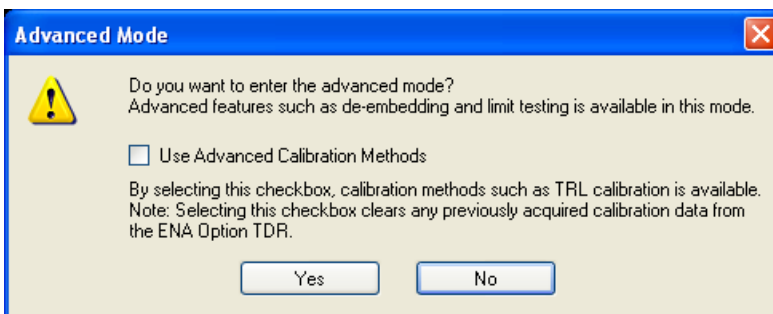

6.2.2. Bulk Cable and Connector Impedance Measurements (Normative)

6.2.2.1. Measurement Setup

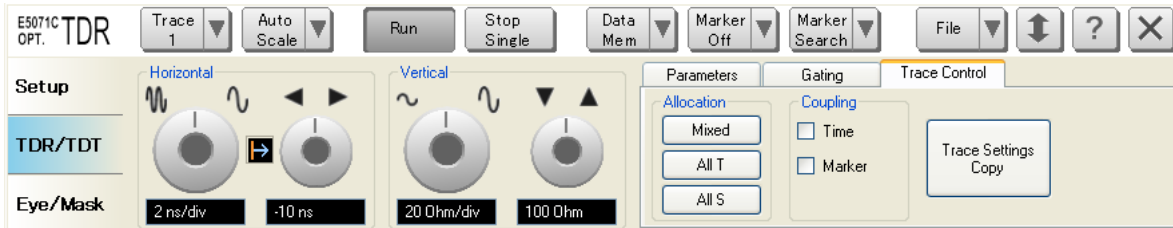

1. Click **Stop Single**.
2. Open **TDR/TDT** tab.
3. Click **Trace Control** tab.
4. Clear **Time** and **Marker** check box under Coupling.
5. Open **Parameters** tab.
6. Select **Trace 1**.
7. Select **Rise Time** to 20-80 % and input value to 130 psec.
8. Click the box below the left knob under Horizontal. Then Entry dialog box appear.
9. Input horizontal scale to 150 ps/div.
10. Click the box below the right knob under Horizontal. Then Entry dialog box appear.
11. Input horizontal position to -360 ps.
12. Click the box below the left knob under Vertical. Then Entry dialog box appear.
13. Input vertical scale to 5 ohm/div.
14. Click the box below the right knob under Vertical. Then Entry dialog box appear.
15. Input vertical position to 75 ohm.
16. Open **Trace Control** tab.
17. Click **Trace Settings Copy**.
18. Trace Settings Copy dialog box appears.
19. Select the **Trace 1** in the From list.
20. Select the **Trace 5** in the To list.
21. Click **Copy**.

Keysight MOI for DisplayPort Cable & Connector Compliance Tests

22. Click **Close**.
23. Select **Trace 5**.
24. Open **Parameters** tab.
25. Click **Tdd22**.

6.2.3. Intra-Pair Skew Measurement (Normative)

6.2.3.1. Measurement Setup

1. Select **Trace 2**.
2. Open **Parameters** tab.
3. Select **Measure** to Time Domain and Single-Ended (item 1).

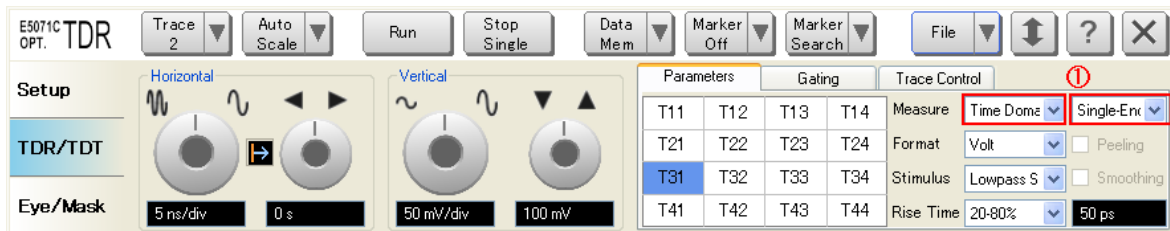

4. Select **Format** to Volt.
5. Click **T31**.
6. Select **Rise Time** to 10-90 % and input value to 50 psec.
7. Click the box below the left knob under Horizontal. Then Entry dialog box appear.
8. Input horizontal scale to 5 ns/div.
9. Click the box below the right knob under Horizontal. Then Entry dialog box appear.
10. Input horizontal position to 0 ns.
11. Click the box below the left knob under Vertical. Then Entry dialog box appear.
12. Input vertical scale to 50 mV/div.
13. Click the box below the right knob under Vertical. Then Entry dialog box appear.
14. Input vertical position to 100 mV.
15. Open **Trace Control** tab.
16. Click **Trace Settings Copy**.
17. Trace Settings Copy dialog box appears.

Keysight MOI for DisplayPort Cable & Connector Compliance Tests

18. Select the **Trace 2** in the From list.
19. Select the **Trace 6** in the To list.
20. Click **Copy**.
21. Click **Close**.
22. Select **Trace 6**.
23. Open **Parameters** tab.
24. Click **T42**.
25. Select **Trace 2**.
26. Click **Marker Search** and select **Δ Time**.
27. Delta Time dialog box appear.
28. Check the **Δ Time** check box.
29. Select **Target (Stop)** to Trace 6 (T42).
30. Input **Position (%)** to 15.
31. Click **OK**.

6.2.3.2. Crosstalk Compensation

1. Select **Trace 2**.
2. Press **Display** > **Equation Editor...** > Enter an equation "**Intra+= S31-S32**".
3. Check **Equation Enabled** check box.
4. Click **Apply**.
5. Click **Close**.
6. Select **Trace 6**.
7. Press **Display** > **Equation Editor...** > Enter an equation "**Intra-= S42-S41**".
8. Check **Equation Enabled** check box.
9. Click **Apply**.
10. Click **Close**.

Keysight MOI for DisplayPort Cable & Connector Compliance Tests



6.2.4. Inter-pair Skew Measurements (Normative)

6.2.4.1. Measurement Setup

1. Select **Trace 3**.
2. Open **Parameters** tab.
3. Select **Rise Time** to 10-90 % and input value to 50 psec.
4. Click the box below the left knob under Horizontal. Then Entry dialog box appear.
5. Input horizontal scale to 5 ns/div.
6. Click the box below the right knob under Horizontal. Then Entry dialog box appear.
7. Input horizontal position to 0 s.
8. Click the box below the left knob under Vertical. Then Entry dialog box appear.
9. Input vertical scale to 100 mV/div.
10. Click the below the right knob under vertical. Then Entry dialog box appear.
11. Input vertical scale to 200 mV.
12. Press **Marker Search** > **Target** > Target Value and enter “60 mUnits”.
13. Click **Return**.
14. Click **Tracking** to turn it on.
15. Select **Trace 4**.
16. Click **Data Mem** and select **OFF**.
17. Repeat step15 to step16 for **Trace 7** and **Trace 8**.

6.3. Manual Setup for Frequency Domain Measurement

6.3.1. Channel and Trace Settings

1. Press **Display**.
2. Click **Allocate Channels** > .
3. Press **Channel Next**.
4. Click **Num of Traces** > **6**.
5. Click **Allocate Traces** > .

Keysight MOI for DisplayPort Cable & Connector Compliance Tests

6.3.2. Common Settings

1. Press **Sweep Setup** > **Sweep Type** > **Log Freq.**
2. Set **Points** to 201.
3. Press **Start** > Set start value to 10 MHz.
4. Press **Stop** > Set stop value to 8.1 GHz.
5. Press **Avg** > Set **IF Bandwidth** to 70 kHz.
6. Press **Analysis** > **Fixture Simulator** > **Fixture Simulator** and turn it **ON**.
7. Click **Topology** > **Device** > **Bal-Bal**.
8. Click **Port 1 (bal)** > **1-2**.
9. Click **Port 2 (bal)** > **3-4**.
10. Click **Return**.

6.3.3. Far End Noise (FEN) Measurement (Normative)

1. Select Trace 1.
2. Press **Analysis**.
3. Click **Fixture Simulator** > **BalUn** and turn it **ON**.
4. Click **Measurement** > **Sdd21**.
5. Press **Format** > **Real**.
6. Press **Scale** > Set **Divisions** to 10.
7. Set **Scale/Div** to 5 dB/div.
8. Set **Reference position** to 10 Div.
9. Set **Reference Value** to 0 dB.
10. Press **Display** > **Equation Editor...** > Enter an equation
“Single Aggressor=20*log10(mag(data))-20*log10(mag(mem(3)))”
11. Select Trace 5.
12. Repeat from step 2 to step 9.
13. Press **Display** > **Equation Editor...** > Enter an equation
“DualAggressor=10*log10(mag(data)^2+mag(mem)^2)-20*log10(mag(mem(3)))”

Keysight MOI for DisplayPort Cable & Connector Compliance Tests

6.3.4. Return Loss Measurement (Normative)

1. Select Trace 2.
2. Press **Analysis**.
3. Click **Fixture Simulator** > **BalUn** and turn it **ON**.
4. Click **Measurement** > **Sdd11**.
5. Press **Scale** > Set **Divisions** to 10.
6. Set **Scale/Div** to 5 dB/div.
7. Set **Reference position** to 10 Div.
8. Set **Reference Value** to 0 dB.
9. Select Trace 6.
10. Press **Analysis**.
11. Click **Fixture Simulator** > **BalUn** and turn it **ON**.
12. Click **Measurement** > **Sdd22**.
13. Repeat from step 5 to step 8.

6.3.5. Insertion Loss Measurement (Normative)

1. Select Trace 3.
2. Press **Analysis**.
3. Click **Fixture Simulator** > **BalUn** and turn it **ON**.
4. Click **Measurement** > **Sdd21**.
5. Press **Scale** > Set **Divisions** to 10.
6. Set **Scale/Div** to 5 dB/div.
7. Set **Reference position** to 10 Div.
8. Set **Reference Value** to 0 dB.

6.3.6. Near End Noise (NEN) Measurement

1. Select Trace 4.

Keysight MOI for DisplayPort Cable & Connector Compliance Tests

2. Press **Analysis**.
3. Click **Fixture Simulator > BalUn** and turn it **ON**.
4. Click **Measurement > Sdd21**.
5. Press **Scale > Set Divisions** to 10.
6. Set **Scale/Div** to 5 dB/div.
7. Set **Reference position** to 10 Div.
8. Set **Reference Value** to 0 dB.

6.4. Limit Test Settings

6.4.1. Displaying Judgment Result of Test

If a channel has a judgment result of fail, the fail message appears on the screen. It will be judged as failed if one or more unsatisfactory trace exists within the channel.

Follow the procedure below.

1. Press **Analysis > Limit Test > Fail Sign** to switch the fail sign ON/OFF.

6.4.2. Setting the Warning Beeper

Beep sound that occurs when the judgment result is fail.

Follow the procedure below.

1. Press **System > Misc Setup > Beeper > Beep Warning** to switch the warning beeper ON/OFF.

6.4.3. Defining the Limit Line

Set limit lines to perform pass/fail tests on the following measurement items.

1. Bulk Cable and Connector Impedance (Trace 1, 5 in Channel 1)
2. Insertion Loss (Trace 3 in Channel 2)
3. Return Loss (Trace 2, 6 in Channel 2)
4. Near End Noise (Trace 4 in Channel 2)
5. Far End Noise (Trace 1, 5 in Channel 2)

Keysight MOI for DisplayPort Cable & Connector Compliance Tests

1. Press **Channel Next** key and **Trace Next** key to activate the trace on which limit lines should be set.
2. Press **Analysis > Limit Test > Edit Limit Line** to display the limit table shown below (Initially, no segments are entered in the limit table). Using the limit table, create/edit a segment.

	Type	Begin Stimulus	End Stimulus	Begin Response	End Response
1	MAX	0 s	600 ps	105 u	105 u
2	MIN	0 s	600 ps	75 u	75 u
3	▼				

3. Enter the limit line data following the tables below.
4. Click **Return**.
5. Click **Limit Line** and turn it **ON**.
6. Click **Limit Test** and turn it **ON**.
7. Repeat 1 to 6 for each Measurement items.

6.5. Calculating formula for Limit Line

6.5.1. Bulk Cable and Connector Impedance

6.5.1.1. Impedance Profile

Impedance Profile Through Full-size DisplayPort Connector

Segment	Differential Impedance Value	Maximum Tolerance	Comment
Fixture	100 ohm	+-10 %	Fixture should have trace lengths of no more than 50 mm (2-inches)

Keysight MOI for DisplayPort Cable & Connector Compliance Tests

Connector	100 ohm	+/-10 %	
Wire management	100 ohm	+/-10%	Transition from +/-10% to +/- 5% must have a slope of 5 ohm/80ps
Cable	100 ohm	+/-5 %	

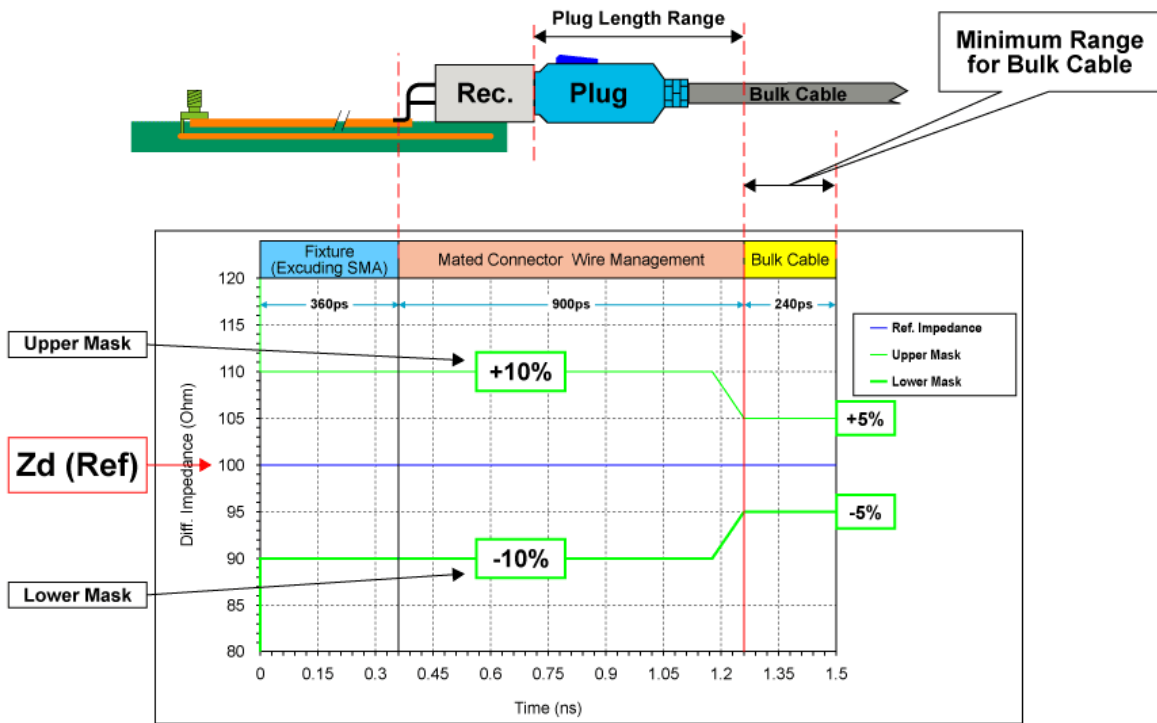

Impedance Profile Measurement Impedance Limits & Connector Profile Example

Impedance Profile Through Mini DisplayPort Connector

Segment	Differential Impedance Value	Maximum Tolerance	Comment
Fixture	100 ohm	+/- 10 %	Fixture should have trace lengths of no more than 50 mm (2-inches)
Connector	100 ohm	+/- 15 %	Transition from +/-15% to +/-10% and transition from +/-10% to +/-5% shall have a slope of 10ohm/200ps
Wire Management	100 ohm	+/-10 %	
Cable	100 ohm	+/-5 %	

Keysight MOI for DisplayPort Cable & Connector Compliance Tests

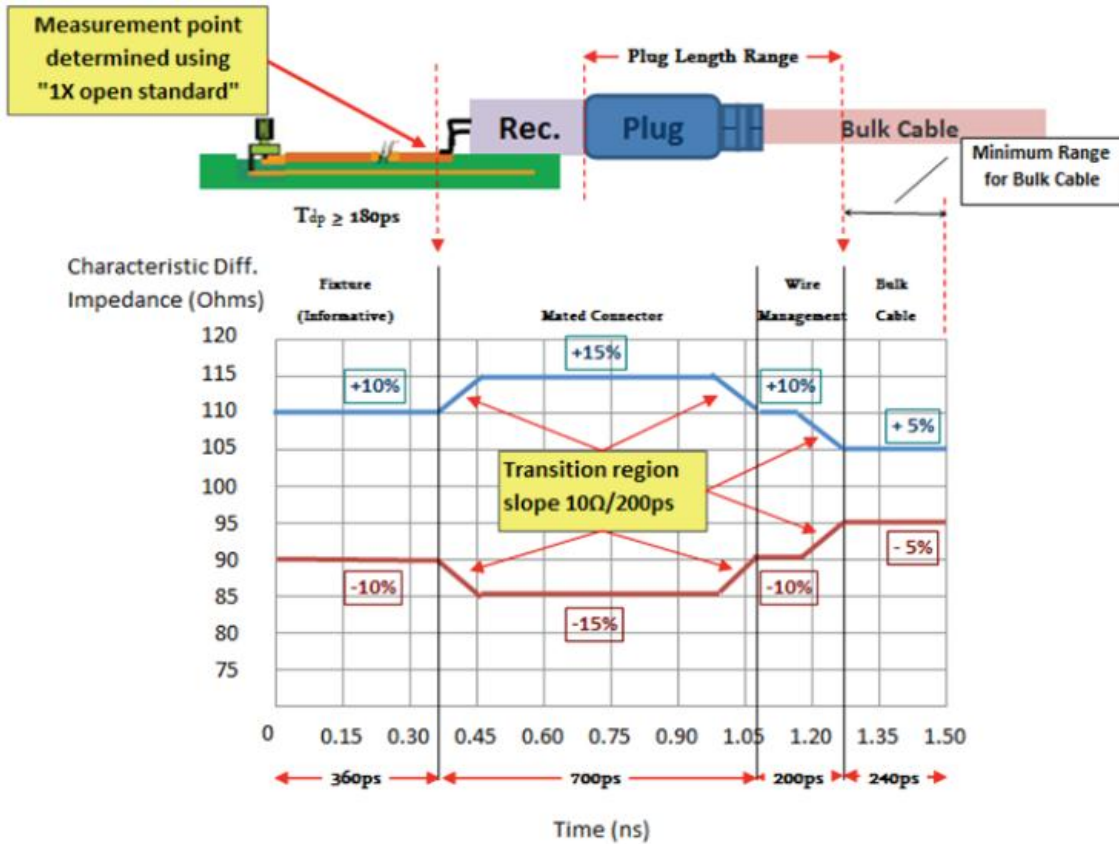

6.5.2. Insertion Loss

Insertion Loss Lower Limit for High Bit Rate Cable Assembly

$$IL_{min}[dB] = \begin{cases} -8.7 \times \sqrt{\frac{f}{f_0}} - 0.072; & 0.1 < f \leq \frac{f_0}{3} \\ 5.68\sqrt{f} - 5.3 * f - 6.52; & \frac{f_0}{3} < f \leq 8.1 \end{cases}$$

Where:

f is given in GHz

$f_0 = 1.35GHz$

Insertion Loss Lower Limit for High Bit Rate Resizing Adaptors

Keysight MOI for DisplayPort Cable & Connector Compliance Tests

$$IL_{\min.}[dB] = \begin{cases} -1.6 \times \sqrt{\frac{f}{f_0}}; & 0.1 < f \leq \frac{f_0}{3} \\ 1.75\sqrt{f} - 1.65 * f - 1.31; & \frac{f_0}{3} < f \leq 8.1 \end{cases}$$

Where:

f is given in GHz

$f_0 = 1.35\text{GHz}$

Insertion Loss Lower Limit for Extension Cable

$$IL_{\min.}[dB] = \begin{cases} -5.22 \times \sqrt{\frac{f}{f_0}} - 0.043; & 0.1 < f \leq \frac{f_0}{3} \\ 3.41\sqrt{f} - 3.18 * f - 3.91; & \frac{f_0}{3} < f \leq 8.1 \end{cases}$$

Where:

f is given in GHz

$f_0 = 1.35\text{GHz}$

Insertion Loss Lower Limit for Reduced Bit Rate Cable Assembly

$$IL_{\min.}[dB] = \begin{cases} -1 - 13.5 \times \sqrt{\frac{f}{f_0}} & ; 0.01 < f \leq \frac{f_0}{3} \\ -2.1 - [12(f - \frac{f_0}{3}) + 6.8] & ; \frac{f_0}{3} < f \leq 4 \end{cases}$$

Where:

f is given in GHz

$f_0 = 0.825\text{GHz}$

6.5.3. Return Loss

Return Loss Upper Limit for High Bit Rate Cable Assembly/Adaptor (full-size DP)

Keysight MOI for DisplayPort Cable & Connector Compliance Tests

connector)

$$RL_{\max.} [dB] = \begin{cases} -15; & 0.1 < f \leq \frac{f_0}{2} \\ -15 + 12.3 \operatorname{Log}_{10} \left(\frac{2f}{f_0} \right); & \frac{f_0}{2} < f \leq 8.1 \end{cases}$$

Where:

f is given in GHz

$$f_0 = 1.35 \text{GHz}$$

**Return Loss Upper Limit for High Bit Rate Cable Assembly/Adaptor/Extension Cable
(mini DP connector)**

$$RL_{\max.} [dB] = \begin{cases} -15; & 0.1 < f \leq \frac{f_0}{2} \\ -15 + 12.3 \operatorname{Log}_{10} \left(\frac{2f}{f_0} \right); & \frac{f_0}{2} < f \leq 8.1 \end{cases}$$

Where:

f is given in GHz

$$f_0 = 1.35 \text{GHz}$$

Return Loss Upper Limit Reduced Bit Rate Cable Assembly

$$RL_{\max.} [dB] = \begin{cases} -15 & ; 0.1 < f \leq \frac{f_0}{2} \\ -15 + 12 \operatorname{Log}_{10} \left(2x \frac{f}{f_0} \right) & ; \frac{f_0}{2} < f \leq 4 \end{cases}$$

Where:

f is given in GHz

$$f_0 = 0.8 \text{GHz}$$

6.5.4. Near End Noise (NEN)

Near End Noise Upper Limit for High Bit Rate Cable Assembly

$$Isolation_{\max}[dB] = \begin{cases} -26 & ; 0.1 < f \leq f_0 \\ -26 + 15 \text{Log}_{10}\left(\frac{f}{f_0}\right) & ; f_0 < f \leq 8.1 \end{cases}$$

Where:

f is given in GHz

$f_0 = 1.35 \text{GHz}$

Near End Noise Upper Limit for Reduced Bit Rate Cable Assembly

$$Isolation_{\max}[dB] = \begin{cases} -26 & ; 0.1 < f \leq f_0 \\ -26 + 15 \text{Log}_{10}\left(\frac{f}{f_0}\right) & ; f_0 < f \leq 4 \end{cases}$$

Where:

f is given in GHz

$f_0 = 0.8 \text{GHz}$

6.5.5. Far End Noise (FEN)

The Power Sum Equal Level Far End Noise specification applies to all cable assembly types. The Power Sum Equal Level Far End Noise represents the difference between cable insertion loss and the total power sum far end noise from aggressor cable lanes.

Keysight MOI for DisplayPort Cable & Connector Compliance Tests

$$PSFEN(f) = 10 \times \log \sum_1^n 10^{\left(\frac{FENn(f)}{10}\right)}$$

$$PSELFEN(f) = PSFEN(f) - IL(f)$$

Where:

$FENn(f)$ is the far-end noise in dB

$IL(f)$ is the victim lane insertion loss in dB

Far End Noise Upper Limit for High Bit Rate Cable Assembly

$$PSELFEN_{max}[dB] = \begin{cases} -22 + 6 \text{Log}_{10}\left(\frac{f}{f_0}\right); & 0.1 < f \leq f_0 \\ -22 + 40 \text{Log}_{10}\left(\frac{f}{f_0}\right); & f_0 < f \leq 8.1 \end{cases}$$

Where:

f is given in GHz

$f_0 = 2.7 \text{GHz}$

Far End Noise Upper Limit for Reduced Bit Rate Cable Assembly

$$PSELFEN_{max}[dB] = -26$$