

Keysight Technologies

Testing Amplifiers and Active Devices with the 8510C Network Analyzer

Technical Overview

Discontinued Product Information – For Support Reference Only –
Information herein, may refer to products/services no longer supported. We regret
any inconvenience caused by obsolete information. For the latest information on
Keysight's test and measurement products go to: www.keysight.com/find/products

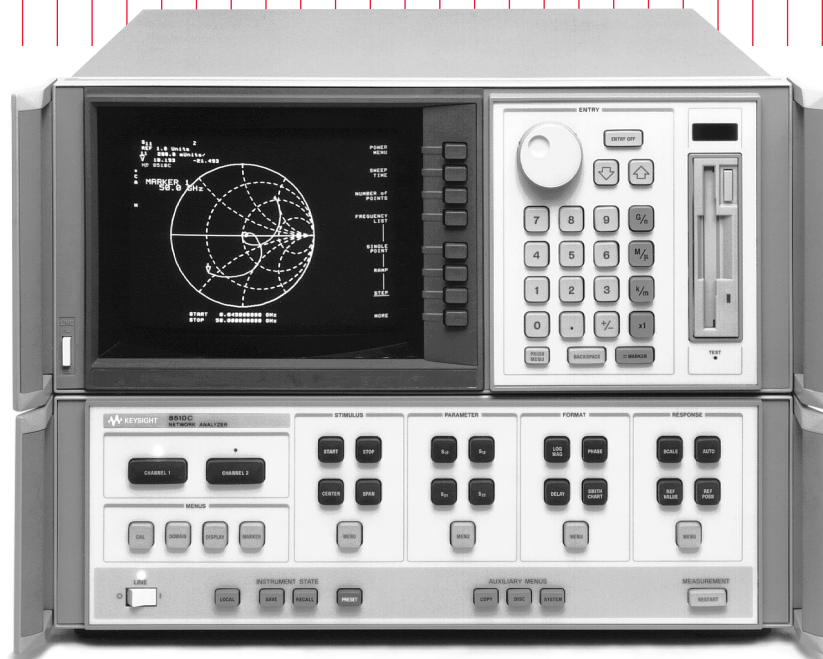

Table of Contents

Introduction	3
Amplifier Parameters	4
Measurement Setup	5
Linear Measurements	7
Power Flatness Correction	11
Nonlinear Measurements	13
Appendix A—High Power Measurements	15
Appendix B—Accuracy Considerations.	17
Appendix C—8360 Series Synthesized Sweepers Maximum Leveled Power (dBm)	19
Appendix D—Optimizing Power Sweep Range.	20

Introduction

The Keysight Technologies, Inc. 8510C microwave network analyzer is an excellent instrument for measuring the transmission and reflection characteristics of many amplifiers and active devices. Scalar parameters such as gain, gain flatness, gain compression, reverse isolation, return loss (SWR), and gain drift versus time can be measured. Additionally, vector parameters such as deviation from linear phase, group delay, and complex impedance can also be measured.

Two new features available with 8510C revision 7.0 firmware, power domain and receiver calibration, allow for absolute power and nonlinear measurements such as gain compression. Since the 8510 is a tuned receiver, it provides high dynamic range, sensitivity and immunity to unwanted spurious responses. Its accuracy-enhancement capabilities reduce systematic errors for more precise characterization of the amplifier or active device under test (AUT).

Keysight 8510C—Capabilities for measuring amplifiers and active devices

- High output power at the test port (-15 dBm at 50 GHz for the 8517B Opt 007 test set) drives high-power devices, eliminating the need for external amplifiers.
- 0.02 dB power resolution provides precise control of the input power to the device.
- Power sweep (8 dB broadband, up to 26 dB narrowband for the 8510C with 8517B Opt 007 test set, 1 dB broadband, up to 23 dB narrowband with the 8515A, and 13 dB broadband, up to 23 dB narrowband with the 8514B) allows for convenient gain compression measurements (in dBm or mW).
- Power meter calibration improves measurement accuracy and when combined with receiver calibration provides new capabilities such as absolute output-power measurements.
- User-defined preset function saves setup

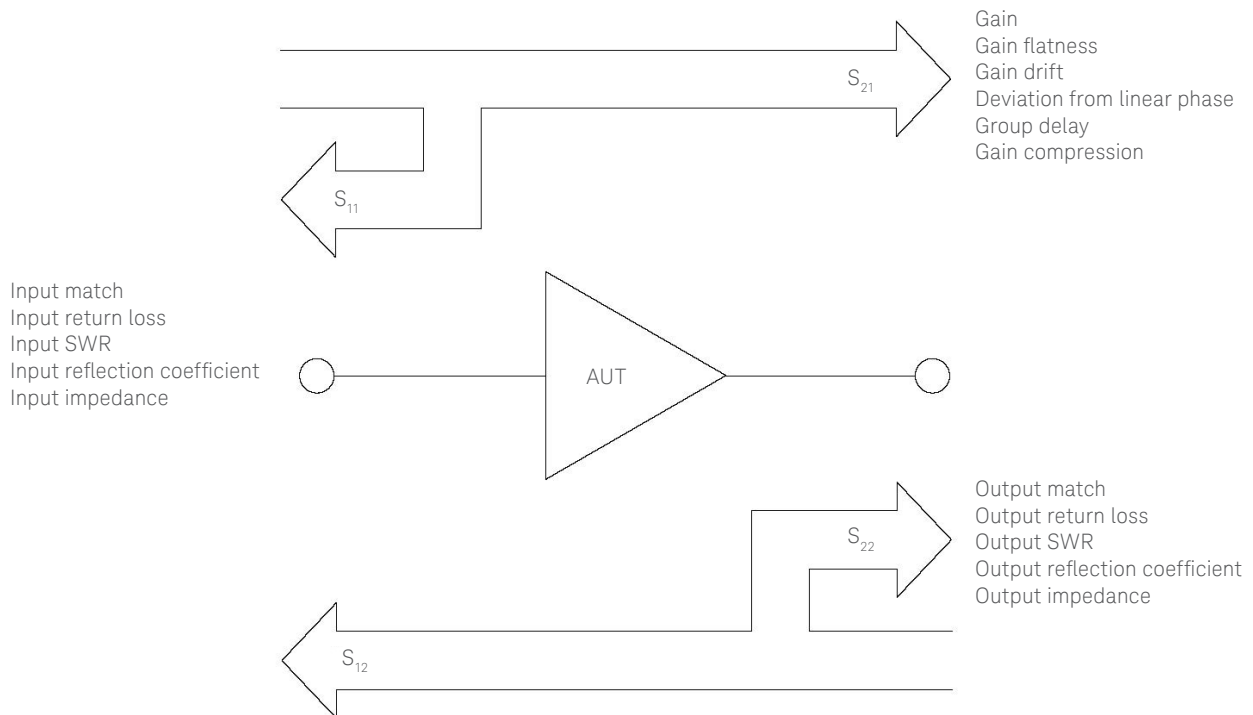

Figure 1. Amplifier parameters

Amplifier Parameters

Parameter	Equation	Definition
Gain	V_{trans}	The ratio of the amplifier's output power (delivered to a Z_0 load) to the input power (delivered from a $t = \text{-----}$ Z_0 source). Z_0 is the characteristic impedance, in this case, 50Ω .
	V_{inc}	
	Gain (dB) = $-20\log_{10} \tau $	For small signal levels, the output power of the amplifier is proportional to the input power. Small signal gain is the gain in this linear region.
	Gain (dB) = $P_{out} \text{ (dBm)} - P_{in} \text{ (dBm)}$	As the input power level increases and the amplifier approaches saturation, the output power reaches a limit and the gain drops. Large signal gain is the gain in this nonlinear region.
Gain flatness		The variation of the gain over the frequency range of the amplifier.
Reverse isolation		The measure of transmission from output to input. Similar to the gain measurement except the signal stimulus is applied to the output of the amplifier.
Deviation from linear phase		The amount of variation from a linear phase shift. Ideally, the phase shift through an amplifier is a linear function of frequency.
Group delay	$tg(\text{sec}) = -\frac{\Delta\theta}{\Delta\omega} = -\frac{1}{360} * \frac{\Delta\theta}{\Delta f}$	The measure of the transit time through the amplifier as a function of frequency. A perfectly linear phase shift would have a constant rate of change with respect to frequency, yielding a constant group delay.
Return loss (SWR, ρ)	$\Gamma = \frac{V_{refl}}{V_{inc}} = \rho \angle \theta$ Reflection coefficient = ρ Return loss (dB) = $-20\log_{10}\rho$ $SWR = \frac{1 + \rho}{1 - \rho}$	The measure of the reflection mismatch at the input or output of the amplifier relative to the system ZO characteristic impedance.
Complex impedance	$Z = \frac{1 + \Gamma}{1 - \Gamma} * Z_0 = R + jX$	The amount of reflected energy from an amplifier is directly related to its impedance. Complex impedance consists of both a resistive and a reactive component. It is derived from the characteristic impedance of the system and the reflection coefficient.
Gain compression		An amplifier has a region of linear gain where the gain is independent of input power level (small signal gain). As the power is increased to a level that causes the amplifier to saturate, the gain decreases. Gain compression is determined by measuring the amplifier's 1 dB gain compression point (P1dB) which is the output power at which the gain drops 1 dB relative to the small signal gain. This is a common measure of an amplifier's power output capability.

Measurement Setup

Before making an actual measurement it is important to know the input and output power levels of the AUT and the type of calibration required.

Setup

1. Select input power levels

Selecting the proper stimulus settings at the various ports of the AUT are of primary concern. If the small signal gain and output power at the 1 dB compression point of the amplifier are approximately known, the proper setting for the input power level can be estimated. For linear operation, the input power to the amplifier should be set such that the output power is approximately 3 to 10 dB below the 1 dB compression level.

$$P_{\text{input}} \text{ (dBm)} = P_{\text{1dB compression}} \text{ (dBm)} - \text{Gain}_{\text{small signal}} \text{ (dB)} - 10 \text{ dB}$$

For the Keysight 8510C, the power may be varied continuously within the “available output power range” indicated in Table 1. If lower power is required to the AUT, an internal step attenuator may be varied from 10 to 90 dB in 10 dB steps. It is advantageous to select a power range that will accommodate the operation of the amplifier in its linear region as well as the nonlinear region.

2. Estimate output power

It is also important to know the output power levels from the AUT to avoid overdriving or damaging the test ports of the network analyzer. External attenuation may be necessary after an AUT with high output power to keep the power level below the specified 0.1 dB compression level of the test set. For more information see Appendix A, “Highpower measurements.”

When measuring high-gain amplifiers, it is possible to overload the test port. Overload occurs when greater than +17 dBm of power is input into either port. When this happens, “IF OVERLOAD” will be displayed. At this point, either more attenuation should be added to the output of the amplifier, or the input power level should be reduced before continuing the measurement.

Table 1. Available output power from network analyzer

RF Source 8510 Test Set	83621A with 8514B	83631A with 8515A	83651A with 8517B	83651A with 8517B, Opt. 007
Frequency (GHz)	Test Port Power Levels (dBm)			
0.05	+2.5 to -20.5	-3.5 to -26	+1.5 to -21.5	+5 to -21
2	+1 to -22.0	-6 to -29	+0.5 to -23.5	+5 to -21
20	-7.5 to -27	-13.5 to -30	-7.5 to -30	+2 to -23
26.5		-25 to -30	-13.5 to -30	+1 to -24
40			-20 to -30	-3 to -21.5
50			-27 to -30	-13 to -29

Table 2. Allowable input power to network analyzer

	8514B at 20 GHz	8515A at 26.5 GHz	8517B at 50 GHz
0.1 dB compression level for test set (at test port) (dBm)	+ 8.5	- 3	- 6
Damage power level at test port (dBm)	+17	+17	+17

3. Power meter calibration (optional)

The 8510C network analyzer provides leveled power at the test set port with a specified variation of less than 2.1 dB at 50 GHz. The power meter calibration feature is available to provide more accurate settable power when required and can also serve to remove the frequency response errors of the cables and adapters between the test set and the AUT. If a power meter calibration is performed it should be done prior to a measurement calibration. Power meter calibration with the 8510C family is compatible with the Keysight 437B and 438A power meters.

4. Measurement calibration

A measurement calibration characterizes and removes the effects of the repeatable variations (or systematic errors) in the test setup. Systematic errors include frequency response tracking, directivity, mismatch, and crosstalk effects. A full twoport calibration provides the greatest measurement accuracy, but in some situations it may be more practical to use other calibration techniques (i.e., a response calibration for transmission-only measurements or a one-port calibration for reflection-only measurements). For more information see Appendix B, "Accuracy considerations."

After a calibration has been performed, "C" appears to the left of the display to indicate that a measurement calibration is on. Any attenuation that is used on the input or output of the AUT should be included in the calibration of the system to remove its effects from the measurement of the AUT.

Operating considerations

If you perform a factory preset ([RECALL] {MORE}{FACTORY PRESET}) the power is set to the maximum leveled value (in the highest power range) of +10 dBm. If the AUT could be damaged by this power level or will be operating in its nonlinear region, it should not be connected until the power is set to a desirable level.

A useful feature for the testing of power-sensitive devices is the user preset feature on the 8510C. This allows the user to specify an instrument setting for a particular measurement and to store it away by pressing [SAVE] {USER PRESET 8}. Later, when the green [USER PRESET] key is pressed, these same conditions are recalled with the power level and/or internal step attenuator set to the appropriate level, preventing potential damage to the AUT.

Measurement examples

The measurement examples described in this note were made on an 8510C network analyzer with an 83651A source and 8517B Opt 007 test set. A full two-port calibration was performed (except where noted) for the greatest accuracy for both transmission and reflection measurements of the two-port device. The amplifier under test is an 8348A amplifier operating over a 2 to 26.5 GHz frequency range. Other sources and test sets may be used, but differences in frequency range and available output power will exist.

Linear Measurements

Measurements in the linear operating region of the amplifier can be made with the 8510C by using the basic setup shown in Figure 2. Care must be taken when setting the input power to the AUT so that it is operating within its linear region.

1. Configure the system as shown in Figure 2. Return the 8510C to a known state of operation.

[RECALL]
[MORE]
[FACTORY PRESET]

2. Choose the appropriate measurement parameters (start/stop frequency, number of points, power, etc). The power level should be set such that the AUT is operating in its linear region. In this measurement example, an estimated input power level of -15 dBm is derived from:

$$\begin{aligned} P_{in} &= P_{1dB} - \text{Gain} - 10 \text{ dB} \\ &= +25 \text{ dBm} - 30 \text{ dB} - 10 \text{ dB} \\ &= -15 \text{ dBm} \end{aligned}$$

[START] [2] [G/n]
[STOP] [26.5] [G/n]
STIMULUS [MENU]
{POWER SOURCE 1} [-15] [x1]

3. Perform a full two-port calibration. If attenuators are used on the output of the amplifier they should be included in the calibration. In this example, a 20 dB fixed attenuator on port 2 prevents the +25 dBm of output power from overdriving the port 2 input of the 8517B. Save the instrument state to one of the internal registers.

[SAVE]
{INST STATE 1}

4. Connect the AUT and apply bias, if necessary.

Small signal gain/gain flatness

Small signal gain is typically measured at a constant input power over a swept frequency range.

1. Set up the 8510C for an S_{21} log magnitude measurement.

[S21] [LOG MAG]

2. Scale the display for optimum viewing and use a marker to measure the small signal gain at a desired frequency.

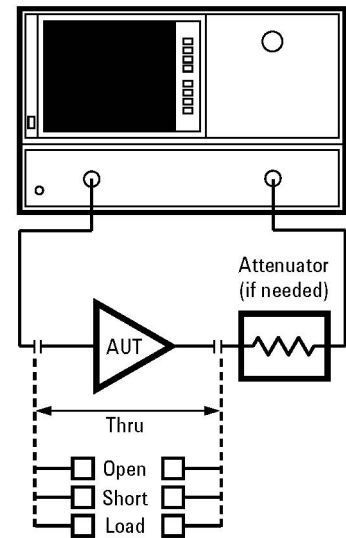

Figure 2. Basic setup for amplifier measurement using the 8510C network analyzer

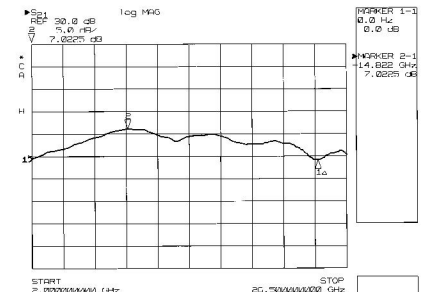

Figure 3. Small signal gain measurement

Linear Measurements (continued)

3. Measure the gain flatness or variation over a frequency range using the following sequence. First, set the appropriate start/stop or center/span frequencies over which the flatness is to be measured. Then perform an appropriate calibration over this frequency range. Then perform the following to see a direct readout of the peak-to-peak difference in the trace.

```
[MARKER]
{MARKER 1}
{MORE} {MARKER TO MINIMUM}
[PRIOR MENU]
{MARKER 2}
{MODE MENU} {REF=1}
{MORE} {MARKER TO MAXIMUM}
```

Reverse isolation

For the measurement of reverse isolation the RF stimulus signal is applied to the output of the AUT by measuring S_{12} . External attenuation placed on the output of the AUT may not be needed for this measurement since the signal path now exhibits loss instead of gain. If it is removed, a new calibration will be required.

1. Recall the full two-port calibration.

```
[RECALL]
{INST STATE 1}
```

2. Set up the Keysight 8510C for an S_{12} log magnitude measurement.

```
[S12] [LOG MAG]
```

If the isolation of the AUT is very high (i.e., displayed trace is in the noise floor) it may be necessary to remove the external attenuation at the output of the AUT and recalibrate (with a response and isolation calibration) at a higher power level and increased averaging.

3. Scale the display for optimum viewing and use a marker to measure the reverse isolation at a desired frequency.

Deviation from linear phase

The measurement of deviation from linear phase of the AUT employs the electrical delay feature of the 8510C network analyzer to remove the linear portion of the phase shift from the measurement.

1. Set up the analyzer for an S_{21} phase measurement.

```
[S21] [PHASE]
```

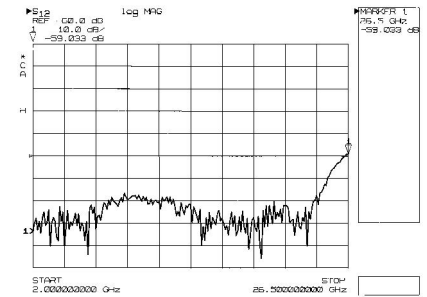

Figure 4. Reverse isolation measurement

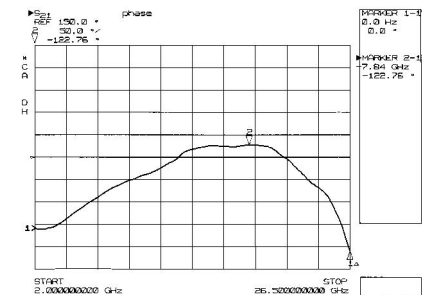

Figure 5. Deviation from linear phase measurement

Linear Measurements (continued)

2. Place a marker in the center of the band and activate the electrical delay feature,

```
[MARKER] {MARKER 1} {12 GHz}
RESPONSE [MENU]
{COAXIAL} OR {WAVEGUIDE}
```

depending upon whether the media exhibits intrinsic linear or dispersive phase shift.
{AUTO DELAY}

3. {ELECTRICAL DELAY} is now the active function. Use the knob, STEP keys, or numeric and units to fine tune the electrical delay for a flat phase response near the center of the passband. The linear phase shift through the AUT is effectively removed and all that remains is the deviation from this linear phase shift.

4. Use the markers to measure the maximum peak-to-peak deviation from linear phase.

```
[MARKER]
{MARKER 1}
{MORE} {MARKER TO MINIMUM}
[PRIOR MENU]
{MARKER 2}
{MODE MENU} {REF=1}
{MORE} {MARKER TO MAXIMUM}
```

Group delay

Group delay is calculated from the phase and frequency information and is displayed in real time by the 8510C network analyzer.

1. Set up the 8510C for an S_{21} group delay measurement.

```
[S21] [DELAY]
```

2. Activate a marker to measure the group delay at a particular frequency.

Group delay measurements may require a specific aperture (Δf) or frequency spacing between measurement points. The phase shift between two adjacent frequency points must be less than 180° , otherwise incorrect group delay information may result.

$$\text{Approximate delay of AUT} < \frac{\text{number of points} - 1}{2 * (\text{frequency span})}$$

The effective group delay aperture can be increased from the minimum by varying the smoothing percentage. Increasing the aperture reduces the resolution demands on the phase detector and permits better group delay resolution by increasing the number of measurement points over which the group delay aperture is calculated. Since increasing the aperture removes fine grain variations from the response, it is critical that group delay aperture be specified when comparing group delay measurements. To adjust the aperture press RESPONSE [MENU] [SMOOTHING ON] and adjust aperture as necessary.

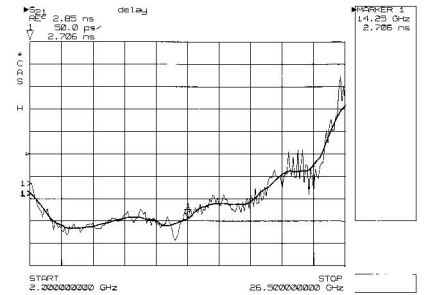

Figure 6. Group delay measurement with minimum and increased aperture

Return loss, SWR, and reflection coefficient

Return loss (RL), standing wave ratio (SWR) or reflection coefficient (ρ) are commonly specified to quantify the reflection mismatch at the input and output ports of an AUT. Because reflection measurements involve loss instead of gain, power levels are lower at the receiver inputs. Therefore, it may be necessary to increase power levels for reflection measurements. Alternatively, the noise levels can be reduced by increasing the averaging.

1. Set up the 8510C for an S_{11} measurement.

[S11]

2. Display the return loss, SWR, and reflection coefficient of the input port of the AUT.

[LOG MAG]
 FORMAT [MENU] {SWR}
 {LINEAR MAGNITUDE}

3. Similarly, the output match of the AUT can be measured by repeating the procedure for S_{22} .

Complex impedance

When the phase and magnitude characteristics of an AUT are desired, the complex impedance can be easily determined.

1. Set up the analyzer for an S_{11} measurement.

[S11]

2. Display the input impedance of the AUT.

[SMITH CHART]

Markers used with this format display $R + jX$. The reactance is displayed as an equivalent capacitance or inductance at the marker frequency. Marker values are normally based on a system Z_0 of 50Ω . If the measurement environment is not 50Ω , the network analyzer characteristic impedance must be modified under [CAL] {MORE} {SET Z0} before calibrating. In addition, a minimum loss pad or matching transformer must be inserted between the AUT and the measurement port.

3. Display the complex reflection coefficient (G). The linear magnitude and phase will be displayed at the marker frequency.

FORMAT [MENU] {Re/Im mkr on POLAR}

4. Similarly, the output impedance of the AUT can be measured by repeating the process for S_{22} .

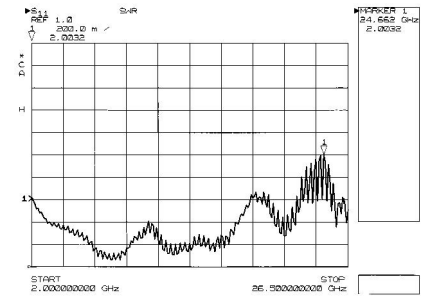

Figure 7. Input SWR measurement

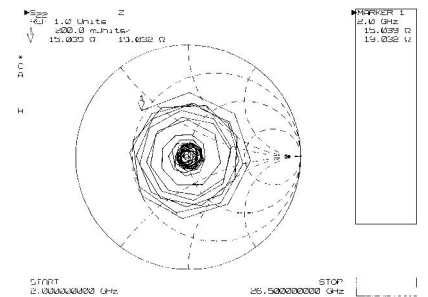

Figure 8. Complex output impedance measurement

Power Flatness Correction

The power flatness calibration feature of the 8510C network analyzer provides a more precise power level to the AUT. A 437B or 438A power meter and an appropriate power sensor such as the Keysight 8481A, 8485A or 8487A are required.

The power sensor is attached to the desired test port, after any cables or adapters leading up to the point where the AUT will be connected, and a single power calibration sweep is performed. The power meter monitors the test port power at each measurement point across the frequency band of interest, and a table of power corrections versus frequency is derived and stored in the 8360 synthesized sweeper. When the power meter is disconnected and the test port flatness correction is enabled, the source will adjust the output power to compensate for path losses at each measurement point in the frequency span, with no degradation in measurement speed.

1. Configure the system as shown in Figure 10. Connect the 437B power meter to the system bus of the 8510C. Zero and calibrate the power meter. Verify that the address of the power meter matches the setting in the network analyzer. The default address for the 437B is 13.

```
[LOCAL] {POWERMETER} [13] [x1]
```

2. Choose the appropriate measurement parameters. Set the source to maximum leveled power (P1) at the highest frequency in the measurement span. See Appendix C, "8360 Series Synthesized Sweepers maximum leveled power."

```
[START] [2] [G/n]
[STOP] [26.5] [G/n]
[S21]
STIMULUS [MENU]
{POWER MENU}
{POWER SOURCE 1}P1 [x1]
```

3. When the flatness calibration is initiated, the analyzer sends the source a list of flatness correction frequencies equal to the number of trace points set on the analyzer. If needed, adjust the number of analyzer trace points.

```
STIMULUS [MENU]
{NUMBER of POINTS}
```

4. Connect the power sensor to the active test port (normally port 1 where the input of the AUT is connected).

5. Initiate the flatness calibration.

```
STIMULUS [MENU]
{POWER MENU}
{POWER FLATNESS}
{CALIBRATE FLATNESS}
{FLATNESS CAL START}
```

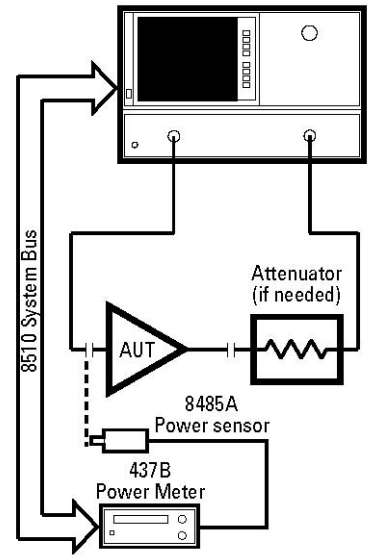

Figure 9. Power flatness correction setup

Power Flatness Correction (continued)

6. When the calibration is complete, activate flatness correction.

[PRIOR MENU]
{FLATNESS ON}

7. Verify the constant power level at the test port by using the 437B to measure the test port power at CW frequencies. As the power is manually measured, the user must enter each test frequency on the 437B so that the correct calibration factor will be used.

8. The analyzer will automatically store the correction table into register 1 of the source.

9. Remove the power sensor. Connect AUT and apply bias, if necessary.

Once the flatness calibration has been completed the user may choose to reduce the measurement frequency span at any time without invalidating the flatness correction.

Absolute output power

After port 1 has been calibrated for a constant input power, the 8510C can be used to display absolute power (in dBm or mW) versus frequency.

1. Perform a power flatness correction over the desired frequency range and power level (as previously described).

2. Set up channel 1 for the desired frequency range, number of points and step sweep mode.

3. Set the source power at a value appropriate for the device under test. This step is necessary to get a correct reading of absolute power. Connect a thru and perform a receiver calibration to remove the frequency response errors of the port 2 path in the measurement. Be sure to include any attenuators or adapters which are part of the measurement.

[CAL]
{RECEIVER CAL}
{INPUT PWR}
{OUTPUT PWR}
{SAVE RCVR CAL}

If several THRU's have been defined in the calibration kit, a further menu appears after {OUTPUT PWR} is selected to allow selection of the appropriate standard.

A flat line should be displayed at the correct power level.

4. Connect the AUT and apply bias, if necessary.

5. When Receiver Cal is turned on, parameter User 1 a1 displays input power (P_{in}) in dBm and User 2 b2 displays output power (P_{out}).

PARAMETER [MENU]
{USER 1 a1}
{USER 2 b2}

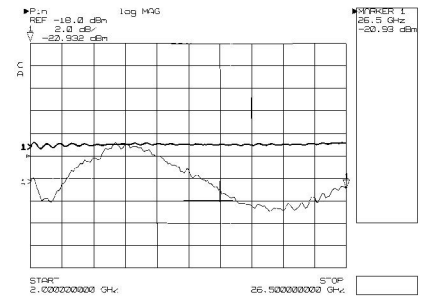

Figure 10. Test port power before and after a power meter calibration

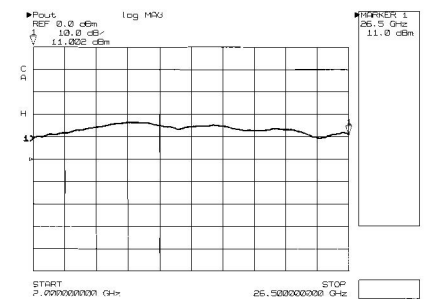

Figure 11. Absolute output power measurement

Nonlinear Measurements

The Keysight 8510C has the capability to make measurements of amplifiers operating in their nonlinear region. A swept-frequency gain compression measurement locates the frequency at which the 1 dB gain compression first occurs. A swept-power gain compression measurement shows the reduction in gain at a single frequency as a power ramp is applied to the AUT.

Swept-frequency gain compression

A measurement of swept-frequency gain compression locates the frequency at which the 1 dB gain compression first occurs. The swept-frequency gain compression is determined by normalizing to the small signal gain and by observing compression as the 1 dB drop from the reference line as input power is increased. The swept-frequency gain compression and corresponding output power (P_{1dB}) can be displayed simultaneously on the 8510C network analyzer.

1. Perform an absolute output power calibration and measurement (as previously described).

2. Channel 1 should already be set up for an absolute power measurement (with correction on). Set up channel 2 for an S_{21} gain measurement. Turn on a dual channel split display.

```
[CH 2] [S21]
[LOG MAG]
[DISPLAY] {DISPLAY MODE}
{DUAL CHAN SPLIT}
```

3. Connect the AUT and apply bias, if necessary.

4. Normalize the display to the small signal gain.

```
[DISPLAY] {DATA AND MEMORIES}
{DATA->MEMORY}
{Math (/)}
```

A flat line at 0 dB should now be displayed on channel 2.

5. Set a scale of 0.5 dB/division and a reference value of 0 dB to allow easy viewing of a 1 dB drop from the small signal gain.

6. Increase the source power level until the trace drops by 1 dB at some frequency. A marker can then be used to read the exact frequency where the 1 dB compression first occurs. Care should be taken when increasing the source power so that the input power limitation of the AUT is not exceeded.

```
STIMULUS [MENU]
{POWER MENU} {POWER SOURCE 1}
```

Use knob or arrow keys to increase power.

```
[MARKER]
{MARKER 1}
```

7. Set the source power on channel 1 to the same value as for channel 2. The channel 1 marker displays the actual output power of the amplifier (in dBm) at the 1 dB gain compression point. In this example, the 1 dB gain compression first occurs at 26.255 GHz at an output power level of 16.19 dBm.

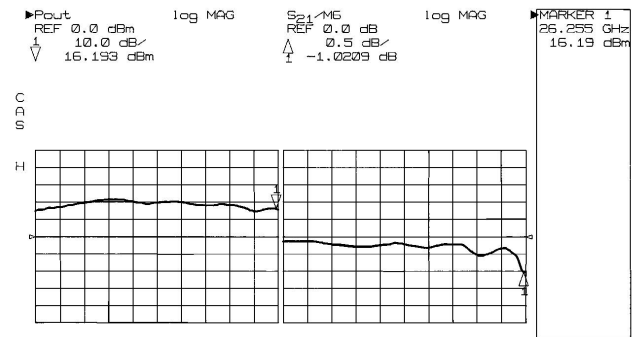

Figure 12. Swept-frequency gain compression measurement

Swept-power gain compression

By applying a fixed-frequency power sweep to the input of an amplifier, the gain compression can be observed as a 1 dB drop from small signal gain. The power sweep should be selected such that the AUT is forced into compression.

The S_{21} gain will decrease as the input power is increased into the nonlinear operating region of the amplifier. The 8510C network analyzer has a power sweep range as defined earlier in Table 1. The fixed frequency chosen could be the frequency for which the 1 dB drop first occurs in a swept-frequency gain compression measurement. The swept-power gain compression and corresponding output power (P_{out}) can be displayed simultaneously on the 8510C network analyzer. A power flatness correction over a power sweep range (at a fixed frequency) may be performed first if very accurate power is required at the input to the AUT.

1. Configure the system as shown in Figure 2.
2. Perform a power flatness correction, if necessary.
3. Set up channel 1 for an absolute power measurement and channel 2 for an S_{21} gain measurement as described earlier.
4. Turn on a dual channel split display.

[DISPLAY] {DISPLAY MODE}
 {DUAL CHAN SPLIT}

5. Set the marker to the CW frequency point of interest, and set the power low enough to avoid driving the device into compression.
6. Turn on power domain. Set the start and stop power points to drive the amplifier into compression.

[DOMAIN] {POWER} [
 START] -22 [x1]
 [STOP] -12 [x1]

7. Connect the AUT and apply bias, if necessary.
8. Move a marker to the flat portion of the trace. If there is no flat portion the AUT is in compression throughout the sweep, and power levels must be decreased. Use the marker search to find the power for which a 1 dB drop in gain occurs. Read the marker value for channel 1 to determine the absolute input power (P_{in}) or output power (P_{out}) where the 1 dB gain compression occurs.

[MARKER] {MORE} {MINIMUM}
 [CHANNEL 1]
 PARAMETER [MENU]
 {USER 1 a1} or {USER 2 b2}

In this example, the 1 dB gain compression at 26.255 GHz occurs at an output power level of 16.006 dBm and an input power level of -14.7 dBm.

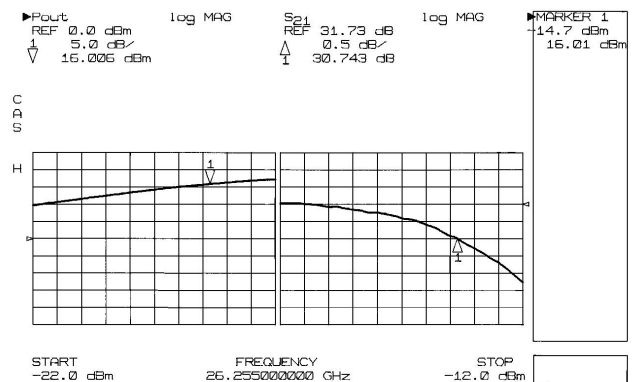

Figure 13. Swept power gain compression measurement

Appendix A—High-Power Measurements

Custom test set configurations

The Keysight 85110 test set provides the greatest flexibility for the testing of high-power amplifiers which often require custom test set configurations. The 85110 test set is an open architecture which allows amplifiers to be added to the RF path of the test set. External test set components (amplifiers, couplers, isolators, attenuators, etc.) can be specially selected to provide the necessary power handling capability.

For example, if the required input power for the AUT is greater than the standard 8510C test set can provide, the 85110 test set allows the addition of an amplifier to properly drive the AUT. Highpower couplers and attenuators are required to prevent over-driving the reference and test samplers.

Special test set configurations

Special 8510 test set configurations for high-power testing are available on a request basis. An example of a special 85110 configuration is shown in Figure 15. This modified RF block diagram allows up to 500 watts (CW) of high-power handling capability and also provides the ability to connect additional test equipment to the AUT via a single RF connection.

High-power directional couplers replace the standard directional couplers in the 85110. A pair of high-power step attenuators are added before the test samplers (A and B) to prevent them from being overdriven by the AUT. For some amplifier measurements, throughput is a major concern due to the multiplicity of tests that are required. It is desirable to make as many measurements as possible at one test station with a single connection to the device to reduce lengthy setup time. The front panel port 1 and port 2 jumpers also allow the addition of other test equipment (power meter, spectrum analyzer, noise figure meter, etc.) for a single connection multiple measurement solution.

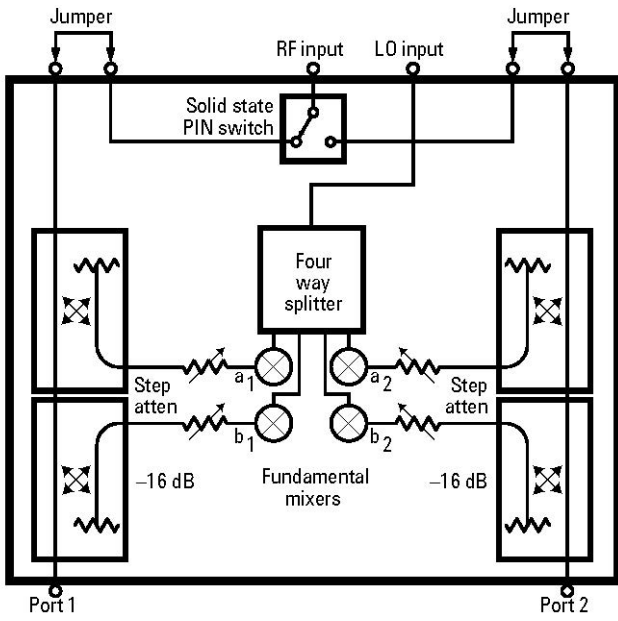

Figure 14. 85110 simplified block diagram

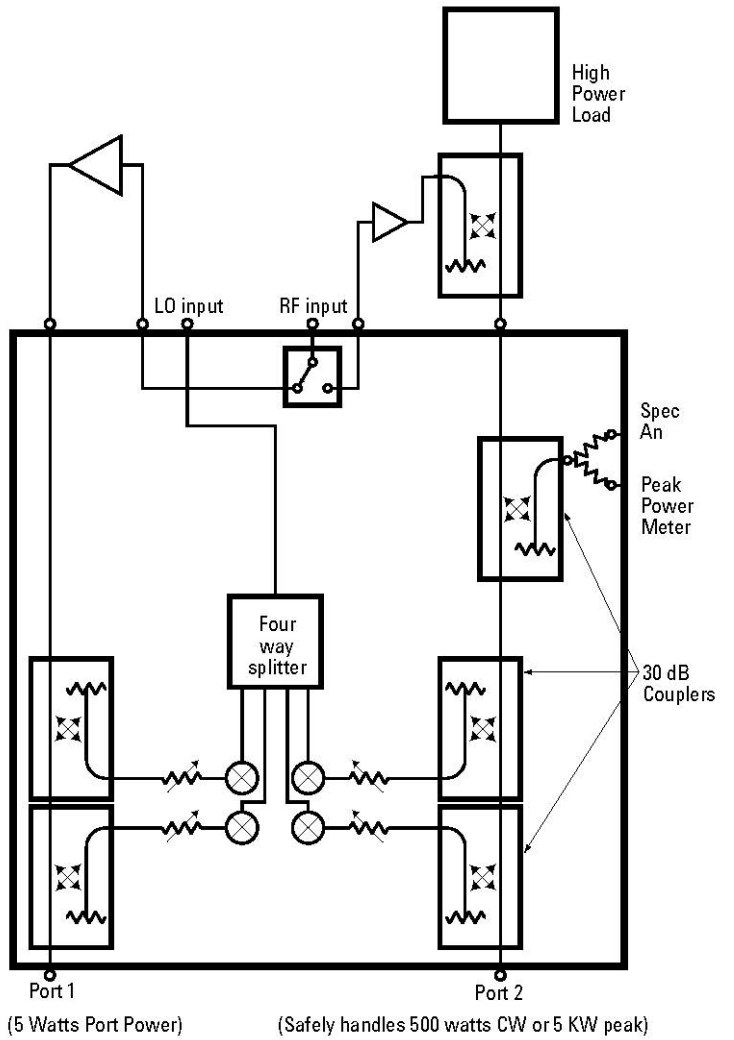

Figure 15. Block diagram for special high-power test set configuration for the 85110

Appendix B—Accuracy Considerations

Error correction can be applied to the measurements discussed in this note to reduce the measurement uncertainty. A full two-port calibration was used for the measurement examples (except where noted) to provide the best measurement accuracy of both transmission and reflection measurements of two-port devices. When a full two-port calibration is applied, the dynamic range and accuracy of the measurement is limited only by the system noise and stability, connector repeatability, and the accuracy to which the characteristics of the calibration standards are known.

In some instances it may be more convenient to perform a response calibration to remove the frequency response errors of the test setup for transmission only measurements when extreme accuracy is not a critical factor. Likewise, an S_{11} one-port or S_{22} one-port calibration to remove directivity, source match and frequency response errors may be more convenient for reflection only measurements when the AUT is well-terminated.

Transmission measurements

For a gain measurement, the three major sources of error are the frequency response error of the test setup, the source and load mismatch error during the measurement, and the dynamic accuracy. A simple response calibration using a thru connection significantly reduces the frequency response error which is usually the dominant error in a transmission measurement. For the greatest accuracy, a full two-port calibration can be used which also reduces the uncertainty in the measurement caused by the source and load match.

Dynamic accuracy is a measure of the receiver's performance as a function of the incident power level and has an effect on the uncertainty of a gain measurement. This is because the receiver detects a different power level between calibration and measurement. The effects of dynamic accuracy on a gain measurement are negligible (less than 0.5 dB) as long as the network analyzer is operating below the specified 0.1 dB compression level.

A gain drift measurement is subject to the same errors as a gain measurement. Another factor that could be significant is the transmission tracking drift of the system. This drift is primarily caused by the change in the temperature of the test setup between calibration and measurement. To minimize this effect, allow the instrument to stabilize to the ambient temperature before calibration and measurement.

A reverse isolation measurement is subject to the same errors as a gain measurement. In addition, if the isolation of the AUT is very large, the transmitted signal level may be near the noise floor or crosstalk level of the receiver. To lower the noise floor, a decreased IF bandwidth may be necessary. When crosstalk levels begin to affect the measurement accuracy, a response and isolation calibration or a full two-port calibration (including the isolation part of the calibration) removes the crosstalk error term. When performing the isolation part of the calibration it is important to use the same averaging factor and IF bandwidth during the calibration and measurement.

For deviation from linear phase measurements, the phase uncertainty is calculated from a comparison of the magnitude uncertainty (already discussed for gain measurements) with the test signal magnitude.

Reflection measurements

The uncertainty of a reflection measurement such as return loss, SWR, reflection coefficient and impedance is affected by directivity, source match, load match, and reflection tracking of the test system. With a full two-port calibration, the effects of these factors are minimized. A one-port calibration can provide equivalent results if the amplifier has sufficient isolation to reduce the effects of the load match.

Nonlinear measurements

For absolute power measurements, a frequency response calibration is used. Because the power calibration is made relative to 50 Ω , inaccuracies due to mismatch will occur when a device is attached that is not exactly 50 Ω . Since the power meter calibration feature is not a true leveling feature, it cannot correct for mismatches that occur between the test port and the AUT. Mismatch can be reduced by using attenuators at the input or output of the AUT.

For a gain compression measurement a response calibration reduces the frequency response errors. A gain compression measurement requires the power level to be changed after a calibration. The Keysight 8360 Series sources, used with the 8510C are specified to have a source linearity of ± 5 dB, typically less than ± 2 dB. Source linearity uncertainty can be reduced by performing a power flatness correction at the input of the AUT. This precisely sets the power level incident to the AUT by compensating the source power for any nonlinearities in the source or test setup.

Appendix C—8360 Series Synthesized Sweepers Maximum Leveled Power (dBm)

Frequency	83620A/ 83621A	83623A	83631A	83651A
20 GHz	+10	+17	+10	+10
26.5 GHz	–	–	+4	+4
40 GHz	–	–	–	+3
50 GHz	–	–	–	0

When power levels from the AUT are such that external attenuation is not practical or when the source cannot deliver enough power to properly drive the AUT, it may be necessary to construct a custom test set.

Appendix D—Optimizing Power Sweep Range

Power sweep range will be reduced if a power flatness correction is used in combination with power sweep. If flat test port power is required, there is no way to avoid this.

If the source has step attenuators installed, and a power flatness correction is used with power sweep, the available sweep range will be further reduced. This reduction is due to the source setting the attenuator for the optimum ALC (automatic leveling control) range. This loss in sweep range can be compensated for using one of the following two methods. Both methods require a computer to implement a work around which allows better use of the ALC range in the 8360 synthesizer when using power sweep plus flatness correction.

The first method involves using a computer connected directly to the source to make the modifications.

1. Read the flatness correction array from the 8360. Determine the average.
2. Determine the average amplitude correction the array is providing $(\max + \min)/2$ (eg. $(-10 \text{ dBm} + -30 \text{ dBm})/2$).
3. Subtract this number from each of the numbers in the array and put this modified array back into the 8360.
4. Use that same “average correction” and input that as a “power offset”.

The net result will be the same power out of the 8360, but the attenuators will be “faked out” and allow as much of the ALC range to be used as possible. (Remember that some sweep range will still be lost because of the flatness correction.)

The second method involves connecting the computer to the 8510 and using the “pass-through” address to access the source. Pass-through allows you to WRITE to the source, but not READ them from the source, so an alternate method must be used.

Since you can't read the actual array from the 8510, you have to find another way to get the same data. With the 8510, you can read the power to the test port by looking at “a1” instead of S_{11} , S_{21} , etc. The procedure is as follows.

1. Read the “a1” data with flatness off into a computer.
2. Read the “a1” data with flatness on.
3. Calculate the difference in dB between the two traces and determine the max and min correction. From that, calculate the “average correction.”
4. Build a new flatness array, subtracting the “average correction” as in the previous process.
5. Write this to the 8360 using pass-through.
6. Set the power offset also using pass-through.

Note: You must make sure you are operating in the linear region of the test set, otherwise the offset will not be correct.

Optimizing Power Sweep Range (continued)

The following example program demonstrates this method.

```

10 ! RE-SAVE "POW_OFFSET"
20 !
30 ! This program calculates and removes the average ampli-
  tude correction
40 ! factor from the 8360 flatness correction array. It then sets
  and
50 ! activates this average amplitude as a constant offset to
  the 8360
60 ! power output. The flatness array minus the offset is then
  re-written
70 ! to the 8360. The net result output power is the same (flat
  test port
80 ! power). However, full ALC range will now be available for
  any power
90 ! or attenuator setting.
100 !
110 DIMDiff(1:801,1),Flat_on(1:801,1), Flat_off(1:801,1)
120 INTEGER I,Preamble,Bytes
130 ASSIGN @Na TO 716
140 ASSIGN @Na_data TO 716;FORMAT OFF
150 ASSIGN @Na_sys TO 717
160 CLEAR SCREEN
170 !
180 PRINT TABXY(0,5)
190 PRINT "NOTICE:"
200 PRINT
210 PRINT "This program will only work in STEP or RAMP sweep
  modes. Any"
220 PRINT "number of points may be used (51, 101, 201, 401 or
  801)."
```

```

230 PRINT
240 PRINT "A test port power flatness calibration must
  already be done."
250 PRINT
260 PRINT "The current instrument state will be saved in Inst
  State 5 and"
270 PRINT "recalled at the end of this program."
280 INPUT "Press <Return> to continue.",In$
290 CLEAR SCREEN
300 OUTPUT @Na;"SAVE5"
310 GOSUB Get_data
320 GOSUB Process_data
330 OUTPUT @Na;"RECA5; FLATON"
340 !
350 PRINT TABXY(0,5)
360 PRINT "Source PowerOffset=";PROUND (Offset,-2);" db"
370 PRINT
380 PRINT "WARNING: Power offset is now on in the source.
  This offset is"
390 PRINT "applied to the power setting displayed by the 8510
  with flatness"
400 PRINT "turned On OR Off."
410 PRINT "Power offset will be turned off in the source if
  a factory"
420 PRINT "preset is executed OR 8510 power is cycled.
  Otherwise it will"
430 PRINT "be applied."
440 PRINT "Flatness data stored in the source is only valid
  with offset"
450 PRINT "on. You must re-do 8510 flatness calibration
  (without offset)"
460 PRINT "before running this program again for correct
  results."
470 DISP "Program Complete"
480 LOCAL @Na
490 STOP
500 !
510 Get_data: !
520 OUTPUT @Na;"USER1; LOGM; AVERON 64; FLATON; SING"
530 OUTPUT @Na;"FORM3; OUTPFORM"
540 ENTER @Na_data;Preamble,Bytes
550 REDIMDiff(1:Bytes/16,1),Flat_on (1:Bytes/16,1),
  Flat_off(1:Bytes/16,1)
560 ENTER @Na_data;Flat_on(*) ! Flat_on(*,0) = amplitude db
570 ! Flat_on(*,1) = 0
580 OUTPUT @Na;"FLATOFF; SING; FORM3; OUTPFORM"
590 ENTER
  @Na_data;Preamble,Bytes,Flat_off(*) ! Flat_off (*,0) =
  amplitude db
600 ! Flat_off(*,1) = 0
610 OUTPUT @Na;"POIN; OUTPACTI"
620 ENTER @Na;Points
630 OUTPUT @Na;"STAR; OUTPACTI"
640 ENTER @Na;Start_freq
650 OUTPUT @Na;"STOP; OUTPACTI"
660 ENTER @Na;Stop_freq
670 RETURN
680 !
690 Process_data: !
700 MAT Diff= Flat_on-Flat_off ! Diff(*) = source flatness corr
  array
710 Offset=SUM(Diff)/(Bytes/16)
720 MAT Diff(*,1)= Diff(*,0) ! Diff(*,1) = flatness amplitudes
730 Freq_increment=(Stop_freq-Start_freq)/(Points-1)
740 Freq=Start_freq
750 FOR I=1 TO Points
760 Diff(I,0)=Freq ! Diff(*,0) = flatness frequencies
770 Diff(I,1)=Diff(I,1)-Offset ! remove offset from flatness ampli-
  tudes
780 Freq=Freq+Freq_increment ! next frequency
790 NEXT I
800 OUTPUT @Na;"ADDRPASS 19"
810 OUTPUT @Na_sys;"SYST:LANG TMSL"
820 WAIT 3
830 OUTPUT @Na_sys ! required after 8360 language switch,
  ignore system

```

Optimizing Power Sweep Range (continued)

```

840 ! bus address error.
850 OUTPUT @Na_sys;"CORR:FLAT ";Diff(*) ! output modified flatness array
860 OUTPUT @Na_sys;"POW:OFFS ";Offset
870 OUTPUT @Na_sys;"POW:OFFS:STAT ON"
880 OUTPUT @Na_sys;"SYST:LANG COMP"
890 WAIT 1
900 OUTPUT @Na;"ADDRPASS 31; CONT; POWE; OUTPACTI"
910 ENTER @Na;Power
920 OUTPUT @Na;"POWE ";Power ! must resend power so source applies offset
930 RETURN
940 !
950 END

```

This Technical Overview was recently referred to as Product Note 8510-18

For more information on Keysight Technologies' products, applications or services, please contact your local Keysight office. The complete list is available at: www.keysight.com/find/contactus

Americas

Canada	(877) 894 4414
Brazil	55 11 3351 7010
Mexico	001 800 254 2440
United States	(800) 829 4444

Asia Pacific

Australia	1 800 629 485
China	800 810 0189
Hong Kong	800 938 693
India	1 800 112 929
Japan	0120 (421) 345
Korea	080 769 0800
Malaysia	1 800 888 848
Singapore	1 800 375 8100
Taiwan	0800 047 866
Other AP Countries	(65) 6375 8100

Europe & Middle East

Austria	0800 001122
Belgium	0800 58580
Finland	0800 523252
France	0805 980333
Germany	0800 6270999
Ireland	1800 832700
Israel	1 809 343051
Italy	800 599100
Luxembourg	+32 800 58580
Netherlands	0800 0233200
Russia	8800 5009286
Spain	800 000154
Sweden	0200 882255
Switzerland	0800 805353
	Opt. 1 (DE)
	Opt. 2 (FR)
	Opt. 3 (IT)
United Kingdom	0800 0260637

For other unlisted countries:
www.keysight.com/find/contactus
 (BP-09-23-14)