

Keysight 34937A-34939A General Purpose Switch Modules

Notices

Copyright Notice

© Keysight Technologies 2016-2022

No part of this manual may be reproduced in any form or by any means (including electronic storage and retrieval or translation into a foreign language) without prior agreement and written consent from Keysight Technologies as governed by United States and international copyright laws.

Trademarks

Microsoft® and Windows® are U.S. registered trademarks of Microsoft Corporation.

Manual Part Number

34980-90037

Edition

Edition 4, Aug 2022

Printed in:

Printed in Malaysia

Published by:

Keysight Technologies
Bayan Lepas Free Industrial Zone,
11900 Penang, Malaysia

Technology Licenses

The hardware and/or software described in this document are furnished under a license and may be used or copied only in accordance with the terms of such license.

Declaration of Conformity

Declarations of Conformity for this product and for other Keysight products may be downloaded from the Web. Go to <http://www.keysight.com/go/conformity>. You can then search by product number to find the latest Declaration of Conformity.

U.S. Government Rights

The Software is “commercial computer software,” as defined by Federal Acquisition Regulation (“FAR”) 2.101. Pursuant to FAR 12.212 and 27.405-3 and Department of Defense FAR Supplement (“DFARS”) 227.7202, the U.S. government acquires commercial computer software under the same terms by which the software is customarily provided to the public. Accordingly, Keysight provides the Software to U.S. government customers under its standard commercial license, which is embodied in its End User License Agreement (EULA), a copy of which can be found at <http://www.keysight.com/find/sweula>. The license set forth in the EULA represents the exclusive authority by which the U.S. government may use, modify, distribute, or disclose the Software. The EULA and the license set forth therein, does not require or permit, among other things, that Keysight: (1) Furnish technical information related to commercial computer software or commercial computer software documentation that is not customarily provided to the public; or (2) Relinquish to, or otherwise provide, the government rights in excess of these rights customarily provided to the public to use, modify, reproduce, release, perform, display, or disclose commercial computer software or commercial computer software documentation. No additional government requirements beyond those set forth in the EULA shall apply, except to the extent that those terms, rights, or licenses are explicitly required from all providers of commercial computer software pursuant to the FAR and the DFARS and are set forth specifically in writing elsewhere in the EULA. Keysight shall be under no obligation to update, revise or otherwise modify the Software. With respect to any technical data as defined by FAR 2.101, pursuant to FAR 12.211 and 27.404.2 and DFARS 227.7102, the U.S. government acquires no greater than Limited Rights as defined in FAR 27.401 or DFAR 227.7103-5 (c), as applicable in any technical data.

Warranty

THE MATERIAL CONTAINED IN THIS DOCUMENT IS PROVIDED “AS IS,” AND IS SUBJECT TO BEING CHANGED, WITHOUT NOTICE, IN FUTURE EDITIONS. FURTHER, TO THE MAXIMUM EXTENT PERMITTED BY APPLICABLE LAW, KEYSIGHT DISCLAIMS ALL WARRANTIES, EITHER EXPRESS OR IMPLIED, WITH REGARD TO THIS MANUAL AND ANY INFORMATION CONTAINED HEREIN, INCLUDING BUT NOT LIMITED TO THE IMPLIED WARRANTIES OF MERCHANTABILITY AND FITNESS FOR A PARTICULAR PURPOSE. KEYSIGHT SHALL NOT BE LIABLE FOR ERRORS OR FOR INCIDENTAL OR CONSEQUENTIAL DAMAGES IN CONNECTION WITH THE FURNISHING, USE, OR PERFORMANCE OF THIS DOCUMENT OR OF ANY INFORMATION CONTAINED HEREIN. SHOULD KEYSIGHT AND THE USER HAVE A SEPARATE WRITTEN AGREEMENT WITH WARRANTY TERMS COVERING THE MATERIAL IN THIS DOCUMENT THAT CONFLICT WITH THESE TERMS, THE WARRANTY TERMS IN THE SEPARATE AGREEMENT SHALL CONTROL.

Safety Information

CAUTION















A CAUTION notice denotes a hazard. It calls attention to an operating procedure, practice, or the like that, if not correctly performed or adhered to, could result in damage to the product or loss of important data. Do not proceed beyond a CAUTION notice until the indicated conditions are fully understood and met.

WARNING

A WARNING notice denotes a hazard. It calls attention to an operating procedure, practice, or the like that, if not correctly performed or adhered to, could result in personal injury or death. Do not proceed beyond a WARNING notice until the indicated conditions are fully understood and met.

Safety Symbols

The following symbols or markings that may be on or with the instrument and in the documentation indicate precautions which must be taken to maintain safe operation of the instrument.

	Alternating current (AC)		Frame or chassis (ground) terminal
	Standby supply. Unit is not completely disconnected from ac mains when switch is off		Caution, risk of electric shock
	Caution, risk of danger (refer to this manual for specific Warning or Caution information)		Direct current (DC)
	Off (mains supply)		On (mains supply)
	Three phase alternating current		Presence of a laser device
	Protective earth (ground) terminal		Equipment protected throughout by double insulation or reinforced insulation
	Caution, hot surface		Product is sensitive to electrostatic discharge

Additional Safety Notices

The following general safety precautions must be observed during all phases of operation of this instrument. Failure to comply with these precautions or with specific warnings or instructions elsewhere in this manual violates safety standards of design, manufacture, and intended use of the instrument. Keysight Technologies assumes no liability of the customer's failure to comply with the requirements.

WARNING

Refer to the 34980A User's Guide before using the equipment. The 34980A User's Guide contains additional important information about the modules.

WARNING

GENERAL

If this product is not used as specified in the operating instructions, the protection provided by the equipment could be impaired. This product must be used in a normal condition (in which all means for protection are intact) only. Any external connections must be made prior to applying power.

CAUTION

This instrument has auto-ranging line voltage input. Be sure the supply voltage is within the specified range and voltage fluctuations do not to exceed 10 percent of the nominal supply voltage.

NOTE

Pollution Degree 1: No pollution or only dry, non-conductive pollution occurs. The pollution has no influence (on insulation).

Pollution Degree 2: Normally only non-conductive pollution occurs. Occasionally, a temporary conductivity (leakage current between isolated conductors) caused by condensation can be expected.

WARNING**GROUND THE INSTRUMENT**

This is a Safety Protection Class I Product (provided with a protective earthing ground incorporated in the power cord). The mains plug shall only be inserted in a socket outlet provided with a protective earth contact. Any interruption of the protective conductor inside or outside of the product is likely to make the product dangerous. Intentional interruption is prohibited. The mains wiring and connectors shall be compatible with the connector used in the premise electrical system. Inadequate earth grounding can damage the instrument. Always use the three-prong AC power cord supplied with the instrument.

Connect the AC power cord as follow:

- Ensure that the power cord is not damaged.
 - Install the signal generator so that one of the following items is readily identifiable and easily reached by the operator: AC power cord, alternative switch or circuit breaker.
 - Insert the mains plug into a socket outlet provided with a protective earth grounding.
-

WARNING

Removal of the instrument's cover is to be conducted by qualified personnel only. Only qualified, trained personnel who are aware of the hazards involved should remove instrument covers. Prevent operators from accessing any external circuits, test fixtures, cables or wherever hazardous voltages may be present. Failure to recognize and observe normal safety precautions could result in personal injury or death.

WARNING

Safety of any system incorporating the equipment is the responsibility of the assembler of the system.

WARNING

The detachable power cord is the instrument disconnecting device. It disconnects the mains circuits from the mains supply before other parts of the instrument. The front panel switch is only a standby switch and is not a LINE switch (disconnecting device). The instrument power cord does not disconnect or de-energize external circuits connected to the analog bus, terminal blocks or modules.

WARNING

Do not use the instrument if it is damaged. Before you use the instrument inspect all connections. Pay particular attention to the insulation surrounding connectors and / or cable assembly insulation. NEVER use a cable showing any signs of damage. Faulty cables can cause electrical shock and /or fire hazards and could lead to personal injury or death.

WARNING

Keysight Customers utilizing the Open Platform Test Systems are classified as follows and require the user to have the appropriate skillset:

Operator: Interacts with the test system in a production environment, selection of test sequences, defining variables, running tests (test results, test statistics, control of marking devices)

Supervisor: Includes access to maintenance functions and utility sequences (control of hardline system functions, access to test area)

Developer: Full access

WARNING

Dangerous voltage levels capable of causing death, may be present on a channel. Use extreme caution when handling and testing and adjusting this instrument. Any voltages greater than 30 Vrms, 42.4 Vpeak and 60 Vdc are considered hazardous (IEC 61010-1).

WARNING

The maximum common mode input to any one system component within the system installation is not to exceed the maximum stated ratings.

WARNING

When interconnecting system components, the overall system maximum allowable input rating of the system would default to the lowest rating of any one system component.

WARNING

When working with dangerous voltage levels, intentionally closing of multiple bus and channel relays could cause a potentially lethal hazard on external connections. Use extreme caution when handling and testing and adjusting this instrument. Do not perform these procedures unless qualified to do so. Failure to recognize and observe normal safety precautions could result in personal injury or death.

WARNING

No operator serviceable parts inside. Do not install substitute parts or perform any unauthorized modifications to the instrument. Return the instrument to Keysight for service and repair to ensure the safety features are maintained in operational condition. Instruments that appear damaged or defective should be made inoperative and secured against unintended operation.

WARNING

To prevent electrical shock, disconnect the instrument from mains and external circuits before cleaning. Use a dry cloth or one slightly dampened with water (or 70% Isopropyl Alcohol) to clean the external case parts. Do not attempt to clean internally. Allow any moisture to evaporate prior to energizing the instrument.

WARNING

This product is designed for use in INSTALLATION CATEGORY II and POLLUTION DEGREE 1 and 2 (See module specifications for ratings for each Pollution Degree environment).

WARNING

The AC Voltage source (outlet) must be in proper working order and provide a secure electrical connection. Do not use the outlet if the power cord makes a loose connection or if the power cord plug does not match the outlet. Do not use the outlet if it is damaged or if the voltage is outside the required range.

WARNING

ENVIRONMENTAL HEALTH & SAFETY: When any channel is connected to a hazardous voltage source, the instrument and the device under test should be supervised, following local EHS practices to restrict access.









Environmental Conditions



Keysight 34980A is designed for indoor use in an installation category II and low condensation environment. Table below shows the general environmental conditions for this instrument. Refer to the product data sheet at <https://literature.cdn.keysight.com/litweb/pdf/5989-1437EN.pdf> for more information on the instrument general specifications.

General specifications	Requirement
Temperature	Operating condition: 0°C to 55°C Storage condition: -40°C to 70°C
Humidity	Maximum Relative Humidity (non-condensing): 80% RH up to 40°C, decreases linearly to 37% RH at 55°C ^[a]
Altitude	Up to 2,000 m
Pollution degree	1 or 2

[a] From 40°C to 55°C, the maximum % Relative Humidity follows the line of constant dew point.

Regulatory Markings

 <p>The CE mark is a registered trademark of the European Community. This CE mark shows that the product complies with all the relevant European Legal Directives.</p>	 <p>The CSA mark is a registered trademark of the Canadian Standards Association.</p>
 <p>The UK conformity mark is a UK government owned mark. Products showing this mark comply with all applicable UK regulations.</p>	<p>The Keysight email address is required by EU directives applicable to our product.</p> 
<p>CAN ICES/NMB-001(A)</p> <p>This indicates that this ISM device complies with the Canadian ICES-001. Interference-Causing Equipment Standard for industrial, scientific and medical (ISM) equipment. Matériel industriel, scientifique et médical (ISM)</p>	<p>ISM 1-A</p> <p>This is a symbol of an Industrial Scientific and Medical Group 1 Class A product. (CISPR 11, Clause 5)</p>
 <p>The CE mark is a registered trademark of the European Community. This CE mark shows that the product complies with all the relevant European Legal Directives.</p> <p>ICES/NMB-001 indicates that this ISM device complies with the Canadian ICES-001.</p> <p>Cet appareil ISM est conforme à la norme NMB-001 du Canada.</p> <p>ISM GRP.1 Class A indicates that this is an Industrial Scientific and Medical Group 1 Class A product.</p>	 <p>This is a combined marking to indicate product compliance with the Industry Canadian Interference-Causing Equipment Standard (ICES/NMB-001). This is also a symbol of an Industrial Scientific and Medical Group 1 Class A product (CISPR 11, Clause 5).</p>
 <p>This symbol is a South Korean Class A EMC Declaration. This is a Class A instrument suitable for professional use and in electromagnetic environment outside of the home.</p>	 <p>The RCM mark is a registered trademark of the Australian Communications and Media Authority.</p>

 <p>This symbol indicates the time period during which no hazardous or toxic substance elements are expected to leak or deteriorate during normal use. Forty years is the expected useful life of the product.</p>	 <p>This instrument complies with the WEEE Directive (2002/96/EC) marking requirement. This affixed product label indicates that you must not discard this electrical or electronic product in domestic household waste.</p>
 <p>Universal recycling symbol.</p>	<p>IP x y</p> <p>This mark indicates product has been designed to meet the requirements of "IP x y", where "x" is the solid particle protection and "y" is the liquid ingress protection.</p>

Waste Electrical and Electronic Equipment (WEEE) Directive 2002/96/EC

The crossed out wheeled bin symbol indicates that separate collection for waste electric and electronic equipment (WEEE) is required, as obligated by the EU DIRECTIVE and other National legislation.

Please refer to [keysight.com/go/takeback](https://www.keysight.com/go/takeback) to understand your Trade in options with Keysight in addition to product takeback instructions.



Sales and Technical Support

To contact Keysight for sales and technical support, refer to the support links on the following Keysight websites:

- www.keysight.com/find/34980a
(product-specific information and support, software and documentation updates)
- www.keysight.com/find/assist
(worldwide contact information for repair and service)

Table of Contents

Safety Symbols	3
Additional Safety Notices	4
Environmental Conditions	9
Regulatory Markings	10
Waste Electrical and Electronic Equipment (WEEE) Directive 2002/96/EC	12
Sales and Technical Support	12
General Purpose Switch Modules	15
Operating Considerations	16
Electrical Considerations	16
Temperature Sensor	16
Switching Reactive Loads	16
Hardware Power-Fail Jumper	17
34937A, 34938A and 34939A SCPI Programming Examples	20
Opening and Closing Channels	20
Reading Jumper State and System Identity	20
Reading Cycle Count and Resetting Modules to Power-On State	21
34937A 32-Channel GP Switch Module	22
34937A Simplified Schematic	22
34937A D-Sub Connectors	23
34937T Terminal Block	24
34937T Terminal Block	25
34938A 20-Channel High-Current GP Switch Module	29
34938A Simplified Schematic	29
34938A D-Sub Connectors	30
34938T Terminal Block	31
34938T Terminal Block	32
34939A 64-Channel High-Density Form-A GP Switch Module	36
34939A Simplified Schematic	36
34939A D-Sub Connectors	37

34939T Terminal Block	39
34980A Current Limiting Graphs	42

General Purpose Switch Modules

This User's Guide covers the following two plug-in modules for the Keysight 34980A Multifunction Switch/Measure Unit:

34937A	28-channel Form C and 4-channel Form A
34938A	28-channel 5-amp Form A
34939A	64-Channel High-Density Form A

- The 34937A provides independent control of 32 relays, including:
 - Twenty-eight Form C relays, each rated for 1 A at 60 VA per channel
 - Four Form A (SPST) relays, each rated for 5 A at 150 VA per channel.
- The 34938A, for power switching applications, offers 20 Form A relays, each rated for 5 A at 150 VA per channel.
- The 34939A provides independent control of 64 Form-A relays, each rated for 1 A at 60 VA per channel.

All three modules utilize armature-latching relays.

You can use these general-purpose switches in your 34980A mainframe for device actuation, digital output, signal routing, or – combined with other switch modules – to create flexible switching topologies. You can close multiple channels at the same time. These modules do not connect to the 34980A's analog buses.

WARNING

High Energy Sources: The instruments are designed to handle inputs up to their rated currents or their rated powers, whichever is less. Under certain fault conditions, high energy sources could provide substantially more current or power than the instrument can handle. It is important to provide external current limiting, such as fuses if the inputs are connected to high-energy sources. The overcurrent protection is to be rated for the maximum available short circuit current of the hazardous sources. Ensure that the current limiting devices / snubber circuits are appropriate for the signal being tested. Failure to do so may result in hazardous conditions such as fire or shock and could lead to personal injury or death. Refer to **34980A Current Limiting Graphs** for the current limiting graphs of 34890A.

Operating Considerations

WARNING

Do not connect the instruments directly to a mains power outlet. If it is necessary to switch a mains voltage or any circuit where a large inductive load may be switched, you must add signal conditioning elements to reduce the potential transients before they reach the instruments. Refer to User's Guide for the maximum rated transients for each external source.

Electrical Considerations

See the *Introduction to the Plug In Modules* chapter of the 34980A Mainframe User's Guide for detailed environmental operating conditions for the 34980A mainframe and its installed modules. That guidance sets maximum per channel current and power ratings at rated voltage for pollution degree 1 (dry) and pollution degree 2 (possible condensation) conditions, for each of the GP modules.

Temperature Sensor

A temperature sensor on these modules triggers system interrupts when high-carry current-induced heat on the modules is excessive and sets the HOT annunciator on the front panel. This over-temperature situation generates an SRQ event when the factory-set 70 °C threshold is reached. It is up to the user to determine what, if any, action should be taken.

Switching Reactive Loads

Reactive loads (those that include significant inductance or capacitance) can cause voltage spikes or current spikes during switching operations. The general purpose modules *are* designed for switching reactive loads. The optional 34937T and 34938T terminal blocks have solder pads for adding snubber circuits for the 5 A relays to reduce the reactive transients. See the drawings on [page 24](#) and [page 31](#) for the locations of snubber circuit pads and installation information about a snubber circuit.

WARNING

High Energy Sources: The instruments are designed to handle inputs up to their rated currents or their rated powers, whichever is less. Under certain fault conditions, high energy sources could provide substantially more current or power than the instrument can handle. It is important to provide external current limiting, such as fuses if the inputs are connected to high-energy sources. The overcurrent protection is to be rated for the maximum available short circuit current of the hazardous sources. Ensure that the current limiting devices / snubber circuits are appropriate for the signal being tested. Failure to do so may result in hazardous conditions such as fire or shock and could lead to personal injury or death. Refer to [34980A Current Limiting Graphs](#) for the current limiting graphs of 34890A.

Hardware Power-Fail Jumper

A hardware jumper on the 34937A and 34938A modules allows you to define the power-failure states for the modules' 5 A latching relays. Depending on the position of the jumper, the 5 A relays will either open or maintain state when system power failure occurs.

On the 34939A module, a hardware jumper allows you to define the power-failure state affecting *all 64* of the module's 1 A latching relays. Depending on the position of the jumper, these relays will either open or maintain state when system power failure occurs.

The jumpers are positionable across pins 1–2 (“Open” position) or across pins 2–3 (“Maintain” position). When shipped from the factory, the power-fail jumper is in the Maintain position (i.e. all relays maintain their present state when power fails).

WARNING

Before changing the position of the jumper, remove external connections from the module. Under certain conditions, dangerous voltage levels capable of causing injury or death may remain even after external circuits have been disconnected. To avoid electrical shock, remove the main power cord from the 34980A and ensure all connections to the DUT, including field wiring to the instrument and the analog bus (if present) are deenergized and all circuits are discharged before coming in contact with the system. Ensure no hazardous voltages remain on any accessible before handling any part of the instrument and test setup, making connections to the system, removing covers or cleaning the instrument.

After all circuits are discharged and no hazardous voltages remain, remove the sheet metal cover from the module and move the position of the jumper mounted on the module. See the figure below for the jumper's location on the module.

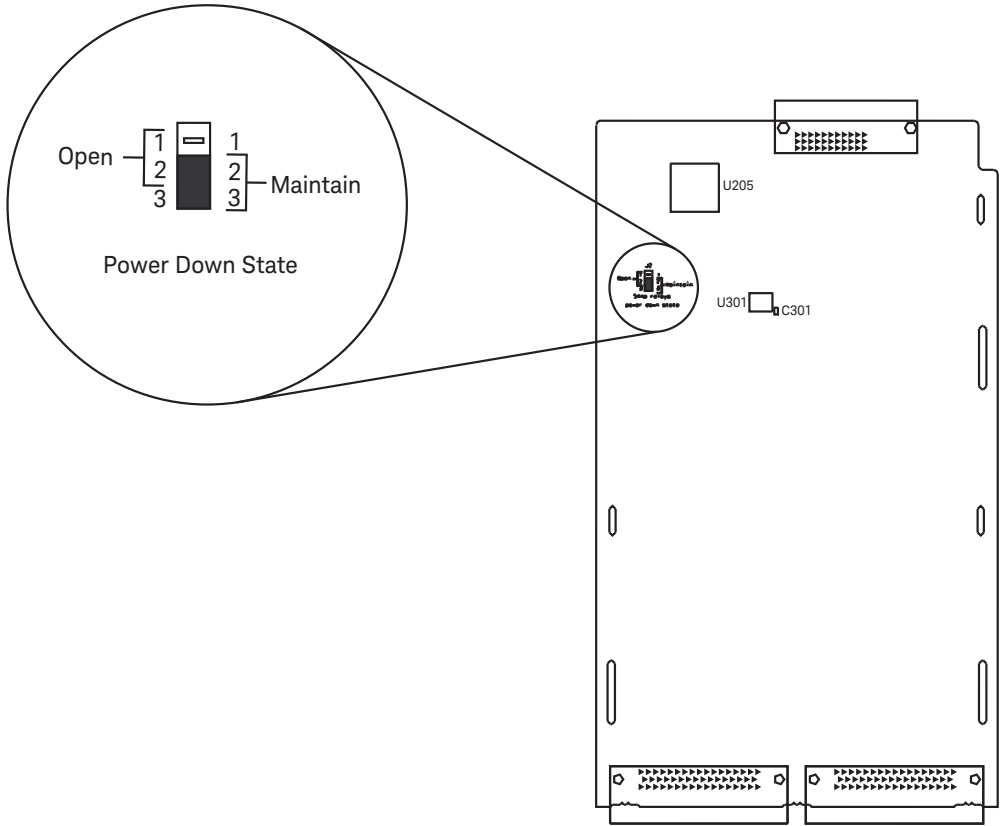

34937A, 34938A and 34939A SCPI Programming Examples

The programming examples below provide you with SCPI command examples to use for actions specific to the general purpose switch modules.

The slot and channel addressing scheme used in these examples follow the form **sccc** where **s** is the mainframe slot number (1 through 8) and **ccc** is the channel number.

For complete information on the SCPI commands used to program the 34980A, and for example programs, refer to the Keysight 34980A Programmer's Reference which can be downloaded from www.keysight.com/find/34980A.

Opening and Closing Channels

Example: Closing and opening channels The first two commands close channel 3 for a module in slot 2, then channel 5 for that module. The last command opens both channel 3 and channel 5.

```
ROUTe:CLOSE (@2003)
ROUTe:CLOSE (@2005)
ROUTe:OPEN (@2003,2005)
```

Example: Querying channels for open or closed state The following command returns a 1 (true) or 0 (false) state of channel 016 for a module in slot 3.

```
ROUTe:CLOSE (@3016)
ROUTe:CLOSE? (@3016) !Returns a 1
ROUTe:OPEN? (@3016) !Returns a 0
```

Reading Jumper State and System Identity

Example: Querying the power-failure state of 5 A relays The following command returns the position of the power-fail jumper, either "MAIN" (all relays maintain their present state when power fails) or "OPEN" (all relays open when power fails) for a module in slot 4. If this command is sent to a module other than the 34937A or 34938A, "NONE" is returned (no error is generated). In particular, the position of the power-fail jumper on the 34939A module *cannot* be queried using this command.

SYSTem:MODUle:PFai1:JUMPer:AMP5? 4

Example: Querying the system for module identify (all modules) The following command returns the identify of the module installed in slot 7.

SYSTem:CTYPE? 7

Reading Cycle Count and Resetting Modules to Power-On State

Example: Reading the cycle count for a relay (all switch modules) The following command returns the relay cycle count on channel 7 and channel 16 for a module in slot 1.

DIAGnostic:RELAy:CYCLes? (@1007,1016)

Example: Clearing the cycle count for a relay (all switch modules) The following command resets the relay cycle count on channels 7 and 16 for a module in slot 1.

DIAGnostic:RELAy:CYCLes:CLEar (@1007,1016)

Example: Resetting Module(s) to power-on state (all modules) The following command resets a module in slot 4 to its power-on state.

SYSTem:CPON 4

34937A 32-Channel GP Switch Module

The 34937A general-purpose switch module provides independent control of:

- Twenty-eight Form C (SPDT) latching relays rated at 1 A
- Four Form A (SPST) latching relays rated at 5 A. You can set the power-failure state for these 5 A relays (see [“Hardware Power-Fail Jumper”](#) on page 17).

NOTE

A temperature sensor on these modules triggers system interrupts when high-carry current-induced heat on the modules reaches a threshold of 70 °C. See description of the “HOT” annunciator on [page 16](#).

34937A Simplified Schematic

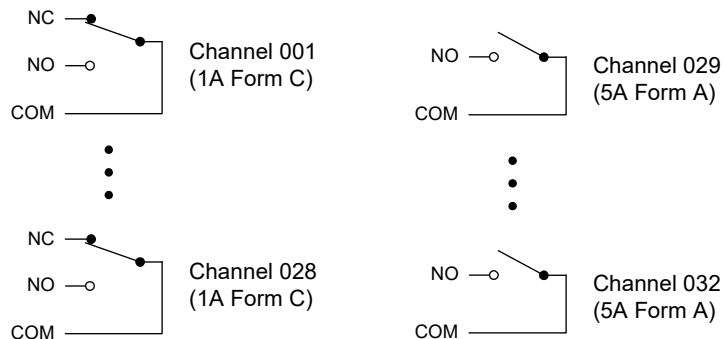

34937A D-Sub Connectors

Bank 1

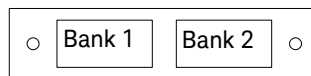

For orientation, the D-sub connector end of the module is facing you.

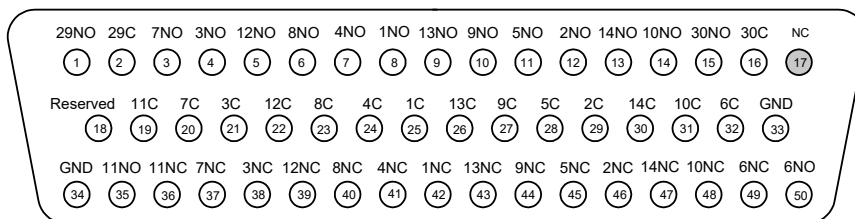

Channel	Pin	Channel	Pin	Channel	Pin	Channel	Pin	Channel	Pin	Channel	Pin
1 NC	42	4 NC	41	7 NC	37	10 NC	48	13 NC	43	30 NO	15
1 Common	25	4 Common	24	7 Common	20	10 Common	31	13 Common	26	30 Common	16
1 NO	8	4 NO	7	7 NO	3	10 NO	14	13 NO	9	Reserved	18
2 NC	46	5 NC	45	8 NC	40	11 NC	36	14 NC	47	GND	33
2 Common	29	5 Common	28	8 Common	23	11 Common	19	14 Common	30	GND	34
2 NO	12	5 NO	11	8 NO	6	11 NO	35	14 NO	13	No Connect	17
3 NC	38	6 NC	49	9 NC	44	12 NC	39	29 NO	1		
3 Common	21	6 Common	32	9 Common	27	12 Common	22	29 Common	2		
3 NO	4	6 NO	50	9 NO	10	12 NO	5				

Bank 2

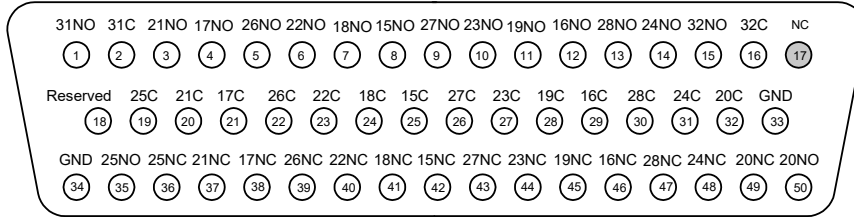

50-Pin D-Sub
Male Connector

Channel	Pin	Channel	Pin	Channel	Pin	Channel	Pin	Channel	Pin	Channel	Pin
15 NC	42	18 NC	41	21 NC	37	24 NC	48	27 NC	43	32 NO	15
15 Common	25	18 Common	24	21 Common	20	24 Common	31	27 Common	26	32 Common	16
15 NO	8	18 NO	7	21 NO	3	24 NO	14	27 NO	9	Reserved	18
16 NC	46	19 NC	45	22 NC	40	25 NC	36	28 NC	47	GND	33
16 Common	29	19 Common	28	22 Common	23	25 Common	19	28 Common	30	GND	34
16 NO	12	19 NO	11	22 NO	6	25 NO	35	28 NO	13	No Connect	17
17 NC	38	20 NC	49	23 NC	44	26 NC	39	31 NO	1		
17 Common	21	20 Common	32	23 Common	27	26 Common	22	31 Common	2		
17 NO	4	20 NO	50	23 NO	10	26 NO	5				

34937T Terminal Block

This terminal block with screw-type connections is labeled with the model number and the abbreviated module name. In addition, space is available on the label for you to write the slot number.

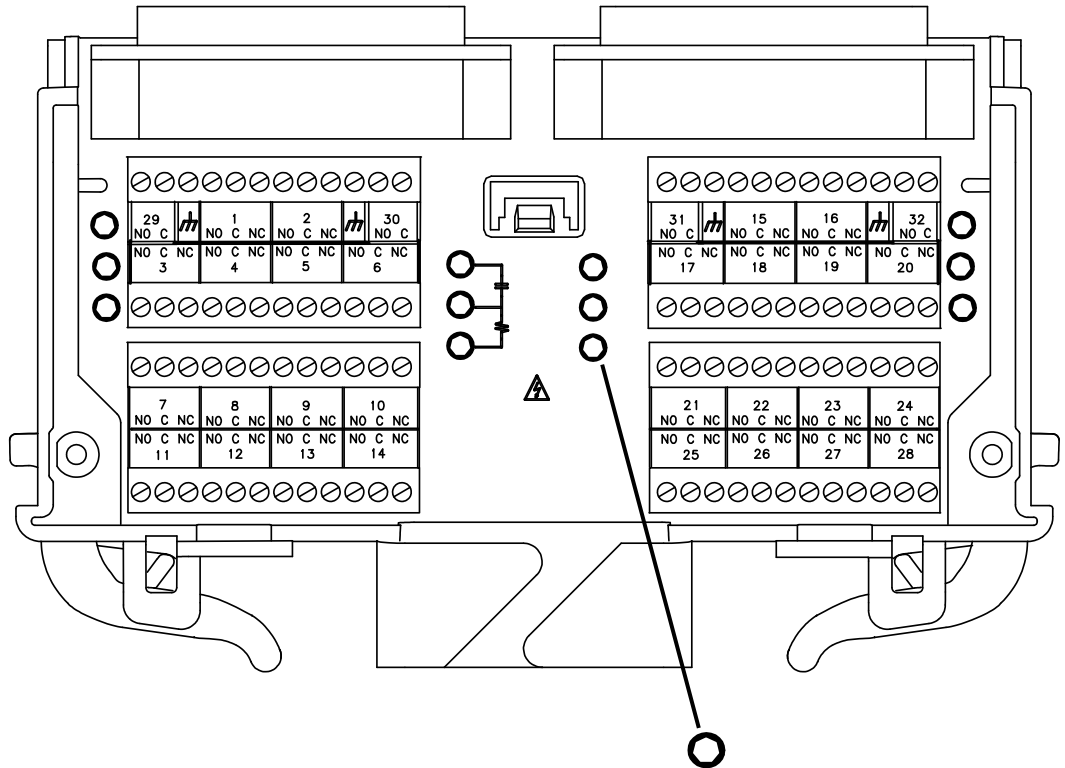

Pads for user-supplied snubber circuitry to alleviate reactive transients. The circuits may consist of resistors, capacitors, varistors, or other elements as needed to reduce the switching voltage and current transients inherent in reactive circuits. These pads are connected to Channels 29 - 32 for 2 Form A circuits.

WARNING

Terminal block wiring: Failure to follow the instructions below could result in equipment damage and may result in hazardous conditions such as fire or shock and could lead to personal injury or death.

Wiring of the terminal block must be performed by qualified persons. A MAXIMUM of 5 mm of conductor insulation is to be removed. All wire strands must be appropriately inserted in the connector housing. The screw connections must be sufficiently secured to prevent accidental loosening.

Never operate the instrument without the terminal block covers securely installed. Use caution to prevent operators from accessing any external circuits, test fixtures, cables or whenever hazardous voltages may be present.

WARNING**External Wiring for Hazardous Voltages:**

To ensure minimum safety insulation when wiring with hazardous voltages, ensure all wiring (both internal and external to the instruments):

- follow (USA) NFPA 79 Table 12.5.1 Conductor Ampacity and 12.5.5(a) Ambient Temperature Correction Factors (or equivalent National Code requirements) when selecting the AWG required.
 - are rated for at least 2 x the maximum applied voltage of the external source or any interconnecting system modules or external connections.
 - flame rated minimum:
 - Wires and cables with overall cross-sectional area of the conductors exceeding 0.5mm^2 meet test of IEC 60332-1-2 (IEC); or
 - Wires and cables with overall cross-sectional area of the conductors of 0.5mm^2 or less, the test of IEC 60332-2-2 (IEC); or
 - FT-1 of CSA C22.2 No. 0.3 (Canada); or
 - VW-1 of UL 1581 (US).
 - temperature rated for the application.
 - classified and suitable to be used external to the enclosure:
 - AWM Class II B or A/B – external/interconnecting wires (single- or multiple-conductor constructions with a jacket) and potentially subject to mechanical abuse (Canada)
 - AWM Style Use – external interconnection of electronic equipment or appliances (US)
-

WARNING

High Energy Sources: The instruments are designed to handle inputs up to their rated currents or their rated powers, whichever is less. Under certain fault conditions, high energy sources could provide substantially more current or power than the instrument can handle. It is important to provide external current limiting, such as fuses if the inputs are connected to high-energy sources. The overcurrent protection is to be rated for the maximum available short circuit current of the hazardous sources. Ensure that the current limiting devices / snubber circuits are appropriate for the signal being tested. Failure to do so may result in hazardous conditions such as fire or shock and could lead to personal injury or death.

34938A 20-Channel High-Current GP Switch Module

The 34938A high-current GP switch module provides twenty 5 A Form A (SPST) relays for general purpose switching needs. You can set the power-failure state for these 5 A relays (see “[Hardware Power-Fail Jumper](#)” on page 17).

NOTE

A temperature sensor on these modules triggers system interrupts when high-carry current-induced heat on the modules reaches a threshold of 70 °C. See description of the “HOT” annunciator on [page 16](#).

34938A Simplified Schematic

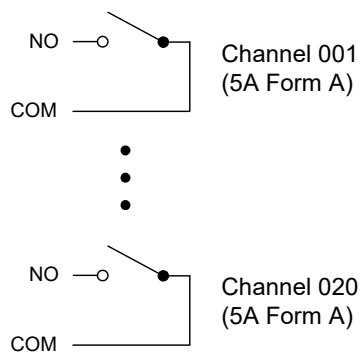

34938A D-Sub Connectors

Bank 1

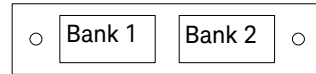

For orientation, the D-sub connector end of the module is

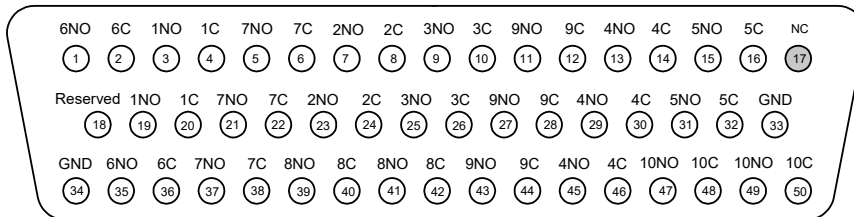

50-Pin D-Sub Male Connector

Channel	Pin	Channel	Pin	Channel	Pin	Channel	Pins	Channel	Pins
1NO	3	3NO	25	5NO	31	7NO	37	9NO	43
1Common	4	3Common	26	5Common	32	7Common	38	9Common	44
1NO	19	4NO	13	6NO	1	8NO	39	10NO	47
1Common	20	4Common	14	6Common	2	8Common	40	10Common	48
2NO	7	4NO	29	6NO	35	8NO	41	10NO	49
2Common	8	4Common	30	6Common	36	8Common	42	10Common	50
2NO	23	4NO	45	7NO	5	9NO	11	Reserved	18
2Common	24	4Common	46	7Common	6	9Common	12	GND	33
3NO	9	5NO	15	7NO	21	9NO	27	GND	34
3Common	10	5Common	16	7Common	22	9Common	28	No Connect	17

Bank 2

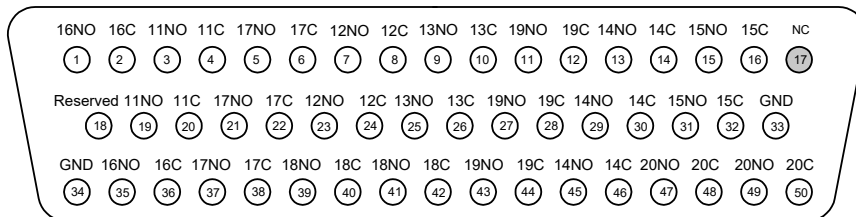

50-Pin D-Sub
Male Connector

Channel	Pin	Channel	Pin	Channel	Pin	Channel	Pins	Channel	Pins
11NO	3	13NO	25	15NO	31	17NO	37	19NO	43
11Common	4	13Common	26	15Common	32	17Common	38	19Common	44
11NO	19	14NO	13	16NO	1	18NO	39	20NO	47
11Common	20	14Common	14	16Common	2	18Common	40	20Common	48
12NO	7	14NO	29	16NO	35	18NO	41	20NO	49
12Common	8	14Common	30	16Common	36	18Common	42	20Common	50
12NO	23	14NO	45	17NO	5	19NO	11	Reserved	18
12Common	24	14Common	46	17Common	6	19Common	12	GND	33
13NO	9	15NO	15	17NO	21	19NO	27	GND	34
13Common	10	15Common	16	17Common	22	19Common	28	No Connect	17

34938T Terminal Block

This terminal block with screw-type connections is labeled with the model number and the abbreviated module name. In addition, space is available on the label for you to write the slot number.

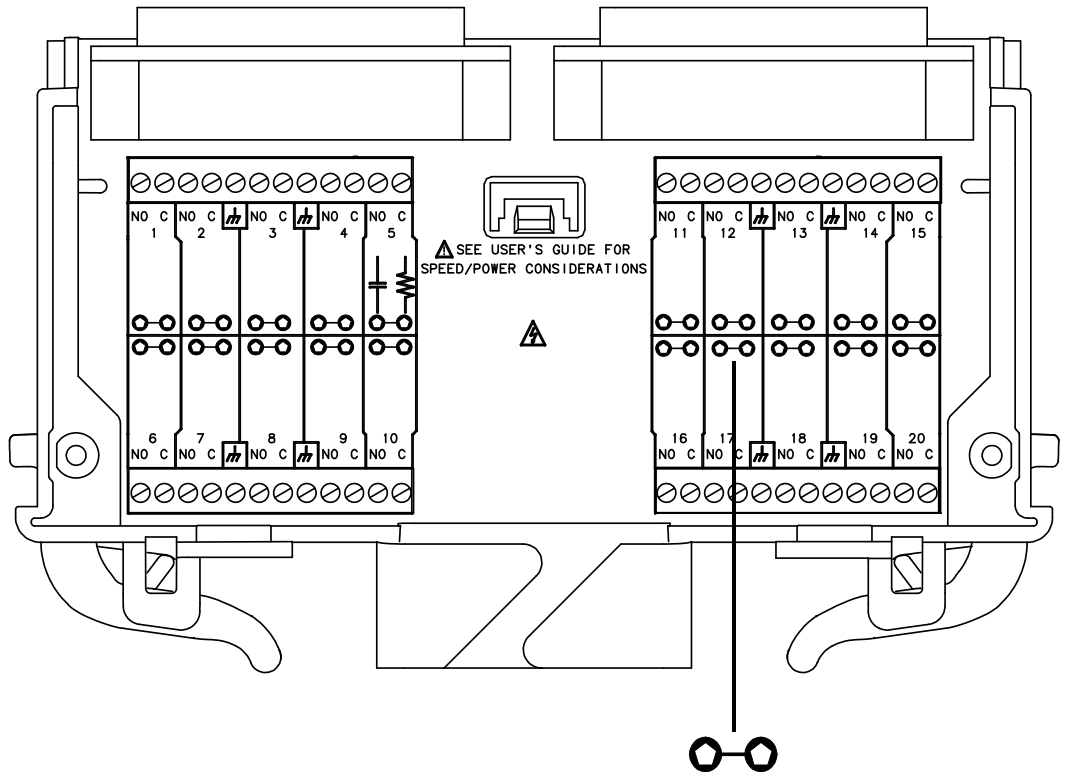

Pads for user-supplied snubber circuitry to alleviate reactive transients. The circuits may consist of resistors, capacitors, varistors, or other elements as needed to reduce the switching voltage and current transients inherent in reactive circuits.

WARNING

Terminal block wiring: Failure to follow the instructions below could result in equipment damage and may result in hazardous conditions such as fire or shock and could lead to personal injury or death.

Wiring of the terminal block must be performed by qualified persons. A MAXIMUM of 5 mm of conductor insulation is to be removed. All wire strands must be appropriately inserted in the connector housing. The screw connections must be sufficiently secured to prevent accidental loosening.

Never operate the instrument without the terminal block covers securely installed. Use caution to prevent operators from accessing any external circuits, test fixtures, cables or whenever hazardous voltages may be present.

WARNING**External Wiring for Hazardous Voltages:**

To ensure minimum safety insulation when wiring with hazardous voltages, ensure all wiring (both internal and external to the instruments):

- follow (USA) NFPA 79 Table 12.5.1 Conductor Ampacity and 12.5.5(a) Ambient Temperature Correction Factors (or equivalent National Code requirements) when selecting the AWG required.
 - are rated for at least 2 x the maximum applied voltage of the external source or any interconnecting system modules or external connections.
 - flame rated minimum:
 - Wires and cables with overall cross-sectional area of the conductors exceeding 0.5mm^2 meet test of IEC 60332-1-2 (IEC); or
 - Wires and cables with overall cross-sectional area of the conductors of 0.5mm^2 or less, the test of IEC 60332-2-2 (IEC); or
 - FT-1 of CSA C22.2 No. 0.3 (Canada); or
 - VW-1 of UL 1581 (US).
 - temperature rated for the application.
 - classified and suitable to be used external to the enclosure:
 - AWM Class II B or A/B – external/interconnecting wires (single- or multiple-conductor constructions with a jacket) and potentially subject to mechanical abuse (Canada)
 - AWM Style Use – external interconnection of electronic equipment or appliances (US)
-

WARNING

High Energy Sources: The instruments are designed to handle inputs up to their rated currents or their rated powers, whichever is less. Under certain fault conditions, high energy sources could provide substantially more current or power than the instrument can handle. It is important to provide external current limiting, such as fuses if the inputs are connected to high-energy sources. The overcurrent protection is to be rated for the maximum available short circuit current of the hazardous sources. Ensure that the current limiting devices / snubber circuits are appropriate for the signal being tested. Failure to do so may result in hazardous conditions such as fire or shock and could lead to personal injury or death.

34939A 64-Channel High-Density Form-A GP Switch Module

The 34939A high-density GP switch module provides sixty-four 1 A Form A (SPST) relays for general purpose switching needs. You can set the power-failure state for these relays (see [“Hardware Power-Fail Jumper”](#) on page 17).

NOTE

A temperature sensor on these modules triggers system interrupts when high-carry current-induced heat on the modules reaches a threshold of 70 °C. See description of the “HOT” annunciator on [page 16](#).

34939A Simplified Schematic

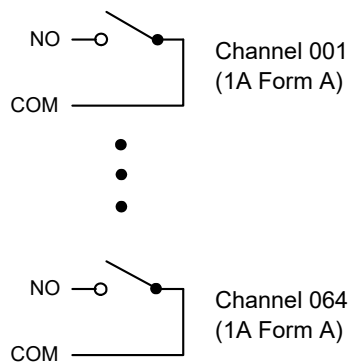

34939A D-Sub Connectors

Bank 1

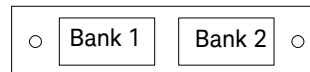

For orientation, the D-sub connector end of the module is facing you.

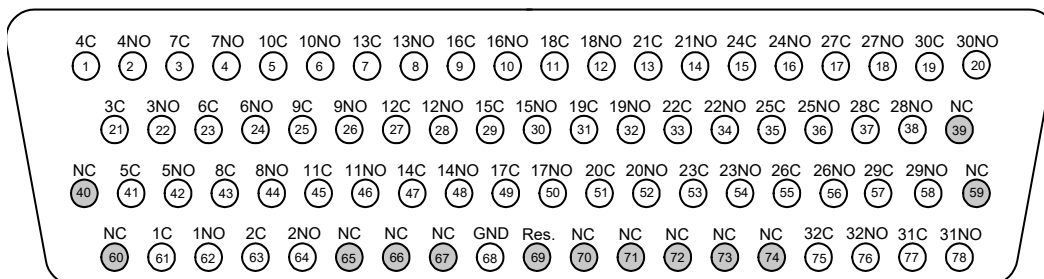

78-Pin D-Sub Male Connector

Channel	Pin	Channel	Pin	Channel	Pin	Channel	Pin	Channel	Pin	Channel	Pin
1 NO	62	8 NO	44	15 NO	30	22 NO	34	29 NO	58	No Connect	67
1 Common	61	8 Common	43	15 Common	29	22 Common	33	29 Common	57	No Connect	70
2 NO	64	9 NO	26	16 NO	10	23 NO	54	30 NO	20	No Connect	71
2 Common	63	9 Common	25	16 Common	9	23 Common	53	30 Common	19	No Connect	72
3 NO	22	10 NO	6	17 NO	50	24 NO	16	31 NO	78	No Connect	73
3 Common	21	10 Common	5	17 Common	49	24 Common	15	31 Common	77	No Connect	74
4 NO	2	11 NO	46	18 NO	12	25 NO	36	32 NO	76	Chassis GND	68
4 Common	1	11 Common	45	18 Common	11	25 Common	35	32 Common	75	Reserved	69
5 NO	42	12 NO	28	19 NO	32	26 NO	56	No Connect	39		
5 Common	41	12 Common	27	19 Common	31	26 Common	55	No Connect	40		
6 NO	24	13 NO	8	20 NO	52	27 NO	18	No Connect	59		
6 Common	23	13 Common	7	20 Common	51	27 Common	17	No Connect	60		
7 NO	4	14 NO	48	21 NO	14	28 NO	38	No Connect	65		
7 Common	3	14 Common	47	21 Common	13	28 Common	37	No Connect	66		

Bank 2

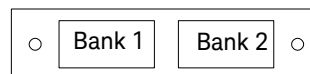

For orientation, the D-sub connector end of the module is facing you.

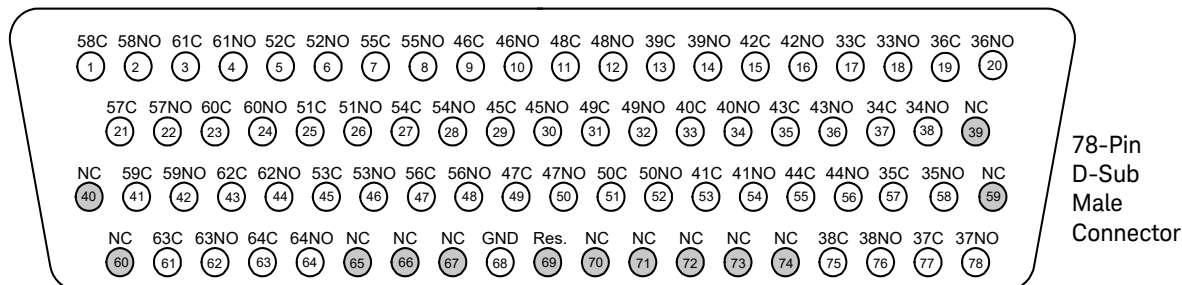

78-Pin
D-Sub
Male
Connector

Channel	Pin	Channel	Pin	Channel	Pin	Channel	Pin	Channel	Pin	Channel	Pin
33 NO	18	40 NO	34	47 NO	50	54 NO	28	61 NO	4	No Connect	67
33 Common	17	40 Common	33	47 Common	49	54 Common	27	61 Common	3	No Connect	70
34 NO	38	41 NO	54	48 NO	12	55 NO	8	62 NO	44	No Connect	71
34 Common	37	41 Common	53	48 Common	11	55 Common	7	62 Common	43	No Connect	72
35 NO	58	42 NO	16	49 NO	32	56 NO	48	63 NO	62	No Connect	73
35 Common	57	42 Common	15	49 Common	31	56 Common	47	63 Common	61	No Connect	74
36 NO	20	43 NO	36	50 NO	52	57 NO	22	64 NO	64	Chassis GND	68
36 Common	19	43 Common	35	50 Common	51	57 Common	21	64 Common	63	Reserved	69
37 NO	78	44 NO	56	51 NO	26	58 NO	2	No Connect	39		
37 Common	77	44 Common	55	51 Common	25	58 Common	1	No Connect	40		
38 NO	76	45 NO	30	52 NO	6	59 NO	42	No Connect	59		
38 Common	75	45 Common	29	52 Common	5	59 Common	41	No Connect	60		
39 NO	14	46 NO	10	53 NO	46	60 NO	24	No Connect	65		
39 Common	13	46 Common	9	53 Common	45	60 Common	23	No Connect	66		

34939T Terminal Block

This terminal block with screw-type connections is labeled with the model number and the abbreviated module name. In addition, space is available on the label for you to write the slot number.

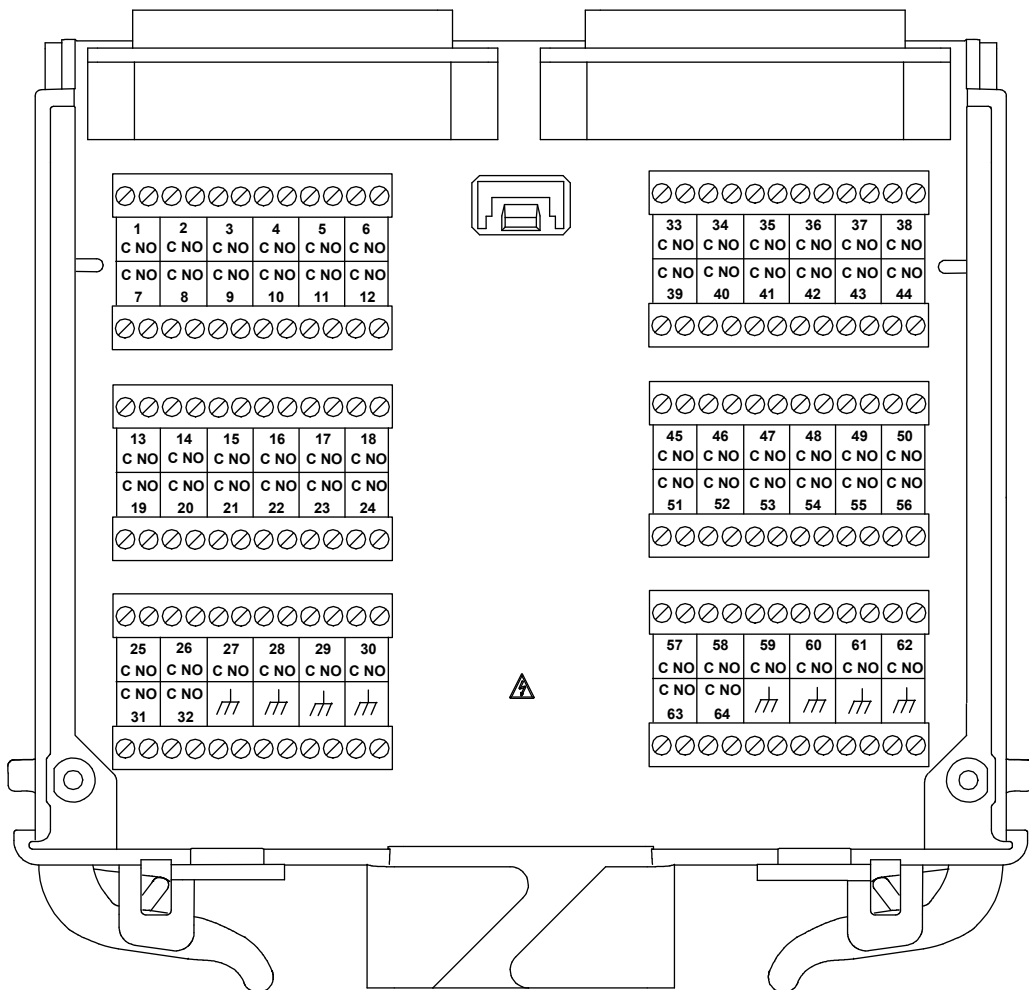

WARNING

Terminal block wiring: Failure to follow the instructions below could result in equipment damage and may result in hazardous conditions such as fire or shock and could lead to personal injury or death.

Wiring of the terminal block must be performed by qualified persons. A **MAXIMUM** of 5 mm of conductor insulation is to be removed. All wire strands must be appropriately inserted in the connector housing. The screw connections must be sufficiently secured to prevent accidental loosening.

Never operate the instrument without the terminal block covers securely installed. Use caution to prevent operators from accessing any external circuits, test fixtures, cables or whenever hazardous voltages may be present.

WARNING**External Wiring for Hazardous Voltages:**

To ensure minimum safety insulation when wiring with hazardous voltages, ensure all wiring (both internal and external to the instruments):

- follow (USA) NFPA 79 Table 12.5.1 Conductor Ampacity and 12.5.5(a) Ambient Temperature Correction Factors (or equivalent National Code requirements) when selecting the AWG required.
 - are rated for at least 2 x the maximum applied voltage of the external source or any interconnecting system modules or external connections.
 - flame rated minimum:
 - Wires and cables with overall cross-sectional area of the conductors exceeding 0.5mm^2 meet test of IEC 60332-1-2 (IEC); or
 - Wires and cables with overall cross-sectional area of the conductors of 0.5mm^2 or less, the test of IEC 60332-2-2 (IEC); or
 - FT-1 of CSA C22.2 No. 0.3 (Canada); or
 - VW-1 of UL 1581 (US).
 - temperature rated for the application.
 - classified and suitable to be used external to the enclosure:
 - AWM Class II B or A/B – external/interconnecting wires (single- or multiple-conductor constructions with a jacket) and potentially subject to mechanical abuse (Canada)
 - AWM Style Use – external interconnection of electronic equipment or appliances (US)
-

34980A Current Limiting Graphs

Modules	Pollution Degree 1	Pollution Degree 2	Transients
General Purpose Switch 34937A	28 channels Form C, 10 MHz	28 channels Form C, 10MHz	1000Vpk
Terminal Block 34937T	<ul style="list-style-type: none"> - $\pm 300\text{Vrms}$ or VDC ¹ - 1A (switch) / 2A (carry) - 60VA per channel ² - Volt-Hertz limit 10^8 - Initial closed channel resistance 125mΩ 4 channels Form A, 10 MHz - $\pm 250\text{Vrms}$ or 30VDC - 5A (switch) / 7A (carry) - 150VA per channel ² - Volt-Hertz limit 10^8 - Initial closed channel resistance 50mΩ - Differential Voltage FormC - FormA 300Vrms or VDC 	<ul style="list-style-type: none"> - $\pm 100\text{Vrms}$ or VDC ¹ - 1A (switch) / 2A (carry) - 60VA per channel ² - Volt-Hertz limit 10^8 - Initial closed channel resistance 125mΩ 4 channels Form A, 10 MHz - $\pm 100\text{Vrms}$ or 30VDC ¹ - 5A (switch) / 7A (carry) - 150VA per channel ² - Volt-Hertz limit 10^8 - Initial closed channel resistance 50mΩ - Differential Voltage FormC - Form A 100Vrms or VDC 	

The overcurrent protection devices will be rated, or the snubber circuits will limit the current, according to:

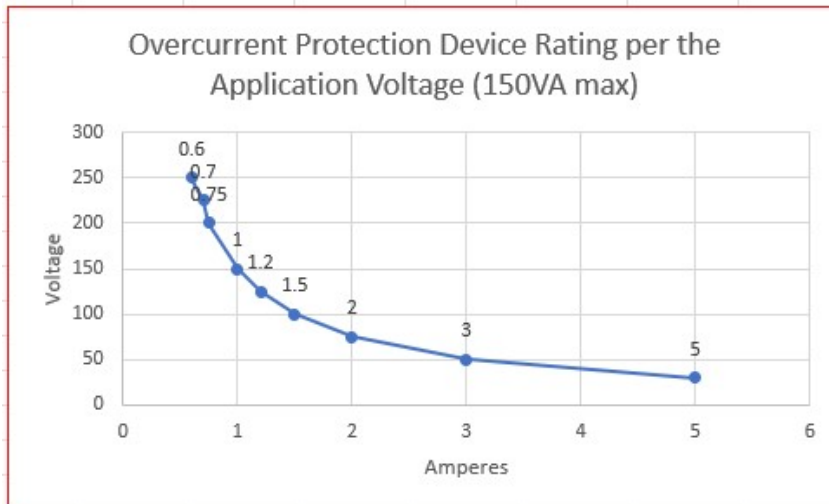
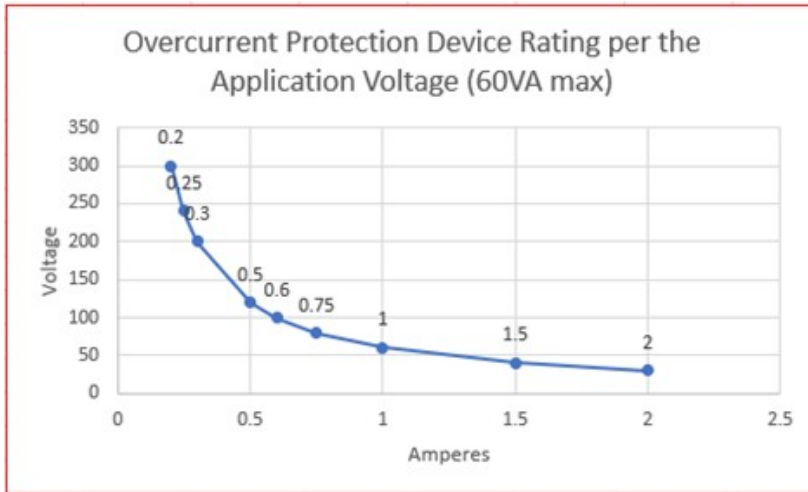

1. DC or AC RMS voltage, channel-to-channel or channel-to-earth.
2. Limited to 6 W of channel resistance power loss per module.

Modules	Pollution Degree 1	Pollution Degree 2	Transients
General Purpose Switch 34938A	20 channels, Form A, 1MHz ±250 Vrms or 30VDC ¹	20 channels, Form A, 1MHz ±100Vrms or 30VDC ¹	1000Vpk
Terminal Block 34938T	5A (switch) / 7A (carry) 150VA per channel	5A (switch) / 7A (carry) 150VA per channel	

The overcurrent protection devices will be rated, or the snubber circuits will limit the current, according to:

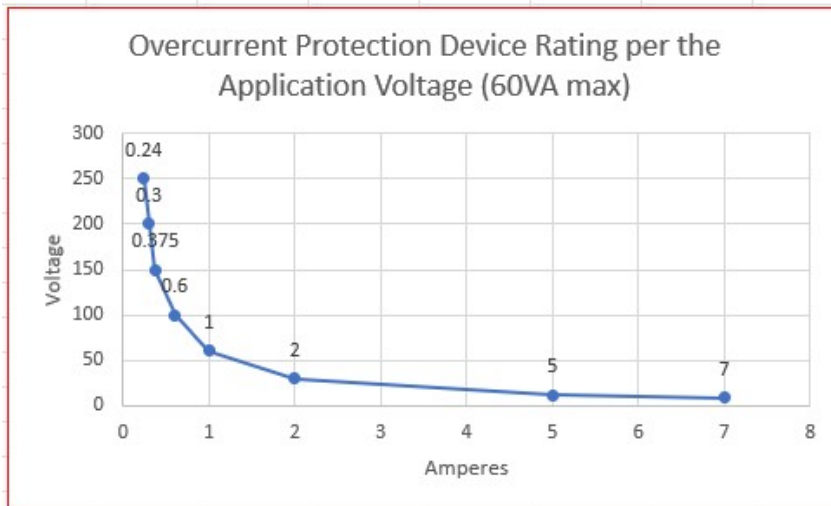

1. DC or AC RMS voltage, channel-to-channel or channel-to-earth.

Modules	Pollution Degree 1	Pollution Degree 2	Transients
General Purpose Switch 34939A	64 channels, Form A, 10MHz ±100Vpeak	64 channels, Form A, 10MHz ±100Vpeak	1000Vpk
Terminal Block 34939T	1A (switch) / 2A (carry) 60VA ¹ per channel Volt-Hertz 10 ⁸ Initial closed channel resistance: <125mΩ	1A (switch) / 2A (carry) 60VA ¹ per channel Volt-Hertz 10 ⁸ Initial closed channel resistance: <125mΩ	

The overcurrent protection devices will be rated, or the snubber circuits will limit the current, according to:

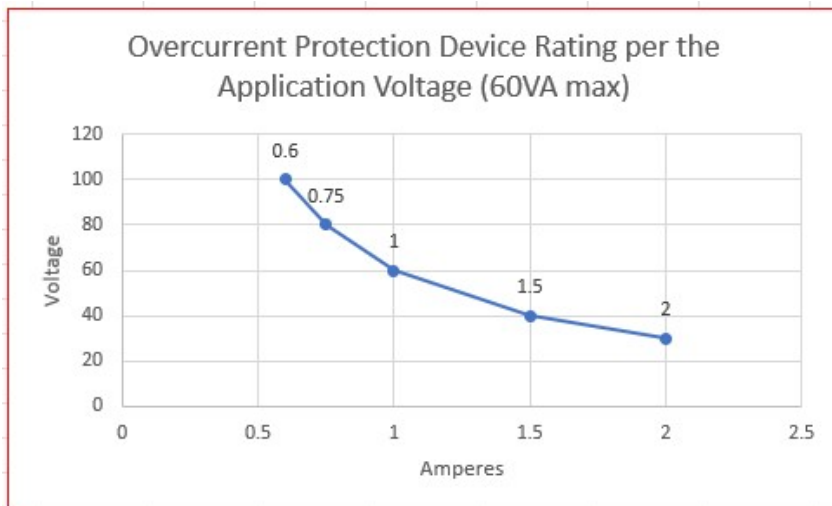

1. Limited to 6 W of channel resistance power loss per module.

THIS PAGE HAS BEEN INTENTIONALLY LEFT BLANK.

Index

Numerics

34929A

pinouts, 37

34937A

connector pinouts, 23

description, 15, 22

simplified schematic, 22

terminal block, 25

wiring log, 25

34938A

connector pinouts, 30

description, 15, 29

simplified schematic, 29

snubber circuitry, 25, 32

terminal block, 32

wiring log, 32

34939A

connector pinouts, 37

description, 15, 36

simplified schematic, 36

terminal block, 39

wiring log, 39

34937A, 23

34938A, 30

34939A, 37

power-fail jumper, 17

programming examples, 20

S

safety notices, 4

T

temperature sensor, 16

C

connector pinouts

34937A, 23

34938A, 30

34939A, 37

D

D-sub pinouts

34937A, 23

34938A, 30

34939A, 37

J

jumper, 17

P

pinouts

THIS PAGE HAS BEEN INTENTIONALLY LEFT BLANK.



This information is subject to change without notice. Always refer to the Keysight website for the latest revision.

© Keysight Technologies 2016-2022
Edition 4, Aug 2022

Printed in Malaysia



34980-90037

www.keysight.com