Keysight N2893A 100 MHz Current Probe

Notices

© Keysight Technologies, Inc. 2013 - 2014, 2016, 2017, 2018, 2020, 2023

No part of this manual may be reproduced in any form or by any means (including electronic storage and retrieval or translation into a foreign language) without prior agreement and written consent from Keysight Technologies, Inc. as governed by United States and international copyright laws.

Manual Part Number

N2893-97004

Edition

March 2023

Published by:
Keysight Technologies, Inc.
1400 Fountaingrove Parkway
Santa Rosa, CA, 95403

Warranty

The material contained in this document is provided “as is,” and is subject to being changed, without notice, in future editions. Further, to the maximum extent permitted by applicable law, Keysight disclaims all warranties, either express or implied, with regard to this manual and any information contained herein, including but not limited to the implied warranties of merchantability and fitness for a particular purpose. Keysight shall not be liable for errors or for incidental or consequential damages in connection with the furnishing, use, or performance of this document or of any information contained herein. Should Keysight and the user have a separate written agreement with warranty terms covering the material in this document that conflict with these terms, the warranty terms in the separate agreement shall control.

Technology Licenses

The hardware and/or software described in this document are furnished under a license and may be used or copied only in accordance with the terms of such license.

U.S. Government Rights

The Software is “commercial computer software,” as defined by Federal Acquisition Regulation (“FAR”) 2.101. Pursuant to FAR 12.212 and 27.405-3 and Department of Defense FAR Supplement (“DFARS”) 227.7202, the U.S. government acquires commercial computer software under the same terms by which the software is customarily provided to the public. Accordingly, Keysight provides the Software to U.S. government customers under its standard commercial license, which is embodied in its End User License Agreement (EULA), a copy of which can be found at <http://www.keysight.com/find/sweula>. The license set forth in the EULA represents the exclusive authority by which the U.S. government may use, modify, distribute, or disclose the Software. The EULA and the license set forth therein, does not require or permit, among other things, that Keysight: (1) Furnish technical information related to commercial computer software or commercial computer software documentation that is not customarily provided to the public; or (2) Relinquish to, or otherwise provide, the government rights in excess of these rights customarily provided to the public to use, modify, reproduce, release, perform, display, or disclose commercial computer software or commercial computer software documentation. No additional government requirements beyond those set forth in the EULA shall apply, except to the extent that those terms, rights, or licenses are explicitly required from all providers of commercial computer software pursuant to the FAR and the DFARS and are set forth specifically in writing elsewhere in the EULA. Keysight shall be under no obligation to update, revise or otherwise modify the Software. With respect to any technical data

as defined by FAR 2.101, pursuant to FAR 12.211 and 27.404.2 and DFARS 227.7102, the U.S. government acquires no greater than Limited Rights as defined in FAR 27.401 or DFAR 227.7103-5 (c), as applicable in any technical data.

Safety Notices

CAUTION

A **CAUTION** notice denotes a hazard. It calls attention to an operating procedure, practice, or the like that, if not correctly performed or adhered to, could result in damage to the product or loss of important data. Do not proceed beyond a **CAUTION** notice until the indicated conditions are fully understood and met.

WARNING

A **WARNING** notice denotes a hazard. It calls attention to an operating procedure, practice, or the like that, if not correctly performed or adhered to, could result in personal injury or death. Do not proceed beyond a **WARNING** notice until the indicated conditions are fully understood and met.

DANGER

A **DANGER** notice that incorrect operation presents extreme danger of accident resulting in death or serious injury to the user.

Contents

Introduction	/ 5
Features	/ 5
Scope Compatibility	/ 5
Inspecting the Probe	/ 6
Cleaning the Probe	/ 6
Safety Information	/ 7
N2893A Components	/ 9
Using the Probe	/ 11
Making Measurements	/ 11
Obtaining the Best Measurement Accuracy	/ 12
Demagnetization and Zero Offset	/ 14
Protecting the Probe Against Damage Resulting from Excessive Input	/ 15
Built-in Safety Function	/ 15
Performance Verification for N2893A	/ 17
Procedure	/ 17
Characteristics and Specifications	/ 21
Plots	/ 25
Product Markings and Labels	/ 27
Service Strategy	/ 28
To return the Probe to Keysight Technologies for Service	/ 28
Index	

Contents

Keysight N2893A 100 MHz Current Probe User Guide

Introduction

The N2893A is a wide-band, DC to 100 MHz, active current probe. The probe features low noise and low circuit insertion loss. The probe has the following operating regions that provide a wide, flat frequency response.

- In the DC to low frequency AC region, the probe operation is based on the negative feedback system that includes the thin film Hall element as a detector.
- In the high frequency region, the probe operates as a current transformer.

The N2893A is ideal for acquiring high transient time signals such as those found in motor controllers, in switching power supplies, and in current amplifiers driving inductive loads.

The probe connects to the InfiniiVision and Infiniium oscilloscopes with 1 M Ω AutoProbe interface. The oscilloscope's AutoProbe interface provides the probe power, probe offset, and auto configuration of probe type and attenuation setting thereby making the current measurements as simple as those made with active voltage probes.

To use this probe effectively and to ensure a long operational life, read this user's guide carefully and retain it for future reference.

Features

- Highly accurate current detection
- Split-core construction allows an easy circuit connection
- Wide bandwidth - DC to 100 MHz
- Connects directly to InfiniiVision and Infiniium oscilloscopes with 1 M Ω AutoProbe interface
- Auto degauss and offset elimination
- Auto activation of the built-in safety feature if the input current exceeds the rated continuous maximum to prevent damage resulting from overloading.

Scope Compatibility

- MXR-Series Oscilloscopes
- EXR-Series Oscilloscopes
- 3000 X-Series oscilloscopes
- 5000, 6000 (except 100 MHz models), and 7000 Series oscilloscopes with software version 6.10 or higher

- 9000A Series with software version 3.0 or higher
- 90000 X-Series with the N5449A adapter

Inspecting the Probe

- Inspect the shipping container for damage.
- Keep the damaged shipping container or cushioning material until the contents of the shipment have been checked for completeness and the probe has been checked mechanically and electrically.
- Check the accessories. If the contents are incomplete or damaged, notify your Keysight Technologies Sales Office.
- Inspect the probe. If there is mechanical damage or defect, or if the probe does not operate properly or pass calibration tests, notify your Keysight Technologies Sales Office.
- If the shipping container is damaged, or the cushioning materials show signs of stress, notify the carrier as well as your Keysight Technologies Sales Office. Keep the shipping materials for the carrier's inspection. The Keysight Technologies office will arrange for repair or replacement at Keysight Technologies' option without waiting for claim settlement.

Cleaning the Probe

If the probe requires cleaning, disconnect it from the oscilloscope and gently clean the external surface of the probe with a soft cloth dampened with a mild soap and water solution.

WARNING

Do not try to clean the unit using cleaners containing organic solvents such as benzene, alcohol, acetone, ether, ketones, thinners, or gasoline. These may cause discoloration or damage.

Make sure the probe is completely dry before reconnecting it to the oscilloscope.

Cleaning the Sensor Head

The presence of foreign substances such as dust on the mating surfaces of the probe's sensor head can cause acoustic resonance and degraded measurements. Therefore, keep these mating surfaces clean by gently wiping with a soft cloth.

Safety Information

This manual provides information and warnings essential for operating this equipment in a safe manner and for maintaining it in safe operating condition. Before using this equipment, be sure to carefully read the following safety notes.

WARNING

This equipment is designed according to IEC 61010-1 and IEC 61010-2-032 Safety Standards, and has been tested for safety prior to shipment. Incorrect measurement procedures could result in injury or death, as well as damage to the equipment. Please read this manual carefully and be sure that you understand its contents before using the equipment. The manufacturer disclaims all responsibility for any accident or injury except that resulting due to defect in its product.

WARNING

If the equipment is used in a manner not specified by the manufacturer, the protection provided by the equipment may be impaired.

WARNING

Do not install substitute parts or perform any unauthorized modification to the instrument. Only Keysight service centers should perform repair/maintenance on the equipment.

DANGER

Never use this sensor on uninsulated conductors. The core and shield case are not insulated. Before clamping the insulated conductor being measured, make sure that the insulation on the conductor is undamaged. Any damage to the insulation can cause an electric shock.

WARNING

Do not subject the unit to vibrations or shocks during transport or handling. Be especially careful to avoid dropping the unit.

WARNING

Do not store the unit where it will be exposed to direct sunlight, high temperature, high humidity, or condensation. If exposed to such conditions, the unit may be damaged, the insulation may deteriorate, and the unit may no longer satisfy its specifications.

WARNING

This unit is not constructed to be dustproof, so do not use it in a very dusty environment.

WARNING

The sensor head is a precision assembly including a molded component, a ferrite core, and a Hall effect element. It may be damaged if subjected to sudden changes in ambient temperature, or mechanical strain or shock, and therefore great care should be exercised in handling it.

WARNING

To avoid scratching the surfaces of the Hall effect elements, keep the core section of the sensor closed, except when clamping it around the insulated conductor to be measured.

WARNING

Before turning on the instrument, you must connect the protective earth terminal of the instrument to the protective conductor of the (mains) power cord. The mains plug shall only be inserted in a socket outlet provided with a protective earth contact. You must not negate the protective action by using an extension cord (power cable) without a protective conductor (grounding).

N2893A Components

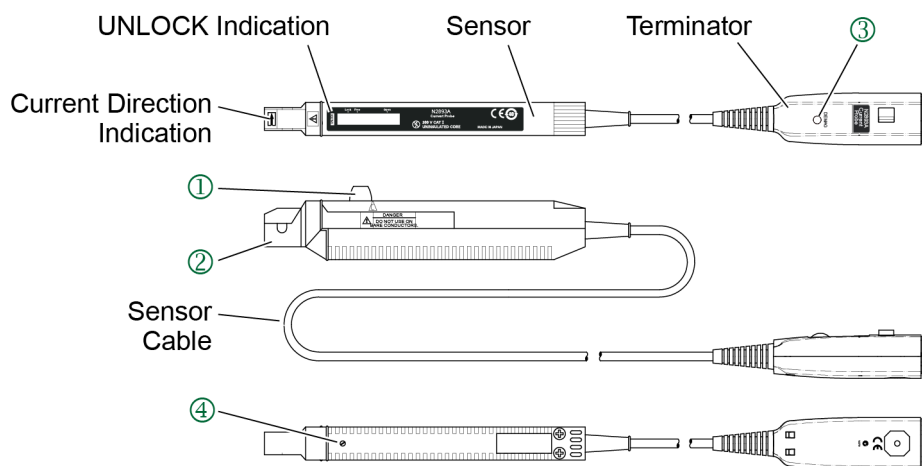

Figure 1 Probe components

① Opening Lever

Operating lever for opening the sensor head. Always use this lever to open the sensor head.

② Sensor Head

This clamps the conductor being measured, and carries out the actual current measurement. It is a precision assembly including a molded component, a ferrite core, and a Hall effect element. It may be damaged if subjected to sudden changes in ambient temperature, or mechanical strain or shock. Care should be exercised when handling the sensor head.

③ Demagnetizing Switch (DEMAG)

This demagnetizes the core if it has been magnetized by switching the power on and off, or by an excessive input. Always carry out demagnetizing before measurement. The probe should be connected to the oscilloscope for the demagnetizing process. This process takes about one second. During demagnetizing, a demagnetizing waveform is output. Refer to ["Demagnetization and Zero Offset"](#) on page 14

④ Coarse Adjustment Trimmer

This adjustment should only be carried out if the probe offset is outside the range of the zero adjustment dial.

WARNING

The raised ridge between the jaws and opening lever of the probe is purely decorative and not intended as a Protective Barrier.

This is a Type D probe and should be used with insulated conductors only.

NOTE

The output of this unit is terminated internally. The high-impedance such as $1\text{ M}\Omega$ input impedance will be automatically selected on the Infiniium oscilloscope, as the probe is plugged into the AutoProbe interface. With an input impedance of 50Ω , accurate measurement is not possible.

NOTE

The probe output sensitivity 0.1 V/A will be automatically selected, as the probe is plugged into the AutoProbe interface. With a different output sensitivity, accurate measurements are not possible.

Using the Probe

WARNING

Ensure all safety warnings and precautions are followed. Before using the probe, study the warning and precautions in **“Safety Information”** on page 7.

Also, take precautions mentioned in **“Protecting the Probe Against Damage Resulting from Excessive Input”** on page 15.

NOTE

This probe is NOT compatible with 50 Ω only Infiniium oscilloscopes (for example, the 90000A series oscilloscopes). Use the N5449A high impedance probe adapter for use with Infiniium 90000X Series oscilloscope. The input coupling is automatically selected to DC, as the terminator is plugged into the AutoProbe interface.

Making Measurements

- 1 Power on the oscilloscope.
- 2 Connect the probe to one of the scope's channels.

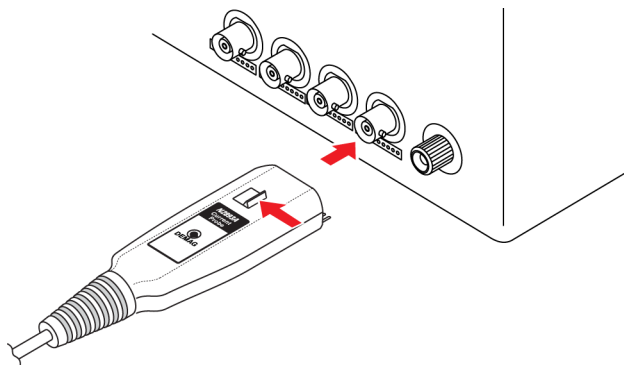

Figure 2 Connecting the Probe to the Oscilloscope

NOTE

When the probe is connected to a scope channel, the AutoProbe interface recognizes the probe as an N2893A and automatically configures several settings on the channel to which the probe is connected.

NOTE

Immediately after powering on, this unit may be subject to an appreciable offset drift due to the effect of self-heating. To counteract this, allow the unit to warm up for about 30 minutes before carrying out measurements.

- 3 Perform the steps described in "Demagnetization and Zero Offset" on page 14.
- 4 With the probe's sensor head around the insulated conductor to be measured, slide the Opening Lever of the probe into the **Locked** position as shown in Figure 3. While doing so, ensure that the **UNLOCK** indication disappears which indicates that the sensor head is properly closed. If the sensor head is not properly closed, accurate measurements will not be possible.

CAUTION

Always use the opening lever when opening the probe's sensor head. If an upper core is forced to open when the sensor head is locked, the open-close mechanism can be damaged.

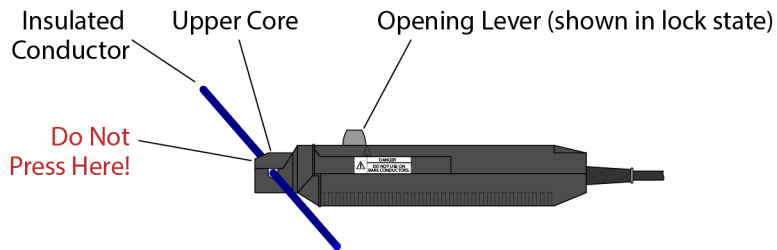

Figure 3 Use the Opening Lever

NOTE

Under certain circumstances, oscillation may occur if the probe is connected to the AutoProbe interface while the oscilloscope is on. This does not indicate a malfunction. Oscillation can be stopped and operation can be restored to normal by opening and closing the sensor head.

Obtaining the Best Measurement Accuracy

To obtain the best measurement accuracy, ensure that:

- The current direction indicator on the sensor aligns with actual current direction in the insulated conductor.
- The sensor opening lever is in the Locked position and the sensor head is properly closed.

- The conductor under test is positioned in such a way that it is in the center of the clamp aperture.

NOTE

Accurate measurement may be impossible in locations subject to strong external magnetic fields, such as transformers and high-current conductors, or in locations subject to strong external electric fields, such as radio transmission equipment.

At high frequencies, common mode noise may affect measurements taken on the high voltage side of circuits. If this occurs, reduce the frequency range of the measuring instrument or clamp onto the low-voltage side of the circuit as shown in Figure 4, as appropriate.

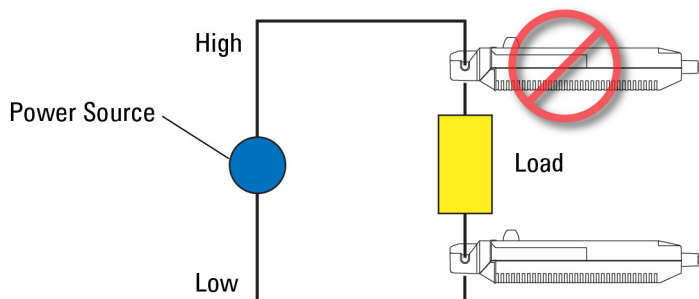

Figure 4 Clamp Onto the Low-Voltage Side of Circuit

NOTE

When performing continuous measurements, it is necessary to be aware that the zero offset voltage will drift if the ambient temperature changes.

NOTE

At some frequencies, some sound may be produced by resonance. This has no effect on measurements.

Demagnetization and Zero Offset

NOTE

Allow both the oscilloscope and probe to warm up for at least 30 minutes before making these adjustments.

- 1 Set the channel offset to 0V for the oscilloscope channel to which the probe is connected.
- 2 Ensure that the probe sensor is NOT clamped around any conductors.
- 3 Slide the probe's Opening Lever into the **Locked** position as shown in [Figure 5](#).

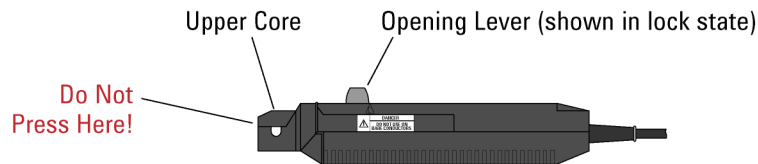

Figure 5 Use the Opening Lever

- 4 Press the probe's **DEMAG** button shown in [Figure 1](#) on page 9. A demagnetization waveform will be displayed for a short time on the channel to which the probe is connected. Wait until this waveform is no longer displayed.
- 5 On Infiniium oscilloscopes:
 - a Click **Setup > Probe Calibration**.
 - b Click the **AutoZero** button to automatically start the demagnetization followed by the zero offset routine.
 - c Follow the on-screen instructions.
- 6 On InfiniiVision oscilloscopes:
 - a Press the scope's channel button (1, 2, 3, or 4) for the channel you are using.
 - b Click the **Probe** softkey (under the display) and then press the key to automatically start the demagnetization and zero offset process.
 - c Follow the on-screen instructions.

Protecting the Probe Against Damage Resulting from Excessive Input

WARNING

The steps and guidelines provided in this topic must be followed to ensure that your probe is protected against any damage caused due to the input current that exceeds the maximum continuous input range for the probe.

The maximum continuous input range is based on heat that is internally generated during measurement. This range varies according to the frequency of the current being measured. See [Figure 11](#) on page 25 to know about the maximum continuous input range for the N2893A probe. It is recommended not to exceed this range.

Built-in Safety Function

WARNING

In the following situations, the generated heat activates a built-in safety function in the probe that blocks normal output to prevent probe damage resulting from heating.

- If the input current exceeds the maximum continuous input range.
 - Continuous input for an extended period of time (even if the input current does not exceed the rated continuous maximum).
 - At high ambient temperatures, the built-in safety function may activate even at current input levels below the rated continuous maximum.
-

In such situations, when the built-in safety function is activated:

- 1 Remove the input immediately (unclamp the sensor from the conductor being measured or reduce the input current to zero).
- 2 Wait until the sensor on the probe had the sufficient time to cool before resuming operation.

WARNING

If there is continuous input of current exceeding the rated maximum or repeated activation of the built-in safety function, it may result in damage to the unit.

WARNING

Do NOT measure current such that the total probe current consumption exceeds the allowable AutoProbe interface current consumption. The excess current consumption causes a temporary shutdown of the oscilloscope's power supply for safety. Quit the measurement and cycle the power of the oscilloscope, if the shutdown occurs. The typical probe current consumption from the AutoProbe interface is shown in **Figure 6**.

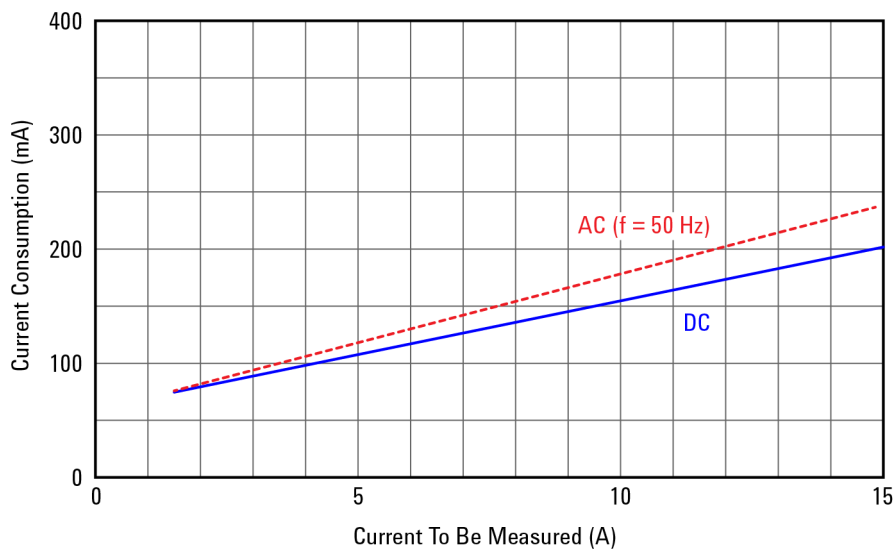

Figure 6 Typical Probe Consumption

Performance Verification for N2893A

Use the following procedure to test the warranted Accuracy specifications for the N2893A probe (as listed on [page 21](#)). The recommended test interval to warrant performance of this probe is once a year. However, you can also test the probe's performance as and when required using the recommended test equipment and by following the procedure documented in this chapter.

Table 1 Required Test Equipment

Description	Minimum Requirements	Recommended Test Equipment
Oscilloscope	Bandwidth ≥ 250 MHz Amplitude accuracy: $\leq 0.4\%$	Infiniium or InfiniiVision with 1 M Ω input
Two Digital Multimeters	-	Keysight U1251B Handheld Digital Multimeter or equivalent DVM/DMM
AC Current Generator	AC 10 A _{rms} , 50 or 60 Hz, sine wave Amplitude accuracy: $\leq 0.3\%$	Keysight AC6800 or Wavetek 9100
Probe Adapter	-	Keysight N1022B Probe Adapter
Power Supply	-	Keysight 1143A Probe Offset Control and Power Module
Test Cables (with banana jacks)	-	-
BNC Cable	-	-
BNC (F) to Banana Adapter	-	-
NMD 3.5mm (M) to 3.5mm (F) adapter	-	-
3.5mm (M) to BNC (F) adapter	-	-

Procedure

- 1 To provide power to the probe, connect the power cord of the N1022B probe adapter to the Power connector on the front panel of the 1143A power module. Then connect the N2893A probe's output to the N1022B probe adapter's input.

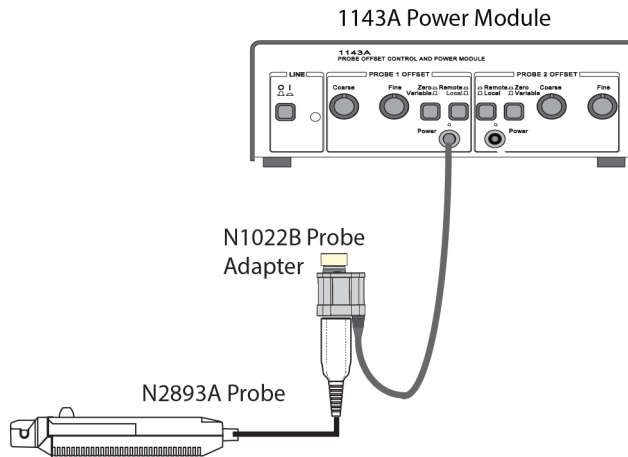

Figure 7 Providing power to the N2893A probe

- 2 Turn on the equipment.
- 3 Wait for 20 minutes to allow the probe to warm up.
- 4 Connect the test setup as shown in [Figure 8](#) on page 19 as per the following substeps.
 - a Clamp the N2893A probe around the test cable <1> and lock the sensor head of the probe.
 - b Press the **DEMAG** button on the probe.
 - c Set the digital multimeter (DMM <1>) to A_{rms} mode.
 - d Connect the test cable <1> to the positive terminal of the AC current generator's OUTPUT terminal block and to the current input of the DMM <1>.
 - e Connect the test cable <2> to the negative terminal of the AC current generator's OUTPUT terminal block and to negative input of the DMM <1>.
 - f Using the DMM <1>, set the output current of AC current generator to $6A_{rms}$.

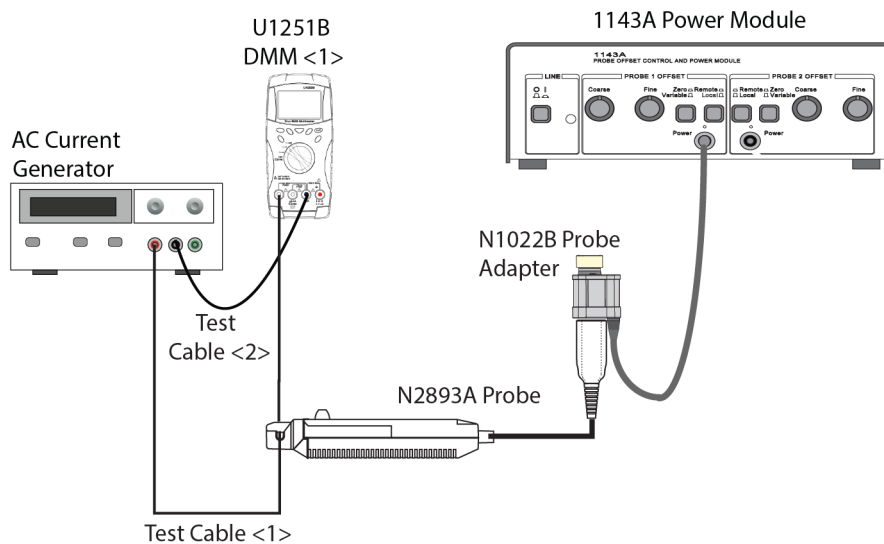

Figure 8 Setting up AC Current Generator

- 5 Set the DMM <2> to V_{rms} mode.
- 6 As displayed in [Figure 9](#) on page 20, connect a BNC cable to the:
 - a N1022B adapter's output using the NMD 3.5mm (M) to 3.5mm (F) adapter and 3.5mm (M) to BNC (F) adapter.
 - b DMM <2> using a BNC (F)-to-banana adapter.

This completes the test setup.

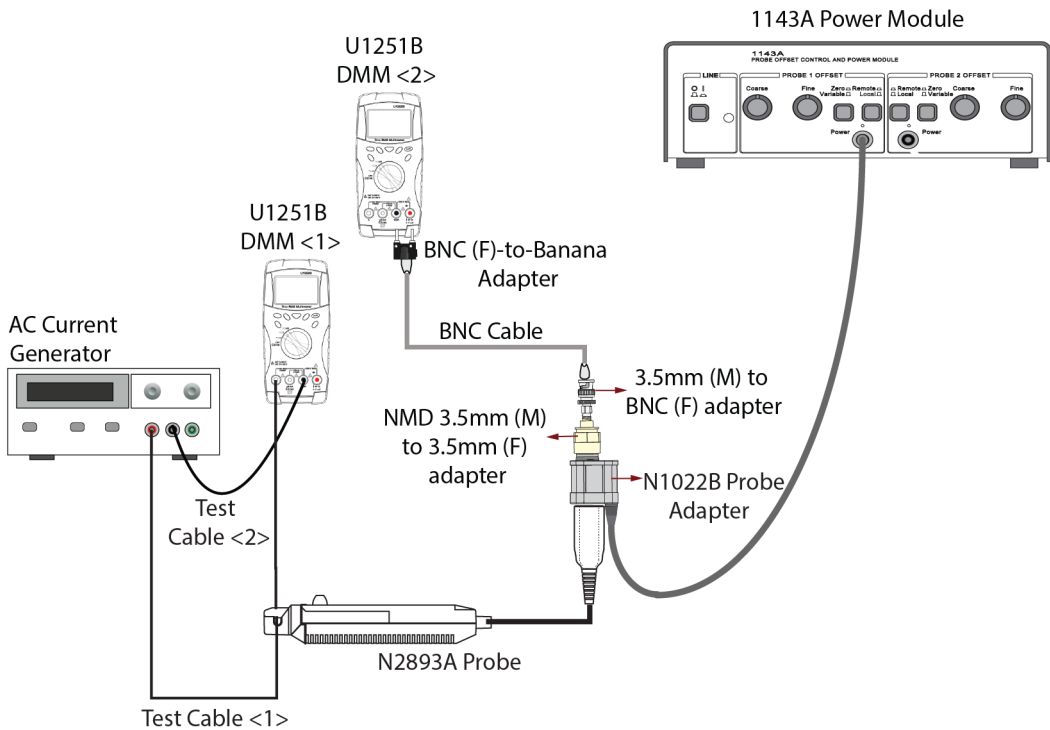

Figure 9 Complete Test Setup

- 7 Measure the current and record V_{rms} output of the probe as displayed on the DMM <2>.
- 8 Calculate gain as follows:

$$\text{Gain} = V_{rms} / A_{rms}$$

Gain should be between 0.99 and 1.01 (+/-1% gain accuracy).

- 9 Remove the test cable and AC current generator from the N2893A probe.

Characteristics and Specifications

Table 2 Measurement Characteristics

Item	Characteristic ^a
Probe Bandwidth	DC to 100 MHz (-3 dB)
Accuracy (Probe Only) ^b	±1% of reading ±1mV (DC or 45 Hz to 66 Hz)
Risetime ^c	≤ 3.5 ns
Maximum Continuous Current	15A peak, 15 A _{DC} , 10 A _{rms}
	30A peak, 30 A _{DC} , 24 A _{rms} (when one probe is used with InfiniiVision 3000XT, 5000/6000/7000 scope)
	DC: 30A _{DC} , Continuous AC: 30A _{rms} , 42A _{peak} (when used with MXR/EXR oscilloscope main channels (channel 1 to 4))
	DC: 15A _{DC} , Continuous AC: 10A _{rms} , 15A _{peak} (when used with MXR/EXR oscilloscope secondary channels (channel 5 to 8))
Maximum Non-continuous Peak Current (for Pulse Widths ≤ 10μs)	50A 30A peak, 32A peak (when one probe is used with InfiniiVision 3000XT, 5000/6000/7000 scope)
	AC: 50 A _{pk} (when used with MXR/EXR oscilloscope main channels (channel 1 to 4))
	AC: 30 A _{pk} (when used with MXR/EXR oscilloscope secondary channels (channel 5 to 8))
Probe Sensitivity	0.1V/A
Noise	≤ 2.5 mA _{rms} (with 20 MHz Bandwidth limiting)
Insertion Impedance	See Figure 12 on page 26.
Temperature Coefficient	≤ ±2% (0°C to 40°C)
Maximum Circuit Voltage	Refer to safety considerations and product compliances Not rated for CAT II, III, IV

^a Requires 1MΩ termination. Valid for 23°C ±3°C (73°F ±5°F), at least 30 minutes after power on.

N2893A Probe

- b This is a specification and is guaranteed at $23^{\circ}\text{C} \pm 3^{\circ}\text{C}$ ($73^{\circ}\text{F} \pm 5^{\circ}\text{F}$).
- c Rise time is calculated as: $\text{Tr} = 0.35/\text{Bandwidth}$.

Table 3 Power Supply Characteristics

Item	Characteristics
DC supply Voltage Requirements	$\pm 12\text{Vdc} \pm 1\text{V}$
Probe Power Consumption	Increases with measured current. 3 VA when measuring 15A

Table 4 Mechanical Characteristics

Item	Characteristics
Maximum Cable Diameter	5 mm (0.2 inch)
Sensor Cable Length	1.5 m (59 inches)
Dimensions (Sensor)	175 mm x 18 mm x 40 mm 6.89 in. x 0.71 in. x 1.6 in.
Dimensions (Terminator)	28 mm x 81 mm x 24 mm 1.1 in. x 3.2 in. x 0.94 in
Weight	210 g (7.4 oz.)
Accessories Supplied	Storage case, calibration certificate

Table 5 Environmental Characteristics

Item	Characteristics
Use	Indoor
Operating Temperature Range	0°C to 40°C (32°F to 104°F)
Storage Temperature Range	-10°C to 50°C (14°F to 122°F)
Maximum Relative Humidity (Operating or Storage)	80% (no condensation)
Maximum Altitude	2000m

Plots

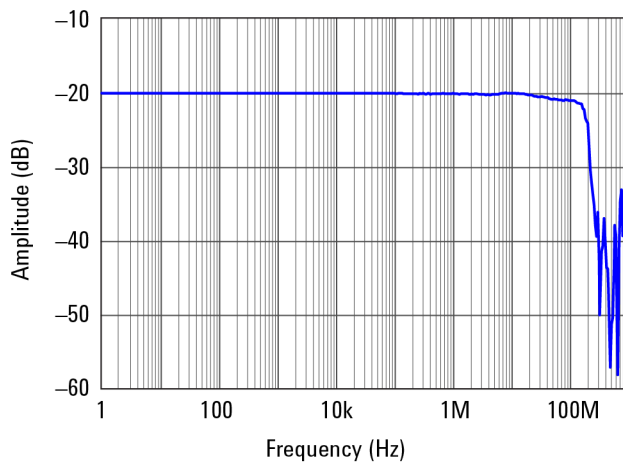

Figure 10 Frequency Response of N2893A

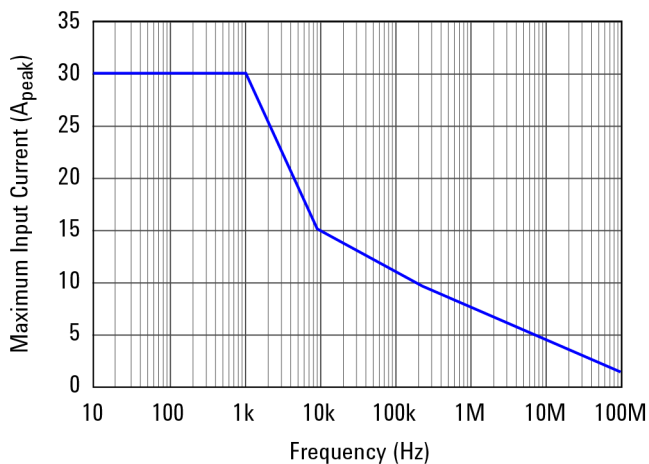

Figure 11 Continuous Maximum Input Rating of N2893A

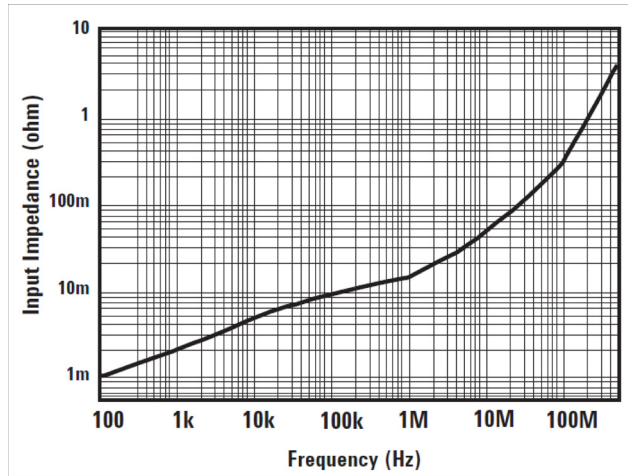

Figure 12 Insert Impedance of N2893A

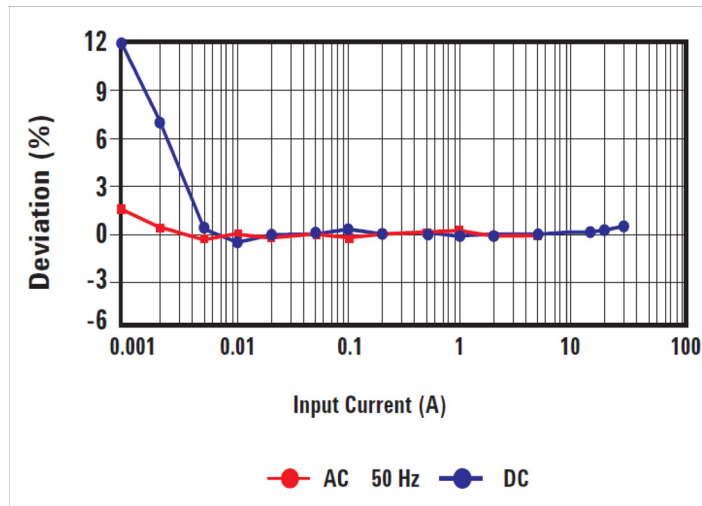









Figure 13 Amplitude Accuracy Characteristic of N2893A

Product Markings and Labels

Table 6 Instrument Markings

Marking	Description
 300 V CAT I UNINSULATED CORE	Indicates the maximum circuit voltage and product compliance. (Not rated for CAT II, III, IV) This product cannot be used with an uninsulated conductor.
	Indicates that only insulated conductors suited to the voltage of the circuit under test can be measured. DO NOT use with an uninsulated conductor.
	This symbol indicates the Environmental Protection Use Period (EPUP) for the product's toxic substances for the China RoHS requirements.
	The CE mark is a registered trademark of the European Community. ISM GRP 1-A denotes the instrument is an Industrial Scientific and Medical Group 1 Class A product. ICES/NMB-001 indicates product compliance with the Canadian Interference-Causing Equipment Standard.
	CAUTION. Risk of Danger. Refer to this manual for more information.
	Indicates DC (Direct Current) or AC (Alternating Current).
	Indicates a risk of Electric Shock. Refer to the manual for more information.
	Earth terminal symbol: Used to indicate a circuit common connected to grounded chassis.

Service Strategy

For calibration testing, return the N2893A probe to a Keysight Service Center. If the probe is under warranty, normal warranty services apply. If the probe is not under warranty, repair costs will be applied.

To return the Probe to Keysight Technologies for Service

Call (800) 829-4444 for further details and the location of your nearest Keysight Technologies Service Office or go to www.keysight.com/find/assist for contact information.

- 1 Write the following information on a tag and attach it to the probe.
 - Name and address of the owner
 - Probe model number
 - Description of service required or failure indications
- 2 Retain all accessories.
- 3 Return the probe in its case or pack the probe in foam or other shock-absorbing material and place it in a strong shipping container. You can use the original shipping materials or order materials from an Keysight Technologies Sales Office. If neither are available, place 3 to 4 inches of shock-absorbing material around the instrument and place it in a box that does not allow movement during shipping.
- 4 Seal the shipping container securely.
- 5 Mark the shipping container as FRAGILE. In all correspondence, refer to the instrument by model number and full serial number.

Index

A

AC accuracy, 17
accuracy, 21
AutoProbe, 11

C

cable diameter, 23
calibration, 17
characteristics and specifications, 21
China RoHS requirements, 27
coarse adjustment trimmer, 10
current direction indicator, 12

D

DC supply voltage requirements, 23
DEMAG, 9, 14
demagnetizing switch, 9
dimensions (sensor), 23
dimensions (terminator), 23

H

high frequencies, 13
high transient time signals, 5

I

IEC 61010-1 and IEC 61010-2-032
Safety Standards, 7
impedance, insertion, 21
insertion impedance, 21
inspection, 6
instrument markings, 27
ISM1-A, 27

L

labels, 27

M

maximum altitude, 24
maximum cable diameter, 23

maximum circuit voltage, 21
maximum current, 21
maximum peak current, 21
maximum relative humidity, 24
measurement procedure, 11

N

noise, 21

O

opening lever, 9
opening sensor head, 12
operating temperature range, 24

P

probe bandwidth, 21
probe parts identification, 9
probe power consumption, 23
probe sensitivity, 21

R

risetime, 21

S

safety warnings, 7
sensitivity, 21
sensor cable length, 23
sensor head, 9
service, 28
storage temperature range, 24

T

temperature coefficient, 21
temperature range, 24

U

use, 24
using, 12

W

weight, 23

